

Partial FCC Test Report

Report No.: RF150722C27-1

FCC ID: GKR-TP00078A

Test Model: TP00078A

Received Date: Jul. 22, 2015

Test Date: Jul. 29, 2015 ~ Aug. 18, 2015

Issued Date: Aug. 26, 2015

Applicant: Compal Electronics Inc

Address: No.581, Ruiguang Rd., Neihu District, Taipei City, Taiwan 11492, R.O.C.

Issued By: Bureau Veritas Consumer Products Services (H.K.) Ltd., Taoyuan Branch

Lab Address: No. 47-2, 14th Ling, Chia Pau Vil., Lin Kou Dist., New Taipei City, Taiwan (R.O.C)

Test Location (1): No. 19, Hwa Ya 2nd Rd, Wen Hwa Tsuen, Kwei Shan Hsiang, Taoyuan Hsien 333, Taiwan, R.O.C.

Test Location (2): No.215, Sec. 3, Beixin Rd., Xindian Dist., New Taipei City 231, Taiwan, R.O.C



This report is for your exclusive use. Any copying or replication of this report to or for any other person or entity, or use of our name or trademark, is permitted only with our prior written permission. This report sets forth our findings solely with respect to the test samples identified herein. The results set forth in this report are not indicative or representative of the quality or characteristics of the lot from which a test sample was taken or any similar or identical product unless specifically and expressly noted. Our report includes all of the tests requested by you and the results thereof based upon the information that you provided to us. You have 60 days from date of issuance of this report to notify us of any material error or omission caused by our negligence, provided, however, that such notice shall be in writing and shall specifically address the issue you wish to raise. A failure to raise such issue within the prescribed time shall constitute your unqualified acceptance of the completeness of this report, the tests conducted and the correctness of the report contents. Unless specific mention, the uncertainty of measurement has been explicitly taken into account to declare the compliance or non-compliance to the specification. The report must not be used by the client to claim product certification, approval, or endorsement by TAF or any government agencies.

Table of Contents

Release Control Record	3
1 Certificate of Conformity	4
2 Summary of Test Results	5
2.1 Measurement Uncertainty	5
2.2 Modification Record	5
3 General Information	6
3.1 General Description of EUT	6
3.2 Description of Test Modes.....	8
3.2.1 Test Mode Applicability and Tested Channel Detail	10
3.3 Description of Support Units	12
3.3.1 Configuration of System under Test	12
3.4 General Description of Applied Standards.....	12
4 Test Types and Results	13
4.1 Radiated Emission and Bandedge Measurement	13
4.1.1 Limits of Radiated Emission and Bandedge Measurement	13
4.1.2 Limits of Unwanted Emission Out of The Restricted Bands.....	13
4.1.3 Test Instruments	14
4.1.4 Test Procedures.....	15
4.1.5 Deviation from Test Standard	15
4.1.6 Test Set Up	16
4.1.7 EUT Operating Conditions.....	16
4.1.8 Test Results	17
4.2 Conducted Emission Measurement.....	97
4.2.1 Limits of Conducted Emission Measurement	97
4.2.2 Test Instruments	97
4.2.3 Test Procedures.....	98
4.2.4 Deviation from Test Standard	98
4.2.5 Test Setup.....	98
4.2.6 EUT Operating Conditions.....	98
4.2.7 Test Results	99
5 Pictures of Test Arrangements	103
Appendix – Information on the Testing Laboratories	104



A D T

Release Control Record

Issue No.	Description	Date Issued
RF150722C27-1	Original Release	Aug. 26, 2015



1 Certificate of Conformity

Product: Tablet Computer
Brand: Lenovo
Test Model: TP00078A
Sample Status: Production Unit
Applicant: Compal Electronics Inc
Test Date: Jul. 29, 2015 ~ Aug. 18, 2015
Standards: 47 CFR FCC Part 15, Subpart E (Section 15.407)
ANSI C63.10:2013

The above equipment has been tested by **Bureau Veritas Consumer Products Services (H.K.) Ltd., Taoyuan Branch**, and found compliance with the requirement of the above standards. The test record, data evaluation & Equipment Under Test (EUT) configurations represented herein are true and accurate accounts of the measurements of the sample's EMC characteristics under the conditions specified in this report.

Prepared by : Rona Chen , **Date:** Aug. 26, 2015
Rona Chen / Specialist

Approved by : Kay Wu , **Date:** Aug. 26, 2015
Kay Wu / Supervisor

2 Summary of Test Results

47 CFR FCC Part 15, Subpart E (SECTION 15.407)			
FCC Clause	Test Item	Result	Remarks
15.407(b)(6)	AC Power Conducted Emissions	PASS	Meet the requirement of limit. Minimum passing margin is -16.35dB at 0.19301MHz.
15.407(b)(1/2/3/4/6)	Radiated Emissions & Band Edge Measurement	PASS	Meet the requirement of limit. Minimum passing margin is -0.74dB at 5350MHz.
15.407(a)(1/2/3)	Max Average Transmit Power	N/A	Refer to Note
15.407(a)(1/2/3)	Peak Power Spectral Density	N/A	Refer to Note
15.407(e)	6dB bandwidth	N/A	Refer to Note
15.407(g)	Frequency Stability	N/A	Refer to Note
15.203	Antenna Requirement	PASS	No antenna connector is used.

Note: Only test item of AC power Conducted Emission and Radiated Emissions were performed for this report. Other testing data please refer to SPORTON International Inc. report no.: FR473142AB for module (Brand: Broadcom, Model: BCM94356Z, FCC ID: QDS-BRCM1085)

2.1 Measurement Uncertainty

Where relevant, the following measurement uncertainty levels have been estimated for tests performed on the EUT as specified in CISPR 16-4-2:

Measurement	Frequency	Expanded Uncertainty (k=2) (±)
Conducted Emissions at mains ports	150kHz ~ 30MHz	2.44 dB
Radiated Emissions up to 1 GHz	30MHz ~ 200MHz	2.0153 dB
	200MHz ~ 1000MHz	2.0224 dB
Radiated Emissions above 1 GHz	1GHz ~ 18GHz	1.0121 dB
	18GHz ~ 40GHz	1.1508 dB

2.2 Modification Record

There were no modifications required for compliance.

3 General Information

3.1 General Description of EUT

Product	Tablet Computer
Brand	Lenovo
Test Model	TP00078A
Status of EUT	Production Unit
Power Supply Rating	20Vdc (Adapter) 15.2Vdc (Li-ion battery)
Modulation Type	256QAM, 64QAM, 16QAM, QPSK, BPSK
Modulation Technology	OFDM
Transfer Rate	802.11a: 54.0/ 48.0/ 36.0/ 24.0/ 18.0/ 12.0/ 9.0/ 6.0Mbps 802.11n: up to MCS7 802.11ac: up to V9
Operating Frequency	5180 ~ 5240MHz, 5260 ~ 5320MHz, 5500 ~ 5700MHz, 5745 ~ 5825MHz
Number of Channel	5180 ~ 5240MHz: 4 for 802.11a, 802.11n (20MHz) 2 for 802.11n (40MHz) 1 for 802.11ac (80MHz) 5260 ~ 5320MHz: 4 for 802.11a, 802.11n (20MHz) 2 for 802.11n (40MHz) 1 for 802.11ac (80MHz) 5500 ~ 5700MHz: 8 for 802.11a, 802.11n (20MHz) 3 for 802.11n (40MHz) 1 for 802.11ac (80MHz) 5745 ~ 5825MHz: 5 for 802.11a, 802.11n (20MHz) 2 for 802.11n (40MHz) 1 for 802.11ac (80MHz)
Antenna Type	Refer to Note as below
Antenna Connector	N/A
Accessory Device	Refer to Note as below
Data Cable Supplied	Refer to Note as below

Note:

- The EUT incorporates a MIMO function. Physically, the EUT provides two completed transmitters and two receivers.

Modulation Mode	Tx Function
802.11b	1TX
802.11g	1TX
802.11a	1TX
802.11n (20MHz)	2TX
802.11n (40MHz)	2TX
802.11ac (80MHz)	2TX

* The modulation and bandwidth are similar for 802.11n mode for 20MHz / 40MHz, therefore investigated worst case to representative mode in test report. (Final test mode refer section 3.2.1)

2. This EUT contains two samples listed as below.

Sample	Difference
EUT 1	Tablet computer with Antenna (Ethertronics Inc.)
EUT 2	Tablet computer with Antenna (HIGH-TEK)

3. The antenna information is listed as below.

Antenna Type	Brand Name	Parts Number	Antenna Gain	
			2.4GHz	5GHz
PIFA	Ethertronics Inc.	WLAN Main Antenna: 5002022 WLAN Aux. Antenna: 5002030	Main: 0.85 Aux.: -0.71	Main: 0.46 Aux.: 0.36
	HIGH-TEK	WLAN Main Antenna: DC33001RQ00 WLAN Aux. Antenna: DC33001RQ10	Main: -0.17 Aux.: -0.30	Main: 1.84 Aux.: 1.56

4. The EUT contains following accessory devices.

Product	Brand	Model	Description
Adapter 1	lenovo	ADLX45NCC2A	I/P: 100-240Vac, 50~60Hz, 1.3A O/P: 20Vdc, 2.25A
Adapter 2	lenovo	ADLX45NDC2A	I/P: 100-240Vac, 50~60Hz, 1.3A O/P: 20Vdc, 2.25A
Battery	lenovo	SB10F46465	15.2Vdc, 2.895Ah
WLAN Module	Broadcom	BCM94356Z	--

5. The above EUT information is declared by manufacturer and for more detailed features description, please refer to the manufacturer's specifications or user's manual.

3.2 Description of Test Modes

FOR 5180 ~ 5240MHz

4 channels are provided for 802.11a, 802.11n (20MHz):

Channel	Frequency	Channel	Frequency
36	5180 MHz	44	5220 MHz
40	5200 MHz	48	5240 MHz

2 channels are provided for 802.11n (40MHz):

Channel	Frequency	Channel	Frequency
38	5190 MHz	46	5230 MHz

1 channel is provided for 802.11ac (80MHz):

Channel	Frequency
42	5210MHz

FOR 5260 ~ 5320MHz

4 channels are provided for 802.11a, 802.11n (20MHz):

Channel	Frequency	Channel	Frequency
52	5260 MHz	60	5300 MHz
56	5280 MHz	64	5320 MHz

2 channels are provided for 802.11n (40MHz):

Channel	Frequency	Channel	Frequency
54	5270 MHz	62	5310 MHz

1 channel is provided for 802.11ac (80MHz):

Channel	Frequency
58	5290MHz

FOR 5500 ~ 5700MHz

11 channels are provided for 802.11a, 802.11n (20MHz):

Channel	Frequency	Channel	Frequency
100	5500 MHz	124	5620 MHz
104	5520 MHz	128	5640 MHz
108	5540 MHz	132	5660 MHz
112	5560 MHz	136	5680 MHz
116	5580 MHz	140	5700 MHz
120	5600 MHz		

5 channels are provided for 802.11n (40MHz):

Channel	Frequency	Channel	Frequency
102	5510 MHz	126	5630 MHz
110	5550 MHz	134	5670 MHz
118	5590 MHz		

2 channels are provided for 802.11ac (80MHz):

Channel	Frequency	Channel	Frequency
106	5530MHz	122	5610 MHz

FOR 5745 ~ 5825MHz:

5 channels are provided for 802.11a, 802.11n (20MHz):

Channel	Frequency	Channel	Frequency
149	5745MHz	161	5805MHz
153	5765MHz	165	5825MHz
157	5785MHz		

2 channels are provided for 802.11n (40MHz):

Channel	Frequency	Channel	Frequency
151	5755MHz	159	5795MHz

1 channel is provided for 802.11ac (80MHz):

Channel	Frequency
155	5775MHz

3.2.1 Test Mode Applicability and Tested Channel Detail

EUT Configure Mode	Applicable To			Description
	RE≥1G	RE<1G	PLC	
A	√	√	√	EUT 1 (Ant. Ethertronic)
B	√	√	√	EUT 2 (Ant. HIGH-TEK)

Where **RE≥1G**: Radiated Emission above 1GHz **RE<1G**: Radiated Emission below 1GHz
PLC: Power Line Conducted Emission

Radiated Emission Test (Above 1GHz):

- Pre-Scan has been conducted to determine the worst-case mode from all possible combinations between available modulations, data rates and antenna ports (if EUT with antenna diversity architecture).
- Following channel(s) was (were) selected for the final test as listed below.

EUT Configure Mode	Mode	Frequency Band (MHz)	Available Channel	Tested Channel	Modulation Technology	Modulation Type	Data Rate (Mbps)
B	802.11a	5180-5240	36 to 48	36, 40, 48	OFDM	BPSK	6.0
	802.11n (20MHz)		36 to 48	36, 40, 48	OFDM	BPSK	MCS0
	802.11n (40MHz)		38 to 46	38, 46	OFDM	BPSK	MCS0
	802.11ac (80MHz)		42	42	OFDM	BPSK	V0
	802.11a	5260-5320	52 to 64	52, 60, 64	OFDM	BPSK	6.0
	802.11n (20MHz)		52 to 64	52, 60, 64	OFDM	BPSK	MCS0
	802.11n (40MHz)		54 to 62	54, 62	OFDM	BPSK	MCS0
	802.11ac (80MHz)		58	58	OFDM	BPSK	V0
	802.11a	5500-5700	100 to 140	100, 116, 140	OFDM	BPSK	6.0
	802.11n (20MHz)		100 to 140	100, 116, 140	OFDM	BPSK	MCS0
	802.11n (40MHz)		102 to 134	102, 110, 134	OFDM	BPSK	MCS0
	802.11ac (80MHz)		106	106	OFDM	BPSK	V0
	802.11a	5745-5825	149 to 165	149, 157, 165	OFDM	BPSK	6.0
	802.11n (20MHz)		149 to 165	149, 157, 165	OFDM	BPSK	MCS0
	802.11n (40MHz)		151 to 159	151, 159	OFDM	BPSK	MCS0
	802.11ac (80MHz)		155	155	OFDM	BPSK	V0
A	802.11a	5180-5240	36 to 48	36	OFDM	BPSK	6.0
	802.11ac (80MHz)		42	42	OFDM	BPSK	V0
	802.11a	5260-5320	52 to 64	64	OFDM	BPSK	6.0
	802.11n (20MHz)		52 to 64	64	OFDM	BPSK	MCS0
	802.11a	5500-5700	100 to 140	140	OFDM	BPSK	6.0
	802.11n (20MHz)		100 to 140	140	OFDM	BPSK	MCS0
	802.11n (20MHz)	5745-5825	149 to 165	165	OFDM	BPSK	MCS0
	802.11ac (80MHz)		155	155	OFDM	BPSK	V0

Radiated Emission Test (Below 1GHz):

- Pre-Scan has been conducted to determine the worst-case mode from all possible combinations between available modulations, data rates and antenna ports (if EUT with antenna diversity architecture).
- Following channel(s) was (were) selected for the final test as listed below.

EUT Configure Mode	Mode	Frequency Band (MHz)	Available Channel	Tested Channel	Modulation Technology	Modulation Type	Data Rate (Mbps)
A, B	802.11a	5180-5240	36 to 48	36	OFDM	BPSK	6.0
	802.11a	5260-5320	52 to 64	64	OFDM	BPSK	6.0
	802.11a	5500-5700	100 to 140	140	OFDM	BPSK	6.0
	802.11n (20MHz)	5745-5825	149 to 165	165	OFDM	BPSK	MCS0

Power Line Conducted Emission Test:

- Pre-Scan has been conducted to determine the worst-case mode from all possible combinations between available modulations, data rates and antenna ports (if EUT with antenna diversity architecture).
- Following channel(s) was (were) selected for the final test as listed below.

EUT Configure Mode	Mode	Frequency Band (MHz)	Available Channel	Tested Channel	Modulation Technology	Modulation Type	Data Rate (Mbps)
A	802.11a	5180-5240	36 to 48	36	OFDM	BPSK	6.0
B	802.11n (20MHz)	5745-5825	149 to 165	165	OFDM	BPSK	MCS0

Test Condition:

Applicable To	Environmental Conditions	Input Power	Tested by
RE≥1G	25deg. C, 65%RH	120Vac, 60Hz	Karl Lee
RE<1G	25deg. C, 65%RH	120Vac, 60Hz	Karl Lee
PLC	25deg. C, 68%RH	120Vac, 60Hz	Toby Tian

3.3 Description of Support Units

3.3.1 Configuration of System under Test

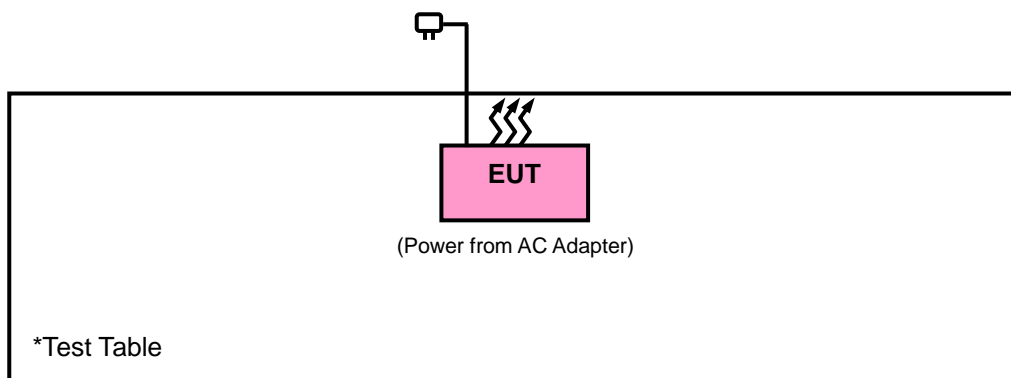

3.4 General Description of Applied Standards

The EUT is a RF Product. According to the specifications of the manufacturer, it must comply with the requirements of the following standards:

FCC Part 15, Subpart E (15.407)

789033 D02 General UNII Test Procedures New Rules v01

644545 D01 Guidance for IEEE 802 11ac v01r02

662911 D01 Multiple Transmitter Output v02r01

ANSI C63.10-2013

All test items have been performed and recorded as per the above standards.

NOTE: The EUT has been verified to comply with the requirements of FCC Part 15, Subpart B, Class B (DoC).
The test report has been issued separately.

4 Test Types and Results

4.1 Radiated Emission and Bandedge Measurement

4.1.1 Limits of Radiated Emission and Bandedge Measurement

Radiated emissions which fall in the restricted bands must comply with the radiated emission limits specified as below table. Other emissions shall be at least 20dB below the highest level of the desired power:

Frequencies (MHz)	Field Strength (microvolts/meter)	Measurement Distance (meters)
0.009 ~ 0.490	2400/F(kHz)	300
0.490 ~ 1.705	24000/F(kHz)	30
1.705 ~ 30.0	30	30
30 ~ 88	100	3
88 ~ 216	150	3
216 ~ 960	200	3
Above 960	500	3

NOTE:

1. The lower limit shall apply at the transition frequencies.
2. Emission level (dBuV/m) = 20 log Emission level (uV/m).
3. For frequencies above 1000MHz, the field strength limits are based on average detector, however, the peak field strength of any emission shall not exceed the maximum permitted average limits, specified above by more than 20dB under any condition of modulation.

4.1.2 Limits of Unwanted Emission Out of The Restricted Bands

Applicable To	Limit	
789033 D02 General UNII Test Procedures New Rules v01	Field Strength AT 3m	
	PK:74 (dBµV/m)	AV:54 (dBµV/m)
Applicable To	EIRP Limit	Equivalent Field Strength At 3m
15.407(b)(1)	PK:-27 (dBm/MHz)	PK:68.2(dBµV/m)
15.407(b)(2)		
15.407(b)(3)		
15.407(b)(4)	PK:-27 (dBm/MHz) ^{*1} PK:-17 (dBm/MHz) ^{*2}	PK: 68.2(dBµV/m) ^{*1} PK:78.2 (dBµV/m) ^{*2}

NOTE: ^{*1} beyond 10MHz of the band edge ^{*2} within 10 MHz of band edge

The following formula is used to convert the equipment isotropic radiated power (eirp) to field strength:

$$E = \frac{1000000\sqrt{30P}}{3} \mu\text{V/m, where P is the eirp (Watts).}$$

4.1.3 Test Instruments

Description & Manufacturer	Model No.	Serial No.	Date of Calibration	Due Date of Calibration
Spectrum Analyzer Agilent Technologies	N9038A	MY52260177	May 19, 2015	May 18, 2016
Spectrum Analyzer ROHDE & SCHWARZ	FSU43	101261	Dec. 10, 2014	Dec. 09, 2015
BILOG Antenna SCHWARZBECK	VULB9168	9168-472	Feb. 04, 2015	Feb. 04, 2016
HORN Antenna ETS-Lindgren	3117	00143293	Aug. 28, 2014	Aug. 27, 2015
Preamplifier Agilent	310N	187226	Jun. 29, 2015	Jun. 28, 2016
Preamplifier Agilent	83017A	980116	Jan. 09, 2015	Jan. 08, 2016
Power Meter Anritsu	ML2495A	1232002	Sep. 17, 2014	Sep. 16, 2015
Power Sensor Anritsu	MA2411B	1207325	Sep. 17, 2014	Sep. 16, 2015
RF signal cable ETS-LINDGREN	5D-FB	Cable-CH1-01(R FC-SMS-100-SM S-120+RFC-SMS -100-SMS-400)	Jun. 27, 2015	Jun. 26, 2016
RF signal cable ETS-LINDGREN	8D-FB	Cable-CH1-02(R FC-SMS-100-SM S-24)	Jun. 27, 2015	Jun. 26, 2016
Software BV ADT	E3 8.130425b	NA	NA	NA
Antenna Tower MF	NA	NA	NA	NA
Turn Table MF	NA	NA	NA	NA
Antenna Tower & Turn Table Controller MF	MF-7802	NA	NA	NA

- Note: 1. The calibration interval of the above test instruments is 12 months and the calibrations are traceable to NML/ROC and NIST/USA.
2. The test was performed in HsinTien Chamber 1.
3. The horn antenna and HP preamplifier (model: 8449B) are used only for the measurement of emission frequency above 1GHz if tested.
4. The FCC Site Registration No. is 149147.
5. The IC Site Registration No. is IC7450I-1.

4.1.4 Test Procedures

- a. The EUT was placed on the top of a rotating table 0.8 meters (for below 1GHz) / 1.5 meters (for above 1GHz) above the ground at 3 meter chamber room for test. The table was rotated 360 degrees to determine the position of the highest radiation.
- b. The EUT was set 3 meters away from the interference-receiving antenna, which was mounted on the top of a variable-height antenna tower.
- c. The height of antenna is varied from one meter to four meters above the ground to determine the maximum value of the field strength. Both horizontal and vertical polarizations of the antenna are set to make the measurement.
- d. For each suspected emission, the EUT was arranged to its worst case and then the antenna was tuned to heights from 1 meter to 4 meters and the rotatable table was turned from 0 degrees to 360 degrees to find the maximum reading.
- e. The test-receiver system was set to quasi-peak detect function and specified bandwidth with maximum hold mode when the test frequency is below 1 GHz.
- f. The test-receiver system was set to peak and average detect function and specified bandwidth with maximum hold mode when the test frequency is above 1 GHz. If the peak reading value also meets average limit, measurement with the average detector is unnecessary.

Note:

1. The resolution bandwidth and video bandwidth of test receiver/spectrum analyzer is 120kHz for Quasi-peak detection (QP) at frequency below 1GHz.
2. The resolution bandwidth of test receiver/spectrum analyzer is 1 MHz and the video bandwidth is 3 MHz for Peak detection (PK) at frequency above 1GHz.
3. The resolution bandwidth of test receiver/spectrum analyzer is 1MHz and the video bandwidth is 3MHz for RMS Average (Duty cycle < 98%) for Average detection (AV) at frequency above 1GHz, then the measurement results was added to a correction factor ($10 \log(1/\text{duty cycle})$).
4. The resolution bandwidth of test receiver/spectrum analyzer is 1MHz and the video bandwidth is 10Hz (Duty cycle $\geq 98\%$) for Average detection (AV) at frequency above 1GHz.
5. All modes of operation were investigated and the worst-case emissions are reported.

4.1.5 Deviation from Test Standard

No deviation.

4.1.6 Test Set Up

<Frequency Range below 1GHz>

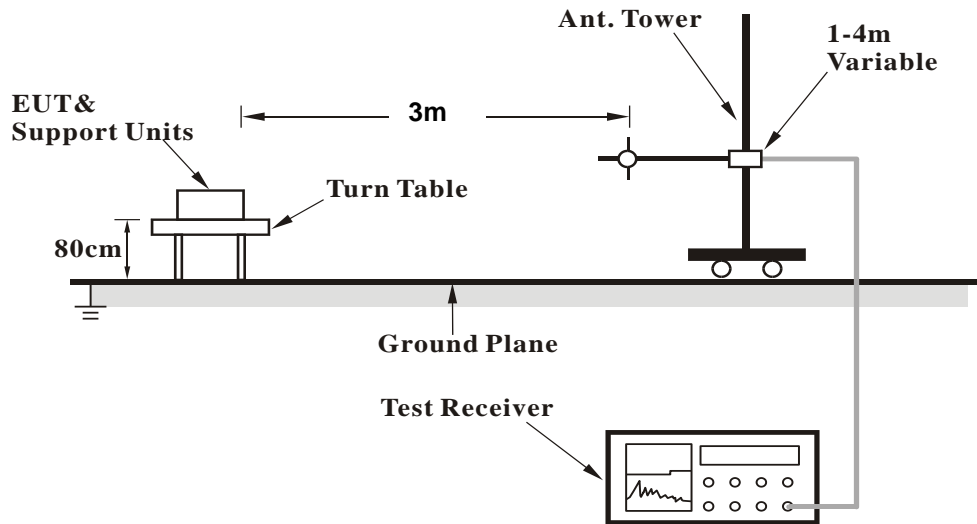

<Frequency Range above 1GHz>

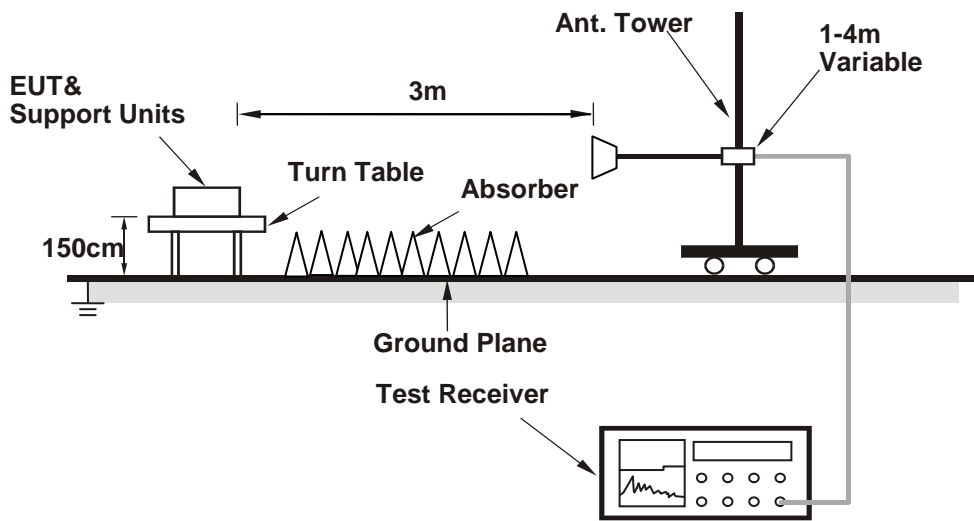

For the actual test configuration, please refer to the attached file (Test Setup Photo).

4.1.7 EUT Operating Conditions

- a. Placed the EUT on a testing table.
- b. Use the software to control the EUT under transmission condition continuously at specific channel frequency.

4.1.8 Test Results
ABOVE 1GHz DATA :
Mode B (1Tx)
802.11a

EUT TEST CONDITION		MEASUREMENT DETAIL	
CHANNEL	Channel 36	FREQUENCY RANGE	1GHz ~ 40GHz
INPUT POWER	120Vac, 60 Hz	DETECTOR FUNCTION	Peak (PK) Average (AV)
ENVIRONMENTAL CONDITIONS	25deg. C, 65%RH	TESTED BY	Karl Lee

ANTENNA POLARITY & TEST DISTANCE: HORIZONTAL AT 3 M										
FREQ. (MHz)	EMISSION LEVEL (dBuV/m)	READ LEVEL (dBuV)	LIMIT (dBuV/m)	MARGIN (dB)	ANTENNA FACTOR (dB/m)	CABLE LOSS (dB)	PREAMP FACTOR (dB)	ANTENNA HEIGHT (cm)	TABLE ANGLE (Degree)	REMARK
5150	52.24	43.99	54	-1.76	34.12	8.13	34	151	11	Average
5150	66.25	58	74	-7.75	34.12	8.13	34	151	11	Peak
5180	99.05	90.74			34.15	8.16	34	151	11	Average
5180	107.41	99.1			34.15	8.16	34	151	11	Peak
5456	43.51	34.69	54	-10.49	34.36	8.51	34.05	151	11	Average
5456	57.19	48.37	74	-16.81	34.36	8.51	34.05	151	11	Peak
ANTENNA POLARITY & TEST DISTANCE: VERTICAL AT 3 M										
FREQ. (MHz)	EMISSION LEVEL (dBuV/m)	READ LEVEL (dBuV)	LIMIT (dBuV/m)	MARGIN (dB)	ANTENNA FACTOR (dB/m)	CABLE LOSS (dB)	PREAMP FACTOR (dB)	ANTENNA HEIGHT (cm)	TABLE ANGLE (Degree)	REMARK
5150	51.25	43	54	-2.75	34.12	8.13	34	216	335	Average
5150	65.94	57.69	74	-8.06	34.12	8.13	34	216	335	Peak
5180	97.65	89.34			34.15	8.16	34	216	335	Average
5180	105.17	96.86			34.15	8.16	34	216	335	Peak
5434	43.25	34.46	54	-10.75	34.35	8.48	34.04	216	335	Average
5434	56.33	47.54	74	-17.67	34.35	8.48	34.04	216	335	Peak

REMARKS:

- Emission Level = Read Level + Antenna Factor + Cable Loss - Preamp Factor
Margin value = Emission level – Limit value
- 5180MHz: Fundamental frequency.



A D T

EUT TEST CONDITION		MEASUREMENT DETAIL	
CHANNEL	Channel 44	FREQUENCY RANGE	1GHz ~ 40GHz
INPUT POWER	120Vac, 60 Hz	DETECTOR FUNCTION	Peak (PK) Average (AV)
ENVIRONMENTAL CONDITIONS	25deg. C, 65%RH	TESTED BY	Karl Lee

ANTENNA POLARITY & TEST DISTANCE: HORIZONTAL AT 3 M										
FREQ. (MHz)	EMISSION LEVEL (dBuV/m)	READ LEVEL (dBuV)	LIMIT (dBuV/m)	MARGIN (dB)	ANTENNA FACTOR (dB/m)	CABLE LOSS (dB)	PREAMP FACTOR (dB)	ANTENNA HEIGHT (cm)	TABLE ANGLE (Degree)	REMARK
5068	43.34	35.24	54	-10.66	34.05	8.03	33.98	151	112	Average
5068	56.63	48.53	74	-17.37	34.05	8.03	33.98	151	112	Peak
5220	100.88	92.49			34.17	8.22	34	151	112	Average
5220	108.2	99.81			34.17	8.22	34	151	112	Peak
5388	43.57	34.89	54	-10.43	34.31	8.41	34.04	151	112	Average
5388	57.64	48.96	74	-16.36	34.31	8.41	34.04	151	112	Peak
ANTENNA POLARITY & TEST DISTANCE: VERTICAL AT 3 M										
FREQ. (MHz)	EMISSION LEVEL (dBuV/m)	READ LEVEL (dBuV)	LIMIT (dBuV/m)	MARGIN (dB)	ANTENNA FACTOR (dB/m)	CABLE LOSS (dB)	PREAMP FACTOR (dB)	ANTENNA HEIGHT (cm)	TABLE ANGLE (Degree)	REMARK
5144	43.15	34.9	54	-10.85	34.12	8.13	34	212	335	Average
5144	57.24	48.99	74	-16.76	34.12	8.13	34	212	335	Peak
5220	98.86	90.47			34.17	8.22	34	212	335	Average
5220	106.05	97.66			34.17	8.22	34	212	335	Peak
5380	43.27	34.59	54	-10.73	34.31	8.41	34.04	212	335	Average
5380	57.77	49.09	74	-16.23	34.31	8.41	34.04	212	335	Peak

REMARKS:

- Emission Level = Read Level + Antenna Factor + Cable Loss - Preamp Factor
Margin value = Emission level – Limit value
- 5220MHz: Fundamental frequency.



EUT TEST CONDITION		MEASUREMENT DETAIL	
CHANNEL	Channel 48	FREQUENCY RANGE	1GHz ~ 40GHz
INPUT POWER	120Vac, 60 Hz	DETECTOR FUNCTION	Peak (PK) Average (AV)
ENVIRONMENTAL CONDITIONS	25deg. C, 65%RH	TESTED BY	Karl Lee

ANTENNA POLARITY & TEST DISTANCE: HORIZONTAL AT 3 M										
FREQ. (MHz)	EMISSION LEVEL (dBuV/m)	READ LEVEL (dBuV)	LIMIT (dBuV/m)	MARGIN (dB)	ANTENNA FACTOR (dB/m)	CABLE LOSS (dB)	PREAMP FACTOR (dB)	ANTENNA HEIGHT (cm)	TABLE ANGLE (Degree)	REMARK
5078	42.59	34.47	54	-11.41	34.07	8.03	33.98	138	110	Average
5078	56.77	48.65	74	-17.23	34.07	8.03	33.98	138	110	Peak
5240	101.56	93.12			34.19	8.26	34.01	138	110	Average
5240	108.5	100.06			34.19	8.26	34.01	138	110	Peak
5458	43.94	35.12	54	-10.06	34.36	8.51	34.05	138	110	Average
5458	57.13	48.31	74	-16.87	34.36	8.51	34.05	138	110	Peak

ANTENNA POLARITY & TEST DISTANCE: VERTICAL AT 3 M										
FREQ. (MHz)	EMISSION LEVEL (dBuV/m)	READ LEVEL (dBuV)	LIMIT (dBuV/m)	MARGIN (dB)	ANTENNA FACTOR (dB/m)	CABLE LOSS (dB)	PREAMP FACTOR (dB)	ANTENNA HEIGHT (cm)	TABLE ANGLE (Degree)	REMARK
5144	42.75	34.5	54	-11.25	34.12	8.13	34	212	335	Average
5144	57.85	49.6	74	-16.15	34.12	8.13	34	212	335	Peak
5240	99.02	90.58			34.19	8.26	34.01	212	335	Average
5240	106.75	98.31			34.19	8.26	34.01	212	335	Peak
5442	43.02	34.23	54	-10.98	34.35	8.48	34.04	212	335	Average
5442	58.18	49.39	74	-15.82	34.35	8.48	34.04	212	335	Peak

REMARKS:

- Emission Level = Read Level + Antenna Factor + Cable Loss - Preamp Factor
Margin value = Emission level – Limit value
- 5240MHz: Fundamental frequency.



EUT TEST CONDITION		MEASUREMENT DETAIL	
CHANNEL	Channel 52	FREQUENCY RANGE	1GHz ~ 40GHz
INPUT POWER	120Vac, 60 Hz	DETECTOR FUNCTION	Peak (PK) Average (AV)
ENVIRONMENTAL CONDITIONS	25deg. C, 65%RH	TESTED BY	Karl Lee

ANTENNA POLARITY & TEST DISTANCE: HORIZONTAL AT 3 M										
FREQ. (MHz)	EMISSION LEVEL (dBuV/m)	READ LEVEL (dBuV)	LIMIT (dBuV/m)	MARGIN (dB)	ANTENNA FACTOR (dB/m)	CABLE LOSS (dB)	PREAMP FACTOR (dB)	ANTENNA HEIGHT (cm)	TABLE ANGLE (Degree)	REMARK
5066	42.37	34.27	54	-11.63	34.05	8.03	33.98	121	14	Average
5066	56.87	48.77	74	-17.13	34.05	8.03	33.98	121	14	Peak
5260	100.44	91.98			34.21	8.26	34.01	121	14	Average
5260	108.49	100.03			34.21	8.26	34.01	121	14	Peak
5428	43.12	34.35	54	-10.88	34.33	8.48	34.04	121	14	Average
5428	57.39	48.62	74	-16.61	34.33	8.48	34.04	121	14	Peak
ANTENNA POLARITY & TEST DISTANCE: VERTICAL AT 3 M										
FREQ. (MHz)	EMISSION LEVEL (dBuV/m)	READ LEVEL (dBuV)	LIMIT (dBuV/m)	MARGIN (dB)	ANTENNA FACTOR (dB/m)	CABLE LOSS (dB)	PREAMP FACTOR (dB)	ANTENNA HEIGHT (cm)	TABLE ANGLE (Degree)	REMARK
5090	42.32	34.15	54	-11.68	34.08	8.07	33.98	116	358	Average
5090	56.99	48.82	74	-17.01	34.08	8.07	33.98	116	358	Peak
5260	98.84	90.38			34.21	8.26	34.01	116	358	Average
5260	106.27	97.81			34.21	8.26	34.01	116	358	Peak
5424	42.44	33.67	54	-11.56	34.33	8.48	34.04	116	358	Average
5424	57.33	48.56	74	-16.67	34.33	8.48	34.04	116	358	Peak

REMARKS:

- Emission Level = Read Level + Antenna Factor + Cable Loss - Preamp Factor
Margin value = Emission level – Limit value
- 5260MHz: Fundamental frequency.



EUT TEST CONDITION		MEASUREMENT DETAIL	
CHANNEL	Channel 60	FREQUENCY RANGE	1GHz ~ 40GHz
INPUT POWER	120Vac, 60 Hz	DETECTOR FUNCTION	Peak (PK) Average (AV)
ENVIRONMENTAL CONDITIONS	25deg. C, 65%RH	TESTED BY	Karl Lee

ANTENNA POLARITY & TEST DISTANCE: HORIZONTAL AT 3 M										
FREQ. (MHz)	EMISSION LEVEL (dBuV/m)	READ LEVEL (dBuV)	LIMIT (dBuV/m)	MARGIN (dB)	ANTENNA FACTOR (dB/m)	CABLE LOSS (dB)	PREAMP FACTOR (dB)	ANTENNA HEIGHT (cm)	TABLE ANGLE (Degree)	REMARK
5142	42.65	34.39	54	-11.35	34.12	8.13	33.99	152	14	Average
5142	56.95	48.69	74	-17.05	34.12	8.13	33.99	152	14	Peak
5300	99.25	90.71			34.24	8.32	34.02	152	14	Average
5300	107.68	99.14			34.24	8.32	34.02	152	14	Peak
5352	46.02	37.39	54	-7.98	34.28	8.38	34.03	152	14	Average
5352	58.14	49.51	74	-15.86	34.28	8.38	34.03	152	14	Peak

ANTENNA POLARITY & TEST DISTANCE: VERTICAL AT 3 M										
FREQ. (MHz)	EMISSION LEVEL (dBuV/m)	READ LEVEL (dBuV)	LIMIT (dBuV/m)	MARGIN (dB)	ANTENNA FACTOR (dB/m)	CABLE LOSS (dB)	PREAMP FACTOR (dB)	ANTENNA HEIGHT (cm)	TABLE ANGLE (Degree)	REMARK
5142	42.43	34.17	54	-11.57	34.12	8.13	33.99	103	211	Average
5142	56.75	48.49	74	-17.25	34.12	8.13	33.99	103	211	Peak
5300	98.25	89.71			34.24	8.32	34.02	103	211	Average
5300	105.65	97.11			34.24	8.32	34.02	103	211	Peak
5350	45.19	36.56	54	-8.81	34.28	8.38	34.03	103	211	Average
5350	58.72	50.09	74	-15.28	34.28	8.38	34.03	103	211	Peak

REMARKS:

- Emission Level = Read Level + Antenna Factor + Cable Loss - Preamp Factor
Margin value = Emission level – Limit value
- 5300MHz: Fundamental frequency.



EUT TEST CONDITION		MEASUREMENT DETAIL	
CHANNEL	Channel 64	FREQUENCY RANGE	1GHz ~ 40GHz
INPUT POWER	120Vac, 60 Hz	DETECTOR FUNCTION	Peak (PK) Average (AV)
ENVIRONMENTAL CONDITIONS	25deg. C, 65%RH	TESTED BY	Karl Lee

ANTENNA POLARITY & TEST DISTANCE: HORIZONTAL AT 3 M										
FREQ. (MHz)	EMISSION LEVEL (dBuV/m)	READ LEVEL (dBuV)	LIMIT (dBuV/m)	MARGIN (dB)	ANTENNA FACTOR (dB/m)	CABLE LOSS (dB)	PREAMP FACTOR (dB)	ANTENNA HEIGHT (cm)	TABLE ANGLE (Degree)	REMARK
5078	42.5	34.38	54	-11.5	34.07	8.03	33.98	152	14	Average
5078	57.29	49.17	74	-16.71	34.07	8.03	33.98	152	14	Peak
5320	98	89.42			34.25	8.35	34.02	152	14	Average
5320	105.45	96.87			34.25	8.35	34.02	152	14	Peak
5350	49.48	40.85	54	-4.52	34.28	8.38	34.03	152	14	Average
5350	62.48	53.85	74	-11.52	34.28	8.38	34.03	152	14	Peak

ANTENNA POLARITY & TEST DISTANCE: VERTICAL AT 3 M										
FREQ. (MHz)	EMISSION LEVEL (dBuV/m)	READ LEVEL (dBuV)	LIMIT (dBuV/m)	MARGIN (dB)	ANTENNA FACTOR (dB/m)	CABLE LOSS (dB)	PREAMP FACTOR (dB)	ANTENNA HEIGHT (cm)	TABLE ANGLE (Degree)	REMARK
5050	42.24	34.18	54	-11.76	34.04	8	33.98	109	211	Average
5050	57.16	49.1	74	-16.84	34.04	8	33.98	109	211	Peak
5320	96.97	88.39			34.25	8.35	34.02	109	211	Average
5320	103.95	95.37			34.25	8.35	34.02	109	211	Peak
5350	48.04	39.41	54	-5.96	34.28	8.38	34.03	109	211	Average
5350	62.34	53.71	74	-11.66	34.28	8.38	34.03	109	211	Peak

REMARKS:

- Emission Level = Read Level + Antenna Factor + Cable Loss - Preamp Factor
Margin value = Emission level – Limit value
- 5320MHz: Fundamental frequency.



EUT TEST CONDITION		MEASUREMENT DETAIL	
CHANNEL	Channel 100	FREQUENCY RANGE	1GHz ~ 40GHz
INPUT POWER	120Vac, 60 Hz	DETECTOR FUNCTION	Peak (PK) Average (AV)
ENVIRONMENTAL CONDITIONS	25deg. C, 65%RH	TESTED BY	Karl Lee

ANTENNA POLARITY & TEST DISTANCE: HORIZONTAL AT 3 M

FREQ. (MHz)	EMISSION LEVEL (dBuV/m)	READ LEVEL (dBuV)	LIMIT (dBuV/m)	MARGIN (dB)	ANTENNA FACTOR (dB/m)	CABLE LOSS (dB)	PREAMP FACTOR (dB)	ANTENNA HEIGHT (cm)	TABLE ANGLE (Degree)	REMARK
5460	45.64	36.82	54	-8.36	34.36	8.51	34.05	107	77	Average
5460	58.97	50.15	74	-15.03	34.36	8.51	34.05	107	77	Peak
5470	63.45	54.62	68.2	-4.75	34.37	8.51	34.05	107	77	Peak
5500	98.65	89.73			34.4	8.57	34.05	107	77	Average
5500	106.11	97.19			34.4	8.57	34.05	107	77	Peak
5725	56.64	47.48	68.2	-11.56	34.62	8.65	34.11	107	77	Peak

ANTENNA POLARITY & TEST DISTANCE: VERTICAL AT 3 M

FREQ. (MHz)	EMISSION LEVEL (dBuV/m)	READ LEVEL (dBuV)	LIMIT (dBuV/m)	MARGIN (dB)	ANTENNA FACTOR (dB/m)	CABLE LOSS (dB)	PREAMP FACTOR (dB)	ANTENNA HEIGHT (cm)	TABLE ANGLE (Degree)	REMARK
5458	45.25	36.43	54	-8.75	34.36	8.51	34.05	194	91	Average
5458	58.84	50.02	74	-15.16	34.36	8.51	34.05	194	91	Peak
5470	59.09	50.26	68.2	-9.11	34.37	8.51	34.05	194	91	Peak
5500	96.73	87.81			34.4	8.57	34.05	194	91	Average
5500	104.26	95.34			34.4	8.57	34.05	194	91	Peak
5725	57.08	47.92	68.2	-11.12	34.62	8.65	34.11	194	91	Peak

REMARKS:

- Emission Level = Read Level + Antenna Factor + Cable Loss - Preamp Factor
Margin value = Emission level – Limit value
- 5500MHz: Fundamental frequency.
- 5470MHz & 5725MHz: Out of restricted band



EUT TEST CONDITION		MEASUREMENT DETAIL	
CHANNEL	Channel 116	FREQUENCY RANGE	1GHz ~ 40GHz
INPUT POWER	120Vac, 60 Hz	DETECTOR FUNCTION	Peak (PK) Average (AV)
ENVIRONMENTAL CONDITIONS	25deg. C, 65%RH	TESTED BY	Karl Lee

ANTENNA POLARITY & TEST DISTANCE: HORIZONTAL AT 3 M										
FREQ. (MHz)	EMISSION LEVEL (dBuV/m)	READ LEVEL (dBuV)	LIMIT (dBuV/m)	MARGIN (dB)	ANTENNA FACTOR (dB/m)	CABLE LOSS (dB)	PREAMP FACTOR (dB)	ANTENNA HEIGHT (cm)	TABLE ANGLE (Degree)	REMARK
5444	43.22	34.43	54	-10.78	34.35	8.48	34.04	109	75	Average
5444	57.53	48.74	74	-16.47	34.35	8.48	34.04	109	75	Peak
5470	56.67	47.84	68.2	-11.53	34.37	8.51	34.05	109	75	Peak
5580	102.77	93.78			34.47	8.6	34.08	109	75	Average
5580	110.06	101.07			34.47	8.6	34.08	109	75	Peak
5725	56.52	47.36	68.2	-11.68	34.62	8.65	34.11	109	75	Peak
ANTENNA POLARITY & TEST DISTANCE: VERTICAL AT 3 M										
FREQ. (MHz)	EMISSION LEVEL (dBuV/m)	READ LEVEL (dBuV)	LIMIT (dBuV/m)	MARGIN (dB)	ANTENNA FACTOR (dB/m)	CABLE LOSS (dB)	PREAMP FACTOR (dB)	ANTENNA HEIGHT (cm)	TABLE ANGLE (Degree)	REMARK
5404	42.86	34.14	54	-11.14	34.32	8.44	34.04	194	91	Average
5404	57.21	48.49	74	-16.79	34.32	8.44	34.04	194	91	Peak
5470	56.23	47.4	68.2	-11.97	34.37	8.51	34.05	194	91	Peak
5580	100.07	91.08			34.47	8.6	34.08	194	91	Average
5580	108.92	99.93			34.47	8.6	34.08	194	91	Peak
5725	56.15	46.99	68.2	-12.05	34.62	8.65	34.11	194	91	Peak
11160	48.58	33.5	54	-5.42	37.7	12.83	35.45	103	281	Average
11160	59.12	44.04	74	-14.88	37.7	12.83	35.45	103	281	Peak

REMARKS:

- Emission Level = Read Level + Antenna Factor + Cable Loss - Preamp Factor
Margin value = Emission level – Limit value
- 5580MHz: Fundamental frequency.
- 5470MHz & 5725MHz: Out of restricted band



A D T

EUT TEST CONDITION		MEASUREMENT DETAIL	
CHANNEL	Channel 140	FREQUENCY RANGE	1GHz ~ 40GHz
INPUT POWER	120Vac, 60 Hz	DETECTOR FUNCTION	Peak (PK) Average (AV)
ENVIRONMENTAL CONDITIONS	25deg. C, 65%RH	TESTED BY	Karl Lee

ANTENNA POLARITY & TEST DISTANCE: HORIZONTAL AT 3 M										
FREQ. (MHz)	EMISSION LEVEL (dBuV/m)	READ LEVEL (dBuV)	LIMIT (dBuV/m)	MARGIN (dB)	ANTENNA FACTOR (dB/m)	CABLE LOSS (dB)	PREAMP FACTOR (dB)	ANTENNA HEIGHT (cm)	TABLE ANGLE (Degree)	REMARK
5450	42.67	33.85	54	-11.33	34.36	8.51	34.05	107	38	Average
5450	57.19	48.37	74	-16.81	34.36	8.51	34.05	107	38	Peak
5470	57.6	48.77	68.2	-10.6	34.37	8.51	34.05	107	38	Peak
5700	99.83	90.7			34.59	8.64	34.1	107	38	Average
5700	107.71	98.58			34.59	8.64	34.1	107	38	Peak
5725	66.76	57.6	68.2	-1.44	34.62	8.65	34.11	107	38	Peak
ANTENNA POLARITY & TEST DISTANCE: VERTICAL AT 3 M										
FREQ. (MHz)	EMISSION LEVEL (dBuV/m)	READ LEVEL (dBuV)	LIMIT (dBuV/m)	MARGIN (dB)	ANTENNA FACTOR (dB/m)	CABLE LOSS (dB)	PREAMP FACTOR (dB)	ANTENNA HEIGHT (cm)	TABLE ANGLE (Degree)	REMARK
5410	42.66	33.94	54	-11.34	34.32	8.44	34.04	190	91	Average
5410	56.32	47.6	74	-17.68	34.32	8.44	34.04	190	91	Peak
5470	55.33	46.5	68.2	-12.87	34.37	8.51	34.05	190	91	Peak
5700	97.63	88.5			34.59	8.64	34.1	190	91	Average
5700	105.33	96.2			34.59	8.64	34.1	190	91	Peak
5725	66.35	57.19	68.2	-1.85	34.62	8.65	34.11	190	91	Peak

REMARKS:

- Emission Level = Read Level + Antenna Factor + Cable Loss - Preamp Factor
Margin value = Emission level – Limit value
- 5700MHz: Fundamental frequency.
- 5470MHz & 5725MHz: Out of restricted band



EUT TEST CONDITION		MEASUREMENT DETAIL	
CHANNEL	Channel 149	FREQUENCY RANGE	1GHz ~ 40GHz
INPUT POWER	120Vac, 60 Hz	DETECTOR FUNCTION	Peak (PK) Average (AV)
ENVIRONMENTAL CONDITIONS	25deg. C, 65%RH	TESTED BY	Karl Lee

ANTENNA POLARITY & TEST DISTANCE: HORIZONTAL AT 3 M

FREQ. (MHz)	EMISSION LEVEL (dBuV/m)	READ LEVEL (dBuV)	LIMIT (dBuV/m)	MARGIN (dB)	ANTENNA FACTOR (dB/m)	CABLE LOSS (dB)	PREAMP FACTOR (dB)	ANTENNA HEIGHT (cm)	TABLE ANGLE (Degree)	REMARK
*5714	62.86	53.71	68.2	-5.34	34.61	8.65	34.11	148	167	Peak
*5724	70.7	61.54	78.2	-7.5	34.62	8.65	34.11	148	167	Peak
5745	99.33	90.14			34.64	8.66	34.11	148	167	Average
5745	107.34	98.15			34.64	8.66	34.11	148	167	Peak
*5856	58.32	49	78.2	-19.88	34.76	8.7	34.14	148	167	Peak
*5866	57.61	48.28	68.2	-10.59	34.76	8.71	34.14	148	167	Peak

ANTENNA POLARITY & TEST DISTANCE: VERTICAL AT 3 M

FREQ. (MHz)	EMISSION LEVEL (dBuV/m)	READ LEVEL (dBuV)	LIMIT (dBuV/m)	MARGIN (dB)	ANTENNA FACTOR (dB/m)	CABLE LOSS (dB)	PREAMP FACTOR (dB)	ANTENNA HEIGHT (cm)	TABLE ANGLE (Degree)	REMARK
*5714	61.72	52.57	68.2	-6.48	34.61	8.65	34.11	101	168	Peak
*5724	66.78	57.62	78.2	-11.42	34.62	8.65	34.11	101	168	Peak
5745	97.76	88.57			34.64	8.66	34.11	101	168	Average
5745	105.62	96.43			34.64	8.66	34.11	101	168	Peak
*5858	57.62	48.3	78.2	-20.58	34.76	8.7	34.14	101	168	Peak
*5866	58.06	48.73	68.2	-10.14	34.76	8.71	34.14	101	168	Peak

REMARKS:

- Emission Level = Read Level + Antenna Factor + Cable Loss - Preamp Factor
Margin value = Emission level – Limit value
- 5745MHz: Fundamental frequency.
- *: Out of restricted band



EUT TEST CONDITION		MEASUREMENT DETAIL	
CHANNEL	Channel 157	FREQUENCY RANGE	1GHz ~ 40GHz
INPUT POWER	120Vac, 60 Hz	DETECTOR FUNCTION	Peak (PK) Average (AV)
ENVIRONMENTAL CONDITIONS	25deg. C, 65%RH	TESTED BY	Karl Lee

ANTENNA POLARITY & TEST DISTANCE: HORIZONTAL AT 3 M										
FREQ. (MHz)	EMISSION LEVEL (dBuV/m)	READ LEVEL (dBuV)	LIMIT (dBuV/m)	MARGIN (dB)	ANTENNA FACTOR (dB/m)	CABLE LOSS (dB)	PREAMP FACTOR (dB)	ANTENNA HEIGHT (cm)	TABLE ANGLE (Degree)	REMARK
*5712	58.19	49.04	68.2	-10.01	34.61	8.65	34.11	148	167	Peak
*5724	59.24	50.08	78.2	-18.96	34.62	8.65	34.11	148	167	Peak
5785	101.64	92.41			34.68	8.68	34.13	148	167	Average
5785	108.95	99.72			34.68	8.68	34.13	148	167	Peak
*5858	58.56	49.24	78.2	-19.64	34.76	8.7	34.14	148	167	Peak
*5868	59.71	50.38	68.2	-8.49	34.76	8.71	34.14	148	167	Peak
ANTENNA POLARITY & TEST DISTANCE: VERTICAL AT 3 M										
FREQ. (MHz)	EMISSION LEVEL (dBuV/m)	READ LEVEL (dBuV)	LIMIT (dBuV/m)	MARGIN (dB)	ANTENNA FACTOR (dB/m)	CABLE LOSS (dB)	PREAMP FACTOR (dB)	ANTENNA HEIGHT (cm)	TABLE ANGLE (Degree)	REMARK
*5712	58.76	49.61	68.2	-9.44	34.61	8.65	34.11	100	169	Peak
*5720	58.44	49.28	78.2	-19.76	34.62	8.65	34.11	100	169	Peak
5785	99.55	90.32			34.68	8.68	34.13	100	169	Average
5785	106.99	97.76			34.68	8.68	34.13	100	169	Peak
*5854	58	48.68	78.2	-20.2	34.76	8.7	34.14	100	169	Peak
*5870	60.13	50.8	68.2	-8.07	34.76	8.71	34.14	100	169	Peak

REMARKS:

- Emission Level = Read Level + Antenna Factor + Cable Loss - Preamp Factor
Margin value = Emission level – Limit value
- 5785MHz: Fundamental frequency.
- *: Out of restricted band



EUT TEST CONDITION		MEASUREMENT DETAIL	
CHANNEL	Channel 165	FREQUENCY RANGE	1GHz ~ 40GHz
INPUT POWER	120Vac, 60 Hz	DETECTOR FUNCTION	Peak (PK) Average (AV)
ENVIRONMENTAL CONDITIONS	25deg. C, 65%RH	TESTED BY	Karl Lee

ANTENNA POLARITY & TEST DISTANCE: HORIZONTAL AT 3 M										
FREQ. (MHz)	EMISSION LEVEL (dBuV/m)	READ LEVEL (dBuV)	LIMIT (dBuV/m)	MARGIN (dB)	ANTENNA FACTOR (dB/m)	CABLE LOSS (dB)	PREAMP FACTOR (dB)	ANTENNA HEIGHT (cm)	TABLE ANGLE (Degree)	REMARK
*5706	59.61	50.46	68.2	-8.59	34.61	8.65	34.11	160	167	Peak
*5718	58.72	49.56	78.2	-19.48	34.62	8.65	34.11	160	167	Peak
5825	100.29	91			34.73	8.69	34.13	160	167	Average
5825	107.66	98.37			34.73	8.69	34.13	160	167	Peak
*5852	73.55	64.25	78.2	-4.65	34.74	8.7	34.14	160	167	Peak
*5864	62.87	53.54	68.2	-5.33	34.76	8.71	34.14	160	167	Peak
ANTENNA POLARITY & TEST DISTANCE: VERTICAL AT 3 M										
FREQ. (MHz)	EMISSION LEVEL (dBuV/m)	READ LEVEL (dBuV)	LIMIT (dBuV/m)	MARGIN (dB)	ANTENNA FACTOR (dB/m)	CABLE LOSS (dB)	PREAMP FACTOR (dB)	ANTENNA HEIGHT (cm)	TABLE ANGLE (Degree)	REMARK
*5714	57.77	48.62	68.2	-10.43	34.61	8.65	34.11	100	165	Peak
*5720	57.64	48.48	78.2	-20.56	34.62	8.65	34.11	100	165	Peak
5825	97.96	88.67			34.73	8.69	34.13	100	165	Average
5825	105.67	96.38			34.73	8.69	34.13	100	165	Peak
*5852	63.49	54.19	78.2	-14.71	34.74	8.7	34.14	100	165	Peak
*5862	59.47	50.14	68.2	-8.73	34.76	8.71	34.14	100	165	Peak

REMARKS:

- Emission Level = Read Level + Antenna Factor + Cable Loss - Preamp Factor
Margin value = Emission level – Limit value
- 5825MHz: Fundamental frequency.
- *: Out of restricted band

802.11n (20MHz)

EUT TEST CONDITION		MEASUREMENT DETAIL	
CHANNEL	Channel 36	FREQUENCY RANGE	1GHz ~ 40GHz
INPUT POWER	120Vac, 60 Hz	DETECTOR FUNCTION	Peak (PK) Average (AV)
ENVIRONMENTAL CONDITIONS	25deg. C, 65%RH	TESTED BY	Karl Lee

ANTENNA POLARITY & TEST DISTANCE: HORIZONTAL AT 3 M

FREQ. (MHz)	EMISSION LEVEL (dBuV/m)	READ LEVEL (dBuV)	LIMIT (dBuV/m)	MARGIN (dB)	ANTENNA FACTOR (dB/m)	CABLE LOSS (dB)	PREAMP FACTOR (dB)	ANTENNA HEIGHT (cm)	TABLE ANGLE (Degree)	REMARK
5150	47.78	39.53	54	-6.22	34.12	8.13	34	187	76	Average
5150	62.64	54.39	74	-11.36	34.12	8.13	34	187	76	Peak
5180	97.49	89.18			34.15	8.16	34	187	76	Average
5180	105.25	96.94			34.15	8.16	34	187	76	Peak
5356	44.05	35.42	54	-9.95	34.28	8.38	34.03	187	76	Average
5356	58.42	49.79	74	-15.58	34.28	8.38	34.03	187	76	Peak

ANTENNA POLARITY & TEST DISTANCE: VERTICAL AT 3 M

FREQ. (MHz)	EMISSION LEVEL (dBuV/m)	READ LEVEL (dBuV)	LIMIT (dBuV/m)	MARGIN (dB)	ANTENNA FACTOR (dB/m)	CABLE LOSS (dB)	PREAMP FACTOR (dB)	ANTENNA HEIGHT (cm)	TABLE ANGLE (Degree)	REMARK
5148	46.37	38.12	54	-7.63	34.12	8.13	34	120	11	Average
5148	58.69	50.44	74	-15.31	34.12	8.13	34	120	11	Peak
5180	95.03	86.72			34.15	8.16	34	120	11	Average
5180	102.97	94.66			34.15	8.16	34	120	11	Peak
5450	43.67	34.85	54	-10.33	34.36	8.51	34.05	120	11	Average
5450	58.27	49.45	74	-15.73	34.36	8.51	34.05	120	11	Peak

REMARKS:

- Emission Level = Read Level + Antenna Factor + Cable Loss - Preamp Factor
Margin value = Emission level – Limit value
- 5180MHz: Fundamental frequency.



EUT TEST CONDITION		MEASUREMENT DETAIL	
CHANNEL	Channel 44	FREQUENCY RANGE	1GHz ~ 40GHz
INPUT POWER	120Vac, 60 Hz	DETECTOR FUNCTION	Peak (PK) Average (AV)
ENVIRONMENTAL CONDITIONS	25deg. C, 65%RH	TESTED BY	Karl Lee

ANTENNA POLARITY & TEST DISTANCE: HORIZONTAL AT 3 M										
FREQ. (MHz)	EMISSION LEVEL (dBuV/m)	READ LEVEL (dBuV)	LIMIT (dBuV/m)	MARGIN (dB)	ANTENNA FACTOR (dB/m)	CABLE LOSS (dB)	PREAMP FACTOR (dB)	ANTENNA HEIGHT (cm)	TABLE ANGLE (Degree)	REMARK
5130	43.93	35.71	54	-10.07	34.11	8.1	33.99	187	76	Average
5130	57.66	49.44	74	-16.34	34.11	8.1	33.99	187	76	Peak
5220	98.69	90.3			34.17	8.22	34	187	76	Average
5220	106.46	98.07			34.17	8.22	34	187	76	Peak
5382	43.93	35.25	54	-10.07	34.31	8.41	34.04	187	76	Average
5382	58.12	49.44	74	-15.88	34.31	8.41	34.04	187	76	Peak
ANTENNA POLARITY & TEST DISTANCE: VERTICAL AT 3 M										
FREQ. (MHz)	EMISSION LEVEL (dBuV/m)	READ LEVEL (dBuV)	LIMIT (dBuV/m)	MARGIN (dB)	ANTENNA FACTOR (dB/m)	CABLE LOSS (dB)	PREAMP FACTOR (dB)	ANTENNA HEIGHT (cm)	TABLE ANGLE (Degree)	REMARK
5038	42.81	34.74	54	-11.19	34.04	8	33.97	126	10	Average
5038	57.17	49.1	74	-16.83	34.04	8	33.97	126	10	Peak
5220	96.64	88.25			34.17	8.22	34	126	10	Average
5220	104.2	95.81			34.17	8.22	34	126	10	Peak
5454	43.85	35.03	54	-10.15	34.36	8.51	34.05	126	10	Average
5454	56.93	48.11	74	-17.07	34.36	8.51	34.05	126	10	Peak

REMARKS:

- Emission Level = Read Level + Antenna Factor + Cable Loss - Preamp Factor
Margin value = Emission level – Limit value
- 5220MHz: Fundamental frequency.



A D T

EUT TEST CONDITION		MEASUREMENT DETAIL	
CHANNEL	Channel 48	FREQUENCY RANGE	1GHz ~ 40GHz
INPUT POWER	120Vac, 60 Hz	DETECTOR FUNCTION	Peak (PK) Average (AV)
ENVIRONMENTAL CONDITIONS	25deg. C, 65%RH	TESTED BY	Karl Lee

ANTENNA POLARITY & TEST DISTANCE: HORIZONTAL AT 3 M										
FREQ. (MHz)	EMISSION LEVEL (dBuV/m)	READ LEVEL (dBuV)	LIMIT (dBuV/m)	MARGIN (dB)	ANTENNA FACTOR (dB/m)	CABLE LOSS (dB)	PREAMP FACTOR (dB)	ANTENNA HEIGHT (cm)	TABLE ANGLE (Degree)	REMARK
5126	43.24	35.02	54	-10.76	34.11	8.1	33.99	187	76	Average
5126	58.71	50.49	74	-15.29	34.11	8.1	33.99	187	76	Peak
5240	99.29	90.85			34.19	8.26	34.01	187	76	Average
5240	106.49	98.05			34.19	8.26	34.01	187	76	Peak
5450	44.15	35.33	54	-9.85	34.36	8.51	34.05	187	76	Average
5450	58.56	49.74	74	-15.44	34.36	8.51	34.05	187	76	Peak

ANTENNA POLARITY & TEST DISTANCE: VERTICAL AT 3 M										
FREQ. (MHz)	EMISSION LEVEL (dBuV/m)	READ LEVEL (dBuV)	LIMIT (dBuV/m)	MARGIN (dB)	ANTENNA FACTOR (dB/m)	CABLE LOSS (dB)	PREAMP FACTOR (dB)	ANTENNA HEIGHT (cm)	TABLE ANGLE (Degree)	REMARK
5054	42.74	34.68	54	-11.26	34.04	8	33.98	126	10	Average
5054	58.64	50.58	74	-15.36	34.04	8	33.98	126	10	Peak
5240	96.49	88.05			34.19	8.26	34.01	126	10	Average
5240	104.72	96.28			34.19	8.26	34.01	126	10	Peak
5390	43.58	34.9	54	-10.42	34.31	8.41	34.04	126	10	Average
5390	58.12	49.44	74	-15.88	34.31	8.41	34.04	126	10	Peak

REMARKS:

- Emission Level = Read Level + Antenna Factor + Cable Loss - Preamp Factor
Margin value = Emission level – Limit value
- 5240MHz: Fundamental frequency.



EUT TEST CONDITION		MEASUREMENT DETAIL	
CHANNEL	Channel 52	FREQUENCY RANGE	1GHz ~ 40GHz
INPUT POWER	120Vac, 60 Hz	DETECTOR FUNCTION	Peak (PK) Average (AV)
ENVIRONMENTAL CONDITIONS	25deg. C, 65%RH	TESTED BY	Karl Lee

ANTENNA POLARITY & TEST DISTANCE: HORIZONTAL AT 3 M										
FREQ. (MHz)	EMISSION LEVEL (dBuV/m)	READ LEVEL (dBuV)	LIMIT (dBuV/m)	MARGIN (dB)	ANTENNA FACTOR (dB/m)	CABLE LOSS (dB)	PREAMP FACTOR (dB)	ANTENNA HEIGHT (cm)	TABLE ANGLE (Degree)	REMARK
5124	42.44	34.22	54	-11.56	34.11	8.1	33.99	121	14	Average
5124	56.83	48.61	74	-17.17	34.11	8.1	33.99	121	14	Peak
5260	99.1	90.64			34.21	8.26	34.01	121	14	Average
5260	107.53	99.07			34.21	8.26	34.01	121	14	Peak
5438	43.07	34.28	54	-10.93	34.35	8.48	34.04	121	14	Average
5438	57.02	48.23	74	-16.98	34.35	8.48	34.04	121	14	Peak
ANTENNA POLARITY & TEST DISTANCE: VERTICAL AT 3 M										
FREQ. (MHz)	EMISSION LEVEL (dBuV/m)	READ LEVEL (dBuV)	LIMIT (dBuV/m)	MARGIN (dB)	ANTENNA FACTOR (dB/m)	CABLE LOSS (dB)	PREAMP FACTOR (dB)	ANTENNA HEIGHT (cm)	TABLE ANGLE (Degree)	REMARK
5126	42.45	34.23	54	-11.55	34.11	8.1	33.99	110	212	Average
5126	57.05	48.83	74	-16.95	34.11	8.1	33.99	110	212	Peak
5260	97.54	89.08			34.21	8.26	34.01	110	212	Average
5260	105.49	97.03			34.21	8.26	34.01	110	212	Peak
5420	42.65	33.88	54	-11.35	34.33	8.48	34.04	110	212	Average
5420	57.31	48.54	74	-16.69	34.33	8.48	34.04	110	212	Peak

REMARKS:

- Emission Level = Read Level + Antenna Factor + Cable Loss - Preamp Factor
Margin value = Emission level – Limit value
- 5260MHz: Fundamental frequency.



EUT TEST CONDITION		MEASUREMENT DETAIL	
CHANNEL	Channel 60	FREQUENCY RANGE	1GHz ~ 40GHz
INPUT POWER	120Vac, 60 Hz	DETECTOR FUNCTION	Peak (PK) Average (AV)
ENVIRONMENTAL CONDITIONS	25deg. C, 65%RH	TESTED BY	Karl Lee

ANTENNA POLARITY & TEST DISTANCE: HORIZONTAL AT 3 M										
FREQ. (MHz)	EMISSION LEVEL (dBuV/m)	READ LEVEL (dBuV)	LIMIT (dBuV/m)	MARGIN (dB)	ANTENNA FACTOR (dB/m)	CABLE LOSS (dB)	PREAMP FACTOR (dB)	ANTENNA HEIGHT (cm)	TABLE ANGLE (Degree)	REMARK
5114	44.31	36.11	54	-9.69	34.09	8.1	33.99	152	14	Average
5114	57.09	48.89	74	-16.91	34.09	8.1	33.99	152	14	Peak
5300	98.75	90.21			34.24	8.32	34.02	152	14	Average
5300	105.88	97.34			34.24	8.32	34.02	152	14	Peak
5412	47.86	39.13	54	-6.14	34.33	8.44	34.04	152	14	Average
5412	57.92	49.19	74	-16.08	34.33	8.44	34.04	152	14	Peak
ANTENNA POLARITY & TEST DISTANCE: VERTICAL AT 3 M										
FREQ. (MHz)	EMISSION LEVEL (dBuV/m)	READ LEVEL (dBuV)	LIMIT (dBuV/m)	MARGIN (dB)	ANTENNA FACTOR (dB/m)	CABLE LOSS (dB)	PREAMP FACTOR (dB)	ANTENNA HEIGHT (cm)	TABLE ANGLE (Degree)	REMARK
5080	42.26	34.14	54	-11.74	34.07	8.03	33.98	103	211	Average
5080	57.37	49.25	74	-16.63	34.07	8.03	33.98	103	211	Peak
5300	97.68	89.14			34.24	8.32	34.02	103	211	Average
5300	105.33	96.79			34.24	8.32	34.02	103	211	Peak
5426	45.14	36.37	54	-8.86	34.33	8.48	34.04	103	211	Average
5426	58.99	50.22	74	-15.01	34.33	8.48	34.04	103	211	Peak

REMARKS:

- Emission Level = Read Level + Antenna Factor + Cable Loss - Preamp Factor
Margin value = Emission level – Limit value
- 5300MHz: Fundamental frequency.



A D T

EUT TEST CONDITION		MEASUREMENT DETAIL	
CHANNEL	Channel 64	FREQUENCY RANGE	1GHz ~ 40GHz
INPUT POWER	120Vac, 60 Hz	DETECTOR FUNCTION	Peak (PK) Average (AV)
ENVIRONMENTAL CONDITIONS	25deg. C, 65%RH	TESTED BY	Karl Lee

ANTENNA POLARITY & TEST DISTANCE: HORIZONTAL AT 3 M										
FREQ. (MHz)	EMISSION LEVEL (dBuV/m)	READ LEVEL (dBuV)	LIMIT (dBuV/m)	MARGIN (dB)	ANTENNA FACTOR (dB/m)	CABLE LOSS (dB)	PREAMP FACTOR (dB)	ANTENNA HEIGHT (cm)	TABLE ANGLE (Degree)	REMARK
5100	42.51	34.35	54	-11.49	34.08	8.07	33.99	152	14	Average
5100	56.91	48.75	74	-17.09	34.08	8.07	33.99	152	14	Peak
5320	97.12	88.54			34.25	8.35	34.02	152	14	Average
5320	105.72	97.14			34.25	8.35	34.02	152	14	Peak
5350	48.94	40.31	54	-5.06	34.28	8.38	34.03	152	14	Average
5350	62.37	53.74	74	-11.63	34.28	8.38	34.03	152	14	Peak

ANTENNA POLARITY & TEST DISTANCE: VERTICAL AT 3 M										
FREQ. (MHz)	EMISSION LEVEL (dBuV/m)	READ LEVEL (dBuV)	LIMIT (dBuV/m)	MARGIN (dB)	ANTENNA FACTOR (dB/m)	CABLE LOSS (dB)	PREAMP FACTOR (dB)	ANTENNA HEIGHT (cm)	TABLE ANGLE (Degree)	REMARK
5134	42.52	34.27	54	-11.48	34.11	8.13	33.99	109	211	Average
5134	57.3	49.05	74	-16.7	34.11	8.13	33.99	109	211	Peak
5320	95.45	86.87			34.25	8.35	34.02	109	211	Average
5320	103.1	94.52			34.25	8.35	34.02	109	211	Peak
5350	47.64	39.01	54	-6.36	34.28	8.38	34.03	109	211	Average
5350	61.91	53.28	74	-12.09	34.28	8.38	34.03	109	211	Peak

REMARKS:

1. Emission Level = Read Level + Antenna Factor + Cable Loss - Preamp Factor
Margin value = Emission level – Limit value
2. 5320MHz: Fundamental frequency.

EUT TEST CONDITION		MEASUREMENT DETAIL	
CHANNEL	Channel 100	FREQUENCY RANGE	1GHz ~ 40GHz
INPUT POWER	120Vac, 60 Hz	DETECTOR FUNCTION	Peak (PK) Average (AV)
ENVIRONMENTAL CONDITIONS	25deg. C, 65%RH	TESTED BY	Karl Lee

ANTENNA POLARITY & TEST DISTANCE: HORIZONTAL AT 3 M										
FREQ. (MHz)	EMISSION LEVEL (dBuV/m)	READ LEVEL (dBuV)	LIMIT (dBuV/m)	MARGIN (dB)	ANTENNA FACTOR (dB/m)	CABLE LOSS (dB)	PREAMP FACTOR (dB)	ANTENNA HEIGHT (cm)	TABLE ANGLE (Degree)	REMARK
5458	45.3	36.48	54	-8.7	34.36	8.51	34.05	107	77	Average
5458	58.57	49.75	74	-15.43	34.36	8.51	34.05	107	77	Peak
5470	58.66	49.83	68.2	-9.54	34.37	8.51	34.05	107	77	Peak
5500	97.86	88.94			34.4	8.57	34.05	107	77	Average
5500	105.57	96.65			34.4	8.57	34.05	107	77	Peak
5725	57.23	48.07	68.2	-10.97	34.62	8.65	34.11	107	77	Peak
ANTENNA POLARITY & TEST DISTANCE: VERTICAL AT 3 M										
FREQ. (MHz)	EMISSION LEVEL (dBuV/m)	READ LEVEL (dBuV)	LIMIT (dBuV/m)	MARGIN (dB)	ANTENNA FACTOR (dB/m)	CABLE LOSS (dB)	PREAMP FACTOR (dB)	ANTENNA HEIGHT (cm)	TABLE ANGLE (Degree)	REMARK
5436	44.75	35.96	54	-9.25	34.35	8.48	34.04	194	91	Average
5436	58.8	50.01	74	-15.2	34.35	8.48	34.04	194	91	Peak
5470	59.36	50.53	68.2	-8.84	34.37	8.51	34.05	194	91	Peak
5500	96.05	87.13			34.4	8.57	34.05	194	91	Average
5500	103.95	95.03			34.4	8.57	34.05	194	91	Peak
5725	56.78	47.62	68.2	-11.42	34.62	8.65	34.11	194	91	Peak

REMARKS:

- Emission Level = Read Level + Antenna Factor + Cable Loss - Preamp Factor
Margin value = Emission level – Limit value
- 5500MHz: Fundamental frequency.
- 5470MHz & 5725MHz: Out of restricted band

EUT TEST CONDITION		MEASUREMENT DETAIL	
CHANNEL	Channel 116	FREQUENCY RANGE	1GHz ~ 40GHz
INPUT POWER	120Vac, 60 Hz	DETECTOR FUNCTION	Peak (PK) Average (AV)
ENVIRONMENTAL CONDITIONS	25deg. C, 65%RH	TESTED BY	Karl Lee

ANTENNA POLARITY & TEST DISTANCE: HORIZONTAL AT 3 M										
FREQ. (MHz)	EMISSION LEVEL (dBuV/m)	READ LEVEL (dBuV)	LIMIT (dBuV/m)	MARGIN (dB)	ANTENNA FACTOR (dB/m)	CABLE LOSS (dB)	PREAMP FACTOR (dB)	ANTENNA HEIGHT (cm)	TABLE ANGLE (Degree)	REMARK
5442	42.72	33.93	54	-11.28	34.35	8.48	34.04	109	75	Average
5442	57.46	48.67	74	-16.54	34.35	8.48	34.04	109	75	Peak
5470	55.1	46.27	68.2	-13.1	34.37	8.51	34.05	109	75	Peak
5580	98.87	89.88			34.47	8.6	34.08	109	75	Average
5580	106.83	97.84			34.47	8.6	34.08	109	75	Peak
5725	54.16	45	68.2	-14.04	34.62	8.65	34.11	109	75	Peak
ANTENNA POLARITY & TEST DISTANCE: VERTICAL AT 3 M										
FREQ. (MHz)	EMISSION LEVEL (dBuV/m)	READ LEVEL (dBuV)	LIMIT (dBuV/m)	MARGIN (dB)	ANTENNA FACTOR (dB/m)	CABLE LOSS (dB)	PREAMP FACTOR (dB)	ANTENNA HEIGHT (cm)	TABLE ANGLE (Degree)	REMARK
5456	42.87	34.05	54	-11.13	34.36	8.51	34.05	194	91	Average
5456	56.82	48	74	-17.18	34.36	8.51	34.05	194	91	Peak
5470	55.47	46.64	68.2	-12.73	34.37	8.51	34.05	194	91	Peak
5580	96.67	87.68			34.47	8.6	34.08	194	91	Average
5580	104.85	95.86			34.47	8.6	34.08	194	91	Peak
5725	54.53	45.37	68.2	-13.67	34.62	8.65	34.11	194	91	Peak

REMARKS:

- Emission Level = Read Level + Antenna Factor + Cable Loss - Preamp Factor
Margin value = Emission level – Limit value
- 5580MHz: Fundamental frequency.
- 5470MHz & 5725MHz: Out of restricted band

EUT TEST CONDITION		MEASUREMENT DETAIL	
CHANNEL	Channel 140	FREQUENCY RANGE	1GHz ~ 40GHz
INPUT POWER	120Vac, 60 Hz	DETECTOR FUNCTION	Peak (PK) Average (AV)
ENVIRONMENTAL CONDITIONS	25deg. C, 65%RH	TESTED BY	Karl Lee

ANTENNA POLARITY & TEST DISTANCE: HORIZONTAL AT 3 M										
FREQ. (MHz)	EMISSION LEVEL (dBuV/m)	READ LEVEL (dBuV)	LIMIT (dBuV/m)	MARGIN (dB)	ANTENNA FACTOR (dB/m)	CABLE LOSS (dB)	PREAMP FACTOR (dB)	ANTENNA HEIGHT (cm)	TABLE ANGLE (Degree)	REMARK
5356	42.46	33.83	54	-11.54	34.28	8.38	34.03	119	38	Average
5356	57.26	48.63	74	-16.74	34.28	8.38	34.03	119	38	Peak
5470	55.93	47.1	68.2	-12.27	34.37	8.51	34.05	119	38	Peak
5700	95.93	86.8			34.59	8.64	34.1	119	38	Average
5700	103.52	94.39			34.59	8.64	34.1	119	38	Peak
5725	57.16	48	68.2	-11.04	34.62	8.65	34.11	119	38	Peak
ANTENNA POLARITY & TEST DISTANCE: VERTICAL AT 3 M										
FREQ. (MHz)	EMISSION LEVEL (dBuV/m)	READ LEVEL (dBuV)	LIMIT (dBuV/m)	MARGIN (dB)	ANTENNA FACTOR (dB/m)	CABLE LOSS (dB)	PREAMP FACTOR (dB)	ANTENNA HEIGHT (cm)	TABLE ANGLE (Degree)	REMARK
5460	42.77	33.95	54	-11.23	34.36	8.51	34.05	190	91	Average
5460	58.02	49.2	74	-15.98	34.36	8.51	34.05	190	91	Peak
5470	56.26	47.43	68.2	-11.94	34.37	8.51	34.05	190	91	Peak
5700	93.33	84.2			34.59	8.64	34.1	190	91	Average
5700	101.36	92.23			34.59	8.64	34.1	190	91	Peak
5725	57.68	48.52	68.2	-10.52	34.62	8.65	34.11	190	91	Peak

REMARKS:

- Emission Level = Read Level + Antenna Factor + Cable Loss - Preamp Factor
Margin value = Emission level – Limit value
- 5700MHz: Fundamental frequency.
- 5470MHz & 5725MHz: Out of restricted band

EUT TEST CONDITION		MEASUREMENT DETAIL	
CHANNEL	Channel 149	FREQUENCY RANGE	1GHz ~ 40GHz
INPUT POWER	120Vac, 60 Hz	DETECTOR FUNCTION	Peak (PK) Average (AV)
ENVIRONMENTAL CONDITIONS	25deg. C, 65%RH	TESTED BY	Karl Lee

ANTENNA POLARITY & TEST DISTANCE: HORIZONTAL AT 3 M										
FREQ. (MHz)	EMISSION LEVEL (dBuV/m)	READ LEVEL (dBuV)	LIMIT (dBuV/m)	MARGIN (dB)	ANTENNA FACTOR (dB/m)	CABLE LOSS (dB)	PREAMP FACTOR (dB)	ANTENNA HEIGHT (cm)	TABLE ANGLE (Degree)	REMARK
*5714	64.23	55.08	68.2	-3.97	34.61	8.65	34.11	148	167	Peak
*5724	72.18	63.02	78.2	-6.02	34.62	8.65	34.11	148	167	Peak
5745	99	89.81			34.64	8.66	34.11	148	167	Average
5745	106.12	96.93			34.64	8.66	34.11	148	167	Peak
*5854	58.01	48.69	78.2	-20.19	34.76	8.7	34.14	148	167	Peak
*5868	57.42	48.09	68.2	-10.78	34.76	8.71	34.14	148	167	Peak
ANTENNA POLARITY & TEST DISTANCE: VERTICAL AT 3 M										
FREQ. (MHz)	EMISSION LEVEL (dBuV/m)	READ LEVEL (dBuV)	LIMIT (dBuV/m)	MARGIN (dB)	ANTENNA FACTOR (dB/m)	CABLE LOSS (dB)	PREAMP FACTOR (dB)	ANTENNA HEIGHT (cm)	TABLE ANGLE (Degree)	REMARK
*5714	61.46	52.31	68.2	-6.74	34.61	8.65	34.11	101	168	Peak
*5722	70.1	60.94	78.2	-8.1	34.62	8.65	34.11	101	168	Peak
5745	96.64	87.45			34.64	8.66	34.11	101	168	Average
5745	104.03	94.84			34.64	8.66	34.11	101	168	Peak
*5858	56.85	47.53	78.2	-21.35	34.76	8.7	34.14	101	168	Peak
*5866	56.51	47.18	68.2	-11.69	34.76	8.71	34.14	101	168	Peak

REMARKS:

- Emission Level = Read Level + Antenna Factor + Cable Loss - Preamp Factor
Margin value = Emission level – Limit value
- 5745MHz: Fundamental frequency.
- *: Out of restricted band

EUT TEST CONDITION		MEASUREMENT DETAIL	
CHANNEL	Channel 157	FREQUENCY RANGE	1GHz ~ 40GHz
INPUT POWER	120Vac, 60 Hz	DETECTOR FUNCTION	Peak (PK) Average (AV)
ENVIRONMENTAL CONDITIONS	25deg. C, 65%RH	TESTED BY	Karl Lee

ANTENNA POLARITY & TEST DISTANCE: HORIZONTAL AT 3 M										
FREQ. (MHz)	EMISSION LEVEL (dBuV/m)	READ LEVEL (dBuV)	LIMIT (dBuV/m)	MARGIN (dB)	ANTENNA FACTOR (dB/m)	CABLE LOSS (dB)	PREAMP FACTOR (dB)	ANTENNA HEIGHT (cm)	TABLE ANGLE (Degree)	REMARK
*5714	57.66	48.51	68.2	-10.54	34.61	8.65	34.11	160	167	Peak
*5722	59.31	50.15	78.2	-18.89	34.62	8.65	34.11	160	167	Peak
5785	101.94	92.71			34.68	8.68	34.13	160	167	Average
5785	109.89	100.66			34.68	8.68	34.13	160	167	Peak
*5854	58.75	49.43	78.2	-19.45	34.76	8.7	34.14	160	167	Peak
*5866	58.82	49.49	68.2	-9.38	34.76	8.71	34.14	160	167	Peak
ANTENNA POLARITY & TEST DISTANCE: VERTICAL AT 3 M										
FREQ. (MHz)	EMISSION LEVEL (dBuV/m)	READ LEVEL (dBuV)	LIMIT (dBuV/m)	MARGIN (dB)	ANTENNA FACTOR (dB/m)	CABLE LOSS (dB)	PREAMP FACTOR (dB)	ANTENNA HEIGHT (cm)	TABLE ANGLE (Degree)	REMARK
*5706	58.24	49.09	68.2	-9.96	34.61	8.65	34.11	100	169	Peak
*5724	58.47	49.31	78.2	-19.73	34.62	8.65	34.11	100	169	Peak
5785	99.33	90.1			34.68	8.68	34.13	100	169	Average
5785	107.32	98.09			34.68	8.68	34.13	100	169	Peak
*5858	57.72	48.4	78.2	-20.48	34.76	8.7	34.14	100	169	Peak
*5870	58.16	48.83	68.2	-10.04	34.76	8.71	34.14	100	169	Peak

REMARKS:

- Emission Level = Read Level + Antenna Factor + Cable Loss - Preamp Factor
Margin value = Emission level – Limit value
- 5785MHz: Fundamental frequency.
- *: Out of restricted band



EUT TEST CONDITION		MEASUREMENT DETAIL	
CHANNEL	Channel 165	FREQUENCY RANGE	1GHz ~ 40GHz
INPUT POWER	120Vac, 60 Hz	DETECTOR FUNCTION	Peak (PK) Average (AV)
ENVIRONMENTAL CONDITIONS	25deg. C, 65%RH	TESTED BY	Karl Lee

ANTENNA POLARITY & TEST DISTANCE: HORIZONTAL AT 3 M										
FREQ. (MHz)	EMISSION LEVEL (dBuV/m)	READ LEVEL (dBuV)	LIMIT (dBuV/m)	MARGIN (dB)	ANTENNA FACTOR (dB/m)	CABLE LOSS (dB)	PREAMP FACTOR (dB)	ANTENNA HEIGHT (cm)	TABLE ANGLE (Degree)	REMARK
*5714	58.7	49.55	68.2	-9.5	34.61	8.65	34.11	160	167	Peak
*5722	58.18	49.02	78.2	-20.02	34.62	8.65	34.11	160	167	Peak
5825	100.16	90.87			34.73	8.69	34.13	160	167	Average
5825	107.34	98.05			34.73	8.69	34.13	160	167	Peak
*5852	72.92	63.62	78.2	-5.28	34.74	8.7	34.14	160	167	Peak
*5862	66.89	57.56	68.2	-1.31	34.76	8.71	34.14	160	167	Peak
ANTENNA POLARITY & TEST DISTANCE: VERTICAL AT 3 M										
FREQ. (MHz)	EMISSION LEVEL (dBuV/m)	READ LEVEL (dBuV)	LIMIT (dBuV/m)	MARGIN (dB)	ANTENNA FACTOR (dB/m)	CABLE LOSS (dB)	PREAMP FACTOR (dB)	ANTENNA HEIGHT (cm)	TABLE ANGLE (Degree)	REMARK
*5710	57.87	48.72	68.2	-10.33	34.61	8.65	34.11	100	165	Peak
*5724	57.69	48.53	78.2	-20.51	34.62	8.65	34.11	100	165	Peak
5825	98.03	88.74			34.73	8.69	34.13	100	165	Average
5825	105.33	96.04			34.73	8.69	34.13	100	165	Peak
*5852	67.05	57.75	78.2	-11.15	34.74	8.7	34.14	100	165	Peak
*5862	61.82	52.49	68.2	-6.38	34.76	8.71	34.14	100	165	Peak

REMARKS:

- Emission Level = Read Level + Antenna Factor + Cable Loss - Preamp Factor
Margin value = Emission level – Limit value
- 5825MHz: Fundamental frequency.
- *: Out of restricted band

802.11n (40MHz)

EUT TEST CONDITION		MEASUREMENT DETAIL	
CHANNEL	Channel 38	FREQUENCY RANGE	1GHz ~ 40GHz
INPUT POWER	120Vac, 60 Hz	DETECTOR FUNCTION	Peak (PK) Average (AV)
ENVIRONMENTAL CONDITIONS	25deg. C, 65%RH	TESTED BY	Karl Lee

ANTENNA POLARITY & TEST DISTANCE: HORIZONTAL AT 3 M

FREQ. (MHz)	EMISSION LEVEL (dBuV/m)	READ LEVEL (dBuV)	LIMIT (dBuV/m)	MARGIN (dB)	ANTENNA FACTOR (dB/m)	CABLE LOSS (dB)	PREAMP FACTOR (dB)	ANTENNA HEIGHT (cm)	TABLE ANGLE (Degree)	REMARK
5150	49.68	41.43	54	-4.32	34.12	8.13	34	187	76	Average
5150	61.32	53.07	74	-12.68	34.12	8.13	34	187	76	Peak
5190	92.31	83.97			34.15	8.19	34	187	76	Average
5190	99.4	91.06			34.15	8.19	34	187	76	Peak
5394	43.57	34.86	54	-10.43	34.31	8.44	34.04	187	76	Average
5394	57.37	48.66	74	-16.63	34.31	8.44	34.04	187	76	Peak

ANTENNA POLARITY & TEST DISTANCE: VERTICAL AT 3 M

FREQ. (MHz)	EMISSION LEVEL (dBuV/m)	READ LEVEL (dBuV)	LIMIT (dBuV/m)	MARGIN (dB)	ANTENNA FACTOR (dB/m)	CABLE LOSS (dB)	PREAMP FACTOR (dB)	ANTENNA HEIGHT (cm)	TABLE ANGLE (Degree)	REMARK
5150	47.94	39.69	54	-6.06	34.12	8.13	34	120	10	Average
5150	59.5	51.25	74	-14.5	34.12	8.13	34	120	10	Peak
5190	89.13	80.79			34.15	8.19	34	120	10	Average
5190	97.23	88.89			34.15	8.19	34	120	10	Peak
5396	43.59	34.87	54	-10.41	34.32	8.44	34.04	120	10	Average
5396	56.93	48.21	74	-17.07	34.32	8.44	34.04	120	10	Peak

REMARKS:

- Emission Level = Read Level + Antenna Factor + Cable Loss - Preamp Factor
Margin value = Emission level – Limit value
- 5190MHz: Fundamental frequency.



EUT TEST CONDITION		MEASUREMENT DETAIL	
CHANNEL	Channel 46	FREQUENCY RANGE	1GHz ~ 40GHz
INPUT POWER	120Vac, 60 Hz	DETECTOR FUNCTION	Peak (PK) Average (AV)
ENVIRONMENTAL CONDITIONS	25deg. C, 65%RH	TESTED BY	Karl Lee

ANTENNA POLARITY & TEST DISTANCE: HORIZONTAL AT 3 M										
FREQ. (MHz)	EMISSION LEVEL (dBuV/m)	READ LEVEL (dBuV)	LIMIT (dBuV/m)	MARGIN (dB)	ANTENNA FACTOR (dB/m)	CABLE LOSS (dB)	PREAMP FACTOR (dB)	ANTENNA HEIGHT (cm)	TABLE ANGLE (Degree)	REMARK
5134	44.75	36.5	54	-9.25	34.11	8.13	33.99	151	112	Average
5134	57.08	48.83	74	-16.92	34.11	8.13	33.99	151	112	Peak
5230	95.45	87.05			34.19	8.22	34.01	151	112	Average
5230	102.75	94.35			34.19	8.22	34.01	151	112	Peak
5440	43.6	34.81	54	-10.4	34.35	8.48	34.04	151	112	Average
5440	57.73	48.94	74	-16.27	34.35	8.48	34.04	151	112	Peak
ANTENNA POLARITY & TEST DISTANCE: VERTICAL AT 3 M										
FREQ. (MHz)	EMISSION LEVEL (dBuV/m)	READ LEVEL (dBuV)	LIMIT (dBuV/m)	MARGIN (dB)	ANTENNA FACTOR (dB/m)	CABLE LOSS (dB)	PREAMP FACTOR (dB)	ANTENNA HEIGHT (cm)	TABLE ANGLE (Degree)	REMARK
5080	44.14	36.02	54	-9.86	34.07	8.03	33.98	212	335	Average
5080	56.87	48.75	74	-17.13	34.07	8.03	33.98	212	335	Peak
5230	92.96	84.56			34.19	8.22	34.01	212	335	Average
5230	100.28	91.88			34.19	8.22	34.01	212	335	Peak
5458	43.43	34.61	54	-10.57	34.36	8.51	34.05	212	335	Average
5458	58.26	49.44	74	-15.74	34.36	8.51	34.05	212	335	Peak

REMARKS:

- Emission Level = Read Level + Antenna Factor + Cable Loss - Preamp Factor
Margin value = Emission level – Limit value
- 5230MHz: Fundamental frequency.

EUT TEST CONDITION		MEASUREMENT DETAIL	
CHANNEL	Channel 54	FREQUENCY RANGE	1GHz ~ 40GHz
INPUT POWER	120Vac, 60 Hz	DETECTOR FUNCTION	Peak (PK) Average (AV)
ENVIRONMENTAL CONDITIONS	25deg. C, 65%RH	TESTED BY	Karl Lee

ANTENNA POLARITY & TEST DISTANCE: HORIZONTAL AT 3 M										
FREQ. (MHz)	EMISSION LEVEL (dBuV/m)	READ LEVEL (dBuV)	LIMIT (dBuV/m)	MARGIN (dB)	ANTENNA FACTOR (dB/m)	CABLE LOSS (dB)	PREAMP FACTOR (dB)	ANTENNA HEIGHT (cm)	TABLE ANGLE (Degree)	REMARK
5114	42.73	34.53	54	-11.27	34.09	8.1	33.99	121	14	Average
5114	57.12	48.92	74	-16.88	34.09	8.1	33.99	121	14	Peak
5270	94.49	86			34.21	8.29	34.01	121	14	Average
5270	102.7	94.21			34.21	8.29	34.01	121	14	Peak
5354	45.14	36.51	54	-8.86	34.28	8.38	34.03	121	14	Average
5354	58.7	50.07	74	-15.3	34.28	8.38	34.03	121	14	Peak
ANTENNA POLARITY & TEST DISTANCE: VERTICAL AT 3 M										
FREQ. (MHz)	EMISSION LEVEL (dBuV/m)	READ LEVEL (dBuV)	LIMIT (dBuV/m)	MARGIN (dB)	ANTENNA FACTOR (dB/m)	CABLE LOSS (dB)	PREAMP FACTOR (dB)	ANTENNA HEIGHT (cm)	TABLE ANGLE (Degree)	REMARK
5084	42.8	34.64	54	-11.2	34.07	8.07	33.98	110	212	Average
5084	56.42	48.26	74	-17.58	34.07	8.07	33.98	110	212	Peak
5270	92.29	83.8			34.21	8.29	34.01	110	212	Average
5270	100.81	92.32			34.21	8.29	34.01	110	212	Peak
5448	44.3	35.47	54	-9.7	34.36	8.51	34.04	110	212	Average
5448	58.26	49.43	74	-15.74	34.36	8.51	34.04	110	212	Peak

REMARKS:

- Emission Level = Read Level + Antenna Factor + Cable Loss - Preamp Factor
Margin value = Emission level – Limit value
- 5270MHz: Fundamental frequency.



A D T

EUT TEST CONDITION		MEASUREMENT DETAIL	
CHANNEL	Channel 62	FREQUENCY RANGE	1GHz ~ 40GHz
INPUT POWER	120Vac, 60 Hz	DETECTOR FUNCTION	Peak (PK) Average (AV)
ENVIRONMENTAL CONDITIONS	25deg. C, 65%RH	TESTED BY	Karl Lee

ANTENNA POLARITY & TEST DISTANCE: HORIZONTAL AT 3 M										
FREQ. (MHz)	EMISSION LEVEL (dBuV/m)	READ LEVEL (dBuV)	LIMIT (dBuV/m)	MARGIN (dB)	ANTENNA FACTOR (dB/m)	CABLE LOSS (dB)	PREAMP FACTOR (dB)	ANTENNA HEIGHT (cm)	TABLE ANGLE (Degree)	REMARK
5080	42.88	34.76	54	-11.12	34.07	8.03	33.98	152	14	Average
5080	57.46	49.34	74	-16.54	34.07	8.03	33.98	152	14	Peak
5310	92.16	83.61			34.25	8.32	34.02	152	14	Average
5310	100.16	91.61			34.25	8.32	34.02	152	14	Peak
5350	48.89	40.26	54	-5.11	34.28	8.38	34.03	152	14	Average
5350	62.34	53.71	74	-11.66	34.28	8.38	34.03	152	14	Peak

ANTENNA POLARITY & TEST DISTANCE: VERTICAL AT 3 M										
FREQ. (MHz)	EMISSION LEVEL (dBuV/m)	READ LEVEL (dBuV)	LIMIT (dBuV/m)	MARGIN (dB)	ANTENNA FACTOR (dB/m)	CABLE LOSS (dB)	PREAMP FACTOR (dB)	ANTENNA HEIGHT (cm)	TABLE ANGLE (Degree)	REMARK
5100	42.72	34.56	54	-11.28	34.08	8.07	33.99	103	211	Average
5100	56.73	48.57	74	-17.27	34.08	8.07	33.99	103	211	Peak
5310	90.88	82.33			34.25	8.32	34.02	103	211	Average
5310	98.65	90.1			34.25	8.32	34.02	103	211	Peak
5354	47.66	39.03	54	-6.34	34.28	8.38	34.03	103	211	Average
5354	58.06	49.43	74	-15.94	34.28	8.38	34.03	103	211	Peak

REMARKS:

- Emission Level = Read Level + Antenna Factor + Cable Loss - Preamp Factor
Margin value = Emission level – Limit value
- 5310MHz: Fundamental frequency.



A D T

EUT TEST CONDITION		MEASUREMENT DETAIL	
CHANNEL	Channel 102	FREQUENCY RANGE	1GHz ~ 40GHz
INPUT POWER	120Vac, 60 Hz	DETECTOR FUNCTION	Peak (PK) Average (AV)
ENVIRONMENTAL CONDITIONS	25deg. C, 65%RH	TESTED BY	Karl Lee

ANTENNA POLARITY & TEST DISTANCE: HORIZONTAL AT 3 M										
FREQ. (MHz)	EMISSION LEVEL (dBuV/m)	READ LEVEL (dBuV)	LIMIT (dBuV/m)	MARGIN (dB)	ANTENNA FACTOR (dB/m)	CABLE LOSS (dB)	PREAMP FACTOR (dB)	ANTENNA HEIGHT (cm)	TABLE ANGLE (Degree)	REMARK
5460	45.04	36.22	54	-8.96	34.36	8.51	34.05	107	77	Average
5460	59.27	50.45	74	-14.73	34.36	8.51	34.05	107	77	Peak
5470	61.7	52.87	68.2	-6.5	34.37	8.51	34.05	107	77	Peak
5510	90.37	81.46			34.4	8.57	34.06	107	77	Average
5510	98.29	89.38			34.4	8.57	34.06	107	77	Peak
5725	56.56	47.4	68.2	-11.64	34.62	8.65	34.11	107	77	Peak
ANTENNA POLARITY & TEST DISTANCE: VERTICAL AT 3 M										
FREQ. (MHz)	EMISSION LEVEL (dBuV/m)	READ LEVEL (dBuV)	LIMIT (dBuV/m)	MARGIN (dB)	ANTENNA FACTOR (dB/m)	CABLE LOSS (dB)	PREAMP FACTOR (dB)	ANTENNA HEIGHT (cm)	TABLE ANGLE (Degree)	REMARK
5378	44.37	35.69	54	-9.63	34.31	8.41	34.04	175	91	Average
5378	57.31	48.63	74	-16.69	34.31	8.41	34.04	175	91	Peak
5470	58.03	49.2	68.2	-10.17	34.37	8.51	34.05	175	91	Peak
5510	89.02	80.11			34.4	8.57	34.06	175	91	Average
5510	96.52	87.61			34.4	8.57	34.06	175	91	Peak
5725	55.17	46.01	68.2	-13.03	34.62	8.65	34.11	175	91	Peak

REMARKS:

- Emission Level = Read Level + Antenna Factor + Cable Loss - Preamp Factor
Margin value = Emission level – Limit value
- 5510MHz: Fundamental frequency.
- 5470MHz & 5725MHz: Out of restricted band

EUT TEST CONDITION		MEASUREMENT DETAIL	
CHANNEL	Channel 110	FREQUENCY RANGE	1GHz ~ 40GHz
INPUT POWER	120Vac, 60 Hz	DETECTOR FUNCTION	Peak (PK) Average (AV)
ENVIRONMENTAL CONDITIONS	25deg. C, 65%RH	TESTED BY	Karl Lee

ANTENNA POLARITY & TEST DISTANCE: HORIZONTAL AT 3 M										
FREQ. (MHz)	EMISSION LEVEL (dBuV/m)	READ LEVEL (dBuV)	LIMIT (dBuV/m)	MARGIN (dB)	ANTENNA FACTOR (dB/m)	CABLE LOSS (dB)	PREAMP FACTOR (dB)	ANTENNA HEIGHT (cm)	TABLE ANGLE (Degree)	REMARK
5446	44.77	35.94	54	-9.23	34.36	8.51	34.04	111	75	Average
5446	57.62	48.79	74	-16.38	34.36	8.51	34.04	111	75	Peak
5470	61	52.17	68.2	-7.2	34.37	8.51	34.05	111	75	Peak
5550	96.34	87.37			34.45	8.59	34.07	111	75	Average
5550	104.28	95.31			34.45	8.59	34.07	111	75	Peak
5725	54.99	45.83	68.2	-13.21	34.62	8.65	34.11	111	75	Peak
ANTENNA POLARITY & TEST DISTANCE: VERTICAL AT 3 M										
FREQ. (MHz)	EMISSION LEVEL (dBuV/m)	READ LEVEL (dBuV)	LIMIT (dBuV/m)	MARGIN (dB)	ANTENNA FACTOR (dB/m)	CABLE LOSS (dB)	PREAMP FACTOR (dB)	ANTENNA HEIGHT (cm)	TABLE ANGLE (Degree)	REMARK
5430	44.52	35.73	54	-9.48	34.35	8.48	34.04	194	91	Average
5430	57.2	48.41	74	-16.8	34.35	8.48	34.04	194	91	Peak
5470	56.35	47.52	68.2	-11.85	34.37	8.51	34.05	194	91	Peak
5550	94.34	85.37			34.45	8.59	34.07	194	91	Average
5550	102.01	93.04			34.45	8.59	34.07	194	91	Peak
5725	54.5	45.34	68.2	-13.7	34.62	8.65	34.11	194	91	Peak

REMARKS:

- Emission Level = Read Level + Antenna Factor + Cable Loss - Preamp Factor
Margin value = Emission level – Limit value
- 5550MHz: Fundamental frequency.
- 5470MHz & 5725MHz: Out of restricted band

EUT TEST CONDITION		MEASUREMENT DETAIL	
CHANNEL	Channel 134	FREQUENCY RANGE	1GHz ~ 40GHz
INPUT POWER	120Vac, 60 Hz	DETECTOR FUNCTION	Peak (PK) Average (AV)
ENVIRONMENTAL CONDITIONS	25deg. C, 65%RH	TESTED BY	Karl Lee

ANTENNA POLARITY & TEST DISTANCE: HORIZONTAL AT 3 M										
FREQ. (MHz)	EMISSION LEVEL (dBuV/m)	READ LEVEL (dBuV)	LIMIT (dBuV/m)	MARGIN (dB)	ANTENNA FACTOR (dB/m)	CABLE LOSS (dB)	PREAMP FACTOR (dB)	ANTENNA HEIGHT (cm)	TABLE ANGLE (Degree)	REMARK
5440	42.92	34.13	54	-11.08	34.35	8.48	34.04	200	40	Average
5440	57.95	49.16	74	-16.05	34.35	8.48	34.04	200	40	Peak
5470	56.94	48.11	68.2	-11.26	34.37	8.51	34.05	200	40	Peak
5670	94.1	85			34.57	8.63	34.1	200	40	Average
5670	102.64	93.54			34.57	8.63	34.1	200	40	Peak
5725	63.18	54.02	68.2	-5.02	34.62	8.65	34.11	200	40	Peak
ANTENNA POLARITY & TEST DISTANCE: VERTICAL AT 3 M										
FREQ. (MHz)	EMISSION LEVEL (dBuV/m)	READ LEVEL (dBuV)	LIMIT (dBuV/m)	MARGIN (dB)	ANTENNA FACTOR (dB/m)	CABLE LOSS (dB)	PREAMP FACTOR (dB)	ANTENNA HEIGHT (cm)	TABLE ANGLE (Degree)	REMARK
5446	42.97	34.14	54	-11.03	34.36	8.51	34.04	223	91	Average
5446	56.54	47.71	74	-17.46	34.36	8.51	34.04	223	91	Peak
5470	55.86	47.03	68.2	-12.34	34.37	8.51	34.05	223	91	Peak
5670	92.7	83.6			34.57	8.63	34.1	223	91	Average
5670	100.75	91.65			34.57	8.63	34.1	223	91	Peak
5725	61.85	52.69	68.2	-6.35	34.62	8.65	34.11	223	91	Peak

REMARKS:

- Emission Level = Read Level + Antenna Factor + Cable Loss - Preamp Factor
Margin value = Emission level – Limit value
- 5670MHz: Fundamental frequency.
- 5470MHz & 5725MHz: Out of restricted band

EUT TEST CONDITION		MEASUREMENT DETAIL	
CHANNEL	Channel 151	FREQUENCY RANGE	1GHz ~ 40GHz
INPUT POWER	120Vac, 60 Hz	DETECTOR FUNCTION	Peak (PK) Average (AV)
ENVIRONMENTAL CONDITIONS	25deg. C, 65%RH	TESTED BY	Karl Lee

ANTENNA POLARITY & TEST DISTANCE: HORIZONTAL AT 3 M										
FREQ. (MHz)	EMISSION LEVEL (dBuV/m)	READ LEVEL (dBuV)	LIMIT (dBuV/m)	MARGIN (dB)	ANTENNA FACTOR (dB/m)	CABLE LOSS (dB)	PREAMP FACTOR (dB)	ANTENNA HEIGHT (cm)	TABLE ANGLE (Degree)	REMARK
*5714	63.5	54.35	68.2	-4.7	34.61	8.65	34.11	148	167	Peak
*5722	65.58	56.42	78.2	-12.62	34.62	8.65	34.11	148	167	Peak
5755	93.81	84.6			34.66	8.66	34.11	148	167	Average
5755	101.1	91.89			34.66	8.66	34.11	148	167	Peak
*5856	58.15	48.83	78.2	-20.05	34.76	8.7	34.14	148	167	Peak
*5870	58.85	49.52	68.2	-9.35	34.76	8.71	34.14	148	167	Peak
ANTENNA POLARITY & TEST DISTANCE: VERTICAL AT 3 M										
FREQ. (MHz)	EMISSION LEVEL (dBuV/m)	READ LEVEL (dBuV)	LIMIT (dBuV/m)	MARGIN (dB)	ANTENNA FACTOR (dB/m)	CABLE LOSS (dB)	PREAMP FACTOR (dB)	ANTENNA HEIGHT (cm)	TABLE ANGLE (Degree)	REMARK
*5712	61.25	52.1	68.2	-6.95	34.61	8.65	34.11	101	168	Peak
*5724	61.27	52.11	78.2	-16.93	34.62	8.65	34.11	101	168	Peak
5755	91.93	82.72			34.66	8.66	34.11	101	168	Average
5755	99.85	90.64			34.66	8.66	34.11	101	168	Peak
*5856	57.88	48.56	78.2	-20.32	34.76	8.7	34.14	101	168	Peak
*5864	57.85	48.52	68.2	-10.35	34.76	8.71	34.14	101	168	Peak

REMARKS:

- Emission Level = Read Level + Antenna Factor + Cable Loss - Preamp Factor
Margin value = Emission level – Limit value
- 5755MHz: Fundamental frequency.
- *: Out of restricted band

EUT TEST CONDITION		MEASUREMENT DETAIL	
CHANNEL	Channel 159	FREQUENCY RANGE	1GHz ~ 40GHz
INPUT POWER	120Vac, 60 Hz	DETECTOR FUNCTION	Peak (PK) Average (AV)
ENVIRONMENTAL CONDITIONS	25deg. C, 65%RH	TESTED BY	Karl Lee

ANTENNA POLARITY & TEST DISTANCE: HORIZONTAL AT 3 M										
FREQ. (MHz)	EMISSION LEVEL (dBuV/m)	READ LEVEL (dBuV)	LIMIT (dBuV/m)	MARGIN (dB)	ANTENNA FACTOR (dB/m)	CABLE LOSS (dB)	PREAMP FACTOR (dB)	ANTENNA HEIGHT (cm)	TABLE ANGLE (Degree)	REMARK
*5712	57.29	48.14	68.2	-10.91	34.61	8.65	34.11	182	39	Peak
*5722	58.9	49.74	78.2	-19.3	34.62	8.65	34.11	182	39	Peak
5795	94.76	85.52			34.69	8.68	34.13	182	39	Average
5795	102.57	93.33			34.69	8.68	34.13	182	39	Peak
*5852	60.05	50.75	78.2	-18.15	34.74	8.7	34.14	182	39	Peak
*5862	59.12	49.79	68.2	-9.08	34.76	8.71	34.14	182	39	Peak
ANTENNA POLARITY & TEST DISTANCE: VERTICAL AT 3 M										
FREQ. (MHz)	EMISSION LEVEL (dBuV/m)	READ LEVEL (dBuV)	LIMIT (dBuV/m)	MARGIN (dB)	ANTENNA FACTOR (dB/m)	CABLE LOSS (dB)	PREAMP FACTOR (dB)	ANTENNA HEIGHT (cm)	TABLE ANGLE (Degree)	REMARK
*5714	56.9	47.75	68.2	-11.3	34.61	8.65	34.11	144	168	Peak
*5720	56.55	47.39	78.2	-21.65	34.62	8.65	34.11	144	168	Peak
5795	92.37	83.13			34.69	8.68	34.13	144	168	Average
5795	100.16	90.92			34.69	8.68	34.13	144	168	Peak
*5858	56.7	47.38	78.2	-21.5	34.76	8.7	34.14	144	168	Peak
*5866	57.12	47.79	68.2	-11.08	34.76	8.71	34.14	144	168	Peak

REMARKS:

- Emission Level = Read Level + Antenna Factor + Cable Loss - Preamp Factor
Margin value = Emission level – Limit value
- 5795MHz: Fundamental frequency.
- *: Out of restricted band

802.11ac (80MHz)

EUT TEST CONDITION		MEASUREMENT DETAIL	
CHANNEL	Channel 42	FREQUENCY RANGE	1GHz ~ 40GHz
INPUT POWER	120Vac, 60 Hz	DETECTOR FUNCTION	Peak (PK) Average (AV)
ENVIRONMENTAL CONDITIONS	25deg. C, 65%RH	TESTED BY	Karl Lee

ANTENNA POLARITY & TEST DISTANCE: HORIZONTAL AT 3 M

FREQ. (MHz)	EMISSION LEVEL (dBuV/m)	READ LEVEL (dBuV)	LIMIT (dBuV/m)	MARGIN (dB)	ANTENNA FACTOR (dB/m)	CABLE LOSS (dB)	PREAMP FACTOR (dB)	ANTENNA HEIGHT (cm)	TABLE ANGLE (Degree)	REMARK
5150	50.05	41.8	54	-3.95	34.12	8.13	34	187	76	Average
5150	61.58	53.33	74	-12.42	34.12	8.13	34	187	76	Peak
5210	90.72	82.36			34.17	8.19	34	187	76	Average
5210	97.9	89.54			34.17	8.19	34	187	76	Peak
5354	44.58	35.95	54	-9.42	34.28	8.38	34.03	187	76	Average
5354	59.21	50.58	74	-14.79	34.28	8.38	34.03	187	76	Peak

ANTENNA POLARITY & TEST DISTANCE: VERTICAL AT 3 M

FREQ. (MHz)	EMISSION LEVEL (dBuV/m)	READ LEVEL (dBuV)	LIMIT (dBuV/m)	MARGIN (dB)	ANTENNA FACTOR (dB/m)	CABLE LOSS (dB)	PREAMP FACTOR (dB)	ANTENNA HEIGHT (cm)	TABLE ANGLE (Degree)	REMARK
5150	46.8	38.55	54	-7.2	34.12	8.13	34	118	10	Average
5150	59.23	50.98	74	-14.77	34.12	8.13	34	118	10	Peak
5210	87.37	79.01			34.17	8.19	34	118	10	Average
5210	95.53	87.17			34.17	8.19	34	118	10	Peak
5432	44	35.21	54	-10	34.35	8.48	34.04	118	10	Average
5432	58.56	49.77	74	-15.44	34.35	8.48	34.04	118	10	Peak

REMARKS:

- Emission Level = Read Level + Antenna Factor + Cable Loss - Preamp Factor
Margin value = Emission level – Limit value
- 5210MHz: Fundamental frequency.



EUT TEST CONDITION		MEASUREMENT DETAIL	
CHANNEL	Channel 58	FREQUENCY RANGE	1GHz ~ 40GHz
INPUT POWER	120Vac, 60 Hz	DETECTOR FUNCTION	Peak (PK) Average (AV)
ENVIRONMENTAL CONDITIONS	25deg. C, 65%RH	TESTED BY	Karl Lee

ANTENNA POLARITY & TEST DISTANCE: HORIZONTAL AT 3 M										
FREQ. (MHz)	EMISSION LEVEL (dBuV/m)	READ LEVEL (dBuV)	LIMIT (dBuV/m)	MARGIN (dB)	ANTENNA FACTOR (dB/m)	CABLE LOSS (dB)	PREAMP FACTOR (dB)	ANTENNA HEIGHT (cm)	TABLE ANGLE (Degree)	REMARK
5094	44.72	36.56	54	-9.28	34.08	8.07	33.99	152	14	Average
5094	57.97	49.81	74	-16.03	34.08	8.07	33.99	152	14	Peak
5290	90.94	82.41			34.23	8.32	34.02	152	14	Average
5290	98.66	90.13			34.23	8.32	34.02	152	14	Peak
5356	49.29	40.66	54	-4.71	34.28	8.38	34.03	152	14	Average
5356	60.72	52.09	74	-13.28	34.28	8.38	34.03	152	14	Peak

ANTENNA POLARITY & TEST DISTANCE: VERTICAL AT 3 M										
FREQ. (MHz)	EMISSION LEVEL (dBuV/m)	READ LEVEL (dBuV)	LIMIT (dBuV/m)	MARGIN (dB)	ANTENNA FACTOR (dB/m)	CABLE LOSS (dB)	PREAMP FACTOR (dB)	ANTENNA HEIGHT (cm)	TABLE ANGLE (Degree)	REMARK
5146	43.52	35.27	54	-10.48	34.12	8.13	34	103	211	Average
5146	56.89	48.64	74	-17.11	34.12	8.13	34	103	211	Peak
5290	89.07	80.54			34.23	8.32	34.02	103	211	Average
5290	96.56	88.03			34.23	8.32	34.02	103	211	Peak
5366	48.19	39.55	54	-5.81	34.29	8.38	34.03	103	211	Average
5366	58.34	49.7	74	-15.66	34.29	8.38	34.03	103	211	Peak

REMARKS:

- Emission Level = Read Level + Antenna Factor + Cable Loss - Preamp Factor
Margin value = Emission level – Limit value
- 5290MHz: Fundamental frequency.



EUT TEST CONDITION		MEASUREMENT DETAIL	
CHANNEL	Channel 106	FREQUENCY RANGE	1GHz ~ 40GHz
INPUT POWER	120Vac, 60 Hz	DETECTOR FUNCTION	Peak (PK) Average (AV)
ENVIRONMENTAL CONDITIONS	25deg. C, 65%RH	TESTED BY	Karl Lee

ANTENNA POLARITY & TEST DISTANCE: HORIZONTAL AT 3 M										
FREQ. (MHz)	EMISSION LEVEL (dBuV/m)	READ LEVEL (dBuV)	LIMIT (dBuV/m)	MARGIN (dB)	ANTENNA FACTOR (dB/m)	CABLE LOSS (dB)	PREAMP FACTOR (dB)	ANTENNA HEIGHT (cm)	TABLE ANGLE (Degree)	REMARK
5444	47.41	38.62	54	-6.59	34.35	8.48	34.04	105	77	Average
5444	60.13	51.34	74	-13.87	34.35	8.48	34.04	105	77	Peak
5470	59.35	50.52	68.2	-8.85	34.37	8.51	34.05	105	77	Peak
5530	88.85	79.92			34.42	8.58	34.07	105	77	Average
5530	96.3	87.37			34.42	8.58	34.07	105	77	Peak
5725	56.22	47.06	68.2	-11.98	34.62	8.65	34.11	105	77	Peak

ANTENNA POLARITY & TEST DISTANCE: VERTICAL AT 3 M										
FREQ. (MHz)	EMISSION LEVEL (dBuV/m)	READ LEVEL (dBuV)	LIMIT (dBuV/m)	MARGIN (dB)	ANTENNA FACTOR (dB/m)	CABLE LOSS (dB)	PREAMP FACTOR (dB)	ANTENNA HEIGHT (cm)	TABLE ANGLE (Degree)	REMARK
5446	46.73	37.9	54	-7.27	34.36	8.51	34.04	175	91	Average
5446	59.76	50.93	74	-14.24	34.36	8.51	34.04	175	91	Peak
5470	57.13	48.3	68.2	-11.07	34.37	8.51	34.05	175	91	Peak
5530	86.38	77.45			34.42	8.58	34.07	175	91	Average
5530	94.79	85.86			34.42	8.58	34.07	175	91	Peak
5725	55.71	46.55	68.2	-12.49	34.62	8.65	34.11	175	91	Peak

REMARKS:

- Emission Level = Read Level + Antenna Factor + Cable Loss - Preamp Factor
Margin value = Emission level – Limit value
- 5530MHz: Fundamental frequency.
- 5470MHz & 5725MHz: Out of restricted band

EUT TEST CONDITION		MEASUREMENT DETAIL	
CHANNEL	Channel 122	FREQUENCY RANGE	1GHz ~ 40GHz
INPUT POWER	120Vac, 60 Hz	DETECTOR FUNCTION	Peak (PK) Average (AV)
ENVIRONMENTAL CONDITIONS	25deg. C, 65%RH	TESTED BY	Karl Lee

ANTENNA POLARITY & TEST DISTANCE: HORIZONTAL AT 3 M										
FREQ. (MHz)	EMISSION LEVEL (dBuV/m)	READ LEVEL (dBuV)	LIMIT (dBuV/m)	MARGIN (dB)	ANTENNA FACTOR (dB/m)	CABLE LOSS (dB)	PREAMP FACTOR (dB)	ANTENNA HEIGHT (cm)	TABLE ANGLE (Degree)	REMARK
5440	45.02	36.23	54	-8.98	34.35	8.48	34.04	109	75	Average
5440	57.19	48.4	74	-16.81	34.35	8.48	34.04	109	75	Peak
5470	55.57	46.74	68.2	-12.63	34.37	8.51	34.05	109	75	Peak
5610	91.71	82.68			34.5	8.61	34.08	109	75	Average
5610	99.16	90.13			34.5	8.61	34.08	109	75	Peak
5725	56.07	46.91	68.2	-12.13	34.62	8.65	34.11	109	75	Peak
ANTENNA POLARITY & TEST DISTANCE: VERTICAL AT 3 M										
FREQ. (MHz)	EMISSION LEVEL (dBuV/m)	READ LEVEL (dBuV)	LIMIT (dBuV/m)	MARGIN (dB)	ANTENNA FACTOR (dB/m)	CABLE LOSS (dB)	PREAMP FACTOR (dB)	ANTENNA HEIGHT (cm)	TABLE ANGLE (Degree)	REMARK
5458	45.27	36.45	54	-8.73	34.36	8.51	34.05	200	92	Average
5458	57.51	48.69	74	-16.49	34.36	8.51	34.05	200	92	Peak
5470	57.68	48.85	68.2	-10.52	34.37	8.51	34.05	200	92	Peak
5610	89.61	80.58			34.5	8.61	34.08	200	92	Average
5610	97.85	88.82			34.5	8.61	34.08	200	92	Peak
5725	55.92	46.76	68.2	-12.28	34.62	8.65	34.11	200	92	Peak

REMARKS:

- Emission Level = Read Level + Antenna Factor + Cable Loss - Preamp Factor
Margin value = Emission level – Limit value
- 5610MHz: Fundamental frequency.
- 5470MHz & 5725MHz: Out of restricted band

EUT TEST CONDITION		MEASUREMENT DETAIL	
CHANNEL	Channel 155	FREQUENCY RANGE	1GHz ~ 40GHz
INPUT POWER	120Vac, 60 Hz	DETECTOR FUNCTION	Peak (PK) Average (AV)
ENVIRONMENTAL CONDITIONS	25deg. C, 65%RH	TESTED BY	Karl Lee

ANTENNA POLARITY & TEST DISTANCE: HORIZONTAL AT 3 M										
FREQ. (MHz)	EMISSION LEVEL (dBuV/m)	READ LEVEL (dBuV)	LIMIT (dBuV/m)	MARGIN (dB)	ANTENNA FACTOR (dB/m)	CABLE LOSS (dB)	PREAMP FACTOR (dB)	ANTENNA HEIGHT (cm)	TABLE ANGLE (Degree)	REMARK
5440	45.02	36.23	54	-8.98	34.35	8.48	34.04	109	75	Average
5440	57.19	48.4	74	-16.81	34.35	8.48	34.04	109	75	Peak
5470	55.57	46.74	68.2	-12.63	34.37	8.51	34.05	109	75	Peak
5610	91.71	82.68			34.5	8.61	34.08	109	75	Average
5610	99.16	90.13			34.5	8.61	34.08	109	75	Peak
5725	56.07	46.91	68.2	-12.13	34.62	8.65	34.11	109	75	Peak
ANTENNA POLARITY & TEST DISTANCE: VERTICAL AT 3 M										
FREQ. (MHz)	EMISSION LEVEL (dBuV/m)	READ LEVEL (dBuV)	LIMIT (dBuV/m)	MARGIN (dB)	ANTENNA FACTOR (dB/m)	CABLE LOSS (dB)	PREAMP FACTOR (dB)	ANTENNA HEIGHT (cm)	TABLE ANGLE (Degree)	REMARK
5458	45.27	36.45	54	-8.73	34.36	8.51	34.05	200	92	Average
5458	57.51	48.69	74	-16.49	34.36	8.51	34.05	200	92	Peak
5470	57.68	48.85	68.2	-10.52	34.37	8.51	34.05	200	92	Peak
5610	89.61	80.58			34.5	8.61	34.08	200	92	Average
5610	97.85	88.82			34.5	8.61	34.08	200	92	Peak
5725	55.92	46.76	68.2	-12.28	34.62	8.65	34.11	200	92	Peak

REMARKS:

- Emission Level = Read Level + Antenna Factor + Cable Loss - Preamp Factor
Margin value = Emission level – Limit value
- 5775MHz: Fundamental frequency.
- 5470MHz & 5725MHz: Out of restricted band

Mode B (2Tx)
802.11n (20MHz)

EUT TEST CONDITION		MEASUREMENT DETAIL	
CHANNEL	Channel 36	FREQUENCY RANGE	1GHz ~ 40GHz
INPUT POWER	120Vac, 60 Hz	DETECTOR FUNCTION	Peak (PK) Average (AV)
ENVIRONMENTAL CONDITIONS	25deg. C, 65%RH	TESTED BY	Karl Lee

ANTENNA POLARITY & TEST DISTANCE: HORIZONTAL AT 3 M										
FREQ. (MHz)	EMISSION LEVEL (dBuV/m)	READ LEVEL (dBuV)	LIMIT (dBuV/m)	MARGIN (dB)	ANTENNA FACTOR (dB/m)	CABLE LOSS (dB)	PREAMP FACTOR (dB)	ANTENNA HEIGHT (cm)	TABLE ANGLE (Degree)	REMARK
5142	44.85	36.59	54	-9.15	34.12	8.13	33.99	178	73	Average
5142	59.46	51.2	74	-14.54	34.12	8.13	33.99	178	73	Peak
5220	102.35	93.96			34.17	8.22	34	178	73	Average
5220	109.58	101.19			34.17	8.22	34	178	73	Peak
5406	45.36	36.64	54	-8.64	34.32	8.44	34.04	178	73	Average
5406	59.78	51.06	74	-14.22	34.32	8.44	34.04	178	73	Peak

ANTENNA POLARITY & TEST DISTANCE: VERTICAL AT 3 M										
FREQ. (MHz)	EMISSION LEVEL (dBuV/m)	READ LEVEL (dBuV)	LIMIT (dBuV/m)	MARGIN (dB)	ANTENNA FACTOR (dB/m)	CABLE LOSS (dB)	PREAMP FACTOR (dB)	ANTENNA HEIGHT (cm)	TABLE ANGLE (Degree)	REMARK
5150	50.65	42.4	54	-28.66	34.12	8.13	34	205	93	Average
5150	63.29	55.04	74	-24.55	34.12	8.13	34	205	93	Peak
5180	99.31	91			34.15	8.16	34	205	91	Average
5180	107.84	99.53			34.15	8.16	34	205	91	Peak
5402	44.06	35.34	54	-35.25	34.32	8.44	34.04	205	91	Average
5402	59.57	50.85	74	-28.27	34.32	8.44	34.04	205	91	Peak

REMARKS:

- Emission Level = Read Level + Antenna Factor + Cable Loss - Preamp Factor
Margin value = Emission level – Limit value
- 5180MHz: Fundamental frequency.



A D T

EUT TEST CONDITION		MEASUREMENT DETAIL	
CHANNEL	Channel 44	FREQUENCY RANGE	1GHz ~ 40GHz
INPUT POWER	120Vac, 60 Hz	DETECTOR FUNCTION	Peak (PK) Average (AV)
ENVIRONMENTAL CONDITIONS	25deg. C, 65%RH	TESTED BY	Karl Lee

ANTENNA POLARITY & TEST DISTANCE: HORIZONTAL AT 3 M										
FREQ. (MHz)	EMISSION LEVEL (dBuV/m)	READ LEVEL (dBuV)	LIMIT (dBuV/m)	MARGIN (dB)	ANTENNA FACTOR (dB/m)	CABLE LOSS (dB)	PREAMP FACTOR (dB)	ANTENNA HEIGHT (cm)	TABLE ANGLE (Degree)	REMARK
5142	44.85	36.59	54	-9.15	34.12	8.13	33.99	178	73	Average
5142	59.46	51.2	74	-14.54	34.12	8.13	33.99	178	73	Peak
5220	102.35	93.96			34.17	8.22	34	178	73	Average
5220	109.58	101.19			34.17	8.22	34	178	73	Peak
5406	45.36	36.64	54	-8.64	34.32	8.44	34.04	178	73	Average
5406	59.78	51.06	74	-14.22	34.32	8.44	34.04	178	73	Peak
10440	48.36	33.9	82.35	-33.99	37.16	12.47	35.17	200	338	Average
10440	57.81	43.35	89.58	-31.77	37.16	12.47	35.17	200	338	Peak
ANTENNA POLARITY & TEST DISTANCE: VERTICAL AT 3 M										
FREQ. (MHz)	EMISSION LEVEL (dBuV/m)	READ LEVEL (dBuV)	LIMIT (dBuV/m)	MARGIN (dB)	ANTENNA FACTOR (dB/m)	CABLE LOSS (dB)	PREAMP FACTOR (dB)	ANTENNA HEIGHT (cm)	TABLE ANGLE (Degree)	REMARK
5134	44.84	36.59	54	-9.16	34.11	8.13	33.99	183	92	Average
5134	60.32	52.07	74	-13.68	34.11	8.13	33.99	183	92	Peak
5220	101.3	92.91			34.17	8.22	34	183	92	Average
5220	108.79	100.4			34.17	8.22	34	183	92	Peak
5412	44.38	35.65	54	-9.62	34.33	8.44	34.04	183	92	Average
5412	60.62	51.89	74	-13.38	34.33	8.44	34.04	183	92	Peak

REMARKS:

- Emission Level = Read Level + Antenna Factor + Cable Loss - Preamp Factor
Margin value = Emission level – Limit value
- 5220MHz: Fundamental frequency.
- 10440MHz: Out of restricted band



EUT TEST CONDITION		MEASUREMENT DETAIL			
CHANNEL	Channel 48	FREQUENCY RANGE	1GHz ~ 40GHz		
INPUT POWER	120Vac, 60 Hz	DETECTOR FUNCTION	Peak (PK) Average (AV)		
ENVIRONMENTAL CONDITIONS	25deg. C, 65%RH	TESTED BY	Karl Lee		

ANTENNA POLARITY & TEST DISTANCE: HORIZONTAL AT 3 M										
FREQ. (MHz)	EMISSION LEVEL (dBuV/m)	READ LEVEL (dBuV)	LIMIT (dBuV/m)	MARGIN (dB)	ANTENNA FACTOR (dB/m)	CABLE LOSS (dB)	PREAMP FACTOR (dB)	ANTENNA HEIGHT (cm)	TABLE ANGLE (Degree)	REMARK
5058	43.19	35.09	54	-39.35	34.05	8.03	33.98	178	73	Average
5058	59.11	51.01	74	-30.36	34.05	8.03	33.98	178	73	Peak
5240	102.54	94.1			34.19	8.26	34.01	178	73	Average
5240	109.47	101.03			34.19	8.26	34.01	178	73	Peak
5450	44.97	36.15	54	-37.57	34.36	8.51	34.05	178	73	Average
5450	59.17	50.35	74	-30.3	34.36	8.51	34.05	178	73	Peak

ANTENNA POLARITY & TEST DISTANCE: VERTICAL AT 3 M										
FREQ. (MHz)	EMISSION LEVEL (dBuV/m)	READ LEVEL (dBuV)	LIMIT (dBuV/m)	MARGIN (dB)	ANTENNA FACTOR (dB/m)	CABLE LOSS (dB)	PREAMP FACTOR (dB)	ANTENNA HEIGHT (cm)	TABLE ANGLE (Degree)	REMARK
5052	43.14	35.08	54	-38.5	34.04	8	33.98	194	92	Average
5052	58.92	50.86	74	-29.57	34.04	8	33.98	194	92	Peak
5240	101.64	93.2			34.19	8.26	34.01	194	92	Average
5240	108.49	100.05			34.19	8.26	34.01	194	92	Peak
5456	44.57	35.75	54	-37.07	34.36	8.51	34.05	194	92	Average
5456	59	50.18	74	-29.49	34.36	8.51	34.05	194	92	Peak

REMARKS:

- Emission Level = Read Level + Antenna Factor + Cable Loss - Preamp Factor
Margin value = Emission level – Limit value
- 5240MHz: Fundamental frequency.

EUT TEST CONDITION		MEASUREMENT DETAIL	
CHANNEL	Channel 52	FREQUENCY RANGE	1GHz ~ 40GHz
INPUT POWER	120Vac, 60 Hz	DETECTOR FUNCTION	Peak (PK) Average (AV)
ENVIRONMENTAL CONDITIONS	25deg. C, 65%RH	TESTED BY	Karl Lee

ANTENNA POLARITY & TEST DISTANCE: HORIZONTAL AT 3 M										
FREQ. (MHz)	EMISSION LEVEL (dBuV/m)	READ LEVEL (dBuV)	LIMIT (dBuV/m)	MARGIN (dB)	ANTENNA FACTOR (dB/m)	CABLE LOSS (dB)	PREAMP FACTOR (dB)	ANTENNA HEIGHT (cm)	TABLE ANGLE (Degree)	REMARK
5102	42.95	34.79	54	-11.05	34.08	8.07	33.99	156	307	Average
5102	58.78	50.62	74	-15.22	34.08	8.07	33.99	156	307	Peak
5260	103.27	94.81			34.21	8.26	34.01	156	307	Average
5260	109.98	101.52			34.21	8.26	34.01	156	307	Peak
5428	43.26	34.49	54	-10.74	34.33	8.48	34.04	156	307	Average
5428	60.56	51.79	74	-13.44	34.33	8.48	34.04	156	307	Peak
ANTENNA POLARITY & TEST DISTANCE: VERTICAL AT 3 M										
FREQ. (MHz)	EMISSION LEVEL (dBuV/m)	READ LEVEL (dBuV)	LIMIT (dBuV/m)	MARGIN (dB)	ANTENNA FACTOR (dB/m)	CABLE LOSS (dB)	PREAMP FACTOR (dB)	ANTENNA HEIGHT (cm)	TABLE ANGLE (Degree)	REMARK
5080	42.6	34.48	54	-11.4	34.07	8.03	33.98	233	266	Average
5080	58.56	50.44	74	-15.44	34.07	8.03	33.98	233	266	Peak
5260	101.87	93.41			34.21	8.26	34.01	233	266	Average
5260	108.69	100.23			34.21	8.26	34.01	233	266	Peak
5434	43.32	34.53	54	-10.68	34.35	8.48	34.04	233	266	Average
5434	58.95	50.16	74	-15.05	34.35	8.48	34.04	233	266	Peak

REMARKS:

- Emission Level = Read Level + Antenna Factor + Cable Loss - Preamp Factor
Margin value = Emission level – Limit value
- 5260MHz: Fundamental frequency.



EUT TEST CONDITION		MEASUREMENT DETAIL	
CHANNEL	Channel 60	FREQUENCY RANGE	1GHz ~ 40GHz
INPUT POWER	120Vac, 60 Hz	DETECTOR FUNCTION	Peak (PK) Average (AV)
ENVIRONMENTAL CONDITIONS	25deg. C, 65%RH	TESTED BY	Karl Lee

ANTENNA POLARITY & TEST DISTANCE: HORIZONTAL AT 3 M										
FREQ. (MHz)	EMISSION LEVEL (dBuV/m)	READ LEVEL (dBuV)	LIMIT (dBuV/m)	MARGIN (dB)	ANTENNA FACTOR (dB/m)	CABLE LOSS (dB)	PREAMP FACTOR (dB)	ANTENNA HEIGHT (cm)	TABLE ANGLE (Degree)	REMARK
5090	42.65	34.48	54	-11.35	34.08	8.07	33.98	163	307	Average
5090	58.73	50.56	74	-15.27	34.08	8.07	33.98	163	307	Peak
5300	101.86	93.32			34.24	8.32	34.02	163	307	Average
5300	109.49	100.95			34.24	8.32	34.02	163	307	Peak
5354	48.46	39.83	54	-5.54	34.28	8.38	34.03	162	306	Average
5354	62.04	53.41	74	-11.96	34.28	8.38	34.03	162	306	Peak
ANTENNA POLARITY & TEST DISTANCE: VERTICAL AT 3 M										
FREQ. (MHz)	EMISSION LEVEL (dBuV/m)	READ LEVEL (dBuV)	LIMIT (dBuV/m)	MARGIN (dB)	ANTENNA FACTOR (dB/m)	CABLE LOSS (dB)	PREAMP FACTOR (dB)	ANTENNA HEIGHT (cm)	TABLE ANGLE (Degree)	REMARK
5134	42.54	34.29	54	-11.46	34.11	8.13	33.99	233	266	Average
5134	58.45	50.2	74	-15.55	34.11	8.13	33.99	233	266	Peak
5300	101.16	92.62			34.24	8.32	34.02	233	266	Average
5300	108.61	100.07			34.24	8.32	34.02	233	266	Peak
5448	48.47	39.64	54	-5.53	34.36	8.51	34.04	229	266	Average
5448	60.75	51.92	74	-13.25	34.36	8.51	34.04	229	266	Peak

REMARKS:

- Emission Level = Read Level + Antenna Factor + Cable Loss - Preamp Factor
Margin value = Emission level – Limit value
- 5300MHz: Fundamental frequency.



EUT TEST CONDITION		MEASUREMENT DETAIL	
CHANNEL	Channel 64	FREQUENCY RANGE	1GHz ~ 40GHz
INPUT POWER	120Vac, 60 Hz	DETECTOR FUNCTION	Peak (PK) Average (AV)
ENVIRONMENTAL CONDITIONS	25deg. C, 65%RH	TESTED BY	Karl Lee

ANTENNA POLARITY & TEST DISTANCE: HORIZONTAL AT 3 M										
FREQ. (MHz)	EMISSION LEVEL (dBuV/m)	READ LEVEL (dBuV)	LIMIT (dBuV/m)	MARGIN (dB)	ANTENNA FACTOR (dB/m)	CABLE LOSS (dB)	PREAMP FACTOR (dB)	ANTENNA HEIGHT (cm)	TABLE ANGLE (Degree)	REMARK
5012	42.48	34.47	54	-11.52	34.01	7.97	33.97	157	307	Average
5012	60.03	52.02	74	-13.97	34.01	7.97	33.97	157	307	Peak
5320	101.1	92.52			34.25	8.35	34.02	157	307	Average
5320	107.84	99.26			34.25	8.35	34.02	157	307	Peak
5350	52.66	44.03	54	-1.34	34.28	8.38	34.03	162	307	Average
5350	64.27	55.64	74	-9.73	34.28	8.38	34.03	162	307	Peak
ANTENNA POLARITY & TEST DISTANCE: VERTICAL AT 3 M										
FREQ. (MHz)	EMISSION LEVEL (dBuV/m)	READ LEVEL (dBuV)	LIMIT (dBuV/m)	MARGIN (dB)	ANTENNA FACTOR (dB/m)	CABLE LOSS (dB)	PREAMP FACTOR (dB)	ANTENNA HEIGHT (cm)	TABLE ANGLE (Degree)	REMARK
5120	42.39	34.19	54	-11.61	34.09	8.1	33.99	222	266	Average
5120	58.35	50.15	74	-15.65	34.09	8.1	33.99	222	266	Peak
5320	99.8	91.22			34.25	8.35	34.02	222	266	Average
5320	106.6	98.02			34.25	8.35	34.02	222	266	Peak
5350	51.56	42.93	54	-2.44	34.28	8.38	34.03	229	266	Average
5350	64.45	55.82	74	-9.55	34.28	8.38	34.03	229	266	Peak

REMARKS:

- Emission Level = Read Level + Antenna Factor + Cable Loss - Preamp Factor
Margin value = Emission level – Limit value
- 5320MHz: Fundamental frequency.



A D T

EUT TEST CONDITION		MEASUREMENT DETAIL	
CHANNEL	Channel 100	FREQUENCY RANGE	1GHz ~ 40GHz
INPUT POWER	120Vac, 60 Hz	DETECTOR FUNCTION	Peak (PK) Average (AV)
ENVIRONMENTAL CONDITIONS	25deg. C, 65%RH	TESTED BY	Karl Lee

ANTENNA POLARITY & TEST DISTANCE: HORIZONTAL AT 3 M										
FREQ. (MHz)	EMISSION LEVEL (dBuV/m)	READ LEVEL (dBuV)	LIMIT (dBuV/m)	MARGIN (dB)	ANTENNA FACTOR (dB/m)	CABLE LOSS (dB)	PREAMP FACTOR (dB)	ANTENNA HEIGHT (cm)	TABLE ANGLE (Degree)	REMARK
5460	47.67	38.85	54	-6.33	34.36	8.51	34.05	100	111	Average
5460	60.99	52.17	74	-13.01	34.36	8.51	34.05	100	111	Peak
5470	67.01	58.18	68.2	-1.19	34.37	8.51	34.05	100	111	Peak
5500	98.12	89.2			34.4	8.57	34.05	117	111	Average
5500	105.32	96.4			34.4	8.57	34.05	117	111	Peak
5725	57.58	48.42	68.2	-10.62	34.62	8.65	34.11	117	111	Peak
ANTENNA POLARITY & TEST DISTANCE: VERTICAL AT 3 M										
FREQ. (MHz)	EMISSION LEVEL (dBuV/m)	READ LEVEL (dBuV)	LIMIT (dBuV/m)	MARGIN (dB)	ANTENNA FACTOR (dB/m)	CABLE LOSS (dB)	PREAMP FACTOR (dB)	ANTENNA HEIGHT (cm)	TABLE ANGLE (Degree)	REMARK
5452	44.97	36.15	54	-9.03	34.36	8.51	34.05	100	168	Average
5452	58.98	50.16	74	-15.02	34.36	8.51	34.05	100	168	Peak
5470	66.8	57.97	68.2	-1.4	34.37	8.51	34.05	132	165	Peak
5500	99.27	90.35			34.4	8.57	34.05	100	168	Average
5500	106.68	97.76			34.4	8.57	34.05	100	168	Peak
5725	57.9	48.74	68.2	-10.3	34.62	8.65	34.11	100	168	Peak

REMARKS:

- Emission Level = Read Level + Antenna Factor + Cable Loss - Preamp Factor
Margin value = Emission level – Limit value
- 5500MHz: Fundamental frequency.
- 5470MHz & 5725MHz: Out of restricted band

EUT TEST CONDITION		MEASUREMENT DETAIL	
CHANNEL	Channel 116	FREQUENCY RANGE	1GHz ~ 40GHz
INPUT POWER	120Vac, 60 Hz	DETECTOR FUNCTION	Peak (PK) Average (AV)
ENVIRONMENTAL CONDITIONS	25deg. C, 65%RH	TESTED BY	Karl Lee

ANTENNA POLARITY & TEST DISTANCE: HORIZONTAL AT 3 M										
FREQ. (MHz)	EMISSION LEVEL (dBuV/m)	READ LEVEL (dBuV)	LIMIT (dBuV/m)	MARGIN (dB)	ANTENNA FACTOR (dB/m)	CABLE LOSS (dB)	PREAMP FACTOR (dB)	ANTENNA HEIGHT (cm)	TABLE ANGLE (Degree)	REMARK
5442	43.22	34.43	54	-10.78	34.35	8.48	34.04	150	112	Average
5442	59.71	50.92	74	-14.29	34.35	8.48	34.04	150	112	Peak
5470	59.16	50.33	68.2	-9.04	34.37	8.51	34.05	150	112	Peak
5580	100.87	91.88			34.47	8.6	34.08	150	112	Average
5580	108.01	99.02			34.47	8.6	34.08	150	112	Peak
5725	58.54	49.38	68.2	-9.66	34.62	8.65	34.11	150	112	Peak
ANTENNA POLARITY & TEST DISTANCE: VERTICAL AT 3 M										
FREQ. (MHz)	EMISSION LEVEL (dBuV/m)	READ LEVEL (dBuV)	LIMIT (dBuV/m)	MARGIN (dB)	ANTENNA FACTOR (dB/m)	CABLE LOSS (dB)	PREAMP FACTOR (dB)	ANTENNA HEIGHT (cm)	TABLE ANGLE (Degree)	REMARK
5396	42.66	33.94	54	-11.34	34.32	8.44	34.04	142	170	Average
5396	59.58	50.86	74	-14.42	34.32	8.44	34.04	142	170	Peak
5470	57.62	48.79	68.2	-10.58	34.37	8.51	34.05	142	170	Peak
5580	101.27	92.28			34.47	8.6	34.08	142	170	Average
5580	109.59	100.6			34.47	8.6	34.08	142	170	Peak
5725	56.83	47.67	68.2	-11.37	34.62	8.65	34.11	142	170	Peak

REMARKS:

- Emission Level = Read Level + Antenna Factor + Cable Loss - Preamp Factor
Margin value = Emission level – Limit value
- 5580MHz: Fundamental frequency.
- 5470MHz & 5725MHz: Out of restricted band

EUT TEST CONDITION		MEASUREMENT DETAIL	
CHANNEL	Channel 140	FREQUENCY RANGE	1GHz ~ 40GHz
INPUT POWER	120Vac, 60 Hz	DETECTOR FUNCTION	Peak (PK) Average (AV)
ENVIRONMENTAL CONDITIONS	25deg. C, 65%RH	TESTED BY	Karl Lee

ANTENNA POLARITY & TEST DISTANCE: HORIZONTAL AT 3 M										
FREQ. (MHz)	EMISSION LEVEL (dBuV/m)	READ LEVEL (dBuV)	LIMIT (dBuV/m)	MARGIN (dB)	ANTENNA FACTOR (dB/m)	CABLE LOSS (dB)	PREAMP FACTOR (dB)	ANTENNA HEIGHT (cm)	TABLE ANGLE (Degree)	REMARK
5440	43.68	34.89	54	-10.32	34.35	8.48	34.04	160	299	Average
5440	58.98	50.19	74	-15.02	34.35	8.48	34.04	160	299	Peak
5470	58.4	49.57	68.2	-9.8	34.37	8.51	34.05	160	299	Peak
5700	97.34	88.21			34.59	8.64	34.1	160	299	Average
5700	105.85	96.72			34.59	8.64	34.1	160	299	Peak
5725	63	53.84	68.2	-5.2	34.62	8.65	34.11	160	299	Peak
ANTENNA POLARITY & TEST DISTANCE: VERTICAL AT 3 M										
FREQ. (MHz)	EMISSION LEVEL (dBuV/m)	READ LEVEL (dBuV)	LIMIT (dBuV/m)	MARGIN (dB)	ANTENNA FACTOR (dB/m)	CABLE LOSS (dB)	PREAMP FACTOR (dB)	ANTENNA HEIGHT (cm)	TABLE ANGLE (Degree)	REMARK
5350	42.56	33.93	54	-11.44	34.28	8.38	34.03	132	204	Average
5350	58.83	50.2	74	-15.17	34.28	8.38	34.03	132	204	Peak
5470	57.74	48.91	68.2	-10.46	34.37	8.51	34.05	132	204	Peak
5700	99.71	90.58			34.59	8.64	34.1	132	204	Average
5700	106.94	97.81			34.59	8.64	34.1	132	204	Peak
5725	67.2	58.04	68.2	-1	34.62	8.65	34.11	131	204	Peak

REMARKS:

- Emission Level = Read Level + Antenna Factor + Cable Loss - Preamp Factor
Margin value = Emission level – Limit value
- 5700MHz: Fundamental frequency.
- 5470MHz & 5725MHz: Out of restricted band

EUT TEST CONDITION		MEASUREMENT DETAIL	
CHANNEL	Channel 149	FREQUENCY RANGE	1GHz ~ 40GHz
INPUT POWER	120Vac, 60 Hz	DETECTOR FUNCTION	Peak (PK) Average (AV)
ENVIRONMENTAL CONDITIONS	25deg. C, 65%RH	TESTED BY	Karl Lee

ANTENNA POLARITY & TEST DISTANCE: HORIZONTAL AT 3 M										
FREQ. (MHz)	EMISSION LEVEL (dBuV/m)	READ LEVEL (dBuV)	LIMIT (dBuV/m)	MARGIN (dB)	ANTENNA FACTOR (dB/m)	CABLE LOSS (dB)	PREAMP FACTOR (dB)	ANTENNA HEIGHT (cm)	TABLE ANGLE (Degree)	REMARK
*5712	66.49	57.34	68.2	-1.71	34.61	8.65	34.11	109	200	Peak
*5724	74.2	65.04	78.2	-4	34.62	8.65	34.11	109	200	Peak
5745	99.3	90.11			34.64	8.66	34.11	110	202	Average
5745	105.92	96.73			34.64	8.66	34.11	110	202	Peak
*5858	59.31	49.99	78.2	-18.89	34.76	8.7	34.14	110	202	Peak
*5864	60.94	51.61	68.2	-7.26	34.76	8.71	34.14	110	202	Peak
ANTENNA POLARITY & TEST DISTANCE: VERTICAL AT 3 M										
FREQ. (MHz)	EMISSION LEVEL (dBuV/m)	READ LEVEL (dBuV)	LIMIT (dBuV/m)	MARGIN (dB)	ANTENNA FACTOR (dB/m)	CABLE LOSS (dB)	PREAMP FACTOR (dB)	ANTENNA HEIGHT (cm)	TABLE ANGLE (Degree)	REMARK
*5714	66.82	57.67	68.2	-1.38	34.61	8.65	34.11	101	170	Peak
*5724	74.16	65	78.2	-4.04	34.62	8.65	34.11	101	170	Peak
5745	99.7	90.51			34.64	8.66	34.11	106	170	Average
5745	106.63	97.44			34.64	8.66	34.11	106	170	Peak
*5856	59.72	50.4	78.2	-18.48	34.76	8.7	34.14	106	170	Peak
*5864	59.21	49.88	68.2	-8.99	34.76	8.71	34.14	106	170	Peak

REMARKS:

- Emission Level = Read Level + Antenna Factor + Cable Loss - Preamp Factor
Margin value = Emission level – Limit value
- 5745MHz: Fundamental frequency.
- *: Out of restricted band

EUT TEST CONDITION		MEASUREMENT DETAIL	
CHANNEL	Channel 157	FREQUENCY RANGE	1GHz ~ 40GHz
INPUT POWER	120Vac, 60 Hz	DETECTOR FUNCTION	Peak (PK) Average (AV)
ENVIRONMENTAL CONDITIONS	25deg. C, 65%RH	TESTED BY	Karl Lee

ANTENNA POLARITY & TEST DISTANCE: HORIZONTAL AT 3 M										
FREQ. (MHz)	EMISSION LEVEL (dBuV/m)	READ LEVEL (dBuV)	LIMIT (dBuV/m)	MARGIN (dB)	ANTENNA FACTOR (dB/m)	CABLE LOSS (dB)	PREAMP FACTOR (dB)	ANTENNA HEIGHT (cm)	TABLE ANGLE (Degree)	REMARK
*5714	61.68	52.53	68.2	-6.52	34.61	8.65	34.11	104	202	Peak
*5724	62.05	52.89	78.2	-16.15	34.62	8.65	34.11	104	202	Peak
5785	102.48	93.25			34.68	8.68	34.13	104	202	Average
5785	109.27	100.04			34.68	8.68	34.13	104	202	Peak
*5858	60.03	50.71	78.2	-18.17	34.76	8.7	34.14	104	202	Peak
*5868	58.66	49.33	68.2	-9.54	34.76	8.71	34.14	104	202	Peak
ANTENNA POLARITY & TEST DISTANCE: VERTICAL AT 3 M										
FREQ. (MHz)	EMISSION LEVEL (dBuV/m)	READ LEVEL (dBuV)	LIMIT (dBuV/m)	MARGIN (dB)	ANTENNA FACTOR (dB/m)	CABLE LOSS (dB)	PREAMP FACTOR (dB)	ANTENNA HEIGHT (cm)	TABLE ANGLE (Degree)	REMARK
*5708	59.41	50.26	68.2	-8.79	34.61	8.65	34.11	100	168	Peak
*5724	66.82	57.66	78.2	-11.38	34.62	8.65	34.11	101	168	Peak
5785	103.72	94.49			34.68	8.68	34.13	100	168	Average
5785	110.29	101.06			34.68	8.68	34.13	100	168	Peak
*5856	59.5	50.18	78.2	-18.7	34.76	8.7	34.14	100	168	Peak
*5864	59.5	50.17	68.2	-8.7	34.76	8.71	34.14	100	168	Peak

REMARKS:

- Emission Level = Read Level + Antenna Factor + Cable Loss - Preamp Factor
Margin value = Emission level – Limit value
- 5785MHz: Fundamental frequency.
- *: Out of restricted band

EUT TEST CONDITION		MEASUREMENT DETAIL	
CHANNEL	Channel 165	FREQUENCY RANGE	1GHz ~ 40GHz
INPUT POWER	120Vac, 60 Hz	DETECTOR FUNCTION	Peak (PK) Average (AV)
ENVIRONMENTAL CONDITIONS	25deg. C, 65%RH	TESTED BY	Karl Lee

ANTENNA POLARITY & TEST DISTANCE: HORIZONTAL AT 3 M										
FREQ. (MHz)	EMISSION LEVEL (dBuV/m)	READ LEVEL (dBuV)	LIMIT (dBuV/m)	MARGIN (dB)	ANTENNA FACTOR (dB/m)	CABLE LOSS (dB)	PREAMP FACTOR (dB)	ANTENNA HEIGHT (cm)	TABLE ANGLE (Degree)	REMARK
*5708	58.86	49.71	68.2	-9.34	34.61	8.65	34.11	104	202	Peak
*5722	58.53	49.37	78.2	-19.67	34.62	8.65	34.11	104	202	Peak
5825	99.52	90.23			34.73	8.69	34.13	104	202	Average
5825	106.53	97.24			34.73	8.69	34.13	104	202	Peak
*5852	72.12	62.82	78.2	-6.08	34.74	8.7	34.14	180	203	Peak
*5862	66.86	57.53	68.2	-1.34	34.76	8.71	34.14	180	203	Peak
ANTENNA POLARITY & TEST DISTANCE: VERTICAL AT 3 M										
FREQ. (MHz)	EMISSION LEVEL (dBuV/m)	READ LEVEL (dBuV)	LIMIT (dBuV/m)	MARGIN (dB)	ANTENNA FACTOR (dB/m)	CABLE LOSS (dB)	PREAMP FACTOR (dB)	ANTENNA HEIGHT (cm)	TABLE ANGLE (Degree)	REMARK
*5710	59.44	50.29	68.2	-8.76	34.61	8.65	34.11	148	169	Peak
*5718	59.48	50.32	78.2	-18.72	34.62	8.65	34.11	148	169	Peak
5825	99.78	90.49			34.73	8.69	34.13	148	169	Average
5825	107.05	97.76			34.73	8.69	34.13	148	169	Peak
*5852	74.28	64.98	78.2	-3.92	34.74	8.7	34.14	104	169	Peak
*5864	66.72	57.39	68.2	-1.48	34.76	8.71	34.14	104	169	Peak

REMARKS:

- Emission Level = Read Level + Antenna Factor + Cable Loss - Preamp Factor
Margin value = Emission level – Limit value
- 5825MHz: Fundamental frequency.
- *: Out of restricted band



802.11n (40MHz)

EUT TEST CONDITION		MEASUREMENT DETAIL	
CHANNEL	Channel 38	FREQUENCY RANGE	1GHz ~ 40GHz
INPUT POWER	120Vac, 60 Hz	DETECTOR FUNCTION	Peak (PK) Average (AV)
ENVIRONMENTAL CONDITIONS	25deg. C, 65%RH	TESTED BY	Karl Lee

ANTENNA POLARITY & TEST DISTANCE: HORIZONTAL AT 3 M										
FREQ. (MHz)	EMISSION LEVEL (dBuV/m)	READ LEVEL (dBuV)	LIMIT (dBuV/m)	MARGIN (dB)	ANTENNA FACTOR (dB/m)	CABLE LOSS (dB)	PREAMP FACTOR (dB)	ANTENNA HEIGHT (cm)	TABLE ANGLE (Degree)	REMARK
5150	52.95	44.7	54	-22.59	34.12	8.13	34	185	75	Average
5150	63.48	55.23	74	-18.87	34.12	8.13	34	185	75	Peak
5190	95.54	87.2			34.15	8.19	34	186	75	Average
5190	102.35	94.01			34.15	8.19	34	186	75	Peak
5386	43.62	34.94	54	-31.92	34.31	8.41	34.04	186	75	Average
5386	59.96	51.28	74	-22.39	34.31	8.41	34.04	186	75	Peak

ANTENNA POLARITY & TEST DISTANCE: VERTICAL AT 3 M										
FREQ. (MHz)	EMISSION LEVEL (dBuV/m)	READ LEVEL (dBuV)	LIMIT (dBuV/m)	MARGIN (dB)	ANTENNA FACTOR (dB/m)	CABLE LOSS (dB)	PREAMP FACTOR (dB)	ANTENNA HEIGHT (cm)	TABLE ANGLE (Degree)	REMARK
5150	52.05	43.8	54	-22.69	34.12	8.13	34	200	90	Average
5150	63.55	55.3	74	-17.92	34.12	8.13	34	200	90	Peak
5190	94.74	86.4			34.15	8.19	34	205	91	Average
5190	101.47	93.13			34.15	8.19	34	205	91	Peak
5430	43.62	34.83	54	-31.12	34.35	8.48	34.04	205	91	Average
5430	58.78	49.99	74	-22.69	34.35	8.48	34.04	205	91	Peak

REMARKS:

- Emission Level = Read Level + Antenna Factor + Cable Loss - Preamp Factor
Margin value = Emission level – Limit value
- 5190MHz: Fundamental frequency.



A D T

EUT TEST CONDITION		MEASUREMENT DETAIL	
CHANNEL	Channel 46	FREQUENCY RANGE	1GHz ~ 40GHz
INPUT POWER	120Vac, 60 Hz	DETECTOR FUNCTION	Peak (PK) Average (AV)
ENVIRONMENTAL CONDITIONS	25deg. C, 65%RH	TESTED BY	Karl Lee

ANTENNA POLARITY & TEST DISTANCE: HORIZONTAL AT 3 M										
FREQ. (MHz)	EMISSION LEVEL (dBuV/m)	READ LEVEL (dBuV)	LIMIT (dBuV/m)	MARGIN (dB)	ANTENNA FACTOR (dB/m)	CABLE LOSS (dB)	PREAMP FACTOR (dB)	ANTENNA HEIGHT (cm)	TABLE ANGLE (Degree)	REMARK
5150	52.65	44.4	54	-27.46	34.12	8.13	34	182	73	Average
5150	63.88	55.63	74	-23.15	34.12	8.13	34	182	73	Peak
5230	100.11	91.71			34.19	8.22	34.01	178	73	Average
5230	107.03	98.63			34.19	8.22	34.01	178	73	Peak
5434	45.92	37.13	54	-34.19	34.35	8.48	34.04	178	73	Average
5434	60.48	51.69	74	-26.55	34.35	8.48	34.04	178	73	Peak

ANTENNA POLARITY & TEST DISTANCE: VERTICAL AT 3 M										
FREQ. (MHz)	EMISSION LEVEL (dBuV/m)	READ LEVEL (dBuV)	LIMIT (dBuV/m)	MARGIN (dB)	ANTENNA FACTOR (dB/m)	CABLE LOSS (dB)	PREAMP FACTOR (dB)	ANTENNA HEIGHT (cm)	TABLE ANGLE (Degree)	REMARK
5150	52.93	44.68	54	-26.38	34.12	8.13	34	200	95	Average
5150	65.27	57.02	74	-21.71	34.12	8.13	34	200	95	Peak
5230	99.31	90.91			34.19	8.22	34.01	180	92	Average
5230	106.98	98.58			34.19	8.22	34.01	180	92	Peak
5452	45.87	37.05	54	-33.44	34.36	8.51	34.05	180	92	Average
5452	60.22	51.4	74	-26.76	34.36	8.51	34.05	180	92	Peak

REMARKS:

1. Emission Level = Read Level + Antenna Factor + Cable Loss - Preamp Factor
Margin value = Emission level – Limit value
2. 5230MHz: Fundamental frequency.



EUT TEST CONDITION		MEASUREMENT DETAIL	
CHANNEL	Channel 54	FREQUENCY RANGE	1GHz ~ 40GHz
INPUT POWER	120Vac, 60 Hz	DETECTOR FUNCTION	Peak (PK) Average (AV)
ENVIRONMENTAL CONDITIONS	25deg. C, 65%RH	TESTED BY	Karl Lee

ANTENNA POLARITY & TEST DISTANCE: HORIZONTAL AT 3 M										
FREQ. (MHz)	EMISSION LEVEL (dBuV/m)	READ LEVEL (dBuV)	LIMIT (dBuV/m)	MARGIN (dB)	ANTENNA FACTOR (dB/m)	CABLE LOSS (dB)	PREAMP FACTOR (dB)	ANTENNA HEIGHT (cm)	TABLE ANGLE (Degree)	REMARK
5054	44.24	36.18	54	-9.76	34.04	8	33.98	156	307	Average
5054	59.31	51.25	74	-14.69	34.04	8	33.98	156	307	Peak
5270	99.5	91.01			34.21	8.29	34.01	156	307	Average
5270	107.46	98.97			34.21	8.29	34.01	156	307	Peak
5350	51.52	42.89	54	-2.48	34.28	8.38	34.03	160	307	Average
5350	62.41	53.78	74	-11.59	34.28	8.38	34.03	160	307	Peak
ANTENNA POLARITY & TEST DISTANCE: VERTICAL AT 3 M										
FREQ. (MHz)	EMISSION LEVEL (dBuV/m)	READ LEVEL (dBuV)	LIMIT (dBuV/m)	MARGIN (dB)	ANTENNA FACTOR (dB/m)	CABLE LOSS (dB)	PREAMP FACTOR (dB)	ANTENNA HEIGHT (cm)	TABLE ANGLE (Degree)	REMARK
5070	43.89	35.79	54	-10.11	34.05	8.03	33.98	233	266	Average
5070	58.8	50.7	74	-15.2	34.05	8.03	33.98	233	266	Peak
5270	98.1	89.61			34.21	8.29	34.01	233	266	Average
5270	106.35	97.86			34.21	8.29	34.01	233	266	Peak
5352	50.71	42.08	54	-3.29	34.28	8.38	34.03	211	266	Average
5352	62.73	54.1	74	-11.27	34.28	8.38	34.03	211	266	Peak

REMARKS:

- Emission Level = Read Level + Antenna Factor + Cable Loss - Preamp Factor
Margin value = Emission level – Limit value
- 5270MHz: Fundamental frequency.



EUT TEST CONDITION		MEASUREMENT DETAIL	
CHANNEL	Channel 62	FREQUENCY RANGE	1GHz ~ 40GHz
INPUT POWER	120Vac, 60 Hz	DETECTOR FUNCTION	Peak (PK) Average (AV)
ENVIRONMENTAL CONDITIONS	25deg. C, 65%RH	TESTED BY	Karl Lee

ANTENNA POLARITY & TEST DISTANCE: HORIZONTAL AT 3 M										
FREQ. (MHz)	EMISSION LEVEL (dBuV/m)	READ LEVEL (dBuV)	LIMIT (dBuV/m)	MARGIN (dB)	ANTENNA FACTOR (dB/m)	CABLE LOSS (dB)	PREAMP FACTOR (dB)	ANTENNA HEIGHT (cm)	TABLE ANGLE (Degree)	REMARK
5134	42.94	34.69	54	-11.06	34.11	8.13	33.99	157	110	Average
5134	58.77	50.52	74	-15.23	34.11	8.13	33.99	157	110	Peak
5310	97.27	88.72			34.25	8.32	34.02	157	110	Average
5310	103.88	95.33			34.25	8.32	34.02	157	110	Peak
5350	51.96	43.33	54	-2.04	34.28	8.38	34.03	160	110	Average
5350	66.14	57.51	74	-7.86	34.28	8.38	34.03	160	110	Peak
ANTENNA POLARITY & TEST DISTANCE: VERTICAL AT 3 M										
FREQ. (MHz)	EMISSION LEVEL (dBuV/m)	READ LEVEL (dBuV)	LIMIT (dBuV/m)	MARGIN (dB)	ANTENNA FACTOR (dB/m)	CABLE LOSS (dB)	PREAMP FACTOR (dB)	ANTENNA HEIGHT (cm)	TABLE ANGLE (Degree)	REMARK
5082	42.73	34.57	54	-11.27	34.07	8.07	33.98	222	266	Average
5082	58.21	50.05	74	-15.79	34.07	8.07	33.98	222	266	Peak
5310	95.07	86.52			34.25	8.32	34.02	222	266	Average
5310	102.29	93.74			34.25	8.32	34.02	222	266	Peak
5350	50.66	42.03	54	-3.34	34.28	8.38	34.03	220	266	Average
5350	63.1	54.47	74	-10.9	34.28	8.38	34.03	220	266	Peak

REMARKS:

- Emission Level = Read Level + Antenna Factor + Cable Loss - Preamp Factor
Margin value = Emission level – Limit value
- 5310MHz: Fundamental frequency.



A D T

EUT TEST CONDITION		MEASUREMENT DETAIL	
CHANNEL	Channel 102	FREQUENCY RANGE	1GHz ~ 40GHz
INPUT POWER	120Vac, 60 Hz	DETECTOR FUNCTION	Peak (PK) Average (AV)
ENVIRONMENTAL CONDITIONS	25deg. C, 65%RH	TESTED BY	Karl Lee

ANTENNA POLARITY & TEST DISTANCE: HORIZONTAL AT 3 M										
FREQ. (MHz)	EMISSION LEVEL (dBuV/m)	READ LEVEL (dBuV)	LIMIT (dBuV/m)	MARGIN (dB)	ANTENNA FACTOR (dB/m)	CABLE LOSS (dB)	PREAMP FACTOR (dB)	ANTENNA HEIGHT (cm)	TABLE ANGLE (Degree)	REMARK
5460	43.6	34.78	54	-10.4	34.36	8.51	34.05	100	112	Average
5460	61.08	52.26	74	-12.92	34.36	8.51	34.05	100	112	Peak
5470	63.42	54.59	68.2	-4.78	34.37	8.51	34.05	100	112	Peak
5510	92.7	83.79			34.4	8.57	34.06	100	112	Average
5510	100.06	91.15			34.4	8.57	34.06	100	112	Peak
5725	59.25	50.09	68.2	-8.95	34.62	8.65	34.11	100	112	Peak
ANTENNA POLARITY & TEST DISTANCE: VERTICAL AT 3 M										
FREQ. (MHz)	EMISSION LEVEL (dBuV/m)	READ LEVEL (dBuV)	LIMIT (dBuV/m)	MARGIN (dB)	ANTENNA FACTOR (dB/m)	CABLE LOSS (dB)	PREAMP FACTOR (dB)	ANTENNA HEIGHT (cm)	TABLE ANGLE (Degree)	REMARK
5460	51.42	42.6	54	-2.58	34.36	8.51	34.05	111	350	Average
5460	64.3	55.48	74	-9.7	34.36	8.51	34.05	111	350	Peak
5470	66.68	57.85	68.2	-1.52	34.37	8.51	34.05	137	199	Peak
5510	94.53	85.62			34.4	8.57	34.06	111	350	Average
5510	101.59	92.68			34.4	8.57	34.06	111	350	Peak
5725	59.91	50.75	68.2	-8.29	34.62	8.65	34.11	111	350	Peak

REMARKS:

- Emission Level = Read Level + Antenna Factor + Cable Loss - Preamp Factor
Margin value = Emission level – Limit value
- 5510MHz: Fundamental frequency.
- 5470MHz & 5725MHz: Out of restricted band



EUT TEST CONDITION		MEASUREMENT DETAIL	
CHANNEL	Channel 110	FREQUENCY RANGE	1GHz ~ 40GHz
INPUT POWER	120Vac, 60 Hz	DETECTOR FUNCTION	Peak (PK) Average (AV)
ENVIRONMENTAL CONDITIONS	25deg. C, 65%RH	TESTED BY	Karl Lee

ANTENNA POLARITY & TEST DISTANCE: HORIZONTAL AT 3 M										
FREQ. (MHz)	EMISSION LEVEL (dBuV/m)	READ LEVEL (dBuV)	LIMIT (dBuV/m)	MARGIN (dB)	ANTENNA FACTOR (dB/m)	CABLE LOSS (dB)	PREAMP FACTOR (dB)	ANTENNA HEIGHT (cm)	TABLE ANGLE (Degree)	REMARK
5446	47.05	38.22	54	-6.95	34.36	8.51	34.04	150	112	Average
5446	59.74	50.91	74	-14.26	34.36	8.51	34.04	150	112	Peak
5470	62.06	53.23	68.2	-6.14	34.37	8.51	34.05	150	112	Peak
5550	96.89	87.92			34.45	8.59	34.07	150	112	Average
5550	104.83	95.86			34.45	8.59	34.07	150	112	Peak
5725	58.33	49.17	68.2	-9.87	34.62	8.65	34.11	150	112	Peak
ANTENNA POLARITY & TEST DISTANCE: VERTICAL AT 3 M										
FREQ. (MHz)	EMISSION LEVEL (dBuV/m)	READ LEVEL (dBuV)	LIMIT (dBuV/m)	MARGIN (dB)	ANTENNA FACTOR (dB/m)	CABLE LOSS (dB)	PREAMP FACTOR (dB)	ANTENNA HEIGHT (cm)	TABLE ANGLE (Degree)	REMARK
5418	44.31	35.58	54	-9.69	34.33	8.44	34.04	142	170	Average
5418	59.88	51.15	74	-14.12	34.33	8.44	34.04	142	170	Peak
5470	59.4	50.57	68.2	-8.8	34.37	8.51	34.05	142	170	Peak
5550	98.05	89.08			34.45	8.59	34.07	142	170	Average
5550	105.86	96.89			34.45	8.59	34.07	142	170	Peak
5725	58.48	49.32	68.2	-9.72	34.62	8.65	34.11	142	170	Peak

REMARKS:

- Emission Level = Read Level + Antenna Factor + Cable Loss - Preamp Factor
Margin value = Emission level – Limit value
- 5550MHz: Fundamental frequency.
- 5470MHz & 5725MHz: Out of restricted band



EUT TEST CONDITION		MEASUREMENT DETAIL	
CHANNEL	Channel 134	FREQUENCY RANGE	1GHz ~ 40GHz
INPUT POWER	120Vac, 60 Hz	DETECTOR FUNCTION	Peak (PK) Average (AV)
ENVIRONMENTAL CONDITIONS	25deg. C, 65%RH	TESTED BY	Karl Lee

ANTENNA POLARITY & TEST DISTANCE: HORIZONTAL AT 3 M										
FREQ. (MHz)	EMISSION LEVEL (dBuV/m)	READ LEVEL (dBuV)	LIMIT (dBuV/m)	MARGIN (dB)	ANTENNA FACTOR (dB/m)	CABLE LOSS (dB)	PREAMP FACTOR (dB)	ANTENNA HEIGHT (cm)	TABLE ANGLE (Degree)	REMARK
5412	43.22	34.49	54	-10.78	34.33	8.44	34.04	160	299	Average
5412	60.24	51.51	74	-13.76	34.33	8.44	34.04	160	299	Peak
5470	57.39	48.56	68.2	-10.81	34.37	8.51	34.05	160	299	Peak
5670	95.07	85.97			34.57	8.63	34.1	160	299	Average
5670	103.38	94.28			34.57	8.63	34.1	160	299	Peak
5725	62.71	53.55	68.2	-5.49	34.62	8.65	34.11	160	299	Peak

ANTENNA POLARITY & TEST DISTANCE: VERTICAL AT 3 M										
FREQ. (MHz)	EMISSION LEVEL (dBuV/m)	READ LEVEL (dBuV)	LIMIT (dBuV/m)	MARGIN (dB)	ANTENNA FACTOR (dB/m)	CABLE LOSS (dB)	PREAMP FACTOR (dB)	ANTENNA HEIGHT (cm)	TABLE ANGLE (Degree)	REMARK
5444	43.32	34.53	54	-10.68	34.35	8.48	34.04	132	204	Average
5444	59.04	50.25	74	-14.96	34.35	8.48	34.04	132	204	Peak
5470	56.65	47.82	68.2	-11.55	34.37	8.51	34.05	132	204	Peak
5670	98.09	88.99			34.57	8.63	34.1	132	204	Average
5670	104.34	95.24			34.57	8.63	34.1	132	204	Peak
5725	65.06	55.9	68.2	-3.14	34.62	8.65	34.11	138	204	Peak

REMARKS:

- Emission Level = Read Level + Antenna Factor + Cable Loss - Preamp Factor
Margin value = Emission level – Limit value
- 5670MHz: Fundamental frequency.
- 5470MHz & 5725MHz: Out of restricted band



EUT TEST CONDITION		MEASUREMENT DETAIL	
CHANNEL	Channel 151	FREQUENCY RANGE	1GHz ~ 40GHz
INPUT POWER	120Vac, 60 Hz	DETECTOR FUNCTION	Peak (PK) Average (AV)
ENVIRONMENTAL CONDITIONS	25deg. C, 65%RH	TESTED BY	Karl Lee

ANTENNA POLARITY & TEST DISTANCE: HORIZONTAL AT 3 M										
FREQ. (MHz)	EMISSION LEVEL (dBuV/m)	READ LEVEL (dBuV)	LIMIT (dBuV/m)	MARGIN (dB)	ANTENNA FACTOR (dB/m)	CABLE LOSS (dB)	PREAMP FACTOR (dB)	ANTENNA HEIGHT (cm)	TABLE ANGLE (Degree)	REMARK
*5712	65.9	56.75	68.2	-2.3	34.61	8.65	34.11	112	202	Peak
*5718	67.13	57.97	78.2	-11.07	34.62	8.65	34.11	112	202	Peak
5755	92.92	83.71			34.66	8.66	34.11	110	202	Average
5755	99.43	90.22			34.66	8.66	34.11	110	202	Peak
*5854	59.16	49.84	78.2	-19.04	34.76	8.7	34.14	110	202	Peak
*5870	59.16	49.83	68.2	-9.04	34.76	8.71	34.14	110	202	Peak
ANTENNA POLARITY & TEST DISTANCE: VERTICAL AT 3 M										
FREQ. (MHz)	EMISSION LEVEL (dBuV/m)	READ LEVEL (dBuV)	LIMIT (dBuV/m)	MARGIN (dB)	ANTENNA FACTOR (dB/m)	CABLE LOSS (dB)	PREAMP FACTOR (dB)	ANTENNA HEIGHT (cm)	TABLE ANGLE (Degree)	REMARK
*5714	66.99	57.84	68.2	-1.21	34.61	8.65	34.11	101	170	Peak
*5722	67.61	58.45	78.2	-10.59	34.62	8.65	34.11	101	170	Peak
5755	94.12	84.91			34.66	8.66	34.11	106	170	Average
5755	100.92	91.71			34.66	8.66	34.11	106	170	Peak
*5852	59.85	50.55	78.2	-18.35	34.74	8.7	34.14	106	170	Peak
*5868	59.52	50.19	68.2	-8.68	34.76	8.71	34.14	106	170	Peak

REMARKS:

- Emission Level = Read Level + Antenna Factor + Cable Loss - Preamp Factor
Margin value = Emission level – Limit value
- 5755MHz: Fundamental frequency.
- *: Out of restricted band



EUT TEST CONDITION		MEASUREMENT DETAIL	
CHANNEL	Channel 159	FREQUENCY RANGE	1GHz ~ 40GHz
INPUT POWER	120Vac, 60 Hz	DETECTOR FUNCTION	Peak (PK) Average (AV)
ENVIRONMENTAL CONDITIONS	25deg. C, 65%RH	TESTED BY	Karl Lee

ANTENNA POLARITY & TEST DISTANCE: HORIZONTAL AT 3 M										
FREQ. (MHz)	EMISSION LEVEL (dBuV/m)	READ LEVEL (dBuV)	LIMIT (dBuV/m)	MARGIN (dB)	ANTENNA FACTOR (dB/m)	CABLE LOSS (dB)	PREAMP FACTOR (dB)	ANTENNA HEIGHT (cm)	TABLE ANGLE (Degree)	REMARK
*5706	59.47	50.32	68.2	-8.73	34.61	8.65	34.11	196	202	Peak
*5720	60.54	51.38	78.2	-17.66	34.62	8.65	34.11	196	202	Peak
5795	94.37	85.13			34.69	8.68	34.13	196	202	Average
5795	101.85	92.61			34.69	8.68	34.13	196	202	Peak
*5852	61.19	51.89	78.2	-17.01	34.74	8.7	34.14	196	202	Peak
*5862	60.75	51.42	68.2	-7.45	34.76	8.71	34.14	196	202	Peak
ANTENNA POLARITY & TEST DISTANCE: VERTICAL AT 3 M										
FREQ. (MHz)	EMISSION LEVEL (dBuV/m)	READ LEVEL (dBuV)	LIMIT (dBuV/m)	MARGIN (dB)	ANTENNA FACTOR (dB/m)	CABLE LOSS (dB)	PREAMP FACTOR (dB)	ANTENNA HEIGHT (cm)	TABLE ANGLE (Degree)	REMARK
*5708	58.69	49.54	68.2	-9.51	34.61	8.65	34.11	111	342	Peak
*5724	59.06	49.9	78.2	-19.14	34.62	8.65	34.11	111	342	Peak
5795	95.47	86.23			34.69	8.68	34.13	111	342	Average
5795	102.37	93.13			34.69	8.68	34.13	111	342	Peak
*5858	60.44	51.12	78.2	-17.76	34.76	8.7	34.14	111	342	Peak
*5866	58.27	48.94	68.2	-9.93	34.76	8.71	34.14	111	342	Peak

REMARKS:

- Emission Level = Read Level + Antenna Factor + Cable Loss - Preamp Factor
Margin value = Emission level – Limit value
- 5795MHz: Fundamental frequency.
- *: Out of restricted band

802.11ac (80MHz)

EUT TEST CONDITION		MEASUREMENT DETAIL	
CHANNEL	Channel 42	FREQUENCY RANGE	1GHz ~ 40GHz
INPUT POWER	120Vac, 60 Hz	DETECTOR FUNCTION	Peak (PK) Average (AV)
ENVIRONMENTAL CONDITIONS	25deg. C, 65%RH	TESTED BY	Karl Lee

ANTENNA POLARITY & TEST DISTANCE: HORIZONTAL AT 3 M

FREQ. (MHz)	EMISSION LEVEL (dBuV/m)	READ LEVEL (dBuV)	LIMIT (dBuV/m)	MARGIN (dB)	ANTENNA FACTOR (dB/m)	CABLE LOSS (dB)	PREAMP FACTOR (dB)	ANTENNA HEIGHT (cm)	TABLE ANGLE (Degree)	REMARK
5148	53	44.75	54	-18.47	34.12	8.13	34	180	76	Average
5148	64.48	56.23	74	-15.44	34.12	8.13	34	180	76	Peak
5210	91.47	83.11			34.17	8.19	34	174	76	Average
5210	99.92	91.56			34.17	8.19	34	174	76	Peak
5376	44.31	35.65	54	-27.16	34.29	8.41	34.04	174	76	Average
5376	59.75	51.09	74	-20.17	34.29	8.41	34.04	174	76	Peak

ANTENNA POLARITY & TEST DISTANCE: VERTICAL AT 3 M

FREQ. (MHz)	EMISSION LEVEL (dBuV/m)	READ LEVEL (dBuV)	LIMIT (dBuV/m)	MARGIN (dB)	ANTENNA FACTOR (dB/m)	CABLE LOSS (dB)	PREAMP FACTOR (dB)	ANTENNA HEIGHT (cm)	TABLE ANGLE (Degree)	REMARK
5138	52.45	44.2	54	-18.12	34.11	8.13	33.99	190	88	Average
5138	64.23	55.98	74	-13.94	34.11	8.13	33.99	190	88	Peak
5210	90.57	82.21			34.17	8.19	34	187	92	Average
5210	98.17	89.81			34.17	8.19	34	187	92	Peak
5446	44.07	35.24	54	-26.5	34.36	8.51	34.04	187	92	Average
5446	59.66	50.83	74	-18.51	34.36	8.51	34.04	187	92	Peak

REMARKS:

- Emission Level = Read Level + Antenna Factor + Cable Loss - Preamp Factor
Margin value = Emission level – Limit value
- 5210MHz: Fundamental frequency.

EUT TEST CONDITION		MEASUREMENT DETAIL	
CHANNEL	Channel 58	FREQUENCY RANGE	1GHz ~ 40GHz
INPUT POWER	120Vac, 60 Hz	DETECTOR FUNCTION	Peak (PK) Average (AV)
ENVIRONMENTAL CONDITIONS	25deg. C, 65%RH	TESTED BY	Karl Lee

ANTENNA POLARITY & TEST DISTANCE: HORIZONTAL AT 3 M										
FREQ. (MHz)	EMISSION LEVEL (dBuV/m)	READ LEVEL (dBuV)	LIMIT (dBuV/m)	MARGIN (dB)	ANTENNA FACTOR (dB/m)	CABLE LOSS (dB)	PREAMP FACTOR (dB)	ANTENNA HEIGHT (cm)	TABLE ANGLE (Degree)	REMARK
5146	46.25	38	54	-7.75	34.12	8.13	34	163	307	Average
5146	58.88	50.63	74	-15.12	34.12	8.13	34	163	307	Peak
5290	94.44	85.91			34.23	8.32	34.02	163	307	Average
5290	101.42	92.89			34.23	8.32	34.02	163	307	Peak
5350	50.31	41.68	54	-3.69	34.28	8.38	34.03	164	307	Average
5350	62.7	54.07	74	-11.3	34.28	8.38	34.03	164	307	Peak
ANTENNA POLARITY & TEST DISTANCE: VERTICAL AT 3 M										
FREQ. (MHz)	EMISSION LEVEL (dBuV/m)	READ LEVEL (dBuV)	LIMIT (dBuV/m)	MARGIN (dB)	ANTENNA FACTOR (dB/m)	CABLE LOSS (dB)	PREAMP FACTOR (dB)	ANTENNA HEIGHT (cm)	TABLE ANGLE (Degree)	REMARK
5140	45.35	37.09	54	-8.65	34.12	8.13	33.99	233	266	Average
5140	59.36	51.1	74	-14.64	34.12	8.13	33.99	233	266	Peak
5290	93.24	84.71			34.23	8.32	34.02	233	266	Average
5290	100.69	92.16			34.23	8.32	34.02	233	266	Peak
5356	49.66	41.03	54	-4.34	34.28	8.38	34.03	235	266	Average
5356	61.6	52.97	74	-12.4	34.28	8.38	34.03	235	266	Peak

REMARKS:

- Emission Level = Read Level + Antenna Factor + Cable Loss - Preamp Factor
Margin value = Emission level – Limit value
- 5290MHz: Fundamental frequency.



EUT TEST CONDITION		MEASUREMENT DETAIL	
CHANNEL	Channel 106	FREQUENCY RANGE	1GHz ~ 40GHz
INPUT POWER	120Vac, 60 Hz	DETECTOR FUNCTION	Peak (PK) Average (AV)
ENVIRONMENTAL CONDITIONS	25deg. C, 65%RH	TESTED BY	Karl Lee

ANTENNA POLARITY & TEST DISTANCE: HORIZONTAL AT 3 M										
FREQ. (MHz)	EMISSION LEVEL (dBuV/m)	READ LEVEL (dBuV)	LIMIT (dBuV/m)	MARGIN (dB)	ANTENNA FACTOR (dB/m)	CABLE LOSS (dB)	PREAMP FACTOR (dB)	ANTENNA HEIGHT (cm)	TABLE ANGLE (Degree)	REMARK
5454	50.46	41.64	54	-3.54	34.36	8.51	34.05	100	112	Average
5454	62.32	53.5	74	-11.68	34.36	8.51	34.05	100	112	Peak
5470	61.55	52.72	68.2	-6.65	34.37	8.51	34.05	100	112	Peak
5530	89.09	80.16			34.42	8.58	34.07	100	112	Average
5530	96.07	87.14			34.42	8.58	34.07	100	112	Peak
5725	58.61	49.45	68.2	-9.59	34.62	8.65	34.11	100	112	Peak
ANTENNA POLARITY & TEST DISTANCE: VERTICAL AT 3 M										
FREQ. (MHz)	EMISSION LEVEL (dBuV/m)	READ LEVEL (dBuV)	LIMIT (dBuV/m)	MARGIN (dB)	ANTENNA FACTOR (dB/m)	CABLE LOSS (dB)	PREAMP FACTOR (dB)	ANTENNA HEIGHT (cm)	TABLE ANGLE (Degree)	REMARK
5452	51.92	43.1	54	-2.08	34.36	8.51	34.05	137	199	Average
5452	63.31	54.49	74	-10.69	34.36	8.51	34.05	137	199	Peak
5470	66.64	57.81	68.2	-1.56	34.37	8.51	34.05	137	199	Peak
5530	89.76	80.83			34.42	8.58	34.07	111	350	Average
5530	97.69	88.76			34.42	8.58	34.07	111	350	Peak
5725	59.22	50.06	68.2	-8.98	34.62	8.65	34.11	111	350	Peak

REMARKS:

- Emission Level = Read Level + Antenna Factor + Cable Loss - Preamp Factor
Margin value = Emission level – Limit value
- 5530MHz: Fundamental frequency.
- 5470MHz & 5725MHz: Out of restricted band



EUT TEST CONDITION		MEASUREMENT DETAIL	
CHANNEL	Channel 122	FREQUENCY RANGE	1GHz ~ 40GHz
INPUT POWER	120Vac, 60 Hz	DETECTOR FUNCTION	Peak (PK) Average (AV)
ENVIRONMENTAL CONDITIONS	25deg. C, 65%RH	TESTED BY	Karl Lee

ANTENNA POLARITY & TEST DISTANCE: HORIZONTAL AT 3 M										
FREQ. (MHz)	EMISSION LEVEL (dBuV/m)	READ LEVEL (dBuV)	LIMIT (dBuV/m)	MARGIN (dB)	ANTENNA FACTOR (dB/m)	CABLE LOSS (dB)	PREAMP FACTOR (dB)	ANTENNA HEIGHT (cm)	TABLE ANGLE (Degree)	REMARK
5458	46.17	37.35	54	-7.83	34.36	8.51	34.05	159	169	Average
5458	61.64	52.82	74	-12.36	34.36	8.51	34.05	159	169	Peak
5470	58.47	49.64	68.2	-9.73	34.37	8.51	34.05	159	169	Peak
5610	93.21	84.18			34.5	8.61	34.08	159	169	Average
5610	100.76	91.73			34.5	8.61	34.08	159	169	Peak
5725	60.32	51.16	68.2	-7.88	34.62	8.65	34.11	159	169	Peak

ANTENNA POLARITY & TEST DISTANCE: VERTICAL AT 3 M										
FREQ. (MHz)	EMISSION LEVEL (dBuV/m)	READ LEVEL (dBuV)	LIMIT (dBuV/m)	MARGIN (dB)	ANTENNA FACTOR (dB/m)	CABLE LOSS (dB)	PREAMP FACTOR (dB)	ANTENNA HEIGHT (cm)	TABLE ANGLE (Degree)	REMARK
5430	44.72	35.93	54	-9.28	34.35	8.48	34.04	142	169	Average
5430	59.29	50.5	74	-14.71	34.35	8.48	34.04	142	169	Peak
5470	59.41	50.58	68.2	-8.79	34.37	8.51	34.05	142	169	Peak
5610	94.91	85.88			34.5	8.61	34.08	142	169	Average
5610	101.8	92.77			34.5	8.61	34.08	142	169	Peak
5725	59.23	50.07	68.2	-8.97	34.62	8.65	34.11	142	169	Peak

REMARKS:

- Emission Level = Read Level + Antenna Factor + Cable Loss - Preamp Factor
Margin value = Emission level – Limit value
- 5610MHz: Fundamental frequency.
- 5470MHz & 5725MHz: Out of restricted band

EUT TEST CONDITION		MEASUREMENT DETAIL	
CHANNEL	Channel 155	FREQUENCY RANGE	1GHz ~ 40GHz
INPUT POWER	120Vac, 60 Hz	DETECTOR FUNCTION	Peak (PK) Average (AV)
ENVIRONMENTAL CONDITIONS	25deg. C, 65%RH	TESTED BY	Karl Lee

ANTENNA POLARITY & TEST DISTANCE: HORIZONTAL AT 3 M										
FREQ. (MHz)	EMISSION LEVEL (dBuV/m)	READ LEVEL (dBuV)	LIMIT (dBuV/m)	MARGIN (dB)	ANTENNA FACTOR (dB/m)	CABLE LOSS (dB)	PREAMP FACTOR (dB)	ANTENNA HEIGHT (cm)	TABLE ANGLE (Degree)	REMARK
*5706	67.44	58.29	68.2	-0.76	34.61	8.65	34.11	132	202	Peak
*5718	67.8	58.64	78.2	-10.4	34.62	8.65	34.11	132	202	Peak
5775	90.25	81.02			34.68	8.67	34.12	146	202	Average
5775	96.58	87.35			34.68	8.67	34.12	146	202	Peak
*5852	60.04	50.74	78.2	-18.16	34.74	8.7	34.14	146	202	Peak
*5868	58.93	49.6	68.2	-9.27	34.76	8.71	34.14	146	202	Peak
ANTENNA POLARITY & TEST DISTANCE: VERTICAL AT 3 M										
FREQ. (MHz)	EMISSION LEVEL (dBuV/m)	READ LEVEL (dBuV)	LIMIT (dBuV/m)	MARGIN (dB)	ANTENNA FACTOR (dB/m)	CABLE LOSS (dB)	PREAMP FACTOR (dB)	ANTENNA HEIGHT (cm)	TABLE ANGLE (Degree)	REMARK
*5712	67.13	57.98	68.2	-1.07	34.61	8.65	34.11	100	342	Peak
*5724	68.58	59.42	78.2	-9.62	34.62	8.65	34.11	100	342	Peak
5775	91.2	81.97			34.68	8.67	34.12	111	342	Average
5775	97.75	88.52			34.68	8.67	34.12	111	342	Peak
*5856	59.27	49.95	78.2	-18.93	34.76	8.7	34.14	111	342	Peak
*5862	59.62	50.29	68.2	-8.58	34.76	8.71	34.14	111	342	Peak

REMARKS:

- Emission Level = Read Level + Antenna Factor + Cable Loss - Preamp Factor
Margin value = Emission level – Limit value
- 5775MHz: Fundamental frequency.
- *: Out of restricted band

Mode A (1Tx)
802.11a

EUT TEST CONDITION		MEASUREMENT DETAIL	
CHANNEL	Channel 36	FREQUENCY RANGE	1GHz ~ 40GHz
INPUT POWER	120Vac, 60 Hz	DETECTOR FUNCTION	Peak (PK) Average (AV)
ENVIRONMENTAL CONDITIONS	25deg. C, 65%RH	TESTED BY	Karl Lee

ANTENNA POLARITY & TEST DISTANCE: HORIZONTAL AT 3 M										
FREQ. (MHz)	EMISSION LEVEL (dBuV/m)	READ LEVEL (dBuV)	LIMIT (dBuV/m)	MARGIN (dB)	ANTENNA FACTOR (dB/m)	CABLE LOSS (dB)	PREAMP FACTOR (dB)	ANTENNA HEIGHT (cm)	TABLE ANGLE (Degree)	REMARK
5150	51.25	43	54	-2.75	34.12	8.13	34	155	112	Average
5150	64.94	56.69	74	-9.06	34.12	8.13	34	155	112	Peak
5180	98.41	90.1			34.15	8.16	34	155	112	Average
5180	105.41	97.1			34.15	8.16	34	155	112	Peak
5352	43.96	35.33	54	-10.04	34.28	8.38	34.03	155	112	Average
5352	58.6	49.97	74	-15.4	34.28	8.38	34.03	155	112	Peak

ANTENNA POLARITY & TEST DISTANCE: VERTICAL AT 3 M										
FREQ. (MHz)	EMISSION LEVEL (dBuV/m)	READ LEVEL (dBuV)	LIMIT (dBuV/m)	MARGIN (dB)	ANTENNA FACTOR (dB/m)	CABLE LOSS (dB)	PREAMP FACTOR (dB)	ANTENNA HEIGHT (cm)	TABLE ANGLE (Degree)	REMARK
5142	50.35	42.09	54	-3.65	34.12	8.13	33.99	113	177	Average
5142	63.15	54.89	74	-10.85	34.12	8.13	33.99	113	177	Peak
5180	96.71	88.4			34.15	8.16	34	113	177	Average
5180	103.49	95.18			34.15	8.16	34	113	177	Peak
5440	42.57	33.78	54	-11.43	34.35	8.48	34.04	113	177	Average
5440	58.52	49.73	74	-15.48	34.35	8.48	34.04	113	177	Peak

REMARKS:

- Emission Level = Read Level + Antenna Factor + Cable Loss - Preamp Factor
Margin value = Emission level – Limit value
- 5180MHz: Fundamental frequency.

802.11a

EUT TEST CONDITION		MEASUREMENT DETAIL	
CHANNEL	Channel 64	FREQUENCY RANGE	1GHz ~ 40GHz
INPUT POWER	120Vac, 60 Hz	DETECTOR FUNCTION	Peak (PK) Average (AV)
ENVIRONMENTAL CONDITIONS	25deg. C, 65%RH	TESTED BY	Karl Lee

ANTENNA POLARITY & TEST DISTANCE: HORIZONTAL AT 3 M

FREQ. (MHz)	EMISSION LEVEL (dBuV/m)	READ LEVEL (dBuV)	LIMIT (dBuV/m)	MARGIN (dB)	ANTENNA FACTOR (dB/m)	CABLE LOSS (dB)	PREAMP FACTOR (dB)	ANTENNA HEIGHT (cm)	TABLE ANGLE (Degree)	REMARK
5054	42.44	34.38	54	-11.56	34.04	8	33.98	176	77	Average
5054	56.31	48.25	74	-17.69	34.04	8	33.98	176	77	Peak
5320	98.9	90.32			34.25	8.35	34.02	176	77	Average
5320	106.38	97.8			34.25	8.35	34.02	176	77	Peak
5350	50.76	42.13	54	-3.24	34.28	8.38	34.03	176	77	Average
5350	63.75	55.12	74	-10.25	34.28	8.38	34.03	176	77	Peak

ANTENNA POLARITY & TEST DISTANCE: VERTICAL AT 3 M

FREQ. (MHz)	EMISSION LEVEL (dBuV/m)	READ LEVEL (dBuV)	LIMIT (dBuV/m)	MARGIN (dB)	ANTENNA FACTOR (dB/m)	CABLE LOSS (dB)	PREAMP FACTOR (dB)	ANTENNA HEIGHT (cm)	TABLE ANGLE (Degree)	REMARK
5052	42.37	34.31	54	-11.63	34.04	8	33.98	126	338	Average
5052	56.6	48.54	74	-17.4	34.04	8	33.98	126	338	Peak
5320	96.6	88.02			34.25	8.35	34.02	126	338	Average
5320	104.11	95.53			34.25	8.35	34.02	126	338	Peak
5350	50.08	41.45	54	-3.92	34.28	8.38	34.03	126	338	Average
5350	62.34	53.71	74	-11.66	34.28	8.38	34.03	126	338	Peak

REMARKS:

- Emission Level = Read Level + Antenna Factor + Cable Loss - Preamp Factor
Margin value = Emission level – Limit value
- 5320MHz: Fundamental frequency.

802.11a

EUT TEST CONDITION		MEASUREMENT DETAIL	
CHANNEL	Channel 140	FREQUENCY RANGE	1GHz ~ 40GHz
INPUT POWER	120Vac, 60 Hz	DETECTOR FUNCTION	Peak (PK) Average (AV)
ENVIRONMENTAL CONDITIONS	25deg. C, 65%RH	TESTED BY	Karl Lee

ANTENNA POLARITY & TEST DISTANCE: HORIZONTAL AT 3 M										
FREQ. (MHz)	EMISSION LEVEL (dBuV/m)	READ LEVEL (dBuV)	LIMIT (dBuV/m)	MARGIN (dB)	ANTENNA FACTOR (dB/m)	CABLE LOSS (dB)	PREAMP FACTOR (dB)	ANTENNA HEIGHT (cm)	TABLE ANGLE (Degree)	REMARK
5460	42.77	33.95	54	-11.23	34.36	8.51	34.05	112	172	Average
5460	57.02	48.2	74	-16.98	34.36	8.51	34.05	112	172	Peak
5470	55.74	46.91	68.2	-12.46	34.37	8.51	34.05	112	172	Peak
5700	96.63	87.5			34.59	8.64	34.1	112	172	Average
5700	103.68	94.55			34.59	8.64	34.1	112	172	Peak
5725	66.54	57.38	68.2	-1.66	34.62	8.65	34.11	112	172	Peak

ANTENNA POLARITY & TEST DISTANCE: VERTICAL AT 3 M										
FREQ. (MHz)	EMISSION LEVEL (dBuV/m)	READ LEVEL (dBuV)	LIMIT (dBuV/m)	MARGIN (dB)	ANTENNA FACTOR (dB/m)	CABLE LOSS (dB)	PREAMP FACTOR (dB)	ANTENNA HEIGHT (cm)	TABLE ANGLE (Degree)	REMARK
5384	42.72	34.04	54	-11.28	34.31	8.41	34.04	200	95	Average
5384	57.56	48.88	74	-16.44	34.31	8.41	34.04	200	95	Peak
5470	55.98	47.15	68.2	-12.22	34.37	8.51	34.05	200	95	Peak
5700	97.53	88.4			34.59	8.64	34.1	200	95	Average
5700	105.09	95.96			34.59	8.64	34.1	200	95	Peak
5725	66.82	57.66	68.2	-1.38	34.62	8.65	34.11	200	95	Peak

REMARKS:

- Emission Level = Read Level + Antenna Factor + Cable Loss - Preamp Factor
Margin value = Emission level – Limit value
- 5700MHz: Fundamental frequency.
- 5470MHz & 5725MHz: Out of restricted band

802.11n (20MHz)

EUT TEST CONDITION		MEASUREMENT DETAIL	
CHANNEL	Channel 165	FREQUENCY RANGE	1GHz ~ 40GHz
INPUT POWER	120Vac, 60 Hz	DETECTOR FUNCTION	Peak (PK) Average (AV)
ENVIRONMENTAL CONDITIONS	25deg. C, 65%RH	TESTED BY	Karl Lee

ANTENNA POLARITY & TEST DISTANCE: HORIZONTAL AT 3 M

FREQ. (MHz)	EMISSION LEVEL (dBuV/m)	READ LEVEL (dBuV)	LIMIT (dBuV/m)	MARGIN (dB)	ANTENNA FACTOR (dB/m)	CABLE LOSS (dB)	PREAMP FACTOR (dB)	ANTENNA HEIGHT (cm)	TABLE ANGLE (Degree)	REMARK
*5708	56.21	47.06	68.2	-11.99	34.61	8.65	34.11	200	169	Peak
*5722	56.84	47.68	78.2	-21.36	34.62	8.65	34.11	200	169	Peak
5825	99.62	90.33			34.73	8.69	34.13	200	169	Average
5825	106.54	97.25			34.73	8.69	34.13	200	169	Peak
*5852	71.21	61.91	78.2	-6.99	34.74	8.7	34.14	200	169	Peak
*5866	66.36	57.03	68.2	-1.84	34.76	8.71	34.14	200	169	Peak

ANTENNA POLARITY & TEST DISTANCE: VERTICAL AT 3 M

FREQ. (MHz)	EMISSION LEVEL (dBuV/m)	READ LEVEL (dBuV)	LIMIT (dBuV/m)	MARGIN (dB)	ANTENNA FACTOR (dB/m)	CABLE LOSS (dB)	PREAMP FACTOR (dB)	ANTENNA HEIGHT (cm)	TABLE ANGLE (Degree)	REMARK
*5710	55.79	46.64	68.2	-12.41	34.61	8.65	34.11	100	168	Peak
*5716	56.65	47.5	78.2	-21.55	34.61	8.65	34.11	100	168	Peak
5825	98.12	88.83			34.73	8.69	34.13	100	168	Average
5825	104.53	95.24			34.73	8.69	34.13	100	168	Peak
*5852	68.29	58.99	78.2	-9.91	34.74	8.7	34.14	100	168	Peak
*5862	62.21	52.88	68.2	-5.99	34.76	8.71	34.14	100	168	Peak

REMARKS:

- Emission Level = Read Level + Antenna Factor + Cable Loss - Preamp Factor
Margin value = Emission level – Limit value
- 5825MHz: Fundamental frequency.
- *: Out of restricted band

Mode A (2Tx)
802.11ac (80MHz)

EUT TEST CONDITION		MEASUREMENT DETAIL	
CHANNEL	Channel 42	FREQUENCY RANGE	1GHz ~ 40GHz
INPUT POWER	120Vac, 60 Hz	DETECTOR FUNCTION	Peak (PK) Average (AV)
ENVIRONMENTAL CONDITIONS	25deg. C, 65%RH	TESTED BY	Karl Lee

ANTENNA POLARITY & TEST DISTANCE: HORIZONTAL AT 3 M										
FREQ. (MHz)	EMISSION LEVEL (dBuV/m)	READ LEVEL (dBuV)	LIMIT (dBuV/m)	MARGIN (dB)	ANTENNA FACTOR (dB/m)	CABLE LOSS (dB)	PREAMP FACTOR (dB)	ANTENNA HEIGHT (cm)	TABLE ANGLE (Degree)	REMARK
5148	52.94	44.69	54	-1.06	34.12	8.13	34	149	110	Average
5148	63.53	55.28	74	-10.47	34.12	8.13	34	149	110	Peak
5210	91.37	83.01			34.17	8.19	34	124	110	Average
5210	98.48	90.12			34.17	8.19	34	124	110	Peak
5350	43.66	35.03	54	-10.34	34.28	8.38	34.03	124	110	Average
5350	58.38	49.75	74	-15.62	34.28	8.38	34.03	124	110	Peak

ANTENNA POLARITY & TEST DISTANCE: VERTICAL AT 3 M										
FREQ. (MHz)	EMISSION LEVEL (dBuV/m)	READ LEVEL (dBuV)	LIMIT (dBuV/m)	MARGIN (dB)	ANTENNA FACTOR (dB/m)	CABLE LOSS (dB)	PREAMP FACTOR (dB)	ANTENNA HEIGHT (cm)	TABLE ANGLE (Degree)	REMARK
5128	52.92	44.7	54	-1.08	34.11	8.1	33.99	185	96	Average
5128	63.06	54.84	74	-10.94	34.11	8.1	33.99	185	96	Peak
5210	90.02	81.66			34.17	8.19	34	199	96	Average
5210	97.45	89.09			34.17	8.19	34	199	96	Peak
5372	43.71	35.04	54	-10.29	34.29	8.41	34.03	199	96	Average
5372	57.75	49.08	74	-16.25	34.29	8.41	34.03	199	96	Peak

REMARKS:

- Emission Level = Read Level + Antenna Factor + Cable Loss - Preamp Factor
Margin value = Emission level – Limit value
- 5210MHz: Fundamental frequency.

802.11n (20MHz)

EUT TEST CONDITION		MEASUREMENT DETAIL	
CHANNEL	Channel 64	FREQUENCY RANGE	1GHz ~ 40GHz
INPUT POWER	120Vac, 60 Hz	DETECTOR FUNCTION	Peak (PK) Average (AV)
ENVIRONMENTAL CONDITIONS	25deg. C, 65%RH	TESTED BY	Karl Lee

ANTENNA POLARITY & TEST DISTANCE: HORIZONTAL AT 3 M										
FREQ. (MHz)	EMISSION LEVEL (dBuV/m)	READ LEVEL (dBuV)	LIMIT (dBuV/m)	MARGIN (dB)	ANTENNA FACTOR (dB/m)	CABLE LOSS (dB)	PREAMP FACTOR (dB)	ANTENNA HEIGHT (cm)	TABLE ANGLE (Degree)	REMARK
5052	42.59	34.53	54	-11.41	34.04	8	33.98	102	76	Average
5052	58.51	50.45	74	-15.49	34.04	8	33.98	102	76	Peak
5320	101	92.42			34.25	8.35	34.02	102	76	Average
5320	108.96	100.38			34.25	8.35	34.02	102	76	Peak
5350	53.25	44.62	54	-0.75	34.28	8.38	34.03	101	114	Average
5350	66.08	57.45	74	-7.92	34.28	8.38	34.03	101	114	Peak
ANTENNA POLARITY & TEST DISTANCE: VERTICAL AT 3 M										
FREQ. (MHz)	EMISSION LEVEL (dBuV/m)	READ LEVEL (dBuV)	LIMIT (dBuV/m)	MARGIN (dB)	ANTENNA FACTOR (dB/m)	CABLE LOSS (dB)	PREAMP FACTOR (dB)	ANTENNA HEIGHT (cm)	TABLE ANGLE (Degree)	REMARK
5096	42.7	34.54	54	-11.3	34.08	8.07	33.99	144	273	Average
5096	59.01	50.85	74	-14.99	34.08	8.07	33.99	144	273	Peak
5320	100.2	91.62			34.25	8.35	34.02	144	273	Average
5320	107.98	99.4			34.25	8.35	34.02	144	273	Peak
5350	53.26	44.63	54	-0.74	34.28	8.38	34.03	150	273	Average
5350	66.76	58.13	74	-7.24	34.28	8.38	34.03	150	273	Peak

REMARKS:

- Emission Level = Read Level + Antenna Factor + Cable Loss - Preamp Factor
Margin value = Emission level – Limit value
- 5320MHz: Fundamental frequency.

802.11n (20MHz)

EUT TEST CONDITION		MEASUREMENT DETAIL	
CHANNEL	Channel 140	FREQUENCY RANGE	1GHz ~ 40GHz
INPUT POWER	120Vac, 60 Hz	DETECTOR FUNCTION	Peak (PK) Average (AV)
ENVIRONMENTAL CONDITIONS	25deg. C, 65%RH	TESTED BY	Karl Lee

ANTENNA POLARITY & TEST DISTANCE: HORIZONTAL AT 3 M

FREQ. (MHz)	EMISSION LEVEL (dBuV/m)	READ LEVEL (dBuV)	LIMIT (dBuV/m)	MARGIN (dB)	ANTENNA FACTOR (dB/m)	CABLE LOSS (dB)	PREAMP FACTOR (dB)	ANTENNA HEIGHT (cm)	TABLE ANGLE (Degree)	REMARK
5460	42.87	34.05	54	-11.13	34.36	8.51	34.05	171	44	Average
5460	58.13	49.31	74	-15.87	34.36	8.51	34.05	171	44	Peak
5470	55.21	46.38	68.2	-12.99	34.37	8.51	34.05	171	44	Peak
5700	96.23	87.1			34.59	8.64	34.1	171	44	Average
5700	104.49	95.36			34.59	8.64	34.1	171	44	Peak
5725	66.69	57.53	68.2	-1.51	34.62	8.65	34.11	176	44	Peak

ANTENNA POLARITY & TEST DISTANCE: VERTICAL AT 3 M

FREQ. (MHz)	EMISSION LEVEL (dBuV/m)	READ LEVEL (dBuV)	LIMIT (dBuV/m)	MARGIN (dB)	ANTENNA FACTOR (dB/m)	CABLE LOSS (dB)	PREAMP FACTOR (dB)	ANTENNA HEIGHT (cm)	TABLE ANGLE (Degree)	REMARK
5440	42.72	33.93	54	-11.28	34.35	8.48	34.04	192	345	Average
5440	57.71	48.92	74	-16.29	34.35	8.48	34.04	192	345	Peak
5470	57.13	48.3	68.2	-11.07	34.37	8.51	34.05	192	345	Peak
5700	97.08	87.95			34.59	8.64	34.1	192	345	Average
5700	105.61	96.48			34.59	8.64	34.1	192	345	Peak
5725	67.19	58.03	68.2	-1.01	34.62	8.65	34.11	124	345	Peak

REMARKS:

- Emission Level = Read Level + Antenna Factor + Cable Loss - Preamp Factor
Margin value = Emission level – Limit value
- 5700MHz: Fundamental frequency.
- 5470MHz & 5725MHz: Out of restricted band

802.11ac (80MHz)

EUT TEST CONDITION		MEASUREMENT DETAIL	
CHANNEL	Channel 155	FREQUENCY RANGE	1GHz ~ 40GHz
INPUT POWER	120Vac, 60 Hz	DETECTOR FUNCTION	Peak (PK) Average (AV)
ENVIRONMENTAL CONDITIONS	25deg. C, 65%RH	TESTED BY	Karl Lee

ANTENNA POLARITY & TEST DISTANCE: HORIZONTAL AT 3 M

FREQ. (MHz)	EMISSION LEVEL (dBuV/m)	READ LEVEL (dBuV)	LIMIT (dBuV/m)	MARGIN (dB)	ANTENNA FACTOR (dB/m)	CABLE LOSS (dB)	PREAMP FACTOR (dB)	ANTENNA HEIGHT (cm)	TABLE ANGLE (Degree)	REMARK
*5710	64.53	55.38	68.2	-3.67	34.61	8.65	34.11	200	308	Peak
*5724	65.18	56.02	78.2	-13.02	34.62	8.65	34.11	200	308	Peak
5775	90.67	81.44			34.68	8.67	34.12	200	340	Average
5775	98.33	89.1			34.68	8.67	34.12	200	340	Peak
*5860	58.75	49.43	78.2	-19.45	34.76	8.7	34.14	200	340	Peak
*5868	58.14	48.81	68.2	-10.06	34.76	8.71	34.14	200	340	Peak

ANTENNA POLARITY & TEST DISTANCE: VERTICAL AT 3 M

FREQ. (MHz)	EMISSION LEVEL (dBuV/m)	READ LEVEL (dBuV)	LIMIT (dBuV/m)	MARGIN (dB)	ANTENNA FACTOR (dB/m)	CABLE LOSS (dB)	PREAMP FACTOR (dB)	ANTENNA HEIGHT (cm)	TABLE ANGLE (Degree)	REMARK
*5712	66.35	57.2	68.2	-1.85	34.61	8.65	34.11	201	275	Peak
*5722	68.22	59.06	78.2	-9.98	34.62	8.65	34.11	201	274	Peak
5775	92.6	83.37			34.68	8.67	34.12	190	272	Average
5775	99.65	90.42			34.68	8.67	34.12	190	272	Peak
*5852	58.94	49.64	78.2	-19.26	34.74	8.7	34.14	190	272	Peak
*5862	58.76	49.43	68.2	-9.44	34.76	8.71	34.14	190	272	Peak

REMARKS:

- Emission Level = Read Level + Antenna Factor + Cable Loss - Preamp Factor
Margin value = Emission level – Limit value
- 5775MHz: Fundamental frequency.
- *: Out of restricted band

**BELOW 1GHz WORST-CASE DATA:****Mode B****802.11a**

EUT TEST CONDITION		MEASUREMENT DETAIL	
CHANNEL	Channel 36	FREQUENCY RANGE	30MHz ~ 1GHz
INPUT POWER	120Vac, 60 Hz	DETECTOR FUNCTION	Peak (PK) Quasi-peak (QP)
ENVIRONMENTAL CONDITIONS	25deg. C, 65%RH	TESTED BY	Karl Lee

ANTENNA POLARITY & TEST DISTANCE: HORIZONTAL AT 3 M

FREQ. (MHz)	EMISSION LEVEL (dBuV/m)	READ LEVEL (dBuV)	LIMIT (dBuV/m)	MARGIN (dB)	ANTENNA FACTOR (dB/m)	CABLE LOSS (dB)	PREAMP FACTOR (dB)	ANTENNA HEIGHT (cm)	TABLE ANGLE (Degree)	REMARK
163.11	27.87	48.03	43.5	-15.63	10.58	1.52	32.26	161	11	Peak
206.31	35.54	54.99	43.5	-7.96	11.17	1.65	32.27	105	239	QP
271.11	27.21	43.76	46	-18.79	13.62	1.94	32.11	127	207	Peak
533.1	40.04	48.94	46	-5.96	20.57	2.7	32.17	140	4	Peak
710.9	35.63	41.39	46	-10.37	23.23	3.11	32.1	171	109	Peak
883.8	33.52	36.73	46	-12.48	24.88	3.49	31.58	188	348	Peak

ANTENNA POLARITY & TEST DISTANCE: VERTICAL AT 3 M

FREQ. (MHz)	EMISSION LEVEL (dBuV/m)	READ LEVEL (dBuV)	LIMIT (dBuV/m)	MARGIN (dB)	ANTENNA FACTOR (dB/m)	CABLE LOSS (dB)	PREAMP FACTOR (dB)	ANTENNA HEIGHT (cm)	TABLE ANGLE (Degree)	REMARK
144.75	31.49	52.65	43.5	-12.01	9.73	1.38	32.27	144	19	Peak
206.31	37.6	57.05	43.5	-5.9	11.17	1.65	32.27	101	217	QP
278.13	25.91	42.26	46	-20.09	13.74	2.03	32.12	278	113	Peak
531.7	42.66	51.55	46	-3.34	20.57	2.7	32.16	117	153	Peak
709.5	36.1	41.86	46	-9.9	23.23	3.11	32.1	141	85	Peak
888.7	33.59	36.74	46	-12.41	24.92	3.49	31.56	124	348	Peak

REMARKS: Emission Level = Read Level + Antenna Factor + Cable Loss - Preamp Factor

Margin value = Emission level – Limit value



802.11a

EUT TEST CONDITION		MEASUREMENT DETAIL	
CHANNEL	Channel 64	FREQUENCY RANGE	30MHz ~ 1GHz
INPUT POWER	120Vac, 60 Hz	DETECTOR FUNCTION	Peak (PK) Quasi-peak (QP)
ENVIRONMENTAL CONDITIONS	25deg. C, 65%RH	TESTED BY	Karl Lee

ANTENNA POLARITY & TEST DISTANCE: HORIZONTAL AT 3 M

FREQ. (MHz)	EMISSION LEVEL (dBuV/m)	READ LEVEL (dBuV)	LIMIT (dBuV/m)	MARGIN (dB)	ANTENNA FACTOR (dB/m)	CABLE LOSS (dB)	PREAMP FACTOR (dB)	ANTENNA HEIGHT (cm)	TABLE ANGLE (Degree)	REMARK
160.95	27.46	47.48	43.5	-16.04	10.73	1.52	32.27	174	247	Peak
207.66	35.46	54.86	43.5	-8.04	11.22	1.65	32.27	103	244	QP
271.11	26.84	43.39	46	-19.16	13.62	1.94	32.11	171	111	Peak
531	39.23	48.08	46	-6.77	20.61	2.7	32.16	153	39	Peak
711.6	34.46	40.22	46	-11.54	23.23	3.11	32.1	123	228	Peak
887.3	31.35	34.5	46	-14.65	24.92	3.49	31.56	173	359	Peak

ANTENNA POLARITY & TEST DISTANCE: VERTICAL AT 3 M

FREQ. (MHz)	EMISSION LEVEL (dBuV/m)	READ LEVEL (dBuV)	LIMIT (dBuV/m)	MARGIN (dB)	ANTENNA FACTOR (dB/m)	CABLE LOSS (dB)	PREAMP FACTOR (dB)	ANTENNA HEIGHT (cm)	TABLE ANGLE (Degree)	REMARK
54.57	35.7	59.7	40	-4.3	7.33	0.9	32.23	157	222	Peak
205.23	37.16	56.65	43.5	-6.34	11.13	1.65	32.27	110	220	QP
276.24	28.53	45	46	-17.47	13.71	1.94	32.12	176	24	Peak
532.4	42.54	51.43	46	-3.46	20.57	2.7	32.16	153	24	Peak
708.1	38.75	44.55	46	-7.25	23.19	3.11	32.1	144	55	Peak
883.1	34.18	37.4	46	-11.82	24.88	3.49	31.59	154	319	Peak

REMARKS: Emission Level = Read Level + Antenna Factor + Cable Loss - Preamp Factor

Margin value = Emission level – Limit value



802.11a

EUT TEST CONDITION		MEASUREMENT DETAIL	
CHANNEL	Channel 140	FREQUENCY RANGE	30MHz ~ 1GHz
INPUT POWER	120Vac, 60 Hz	DETECTOR FUNCTION	Peak (PK) Quasi-peak (QP)
ENVIRONMENTAL CONDITIONS	25deg. C, 65%RH	TESTED BY	Karl Lee

ANTENNA POLARITY & TEST DISTANCE: HORIZONTAL AT 3 M										
FREQ. (MHz)	EMISSION LEVEL (dBuV/m)	READ LEVEL (dBuV)	LIMIT (dBuV/m)	MARGIN (dB)	ANTENNA FACTOR (dB/m)	CABLE LOSS (dB)	PREAMP FACTOR (dB)	ANTENNA HEIGHT (cm)	TABLE ANGLE (Degree)	REMARK
163.11	28.26	48.42	43.5	-15.24	10.58	1.52	32.26	161	113	Peak
206.04	35.95	55.44	43.5	-7.55	11.13	1.65	32.27	111	259	QP
272.19	27.33	43.84	46	-18.67	13.66	1.94	32.11	132	91	Peak
531	38.15	47	46	-7.85	20.61	2.7	32.16	138	153	Peak
711.6	35.59	41.35	46	-10.41	23.23	3.11	32.1	141	3	Peak
883.1	31.35	34.57	46	-14.65	24.88	3.49	31.59	131	88	Peak

ANTENNA POLARITY & TEST DISTANCE: VERTICAL AT 3 M										
FREQ. (MHz)	EMISSION LEVEL (dBuV/m)	READ LEVEL (dBuV)	LIMIT (dBuV/m)	MARGIN (dB)	ANTENNA FACTOR (dB/m)	CABLE LOSS (dB)	PREAMP FACTOR (dB)	ANTENNA HEIGHT (cm)	TABLE ANGLE (Degree)	REMARK
68.34	33.46	56.87	40	-6.54	7.91	0.9	32.22	167	33	Peak
145.02	32.37	53.53	43.5	-11.13	9.73	1.38	32.27	145	2	Peak
206.58	37.96	57.41	43.5	-5.54	11.17	1.65	32.27	104	215	QP
532.4	42.06	50.95	46	-3.94	20.57	2.7	32.16	153	42	Peak
713	36.22	41.94	46	-9.78	23.27	3.11	32.1	111	171	Peak
883.8	34.12	37.33	46	-11.88	24.88	3.49	31.58	124	348	Peak

REMARKS: Emission Level = Read Level + Antenna Factor + Cable Loss - Preamp Factor

Margin value = Emission level – Limit value

802.11n (20MHz)

EUT TEST CONDITION		MEASUREMENT DETAIL	
CHANNEL	Channel 165	FREQUENCY RANGE	30MHz ~ 1GHz
INPUT POWER	120Vac, 60 Hz	DETECTOR FUNCTION	Peak (PK) Quasi-peak (QP)
ENVIRONMENTAL CONDITIONS	25deg. C, 65%RH	TESTED BY	Karl Lee

ANTENNA POLARITY & TEST DISTANCE: HORIZONTAL AT 3 M

FREQ. (MHz)	EMISSION LEVEL (dBuV/m)	READ LEVEL (dBuV)	LIMIT (dBuV/m)	MARGIN (dB)	ANTENNA FACTOR (dB/m)	CABLE LOSS (dB)	PREAMP FACTOR (dB)	ANTENNA HEIGHT (cm)	TABLE ANGLE (Degree)	REMARK
154.2	26.1	46.46	43.5	-17.4	10.39	1.52	32.27	126	101	Peak
206.85	37.68	57.13	43.5	-5.82	11.17	1.65	32.27	102	245	QP
270.3	27.15	43.74	46	-18.85	13.58	1.94	32.11	127	170	Peak
532.4	39.41	48.3	46	-6.59	20.57	2.7	32.16	153	39	Peak
713.7	33.84	39.56	46	-12.16	23.27	3.11	32.1	133	84	Peak
888	33.27	36.42	46	-12.73	24.92	3.49	31.56	144	186	Peak

ANTENNA POLARITY & TEST DISTANCE: VERTICAL AT 3 M

FREQ. (MHz)	EMISSION LEVEL (dBuV/m)	READ LEVEL (dBuV)	LIMIT (dBuV/m)	MARGIN (dB)	ANTENNA FACTOR (dB/m)	CABLE LOSS (dB)	PREAMP FACTOR (dB)	ANTENNA HEIGHT (cm)	TABLE ANGLE (Degree)	REMARK
43.23	36.68	57.9	40	-3.32	10.1	0.9	32.22	143	23	Peak
145.56	31.95	53.05	43.5	-11.55	9.79	1.38	32.27	131	145	Peak
206.31	37.3	56.75	43.5	-6.2	11.17	1.65	32.27	109	213	QP
531.7	42.4	51.29	46	-3.6	20.57	2.7	32.16	142	40	Peak
711.6	36.19	41.95	46	-9.81	23.23	3.11	32.1	111	131	Peak
882.4	34.15	37.37	46	-11.85	24.88	3.49	31.59	188	24	Peak

REMARKS: Emission Level = Read Level + Antenna Factor + Cable Loss - Preamp Factor

Margin value = Emission level – Limit value

Mode A
802.11a

EUT TEST CONDITION		MEASUREMENT DETAIL	
CHANNEL	Channel 36	FREQUENCY RANGE	30MHz ~ 1GHz
INPUT POWER	120Vac, 60 Hz	DETECTOR FUNCTION	Peak (PK) Quasi-peak (QP)
ENVIRONMENTAL CONDITIONS	25deg. C, 65%RH	TESTED BY	Karl Lee

ANTENNA POLARITY & TEST DISTANCE: HORIZONTAL AT 3 M										
FREQ. (MHz)	EMISSION LEVEL (dBuV/m)	READ LEVEL (dBuV)	LIMIT (dBuV/m)	MARGIN (dB)	ANTENNA FACTOR (dB/m)	CABLE LOSS (dB)	PREAMP FACTOR (dB)	ANTENNA HEIGHT (cm)	TABLE ANGLE (Degree)	REMARK
145.29	33.53	54.69	43.5	-9.97	9.73	1.38	32.27	197	307	Peak
206.85	36.98	56.43	43.5	-6.52	11.17	1.65	32.27	101	210	QP
234.93	30.32	48.27	46	-15.68	12.36	1.85	32.16	131	315	Peak
533.1	40.83	49.73	46	-5.17	20.57	2.7	32.17	120	268	Peak
710.9	33.38	39.14	46	-12.62	23.23	3.11	32.1	133	39	Peak
787.9	29.79	34.55	46	-16.21	24.05	3.27	32.08	187	79	Peak

ANTENNA POLARITY & TEST DISTANCE: VERTICAL AT 3 M										
FREQ. (MHz)	EMISSION LEVEL (dBuV/m)	READ LEVEL (dBuV)	LIMIT (dBuV/m)	MARGIN (dB)	ANTENNA FACTOR (dB/m)	CABLE LOSS (dB)	PREAMP FACTOR (dB)	ANTENNA HEIGHT (cm)	TABLE ANGLE (Degree)	REMARK
146.37	34.34	55.38	43.5	-9.16	9.85	1.38	32.27	146	337	Peak
199.83	37.38	57.13	43.5	-6.12	10.9	1.65	32.3	100	235	QP
232.5	30.64	48.71	46	-15.36	12.25	1.85	32.17	132	25	Peak
533.1	42.92	51.82	46	-3.08	20.57	2.7	32.17	191	359	Peak
712.3	35.38	41.14	46	-10.62	23.23	3.11	32.1	130	311	Peak
799.8	30.98	35.12	46	-15.02	24.6	3.32	32.06	199	78	Peak

REMARKS: Emission Level = Read Level + Antenna Factor + Cable Loss - Preamp Factor
Margin value = Emission level – Limit value



802.11a

EUT TEST CONDITION		MEASUREMENT DETAIL	
CHANNEL	Channel 64	FREQUENCY RANGE	30MHz ~ 1GHz
INPUT POWER	120Vac, 60 Hz	DETECTOR FUNCTION	Peak (PK) Quasi-peak (QP)
ENVIRONMENTAL CONDITIONS	25deg. C, 65%RH	TESTED BY	Karl Lee

ANTENNA POLARITY & TEST DISTANCE: HORIZONTAL AT 3 M

FREQ. (MHz)	EMISSION LEVEL (dBuV/m)	READ LEVEL (dBuV)	LIMIT (dBuV/m)	MARGIN (dB)	ANTENNA FACTOR (dB/m)	CABLE LOSS (dB)	PREAMP FACTOR (dB)	ANTENNA HEIGHT (cm)	TABLE ANGLE (Degree)	REMARK
148.26	32.18	52.95	43.5	-11.32	9.98	1.52	32.27	148	22	Peak
205.23	37.24	56.73	43.5	-6.26	11.13	1.65	32.27	104	250	QP
270.57	29.73	46.32	46	-16.27	13.58	1.94	32.11	194	32	Peak
531	39.29	48.14	46	-6.71	20.61	2.7	32.16	120	145	Peak
713.7	34.24	39.96	46	-11.76	23.27	3.11	32.1	137	113	Peak
802.6	29.96	34.09	46	-16.04	24.6	3.32	32.05	104	32	Peak

ANTENNA POLARITY & TEST DISTANCE: VERTICAL AT 3 M

FREQ. (MHz)	EMISSION LEVEL (dBuV/m)	READ LEVEL (dBuV)	LIMIT (dBuV/m)	MARGIN (dB)	ANTENNA FACTOR (dB/m)	CABLE LOSS (dB)	PREAMP FACTOR (dB)	ANTENNA HEIGHT (cm)	TABLE ANGLE (Degree)	REMARK
58.62	31.9	56.28	40	-8.1	6.95	0.9	32.23	158	62	Peak
142.86	33.61	54.95	43.5	-9.89	9.55	1.38	32.27	142	336	Peak
203.61	36.93	56.52	43.5	-6.57	11.04	1.65	32.28	103	210	QP
440.7	26.35	38.13	46	-19.65	17.89	2.49	32.16	178	44	Peak
531	42.33	51.18	46	-3.67	20.61	2.7	32.16	120	61	Peak
713.7	34.28	40	46	-11.72	23.27	3.11	32.1	171	11	Peak

REMARKS: Emission Level = Read Level + Antenna Factor + Cable Loss - Preamp Factor

Margin value = Emission level – Limit value



802.11a

EUT TEST CONDITION		MEASUREMENT DETAIL	
CHANNEL	Channel 140	FREQUENCY RANGE	30MHz ~ 1GHz
INPUT POWER	120Vac, 60 Hz	DETECTOR FUNCTION	Peak (PK) Quasi-peak (QP)
ENVIRONMENTAL CONDITIONS	25deg. C, 65%RH	TESTED BY	Karl Lee

ANTENNA POLARITY & TEST DISTANCE: HORIZONTAL AT 3 M										
FREQ. (MHz)	EMISSION LEVEL (dBuV/m)	READ LEVEL (dBuV)	LIMIT (dBuV/m)	MARGIN (dB)	ANTENNA FACTOR (dB/m)	CABLE LOSS (dB)	PREAMP FACTOR (dB)	ANTENNA HEIGHT (cm)	TABLE ANGLE (Degree)	REMARK
143.67	30.06	51.34	43.5	-13.44	9.61	1.38	32.27	143	66	Peak
206.31	36.1	55.55	43.5	-7.4	11.17	1.65	32.27	107	255	QP
270.03	30.04	46.63	46	-15.96	13.58	1.94	32.11	130	4	Peak
533.1	41.71	50.61	46	-4.29	20.57	2.7	32.17	153	33	Peak
712.3	34.82	40.58	46	-11.18	23.23	3.11	32.1	171	263	Peak
925.8	28.4	29.96	46	-17.6	26.2	3.53	31.29	165	59	Peak
ANTENNA POLARITY & TEST DISTANCE: VERTICAL AT 3 M										
FREQ. (MHz)	EMISSION LEVEL (dBuV/m)	READ LEVEL (dBuV)	LIMIT (dBuV/m)	MARGIN (dB)	ANTENNA FACTOR (dB/m)	CABLE LOSS (dB)	PREAMP FACTOR (dB)	ANTENNA HEIGHT (cm)	TABLE ANGLE (Degree)	REMARK
38.91	33.97	53.55	40	-6.03	11.91	0.74	32.23	138	191	Peak
146.64	34.56	55.6	43.5	-8.94	9.85	1.38	32.27	164	146	Peak
199.83	36.43	56.18	43.5	-7.07	10.9	1.65	32.3	103	195	QP
531	42.49	51.34	46	-3.51	20.61	2.7	32.16	153	351	Peak
711.6	33.71	39.47	46	-12.29	23.23	3.11	32.1	170	19	Peak
797.7	34.09	38.41	46	-11.91	24.42	3.32	32.06	124	242	Peak

REMARKS: Emission Level = Read Level + Antenna Factor + Cable Loss - Preamp Factor

Margin value = Emission level – Limit value

802.11n (20MHz)

EUT TEST CONDITION		MEASUREMENT DETAIL	
CHANNEL	Channel 165	FREQUENCY RANGE	30MHz ~ 1GHz
INPUT POWER	120Vac, 60 Hz	DETECTOR FUNCTION	Peak (PK) Quasi-peak (QP)
ENVIRONMENTAL CONDITIONS	25deg. C, 65%RH	TESTED BY	Karl Lee

ANTENNA POLARITY & TEST DISTANCE: HORIZONTAL AT 3 M

FREQ. (MHz)	EMISSION LEVEL (dBuV/m)	READ LEVEL (dBuV)	LIMIT (dBuV/m)	MARGIN (dB)	ANTENNA FACTOR (dB/m)	CABLE LOSS (dB)	PREAMP FACTOR (dB)	ANTENNA HEIGHT (cm)	TABLE ANGLE (Degree)	REMARK
145.56	29.87	50.97	43.5	-13.63	9.79	1.38	32.27	129	145	Peak
206.58	36	55.45	43.5	-7.5	11.17	1.65	32.27	100	241	QP
270.57	29.62	46.21	46	-16.38	13.58	1.94	32.11	131	250	Peak
533.1	40.66	49.56	46	-5.34	20.57	2.7	32.17	196	332	Peak
707.4	29.73	35.53	46	-16.27	23.19	3.11	32.1	177	159	Peak
801.9	30.04	34.17	46	-15.96	24.6	3.32	32.05	130	14	Peak

ANTENNA POLARITY & TEST DISTANCE: VERTICAL AT 3 M

FREQ. (MHz)	EMISSION LEVEL (dBuV/m)	READ LEVEL (dBuV)	LIMIT (dBuV/m)	MARGIN (dB)	ANTENNA FACTOR (dB/m)	CABLE LOSS (dB)	PREAMP FACTOR (dB)	ANTENNA HEIGHT (cm)	TABLE ANGLE (Degree)	REMARK
145.02	34.05	55.21	43.5	-9.45	9.73	1.38	32.27	102	145	Peak
202.26	36.38	56.03	43.5	-7.12	10.99	1.65	32.29	105	199	QP
247.62	29.75	47.13	46	-16.25	12.88	1.85	32.11	129	229	Peak
532.4	42.63	51.52	46	-3.37	20.57	2.7	32.16	167	120	Peak
708.8	35.32	41.12	46	-10.68	23.19	3.11	32.1	133	70	Peak
881.7	31.04	34.27	46	-14.96	24.88	3.49	31.6	131	150	Peak

REMARKS: Emission Level = Read Level + Antenna Factor + Cable Loss - Preamp Factor

Margin value = Emission level – Limit value

4.2 Conducted Emission Measurement

4.2.1 Limits of Conducted Emission Measurement

Frequency (MHz)	Conducted Limit (dBuV)	
	Quasi-peak	Average
0.15 - 0.5	66 - 56	56 - 46
0.50 - 5.0	56	46
5.0 - 30.0	60	50

Note: 1. The lower limit shall apply at the transition frequencies.

2. The limit decreases in line with the logarithm of the frequency in the range of 0.15 to 0.50MHz.

4.2.2 Test Instruments

Description & Manufacturer	Model No.	Serial No.	Date Of Calibration	Due Date Of Calibration
Test Receiver ROHDE & SCHWARZ	ESCI	100613	Nov. 11, 2014	Nov. 10, 2015
RF signal cable Woken	5D-FB	Cable-HYC01-01	Dec. 26, 2014	Dec. 25, 2015
LISN ROHDE & SCHWARZ (EUT)	ESH3-Z5	835239/001	Mar. 02, 2015	Mar. 01, 2016
LISN ROHDE & SCHWARZ (Peripheral)	ESH3-Z5	100311	Jul. 24, 2015	Jul. 23, 2016
Software ADT	BV ADT_Cond_ V7.3.7.3	NA	NA	NA

- Note:**
1. The calibration interval of the above test instruments is 12 months and the calibrations are traceable to NML/ROC and NIST/USA.
 2. The test was performed in HwaYa Shielded Room 1.
 3. The VCCI Site Registration No. is C-2040.

4.2.3 Test Procedures

- a. The EUT was placed 0.4 meters from the conducting wall of the shielded room with EUT being connected to the power mains through a line impedance stabilization network (LISN). Other support units were connected to the power mains through another LISN. The two LISNs provide 50 ohm/ 50uH of coupling impedance for the measuring instrument.
- b. Both lines of the power mains connected to the EUT were checked for maximum conducted interference.
- c. The frequency range from 150kHz to 30MHz was searched. Emission levels under (Limit - 20dB) was not recorded.

NOTE: All modes of operation were investigated and the worst-case emissions are reported.

4.2.4 Deviation from Test Standard

No deviation.

4.2.5 Test Setup

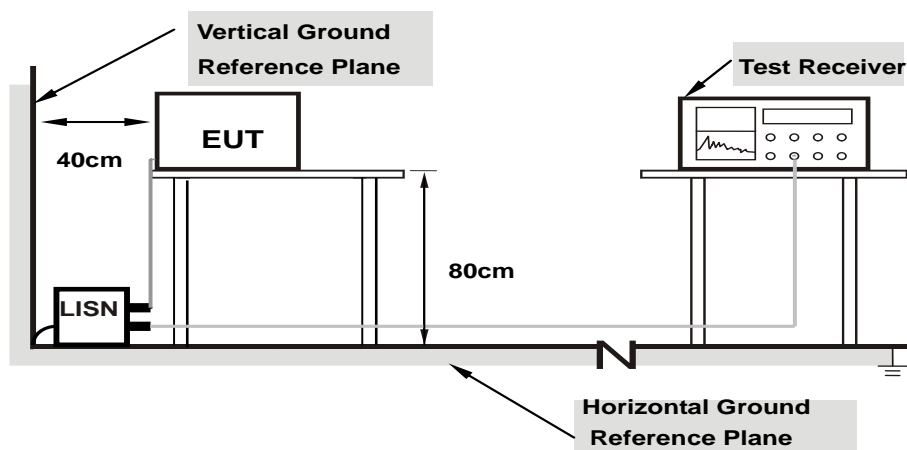

- Note:**
1. Support units were connected to second LISN.
 2. Both of LISNs (AMN) are 80 cm from EUT and at least 80 from other units and other metal planes

For the actual test configuration, please refer to the attached file (Test Setup Photo).

4.2.6 EUT Operating Conditions

Same as 4.1.6.

4.2.7 Test Results

Mode A

Phase	Line (L)	Detector Function	Quasi-Peak (QP) / Average (AV)
-------	----------	-------------------	--------------------------------

No	Frequency (MHz)	Correction Factor (dB)	Reading Value (dBuV)		Emission Level (dBuV)		Limit (dBuV)		Margin (dB)	
			Q.P.	AV.	Q.P.	AV.	Q.P.	AV.	Q.P.	AV.
1	0.16564	0.05	41.78	16.68	41.83	16.73	65.18	55.18	-23.34	-38.44
2	0.19301	0.06	47.50	31.82	47.56	31.88	63.91	53.91	-16.35	-22.03
3	0.24472	0.06	41.99	23.91	42.05	23.97	61.93	51.93	-19.88	-27.96
4	0.30374	0.06	36.34	16.68	36.40	16.74	60.14	50.14	-23.74	-33.40
5	2.49209	0.14	27.57	16.25	27.71	16.39	56.00	46.00	-28.29	-29.61
6	4.22031	0.20	32.51	21.77	32.71	21.97	56.00	46.00	-23.29	-24.03

REMARKS:

1. Q.P. and AV. are abbreviations of quasi-peak and average individually.
2. The emission levels of other frequencies were very low against the limit.
3. Margin value = Emission level - Limit value
4. Correction factor = Insertion loss + Cable loss
5. Emission Level = Correction Factor + Reading Value.

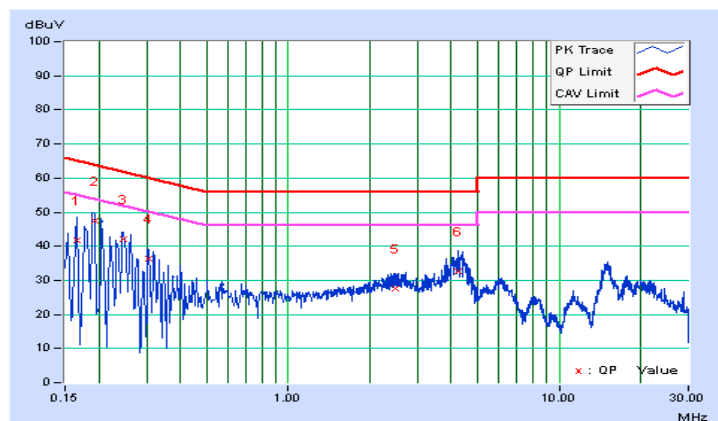

Phase	Neutral (N)	Detector Function	Quasi-Peak (QP) / Average (AV)
-------	-------------	-------------------	--------------------------------

No	Frequency (MHz)	Correction Factor (dB)	Reading Value (dBuV)		Emission Level (dBuV)		Limit (dBuV)		Margin (dB)	
			Q.P.	AV.	Q.P.	AV.	Q.P.	AV.	Q.P.	AV.
1	0.15000	0.05	43.29	24.58	43.34	24.63	66.00	56.00	-22.66	-31.37
2	0.15802	0.05	42.18	19.92	42.23	19.97	65.57	55.57	-23.34	-35.60
3	0.18903	0.05	47.40	32.39	47.45	32.44	64.08	54.08	-16.63	-21.64
4	0.24384	0.05	41.31	23.22	41.36	23.27	61.96	51.96	-20.60	-28.69
5	0.32614	0.06	34.73	18.58	34.79	18.64	59.55	49.55	-24.76	-30.91
6	0.62359	0.07	29.12	13.32	29.19	13.39	56.00	46.00	-26.81	-32.61

REMARKS:

1. Q.P. and AV. are abbreviations of quasi-peak and average individually.
2. The emission levels of other frequencies were very low against the limit.
3. Margin value = Emission level - Limit value
4. Correction factor = Insertion loss + Cable loss
5. Emission Level = Correction Factor + Reading Value.

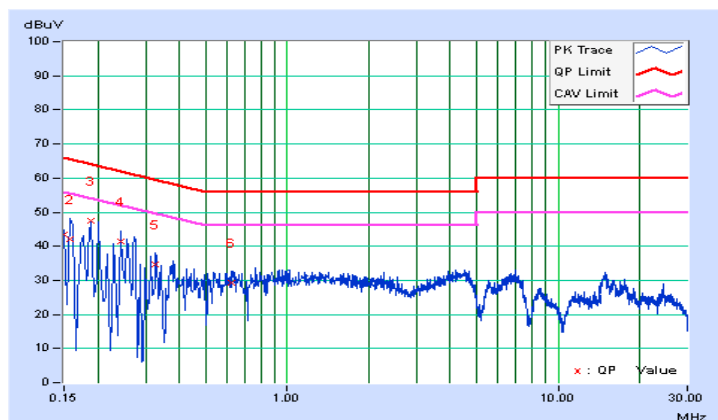

Mode B

Phase	Line (L)	Detector Function	Quasi-Peak (QP) / Average (AV)
-------	----------	-------------------	--------------------------------

No	Frequency (MHz)	Correction Factor (dB)	Reading Value (dBuV)		Emission Level (dBuV)		Limit (dBuV)		Margin (dB)	
			Q.P.	AV.	Q.P.	AV.	Q.P.	AV.	Q.P.	AV.
1	0.15391	0.05	40.78	25.04	40.83	25.09	65.79	55.79	-24.96	-30.70
2	0.18122	0.06	46.15	30.83	46.21	30.89	64.43	54.43	-18.22	-23.54
3	0.22429	0.06	38.32	23.24	38.38	23.30	62.66	52.66	-24.28	-29.36
4	0.31432	0.06	28.94	11.46	29.00	11.52	59.86	49.86	-30.86	-38.34
5	2.52728	0.14	20.63	14.39	20.77	14.53	56.00	46.00	-35.23	-31.47
6	4.29069	0.20	23.70	14.01	23.90	14.21	56.00	46.00	-32.10	-31.79

REMARKS:

1. Q.P. and AV. are abbreviations of quasi-peak and average individually.
2. The emission levels of other frequencies were very low against the limit.
3. Margin value = Emission level - Limit value
4. Correction factor = Insertion loss + Cable loss
5. Emission Level = Correction Factor + Reading Value.

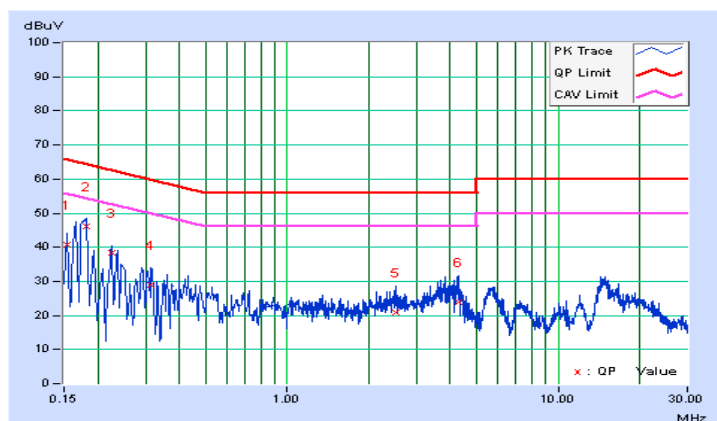

Phase	Neutral (N)	Detector Function	Quasi-Peak (QP) / Average (AV)
-------	-------------	-------------------	--------------------------------

No	Frequency (MHz)	Correction Factor (dB)	Reading Value (dBuV)		Emission Level (dBuV)		Limit (dBuV)		Margin (dB)	
			Q.P.	AV.	Q.P.	AV.	Q.P.	AV.	Q.P.	AV.
1	0.16569	0.05	47.55	32.52	47.60	32.57	65.17	55.17	-17.57	-22.60
2	0.22038	0.05	38.29	23.90	38.34	23.95	62.80	52.80	-24.46	-28.85
3	0.24775	0.05	33.22	15.69	33.27	15.74	61.83	51.83	-28.56	-36.09
4	0.37304	0.06	28.73	16.78	28.79	16.84	58.43	48.43	-29.64	-31.59
5	0.50190	0.06	28.31	19.17	28.37	19.23	56.00	46.00	-27.63	-26.77
6	0.86553	0.08	26.12	15.43	26.20	15.51	56.00	46.00	-29.80	-30.49

REMARKS:

1. Q.P. and AV. are abbreviations of quasi-peak and average individually.
2. The emission levels of other frequencies were very low against the limit.
3. Margin value = Emission level - Limit value
4. Correction factor = Insertion loss + Cable loss
5. Emission Level = Correction Factor + Reading Value.

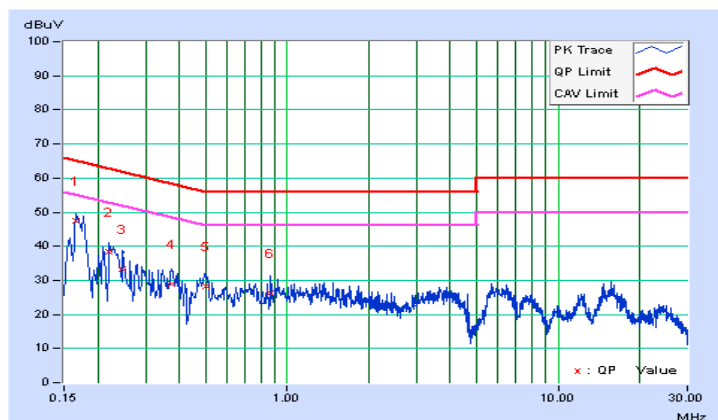



5 Pictures of Test Arrangements

Please refer to the attached file (Test Setup Photo).



A D T

Appendix – Information on the Testing Laboratories

We, Bureau Veritas Consumer Products Services (H.K.) Ltd., Taoyuan Branch, were founded in 1988 to provide our best service in EMC, Radio, Telecom and Safety consultation. Our laboratories are accredited and approved according to ISO/IEC 17025.

If you have any comments, please feel free to contact us at the following:

Linko EMC/RF Lab

Tel: 886-2-26052180

Fax: 886-2-26051924

Hsin Chu EMC/RF Lab/Telecom Lab

Tel: 886-3-5935343

Fax: 886-3-5935342

Hwa Ya EMC/RF/Safety

Tel: 886-3-3183232

Fax: 886-3-3270892

Email: service.adt@tw.bureauveritas.com

Web Site: www.bureauveritas-adt.com

The address and road map of all our labs can be found in our web site also.

--- END ---