

## Partial FCC Test Report

**Report No.:** RF150722C27

**FCC ID:** GKR-TP00078A

**Test Model:** TP00078A

**Received Date:** Jul. 22, 2015

**Test Date:** Jul. 29, 2015 ~ Aug. 18, 2015

**Issued Date:** Aug. 26, 2015

**Applicant:** Compal Electronics Inc

**Address:** No.581, Ruiguang Rd., Neihu District, Taipei City, Taiwan 11492, R.O.C.

**Issued By:** Bureau Veritas Consumer Products Services (H.K.) Ltd., Taoyuan Branch

**Lab Address:** No. 47-2, 14th Ling, Chia Pau Vil., Lin Kou Dist., New Taipei City, Taiwan ( R.O.C )

**Test Location (1):** No. 19, Hwa Ya 2nd Rd, Wen Hwa Tsuen, Kwei Shan Hsiang, Taoyuan Hsien 333, Taiwan, R.O.C.

**Test Location (2):** No.215, Sec. 3, Beixin Rd., Xindian Dist., New Taipei City 231, Taiwan, R.O.C



This report is for your exclusive use. Any copying or replication of this report to or for any other person or entity, or use of our name or trademark, is permitted only with our prior written permission. This report sets forth our findings solely with respect to the test samples identified herein. The results set forth in this report are not indicative or representative of the quality or characteristics of the lot from which a test sample was taken or any similar or identical product unless specifically and expressly noted. Our report includes all of the tests requested by you and the results thereof based upon the information that you provided to us. You have 60 days from date of issuance of this report to notify us of any material error or omission caused by our negligence, provided, however, that such notice shall be in writing and shall specifically address the issue you wish to raise. A failure to raise such issue within the prescribed time shall constitute your unqualified acceptance of the completeness of this report, the tests conducted and the correctness of the report contents. Unless specific mention, the uncertainty of measurement has been explicitly taken into account to declare the compliance or non-compliance to the specification.

## Table of Contents

<b>Release Control Record</b> .....	<b>3</b>
<b>1 Certificate of Conformity</b> .....	<b>4</b>
<b>2 Summary of Test Results</b> .....	<b>5</b>
2.1 Measurement Uncertainty .....	5
2.2 Modification Record .....	5
<b>3 General Information</b> .....	<b>6</b>
3.1 General Description of EUT .....	6
3.2 Description of Test Modes .....	7
3.2.1 Test Mode Applicability and Tested Channel Detail .....	8
3.3 Description of Support Units .....	10
3.3.1 Configuration of System under Test .....	10
3.4 General Description of Applied Standards .....	10
<b>4 Test Types and Results</b> .....	<b>11</b>
4.1 Radiated Emission and Bandedge Measurement .....	11
4.1.1 Limits of Radiated Emission and Bandedge Measurement .....	11
4.1.2 Test Instruments .....	12
4.1.3 Test Procedures .....	13
4.1.4 Deviation from Test Standard .....	13
4.1.5 Test Set Up .....	14
4.1.6 EUT Operating Conditions .....	14
4.1.7 Test Results .....	15
4.2 Conducted Emission Measurement .....	37
4.2.1 Limits of Conducted Emission Measurement .....	37
4.2.2 Test Instruments .....	37
4.2.3 Test Procedures .....	38
4.2.4 Deviation from Test Standard .....	38
4.2.5 Test Setup .....	38
4.2.6 EUT Operating Conditions .....	38
4.2.7 Test Results .....	39
<b>5 Pictures of Test Arrangements</b> .....	<b>43</b>
<b>Appendix – Information on the Testing Laboratories</b> .....	<b>44</b>



A D T

### Release Control Record

Issue No.	Description	Date Issued
RF150722C27	Original Release	Aug. 26, 2015



**1 Certificate of Conformity**

**Product:** Tablet Computer  
**Brand:** Lenovo  
**Test Model:** TP00078A  
**Sample Status:** Production Unit  
**Applicant:** Compal Electronics Inc  
**Test Date:** Jul. 29, 2015 ~ Aug. 18, 2015  
**Standards:** 47 CFR FCC Part 15, Subpart C (Section 15.247)  
ANSI C63.10:2013

The above equipment has been tested by **Bureau Veritas Consumer Products Services (H.K.) Ltd., Taoyuan Branch**, and found compliance with the requirement of the above standards. The test record, data evaluation & Equipment Under Test (EUT) configurations represented herein are true and accurate accounts of the measurements of the sample's EMC characteristics under the conditions specified in this report.

**Prepared by :** Rona Chen , **Date:** Aug. 26, 2015  
Rona Chen / Specialist

**Approved by :** Kay Wu , **Date:** Aug. 26, 2015  
Kay Wu / Supervisor

## 2 Summary of Test Results

47 CFR FCC Part 15, Subpart C (SECTION 15.247)			
FCC Clause	Test Item	Result	Remarks
15.207	AC Power Conducted Emission	PASS	Meet the requirement of limit. Minimum passing margin is -13.64 dB at 0.18508 MHz.
15.205 / 15.209 / 15.247(d)	Radiated Emissions and Band Edge Measurement	PASS	Meet the requirement of limit. Minimum passing margin is -1.01 dB at 2390 MHz.
15.247(d)	Antenna Port Emission	N/A	Refer to Note
15.247(a)(2)	6dB bandwidth	N/A	Refer to Note
15.247(b)	Conducted power	N/A	Refer to Note
15.247(e)	Power Spectral Density	N/A	Refer to Note
15.203	Antenna Requirement	PASS	No antenna connector is used.

Note: Only test item of AC power Conducted Emission and Radiated Emissions were performed for this report. Other testing data please refer to SPORTON International Inc. report no.: FR473142AA for module (Brand: Broadcom, Model: BCM94356Z, FCC ID: QDS-BRCM1085)

### 2.1 Measurement Uncertainty

Where relevant, the following measurement uncertainty levels have been estimated for tests performed on the EUT:

The listed uncertainties are the worst case uncertainty for the entire range of measurement. Please note that the uncertainty values are provided for informational purposes only and are not used in determining the PASS/FAIL results.

Measurement	Frequency	Expanded Uncertainty (k=2) ( $\pm$ )
Conducted Emissions at mains ports	150kHz ~ 30MHz	2.44 dB
Radiated Emissions up to 1 GHz	30MHz ~ 200MHz	2.0153 dB
	200MHz ~ 1000MHz	2.0224 dB
Radiated Emissions above 1 GHz	1GHz ~ 18GHz	1.0121 dB
	18GHz ~ 40GHz	1.1508 dB

### 2.2 Modification Record

There were no modifications required for compliance.

### 3 General Information

#### 3.1 General Description of EUT

Product	Tablet Computer
Brand	Lenovo
Test Model	TP00078A
Status of EUT	Production Unit
Power Supply Rating	20Vdc (Adapter) 15.2Vdc (Li-ion battery)
Modulation Type	CCK, DQPSK, DBPSK for DSSS 64QAM, 16QAM, QPSK, BPSK for OFDM
Modulation Technology	DSSS, OFDM
Transfer Rate	802.11b: 11.0 / 5.5 / 2.0 / 1.0 Mbps 802.11g: 54.0 / 48.0 / 36.0 / 24.0 / 18.0 / 12.0 / 9.0 / 6.0 Mbps 802.11n: up to MCS7
Operating Frequency	2412 ~ 2462MHz
Number of Channel	11 for 802.11b, 802.11g, 802.11n (20MHz) 7 for 802.11n (40MHz)
Antenna Type	Refer to Note as below
Antenna Connector	N/A
Accessory Device	Refer to Note as below
Data Cable Supplied	Refer to Note as below

Note:

1. This EUT contains two samples listed as below.

Sample	Difference
EUT 1	Tablet computer with Antenna (Ethertronics Inc.)
EUT 2	Tablet computer with Antenna (HIGH-TEK)

2. The antenna information is listed as below.

Antenna Type	Brand Name	Parts Number	Antenna Gain	
			2.4GHz	5GHz
PIFA	Ethertronics Inc.	WLAN Main Antenna: 5002022 WLAN Aux. Antenna: 5002030	Main: 0.85 Aux.: -0.71	Main: 0.46 Aux.: 0.36
	HIGH-TEK	WLAN Main Antenna: DC33001RQ00 WLAN Aux. Antenna: DC33001RQ10	Main: -0.17 Aux.: -0.30	Main: 1.84 Aux.: 1.56

3. The EUT contains following accessory devices.

Product	Brand	Model	Description
Adapter 1	lenovo	ADLX45NCC2A	I/P: 100-240Vac, 50~60Hz, 1.3A O/P: 20Vdc, 2.25A
Adapter 2	lenovo	ADLX45NDC2A	I/P: 100-240Vac, 50~60Hz, 1.3A O/P: 20Vdc, 2.25A
Battery	lenovo	SB10F46465	15.2Vdc, 2.895Ah
WLAN Module	Broadcom	BCM94356Z	--

4. The above EUT information is declared by manufacturer and for more detailed features description, please refer to the manufacturer's specifications or user's manual.

### 3.2 Description of Test Modes

11 channels are provided for 802.11b, 802.11g and 802.11n (20MHz):

Channel	Frequency (MHz)	Channel	Frequency (MHz)
1	2412	7	2442
2	2417	8	2447
3	2422	9	2452
4	2427	10	2457
5	2432	11	2462
6	2437		

7 channels are provided for 802.11n (40MHz):

Channel	Frequency	Channel	Frequency
3	2422	7	2442
4	2427	8	2447
5	2432	9	2452
6	2437		

### 3.2.1 Test Mode Applicability and Tested Channel Detail

EUT Configure Mode	Applicable To			Description
	RE $\geq$ 1G	RE<1G	PLC	
A	√	√	√	EUT 1 (Ant. Ethertronic)
B	√	√	√	EUT 2 (Ant. HIGH-TEK)

Where **RE $\geq$ 1G**: Radiated Emission above 1GHz  
**PLC**: Power Line Conducted Emission

**RE<1G**: Radiated Emission below 1GHz

#### **Radiated Emission Test (Above 1GHz):**

- Pre-Scan has been conducted to determine the worst-case mode from all possible combinations between available modulations, data rates and antenna ports (if EUT with antenna diversity architecture).
- Following channel(s) was (were) selected for the final test as listed below.

EUT Configure Mode	Mode	Available Channel	Tested Channel	Modulation Technology	Modulation Type	Data Rate (Mbps)
A	802.11b	1 to 11	1, 6, 11	DSSS	DBPSK	1.0
	802.11g	1 to 11	1, 6, 11	OFDM	BPSK	6.0
	802.11n (20MHz)	1 to 11	1, 6, 11	OFDM	BPSK	7.2
	802.11n (40MHz)	3 to 9	3, 6, 9	OFDM	BPSK	15.0
B	802.11g	1 to 11	6	OFDM	BPSK	6.0
	802.11n (40MHz)	3 to 9	6	OFDM	BPSK	15.0

#### **Radiated Emission Test (Below 1GHz):**

- Pre-Scan has been conducted to determine the worst-case mode from all possible combinations between available modulations, data rates and antenna ports (if EUT with antenna diversity architecture).
- Following channel(s) was (were) selected for the final test as listed below.

EUT Configure Mode	Mode	Available Channel	Tested Channel	Modulation Technology	Modulation Type	Data Rate (Mbps)
A, B	802.11g	1 to 11	6	OFDM	BPSK	6.0

#### **Power Line Conducted Emission Test:**

- Pre-Scan has been conducted to determine the worst-case mode from all possible combinations between available modulations, data rates and antenna ports (if EUT with antenna diversity architecture).
- Following channel(s) was (were) selected for the final test as listed below.

EUT Configure Mode	Mode	Available Channel	Tested Channel	Modulation Technology	Modulation Type	Data Rate (Mbps)
A, B	802.11g	1 to 11	6	OFDM	BPSK	6.0





**Test Condition:**

Applicable To	Environmental Conditions	Input Power	Tested by
RE $\geq$ 1G	25deg. C, 65%RH	120Vac, 60Hz	Charles Hsiao
RE<1G	25deg. C, 65%RH	120Vac, 60Hz	Charles Hsiao
PLC	25deg. C, 68%RH	120Vac, 60Hz	Toby Tian

### 3.3 Description of Support Units

#### 3.3.1 Configuration of System under Test

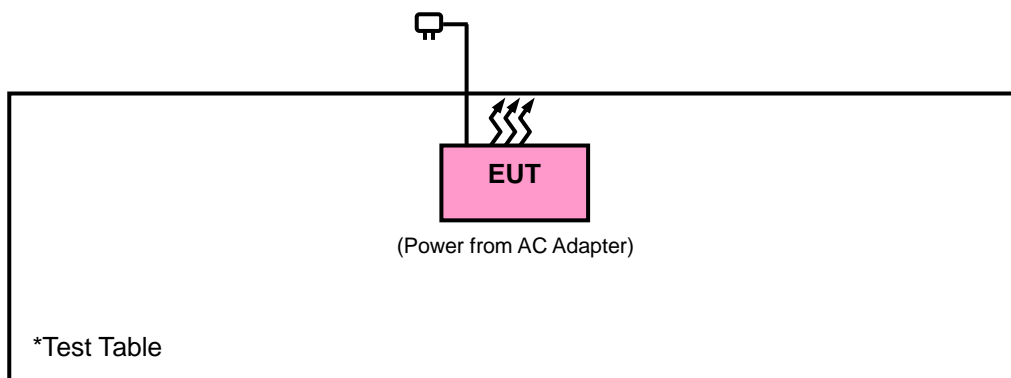

### 3.4 General Description of Applied Standards

The EUT is a RF Product. According to the specifications of the manufacturer, it must comply with the requirements of the following standards:

**FCC Part 15, Subpart C (15.247)**

**558074 D01 DTS Meas Guidance v03r03**

**662911 D01 Multiple Transmitter Output v02r01**

ANSI C63.10-2013

All test items have been performed and recorded as per the above standards.

**NOTE:** The EUT has been verified to comply with the requirements of FCC Part 15, Subpart B, Class B (DoC).  
The test report has been issued separately.

## 4 Test Types and Results

### 4.1 Radiated Emission and Bandedge Measurement

#### 4.1.1 Limits of Radiated Emission and Bandedge Measurement

Radiated emissions which fall in the restricted bands must comply with the radiated emission limits specified as below table. Other emissions shall be at least 20dB below the highest level of the desired power:

Frequencies (MHz)	Field Strength (microvolts/meter)	Measurement Distance (meters)
0.009 ~ 0.490	2400/F(kHz)	300
0.490 ~ 1.705	24000/F(kHz)	30
1.705 ~ 30.0	30	30
30 ~ 88	100	3
88 ~ 216	150	3
216 ~ 960	200	3
Above 960	500	3

**NOTE:**

1. The lower limit shall apply at the transition frequencies.
2. Emission level (dBuV/m) = 20 log Emission level (uV/m).
3. For frequencies above 1000MHz, the field strength limits are based on average detector, however, the peak field strength of any emission shall not exceed the maximum permitted average limits, specified above by more than 20dB under any condition of modulation.

**4.1.2 Test Instruments**

Description & Manufacturer	Model No.	Serial No.	Date of Calibration	Due Date of Calibration
Spectrum Analyzer Agilent Technologies	N9038A	MY52260177	May 19, 2015	May 18, 2016
Spectrum Analyzer ROHDE & SCHWARZ	FSU43	101261	Dec. 10, 2014	Dec. 09, 2015
BILOG Antenna SCHWARZBECK	VULB9168	9168-472	Feb. 04, 2015	Feb. 04, 2016
HORN Antenna ETS-Lindgren	3117	00143293	Aug. 28, 2014	Aug. 27, 2015
Preamplifier Agilent	310N	187226	Jun. 29, 2015	Jun. 28, 2016
Preamplifier Agilent	83017A	980116	Jan. 09, 2015	Jan. 08, 2016
Power Meter Anritsu	ML2495A	1232002	Sep. 17, 2014	Sep. 16, 2015
Power Sensor Anritsu	MA2411B	1207325	Sep. 17, 2014	Sep. 16, 2015
RF signal cable ETS-LINDGREN	5D-FB	Cable-CH1-01(R FC-SMS-100-SM S-120+RFC-SMS -100-SMS-400)	Jun. 27, 2015	Jun. 26, 2016
RF signal cable ETS-LINDGREN	8D-FB	Cable-CH1-02(R FC-SMS-100-SM S-24)	Jun. 27, 2015	Jun. 26, 2016
Software BV ADT	E3 8.130425b	NA	NA	NA
Antenna Tower MF	NA	NA	NA	NA
Turn Table MF	NA	NA	NA	NA
Antenna Tower & Turn Table Controller MF	MF-7802	NA	NA	NA

- Note: 1. The calibration interval of the above test instruments is 12 months and the calibrations are traceable to NML/ROC and NIST/USA.
2. The test was performed in HsinTien Chamber 1.
3. The horn antenna and HP preamplifier (model: 8449B) are used only for the measurement of emission frequency above 1GHz if tested.
4. The FCC Site Registration No. is 149147.
5. The IC Site Registration No. is IC7450I-1.

#### 4.1.3 Test Procedures

- a. The EUT was placed on the top of a rotating table 0.8 meters (for below 1GHz) / 1.5 meters (for above 1GHz) above the ground at 3 meter chamber room for test. The table was rotated 360 degrees to determine the position of the highest radiation.
- b. The EUT was set 3 meters away from the interference-receiving antenna, which was mounted on the top of a variable-height antenna tower.
- c. The height of antenna is varied from one meter to four meters above the ground to determine the maximum value of the field strength. Both horizontal and vertical polarizations of the antenna are set to make the measurement.
- d. For each suspected emission, the EUT was arranged to its worst case and then the antenna was tuned to heights from 1 meter to 4 meters and the rotatable table was turned from 0 degrees to 360 degrees to find the maximum reading.
- e. The test-receiver system was set to quasi-peak detect function and specified bandwidth with maximum hold mode when the test frequency is below 1 GHz.
- f. The test-receiver system was set to peak and average detect function and specified bandwidth with maximum hold mode when the test frequency is above 1 GHz. If the peak reading value also meets average limit, measurement with the average detector is unnecessary.

**Note:**

1. The resolution bandwidth and video bandwidth of test receiver/spectrum analyzer is 120 kHz for Quasi-peak detection (QP) at frequency below 1 GHz.
2. The resolution bandwidth of test receiver/spectrum analyzer is 1 MHz and the video bandwidth is 3 MHz for Peak detection (PK) at frequency above 1 GHz.
3. The resolution bandwidth of test receiver/spectrum analyzer is 1 MHz and the video bandwidth is 3 MHz for RMS Average (Duty cycle < 98%) for Average detection (AV) at frequency above 1GHz, then the measurement results was added to a correction factor ( $10 \log(1/\text{duty cycle})$ ).
4. The resolution bandwidth of test receiver/spectrum analyzer is 1MHz and the video bandwidth is 10 Hz (Duty cycle  $\geq 98\%$ ) for Average detection (AV) at frequency above 1 GHz.
5. All modes of operation were investigated and the worst-case emissions are reported.

#### 4.1.4 Deviation from Test Standard

No deviation.

#### 4.1.5 Test Set Up

##### <Frequency Range below 1GHz>

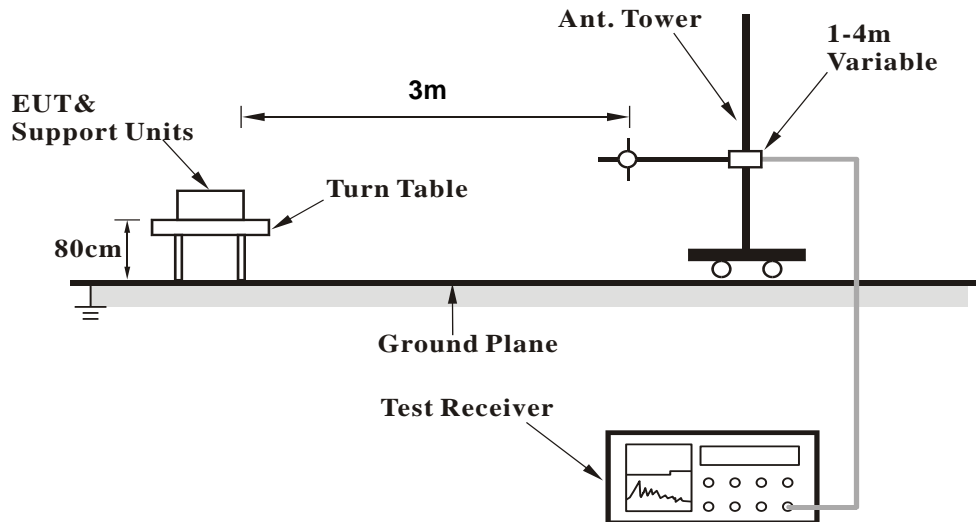

##### <Frequency Range above 1GHz>

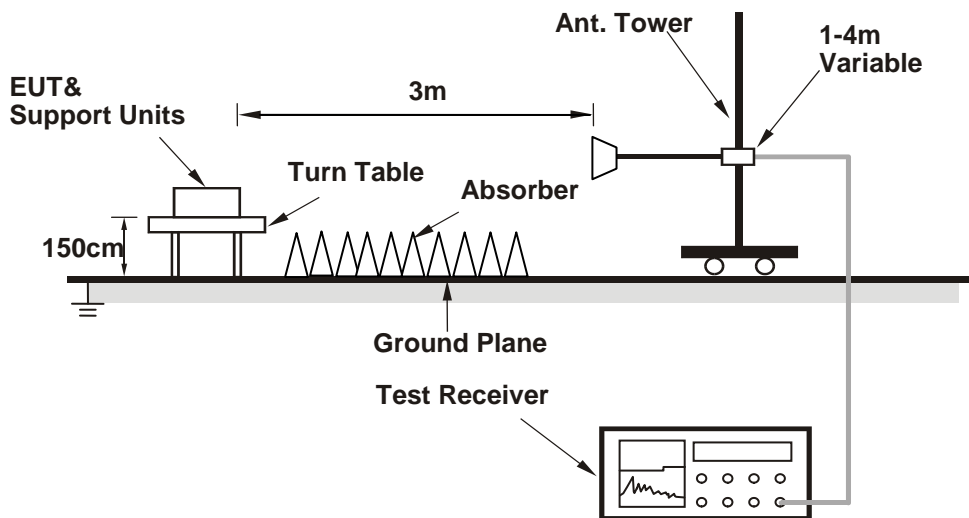

For the actual test configuration, please refer to the attached file (Test Setup Photo).

#### 4.1.6 EUT Operating Conditions

- a. Placed the EUT on a testing table.
- b. Use the software to control the EUT under transmission condition continuously at specific channel frequency.

#### 4.1.7 Test Results

#### Above 1GHz Data :

#### Mode A (1Tx)

#### 802.11b

EUT TEST CONDITION		MEASUREMENT DETAIL	
CHANNEL	Channel 1	FREQUENCY RANGE	1GHz ~ 25GHz
INPUT POWER	120Vac, 60 Hz	DETECTOR FUNCTION	Peak (PK) Average (AV)
ENVIRONMENTAL CONDITIONS	25deg. C, 65%RH	TESTED BY	Charles Hsiao

#### ANTENNA POLARITY & TEST DISTANCE: HORIZONTAL AT 3 M

FREQ. (MHz)	EMISSION LEVEL (dBuV/m)	READ LEVEL (dBuV)	LIMIT (dBuV/m)	MARGIN (dB)	ANTENNA FACTOR (dB/m)	CABLE LOSS (dB)	PREAMP FACTOR (dB)	ANTENNA HEIGHT (cm)	TABLE ANGLE (Degree)	REMARK
2388	51.47	49.76	54	-2.53	31.8	5.4	35.49	102	180	Average
2388	60.55	58.84	74	-13.45	31.8	5.4	35.49	102	180	Peak
2412	106.97	105.2			31.81	5.43	35.47	102	180	Average
2412	109.95	108.18			31.81	5.43	35.47	102	180	Peak
2488	41.8	39.79	54	-12.2	31.9	5.53	35.42	102	180	Average
2488	56.68	54.67	74	-17.32	31.9	5.53	35.42	102	180	Peak

#### ANTENNA POLARITY & TEST DISTANCE: VERTICAL AT 3 M

FREQ. (MHz)	EMISSION LEVEL (dBuV/m)	READ LEVEL (dBuV)	LIMIT (dBuV/m)	MARGIN (dB)	ANTENNA FACTOR (dB/m)	CABLE LOSS (dB)	PREAMP FACTOR (dB)	ANTENNA HEIGHT (cm)	TABLE ANGLE (Degree)	REMARK
2390	49.35	47.62	54	-4.65	31.8	5.4	35.47	103	266	Average
2390	59.71	57.98	74	-14.29	31.8	5.4	35.47	103	266	Peak
2412	104.2	102.43			31.81	5.43	35.47	103	266	Average
2412	107.12	105.35			31.81	5.43	35.47	103	266	Peak
2500	41.53	39.51	54	-12.47	31.9	5.53	35.41	103	266	Average
2500	56.35	54.33	74	-17.65	31.9	5.53	35.41	103	266	Peak

#### REMARKS:

- Emission Level = Read Level + Antenna Factor + Cable Loss - Preamp Factor  
Margin value = Emission level – Limit value
- 2412MHz: Fundamental frequency.



A D T

EUT TEST CONDITION		MEASUREMENT DETAIL	
CHANNEL	Channel 6	FREQUENCY RANGE	1GHz ~ 25GHz
INPUT POWER	120Vac, 60 Hz	DETECTOR FUNCTION	Peak (PK) Average (AV)
ENVIRONMENTAL CONDITIONS	25deg. C, 65%RH	TESTED BY	Charles Hsiao

ANTENNA POLARITY & TEST DISTANCE: HORIZONTAL AT 3 M										
FREQ. (MHz)	EMISSION LEVEL (dBuV/m)	READ LEVEL (dBuV)	LIMIT (dBuV/m)	MARGIN (dB)	ANTENNA FACTOR (dB/m)	CABLE LOSS (dB)	PREAMP FACTOR (dB)	ANTENNA HEIGHT (cm)	TABLE ANGLE (Degree)	REMARK
2390	45.73	44	54	-8.27	31.8	5.4	35.47	102	180	Average
2390	62.04	60.31	74	-11.96	31.8	5.4	35.47	102	180	Peak
2437	109.06	107.21			31.85	5.46	35.46	102	180	Average
2437	111.8	109.95			31.85	5.46	35.46	102	180	Peak
2490	42.29	40.28	54	-11.71	31.9	5.53	35.42	102	180	Average
2490	58.51	56.5	74	-15.49	31.9	5.53	35.42	102	180	Peak

ANTENNA POLARITY & TEST DISTANCE: VERTICAL AT 3 M										
FREQ. (MHz)	EMISSION LEVEL (dBuV/m)	READ LEVEL (dBuV)	LIMIT (dBuV/m)	MARGIN (dB)	ANTENNA FACTOR (dB/m)	CABLE LOSS (dB)	PREAMP FACTOR (dB)	ANTENNA HEIGHT (cm)	TABLE ANGLE (Degree)	REMARK
2376	44.62	42.96	54	-9.38	31.78	5.37	35.49	103	266	Average
2376	58.19	56.53	74	-15.81	31.78	5.37	35.49	103	266	Peak
2437	106.98	105.13			31.85	5.46	35.46	103	266	Average
2437	109.72	107.87			31.85	5.46	35.46	103	266	Peak
2486	41.82	39.83	54	-12.18	31.88	5.53	35.42	103	266	Average
2486	56.51	54.52	74	-17.49	31.88	5.53	35.42	103	266	Peak

## REMARKS:

- Emission Level = Read Level + Antenna Factor + Cable Loss - Preamp Factor  
Margin value = Emission level – Limit value
- 2437MHz: Fundamental frequency.





A D T

EUT TEST CONDITION		MEASUREMENT DETAIL	
CHANNEL	Channel 11	FREQUENCY RANGE	1GHz ~ 25GHz
INPUT POWER	120Vac, 60 Hz	DETECTOR FUNCTION	Peak (PK) Average (AV)
ENVIRONMENTAL CONDITIONS	25deg. C, 65%RH	TESTED BY	Charles Hsiao

ANTENNA POLARITY & TEST DISTANCE: HORIZONTAL AT 3 M										
FREQ. (MHz)	EMISSION LEVEL (dBuV/m)	READ LEVEL (dBuV)	LIMIT (dBuV/m)	MARGIN (dB)	ANTENNA FACTOR (dB/m)	CABLE LOSS (dB)	PREAMP FACTOR (dB)	ANTENNA HEIGHT (cm)	TABLE ANGLE (Degree)	REMARK
2390	42.04	40.31	54	-11.96	31.8	5.4	35.47	113	180	Average
2390	56.53	54.8	74	-17.47	31.8	5.4	35.47	113	180	Peak
2462	107.31	105.38			31.87	5.5	35.44	113	180	Average
2462	110.31	108.38			31.87	5.5	35.44	113	180	Peak
2484	51.51	49.55	54	-2.49	31.88	5.5	35.42	113	180	Average
2484	63.86	61.9	74	-10.14	31.88	5.5	35.42	113	180	Peak

ANTENNA POLARITY & TEST DISTANCE: VERTICAL AT 3 M										
FREQ. (MHz)	EMISSION LEVEL (dBuV/m)	READ LEVEL (dBuV)	LIMIT (dBuV/m)	MARGIN (dB)	ANTENNA FACTOR (dB/m)	CABLE LOSS (dB)	PREAMP FACTOR (dB)	ANTENNA HEIGHT (cm)	TABLE ANGLE (Degree)	REMARK
2386	42.13	40.42	54	-11.87	31.8	5.4	35.49	103	266	Average
2386	56.73	55.02	74	-17.27	31.8	5.4	35.49	103	266	Peak
2462	105.74	103.81			31.87	5.5	35.44	103	266	Average
2462	108.71	106.78			31.87	5.5	35.44	103	266	Peak
2488	45.66	43.65	54	-8.34	31.9	5.53	35.42	103	266	Average
2488	57.84	55.83	74	-16.16	31.9	5.53	35.42	103	266	Peak

## REMARKS:

- Emission Level = Read Level + Antenna Factor + Cable Loss - Preamp Factor  
Margin value = Emission level – Limit value
- 2462MHz: Fundamental frequency.

**802.11g**

EUT TEST CONDITION		MEASUREMENT DETAIL	
CHANNEL	Channel 1	FREQUENCY RANGE	1GHz ~ 25GHz
INPUT POWER	120Vac, 60 Hz	DETECTOR FUNCTION	Peak (PK) Average (AV)
ENVIRONMENTAL CONDITIONS	25deg. C, 65%RH	TESTED BY	Charles Hsiao

**ANTENNA POLARITY & TEST DISTANCE: HORIZONTAL AT 3 M**

FREQ. (MHz)	EMISSION LEVEL (dBuV/m)	READ LEVEL (dBuV)	LIMIT (dBuV/m)	MARGIN (dB)	ANTENNA FACTOR (dB/m)	CABLE LOSS (dB)	PREAMP FACTOR (dB)	ANTENNA HEIGHT (cm)	TABLE ANGLE (Degree)	REMARK
2390	48.01	46.28	54	-5.99	31.8	5.4	35.47	102	180	Average
2390	59.88	58.15	74	-14.12	31.8	5.4	35.47	102	180	Peak
2412	98.46	96.69			31.81	5.43	35.47	102	180	Average
2412	106.64	104.87			31.81	5.43	35.47	102	180	Peak
2500	41.71	39.69	54	-12.29	31.9	5.53	35.41	102	180	Average
2500	55.49	53.47	74	-18.51	31.9	5.53	35.41	102	180	Peak

**ANTENNA POLARITY & TEST DISTANCE: VERTICAL AT 3 M**

FREQ. (MHz)	EMISSION LEVEL (dBuV/m)	READ LEVEL (dBuV)	LIMIT (dBuV/m)	MARGIN (dB)	ANTENNA FACTOR (dB/m)	CABLE LOSS (dB)	PREAMP FACTOR (dB)	ANTENNA HEIGHT (cm)	TABLE ANGLE (Degree)	REMARK
2390	46.2	44.47	54	-7.8	31.8	5.4	35.47	103	266	Average
2390	58.66	56.93	74	-15.34	31.8	5.4	35.47	103	266	Peak
2412	96.61	94.84			31.81	5.43	35.47	103	266	Average
2412	104.64	102.87			31.81	5.43	35.47	103	266	Peak
2486	41.44	39.45	54	-12.56	31.88	5.53	35.42	103	266	Average
2486	56.05	54.06	74	-17.95	31.88	5.53	35.42	103	266	Peak

**REMARKS:**

- Emission Level = Read Level + Antenna Factor + Cable Loss - Preamp Factor  
Margin value = Emission level – Limit value
- 2412MHz: Fundamental frequency.



A D T

EUT TEST CONDITION		MEASUREMENT DETAIL	
CHANNEL	Channel 6	FREQUENCY RANGE	1GHz ~ 25GHz
INPUT POWER	120Vac, 60 Hz	DETECTOR FUNCTION	Peak (PK) Average (AV)
ENVIRONMENTAL CONDITIONS	25deg. C, 65%RH	TESTED BY	Charles Hsiao

ANTENNA POLARITY & TEST DISTANCE: HORIZONTAL AT 3 M										
FREQ. (MHz)	EMISSION LEVEL (dBuV/m)	READ LEVEL (dBuV)	LIMIT (dBuV/m)	MARGIN (dB)	ANTENNA FACTOR (dB/m)	CABLE LOSS (dB)	PREAMP FACTOR (dB)	ANTENNA HEIGHT (cm)	TABLE ANGLE (Degree)	REMARK
2386	51.79	50.08	54	-2.21	31.8	5.4	35.49	102	180	Average
2386	64.26	62.55	74	-9.74	31.8	5.4	35.49	102	180	Peak
2437	103.41	101.56			31.85	5.46	35.46	102	180	Average
2437	111.95	110.1			31.85	5.46	35.46	102	180	Peak
2488	45.58	43.57	54	-8.42	31.9	5.53	35.42	102	180	Average
2488	57.82	55.81	74	-16.18	31.9	5.53	35.42	102	180	Peak

ANTENNA POLARITY & TEST DISTANCE: VERTICAL AT 3 M										
FREQ. (MHz)	EMISSION LEVEL (dBuV/m)	READ LEVEL (dBuV)	LIMIT (dBuV/m)	MARGIN (dB)	ANTENNA FACTOR (dB/m)	CABLE LOSS (dB)	PREAMP FACTOR (dB)	ANTENNA HEIGHT (cm)	TABLE ANGLE (Degree)	REMARK
2390	50.05	48.32	54	-3.95	31.8	5.4	35.47	103	266	Average
2390	62.28	60.55	74	-11.72	31.8	5.4	35.47	103	266	Peak
2437	101.43	99.58			31.85	5.46	35.46	103	266	Average
2437	109.77	107.92			31.85	5.46	35.46	103	266	Peak
2484	44.49	42.53	54	-9.51	31.88	5.5	35.42	103	266	Average
2484	58.12	56.16	74	-15.88	31.88	5.5	35.42	103	266	Peak

## REMARKS:

- Emission Level = Read Level + Antenna Factor + Cable Loss - Preamp Factor  
Margin value = Emission level – Limit value
- 2437MHz: Fundamental frequency.



A D T

EUT TEST CONDITION		MEASUREMENT DETAIL	
CHANNEL	Channel 11	FREQUENCY RANGE	1GHz ~ 25GHz
INPUT POWER	120Vac, 60 Hz	DETECTOR FUNCTION	Peak (PK) Average (AV)
ENVIRONMENTAL CONDITIONS	25deg. C, 65%RH	TESTED BY	Charles Hsiao

ANTENNA POLARITY & TEST DISTANCE: HORIZONTAL AT 3 M										
FREQ. (MHz)	EMISSION LEVEL (dBuV/m)	READ LEVEL (dBuV)	LIMIT (dBuV/m)	MARGIN (dB)	ANTENNA FACTOR (dB/m)	CABLE LOSS (dB)	PREAMP FACTOR (dB)	ANTENNA HEIGHT (cm)	TABLE ANGLE (Degree)	REMARK
2382	41.74	40.05	54	-12.26	31.78	5.4	35.49	113	180	Average
2382	56.72	55.03	74	-17.28	31.78	5.4	35.49	113	180	Peak
2462	98.37	96.44			31.87	5.5	35.44	113	180	Average
2462	106.67	104.74			31.87	5.5	35.44	113	180	Peak
2484	45.68	43.72	54	-8.32	31.88	5.5	35.42	113	180	Average
2484	58.79	56.83	74	-15.21	31.88	5.5	35.42	113	180	Peak
ANTENNA POLARITY & TEST DISTANCE: VERTICAL AT 3 M										
FREQ. (MHz)	EMISSION LEVEL (dBuV/m)	READ LEVEL (dBuV)	LIMIT (dBuV/m)	MARGIN (dB)	ANTENNA FACTOR (dB/m)	CABLE LOSS (dB)	PREAMP FACTOR (dB)	ANTENNA HEIGHT (cm)	TABLE ANGLE (Degree)	REMARK
2376	41.92	40.26	54	-12.08	31.78	5.37	35.49	103	266	Average
2376	56.34	54.68	74	-17.66	31.78	5.37	35.49	103	266	Peak
2462	96.67	94.74			31.87	5.5	35.44	103	266	Average
2462	104.8	102.87			31.87	5.5	35.44	103	266	Peak
2484	42.33	40.37	54	-11.67	31.88	5.5	35.42	103	266	Average
2484	55.72	53.76	74	-18.28	31.88	5.5	35.42	103	266	Peak

## REMARKS:

- Emission Level = Read Level + Antenna Factor + Cable Loss - Preamp Factor  
Margin value = Emission level – Limit value
- 2462MHz: Fundamental frequency.

**802.11n (20MHz)**

EUT TEST CONDITION		MEASUREMENT DETAIL	
CHANNEL	Channel 1	FREQUENCY RANGE	1GHz ~ 25GHz
INPUT POWER	120Vac, 60 Hz	DETECTOR FUNCTION	Peak (PK) Average (AV)
ENVIRONMENTAL CONDITIONS	25deg. C, 65%RH	TESTED BY	Charles Hsiao

**ANTENNA POLARITY & TEST DISTANCE: HORIZONTAL AT 3 M**

FREQ. (MHz)	EMISSION LEVEL (dBuV/m)	READ LEVEL (dBuV)	LIMIT (dBuV/m)	MARGIN (dB)	ANTENNA FACTOR (dB/m)	CABLE LOSS (dB)	PREAMP FACTOR (dB)	ANTENNA HEIGHT (cm)	TABLE ANGLE (Degree)	REMARK
2390	50.3	48.57	54	-3.7	31.8	5.4	35.47	102	180	Average
2390	64.29	62.56	74	-9.71	31.8	5.4	35.47	102	180	Peak
2412	98.88	97.11			31.81	5.43	35.47	102	180	Average
2412	107.45	105.68			31.81	5.43	35.47	102	180	Peak
2498	41.94	39.92	54	-12.06	31.9	5.53	35.41	102	180	Average
2498	55.96	53.94	74	-18.04	31.9	5.53	35.41	102	180	Peak

**ANTENNA POLARITY & TEST DISTANCE: VERTICAL AT 3 M**

FREQ. (MHz)	EMISSION LEVEL (dBuV/m)	READ LEVEL (dBuV)	LIMIT (dBuV/m)	MARGIN (dB)	ANTENNA FACTOR (dB/m)	CABLE LOSS (dB)	PREAMP FACTOR (dB)	ANTENNA HEIGHT (cm)	TABLE ANGLE (Degree)	REMARK
2390	49.08	47.35	54	-4.92	31.8	5.4	35.47	103	266	Average
2390	62.2	60.47	74	-11.8	31.8	5.4	35.47	103	266	Peak
2412	97.2	95.43			31.81	5.43	35.47	103	266	Average
2412	105.61	103.84			31.81	5.43	35.47	103	266	Peak
2500	41.58	39.56	54	-12.42	31.9	5.53	35.41	103	266	Average
2500	55.99	53.97	74	-18.01	31.9	5.53	35.41	103	266	Peak

**REMARKS:**

- Emission Level = Read Level + Antenna Factor + Cable Loss - Preamp Factor  
Margin value = Emission level – Limit value
- 2412MHz: Fundamental frequency.



A D T

EUT TEST CONDITION		MEASUREMENT DETAIL	
CHANNEL	Channel 6	FREQUENCY RANGE	1GHz ~ 25GHz
INPUT POWER	120Vac, 60 Hz	DETECTOR FUNCTION	Peak (PK) Average (AV)
ENVIRONMENTAL CONDITIONS	25deg. C, 65%RH	TESTED BY	Charles Hsiao

ANTENNA POLARITY & TEST DISTANCE: HORIZONTAL AT 3 M										
FREQ. (MHz)	EMISSION LEVEL (dBuV/m)	READ LEVEL (dBuV)	LIMIT (dBuV/m)	MARGIN (dB)	ANTENNA FACTOR (dB/m)	CABLE LOSS (dB)	PREAMP FACTOR (dB)	ANTENNA HEIGHT (cm)	TABLE ANGLE (Degree)	REMARK
2386	50.96	49.25	54	-3.04	31.8	5.4	35.49	102	180	Average
2386	64.99	63.28	74	-9.01	31.8	5.4	35.49	102	180	Peak
2437	103.08	101.23			31.85	5.46	35.46	102	180	Average
2437	111.99	110.14			31.85	5.46	35.46	102	180	Peak
2484	45.3	43.34	54	-8.7	31.88	5.5	35.42	102	180	Average
2484	58.22	56.26	74	-15.78	31.88	5.5	35.42	102	180	Peak

ANTENNA POLARITY & TEST DISTANCE: VERTICAL AT 3 M										
FREQ. (MHz)	EMISSION LEVEL (dBuV/m)	READ LEVEL (dBuV)	LIMIT (dBuV/m)	MARGIN (dB)	ANTENNA FACTOR (dB/m)	CABLE LOSS (dB)	PREAMP FACTOR (dB)	ANTENNA HEIGHT (cm)	TABLE ANGLE (Degree)	REMARK
2390	50.02	48.29	54	-3.98	31.8	5.4	35.47	103	266	Average
2390	62.08	60.35	74	-11.92	31.8	5.4	35.47	103	266	Peak
2437	101.26	99.41			31.85	5.46	35.46	103	266	Average
2437	109.01	107.16			31.85	5.46	35.46	103	266	Peak
2488	44.64	42.63	54	-9.36	31.9	5.53	35.42	103	266	Average
2488	56.8	54.79	74	-17.2	31.9	5.53	35.42	103	266	Peak

## REMARKS:

- Emission Level = Read Level + Antenna Factor + Cable Loss - Preamp Factor  
Margin value = Emission level – Limit value
- 2437MHz: Fundamental frequency.



A D T

EUT TEST CONDITION		MEASUREMENT DETAIL	
CHANNEL	Channel 11	FREQUENCY RANGE	1GHz ~ 25GHz
INPUT POWER	120Vac, 60 Hz	DETECTOR FUNCTION	Peak (PK) Average (AV)
ENVIRONMENTAL CONDITIONS	25deg. C, 65%RH	TESTED BY	Charles Hsiao

ANTENNA POLARITY & TEST DISTANCE: HORIZONTAL AT 3 M										
FREQ. (MHz)	EMISSION LEVEL (dBuV/m)	READ LEVEL (dBuV)	LIMIT (dBuV/m)	MARGIN (dB)	ANTENNA FACTOR (dB/m)	CABLE LOSS (dB)	PREAMP FACTOR (dB)	ANTENNA HEIGHT (cm)	TABLE ANGLE (Degree)	REMARK
2348	41.56	39.99	54	-12.44	31.74	5.33	35.5	113	180	Average
2348	55.73	54.16	74	-18.27	31.74	5.33	35.5	113	180	Peak
2462	96.72	94.79			31.87	5.5	35.44	113	180	Average
2462	104.98	103.05			31.87	5.5	35.44	113	180	Peak
2484	45.03	43.07	54	-8.97	31.88	5.5	35.42	113	180	Average
2484	57.89	55.93	74	-16.11	31.88	5.5	35.42	113	180	Peak

ANTENNA POLARITY & TEST DISTANCE: VERTICAL AT 3 M										
FREQ. (MHz)	EMISSION LEVEL (dBuV/m)	READ LEVEL (dBuV)	LIMIT (dBuV/m)	MARGIN (dB)	ANTENNA FACTOR (dB/m)	CABLE LOSS (dB)	PREAMP FACTOR (dB)	ANTENNA HEIGHT (cm)	TABLE ANGLE (Degree)	REMARK
2390	41.68	39.95	54	-12.32	31.8	5.4	35.47	103	266	Average
2390	56.22	54.49	74	-17.78	31.8	5.4	35.47	103	266	Peak
2462	94.76	92.83			31.87	5.5	35.44	103	266	Average
2462	102.81	100.88			31.87	5.5	35.44	103	266	Peak
2486	42.27	40.28	54	-11.73	31.88	5.53	35.42	103	266	Average
2486	56.28	54.29	74	-17.72	31.88	5.53	35.42	103	266	Peak

## REMARKS:

- Emission Level = Read Level + Antenna Factor + Cable Loss - Preamp Factor  
Margin value = Emission level – Limit value
- 2462MHz: Fundamental frequency.

**802.11n (40MHz)**

EUT TEST CONDITION		MEASUREMENT DETAIL	
CHANNEL	Channel 3	FREQUENCY RANGE	1GHz ~ 25GHz
INPUT POWER	120Vac, 60 Hz	DETECTOR FUNCTION	Peak (PK) Average (AV)
ENVIRONMENTAL CONDITIONS	25deg. C, 65%RH	TESTED BY	Charles Hsiao

**ANTENNA POLARITY & TEST DISTANCE: HORIZONTAL AT 3 M**

FREQ. (MHz)	EMISSION LEVEL (dBuV/m)	READ LEVEL (dBuV)	LIMIT (dBuV/m)	MARGIN (dB)	ANTENNA FACTOR (dB/m)	CABLE LOSS (dB)	PREAMP FACTOR (dB)	ANTENNA HEIGHT (cm)	TABLE ANGLE (Degree)	REMARK
2386	51.18	49.47	54	-2.82	31.8	5.4	35.49	102	180	Average
2386	63.34	61.63	74	-10.66	31.8	5.4	35.49	102	180	Peak
2422	94.16	92.36			31.83	5.43	35.46	102	180	Average
2422	102.1	100.3			31.83	5.43	35.46	102	180	Peak
2494	42.03	40.01	54	-11.97	31.9	5.53	35.41	102	180	Average
2494	55.56	53.54	74	-18.44	31.9	5.53	35.41	102	180	Peak

**ANTENNA POLARITY & TEST DISTANCE: VERTICAL AT 3 M**

FREQ. (MHz)	EMISSION LEVEL (dBuV/m)	READ LEVEL (dBuV)	LIMIT (dBuV/m)	MARGIN (dB)	ANTENNA FACTOR (dB/m)	CABLE LOSS (dB)	PREAMP FACTOR (dB)	ANTENNA HEIGHT (cm)	TABLE ANGLE (Degree)	REMARK
2386	50.2	48.49	54	-3.8	31.8	5.4	35.49	103	270	Average
2386	61.64	59.93	74	-12.36	31.8	5.4	35.49	103	270	Peak
2422	91.76	89.96			31.83	5.43	35.46	103	270	Average
2422	100.75	98.95			31.83	5.43	35.46	103	270	Peak
2484	42.08	40.12	54	-11.92	31.88	5.5	35.42	103	270	Average
2484	56.33	54.37	74	-17.67	31.88	5.5	35.42	103	270	Peak

**REMARKS:**

- Emission Level = Read Level + Antenna Factor + Cable Loss - Preamp Factor  
Margin value = Emission level – Limit value
- 2422MHz: Fundamental frequency.





A D T

EUT TEST CONDITION		MEASUREMENT DETAIL	
CHANNEL	Channel 6	FREQUENCY RANGE	1GHz ~ 25GHz
INPUT POWER	120Vac, 60 Hz	DETECTOR FUNCTION	Peak (PK) Average (AV)
ENVIRONMENTAL CONDITIONS	25deg. C, 65%RH	TESTED BY	Charles Hsiao

ANTENNA POLARITY & TEST DISTANCE: HORIZONTAL AT 3 M										
FREQ. (MHz)	EMISSION LEVEL (dBuV/m)	READ LEVEL (dBuV)	LIMIT (dBuV/m)	MARGIN (dB)	ANTENNA FACTOR (dB/m)	CABLE LOSS (dB)	PREAMP FACTOR (dB)	ANTENNA HEIGHT (cm)	TABLE ANGLE (Degree)	REMARK
2390	49.2	47.47	54	-4.8	31.8	5.4	35.47	100	180	Average
2390	62.59	60.86	74	-11.41	31.8	5.4	35.47	100	180	Peak
2437	96.21	94.36			31.85	5.46	35.46	100	180	Average
2437	104.58	102.73			31.85	5.46	35.46	100	180	Peak
2484	44.48	42.52	54	-9.52	31.88	5.5	35.42	100	180	Average
2484	56.28	54.32	74	-17.72	31.88	5.5	35.42	100	180	Peak

ANTENNA POLARITY & TEST DISTANCE: VERTICAL AT 3 M										
FREQ. (MHz)	EMISSION LEVEL (dBuV/m)	READ LEVEL (dBuV)	LIMIT (dBuV/m)	MARGIN (dB)	ANTENNA FACTOR (dB/m)	CABLE LOSS (dB)	PREAMP FACTOR (dB)	ANTENNA HEIGHT (cm)	TABLE ANGLE (Degree)	REMARK
2390	48.9	47.17	54	-5.1	31.8	5.4	35.47	116	270	Average
2390	62.8	61.07	74	-11.2	31.8	5.4	35.47	116	270	Peak
2437	94.21	92.36			31.85	5.46	35.46	116	270	Average
2437	102.66	100.81			31.85	5.46	35.46	116	270	Peak
2484	43.68	41.72	54	-10.32	31.88	5.5	35.42	116	270	Average
2484	57.71	55.75	74	-16.29	31.88	5.5	35.42	116	270	Peak

REMARKS:

- Emission Level = Read Level + Antenna Factor + Cable Loss - Preamp Factor  
Margin value = Emission level – Limit value
- 2437MHz: Fundamental frequency.



A D T

EUT TEST CONDITION		MEASUREMENT DETAIL	
CHANNEL	Channel 9	FREQUENCY RANGE	1GHz ~ 25GHz
INPUT POWER	120Vac, 60 Hz	DETECTOR FUNCTION	Peak (PK) Average (AV)
ENVIRONMENTAL CONDITIONS	25deg. C, 65%RH	TESTED BY	Charles Hsiao

ANTENNA POLARITY & TEST DISTANCE: HORIZONTAL AT 3 M										
FREQ. (MHz)	EMISSION LEVEL (dBuV/m)	READ LEVEL (dBuV)	LIMIT (dBuV/m)	MARGIN (dB)	ANTENNA FACTOR (dB/m)	CABLE LOSS (dB)	PREAMP FACTOR (dB)	ANTENNA HEIGHT (cm)	TABLE ANGLE (Degree)	REMARK
2390	44.2	42.47	54	-9.8	31.8	5.4	35.47	100	180	Average
2390	55.77	54.04	74	-18.23	31.8	5.4	35.47	100	180	Peak
2452	94.01	92.14			31.85	5.46	35.44	100	180	Average
2452	102.87	101			31.85	5.46	35.44	100	180	Peak
2496	46.11	44.09	54	-7.89	31.9	5.53	35.41	100	180	Average
2496	59.28	57.26	74	-14.72	31.9	5.53	35.41	100	180	Peak

ANTENNA POLARITY & TEST DISTANCE: VERTICAL AT 3 M										
FREQ. (MHz)	EMISSION LEVEL (dBuV/m)	READ LEVEL (dBuV)	LIMIT (dBuV/m)	MARGIN (dB)	ANTENNA FACTOR (dB/m)	CABLE LOSS (dB)	PREAMP FACTOR (dB)	ANTENNA HEIGHT (cm)	TABLE ANGLE (Degree)	REMARK
2376	43.45	41.79	54	-10.55	31.78	5.37	35.49	102	270	Average
2376	55.92	54.26	74	-18.08	31.78	5.37	35.49	102	270	Peak
2452	92.91	91.04			31.85	5.46	35.44	102	270	Average
2452	100.52	98.65			31.85	5.46	35.44	102	270	Peak
2486	45.13	43.14	54	-8.87	31.88	5.53	35.42	102	270	Average
2486	58.11	56.12	74	-15.89	31.88	5.53	35.42	102	270	Peak

## REMARKS:

- Emission Level = Read Level + Antenna Factor + Cable Loss - Preamp Factor  
Margin value = Emission level – Limit value
- 2452MHz: Fundamental frequency.

**Mode A (2Tx)**
**802.11n (20MHz)**

EUT TEST CONDITION		MEASUREMENT DETAIL	
CHANNEL	Channel 1	FREQUENCY RANGE	1GHz ~ 25GHz
INPUT POWER	120Vac, 60 Hz	DETECTOR FUNCTION	Peak (PK) Average (AV)
ENVIRONMENTAL CONDITIONS	25deg. C, 65%RH	TESTED BY	Charles Hsiao

**ANTENNA POLARITY & TEST DISTANCE: HORIZONTAL AT 3 M**

FREQ. (MHz)	EMISSION LEVEL (dBuV/m)	READ LEVEL (dBuV)	LIMIT (dBuV/m)	MARGIN (dB)	ANTENNA FACTOR (dB/m)	CABLE LOSS (dB)	PREAMP FACTOR (dB)	ANTENNA HEIGHT (cm)	TABLE ANGLE (Degree)	REMARK
2390	51.44	49.71	54	-2.56	31.8	5.4	35.47	100	228	Average
2390	64.3	62.57	74	-9.7	31.8	5.4	35.47	100	228	Peak
2412	100.67	98.9			31.81	5.43	35.47	100	228	Average
2412	108.48	106.71			31.81	5.43	35.47	100	228	Peak
2492	45.55	43.53	54	-8.45	31.9	5.53	35.41	100	228	Average
2492	56.5	54.48	74	-17.5	31.9	5.53	35.41	100	228	Peak

**ANTENNA POLARITY & TEST DISTANCE: VERTICAL AT 3 M**

FREQ. (MHz)	EMISSION LEVEL (dBuV/m)	READ LEVEL (dBuV)	LIMIT (dBuV/m)	MARGIN (dB)	ANTENNA FACTOR (dB/m)	CABLE LOSS (dB)	PREAMP FACTOR (dB)	ANTENNA HEIGHT (cm)	TABLE ANGLE (Degree)	REMARK
2390	52.12	50.39	54	-1.88	31.8	5.4	35.47	104	266	Average
2390	66.87	65.14	74	-7.13	31.8	5.4	35.47	104	266	Peak
2412	99.31	97.54			31.81	5.43	35.47	104	266	Average
2412	107.2	105.43			31.81	5.43	35.47	104	266	Peak
2496	41.45	39.43	54	-12.55	31.9	5.53	35.41	104	266	Average
2496	56.41	54.39	74	-17.59	31.9	5.53	35.41	104	266	Peak

**REMARKS:**

- Emission Level = Read Level + Antenna Factor + Cable Loss - Preamp Factor  
Margin value = Emission level – Limit value
- 2412MHz: Fundamental frequency.



A D T

EUT TEST CONDITION		MEASUREMENT DETAIL	
CHANNEL	Channel 6	FREQUENCY RANGE	1GHz ~ 25GHz
INPUT POWER	120Vac, 60 Hz	DETECTOR FUNCTION	Peak (PK) Average (AV)
ENVIRONMENTAL CONDITIONS	25deg. C, 65%RH	TESTED BY	Charles Hsiao

ANTENNA POLARITY & TEST DISTANCE: HORIZONTAL AT 3 M										
FREQ. (MHz)	EMISSION LEVEL (dBuV/m)	READ LEVEL (dBuV)	LIMIT (dBuV/m)	MARGIN (dB)	ANTENNA FACTOR (dB/m)	CABLE LOSS (dB)	PREAMP FACTOR (dB)	ANTENNA HEIGHT (cm)	TABLE ANGLE (Degree)	REMARK
2386	52.4	50.69	54	-1.6	31.8	5.4	35.49	131	181	Average
2386	64.6	62.89	74	-9.4	31.8	5.4	35.49	131	181	Peak
2437	104.41	102.56			31.85	5.46	35.46	100	228	Average
2437	112.59	110.74			31.85	5.46	35.46	100	228	Peak
2486	48.61	46.62	54	-5.39	31.88	5.53	35.42	139	228	Average
2486	61.84	59.85	74	-12.16	31.88	5.53	35.42	139	228	Peak

ANTENNA POLARITY & TEST DISTANCE: VERTICAL AT 3 M										
FREQ. (MHz)	EMISSION LEVEL (dBuV/m)	READ LEVEL (dBuV)	LIMIT (dBuV/m)	MARGIN (dB)	ANTENNA FACTOR (dB/m)	CABLE LOSS (dB)	PREAMP FACTOR (dB)	ANTENNA HEIGHT (cm)	TABLE ANGLE (Degree)	REMARK
2388	52.98	51.27	54	-1.02	31.8	5.4	35.49	105	265	Average
2388	65.37	63.66	74	-8.63	31.8	5.4	35.49	105	265	Peak
2437	103.81	101.96			31.85	5.46	35.46	104	266	Average
2437	111.26	109.41			31.85	5.46	35.46	104	266	Peak
2484	45.43	43.47	54	-8.57	31.88	5.5	35.42	105	266	Average
2484	59.09	57.13	74	-14.91	31.88	5.5	35.42	105	266	Peak

## REMARKS:

- Emission Level = Read Level + Antenna Factor + Cable Loss - Preamp Factor  
Margin value = Emission level – Limit value
- 2437MHz: Fundamental frequency.



A D T

EUT TEST CONDITION		MEASUREMENT DETAIL	
CHANNEL	Channel 11	FREQUENCY RANGE	1GHz ~ 25GHz
INPUT POWER	120Vac, 60 Hz	DETECTOR FUNCTION	Peak (PK) Average (AV)
ENVIRONMENTAL CONDITIONS	25deg. C, 65%RH	TESTED BY	Charles Hsiao

ANTENNA POLARITY & TEST DISTANCE: HORIZONTAL AT 3 M										
FREQ. (MHz)	EMISSION LEVEL (dBuV/m)	READ LEVEL (dBuV)	LIMIT (dBuV/m)	MARGIN (dB)	ANTENNA FACTOR (dB/m)	CABLE LOSS (dB)	PREAMP FACTOR (dB)	ANTENNA HEIGHT (cm)	TABLE ANGLE (Degree)	REMARK
2382	42.28	40.59	54	-11.72	31.78	5.4	35.49	100	235	Average
2382	56.03	54.34	74	-17.97	31.78	5.4	35.49	100	235	Peak
2462	99.75	97.82			31.87	5.5	35.44	100	235	Average
2462	107.96	106.03			31.87	5.5	35.44	100	235	Peak
2484	49.21	47.25	54	-4.79	31.88	5.5	35.42	100	228	Average
2484	63.73	61.77	74	-10.27	31.88	5.5	35.42	100	228	Peak

ANTENNA POLARITY & TEST DISTANCE: VERTICAL AT 3 M										
FREQ. (MHz)	EMISSION LEVEL (dBuV/m)	READ LEVEL (dBuV)	LIMIT (dBuV/m)	MARGIN (dB)	ANTENNA FACTOR (dB/m)	CABLE LOSS (dB)	PREAMP FACTOR (dB)	ANTENNA HEIGHT (cm)	TABLE ANGLE (Degree)	REMARK
2366	42.23	40.59	54	-11.77	31.76	5.37	35.49	102	271	Average
2366	55.86	54.22	74	-18.14	31.76	5.37	35.49	102	271	Peak
2462	98.56	96.63			31.87	5.5	35.44	102	271	Average
2462	106.27	104.34			31.87	5.5	35.44	102	271	Peak
2484	47.71	45.75	54	-6.29	31.88	5.5	35.42	114	271	Average
2484	62.24	60.28	74	-11.76	31.88	5.5	35.42	114	271	Peak

## REMARKS:

- Emission Level = Read Level + Antenna Factor + Cable Loss - Preamp Factor  
Margin value = Emission level – Limit value
- 2462MHz: Fundamental frequency.

**802.11n (40MHz)**

EUT TEST CONDITION		MEASUREMENT DETAIL	
CHANNEL	Channel 3	FREQUENCY RANGE	1GHz ~ 25GHz
INPUT POWER	120Vac, 60 Hz	DETECTOR FUNCTION	Peak (PK) Average (AV)
ENVIRONMENTAL CONDITIONS	25deg. C, 65%RH	TESTED BY	Charles Hsiao

**ANTENNA POLARITY & TEST DISTANCE: HORIZONTAL AT 3 M**

FREQ. (MHz)	EMISSION LEVEL (dBuV/m)	READ LEVEL (dBuV)	LIMIT (dBuV/m)	MARGIN (dB)	ANTENNA FACTOR (dB/m)	CABLE LOSS (dB)	PREAMP FACTOR (dB)	ANTENNA HEIGHT (cm)	TABLE ANGLE (Degree)	REMARK
2390	52.5	50.77	54	-1.5	31.8	5.4	35.47	131	209	Average
2390	62.95	61.22	74	-11.05	31.8	5.4	35.47	131	209	Peak
2422	95.26	93.46			31.83	5.43	35.46	100	213	Average
2422	102.06	100.26			31.83	5.43	35.46	100	213	Peak
2500	41.63	39.61	54	-12.37	31.9	5.53	35.41	100	213	Average
2500	55.79	53.77	74	-18.21	31.9	5.53	35.41	100	213	Peak

**ANTENNA POLARITY & TEST DISTANCE: VERTICAL AT 3 M**

FREQ. (MHz)	EMISSION LEVEL (dBuV/m)	READ LEVEL (dBuV)	LIMIT (dBuV/m)	MARGIN (dB)	ANTENNA FACTOR (dB/m)	CABLE LOSS (dB)	PREAMP FACTOR (dB)	ANTENNA HEIGHT (cm)	TABLE ANGLE (Degree)	REMARK
2388	52.88	51.17	54	-1.12	31.8	5.4	35.49	105	269	Average
2388	63.77	62.06	74	-10.23	31.8	5.4	35.49	105	269	Peak
2422	94.36	92.56			31.83	5.43	35.46	105	268	Average
2422	101.91	100.11			31.83	5.43	35.46	105	268	Peak
2484	41.48	39.52	54	-12.52	31.88	5.5	35.42	105	268	Average
2484	56.07	54.11	74	-17.93	31.88	5.5	35.42	105	268	Peak

**REMARKS:**

- Emission Level = Read Level + Antenna Factor + Cable Loss - Preamp Factor  
Margin value = Emission level – Limit value
- 2422MHz: Fundamental frequency.



A D T

EUT TEST CONDITION		MEASUREMENT DETAIL	
CHANNEL	Channel 6	FREQUENCY RANGE	1GHz ~ 25GHz
INPUT POWER	120Vac, 60 Hz	DETECTOR FUNCTION	Peak (PK) Average (AV)
ENVIRONMENTAL CONDITIONS	25deg. C, 65%RH	TESTED BY	Charles Hsiao

ANTENNA POLARITY & TEST DISTANCE: HORIZONTAL AT 3 M										
FREQ. (MHz)	EMISSION LEVEL (dBuV/m)	READ LEVEL (dBuV)	LIMIT (dBuV/m)	MARGIN (dB)	ANTENNA FACTOR (dB/m)	CABLE LOSS (dB)	PREAMP FACTOR (dB)	ANTENNA HEIGHT (cm)	TABLE ANGLE (Degree)	REMARK
2390	50.3	48.57	54	-3.7	31.8	5.4	35.47	102	235	Average
2390	63.73	62	74	-10.27	31.8	5.4	35.47	102	235	Peak
2437	95.81	93.96			31.85	5.46	35.46	100	236	Average
2437	103.62	101.77			31.85	5.46	35.46	100	236	Peak
2492	43.33	41.31	54	-10.67	31.9	5.53	35.41	100	236	Average
2492	56.19	54.17	74	-17.81	31.9	5.53	35.41	100	236	Peak

ANTENNA POLARITY & TEST DISTANCE: VERTICAL AT 3 M										
FREQ. (MHz)	EMISSION LEVEL (dBuV/m)	READ LEVEL (dBuV)	LIMIT (dBuV/m)	MARGIN (dB)	ANTENNA FACTOR (dB/m)	CABLE LOSS (dB)	PREAMP FACTOR (dB)	ANTENNA HEIGHT (cm)	TABLE ANGLE (Degree)	REMARK
<b>2390</b>	<b>52.99</b>	<b>51.26</b>	<b>54</b>	<b>-1.01</b>	<b>31.8</b>	<b>5.4</b>	<b>35.47</b>	<b>104</b>	<b>271</b>	<b>Average</b>
2390	66.85	65.12	74	-7.15	31.8	5.4	35.47	104	271	Peak
2437	95.31	93.46			31.85	5.46	35.46	102	271	Average
2437	102.3	100.45			31.85	5.46	35.46	102	271	Peak
2500	43.83	41.81	54	-10.17	31.9	5.53	35.41	102	271	Average
2500	56.4	54.38	74	-17.6	31.9	5.53	35.41	102	271	Peak

## REMARKS:

- Emission Level = Read Level + Antenna Factor + Cable Loss - Preamp Factor  
Margin value = Emission level – Limit value
- 2437MHz: Fundamental frequency.



A D T

EUT TEST CONDITION		MEASUREMENT DETAIL	
CHANNEL	Channel 9	FREQUENCY RANGE	1GHz ~ 25GHz
INPUT POWER	120Vac, 60 Hz	DETECTOR FUNCTION	Peak (PK) Average (AV)
ENVIRONMENTAL CONDITIONS	25deg. C, 65%RH	TESTED BY	Charles Hsiao

ANTENNA POLARITY & TEST DISTANCE: HORIZONTAL AT 3 M										
FREQ. (MHz)	EMISSION LEVEL (dBuV/m)	READ LEVEL (dBuV)	LIMIT (dBuV/m)	MARGIN (dB)	ANTENNA FACTOR (dB/m)	CABLE LOSS (dB)	PREAMP FACTOR (dB)	ANTENNA HEIGHT (cm)	TABLE ANGLE (Degree)	REMARK
2362	43.73	42.1	54	-10.27	31.76	5.37	35.5	100	234	Average
2362	56.97	55.34	74	-17.03	31.76	5.37	35.5	100	234	Peak
2452	95.51	93.64			31.85	5.46	35.44	100	234	Average
2452	103.09	101.22			31.85	5.46	35.44	100	234	Peak
2484	47.68	45.72	54	-6.32	31.88	5.5	35.42	100	228	Average
2484	61.11	59.15	74	-12.89	31.88	5.5	35.42	100	228	Peak

ANTENNA POLARITY & TEST DISTANCE: VERTICAL AT 3 M										
FREQ. (MHz)	EMISSION LEVEL (dBuV/m)	READ LEVEL (dBuV)	LIMIT (dBuV/m)	MARGIN (dB)	ANTENNA FACTOR (dB/m)	CABLE LOSS (dB)	PREAMP FACTOR (dB)	ANTENNA HEIGHT (cm)	TABLE ANGLE (Degree)	REMARK
2390	44.2	42.47	54	-9.8	31.8	5.4	35.47	100	271	Average
2390	56	54.27	74	-18	31.8	5.4	35.47	100	271	Peak
2452	95.21	93.34			31.85	5.46	35.44	100	271	Average
2452	102.27	100.4			31.85	5.46	35.44	100	271	Peak
2486	48.11	46.12	54	-5.89	31.88	5.53	35.42	115	271	Average
2486	60.5	58.51	74	-13.5	31.88	5.53	35.42	115	271	Peak

## REMARKS:

- Emission Level = Read Level + Antenna Factor + Cable Loss - Preamp Factor  
Margin value = Emission level – Limit value
- 2452MHz: Fundamental frequency.



**Mode B (1Tx)**
**802.11g**

EUT TEST CONDITION		MEASUREMENT DETAIL	
CHANNEL	Channel 6	FREQUENCY RANGE	1GHz ~ 25GHz
INPUT POWER	120Vac, 60 Hz	DETECTOR FUNCTION	Peak (PK) Average (AV)
ENVIRONMENTAL CONDITIONS	25deg. C, 65%RH	TESTED BY	Charles Hsiao

**ANTENNA POLARITY & TEST DISTANCE: HORIZONTAL AT 3 M**

FREQ. (MHz)	EMISSION LEVEL (dBuV/m)	READ LEVEL (dBuV)	LIMIT (dBuV/m)	MARGIN (dB)	ANTENNA FACTOR (dB/m)	CABLE LOSS (dB)	PREAMP FACTOR (dB)	ANTENNA HEIGHT (cm)	TABLE ANGLE (Degree)	REMARK
2388	48.6	46.89	54	-5.4	31.8	5.4	35.49	100	157	Average
2388	62.24	60.53	74	-11.76	31.8	5.4	35.49	100	157	Peak
2437	103.31	101.46			31.85	5.46	35.46	100	157	Average
2437	111.42	109.57			31.85	5.46	35.46	100	157	Peak
2488	47.51	45.5	54	-6.49	31.9	5.53	35.42	100	157	Average
2488	59.25	57.24	74	-14.75	31.9	5.53	35.42	100	157	Peak

**ANTENNA POLARITY & TEST DISTANCE: VERTICAL AT 3 M**

FREQ. (MHz)	EMISSION LEVEL (dBuV/m)	READ LEVEL (dBuV)	LIMIT (dBuV/m)	MARGIN (dB)	ANTENNA FACTOR (dB/m)	CABLE LOSS (dB)	PREAMP FACTOR (dB)	ANTENNA HEIGHT (cm)	TABLE ANGLE (Degree)	REMARK
2390	49.1	47.37	54	-4.9	31.8	5.4	35.47	117	269	Average
2390	60.94	59.21	74	-13.06	31.8	5.4	35.47	117	269	Peak
2437	101.01	99.16			31.85	5.46	35.46	117	269	Average
2437	109.03	107.18			31.85	5.46	35.46	117	269	Peak
2484	45.01	43.05	54	-8.99	31.88	5.5	35.42	117	269	Average
2484	57.64	55.68	74	-16.36	31.88	5.5	35.42	117	269	Peak

**REMARKS:**

- Emission Level = Read Level + Antenna Factor + Cable Loss - Preamp Factor  
Margin value = Emission level – Limit value
- 2437MHz: Fundamental frequency.

**Mode B (2Tx)**
**802.11n (40MHz)**

EUT TEST CONDITION		MEASUREMENT DETAIL	
CHANNEL	Channel 6	FREQUENCY RANGE	1GHz ~ 25GHz
INPUT POWER	120Vac, 60 Hz	DETECTOR FUNCTION	Peak (PK) Average (AV)
ENVIRONMENTAL CONDITIONS	25deg. C, 65%RH	TESTED BY	Charles Hsiao

**ANTENNA POLARITY & TEST DISTANCE: HORIZONTAL AT 3 M**

FREQ. (MHz)	EMISSION LEVEL (dBuV/m)	READ LEVEL (dBuV)	LIMIT (dBuV/m)	MARGIN (dB)	ANTENNA FACTOR (dB/m)	CABLE LOSS (dB)	PREAMP FACTOR (dB)	ANTENNA HEIGHT (cm)	TABLE ANGLE (Degree)	REMARK
2390	49.84	48.11	54	-4.16	31.8	5.4	35.47	101	233	Average
2390	63.42	61.69	74	-10.58	31.8	5.4	35.47	101	233	Peak
2437	97.11	95.26			31.85	5.46	35.46	100	234	Average
2437	104.78	102.93			31.85	5.46	35.46	100	234	Peak
2492	44.66	42.64	54	-9.34	31.9	5.53	35.41	125	234	Average
2492	57.3	55.28	74	-16.7	31.9	5.53	35.41	125	234	Peak

**ANTENNA POLARITY & TEST DISTANCE: VERTICAL AT 3 M**

FREQ. (MHz)	EMISSION LEVEL (dBuV/m)	READ LEVEL (dBuV)	LIMIT (dBuV/m)	MARGIN (dB)	ANTENNA FACTOR (dB/m)	CABLE LOSS (dB)	PREAMP FACTOR (dB)	ANTENNA HEIGHT (cm)	TABLE ANGLE (Degree)	REMARK
2390	50.2	48.47	54	-3.8	31.8	5.4	35.47	105	268	Average
2390	63.48	61.75	74	-10.52	31.8	5.4	35.47	105	268	Peak
2437	95.61	93.76			31.85	5.46	35.46	116	268	Average
2437	102.67	100.82			31.85	5.46	35.46	116	268	Peak
2488	44.23	42.22	54	-9.77	31.9	5.53	35.42	116	268	Average
2488	56.28	54.27	74	-17.72	31.9	5.53	35.42	116	268	Peak

**REMARKS:**

- Emission Level = Read Level + Antenna Factor + Cable Loss - Preamp Factor  
Margin value = Emission level – Limit value
- 2437MHz: Fundamental frequency.

**Below 1GHz Data:**
**Mode A**
**802.11g**

EUT TEST CONDITION		MEASUREMENT DETAIL	
CHANNEL	Channel 6	FREQUENCY RANGE	30MHz ~ 1GHz
INPUT POWER	120Vac, 60 Hz	DETECTOR FUNCTION	Peak (PK) Quasi Peak (QP)
ENVIRONMENTAL CONDITIONS	25deg. C, 65%RH	TESTED BY	Charles Hsiao

ANTENNA POLARITY & TEST DISTANCE: HORIZONTAL AT 3 M										
FREQ. (MHz)	EMISSION LEVEL (dBuV/m)	READ LEVEL (dBuV)	LIMIT (dBuV/m)	MARGIN (dB)	ANTENNA FACTOR (dB/m)	CABLE LOSS (dB)	PREAMP FACTOR (dB)	ANTENNA HEIGHT (cm)	TABLE ANGLE (Degree)	REMARK
146.64	28.76	49.8	43.5	-14.74	9.85	1.38	32.27	166	343	Peak
208.2	35.44	54.83	43.5	-8.06	11.22	1.65	32.26	100	245	QP
267.6	27.53	44.21	46	-18.47	13.49	1.94	32.11	127	52	Peak
533.1	39.12	48.02	46	-6.88	20.57	2.7	32.17	153	331	Peak
714.4	36.17	41.89	46	-9.83	23.27	3.11	32.1	174	44	Peak
881	32.15	35.42	46	-13.85	24.84	3.49	31.6	188	321	Peak
ANTENNA POLARITY & TEST DISTANCE: VERTICAL AT 3 M										
FREQ. (MHz)	EMISSION LEVEL (dBuV/m)	READ LEVEL (dBuV)	LIMIT (dBuV/m)	MARGIN (dB)	ANTENNA FACTOR (dB/m)	CABLE LOSS (dB)	PREAMP FACTOR (dB)	ANTENNA HEIGHT (cm)	TABLE ANGLE (Degree)	REMARK
144.21	31.38	52.6	43.5	-12.12	9.67	1.38	32.27	144	21	Peak
206.58	37.86	57.31	43.5	-5.64	11.17	1.65	32.27	100	215	QP
279.21	26.51	42.86	46	-19.49	13.74	2.03	32.12	127	121	Peak
533.1	41.76	50.66	46	-4.24	20.57	2.7	32.17	153	111	Peak
708.8	36.8	42.6	46	-9.2	23.19	3.11	32.1	166	333	Peak
884.5	33.04	36.25	46	-12.96	24.88	3.49	31.58	184	159	Peak

**REMARKS:**

Emission Level = Read Level + Antenna Factor + Cable Loss - Preamp Factor

Margin value = Emission level – Limit value



A D T

**Mode B**

**802.11g**

EUT TEST CONDITION		MEASUREMENT DETAIL	
CHANNEL	Channel 6	FREQUENCY RANGE	30MHz ~ 1GHz
INPUT POWER	120Vac, 60 Hz	DETECTOR FUNCTION	Peak (PK)
ENVIRONMENTAL CONDITIONS	25deg. C, 65%RH	TESTED BY	Charles Hsiao

**ANTENNA POLARITY & TEST DISTANCE: HORIZONTAL AT 3 M**

FREQ. (MHz)	EMISSION LEVEL (dBuV/m)	READ LEVEL (dBuV)	LIMIT (dBuV/m)	MARGIN (dB)	ANTENNA FACTOR (dB/m)	CABLE LOSS (dB)	PREAMP FACTOR (dB)	ANTENNA HEIGHT (cm)	TABLE ANGLE (Degree)	REMARK
190.65	35.34	55.59	43.5	-8.16	10.4	1.61	32.26	135	190	Peak
227.37	34.71	53.03	46	-11.29	12.02	1.85	32.19	120	157	Peak
265.98	36.42	53.14	46	-9.58	13.45	1.94	32.11	165	98	Peak
533.1	37.64	46.54	46	-8.36	20.57	2.7	32.17	153	331	Peak
666.8	30.71	36.82	46	-15.29	22.97	3.05	32.13	170	159	Peak
797	39.32	43.64	46	-6.68	24.42	3.32	32.06	124	224	Peak

**ANTENNA POLARITY & TEST DISTANCE: VERTICAL AT 3 M**

FREQ. (MHz)	EMISSION LEVEL (dBuV/m)	READ LEVEL (dBuV)	LIMIT (dBuV/m)	MARGIN (dB)	ANTENNA FACTOR (dB/m)	CABLE LOSS (dB)	PREAMP FACTOR (dB)	ANTENNA HEIGHT (cm)	TABLE ANGLE (Degree)	REMARK
125.04	31.21	53.1	43.5	-12.29	8.97	1.38	32.24	138	189	Peak
192.81	34.02	54.17	43.5	-9.48	10.51	1.61	32.27	105	111	Peak
267.06	32.5	49.18	46	-13.5	13.49	1.94	32.11	126	6	Peak
533.1	38.42	47.32	46	-7.58	20.57	2.7	32.17	138	41	Peak
666.8	37.08	43.19	46	-8.92	22.97	3.05	32.13	166	268	Peak
797.7	41.01	45.33	46	-4.99	24.42	3.32	32.06	141	147	Peak

**REMARKS:**

Emission Level = Read Level + Antenna Factor + Cable Loss - Preamp Factor

Margin value = Emission level – Limit value

## 4.2 Conducted Emission Measurement

### 4.2.1 Limits of Conducted Emission Measurement

Frequency (MHz)	Conducted Limit (dBuV)	
	Quasi-peak	Average
0.15 - 0.5	66 - 56	56 - 46
0.50 - 5.0	56	46
5.0 - 30.0	60	50

Note: 1. The lower limit shall apply at the transition frequencies.

2. The limit decreases in line with the logarithm of the frequency in the range of 0.15 to 0.50MHz.

### 4.2.2 Test Instruments

Description & Manufacturer	Model No.	Serial No.	Date of Calibration	Due Date of Calibration
Test Receiver ROHDE & SCHWARZ	ESCI	100613	Nov. 11, 2014	Nov. 10, 2015
RF signal cable Woken	5D-FB	Cable-HYC01-01	Dec. 26, 2014	Dec. 25, 2015
LISN ROHDE & SCHWARZ (EUT)	ESH3-Z5	835239/001	Mar. 02, 2015	Mar. 01, 2016
LISN ROHDE & SCHWARZ (Peripheral)	ESH3-Z5	100311	Jul. 24, 2015	Jul. 23, 2016
Software ADT	BV ADT_Cond_ V7.3.7.3	NA	NA	NA

Note: 1. The calibration interval of the above test instruments is 12 months and the calibrations are traceable to NML/ROC and NIST/USA.

2. The test was performed in HwaYa Shielded Room 1.

3. The VCCI Site Registration No. is C-2040.

#### 4.2.3 Test Procedures

- a. The EUT was placed 0.4 meters from the conducting wall of the shielded room with EUT being connected to the power mains through a line impedance stabilization network (LISN). Other support units were connected to the power mains through another LISN. The two LISNs provide 50 ohm / 50uH of coupling impedance for the measuring instrument.
- b. Both lines of the power mains connected to the EUT were checked for maximum conducted interference.
- c. The frequency range from 150 kHz to 30MHz was searched. Emission levels under (Limit - 20dB) was not recorded.

**NOTE:** All modes of operation were investigated and the worst-case emissions are reported.

#### 4.2.4 Deviation from Test Standard

No deviation.

#### 4.2.5 Test Setup

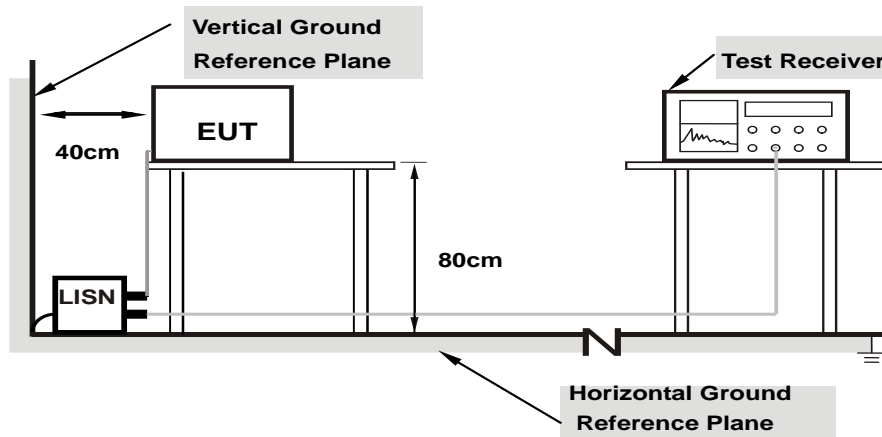

For the actual test configuration, please refer to the attached file (Test Setup Photo).

#### 4.2.6 EUT Operating Conditions

Same as 4.1.6.

### 4.2.7 Test Results

#### Mode A

Phase	Line (L)	Detector Function	Quasi-Peak (QP) / Average (AV)
-------	----------	-------------------	--------------------------------

No	Frequency (MHz)	Correction Factor (dB)	Reading Value (dBuV)		Emission Level (dBuV)		Limit (dBuV)		Margin (dB)	
			Q.P.	AV.	Q.P.	AV.	Q.P.	AV.	Q.P.	AV.
1	0.15000	0.05	44.60	25.08	44.65	25.13	66.00	56.00	-21.35	-30.87
2	0.18910	0.06	49.02	32.98	49.08	33.04	64.08	54.08	-15.00	-21.04
3	0.24384	0.06	42.81	23.88	42.87	23.94	61.96	51.96	-19.09	-28.02
4	0.30640	0.06	36.91	18.89	36.97	18.95	60.07	50.07	-23.10	-31.12
5	2.37870	0.13	27.36	16.19	27.49	16.32	56.00	46.00	-28.51	-29.68
6	4.32979	0.20	32.80	21.99	33.00	22.19	56.00	46.00	-23.00	-23.81

#### REMARKS:

1. Q.P. and AV. are abbreviations of quasi-peak and average individually.
2. The emission levels of other frequencies were very low against the limit.
3. Margin value = Emission level - Limit value
4. Correction factor = Insertion loss + Cable loss
5. Emission Level = Correction Factor + Reading Value.

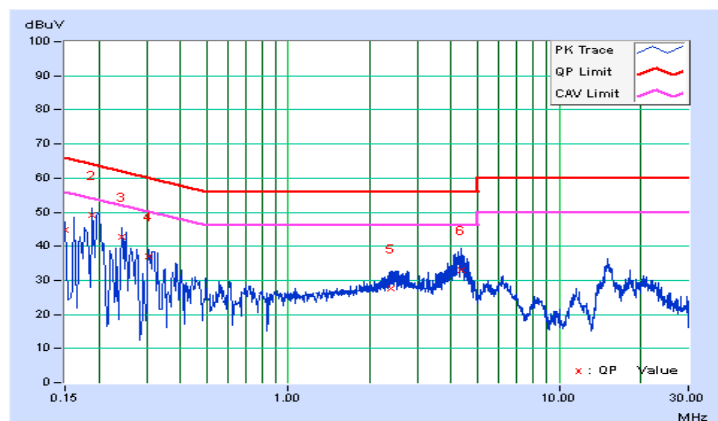

Phase	Neutral (N)	Detector Function	Quasi-Peak (QP) / Average (AV)
-------	-------------	-------------------	--------------------------------

No	Frequency (MHz)	Correction Factor (dB)	Reading Value (dBuV)		Emission Level (dBuV)		Limit (dBuV)		Margin (dB)	
			Q.P.	AV.	Q.P.	AV.	Q.P.	AV.	Q.P.	AV.
1	0.15391	0.05	44.32	25.57	44.37	25.62	65.79	55.79	-21.42	-30.17
<b>2</b>	<b>0.18508</b>	<b>0.05</b>	<b>50.56</b>	<b>34.11</b>	<b>50.61</b>	<b>34.16</b>	<b>64.25</b>	<b>54.25</b>	<b>-13.64</b>	<b>-20.09</b>
3	0.25526	0.05	43.20	26.81	43.25	26.86	61.58	51.58	-18.33	-24.72
4	0.33768	0.06	35.99	17.64	36.05	17.70	59.26	49.26	-23.21	-31.56
5	0.39242	0.06	33.33	17.34	33.39	17.40	58.01	48.01	-24.62	-30.61
6	0.73259	0.07	29.72	16.92	29.79	16.99	56.00	46.00	-26.21	-29.01

**REMARKS:**

1. Q.P. and AV. are abbreviations of quasi-peak and average individually.
2. The emission levels of other frequencies were very low against the limit.
3. Margin value = Emission level - Limit value
4. Correction factor = Insertion loss + Cable loss
5. Emission Level = Correction Factor + Reading Value.

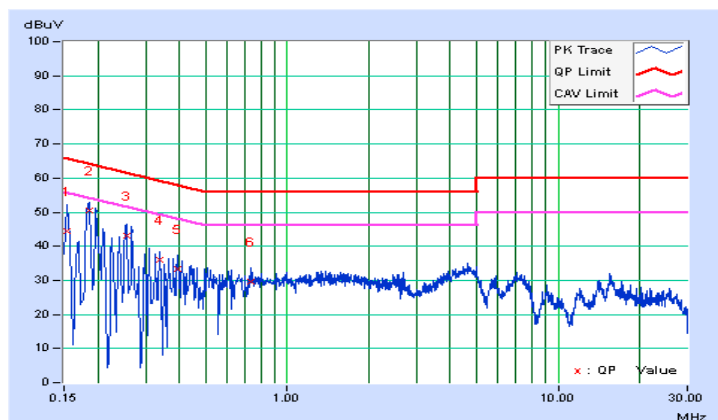



**Mode B**

Phase	Line (L)	Detector Function	Quasi-Peak (QP) / Average (AV)
-------	----------	-------------------	--------------------------------

No	Frequency (MHz)	Correction Factor (dB)	Reading Value (dBuV)		Emission Level (dBuV)		Limit (dBuV)		Margin (dB)	
			Q.P.	AV.	Q.P.	AV.	Q.P.	AV.	Q.P.	AV.
1	0.15000	0.05	38.36	23.57	38.41	23.62	66.00	56.00	-27.59	-32.38
2	0.17737	0.06	49.32	30.69	49.38	30.75	64.61	54.61	-15.23	-23.86
3	0.23602	0.06	36.73	19.20	36.79	19.26	62.24	52.24	-25.45	-32.98
4	0.30294	0.06	32.74	18.49	32.80	18.55	60.16	50.16	-27.36	-31.61
5	2.37870	0.13	22.41	15.06	22.54	15.19	56.00	46.00	-33.46	-30.81
6	4.03263	0.19	25.85	18.36	26.04	18.55	56.00	46.00	-29.96	-27.45

**REMARKS:**

1. Q.P. and AV. are abbreviations of quasi-peak and average individually.
2. The emission levels of other frequencies were very low against the limit.
3. Margin value = Emission level - Limit value
4. Correction factor = Insertion loss + Cable loss
5. Emission Level = Correction Factor + Reading Value.

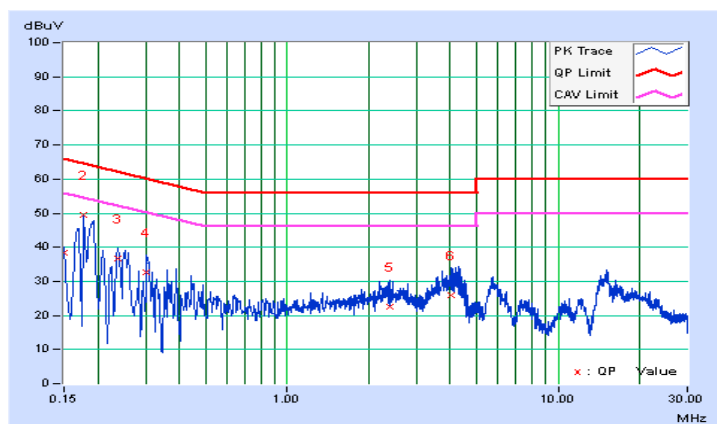

Phase	Neutral (N)	Detector Function	Quasi-Peak (QP) / Average (AV)
-------	-------------	-------------------	--------------------------------

No	Frequency (MHz)	Correction Factor (dB)	Reading Value (dBuV)		Emission Level (dBuV)		Limit (dBuV)		Margin (dB)	
			Q.P.	AV.	Q.P.	AV.	Q.P.	AV.	Q.P.	AV.
1	0.15391	0.05	41.93	24.52	41.98	24.57	65.79	55.79	-23.81	-31.22
2	0.18122	0.05	50.06	25.62	50.11	25.67	64.43	54.43	-14.32	-28.76
3	0.25948	0.05	39.12	23.26	39.17	23.31	61.45	51.45	-22.28	-28.14
4	0.32595	0.06	35.32	19.44	35.38	19.50	59.55	49.55	-24.18	-30.06
5	0.45107	0.06	31.46	16.94	31.52	17.00	56.86	46.86	-25.33	-29.85
6	0.67394	0.07	30.09	17.54	30.16	17.61	56.00	46.00	-25.84	-28.39

**REMARKS:**

1. Q.P. and AV. are abbreviations of quasi-peak and average individually.
2. The emission levels of other frequencies were very low against the limit.
3. Margin value = Emission level - Limit value
4. Correction factor = Insertion loss + Cable loss
5. Emission Level = Correction Factor + Reading Value.

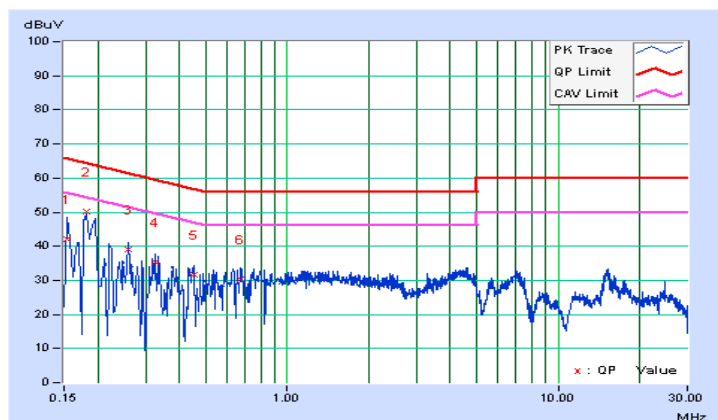



## 5 Pictures of Test Arrangements

Please refer to the attached file (Test Setup Photo).

## Appendix – Information on the Testing Laboratories

We, Bureau Veritas Consumer Products Services (H.K.) Ltd., Taoyuan Branch, were founded in 1988 to provide our best service in EMC, Radio, Telecom and Safety consultation. Our laboratories are accredited and approved according to ISO/IEC 17025.

If you have any comments, please feel free to contact us at the following:

### **Linko EMC/RF Lab**

Tel: 886-2-26052180

Fax: 886-2-26051924

### **Hsin Chu EMC/RF/Telecom Lab**

Tel: 886-3-5935343

Fax: 886-3-5935342

### **Hwa Ya EMC/RF/Safety Lab**

Tel: 886-3-3183232

Fax: 886-3-3270892

**Email:** [service.adt@tw.bureauveritas.com](mailto:service.adt@tw.bureauveritas.com)

**Web Site:** [www.bureauveritas-adt.com](http://www.bureauveritas-adt.com)

The address and road map of all our labs can be found in our web site also.

--- END ---