



**FCC 47 CFR PART 15 SUBPART C &
INDUSTRY CANADA RSS-210**

TEST REPORT

For

Tablet Computer

Model: TP00064B

Trade Name: Lenovo

Issued to

COMPAL ELECTRONICS INC

No.581, Ruiguang Rd., Neihu District, Taipei City 11492, Taiwan (R.O.C)

Issued by

Compliance Certification Services Inc.

**No.11, Wugong 6th Rd., Wugu Dist.,
New Taipei City 24891, Taiwan. (R.O.C.)**

<http://www.ccsrf.com>

service@ccsrf.com

Issued Date: March 6, 2015



Note: This report shall not be reproduced except in full, without the written approval of Compliance Certification Services Inc. This document may be altered or revised by Compliance Certification Services Inc. personnel only, and shall be noted in the revision section of the document.



Revision History

Rev.	Issue Date	Revisions	Effect Page	Revised By
00	March 6, 2015	Initial Issue	ALL	Doris Chu



TABLE OF CONTENTS

1. TEST RESULT CERTIFICATION.....	4
2. EUT DESCRIPTION	5
3. TEST METHODOLOGY	6
3.1 EUT CONFIGURATION	6
3.2 EUT EXERCISE.....	6
3.3 GENERAL TEST PROCEDURES.....	6
3.4 FCC PART 15.205 RESTRICTED BANDS OF OPERATIONS.....	7
3.5 DESCRIPTION OF TEST MODES	8
4. INSTRUMENT CALIBRATION.....	9
4.1 MEASURING INSTRUMENT CALIBRATION	9
4.2 MEASUREMENT EQUIPMENT USED	9
4.3 MEASUREMENT UNCERTAINTY	9
5. FACILITIES AND ACCREDITATIONS	10
5.1 FACILITIES	10
5.2 EQUIPMENT.....	10
5.3 LABORATORY ACCREDITATIONS AND LISTING.....	10
5.4 TABLE OF ACCREDITATIONS AND LISTINGS.....	11
6. SETUP OF EQUIPMENT UNDER TEST	12
6.1 SETUP CONFIGURATION OF EUT.....	12
6.2 SUPPORT EQUIPMENT	12
7. FCC PART 15.247 REQUIREMENTS & RSS-210 REQUIREMENTS.....	13
7.1 PEAK POWER.....	13
7.2 AVERAGE POWER	15
7.3 BAND EDGES MEASUREMENT	17
7.4 RADIATED EMISSIONS	31
7.5 POWERLINE CONDUCTED EMISSIONS.....	44
APPENDIX I PHOTOGRAPHS OF TEST SETUP.....	47



1. TEST RESULT CERTIFICATION

Applicant: COMPAL ELECTRONICS INC
No.581, Ruiguang Rd., Neihu District, Taipei City 11492, Taiwan (R.O.C)

Manufacturer: COMPAL ELECTRONICS INC
No.581, Ruiguang Rd., Neihu District, Taipei City 11492, Taiwan (R.O.C)

Equipment Under Test: Tablet Computer

Trade Name: Lenovo

Model: TP00064B

Date of Test: February 25 ~ March 2, 2015

APPLICABLE STANDARDS	
STANDARD	TEST RESULT
FCC 47 CFR Part 15 Subpart C & Industry Canada RSS-210 Issue 8 December, 2013	No non-compliance noted

We hereby certify that:

The above equipment was tested by Compliance Certification Services Inc. The test data, data evaluation, test procedures, and equipment configurations shown in this report were made in accordance with the procedures given in ANSI C63.10: 2013 and the energy emitted by the sample EUT tested as described in this report is in compliance with the requirements of FCC Rules Part 15.207, 15.209, 15.247 and Industry Canada RSS-210.

The test results of this report relate only to the tested sample EUT identified in this report.

Approved by:

Reviewed by:

Miller Lee
Manager
Compliance Certification Services Inc.

Angel Cheng
Section Manager
Compliance Certification Services Inc.



2. EUT DESCRIPTION

Product	Tablet Computer			
Trade Name	Lenovo			
Model Number	TP00064B			
Received Date	February 10, 2015			
Frequency Range	2412 ~ 2462 MHz			
Transmit Power	Mode	Frequency Range	Output power (dBm)	Output power (W)
	802.11b	2412 - 2462	19.20	0.08318
	802.11g	2412 - 2462	22.50	0.17783
	802.11n Standard-20 MHz	2412 - 2462	22.18	0.1652
Modulation Technique	IEEE 802.11b mode: DSSS (1, 2, 5.5 and 11 Mbps) IEEE 802.11g mode: OFDM (6, 9, 12, 18, 24, 36, 48 and 54 Mbps) IEEE 802.11n HT 20 MHz mode: OFDM (6.5, 7.2, 13, 14.4, 14.44, 19.5, 21.7, 26, 28.89, 28.9, 39, 43.3, 43.33 52, 57.78, 57.8, 58.5, 65.0, 72.2, 78, 86.67, 104, 115.56, 117, 130, 144.44 Mbps)			
Number of Channels	IEEE 802.11b/g mode: 11 Channels IEEE 802.11n HT 20 MHz mode: 11 Channels			
Antenna Specification	Pulse(Suzhou)Wireless Products Co., Ltd DC33001MT20 (MAIN): -2.58 dBi DC33001MT30 (AUX): -1.37 dBi			
Antenna Designation	Monopole Antenna			

Remark:

1. The sample selected for test was engineering sample that approximated to production product and was provided by manufacturer.
2. This submittal(s) (test report) is intended for FCC ID: **GKR-TP00064B** & **IC: 2533B-TP00064B** filing to comply with Section 15.207, 15.209 and 15.247 of the FCC Part 15, Subpart C Rules.



3. TEST METHODOLOGY

The tests documented in this report were performed in accordance with ANSI C63.10: 2013 and FCC CFR 47 Part 15.207, 15.209, 15.247 and DA00-705.

The tests documented in this report were performed in accordance with IC RSS-210, IC RSS-Gen, IC RSS-102, IC RSS-212, and ANSI C63.10: 2013.

This submittal(s) (test report) is intended for IC Certification with Industry Canada RSS-210.

3.1 EUT CONFIGURATION

The EUT configuration for testing is installed on RF field strength measurement to meet the Commissions requirement and operating in a manner that intends to maximize its emission characteristics in a continuous normal application.

3.2 EUT EXERCISE

The EUT was operated in the engineering mode to fix the TX frequency that was for the purpose of the measurements.

According to its specifications, the EUT must comply with the requirements of the Section 15.207, 15.209 and 15.247 under the FCC Rules Part 15 Subpart C.

The tests documented in this report were performed in accordance with IC RSS-210, IC RSS-Gen, IC RSS-102, and ANSI C63.10: 2013.

3.3 GENERAL TEST PROCEDURES

Conducted Emissions

The EUT is placed on the turntable, which is 0.8 m above ground plane. According to the requirements in Section 13.1.4.1 of ANSI C63.10: 2013 Conducted emissions from the EUT measured in the frequency range between 0.15 MHz and 30MHz using CISPR Quasi-peak and average detector modes.

Radiated Emissions

The EUT is placed on a turn table, which is 0.8 m above ground plane. The turntable shall rotate 360 degrees to determine the position of maximum emission level. EUT is set 3m away from the receiving antenna, which varied from 1m to 4m to find out the highest emission. And also, each emission was to be maximized by changing the polarization of receiving antenna both horizontal and vertical. In order to find out the maximum emissions, exploratory radiated emission measurements were made according to the requirements in Section 13.1.4.1 of ANSI C63.10: 2013.



3.4 FCC PART 15.205 RESTRICTED BANDS OF OPERATIONS

(a) Except as shown in paragraph (d) of this section, only spurious emissions are permitted in any of the frequency bands listed below:

MHz	MHz	MHz	GHz
0.090 - 0.110	16.42 - 16.423	399.9 - 410	4.5 - 5.15
¹ 0.495 - 0.505	16.69475 - 16.69525	608 - 614	5.35 - 5.46
2.1735 - 2.1905	16.80425 - 16.80475	960 - 1240	7.25 - 7.75
4.125 - 4.128	25.5 - 25.67	1300 - 1427	8.025 - 8.5
4.17725 - 4.17775	37.5 - 38.25	1435 - 1626.5	9.0 - 9.2
4.20725 - 4.20775	73 - 74.6	1645.5 - 1646.5	9.3 - 9.5
6.215 - 6.218	74.8 - 75.2	1660 - 1710	10.6 - 12.7
6.26775 - 6.26825	108 - 121.94	1718.8 - 1722.2	13.25 - 13.4
6.31175 - 6.31225	123 - 138	2200 - 2300	14.47 - 14.5
8.291 - 8.294	149.9 - 150.05	2310 - 2390	15.35 - 16.2
8.362 - 8.366	156.52475 -	2483.5 - 2500	17.7 - 21.4
8.37625 - 8.38675	156.52525	2655 - 2900	22.01 - 23.12
8.41425 - 8.41475	156.7 - 156.9	3260 - 3267	23.6 - 24.0
12.29 - 12.293	162.0125 - 167.17	3332 - 3339	31.2 - 31.8
12.51975 - 12.52025	167.72 - 173.2	3345.8 - 3358	36.43 - 36.5
12.57675 - 12.57725	240 - 285	3600 - 4400	(²)
13.36 - 13.41	322 - 335.4		

¹ Until February 1, 1999, this restricted band shall be 0.490-0.510 MHz.

² Above 38.6

(b) Except as provided in paragraphs (d) and (e), the field strength of emissions appearing within these frequency bands shall not exceed the limits shown in Section 15.209. At frequencies equal to or less than 1000 MHz, compliance with the limits in Section 15.209 shall be demonstrated using measurement instrumentation employing a CISPR quasi-peak detector. Above 1000 MHz, compliance with the emission limits in Section 15.209 shall be demonstrated based on the average value of the measured emissions. The provisions in Section 15.35 apply to these measurements.



3.5 DESCRIPTION OF TEST MODES

The EUT (Model: TP00064B) had been tested under operating condition.

The EUT is a 2x2 configuration spatial MIMO (2Tx & 2Rx) without beam forming function. The 2x2 configuration is implemented with three outside TX & RX chains (Chain 0 and Chain 1).

Software used to control the EUT for staying in continuous transmitting and receiving mode was programmed.

After verification, all tests carried out are with the worst-case test modes as shown below except radiated spurious emission below 1GHz and power line conducted emissions below 30MHz, which worst case was in normal link mode.

IEEE 802.11b mode:

Channel Low (2412MHz), Channel Mid (2437MHz) and Channel High (2462MHz) with 1Mbps data rate were chosen for full testing.

IEEE 802.11g mode:

Channel Low (2412MHz), Channel Mid (2437MHz) and Channel High (2462MHz) with 6Mbps data rate were chosen for full testing.

IEEE 802.11n HT 20 MHz mode:

Channel Low (2412MHz), Channel Mid (2437MHz) and Channel High (2462MHz) with 6.5Mbps data rate were chosen for full testing.

The field strength of spurious emission was measured in the following position: EUT stand-up position (Z axis), lie-down position (X, Y axis). The worst emission was found in stand-up position (Z axis) and the worst case was recorded.

Test items for conducted and radiated emission were performed for report. Other testing data please refer to module (Brand: Lenovo, Model: Tablet Computer, FCC ID: GKR-TP00064B, IC: 2533B-TP00064B)



4. INSTRUMENT CALIBRATION

4.1 MEASURING INSTRUMENT CALIBRATION

The measuring equipment, which was utilized in performing the tests documented herein, has been calibrated in accordance with the manufacturer's recommendations for utilizing calibration equipment, which is traceable to recognized national standards.

4.2 MEASUREMENT EQUIPMENT USED

Equipment Used for Emissions Measurement

Remark: Each piece of equipment is scheduled for calibration once a year and Loop Antenna is scheduled for calibration once three years.

Wugu 966 Chamber A				
Name of Equipment	Manufacturer	Model	Serial Number	Calibration Due
Spectrum Analyzer	Agilent	E4446A	US42510268	09/18/2015
EMI Test Receiver	R&S	ESCI	100064	05/30/2015
Bilog Antenna	Sunol Sciences	JB3	A030105	08/19/2015
Horn Antenna	EMCO	3117	00055165	01/26/2016
Turn Table	CCS	CC-T-1F	N/A	N.C.R
Antenna Tower	CCS	CC-A-1F	N/A	N.C.R
Controller	CCS	CC-C-1F	N/A	N.C.R
Test S/W	EZ-EMC (CCS-3A1RE)			

Conducted Emission room # B				
Name of Equipment	Manufacturer	Model	Serial Number	Calibration Due
EMI Test Receiver	R&S	ESCI	101073	09/18/2015
LISN	R&S	ENV216	101054	05/18/2015
LISN	SCHWARZBECK	NSLK 8127	8127-541	11/25/2015
Capacitive Voltage Probe	FCC	F-CVP-1	100185	03/09/2015
Test S/W	CCS-3A1-CE			

4.3 MEASUREMENT UNCERTAINTY

PARAMETER	UNCERTAINTY
3M Semi Anechoic Chamber / 30M~200M	+/- 4.0138
3M Semi Anechoic Chamber / 200M~1000M	+/- 3.9483
3M Semi Anechoic Chamber / 1G~8G	+/- 2.5975
3M Semi Anechoic Chamber / 8G~18G	+/- 2.6112
3M Semi Anechoic Chamber / 18G~26G	+/- 2.7389
3M Semi Anechoic Chamber / 26G~40G	+/- 2.9683

Remark: This uncertainty represents an expanded uncertainty expressed at approximately the 95% confidence level using a coverage factor of k=2.



5. FACILITIES AND ACCREDITATIONS

5.1 FACILITIES

All measurement facilities used to collect the measurement data are located at

No.139, Wugong Rd., Wugu Dist., New Taipei City 24891, Taiwan (R.O.C.)
Tel: 886-2-2298-4086 / Fax: 886-2-2298-1470

No.11, Wugong 6th Rd., Wugu Dist., New Taipei City 24891, Taiwan. (R.O.C.)
Tel: 886-2-2299-9720 / Fax: 886-2-2298-4045

No.81-1, Lane 210, Bade 2nd Rd., Lujhu Township, Taoyuan County 33841, TAIWAN,
R.O.C.
Tel: 886-3-324-0332 / Fax: 886-3-324-5235

The sites are constructed in conformance with the requirements of ANSI C63.7, ANSI C63.10: 2013 and CISPR Publication 22.

5.2 EQUIPMENT

Radiated emissions are measured with one or more of the following types of linearly polarized antennas: tuned dipole, biconical, log periodic, bi-log, and/or ridged waveguide, horn. Spectrum analyzers with pre-selectors and quasi-peak detectors are used to perform radiated measurements.

Conducted emissions are measured with Line Impedance Stabilization Networks and EMI Test Receivers.

Calibrated wideband preamplifiers, coaxial cables, and coaxial attenuators are also used for making measurements.



All receiving equipment conforms to CISPR Publication 16-1, "Radio Interference Measuring Apparatus and Measurement Methods."

5.3 LABORATORY ACCREDITATIONS AND LISTING

The test facilities used to perform radiated and conducted emissions tests are accredited by American Association for Laboratory Accreditation Program for the specific scope accreditation under Lab Code: 0824-01 to perform Electromagnetic Interference tests according to FCC Part 15 and CISPR 22 requirements. In addition, the test facilities are listed with Industry Canada, Certification and Engineering Bureau, IC 2324G-1 for 3M Semi Anechoic Chamber A, 2324G-2 for 3M Semi Anechoic Chamber B.



5.4 TABLE OF ACCREDITATIONS AND LISTINGS

Country	Agency	Scope of Accreditation	Logo
USA	FCC	3M Semi Anechoic Chamber (FCC MRA: TW1039) to perform FCC Part 15 measurements	 FCC MRA: TW1039
Taiwan	TAF	LP0002, RTTE01, FCC Method-47 CFR Part 15 Subpart C, D, E, RSS-210, RSS-310 IDA TS SRD, AS/NZS 4268, AS/NZS 4771, TS 12.1 & 12.2, ETSI EN 300 440-1, ETSI EN 300 440-2, ETSI EN 300 328, ETSI EN 300 220-1, ETSI EN 300 220-2, ETSI EN 301 893, ETSI EN 301 489-1/3/7/17 FCC OET Bulletin 65 + Supplement C, EN 50360, EN 50361, EN 50371, RSS 102, EN 50383, EN 50385, EN 50392, IEC 62209, CNS 14958-1, CNS 14959 FCC Method -47 CFR Part 15 Subpart B IEC / EN 61000-3-2, IEC / EN 61000-3-3, IEC / EN 61000-4-2/3/4/5/6/8/11	
Canada	Industry Canada	3M Semi Anechoic Chamber (IC 2324G-1 / IC 2324G-2) to perform	 IC 2324G-1 IC 2324G-2

* No part of this report may be used to claim or imply product endorsement by A2LA or any agency of the US Government.



6. SETUP OF EQUIPMENT UNDER TEST

6.1 SETUP CONFIGURATION OF EUT

See test photographs attached in Appendix II for the actual connections between EUT and support equipment.

6.2 SUPPORT EQUIPMENT

No.	Equipment	Model No.	Serial No.	FCC ID	Trade Name	Data Cable	Power Cord
	N/A						

Remark:

1. All the equipment/cables were placed in the worst-case configuration to maximize the emission during the test.
2. Grounding was established in accordance with the manufacturer's requirements and conditions for the intended use.



7. FCC PART 15.247 REQUIREMENTS & RSS-210 REQUIREMENTS

7.1 PEAK POWER

LIMIT

The maximum peak output power of the intentional radiator shall not exceed the following:

1. According to §15.247(b)(3), for systems using digital modulation in the bands of 902-928 MHz, 2400-2483.5 MHz, and 5725-5850 MHz: 1 Watt.
2. According to §15.247(b)(4), the conducted output power limit specified in paragraph (b) of this section is based on the use of antennas with directional gains that do not exceed 6 dBi. Except as shown in paragraph (c) of this section, if transmitting antennas of directional gain greater than 6 dBi are used, the conducted output power from the intentional radiator shall be reduced below the stated values in paragraphs (b)(1), (b)(2), and (b)(3) of this section, as appropriate, by the amount in dB that the directional gain of the antenna exceeds 6 dBi.

Test Configuration

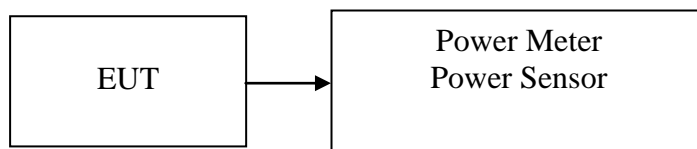

TEST PROCEDURE

The transmitter output is connected to the Power Meter. The Power Meter is set to the peak power detection.

TEST RESULTS

No non-compliance noted.



Test Data

Test mode: IEEE 802.11b mode

Channel	Frequency (MHz)	Output Power (dBm)	Output Power (W)	Limit (W)	Result
Low	2412	18.60	0.07244	1.00	PASS
Mid	2437	18.90	0.07762		PASS
High	2462	*19.20	0.08318		PASS

Test mode: IEEE 802.11g mode

Channel	Frequency (MHz)	Output Power (dBm)	Output Power (W)	Limit (W)	Result
Low	2412	22.40	0.17378	1.00	PASS
Mid	2437	*22.50	0.17783		PASS
High	2462	22.40	0.17378		PASS

Test mode: IEEE 802.11n HT 20 MHz mode

Channel	Frequency (MHz)	Chain 0 Output Power (dBm)	Chain 1 Output Power (dBm)	Total Output Power (dBm)	Output Power (W)	Limit (W)	Result
Low	2412	19.23	18.80	22.03	0.1596	1.00	PASS
Mid	2437	19.02	18.50	21.78	0.1506		PASS
High	2462	19.24	19.10	22.18	0.1652		PASS

Remark: Total Output Power (w) = Chain 0 (10^(Output Power /10)/1000) + Chain 1 (10^(Output Power /10)/1000)



7.2 AVERAGE POWER

LIMIT

None; for reporting purposes only.

Test Configuration

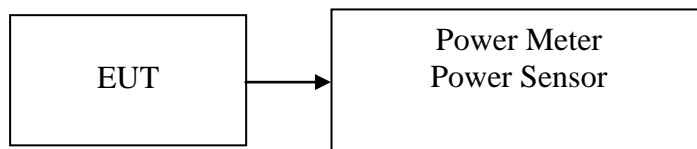

TEST PROCEDURE

The transmitter output is connected to the Power Meter. The Power Meter is set to the avg power detection.

TEST RESULTS

No non-compliance noted.



Test Data

Test mode: IEEE 802.11b mode

Channel	Frequency (MHz)	Output Power (dBm)	Output Power (W)
Low	2412	15.70	0.03715
Mid	2437	15.70	0.03715
High	2462	15.70	0.03715

Test mode: IEEE 802.11g mode

Channel	Frequency (MHz)	Output Power (dBm)	Output Power (W)
Low	2412	15.60	0.03631
Mid	2437	16.60	0.04571
High	2462	15.80	0.03802

Test mode: IEEE 802.11n HT 20 mode

Channel	Frequency (MHz)	Chain 0 Output Power (dBm)	Chain 1 Output Power (dBm)	Total Output Power (dBm)	Output Power (W)
Low	2412	11.93	11.60	14.78	0.0300
Mid	2437	11.91	11.60	14.77	0.0300
High	2462	11.97	11.70	14.85	0.0305

Remark: Total Output Power (w) = Chain 0 (10^(Output Power /10)/1000)+ Chain 1 (10^(Output Power /10)/1000)



7.3BAND EDGES MEASUREMENT

LIMIT

According to §15.247(d) & RSS-210 §A8.5, in any 100 kHz bandwidth outside the frequency bands in which the spread spectrum intentional radiator is operating, the radio frequency power that is produced by the intentional radiator shall be at least 20 dB below that in the 100 kHz bandwidth within the band that contains the highest level of the desired power, based on either an RF conducted or a radiated measurement, provided the transmitter demonstrates compliance with the peak conducted power limits. In addition, radiated emissions which fall in the restricted bands, as defined in §15.205(a), must also comply with the radiated emission limits specified in 15.209(a) (see Section 15.205(c)).

Test Configuration

For Radiated

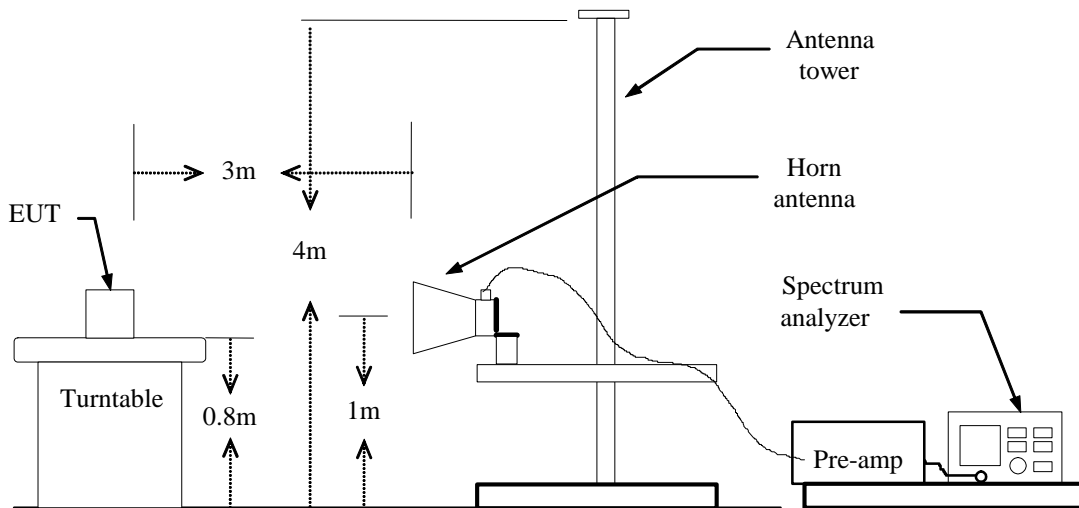

For Conducted

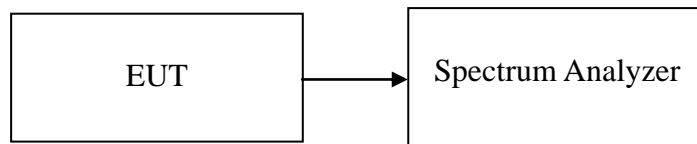



TEST PROCEDURE

For Radiated

1. The EUT is placed on a turntable, which is 0.8m above the ground plane.
2. The turntable shall be rotated for 360 degrees to determine the position of maximum emission level.
3. EUT is set 3m away from the receiving antenna, which is varied from 1m to 4m to find out the highest emission.
4. Set the spectrum analyzer in the following setting in order to capture the lower and upper band-edges of the emission:
 - (a) PEAK: RBW=VBW=3MHz / Sweep=AUTO
 - (b) AVERAGE: RBW=1MHz,
if duty cycle $\geq 98\%$, VBW=10Hz.
if duty cycle $< 98\%$ VBW=1/T.
IEEE 802.11b mode: $\geq 98\%$, VBW=10Hz
IEEE 802.11g mode: $\geq 98\%$, VBW=10Hz
IEEE 802.11n HT 20 MHz mode: $\geq 98\%$, VBW=10Hz
5. Repeat the procedures until all the PEAK and AVERAGE versus POLARIZATION are measured.

For Conducted

Conducted RF measurements of the transmitter output were made to confirm that the EUT antenna port conducted emissions meet the specified limit and to identify any spurious signals that require further investigation or measurements on the radiated emissions site.

The transmitter output is connected to the spectrum analyzer. The resolution bandwidth is set to 100 kHz. The video bandwidth is set to 100 kHz.

TEST RESULTS

Refer to attach spectrum analyzer data chart.



Band Edges (IEEE 802.11b mode / CH Low)

Polarity: Vertical

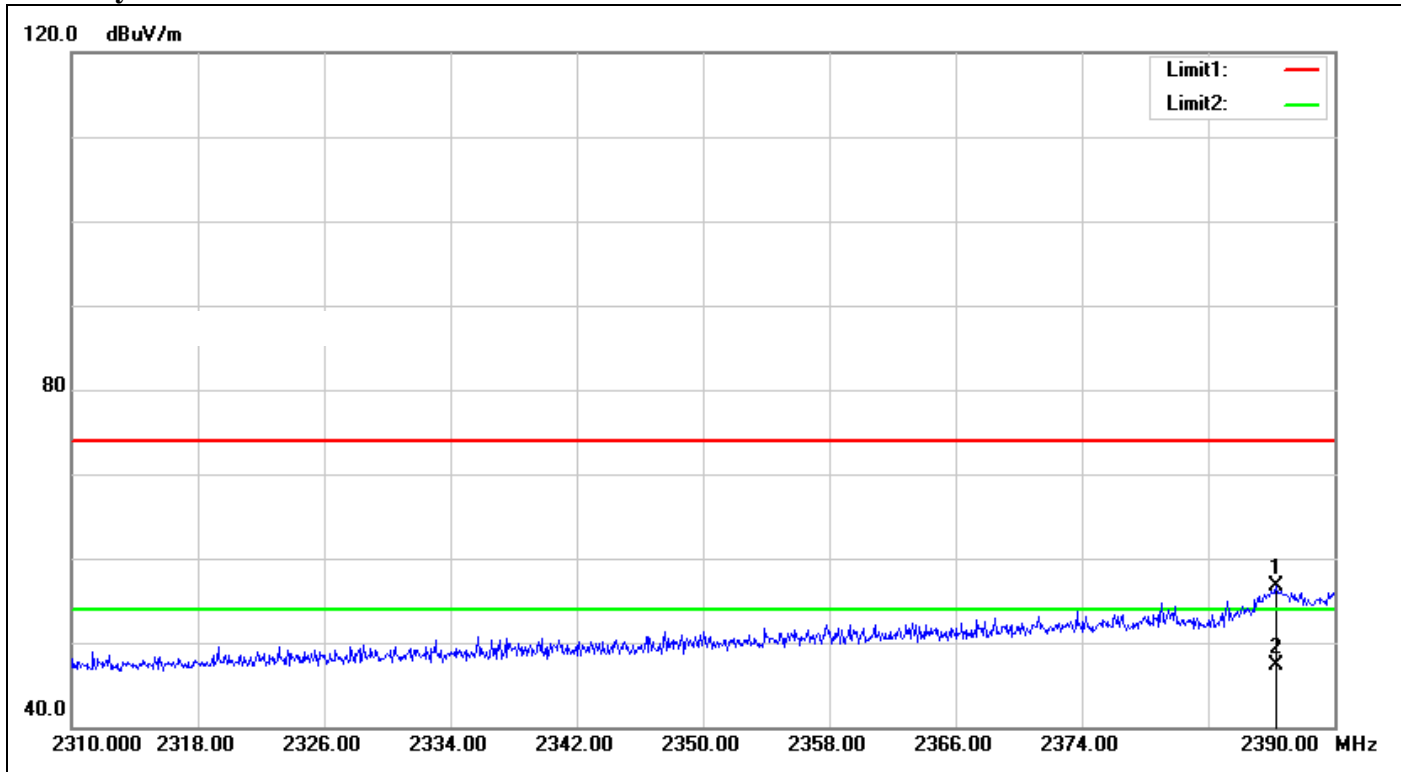

No.	Frequency (MHz)	Reading (dBuV)	Correct Factor(dB/m)	Result (dBuV/m)	Limit (dBuV/m)	Margin (dB)	Height (cm)	Degree (°)	Remark
1	2386.320	60.44	-3.80	56.64	74.00	-17.36	100	38	peak
2	2386.320	51.04	-3.80	47.24	54.00	-6.76	100	38	AVG



Polarity: Horizontal

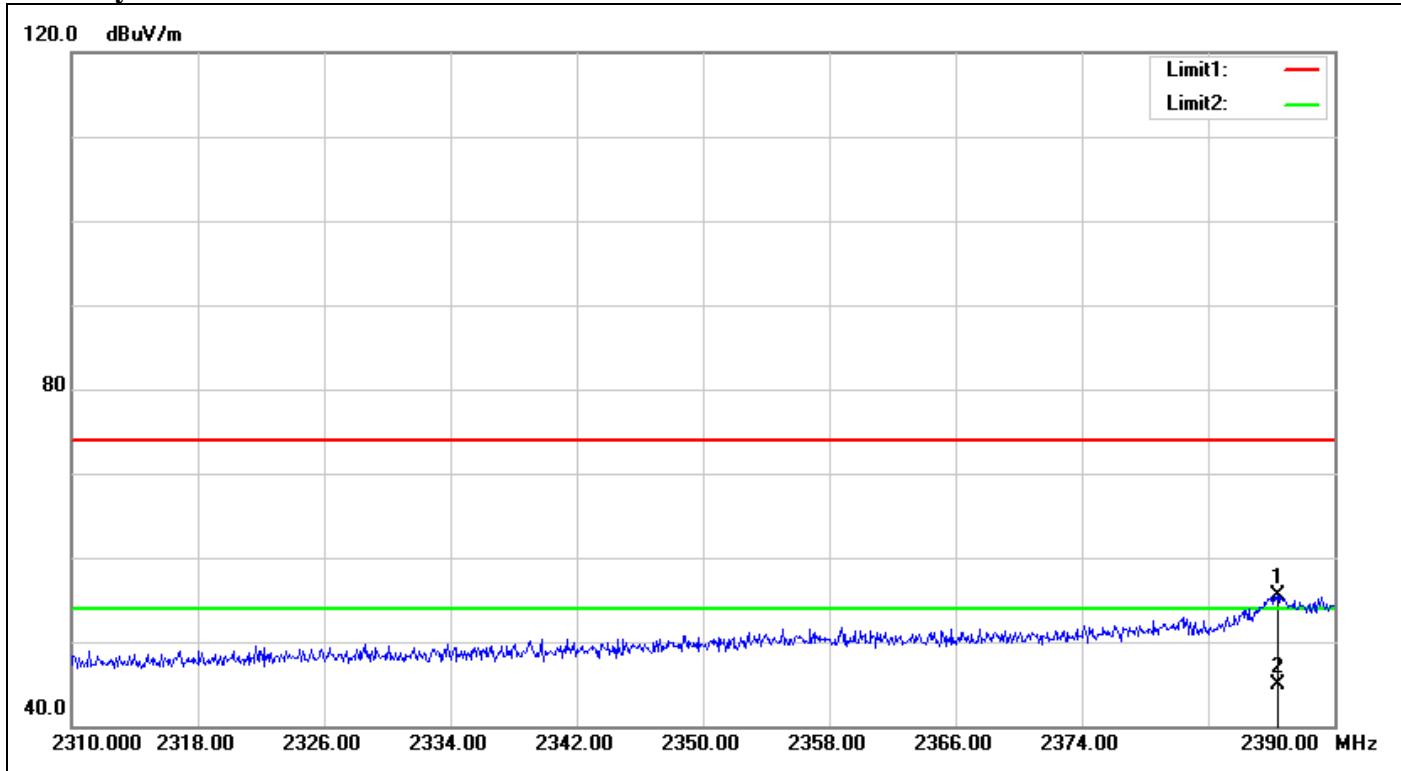

No.	Frequency (MHz)	Reading (dBuV)	Correct Factor(dB/m)	Result (dBuV/m)	Limit (dBuV/m)	Margin (dB)	Height (cm)	Degree (°)	Remark
1	2386.400	59.26	-3.80	55.46	74.00	-18.54	100	259	peak
2	2386.400	48.79	-3.80	44.99	54.00	-9.01	100	259	AVG



Band Edges (IEEE 802.11b mode / CH High)

Polarity: Vertical

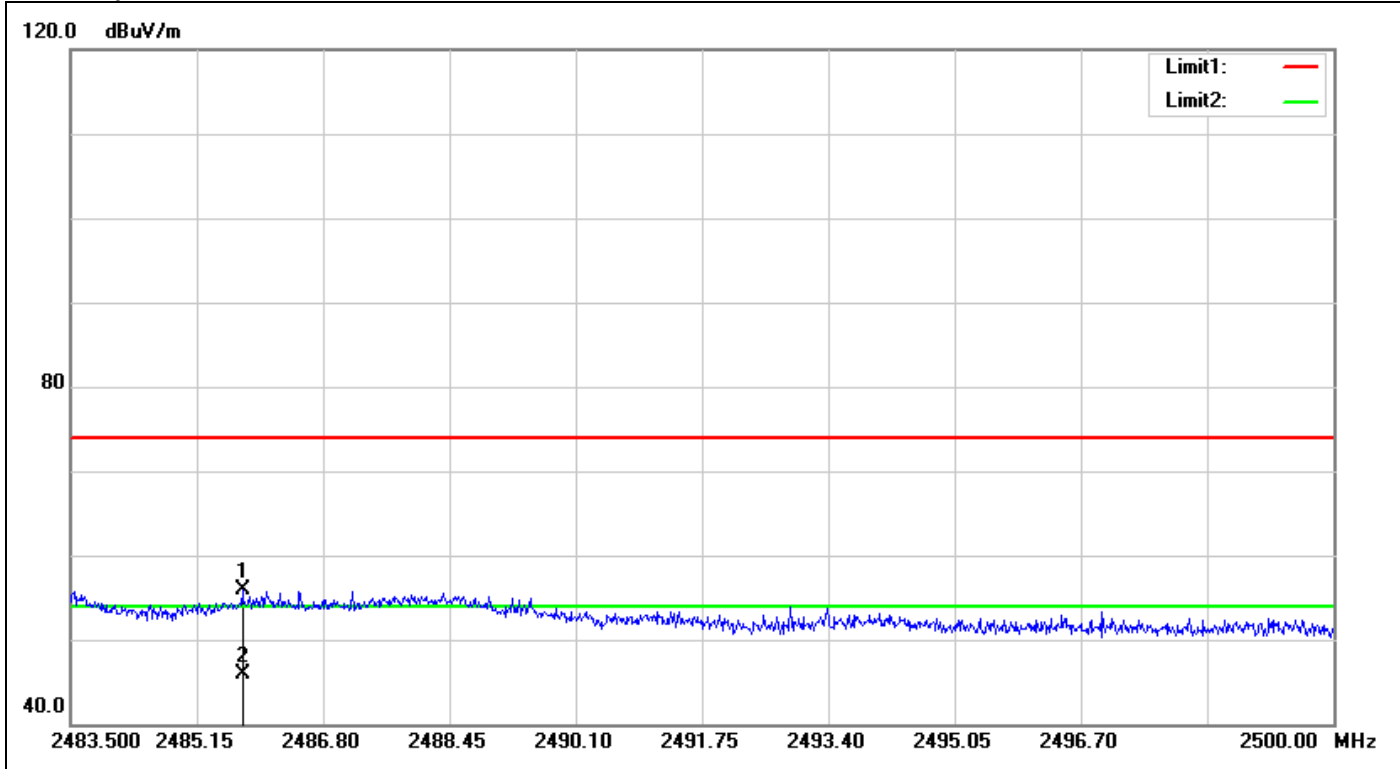

No.	Frequency (MHz)	Reading (dBuV)	Correct Factor(dB/m)	Result (dBuV/m)	Limit (dBuV/m)	Margin (dB)	Height (cm)	Degree (°)	Remark
1	2485.744	59.10	-3.25	55.85	74.00	-18.15	100	356	peak
2	2485.744	49.12	-3.25	45.87	54.00	-8.13	100	356	AVG



Polarity: Horizontal

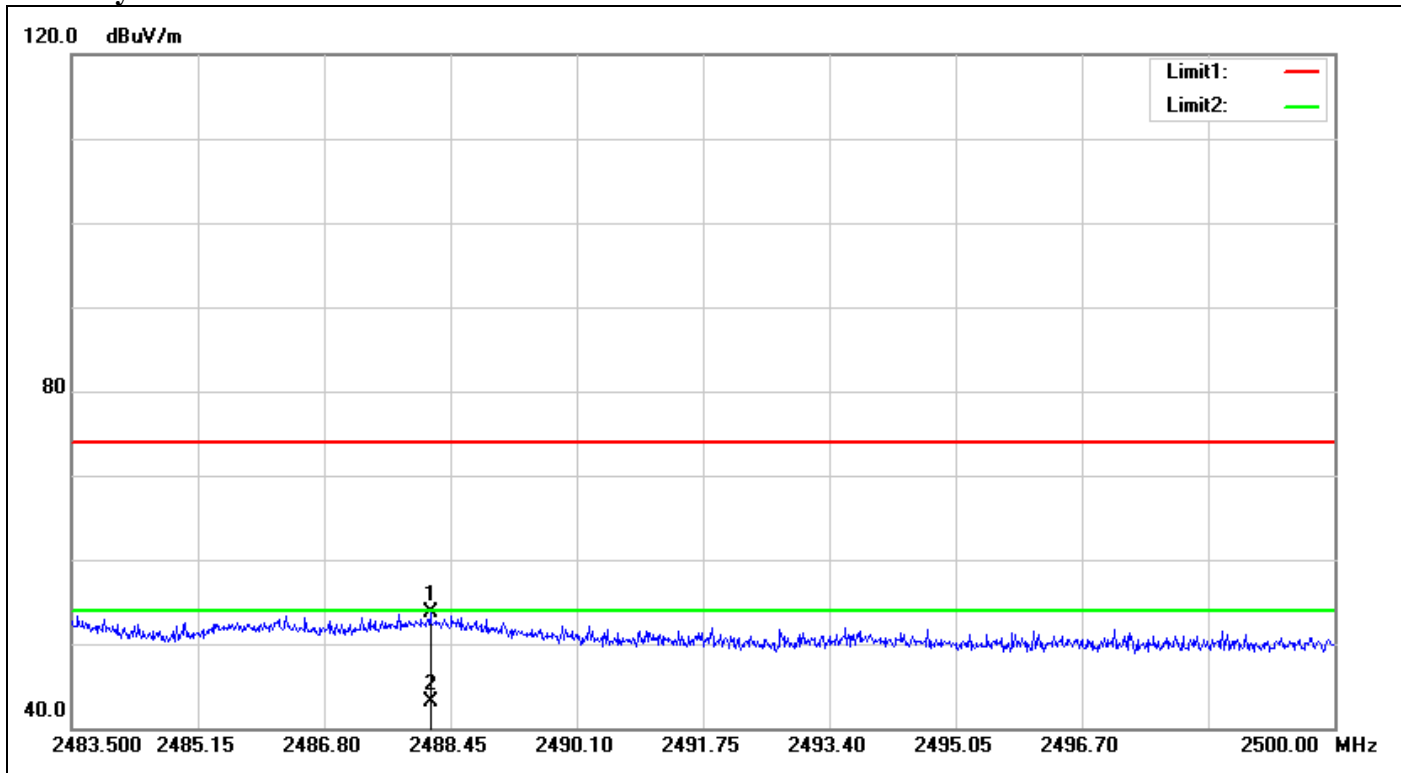

No.	Frequency (MHz)	Reading (dBuV)	Correct Factor(dB/m)	Result (dBuV/m)	Limit (dBuV/m)	Margin (dB)	Height (cm)	Degree (°)	Remark
1	2488.186	56.93	-3.23	53.70	74.00	-20.30	100	287	peak
2	2488.186	46.35	-3.23	43.12	54.00	-10.88	100	287	AVG



Band Edges (IEEE 802.11g mode / CH Low)

Polarity: Vertical

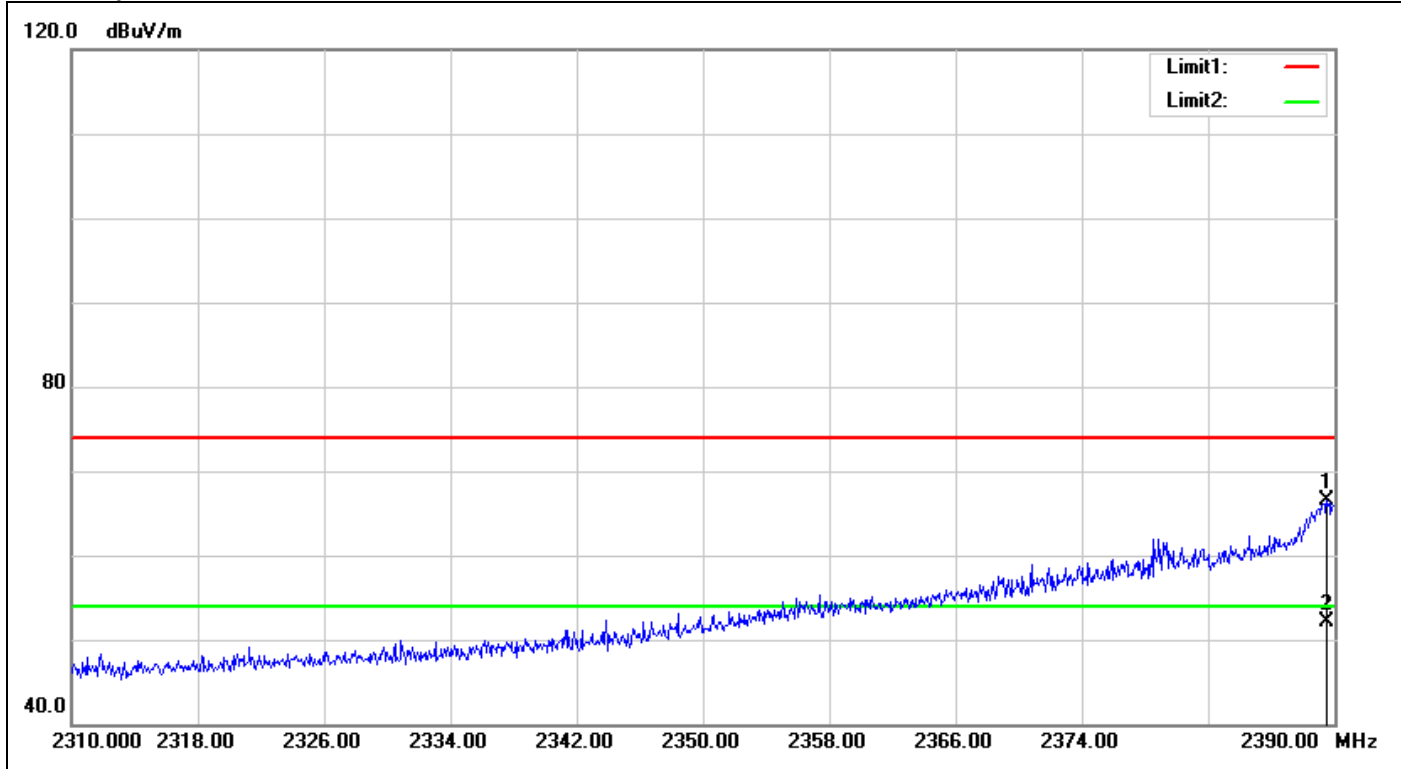

No.	Frequency (MHz)	Reading (dBuV)	Correct Factor(dB/m)	Result (dBuV/m)	Limit (dBuV/m)	Margin (dB)	Height (cm)	Degree (°)	Remark
1	2389.520	70.27	-3.77	66.50	74.00	-7.50	100	97	peak
2	2389.520	55.90	-3.77	52.13	54.00	-1.87	100	97	AVG



Polarity: Horizontal

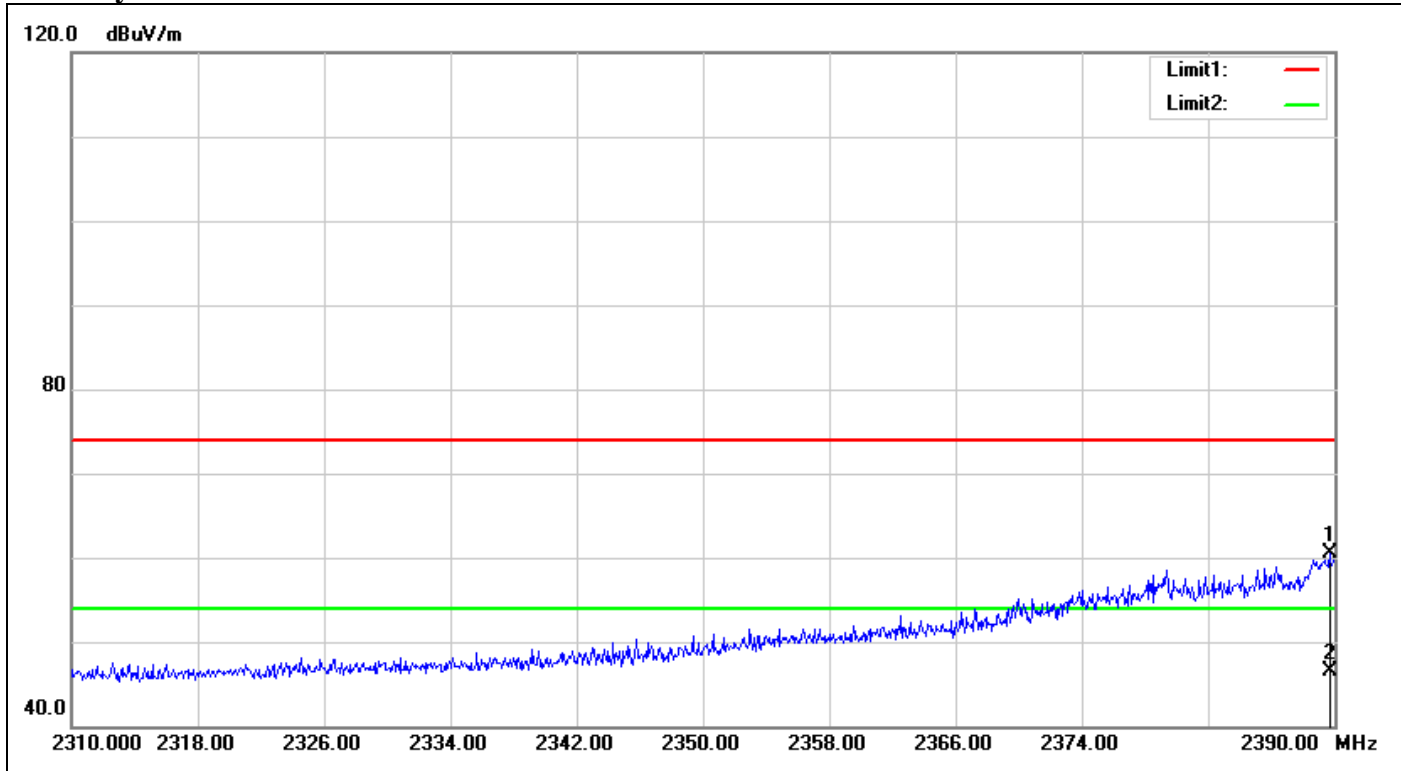

No.	Frequency (MHz)	Reading (dBuV)	Correct Factor(dB/m)	Result (dBuV/m)	Limit (dBuV/m)	Margin (dB)	Height (cm)	Degree (°)	Remark
1	2389.680	64.18	-3.77	60.41	74.00	-13.59	100	205	peak
2	2389.680	50.32	-3.77	46.55	54.00	-7.45	100	205	AVG



Band Edges (IEEE 802.11g mode / CH High)

Polarity: Vertical

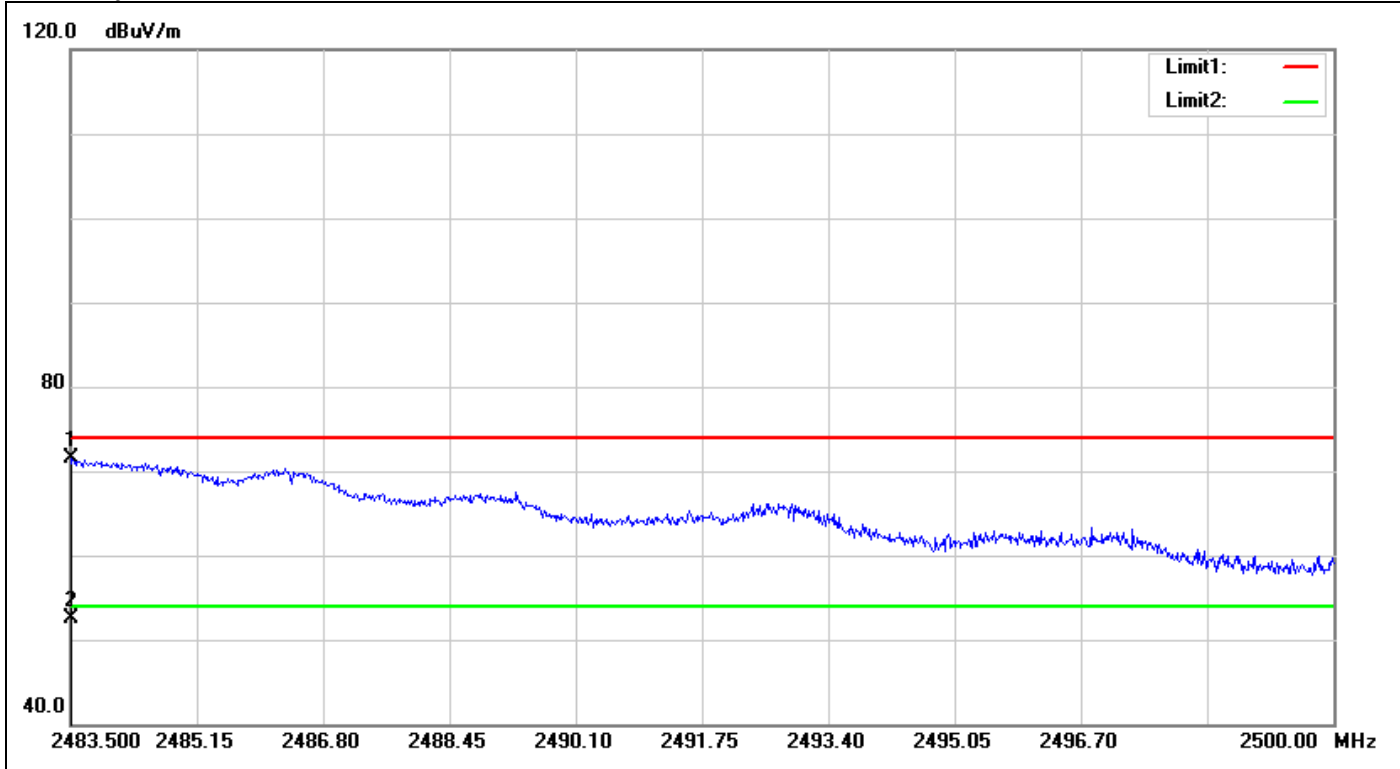

No.	Frequency (MHz)	Reading (dBuV)	Correct Factor(dB/m)	Result (dBuV/m)	Limit (dBuV/m)	Margin (dB)	Height (cm)	Degree (°)	Remark
1	2483.500	74.70	-3.27	71.43	74.00	-2.57	100	36	peak
2	2483.500	55.82	-3.27	52.55	54.00	-1.45	100	36	AVG



Polarity: Horizontal

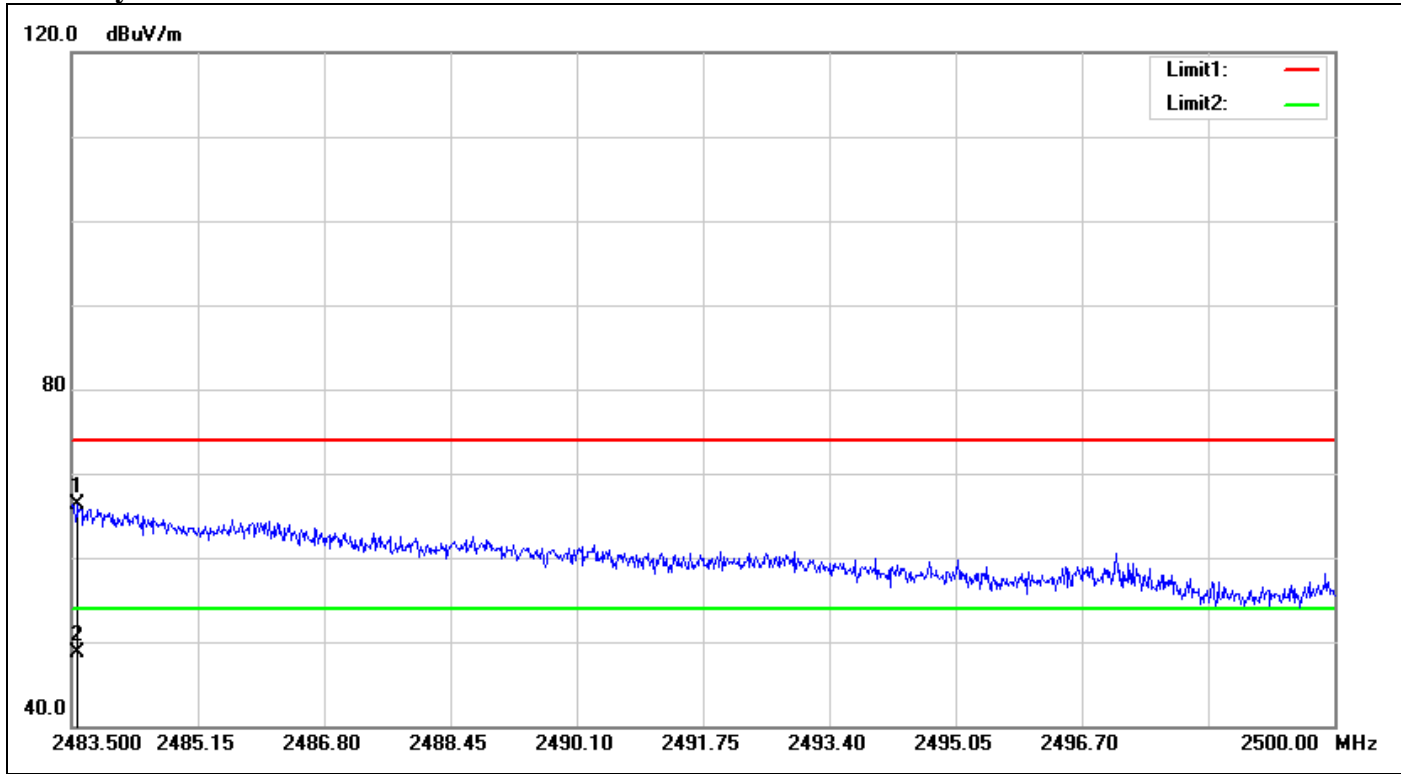

No.	Frequency (MHz)	Reading (dBuV)	Correct Factor(dB/m)	Result (dBuV/m)	Limit (dBuV/m)	Margin (dB)	Height (cm)	Degree (°)	Remark
1	2483.582	69.54	-3.27	66.27	74.00	-7.73	100	0	peak
2	2483.582	51.87	-3.27	48.60	54.00	-5.40	100	0	AVG



Band Edges (IEEE 802.11n HT 20 MHz mode / CH Low)

Polarity: Vertical

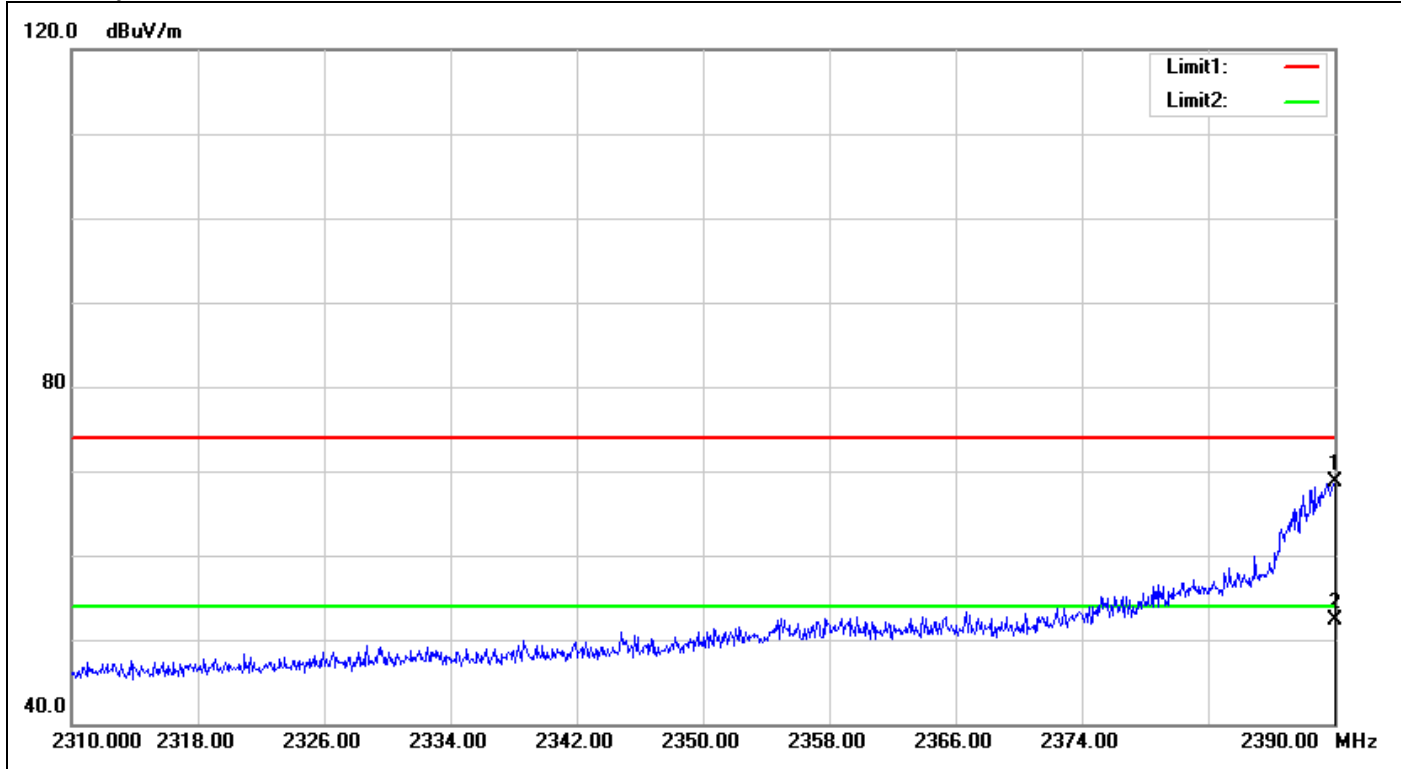

No.	Frequency (MHz)	Reading (dBuV)	Correct Factor(dB/m)	Result (dBuV/m)	Limit (dBuV/m)	Margin (dB)	Height (cm)	Degree (°)	Remark
1	2390.000	72.39	-3.77	68.62	74.00	-5.38	100	302	peak
2	2390.000	56.12	-3.77	52.35	54.00	-1.65	100	302	AVG



Polarity: Horizontal

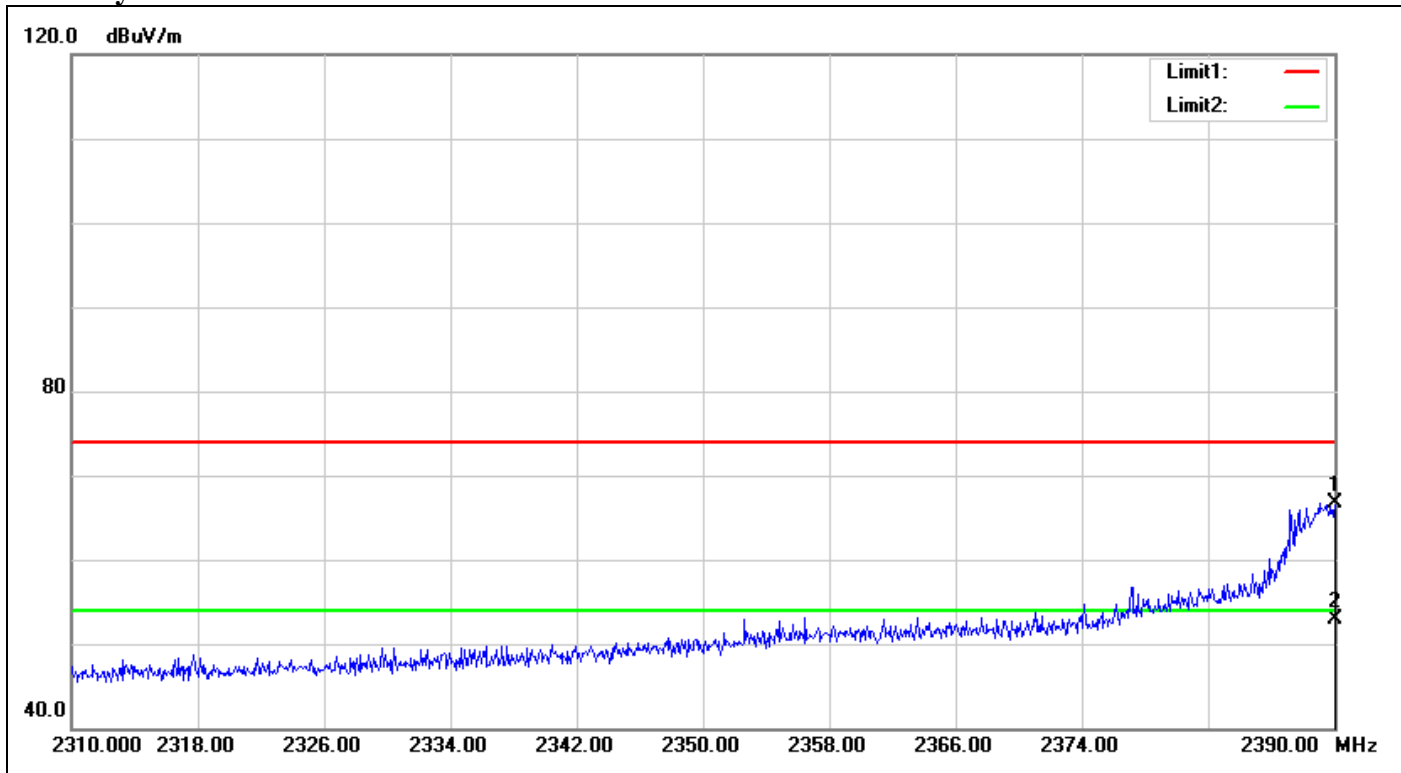

No.	Frequency (MHz)	Reading (dBuV)	Correct Factor(dB/m)	Result (dBuV/m)	Limit (dBuV/m)	Margin (dB)	Height (cm)	Degree (°)	Remark
1	2390.000	70.50	-3.77	66.73	74.00	-7.27	100	320	peak
2	2390.000	56.65	-3.77	52.88	54.00	-1.12	100	320	AVG



Band Edges (IEEE 802.11n HT 20 MHz mode / CH High)

Polarity: Vertical

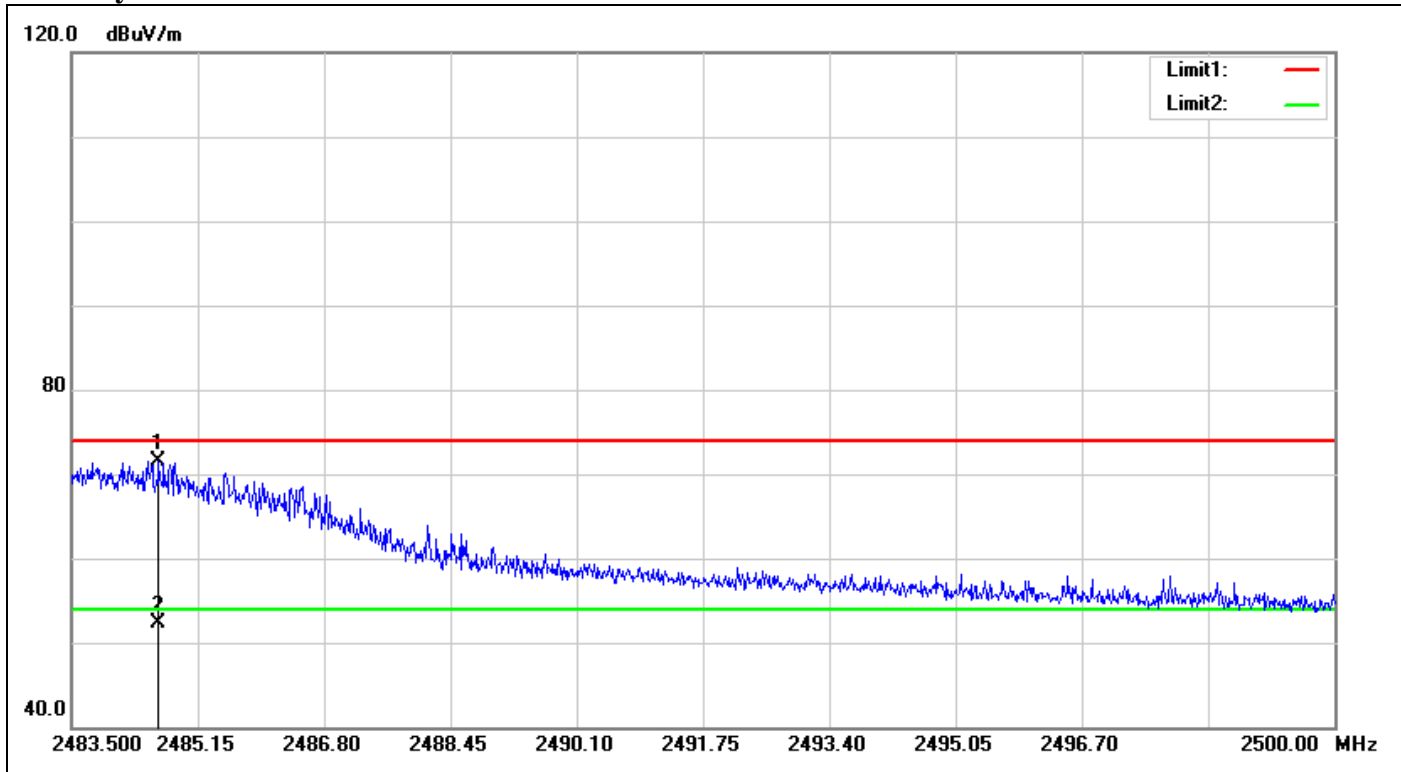

No.	Frequency (MHz)	Reading (dBuV)	Correct Factor(dB/m)	Result (dBuV/m)	Limit (dBuV/m)	Margin (dB)	Height (cm)	Degree (°)	Remark
1	2484.639	74.86	-3.26	71.60	74.00	-2.40	100	221	peak
2	2484.639	55.54	-3.26	52.28	54.00	-1.72	100	221	AVG



Polarity: Horizontal

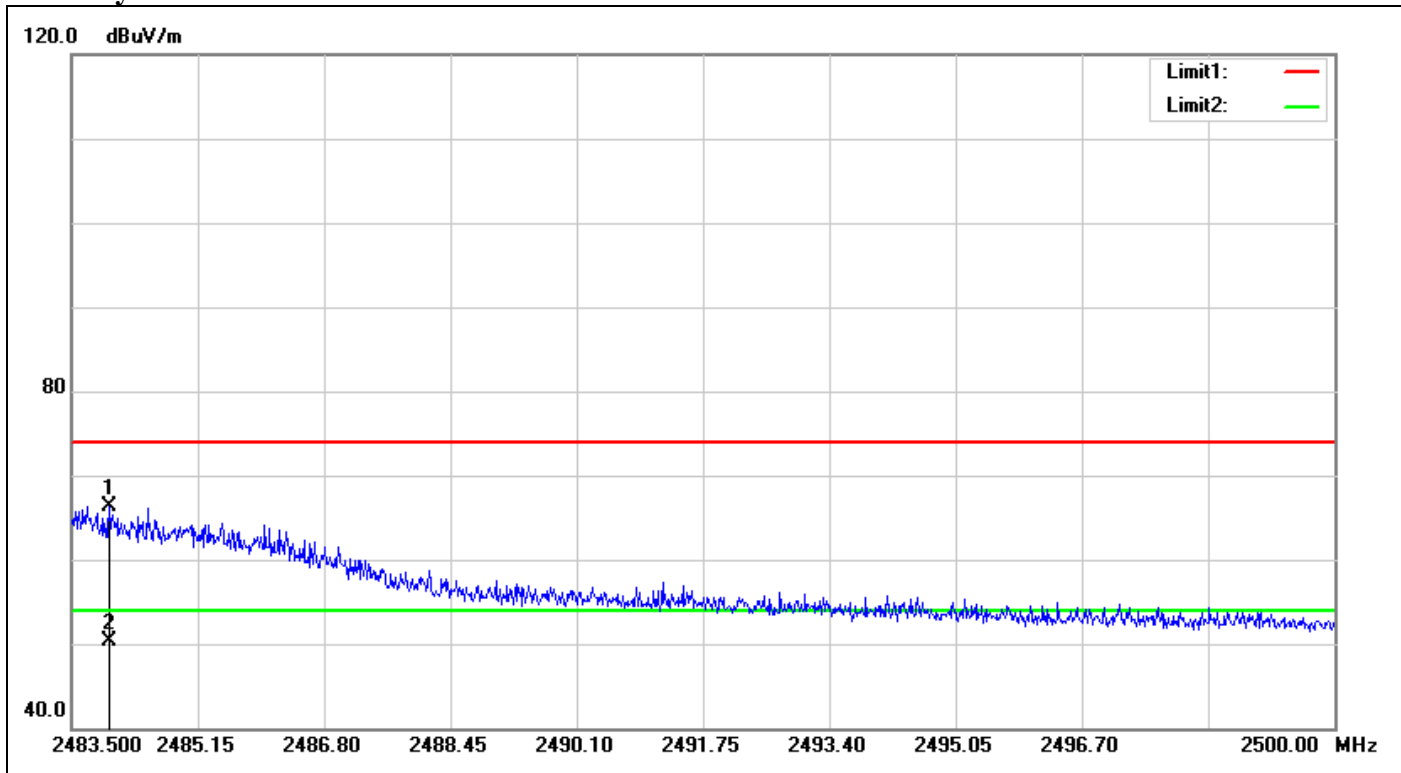

No.	Frequency (MHz)	Reading (dBuV)	Correct Factor(dB/m)	Result (dBuV/m)	Limit (dBuV/m)	Margin (dB)	Height (cm)	Degree (°)	Remark
1	2483.995	69.55	-3.27	66.28	74.00	-7.72	100	309	peak
2	2483.995	53.60	-3.27	50.33	54.00	-3.67	100	309	AVG



7.4 RADIATED EMISSIONS

LIMIT

All spurious emissions shall comply with the limits of §15.209(a) and RSS-Gen Table 2 & Table 5.

RSS-Gen Table 2 & Table 5: General Field Strength Limits for Transmitters and Receivers at Frequencies Above 30 MHz ^(Note)

Frequency (MHz)	Field Strength microvolts/m at 3 metres (watts, e.i.r.p.)	
	Transmitters	Receivers
30-88	100 (3 nW)	100 (3 nW)
88-216	150 (6.8 nW)	150 (6.8 nW)
216-960	200 (12 nW)	200 (12 nW)
Above 960	500 (75 nW)	500 (75 nW)

Note: *Measurements for compliance with limits in the above table may be performed at distances other than 3 metres, in accordance with Section 7.2.7.

Transmitting devices are not permitted in Table 1 bands or, unless stated otherwise, in TV bands (54-72 MHz, 76-88 MHz, 174-216 MHz, 470-608 MHz and 614-806 MHz).

RSS-Gen Table 6: General Field Strength Limits for Transmitters at Frequencies Below 30 MHz (Transmit)

Frequency	Field Strength (microvolts/m)	Magnetic H-Field (microamperes/m)	Measurement Distance (metres)
9-490 kHz	2,400/F (F in kHz)	2,400/377F (F in kHz)	3000
490-1,705 kHz	24,000/F (F in kHz)	24,000/377F (F in kHz)	30
1.705-30 MHz	30	N/A	30

Note: The emission limits for the bands 9-90 kHz and 110-490 kHz are based on measurements employing an average detector.



Test Configuration

9kHz ~ 30MHz

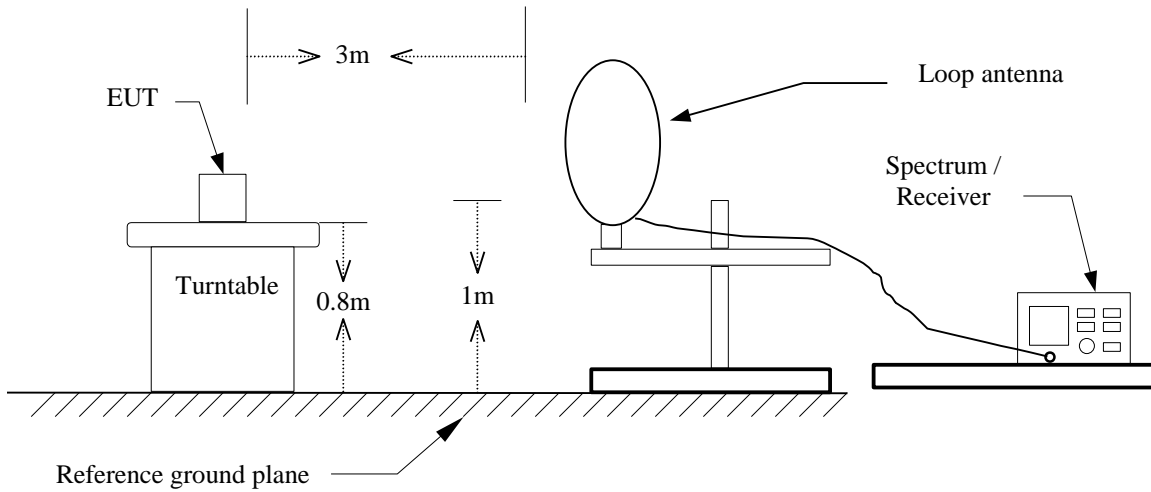

30MHz ~ 1GHz

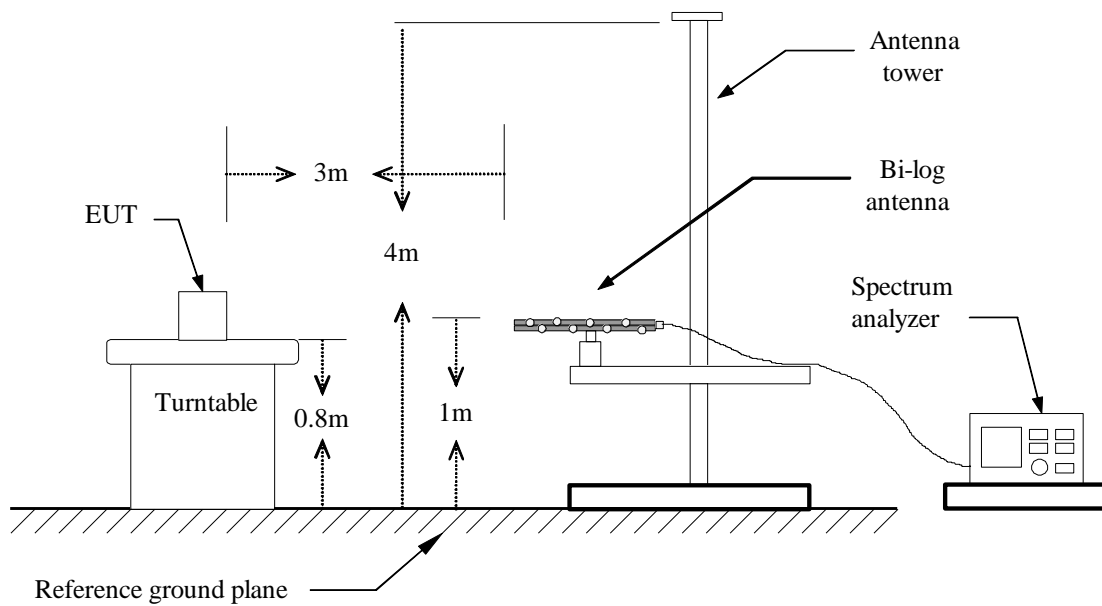



Above 1 GHz

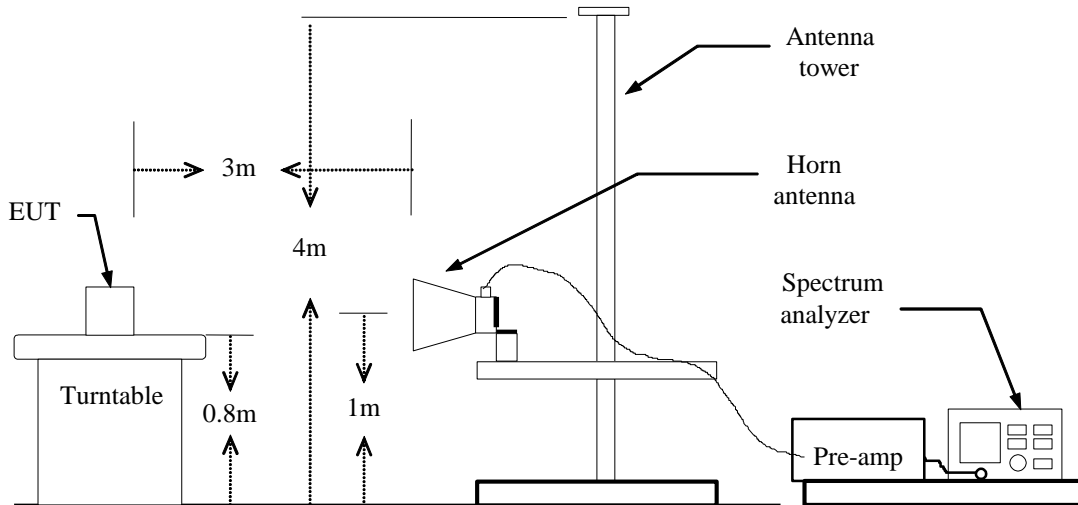

TEST PROCEDURE

1. The EUT is placed on a turntable, which is 0.8m above ground plane.
2. The turntable shall be rotated for 360 degrees to determine the position of maximum emission level.
3. EUT is set 3m away from the receiving antenna, which is varied from 1m to 4m to find out the highest emissions.
4. Maximum procedure was performed on the six highest emissions to ensure EUT compliance.
5. And also, each emission was to be maximized by changing the polarization of receiving antenna both horizontal and vertical.
6. Set the spectrum analyzer in the following setting as:

Below 1GHz:

RBW=100kHz / VBW=300kHz / Sweep=AUTO

Above 1GHz:

(a) PEAK: RBW=1MHz, VBW=1MHz / Sweep=AUTO

(b) AVERAGE: RBW=1MHz,
if duty cycle $\geq 98\%$, VBW=10Hz.
if duty cycle $< 98\%$ VBW=1/T.

IEEE 802.11b mode: $\geq 98\%$, VBW=10Hz

IEEE 802.11g mode: $\geq 98\%$, VBW=10Hz

IEEE 802.11n HT 20 MHz mode: $\geq 98\%$, VBW=10Hz

7. Repeat above procedures until the measurements for all frequencies are complete.



Below 1GHz

Operation Mode: Normal Link

Test Date: March 2, 2015

Temperature: 27°C

Tested by: David Shu

Humidity: 53% RH

Polarity: Ver. / Hor.

Frequency (MHz)	Reading (dBuV)	Correction Factor (dB/m)	Result (dBuV/m)	Limit (dBuV/m)	Margin (dB)	Remark	Ant. Pol. (H/V)
36.7900	47.36	-14.85	32.51	40.00	-7.49	peak	V
76.5600	52.10	-22.90	29.20	40.00	-10.80	peak	V
259.8900	33.28	-17.68	15.60	46.00	-30.40	peak	V
449.0400	35.30	-12.69	22.61	46.00	-23.39	peak	V
668.2600	30.21	-9.12	21.09	46.00	-24.91	peak	V
852.5600	28.68	-6.75	21.93	46.00	-24.07	peak	V
36.7900	45.81	-14.85	30.96	40.00	-9.04	peak	H
76.5600	48.48	-22.90	25.58	40.00	-14.42	peak	H
320.0300	42.28	-15.92	26.36	46.00	-19.64	peak	H
533.4300	33.23	-11.28	21.95	46.00	-24.05	peak	H
749.7400	29.90	-7.88	22.02	46.00	-23.98	peak	H
893.3000	29.30	-6.24	23.06	46.00	-22.94	peak	H

Remark:

1. Measuring frequencies from 30 MHz to the 1GHz.
2. Radiated emissions measured in frequency range from 30 MHz to 1000MHz were made with an instrument using peak/quasi-peak detector mode.
3. Quasi-peak test would be performed if the peak result were greater than the quasi-peak limit or as required by the applicant.
4. Measurements above show only up to 6 maximum emissions noted, or would be lesser, with " N/A " remark, if no specific emissions from the EUT are recorded (ie: margin>20dB from the applicable limit) and considered that's already beyond the background noise floor.
5. Margin (dB) = Result (dBuV/m) – Limit (dBuV/m).



Above 1 GHz

Operation Mode: TX / IEEE 802.11b / CH Low

Test Date: February 25, 2015

Temperature: 27°C

Tested by: Owen Wu

Humidity: 53% RH

Polarity: Ver. / Hor.

Frequency (MHz)	Reading (dBuV)	Correction Factor (dB/m)	Result (dBuV/m)	Limit (dBuV/m)	Margin (dB)	Remark	Ant. Pol. (H/V)
1730.000	49.84	-6.31	43.53	74.00	-30.47	peak	V
4825.000	48.49	4.01	52.50	74.00	-21.50	peak	V
4825.000	46.48	4.01	50.49	54.00	-3.51	AVG	V
N/A							
1632.000	50.61	-6.83	43.78	74.00	-30.22	peak	H
4825.000	50.06	4.01	54.07	74.00	-19.93	peak	H
4825.000	48.59	4.01	52.60	54.00	-1.40	AVG	H
N/A							

Remark:

1. Measuring frequencies from 1 GHz to the 10th harmonic of highest fundamental frequency.
2. Radiated emissions measured in frequency above 1000MHz were made with an instrument using peak/average detector mode.
3. Average test would be performed if the peak result were greater than the average limit or as required by the applicant.
4. Data of measurement within this frequency range shown “ --- ” in the table above means the reading of emissions are attenuated more than 20dB below the permissible limits or the field strength is too small to be measured.
5. Measurements above show only up to 6 maximum emissions noted, or would be lesser, with “ N/A ” remark, if no specific emissions from the EUT are recorded (ie: margin>20dB from the applicable limit) and considered that's already beyond the background noise floor.
6. Margin (dB) = Remark result (dBuV/m) – Average limit (dBuV/m).



Operation Mode: TX / IEEE 802.11b / CH Mid

Test Date: February 25, 2015

Temperature: 27°C

Tested by: Owen Wu

Humidity: 53 % RH

Polarity: Ver. / Hor.

Frequency (MHz)	Reading (dBuV)	Correction Factor (dB/m)	Result (dBuV/m)	Limit (dBuV/m)	Margin (dB)	Remark	Ant. Pol. (H/V)
1806.000	50.50	-5.91	44.59	74.00	-29.41	peak	V
4875.000	46.50	3.92	50.42	74.00	-23.58	peak	V
N/A							
1570.000	50.30	-7.16	43.14	74.00	-30.86	peak	H
4875.000	50.36	3.92	54.28	74.00	-19.72	peak	H
4875.000	48.37	3.92	52.29	54.00	-1.71	AVG	H
N/A							

Remark:

1. Measuring frequencies from 1 GHz to the 10th harmonic of highest fundamental frequency.
2. Radiated emissions measured in frequency above 1000MHz were made with an instrument using peak/average detector mode.
3. Average test would be performed if the peak result were greater than the average limit or as required by the applicant.
4. Data of measurement within this frequency range shown “ --- ” in the table above means the reading of emissions are attenuated more than 20dB below the permissible limits or the field strength is too small to be measured.
5. Measurements above show only up to 6 maximum emissions noted, or would be lesser, with “ N/A ” remark, if no specific emissions from the EUT are recorded (ie: margin>20dB from the applicable limit) and considered that's already beyond the background noise floor.
6. Margin (dB) = Remark result (dBuV/m) – Average limit (dBuV/m).



Operation Mode: TX / IEEE 802.11b / CH High

Test Date: February 25, 2015

Temperature: 27°C

Tested by: Owen Wu

Humidity: 53 % RH

Polarity: Ver. / Hor.

Frequency (MHz)	Reading (dBuV)	Correction Factor (dB/m)	Result (dBuV/m)	Limit (dBuV/m)	Margin (dB)	Remark	Ant. Pol. (H/V)
1698.000	49.63	-6.48	43.15	74.00	-30.85	peak	V
4925.000	53.27	3.90	57.17	74.00	-16.83	peak	V
4925.000	49.08	3.90	52.98	54.00	-1.02	AVG	V
N/A							
1808.000	50.37	-5.90	44.47	74.00	-29.53	peak	H
4925.000	53.56	3.90	57.46	74.00	-16.54	peak	H
4925.000	49.21	3.90	53.11	54.00	-0.89	AVG	H
N/A							

Remark:

1. Measuring frequencies from 1 GHz to the 10th harmonic of highest fundamental frequency.
2. Radiated emissions measured in frequency above 1000MHz were made with an instrument using peak/average detector mode.
3. Average test would be performed if the peak result were greater than the average limit or as required by the applicant.
4. Data of measurement within this frequency range shown " --- " in the table above means the reading of emissions are attenuated more than 20dB below the permissible limits or the field strength is too small to be measured.
5. Measurements above show only up to 6 maximum emissions noted, or would be lesser, with " N/A " remark, if no specific emissions from the EUT are recorded (ie: margin > 20dB from the applicable limit) and considered that's already beyond the background noise floor.
6. Margin (dB) = Remark result (dBuV/m) – Average limit (dBuV/m).



Operation Mode: TX / IEEE 802.11g / CH Low

Test Date: February 25, 2015

Temperature: 27°C

Tested by: Owen Wu

Humidity: 53 % RH

Polarity: Ver. / Hor.

Frequency (MHz)	Reading (dBuV)	Correction Factor (dB/m)	Result (dBuV/m)	Limit (dBuV/m)	Margin (dB)	Remark	Ant. Pol. (H/V)
1644.000	50.28	-6.77	43.51	74.00	-30.49	peak	V
4825.000	52.95	4.01	56.96	74.00	-17.04	peak	V
4825.000	40.58	4.01	44.59	74.00	-29.41	peak	V
N/A							
1828.000	50.41	-5.79	44.62	74.00	-29.38	peak	H
4825.000	56.01	4.01	60.02	74.00	-13.98	peak	H
4825.000	44.96	4.01	48.97	54.00	-5.03	AVG	H
N/A							

Remark:

1. Measuring frequencies from 1 GHz to the 10th harmonic of highest fundamental frequency.
2. Radiated emissions measured in frequency above 1000MHz were made with an instrument using peak/average detector mode.
3. Average test would be performed if the peak result were greater than the average limit or as required by the applicant.
4. Data of measurement within this frequency range shown " --- " in the table above means the reading of emissions are attenuated more than 20dB below the permissible limits or the field strength is too small to be measured.
5. Measurements above show only up to 6 maximum emissions noted, or would be lesser, with " N/A " remark, if no specific emissions from the EUT are recorded (ie: margin > 20dB from the applicable limit) and considered that's already beyond the background noise floor.
6. Margin (dB) = Remark result (dBuV/m) – Average limit (dBuV/m).



Operation Mode: TX / IEEE 802.11g / CH Mid

Test Date: February 25, 2015

Temperature: 27°C

Tested by: Owen Wu

Humidity: 53 % RH

Polarity: Ver. / Hor.

Frequency (MHz)	Reading (dBuV)	Correction Factor (dB/m)	Result (dBuV/m)	Limit (dBuV/m)	Margin (dB)	Remark	Ant. Pol. (H/V)
1476.000	50.74	-7.64	43.10	74.00	-30.90	peak	V
4875.000	55.89	3.92	59.81	74.00	-14.19	peak	V
4875.000	47.40	3.92	51.32	54.00	-2.68	AVG	V
N/A							
1524.000	50.01	-7.40	42.61	74.00	-31.39	peak	H
4870.000	58.69	3.93	62.62	74.00	-11.38	peak	H
4870.000	48.32	3.93	52.25	54.00	-1.75	AVG	H
N/A							

Remark:

1. Measuring frequencies from 1 GHz to the 10th harmonic of highest fundamental frequency.
2. Radiated emissions measured in frequency above 1000MHz were made with an instrument using peak/average detector mode.
3. Average test would be performed if the peak result were greater than the average limit or as required by the applicant.
4. Data of measurement within this frequency range shown " --- " in the table above means the reading of emissions are attenuated more than 20dB below the permissible limits or the field strength is too small to be measured.
5. Measurements above show only up to 6 maximum emissions noted, or would be lesser, with " N/A " remark, if no specific emissions from the EUT are recorded (ie: margin > 20dB from the applicable limit) and considered that's already beyond the background noise floor.
6. Margin (dB) = Remark result (dBuV/m) – Average limit (dBuV/m).



Operation Mode: TX / IEEE 802.11g / CH High

Test Date: February 25, 2015

Temperature: 27°C

Tested by: Owen Wu

Humidity: 53 % RH

Polarity: Ver. / Hor.

Frequency (MHz)	Reading (dBuV)	Correction Factor (dB/m)	Result (dBuV/m)	Limit (dBuV/m)	Margin (dB)	Remark	Ant. Pol. (H/V)
1780.000	50.10	-6.05	44.05	74.00	-29.95	peak	V
4925.000	53.63	3.90	57.53	74.00	-16.47	peak	V
4925.000	44.96	3.90	48.86	54.00	-5.14	AVG	V
N/A							
1538.000	50.62	-7.33	43.29	74.00	-30.71	peak	H
4925.000	56.59	3.90	60.49	74.00	-13.51	peak	H
4925.000	47.51	3.90	51.41	54.00	-2.59	AVG	H
N/A							

Remark:

1. Measuring frequencies from 1 GHz to the 10th harmonic of highest fundamental frequency.
2. Radiated emissions measured in frequency above 1000MHz were made with an instrument using peak/average detector mode.
3. Average test would be performed if the peak result were greater than the average limit or as required by the applicant.
4. Data of measurement within this frequency range shown “ --- ” in the table above means the reading of emissions are attenuated more than 20dB below the permissible limits or the field strength is too small to be measured.
5. Measurements above show only up to 6 maximum emissions noted, or would be lesser, with “ N/A ” remark, if no specific emissions from the EUT are recorded (ie: margin>20dB from the applicable limit) and considered that's already beyond the background noise floor.
6. Margin (dB) = Remark result (dBuV/m) – Average limit (dBuV/m).



Operation Mode: TX / IEEE 802.11n HT 20 MHz mode / CH Low Test Date: February 25, 2015

Temperature: 27°C

Tested by: Owen Wu

Humidity: 53 % RH

Polarity: Ver. / Hor.

Frequency (MHz)	Reading (dBuV)	Correction Factor (dB/m)	Result (dBuV/m)	Limit (dBuV/m)	Margin (dB)	Remark	Ant. Pol. (H/V)
1774.000	49.68	-6.08	43.60	74.00	-30.40	peak	V
4825.000	47.68	4.01	51.69	74.00	-22.31	peak	V
4825.000	38.44	4.01	42.45	54.00	-11.55	AVG	V
N/A							
1516.000	49.50	-7.45	42.05	74.00	-31.95	peak	H
4825.000	49.78	4.01	53.79	74.00	-20.21	peak	H
4825.000	40.30	4.01	44.31	54.00	-9.69	AVG	H
N/A							

Remark:

1. Measuring frequencies from 1 GHz to the 10th harmonic of highest fundamental frequency.
2. Radiated emissions measured in frequency above 1000MHz were made with an instrument using peak/average detector mode.
3. Average test would be performed if the peak result were greater than the average limit or as required by the applicant.
4. Data of measurement within this frequency range shown " --- " in the table above means the reading of emissions are attenuated more than 20dB below the permissible limits or the field strength is too small to be measured.
5. Measurements above show only up to 6 maximum emissions noted, or would be lesser, with " N/A " remark, if no specific emissions from the EUT are recorded (ie: margin > 20dB from the applicable limit) and considered that's already beyond the background noise floor.
6. Margin (dB) = Remark result (dBuV/m) – Average limit (dBuV/m).



Operation Mode: TX / IEEE 802.11n HT 20 MHz mode / CH Mid Test Date: February 25, 2015

Temperature: 27°C

Tested by: Owen Wu

Humidity: 53 % RH

Polarity: Ver. / Hor.

Frequency (MHz)	Reading (dBuV)	Correction Factor (dB/m)	Result (dBuV/m)	Limit (dBuV/m)	Margin (dB)	Remark	Ant. Pol. (H/V)
1446.000	50.74	-7.77	42.97	74.00	-31.03	peak	V
4875.000	50.61	3.92	54.53	74.00	-19.47	peak	V
4875.000	41.14	3.92	45.06	54.00	-8.94	AVG	V
N/A							
1830.000	50.93	-5.78	45.15	74.00	-28.85	peak	H
4870.000	56.67	3.93	60.60	74.00	-13.40	peak	H
4870.000	46.67	3.93	50.60	54.00	-3.40	AVG	H
N/A							

Remark:

1. Measuring frequencies from 1 GHz to the 10th harmonic of highest fundamental frequency.
2. Radiated emissions measured in frequency above 1000MHz were made with an instrument using peak/average detector mode.
3. Average test would be performed if the peak result were greater than the average limit or as required by the applicant.
4. Data of measurement within this frequency range shown " --- " in the table above means the reading of emissions are attenuated more than 20dB below the permissible limits or the field strength is too small to be measured.
5. Measurements above show only up to 6 maximum emissions noted, or would be lesser, with " N/A " remark, if no specific emissions from the EUT are recorded (ie: margin > 20dB from the applicable limit) and considered that's already beyond the background noise floor.
6. Margin (dB) = Remark result (dBuV/m) – Average limit (dBuV/m).



Operation Mode: TX / IEEE 802.11n HT 20 MHz mode / CH High Test Date: February 25, 2015

Temperature: 27°C

Tested by: Owen Wu

Humidity: 53 % RH

Polarity: Ver. / Hor.

Frequency (MHz)	Reading (dBuV)	Correction Factor (dB/m)	Result (dBuV/m)	Limit (dBuV/m)	Margin (dB)	Remark	Ant. Pol. (H/V)
1674.000	50.26	-6.61	43.65	74.00	-30.35	peak	V
4925.000	51.92	3.90	55.82	74.00	-18.18	peak	V
4925.000	42.25	3.90	46.15	54.00	-7.85	AVG	V
N/A							
1646.000	50.02	-6.76	43.26	74.00	-30.74	peak	H
4925.000	59.87	3.90	63.77	74.00	-10.23	peak	H
4925.000	48.62	3.90	52.52	54.00	-1.48	AVG	H
N/A							

Remark:

1. Measuring frequencies from 1 GHz to the 10th harmonic of highest fundamental frequency.
2. Radiated emissions measured in frequency above 1000MHz were made with an instrument using peak/average detector mode.
3. Average test would be performed if the peak result were greater than the average limit or as required by the applicant.
4. Data of measurement within this frequency range shown " --- " in the table above means the reading of emissions are attenuated more than 20dB below the permissible limits or the field strength is too small to be measured.
5. Measurements above show only up to 6 maximum emissions noted, or would be lesser, with " N/A " remark, if no specific emissions from the EUT are recorded (ie: margin > 20dB from the applicable limit) and considered that's already beyond the background noise floor.
6. Margin (dB) = Remark result (dBuV/m) – Average limit (dBuV/m).



7.5 POWERLINE CONDUCTED EMISSIONS

LIMIT

According to §15.207(a), except as shown in paragraphs (b) and (c) of this section, for an intentional radiator that is designed to be connected to the public utility (AC) power line, the radio frequency voltage that is conducted back onto the AC power line on any frequency or frequencies within the band 150 kHz to 30 MHz shall not exceed the limits in the following table, as measured using a 50 μ H/50 ohms line impedance stabilization network (LISN). Compliance with the provisions of this paragraph shall be based on the measurement of the radio frequency voltage between each power line and ground at the power terminal. The lower limit applies at the boundary between the frequency ranges.

Frequency Range (MHz)	Limits (dB μ V)	
	Quasi-peak	Average
0.15 to 0.50	66 to 56*	56 to 46*
0.50 to 5	56	46
5 to 30	60	50

* Decreases with the logarithm of the frequency.

Test Configuration

See test photographs attached in Appendix 1 for the actual connections between EUT and support equipment.

TEST PROCEDURE

1. The EUT was placed on a table, which is 0.8m above ground plane.
2. Maximum procedure was performed on the six highest emissions to ensure EUT compliance.
3. Repeat above procedures until all frequency measured were complete.



TEST RESULTS

The initial step in collecting conducted data is a spectrum analyzer peak scan of the measurement range. Significant peaks are then marked as shown on the following data page, and these signals are then quasi-peaked.

Test Data

Operation Mode: Normal Link **Test Date:** March 2, 2015
Temperature: 24°C **Tested by:** Ken Tsai
Humidity: 50% RH

Freq. (MHz)	QP Reading (dBuV)	AV Reading (dBuV)	Corr. factor (dB/m)	QP Result (dBuV/m)	AV Result (dBuV/m)	QP Limit (dBuV)	AV Limit (dBuV)	QP Margin (dB)	AV Margin (dB)	Note
0.4820	35.08	24.75	9.66	44.74	34.41	56.30	46.30	-11.56	-11.89	L1
0.5100	29.71	17.49	9.66	39.37	27.15	56.00	46.00	-16.63	-18.85	L1
0.5620	21.08	11.43	9.66	30.74	21.09	56.00	46.00	-25.26	-24.91	L1
0.6180	23.18	11.65	9.67	32.85	21.32	56.00	46.00	-23.15	-24.68	L1
0.9580	23.66	12.51	9.71	33.37	22.22	56.00	46.00	-22.63	-23.78	L1
2.6700	23.36	12.70	9.78	33.14	22.48	56.00	46.00	-22.86	-23.52	L1
0.2660	31.14	30.36	9.68	40.82	40.04	61.24	51.24	-20.42	-11.20	L2
0.4900	25.47	18.85	9.71	35.18	28.56	56.17	46.17	-20.99	-17.61	L2
0.5180	28.18	23.40	9.71	37.89	33.11	56.00	46.00	-18.11	-12.89	L2
0.8300	19.23	11.96	9.75	28.98	21.71	56.00	46.00	-27.02	-24.29	L2
0.9980	20.62	13.13	9.76	30.38	22.89	56.00	46.00	-25.62	-23.11	L2
2.4940	18.79	11.29	9.82	28.61	21.11	56.00	46.00	-27.39	-24.89	L2

Remark:

1. Measuring frequencies from 0.15 MHz to 30MHz.
2. The emissions measured in frequency range from 0.15 MHz to 30MHz were made with an instrument using Quasi-peak detector and average detector.
3. The IF bandwidth of SPA between 0.15MHz and 30MHz was 10 kHz; the IF bandwidth of Test Receiver between 0.15MHz and 30MHz was 9 kHz;
4. L1 = Line One (Live Line) / L2 = Line Two (Neutral Line)



Test Plots

Conducted emissions (Line 1)

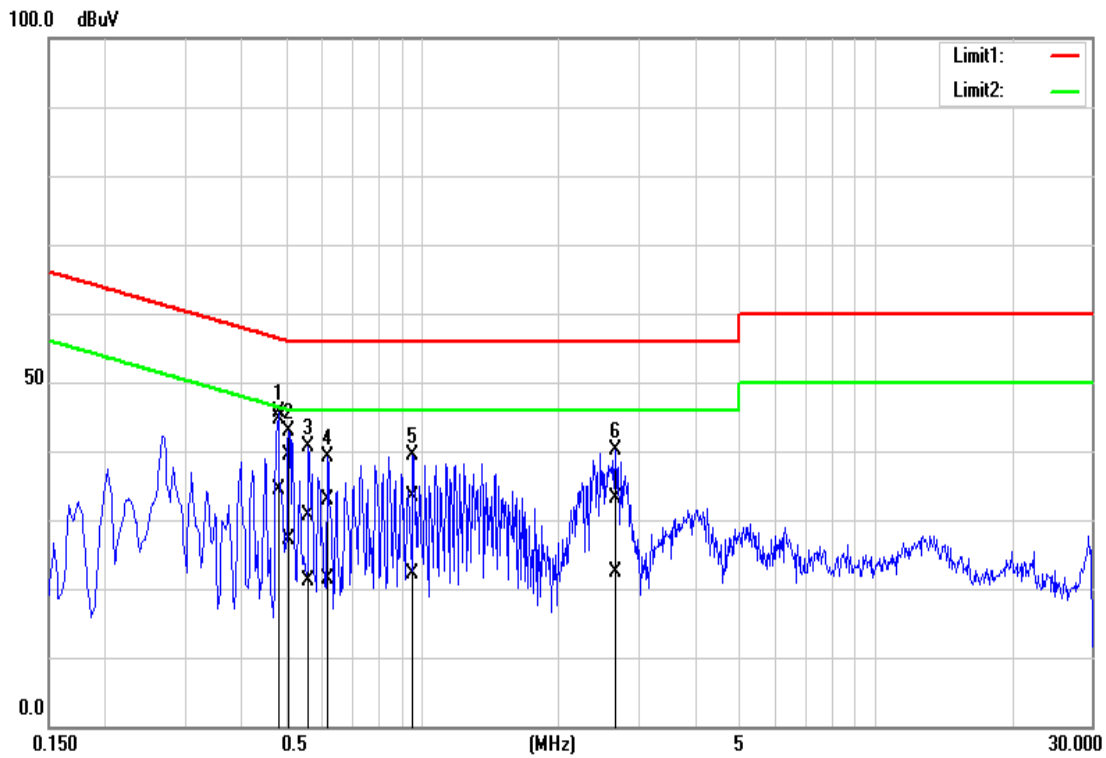

Conducted emissions (Line 2)

