



**FCC 47 CFR PART 15 SUBPART C &
INDUSTRY CANADA RSS-210**

TEST REPORT

For

Digitizer I/O device

Model: SU8E-10W05MI-01A

Trade Name: Lenovo

Issued to

Compal Electronics, INC.

No. 581, Ruiguang RD., Neihu District, Taipei City 11492, Taiwan, R.O.C.

Issued by

Compliance Certification Services Inc.

No.11, Wugong 6th Rd., Wugu Dist.,

New Taipei City 24891, Taiwan. (R.O.C.)

<http://www.ccsrf.com>

service@ccsrf.com

Issued Date: March 5, 2014



Note: This report shall not be reproduced except in full, without the written approval of Compliance Certification Services Inc. This document may be altered or revised by Compliance Certification Services Inc. personnel only, and shall be noted in the revision section of the document.



Revision History

Rev.	Issue Date	Revisions	Effect Page	Revised By
00	March 5, 2014	Initial Issue	ALL	Angel Cheng



TABLE OF CONTENTS

1	TEST RESULT CERTIFICATION.....	4
2	EUT DESCRIPTION	5
3	TEST METHODOLOGY	6
3.1.	DESCRIPTION OF TEST MODES	6
4	INSTRUMENT CALIBRATION.....	7
4.1.	MEASURING INSTRUMENT CALIBRATION	7
4.2.	MEASUREMENT EQUIPMENT USED	7
4.3.	MEASUREMENT UNCERTAINTY	8
5	FACILITIES AND ACCREDITATIONS	9
5.1.	FACILITIES.....	9
5.2.	EQUIPMENT.....	9
5.3.	TABLE OF ACCREDITATIONS AND LISTINGS.....	10
6	SETUP OF EQUIPMENT UNDER TEST.....	11
6.1.	SETUP CONFIGURATION OF EUT.....	11
6.2.	SUPPORT EQUIPMENT.....	11
7	APPLICABLE RULES	12
8	RSS 210 REQUIREMENTS	21
8.1.	99% BANDWIDTH	21
8.2.	RADIATED EMISSIONS.....	24
8.3.	POWERLINE CONDUCTED EMISSIONS.....	33
9	APPENDIX I PHOTOGRAPHS OF TEST SETUP.....	36



1 TEST RESULT CERTIFICATION

Applicant: Compal Electronics, INC.
No. 581, Ruiguang RD., Neihu District,
Taipei City 11492, Taiwan, R.O.C.

Equipment Under Test: Digitizer I/O device

Trade Name: Lenovo

Model: SU8E-10W05MI-01A

Date of Test: March 3 ~ 6, 2014

APPLICABLE STANDARDS	
STANDARD	TEST RESULT
FCC 47 CFR Part 15 Subpart C & Industry Canada RSS-210 Issue 8 December, 2010	No non-compliance noted

We hereby certify that:

Compliance Certification Services Inc. tested the above equipment in accordance with the requirements set forth in the above standards. The test results show that the equipment tested is capable of demonstrating compliance with the requirements as documented in this report.

The test results of this report relate only to the tested sample identified in this report.

Approved by:

Miller Lee
Section Manager

Reviewed by:

Angel Cheng
Section Manager



2 EUT DESCRIPTION

Product	Digitizer I/O device
Trade Name	Lenovo
Model Number	SU8E-10W05MI-01A
Power Supply	1. Power from power adapter. 2. Power from battery.
Operating Frequency Range	531.25kHz, 562.50kHz, 593.75KHz
Antenna Specification	Loop Antenna
Note	The application is for limited module approval. The host PC device show as following: Tablet Computer Brand: Lenovo / FCC Model Number: TP00064A IC Model Number: TP00064AWD

Power Rating

Component	Model / Specification	Manufacturer
Adapter	ADLX36NCT2B AC Input: 100-240V, 1.5A, 50-60Hz DC Output: 12V, 3A	lenovo
Battery	ASM P/N 45N1726 / 3.7V 8.92Ah 33Wh	lenovo



3 TEST METHODOLOGY

The tests documented in this report were performed in accordance with ANSI C63.4 (2003) and FCC CFR 47 Part 2, 15.207, 15.209.

The tests documented in this report were performed in accordance with IC RSS-210, IC RSS-Gen, IC RSS-102, IC RSS-Gen Issue 3, and ANSI C63.4 (2003).

This submittal(s) (test report) is intended for IC Certification with Industry Canada RSS-210.

3.1. DESCRIPTION OF TEST MODES

The EUT (model: TP00064AWD) had been tested under operating condition.

Test program used to control the EUT for staying in continuous transmitting mode was programmed.

After verification, all tests were carried out with the worst case test modes as shown below 1GHz.

RF ID: Channel 531.25kHz, 562.50kHz, 593.75kHz were chosen for full testing.



4 INSTRUMENT CALIBRATION

4.1. MEASURING INSTRUMENT CALIBRATION

The measuring equipment, which was utilized in performing the tests documented herein, has been calibrated in accordance with the manufacturer's recommendations for utilizing calibration equipment, which is traceable to recognized national standards.

4.2. MEASUREMENT EQUIPMENT USED

Equipment Used for Emissions Measurement

Remark: Each piece of equipment is scheduled for calibration once a year and Loop Antenna is scheduled for calibration once three years.

Conducted Emissions Test Site				
Name of Equipment	Manufacturer	Model	Serial Number	Calibration Due
Spectrum Analyzer	Agilent	E4446A	MY43360131	03/20/2014
Power Meter	Anritsu	ML2495A	1012009	06/04/2014
Power Sensor	Anritsu	MA2411A	0917072	06/04/2014

3M Semi Anechoic Chamber				
Name of Equipment	Manufacturer	Model	Serial Number	Calibration Due
Spectrum Analyzer	Agilent	E4446A	US42510268	11/05/2014
EMI Test Receiver	R&S	ESCI	100064	02/27/2015
Pre-Amplifier	Mini-Circuits	ZFL-1000LN	SF350700823	01/11/2015
Pre-Amplifier	MITEQ	AFS44-00102650-42-10P-44	1415367	11/18/2014
Bilog Antenna	Sunol Sciences	JB3	A030105	10/01/2014
Horn Antenna	EMCO	3117	00055165	02/12/2015
Horn Antenna	EMCO	3116	2487	10/09/2014
Loop Antenna	EMCO	6502	8905/2356	06/12/2014
Turn Table	CCS	CC-T-1F	N/A	N.C.R
Antenna Tower	CCS	CC-A-1F	N/A	N.C.R
Controller	CCS	CC-C-1F	N/A	N.C.R
Site NSA	CCS	N/A	N/A	12/21/2014
Test S/W	EZ-EMC (CCS-3A1RE)			

Powerline Conducted Emissions Test Site B				
Name of Equipment	Manufacturer	Model	Serial Number	Calibration Due
EMI Test Receiver	R&S	ESCI	101073	07/30/2014
LISN	R&S	ENV216	101054	06/05/2014
LISN	EMCO	3825/2	9106-1809	07/02/2014
ISN	FCC	FCC-TLISN-T2-02-09	100105	07/29/2014
ISN	FCC	FCC-TLISN-T4-02-09	20395	05/23/2014
ISN	FCC	FCC-TLISN-T8-02-09	100106	07/30/2014
Capacitive Voltage Probe	FCC	F-CVP-1	100185	03/24/2014
Test S/W	CCS-3A1-CE			



4.3. MEASUREMENT UNCERTAINTY

PARAMETER	UNCERTAINTY
Powerline Conducted Emission	+/- 1.2575
3M Semi Anechoic Chamber / 30MHz ~ 200MHz	+/- 4.0138
3M Semi Anechoic Chamber / 200MHz ~ 1GHz	+/- 3.9483
3M Semi Anechoic Chamber / 1 ~ 8GHz	+/- 2.5975
3M Semi Anechoic Chamber / 8 ~ 18GHz	+/- 2.6112
3M Semi Anechoic Chamber / 18 ~ 26GHz	+/- 2.7389
3M Semi Anechoic Chamber / 26 ~ 40GHz	+/- 2.9683

Remark: This uncertainty represents an expanded uncertainty expressed at approximately the 95% confidence level using a coverage factor of $k=2$.



5 FACILITIES AND ACCREDITATIONS

5.1. FACILITIES

All measurement facilities used to collect the measurement data are located at

No.199, Chunghsen Road, Hsintien City, Taipei Hsien, Taiwan, R.O.C.

Tel: 886-2-2217-0894 / Fax: 886-2-2217-1029

No.11, Wugong 6th Rd., Wugu Dist., New Taipei City 24891, Taiwan. (R.O.C.)

Tel: 886-2-2299-9720 / Fax: 886-2-2298-4045

No.81-1, Lane 210, Bade 2nd Rd., Lujhu Township, Taoyuan County 33841, TAIWAN, R.O.C.

Tel: 886-3-324-0332 / Fax: 886-3-324-5235

The sites are constructed in conformance with the requirements of ANSI C63.7, ANSI C63.4 (2003) and CISPR Publication 22.

5.2. EQUIPMENT

Radiated emissions are measured with one or more of the following types of linearly polarized antennas: tuned dipole, biconical, log periodic, bi-log, and/or ridged waveguide, horn. Spectrum analyzers with pre-selectors and quasi-peak detectors are used to perform radiated measurements.



Conducted emissions are measured with Line Impedance Stabilization Networks and EMI Test Receivers.

Calibrated wideband preamplifiers, coaxial cables, and coaxial attenuators are also used for making measurements.

All receiving equipment conforms to CISPR Publication 16-1, "Radio Interference Measuring Apparatus and Measurement Methods."



5.3. TABLE OF ACCREDITATIONS AND LISTINGS

Country	Agency	Scope of Accreditation	Logo
USA	FCC	3M Semi Anechoic Chamber (FCC MRA: TW1039) to perform FCC Part 15 measurements	 FCC MRA: TW1039
Taiwan	TAF	LP0002, RTTE01, FCC Method-47 CFR Part 15 Subpart C, D, E, RSS-210, RSS-310 IDA TS SRD, AS/NZS 4268, AS/NZS 4771, TS 12.1 & 12.2, ETSI EN 300 440-1, ETSI EN 300 440-2, ETSI EN 300 328, ETSI EN 300 220-1, ETSI EN 300 220-2, ETSI EN 301 893, ETSI EN 301 489-1/3/7/17 FCC OET Bulletin 65 + Supplement C, EN 50360, EN 50361, EN 50371, RSS 102, EN 50383, EN 50385, EN 50392, IEC 62209, CNS 14958-1, CNS 14959 FCC Method -47 CFR Part 15 Subpart B IEC / EN 61000-3-2, IEC / EN 61000-3-3, IEC / EN 61000-4-2/3/4/5/6/8/11	
Canada	Industry Canada	3M Semi Anechoic Chamber (IC 2324G-1 / IC 2324G-2) to perform	

Note: No part of this report may be used to claim or imply product endorsement by A2LA, TAF or other government agency.



6 SETUP OF EQUIPMENT UNDER TEST

6.1. SETUP CONFIGURATION OF EUT

See test photographs attached in Appendix 1 for the actual connections between EUT and support equipment.

6.2. SUPPORT EQUIPMENT

No.	Device Type	Brand	Model	Series No.	FCC ID	Data Cable	Power Cord
	N/A						



7 APPLICABLE RULES

RSS-210 §2 General Certification Requirements and Specifications

RSS-210 §2.1 RSS-Gen Compliance

In addition to RSS-210, the requirements in RSS-Gen, General Requirements and Information for the Certification of Radio Apparatus, must be met.

RSS-210 §2.2 Emissions Falling Within Restricted Frequency Bands

Category I licence-exempt equipment is required to comply with the provisions in RSS-Gen with respect to emissions falling within restricted frequency bands. These restricted frequency bands are listed in RSS-Gen.

RSS-210 §2.3 Receivers

Category I equipment receivers for use with transmitters subject to RSS-210 must comply with the applicable requirements set out in RSS-Gen and be certified under RSS-210. Category II equipment receivers for use with transmitters subject to RSS-210 are exempt from certification, but are subject to compliance with RSS-Gen and RSS-310.

RSS-210 §2.5 General Field Strength Limits

RSS-Gen includes the general field strength limits of unwanted emissions, where applicable, for transmitters and receivers operating in accordance with the provisions specified in this standard. Unwanted emissions of transmitters and receivers are permitted to fall within the restricted bands listed in RSS-Gen, and including the TV bands, but fundamental emissions are prohibited in the restricted bands.

RSS-210 §2.5.1 Transmitters with Wanted Emissions that are Within the General Field Strength Limits

Whether or not their operation is addressed by published RSS standards, transmitters whose wanted and unwanted emissions are within the general field strength limits shown in RSS-Gen, they may operate in any of the frequency bands, other than the restricted bands listed in RSS-Gen and including the TV bands, and shall be certified under RSS-210. Under no conditions may the level of any unwanted emissions exceed the level of the fundamental emission.

Note: Devices operating below 490 kHz in which all emissions are at least 40 dB below the limit listed in RSS-Gen (General Field Strength Limits for Transmitters at Frequencies below 30 MHz) are Category II devices and are subject to RSS-310.



RSS-210 §2.7 Tables

RSS-210 §Annex 8: Frequency Hopping and Digital Modulation Systems Operating in the 902-928 MHz, 2400-2483.5 MHz, and 5725-5850 MHz Bands

This section applies to systems that employ frequency hopping (FH) and digital modulation technology in the 902-928 MHz, 2400-2483.5 MHz and 5725-5850 MHz bands. Systems in these bands may employ frequency hopping, digital modulation and or a combination (hybrid) of both techniques.

A frequency hopping system that synchronizes with another or several other systems (to avoid frequency collision among them) via off-air sensing or via connecting cables is not hopping randomly and therefore is not in compliance with RSS-210.

RSS-210 §A8.1 Frequency Hopping Systems

Frequency hopping systems are spread spectrum systems in which the carrier is modulated with coded information in a conventional manner causing a conventional spreading of the RF energy about the carrier frequency. The frequency of the carrier is not fixed but changes at fixed intervals under the direction of a coded sequence.

Frequency hopping systems are not required to employ all available hopping frequencies during each transmission. However, the system, consisting of both the transmitter and the receiver, must be designed to comply with all of the regulations in this section should the transmitter be presented with a continuous data (or information) stream.

Incorporation of intelligence into a frequency hopping system that enables it to recognize other users of the band and to avoid occupied frequencies is permitted, provided that the frequency hopping system does it individually, and independently chooses or adapts its hopset. The coordination of frequency hopping systems in any other manner for the express purpose of avoiding the simultaneous occupancy of individual hopping frequencies by multiple transmitters is not permitted.

The following applies to frequency hopping systems in each of the three bands.

(a) The bandwidth of a frequency hopping channel is the 20 dB emission bandwidth, measured with the hopping stopped. The system RF bandwidth is equal to the channel bandwidth multiplied by the number of channels in the hopset. The hopset shall be such that the near term distribution of frequencies appears random, with sequential hops randomly distributed in both direction and magnitude of change in the hopset while the long term distribution appears evenly distributed.

(b) Frequency hopping systems shall have hopping channel carrier frequencies separated by a minimum of 25 kHz or the 20 dB bandwidth of the hopping channel, whichever is greater. Alternatively, frequency hopping systems operating in the 2400-2483.5 MHz band may have hopping channel carrier frequencies that are separated by 25 kHz or two-thirds of the 20 dB bandwidth of the hopping channel, whichever is greater, provided the systems operate with an output power no greater than 0.125 W. The system receivers shall have input bandwidths that match the hopping channel bandwidths of their corresponding transmitters and shall shift frequencies in synchronization with the transmitted signals.

(d) Frequency hopping systems operating in the 2400-2483.5 MHz band shall use at least 15 hopping channels. The average time of occupancy on any channel shall not be greater than 0.4 seconds within a period of 0.4 seconds multiplied by the number of hopping channels employed. Transmissions on particular hopping frequencies may be avoided or suppressed provided that a minimum of 15 hopping channels are used.

RSS-210 §A8.2 Digital Modulation Systems

These include systems employing digital modulation techniques resulting in spectral



characteristics similar to direct sequence systems. The following applies to all three bands.

RSS-210 §A8.4 Transmitter Output Power and e.i.r.p. Requirements

(4) For systems employing digital modulation techniques operating in the 902-928 MHz, 2400-2483.5 MHz and 5725-5850 MHz bands, the maximum peak conducted power shall not exceed 1 W. Except as provided in Section A8.4(5), the e.i.r.p. shall not exceed 4 W.

As an alternative to a peak power measurement, compliance can be based on a measurement of the maximum conducted output power (see RSS-Gen)

(5) Point-to-point systems in the bands 2400-2483.5 MHz and 5725-5850 MHz are permitted to have an e.i.r.p. higher than 4 W, provided that the higher e.i.r.p. is achieved by employing higher gain directional antennas and not higher transmitter output powers. Point-to-multipoint systems, omni-directional applications and multiple co-located transmitters transmitting the same information are prohibited from exceeding 4 W e.i.r.p. However, remote stations of point-to-multipoint systems shall be allowed to operate at greater than 4 W e.i.r.p, under the same conditions as for point-to- point systems.

Note: “Fixed, point-to-point operation”, excludes point-to-multipoint systems, omnidirectional applications and multiple co-located transmitters transmitting the same information.

RSS-210 §A8.5 Out-of-band Emissions

In any 100 kHz bandwidth outside the frequency band in which the spread spectrum or digitally modulated device is operating, the radio frequency power that is produced shall be at least 20 dB below that in the 100 kHz bandwidth within the band that contains the highest level of the desired power, based on either an RF conducted or a radiated measurement, provided the transmitter demonstrates compliance with the peak conducted power limits. If the transmitter complies with the conducted power limits based on the use of RMS averaging over a time interval, as permitted under section A8.4(4), the attenuation required shall be 30 dB instead of 20 dB. Attenuation below the general limits specified in Tables 2 and 3 is not required.

RSS-Gen §2 General Information

RSS-Gen §2.1.2 Category II Equipment

Category II equipment comprises radio devices where a standard has been prescribed but for which a TAC is not required, that is, equipment certification by Industry Canada or a Certification Body (CB) is not required (certification exempt), pursuant to subsection 4(3) of the Radiocommunication Act. The manufacturer or importer shall nevertheless ensure that the standards are complied with. A test report shall be available on request and the device shall be properly labelled.



RSS-Gen §2.2 Receivers

Receivers that are used for radiocommunication other than broadcasting are defined as Category I equipment or Category II equipment, subject to compliance with applicable Industry Canada standards.

Receivers shall be capable of operation only with transmitters for which RSSs are published. Receivers are classified as described in sections 2.2.1 and 2.2.2.

RSS-Gen §2.2.1 Category I Equipment Receivers

A receiver is classified as Category I equipment if it meets one of the following conditions:

- (a) a stand-alone receiver (see Note 1, below), which operates on any frequency in the band 30-960 MHz, and is used for the reception of signals in that frequency band from a transmitter classified as Category I equipment;
- (b) a Citizen's Band (CB) receiver (26.96-27.410 MHz);
- (c) a scanner receiver.

Note 1: A stand-alone receiver is defined as any receiver that is not permanently combined together with a transmitter in a single case (transceiver), in which it functions as the receiver component of the transceiver.

Receivers classified as Category I equipment shall comply with the limits for receiver spurious emissions set out in RSS-Gen; however, equipment certification is granted under the applicable RSS standard along with the associated transmitter classified as Category I equipment. Scanner receivers are covered under their own specific RSS.

RSS-Gen §2.2.2 Category II Equipment Receivers

A receiver is classified as Category II equipment if it does not meet any of the conditions of Section 2.2.1.

Category II receivers shall comply with the applicable testing, labelling and user manual requirements in RSS-310.

RSS-Gen §2.2.3 Licence-exempt Receivers

Certain types of radio apparatus are permitted to operate without licensing from Industry Canada. These are typically low output power devices that are intended primarily for consumer or commercial applications; however, some are intended for applications in law enforcement, medical and other specialized applications.

Licence-exempt radio apparatus shares spectrum with licensed radio services and must operate on a no-interference, no-protection basis. Licence-exempt radio apparatus may not cause radio interference to, and cannot claim protection from interference caused by, licensed radio services. General requirements for licence-exempt radio apparatus are contained in Section 7.



RSS-Gen §5.6 Exposure of Humans to RF Fields

Category I and Category II equipment shall comply with the applicable requirements of RSS-102.

RSS-Gen §6 Receiver Spurious Emission Standard

Receivers shall comply with the limits of spurious emissions set out in this section, measured over the frequency range determined in accordance with Section 4.10.

RSS-Gen §6.1 Radiated Limits

Radiated spurious emission measurements shall be performed with the receiver antenna connected to the receiver antenna terminals.

Spurious emissions from receivers shall not exceed the radiated limits shown in the table below:

RSS-Gen Table 2 - Spurious Emission Limits for Receivers

Frequency (MHz)	Field Strength microvolts/m at 3 metres
30-88	100
88-216	150
216-960	200
Above 960	500

*Measurements for compliance with limits in the above table may be performed at distances other than 3 metres, in accordance with Section 7.2.7.



RSS- Gen Table 3: Restricted Frequency Bands (Note)

MHz	MHz	MHz	MHz	GHz
0.090-0.110	8.37625-8.38675	--	1718.8-1722.2	9.0-9.2
--	8.41425-8.41475	156.52475-156.52525	2200-2300	9.3-9.5
2.1735-2.1905	12.29-12.293	156.7-156.9	2310-2390	10.6-12.7
3.020-3.026	12.51975-12.52025	--	--	13.25-13.4
4.125-4.128	12.57675-12.57725	--	2655-2900	14.47-14.5
4.17725-4.17775	13.36-13.41	240-285	3260-3267	15.35-16.2
4.20725-4.20775	16.42-16.423	322-335.4	3332-3339	17.7-21.4
5.677-5.683	16.69475-16.69525	399.9-410	3345.8-3358	22.01-23.12
6.215-6.218	16.80425-16.80475	608-614	3500-4400	23.6-24.0
6.26775-6.26825	25.5-25.67	960-1427	4500-5150	31.2-31.8
6.31175-6.31225	37.5-38.25	1435-1626.5	5350-5460	36.43-36.5
8.291-8.294	73-74.6; 74.8-75.2	1645.5-1646.5	7250-7750	Above 38.6
8.362-8.366	108-138	1660-1710	8025-8500	

Note: Certain frequency bands listed in Table 2 and above 38.6 GHz are designated for low-power licence-exempt applications. These frequency bands and the requirements that apply to the devices are set out in this Standard as well as RSS-310.

RSS- Gen Table 5: General Field Strength Limits for Transmitters at Frequencies Above 30 MHz

Frequency (MHz)	Field Strength (microvolt/m at 3 metres)
30-88	100
88-216	150
216-960	200
Above 960	500

Note: Transmitting devices are not permitted in Table 1 bands or, unless stated otherwise, in TV bands(54-72 MHz, 76-88 MHz, 174-216 MHz, 470-608 MHz and 614-806 MHz).



RSS- Gen Table 6: General Field Strength Limits for Transmitters at Frequencies Below 30 MHz (Transmit)

Frequency (fundamental or spurious)	Field Strength (microvolts/m)	Magnetic H-Field (microamperes/m)	Measurement Distance (metres)
9-490 kHz	2,400/F (F in kHz)	2,400/377F (F in Hz)	300
490-1.705 kHz	24,000/F (F in kHz)	24,000/377F (F in kHz)	30
1.705-30 MHz	30	N/A	30

Note: The emission limits for the bands 9-90 kHz and 110-490 kHz are based on measurements employing an average detector.



RSS-Gen §7.1.2 Transmitter Antenna

A transmitter can only be sold or operated with antennas with which it was approved. Transmitter may be approved with multiple antenna types. An antenna type comprises antennas having similar in-band and out-of-band radiation patterns. Testing shall be performed using the highest gain antenna of each combination of transmitter and antenna type for which approval is being sought, with the transmitter output power set at the maximum level. Any antenna of the same type having equal or lesser gain as an antenna that had been successfully tested with the transmitter, will also be considered approved with the transmitter, and may be used and marketed with the transmitter. For Category I transmitters, the manufacturer shall include with the application for certification a list of acceptable antenna types to be used with the transmitter.

When a measurement at the antenna connector is used to determine RF output power, the effective gain of the device's antenna shall be stated, based on measurement or on data from the antenna manufacturer.

For transmitters of RF output power of 10 milliwatts or less, only the portion of the antenna gain that is in excess of 6 dBi (6 dB above isotropic gain) shall be added to the measured RF output power to demonstrate compliance with the radiated power limits specified in the applicable standard. For transmitters of output power greater than 10 milliwatts, the total antenna gain shall be added to the measured RF output power to demonstrate compliance to the specified radiated power limits. User manuals for transmitters shall display the following notice in a conspicuous location:

Under Industry Canada regulations, this radio transmitter may only operate using an antenna of a type and maximum (or lesser) gain approved for the transmitter by Industry Canada. To reduce potential radio interference to other users, the antenna type and its gain should be so chosen that the equivalent isotropically radiated power (e.i.r.p.) is not more than that necessary for successful communication.

The above notice may be affixed to the device instead of displayed in the user manual.

User manuals for transmitters equipped with detachable antennas shall also contain the following notice in a conspicuous location:

This radio transmitter (identify the device by certification number, or model number if Category II) has been approved by Industry Canada to operate with the antenna types listed below with the maximum permissible gain and required antenna impedance for each antenna type indicated. Antenna types not included in this list, having a gain greater than the maximum gain indicated for that type, are strictly prohibited for use with this device.

Immediately following the above notice, the manufacturer shall provide a list of all antenna types approved for use with the transmitter, indicating the maximum permissible antenna gain (in dBi) and required impedance for each.



RSS-Gen §7.2.4 Transmitter and Receiver AC Power Lines Conducted Emission Limits

Except when the requirements applicable to a given device state otherwise, for any radio apparatus equipped to operate from the public utility AC power supply, either directly or indirectly (such as with a battery charger), the radio frequency voltage of emissions conducted back onto the AC power lines in the frequency range of 0.15 MHz to 30 MHz shall not exceed the limits shown in the table below. The more stringent limit applies at the frequency range boundaries.

The conducted emissions shall be measured with a 50 ohm/50 microhenry line impedance stabilization network (LISN).

RSS-Gen Table 4 – AC Power Line Conducted Emission Limits

Frequency Range (MHz)	Conducted limit (dBµV)	
	Quasi-peak	Average
0.15 to 0.5	66 to 56*	56 to 46*
0.5 to 5	56	46
5 to 30	60	50

**Decreases with the logarithm of the frequency.*



8 RSS 210 REQUIREMENTS

8.1. 99% BANDWIDTH

TEST CONFIGURATION

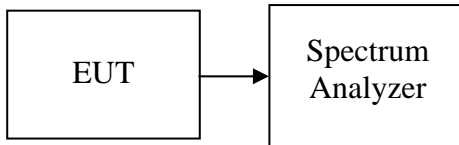

TEST PROCEDURE

1. Place the EUT on the table and set it in the transmitting mode.
2. Remove the antenna from the EUT and then connect a low loss RF cable from the antenna port to the spectrum analyzer.
3. Set the spectrum analyzer as RBW=20Hz, VBW = 62Hz, Span = 2kHz, Sweep = auto.
4. Record the max. reading.

TEST RESULTS

No non-compliance noted

TEST DATA

Frequency (KHz)	B (kHz)
531.25	1.4809
562.50	1.4748
593.75	1.4552



Test Plot

531.25 kHz

Agilent

R T

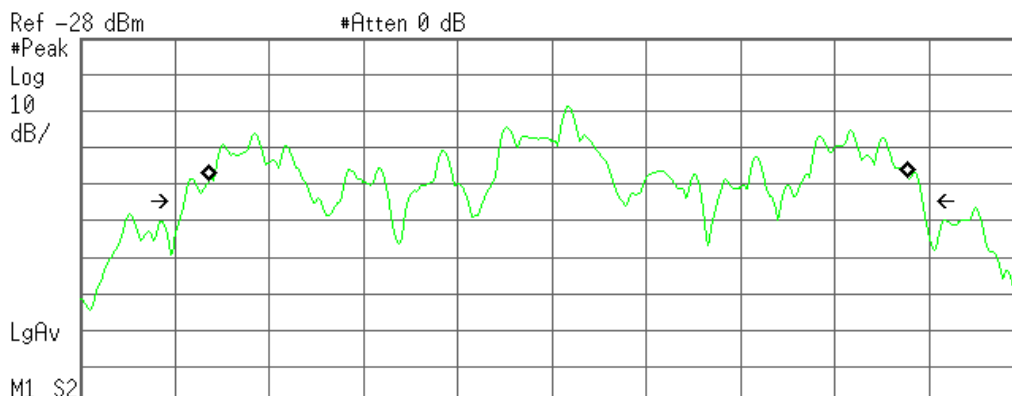

M1 S2
Center 531.250 kHz Span 2 kHz
#Res BW 20 Hz #VBW 62 Hz Sweep 95.48 ms (601 pts)

Occupied Bandwidth
1.4809 kHz

Occ BW % Pwr 99.00 %
x dB -26.00 dB

Transmit Freq Error 13.016 Hz
x dB Bandwidth 1.564 kHz

562.50 kHz

Agilent

R T

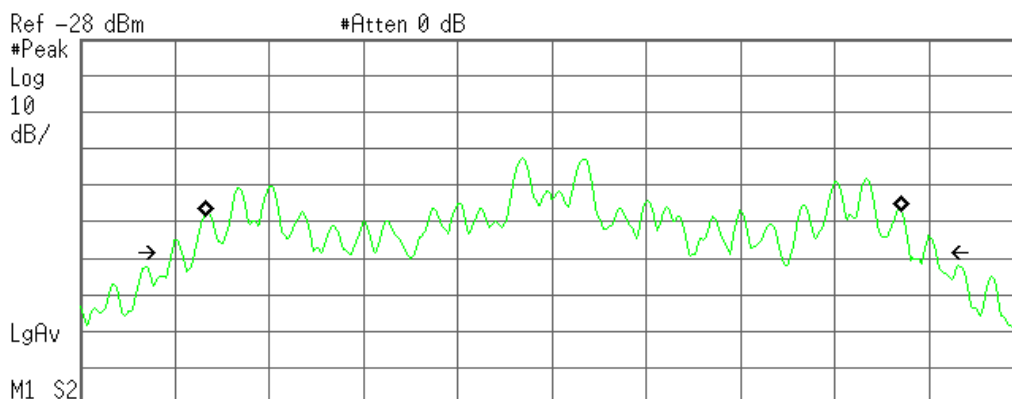

M1 S2
Center 562.500 kHz Span 2 kHz
#Res BW 20 Hz #VBW 62 Hz Sweep 95.48 ms (601 pts)

Occupied Bandwidth
1.4748 kHz

Occ BW % Pwr 99.00 %
x dB -26.00 dB

Transmit Freq Error 3.519 Hz
x dB Bandwidth 1.625 kHz



593.75kHz

Agilent

R T

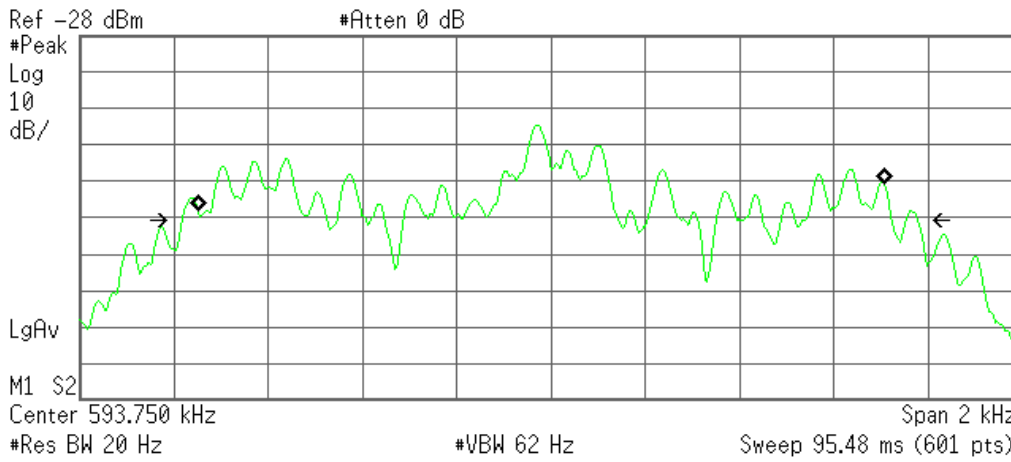

Occupied Bandwidth
1.4552 kHz

Occ BW % Pwr 99.00 %
x dB -26.00 dB

Transmit Freq Error -19.986 Hz
x dB Bandwidth 1.558 kHz



8.2. RADIATED EMISSIONS

LIMIT

1. According to §15.209(a), except as provided elsewhere in this Subpart, the emissions from an intentional radiator shall not exceed the field strength levels specified in the following table:

Frequency (MHz)	Field Strength ($\mu\text{V/m}$)	Measurement Distance (m)
0.009–0.490	2400/F(kHz)	300
0.490–1.705	24000/F(kHz)	30
1.705–30.0	30	30
30–88	100**	3
88–216	150**	3
216–960	200**	3
Above 960	500	3

Remark: Except as provided in paragraph (g), fundamental emissions from intentional radiators operating under this Section shall not be located in the frequency bands 54-72 MHz, 76-88 MHz, 174-216 MHz or 470-806 MHz. However, operation within these frequency bands is permitted under other sections of this Part, e.g., Sections 15.231 and 15.241.

2. In the emission table above, the tighter limit applies at the band edges.

Frequency (Hz)	Field Strength ($\mu\text{V/m}$ at 3-meter)	Field Strength (dB $\mu\text{V/m}$ at 3-meter)
30-88	100	40
88-216	150	43.5
216-960	200	46
Above 960	500	54



TEST CONFIGURATION

9kHz ~ 30MHz

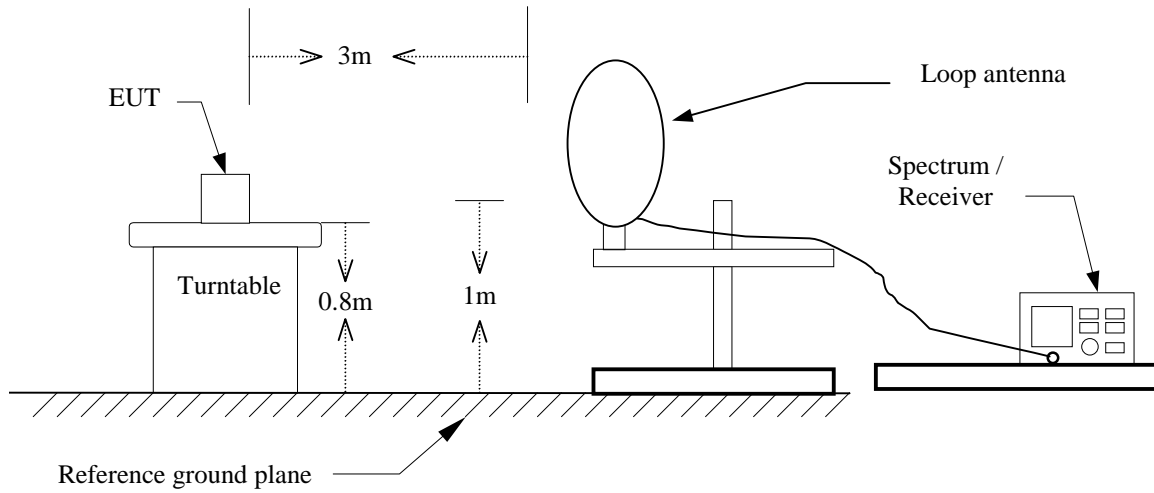

30MHz ~ 1 GHz

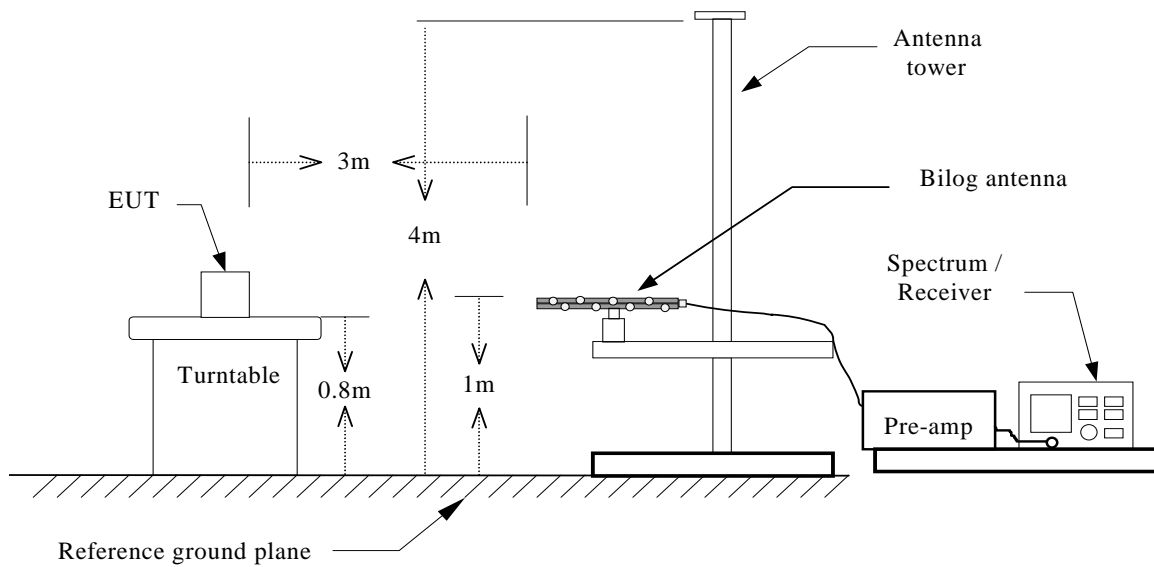



TEST PROCEDURE

For 9kHz ~ 30MHz

1. The EUT is placed on a turntable, which is 0.8m above ground plane.
2. The turntable shall be rotated for 360 degrees to determine the position of maximum emission level.
3. EUT is set 3m away from the receiving antenna, The center of the loop shall be 1 m above the ground then to find out the highest emissions.
4. Maximum procedure was performed on the six highest emissions to ensure EUT compliance.
5. And also, each emission was to be maximized by rotated of receiving antenna axis
6. Set the spectrum analyzer in the following setting as:
RBW=10kHz / VBW=30kHz / Sweep=AUTO
7. Repeat above procedures until the measurements for all frequencies are complete.

For 30MHz ~ 1GHz

1. The EUT is placed on a turntable, which is 0.8m above ground plane.
2. The turntable shall be rotated for 360 degrees to determine the position of maximum emission level.
3. EUT is set 3m away from the receiving antenna, which is varied from 1m to find out the highest emissions.
4. Maximum procedure was performed on the six highest emissions to ensure EUT compliance.
5. And also, each emission was to be maximized by changing the polarization of receiving antenna both horizontal and vertical.
6. Set the spectrum analyzer in the following setting as:
RBW=100kHz / VBW=300kHz / Sweep=AUTO
7. Repeat above procedures until the measurements for all frequencies are complete.

TEST RESULTS

No non-compliance noted.



TEST DATA

Operation Mode: TX mode (531.25kHz) **Test Date:** March 3, 2014
Temperature: 27°C **Tested by:** Rex Huang
Humidity: 53 % RH

Frequency (MHz)	Reading (dBuV)	Correction Factor (dB/m)	Result (dBuV/m)	Limit 3m (dBuV/m)	Margin (dB)	Detector Mode (PK/QP/AVG)
0.5313	36.45	0.00	36.45	73.10	-36.65	Peak
0.3529	41.54	0.00	41.54	103.69	-62.15	Peak
0.3673	40.89	0.00	40.89	102.65	-61.76	Peak
0.3898	39.86	0.00	39.86	101.03	-61.17	Peak
0.4138	39.32	0.00	39.32	99.30	-59.98	Peak
0.4355	39.79	0.00	39.79	97.73	-57.94	Peak
0.4635	41.23	0.00	41.23	95.71	-54.48	Peak
13.6710	21.00	0.00	21.00	69.50	-48.50	Peak
21.5896	13.11	0.00	13.11	69.50	-56.39	Peak
22.6717	16.39	0.00	16.39	69.50	-53.11	Peak
25.6720	17.12	0.00	17.12	69.50	-52.38	Peak
28.7211	14.86	0.00	14.86	69.50	-54.64	Peak

- Remark:**
1. Measuring frequencies from 9kHz to the 1GHz.
 2. Radiated emissions measured in frequency range from 9kHz to 1000MHz were made with an instrument using peak/quasi-peak/average detector mode.
 3. Measurements above show only up to 6 maximum emissions noted, or would be lesser, with " N/A " remark, if no specific emissions from the EUT are recorded (ie: margin>20dB from the applicable limit) and considered that's already beyond the background noise floor.
 4. Margin (dB) = Result (dBuV/m) – Limit (dBuV/m).
 5. 531.25kHz Limit=20 log (24000/531.25)+40 log (30/3) =73.10



Operation Mode: TX mode (562.5kHz) **Test Date:** March 3, 2014
Temperature: 27°C **Tested by:** Rex Huang
Humidity: 53 % RH

Frequency (MHz)	Reading (dBuV)	Correction Factor (dB/m)	Result (dBuV/m)	Limit 3m (dBuV/m)	Margin (dB)	Detector Mode (PK/QP/AVG)
0.5625	35.78	0.00	35.78	72.61	-36.83	Peak
0.3305	42.05	0.00	42.05	105.31	-63.26	Peak
0.3497	41.59	0.00	41.59	103.92	-62.33	Peak
0.3681	40.55	0.00	40.55	102.60	-62.05	Peak
0.4018	39.41	0.00	39.41	100.16	-60.75	Peak
0.4243	40.14	0.00	40.14	98.54	-58.40	Peak
0.4523	38.73	0.00	38.73	96.52	-57.79	Peak
13.5728	24.96	0.00	24.96	69.50	-44.54	Peak
22.6717	16.09	0.00	16.09	69.50	-53.41	Peak
24.8358	13.80	0.00	13.80	69.50	-55.70	Peak
25.6719	16.76	0.00	16.76	69.50	-52.74	Peak
28.7212	13.96	0.00	13.96	69.50	-55.54	Peak

- Remark:**
1. Measuring frequencies from 9kHz to the 1GHz.
 2. Radiated emissions measured in frequency range from 9kHz to 1000MHz were made with an instrument using peak/quasi-peak/average detector mode.
 3. Measurements above show only up to 6 maximum emissions noted, or would be lesser, with " N/A " remark, if no specific emissions from the EUT are recorded (ie: margin>20dB from the applicable limit) and considered that's already beyond the background noise floor.
 4. Margin (dB) = Result (dBuV/m) – Limit (dBuV/m).
 5. 562.5 kHz Limit=20 log (24000/562.5)+40 log (30/3) =72.61



Operation Mode: TX mode (593.75kHz) **Test Date:** March 3, 2014
Temperature: 27°C **Tested by:** Rex Huang
Humidity: 53 % RH

Frequency (MHz)	Reading (dBuV)	Correction Factor (dB/m)	Result (dBuV/m)	Limit 3m (dBuV/m)	Margin (dB)	Detector Mode (PK/QP/AVG)
0.5938	34.95	0.00	34.95	72.13	-37.18	Peak
0.3433	41.74	0.00	41.74	104.39	-62.65	Peak
0.3698	40.66	0.00	40.66	102.47	-61.81	Peak
0.3978	40.52	0.00	40.52	100.45	-59.93	Peak
0.4251	39.52	0.00	39.52	98.48	-58.96	Peak
0.4603	38.61	0.00	38.61	95.94	-57.33	Peak
0.4764	39.55	0.00	39.55	94.78	-55.23	Peak
8.0151	16.75	0.00	16.75	69.50	-52.75	Peak
16.0320	13.28	0.00	13.28	69.50	-56.22	Peak
22.6717	14.69	0.00	14.69	69.50	-54.81	Peak
24.0488	14.17	0.00	14.17	69.50	-55.33	Peak
25.6720	15.10	0.00	15.10	69.50	-54.40	Peak

- Remark:**
1. Measuring frequencies from 9kHz to the 1GHz.
 2. Radiated emissions measured in frequency range from 9kHz to 1000MHz were made with an instrument using peak/quasi-peak/average detector mode.
 3. Measurements above show only up to 6 maximum emissions noted, or would be lesser, with " N/A " remark, if no specific emissions from the EUT are recorded (ie: margin>20dB from the applicable limit) and considered that's already beyond the background noise floor.
 4. Margin (dB) = Result (dBuV/m) – Limit (dBuV/m).
 5. 593.75kHz Limit=20 log (24000/593.75)+40 log (30/3) =72.13



Operation Mode: Normal Link (531.25kHz)

Test Date: March 3, 2014

Temperature: 27°C

Tested by: Rex Huang

Humidity: 53 % RH

Polarity: Ver. / Hor.

Freq. (MHz)	Reading (dBuV)	Factor (dB)	Actual FS (dBuV/m)	Limit 3m (dBuV/m)	Safe Margin (dB)	Ant.Pol. H/V	Detector Mode (PK/QP)
42.9333	47.49	-18.87	28.62	40.00	-11.38	V	Peak
144.7833	37.57	-17.83	19.74	43.50	-23.76	V	Peak
282.2000	39.10	-16.72	22.38	46.00	-23.62	V	Peak
448.7167	35.87	-12.69	23.18	46.00	-22.82	V	Peak
600.6833	36.62	-10.49	26.13	46.00	-19.87	V	Peak
763.9667	34.65	-7.74	26.91	46.00	-19.09	V	Peak
31.6167	30.74	-11.06	19.68	40.00	-20.32	H	Peak
224.0000	43.39	-18.92	24.47	46.00	-21.53	H	Peak
249.8667	38.99	-18.41	20.58	46.00	-25.42	H	Peak
275.7333	38.87	-16.84	22.03	46.00	-23.97	H	Peak
392.1333	35.49	-14.20	21.29	46.00	-24.71	H	Peak
763.9667	32.73	-7.74	24.99	46.00	-21.01	H	Peak

Remark:

1. Measuring frequencies from 30 MHz to the 1GHz.
2. Radiated emissions measured in frequency range from 30 MHz to 1000MHz were made with an instrument using Peak detector mode.
3. Data of measurement within this frequency range shown " --- " in the table above means the reading of emissions are attenuated more than 20dB below the permissible limits or the field strength is too small to be measured.
4. The IF bandwidth of SPA between 30MHz to 1GHz was 100kHz.



Operation Mode: Normal Link (562.5kHz)

Test Date: March 3, 2014

Temperature: 27°C

Tested by: Rex Huang

Humidity: 53 % RH

Polarity: Ver. / Hor.

Freq. (MHz)	Reading (dBuV)	Factor (dB)	Actual FS (dBuV/m)	Limit 3m (dBuV/m)	Safe Margin (dB)	Ant.Pol. H/V	Detector Mode (PK/QP)
42.9333	48.47	-18.87	29.60	40.00	-10.40	V	Peak
148.0167	37.05	-17.92	19.13	43.50	-24.37	V	Peak
224.0000	38.54	-18.92	19.62	46.00	-26.38	V	Peak
474.5833	35.14	-12.25	22.89	46.00	-23.11	V	Peak
600.6833	36.80	-10.49	26.31	46.00	-19.69	V	Peak
763.9667	33.81	-7.74	26.07	46.00	-19.93	V	Peak
149.6333	36.83	-17.97	18.86	43.50	-24.64	H	Peak
209.4500	42.02	-18.22	23.80	43.50	-19.70	H	Peak
224.0000	42.45	-18.92	23.53	46.00	-22.47	H	Peak
275.7333	39.67	-16.84	22.83	46.00	-23.17	H	Peak
396.9833	35.45	-14.09	21.36	46.00	-24.64	H	Peak
763.9667	30.96	-7.74	23.22	46.00	-22.78	H	Peak

Remark:

1. Measuring frequencies from 30 MHz to the 1GHz.
2. Radiated emissions measured in frequency range from 30 MHz to 1000MHz were made with an instrument using Peak detector mode.
3. Data of measurement within this frequency range shown " --- " in the table above means the reading of emissions are attenuated more than 20dB below the permissible limits or the field strength is too small to be measured.
4. The IF bandwidth of SPA between 30MHz to 1GHz was 100kHz.



Operation Mode: Normal Link (593.75kHz)

Test Date: March 3, 2014

Temperature: 27°C

Tested by: Rex Huang

Humidity: 53 % RH

Polarity: Ver. / Hor.

Freq. (MHz)	Reading (dBuV)	Factor (dB)	Actual FS (dBuV/m)	Limit 3m (dBuV/m)	Safe Margin (dB)	Ant.Pol. H/V	Detector Mode (PK/QP)
41.3167	47.18	-17.95	29.23	40.00	-10.77	V	Peak
159.3333	43.95	-18.25	25.70	43.50	-17.80	V	Peak
474.5833	35.67	-12.25	23.42	46.00	-22.58	V	Peak
600.6833	36.36	-10.49	25.87	46.00	-20.13	V	Peak
624.9333	35.46	-9.91	25.55	46.00	-20.45	V	Peak
763.9667	32.54	-7.74	24.80	46.00	-21.20	V	Peak
162.5667	37.14	-18.41	18.73	43.50	-24.77	H	Peak
215.9167	41.00	-18.70	22.30	43.50	-21.20	H	Peak
396.9833	35.43	-14.09	21.34	46.00	-24.66	H	Peak
600.6833	33.15	-10.49	22.66	46.00	-23.34	H	Peak
763.9667	31.92	-7.74	24.18	46.00	-21.82	H	Peak
799.5333	31.77	-7.38	24.39	46.00	-21.61	H	Peak

Remark:

1. Measuring frequencies from 30 MHz to the 1GHz.
2. Radiated emissions measured in frequency range from 30 MHz to 1000MHz were made with an instrument using Peak detector mode.
3. Data of measurement within this frequency range shown " --- " in the table above means the reading of emissions are attenuated more than 20dB below the permissible limits or the field strength is too small to be measured.
4. The IF bandwidth of SPA between 30MHz to 1GHz was 100kHz.



8.3. POWERLINE CONDUCTED EMISSIONS

LIMIT

For an intentional radiator which is designed to be connected to the public utility (AC) power line, the radio frequency voltage that is conducted back onto the AC power line on any frequency or frequencies within the band 150 kHz to 30 MHz shall not exceed 250 microvolts (The limit decreases linearly with the logarithm of the frequency in the range 0.15 MHz to 0.50 MHz). The limits at specific frequency range is listed as follows:

Frequency Range (MHz)	Limits (dB μ V)	
	Quasi-peak	Average
0.15 to 0.50	66 to 56*	56 to 46*
0.50 to 5	56	46
5 to 30	60	50

Compliance with this provision shall be based on the measurement of the radio frequency voltage between each power line (LINE and NEUTRAL) and ground at the power terminals.

TEST CONFIGURATION

See test photographs attached in Appendix I for the actual connections between EUT and support equipment.

TEST PROCEDURE

1. The EUT was placed on a table, which is 0.8m above ground plane.
2. Maximum procedure was performed on the six highest emissions to ensure EUT compliance.
3. Repeat above procedures until all frequency measured were complete.

TEST RESULTS

The initial step in collecting conducted data is a spectrum analyzer peak scan of the measurement range. Significant peaks are then marked as shown on the following data page, and these signals are then quasi-peaked.



TEST DATA

The initial step in collecting conducted data is a spectrum analyzer peak scan of the measurement range. Significant peaks are then marked as shown on the following data page, and these signals are then quasi-peaked.

Operation Mode: Normal Link **Test Date:** March 6, 2014
Temperature: 24°C **Tested by:** Moore Cheng
Humidity: 50% RH

Freq. (MHz)	QP Reading (dBuV)	AV Reading (dBuV)	Corr. factor (dB)	QP Result (dBuV)	AV Result (dBuV)	QP Limit (dBuV)	AV Limit (dBuV)	QP Margin (dB)	AV Margin (dB)	Note
0.1740	36.63	18.99	9.61	46.24	28.60	64.76	54.77	-18.52	-26.17	L1
0.2020	33.15	17.07	9.62	42.77	26.69	63.52	53.53	-20.75	-26.84	L1
3.1740	18.55	12.03	9.70	28.25	21.73	56.00	46.00	-27.75	-24.27	L1
14.1900	22.77	15.57	9.91	32.68	25.48	60.00	50.00	-27.32	-24.52	L1
21.1540	20.69	16.43	9.97	30.66	26.40	60.00	50.00	-29.34	-23.60	L1
28.7100	18.31	10.85	9.92	28.23	20.77	60.00	50.00	-31.77	-29.23	L1
0.1500	39.31	19.78	9.66	48.97	29.44	65.99	56.00	-17.02	-26.56	L2
0.1660	38.23	22.06	9.66	47.89	31.72	65.15	55.16	-17.26	-23.44	L2
3.1740	19.29	12.66	9.76	29.05	22.42	56.00	46.00	-26.95	-23.58	L2
14.3380	23.53	16.84	9.95	33.48	26.79	60.00	50.00	-26.52	-23.21	L2
21.1620	30.00	28.13	10.00	40.00	38.13	60.00	50.00	-20.00	-11.87	L2
28.7220	28.68	27.21	10.06	38.74	37.27	60.00	50.00	-21.26	-12.73	L2

Remark:

1. Measuring frequencies from 0.15 MHz to 30MHz.
2. The emissions measured in frequency range from 0.15 MHz to 30MHz were made with an instrument using Quasi-peak detector and average detector.
3. The IF bandwidth of SPA between 0.15MHz and 30MHz was 10kHz; the IF bandwidth of Test Receiver between 0.15MHz and 30MHz was 9kHz;
4. L1 = Line One (Live Line) / L2 = Line Two (Neutral Line)



Test Plots

Conducted emissions (Line 1)

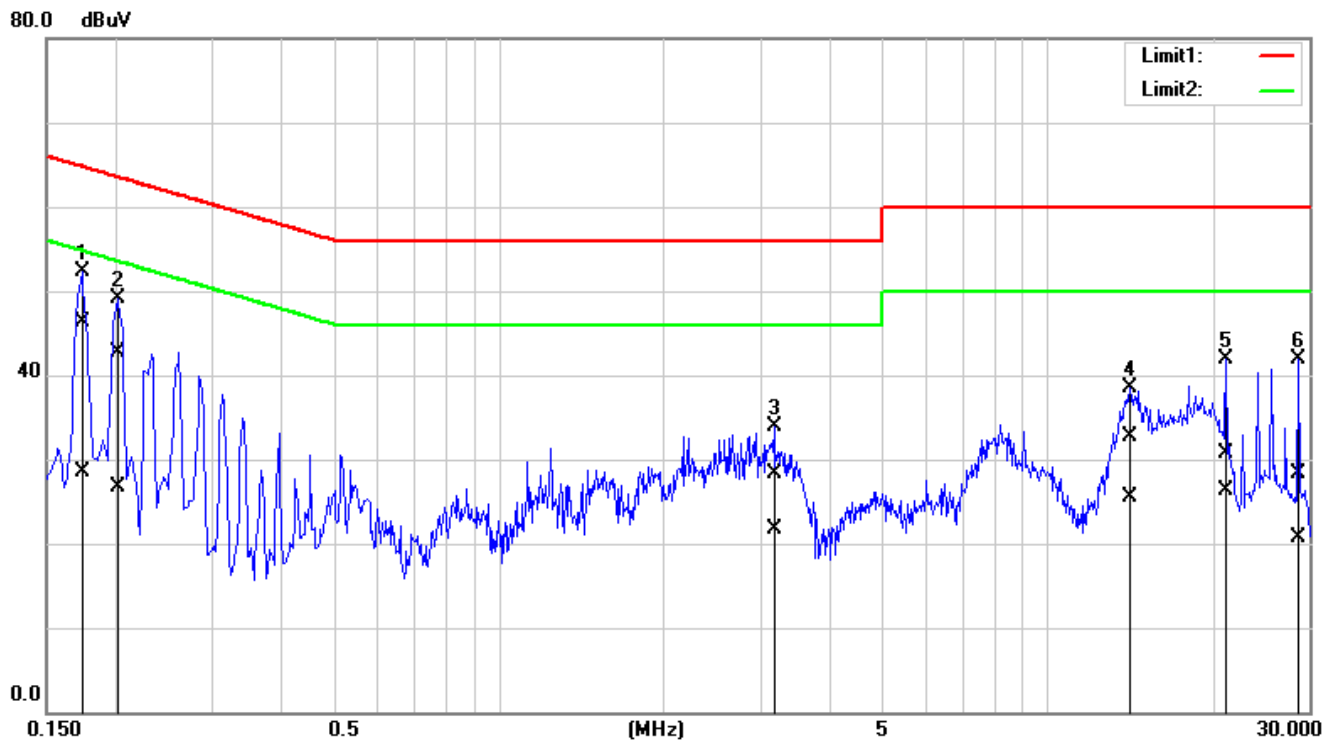

Conducted emissions (Line 2)

