



EMC Test Report

*Industry Canada RSS-Gen Issue 2 / RSS 210 Issue 7
FCC Part 15 Subpart C*

Model: Intel® Centrino® Advanced-N 6205

IC CERTIFICATION #: 1000M-622ANH
1000M-62205ANHU
FCC ID: PD962205ANH
PD962205ANHU

APPLICANT: Intel Corporation
100 Center Point Circle Suite 200
Columbia, SC 29210

TEST SITE(S): Elliott Laboratories
41039 Boyce Road.
Fremont, CA. 94538-2435

IC SITE REGISTRATION #: 2845B-3; 2845B-4, 2845B-5

REPORT DATE: August 31, 2010

FINAL TEST DATES: August 2, 3, 4, 5, 6, 9, 10, 12, 13, 26 and 27,
2010

AUTHORIZED SIGNATORY:

A handwritten signature in blue ink that reads "Mark Briggs". The signature is written over a horizontal line.

Mark Briggs
Staff Engineer
Elliott Laboratories.



Testing Cert #2016.01

Elliott Laboratories is accredited by the A2LA, certificate number 2016-01, to perform the test(s) listed in this report, except where noted otherwise. This report shall not be reproduced, except in its entirety, without the written approval of Elliott Laboratories

REVISION HISTORY

Rev#	Date	Comments	Modified By
-	08-31-2010	First release	

TABLE OF CONTENTS

REVISION HISTORY	2
TABLE OF CONTENTS	3
SCOPE.....	4
OBJECTIVE	4
STATEMENT OF COMPLIANCE.....	5
DEVIATIONS FROM THE STANDARDS.....	5
TEST RESULTS SUMMARY	6
DIGITAL TRANSMISSION SYSTEMS (2400 – 2483.5MHZ).....	6
DIGITAL TRANSMISSION SYSTEMS (5725 –5850 MHZ).....	6
GENERAL REQUIREMENTS APPLICABLE TO ALL BANDS.....	7
MEASUREMENT UNCERTAINTIES.....	7
EQUIPMENT UNDER TEST (EUT) DETAILS.....	8
GENERAL.....	8
OTHER EUT DETAILS.....	8
ENCLOSURE.....	9
MODIFICATIONS.....	9
SUPPORT EQUIPMENT.....	9
INTERFACE PORTS.....	9
EUT OPERATION.....	10
TEST SITE.....	11
GENERAL INFORMATION.....	11
CONDUCTED EMISSIONS CONSIDERATIONS.....	11
RADIATED EMISSIONS CONSIDERATIONS.....	11
MEASUREMENT INSTRUMENTATION	12
RECEIVER SYSTEM.....	12
INSTRUMENT CONTROL COMPUTER.....	12
LINE IMPEDANCE STABILIZATION NETWORK (LISN).....	12
FILTERS/ATTENUATORS.....	13
ANTENNAS.....	13
ANTENNA MAST AND EQUIPMENT TURNTABLE.....	13
INSTRUMENT CALIBRATION.....	13
TEST PROCEDURES	14
EUT AND CABLE PLACEMENT.....	14
CONDUCTED EMISSIONS.....	14
RADIATED EMISSIONS.....	14
RADIATED EMISSIONS.....	15
BANDWIDTH MEASUREMENTS.....	17
SPECIFICATION LIMITS AND SAMPLE CALCULATIONS.....	18
CONDUCTED EMISSIONS SPECIFICATION LIMITS: FCC 15.207; FCC 15.107(A), RSS GEN.....	18
GENERAL TRANSMITTER RADIATED EMISSIONS SPECIFICATION LIMITS.....	19
RECEIVER RADIATED SPURIOUS EMISSIONS SPECIFICATION LIMITS.....	19
OUTPUT POWER LIMITS – DIGITAL TRANSMISSION SYSTEMS.....	20
TRANSMIT MODE SPURIOUS RADIATED EMISSIONS LIMITS – FHSS AND DTS SYSTEMS.....	20
SAMPLE CALCULATIONS - CONDUCTED EMISSIONS.....	20
SAMPLE CALCULATIONS - RADIATED EMISSIONS.....	21
APPENDIX A TEST EQUIPMENT CALIBRATION DATA	1
APPENDIX B TEST DATA	2

SCOPE

An electromagnetic emissions test has been performed on the Intel Corporation model Intel® Centrino® Advanced-N 6205, pursuant to the following rules:

Industry Canada RSS-Gen Issue 2

RSS 210 Issue 7 “Low-power Licence-exempt Radiocommunication Devices (All Frequency Bands): Category I Equipment”

FCC Part 15 Subpart C

Conducted and radiated emissions data has been collected, reduced, and analyzed within this report in accordance with measurement guidelines set forth in the following reference standards and as outlined in Elliott Laboratories test procedures:

ANSI C63.4:2003

FCC DTS Measurement Procedure KDB558074, March 2005

The intentional radiator above has been tested in a simulated typical installation to demonstrate compliance with the relevant Industry Canada performance and procedural standards.

Final system data was gathered in a mode that tended to maximize emissions by varying orientation of EUT, orientation of power and I/O cabling, antenna search height, and antenna polarization.

Every practical effort was made to perform an impartial test using appropriate test equipment of known calibration. All pertinent factors have been applied to reach the determination of compliance.

OBJECTIVE

The primary objective of the manufacturer is compliance with the regulations outlined in the previous section.

Prior to marketing in the USA, all unlicensed transmitters and transceivers require certification. Receive-only devices operating between 30 MHz and 960 MHz are subject to either certification or a manufacturer’s declaration of conformity, with all other receive-only devices exempt from the technical requirements.

Prior to marketing in Canada, Class I transmitters, receivers and transceivers require certification. Class II devices are required to meet the appropriate technical requirements but are exempt from certification requirements.

Certification is a procedure where the manufacturer submits test data and technical information to a certification body and receives a certificate or grant of equipment authorization upon successful completion of the certification body’s review of the submitted documents. Once the equipment authorization has been obtained, the label indicating compliance must be attached to all identical units, which are subsequently manufactured.

Maintenance of compliance is the responsibility of the manufacturer. Any modification of the product which may result in increased emissions should be checked to ensure compliance has been maintained (i.e., printed circuit board layout changes, different line filter, different power supply, harnessing or I/O cable changes, etc.).

STATEMENT OF COMPLIANCE

The tested sample of Intel Corporation model Intel® Centrino® Advanced-N 6205 complied with the requirements of the following regulations:

Industry Canada RSS-Gen Issue 2
RSS 210 Issue 7 “Low-power Licence-exempt Radiocommunication Devices (All Frequency Bands): Category I Equipment”
FCC Part 15 Subpart C

Maintenance of compliance is the responsibility of the manufacturer. Any modifications to the product should be assessed to determine their potential impact on the compliance status of the device with respect to the standards detailed in this test report.

The test results recorded herein are based on a single type test of Intel Corporation model Intel® Centrino® Advanced-N 6205 and therefore apply only to the tested sample. The sample was selected and prepared by Steve Hackett of Intel Corporation.

DEVIATIONS FROM THE STANDARDS

No deviations were made from the published requirements listed in the scope of this report.

TEST RESULTS SUMMARY**DIGITAL TRANSMISSION SYSTEMS (2400 – 2483.5MHz)**

FCC Rule Part	RSS Rule Part	Description	Measured Value / Comments	Limit / Requirement	Result (margin)
15.247(a)	RSS 210 A8.2	Digital Modulation	Systems uses OFDM / DSSS techniques	System must utilize digital transmission technology	Complies
15.247 (a) (2)	RSS 210 A8.2 (1)	6dB Bandwidth	> 10.33 MHz	>500kHz	Complies
15.247 (b) (3)	RSS 210 A8.2 (4)	Output Power (multipoint systems)	802.11b: 17.1dBm 802.11g: 20.7dBm n 20MHz: 15.6dBm n 40MHz: 15.2dBm EIRP = 0.248 W ^{Note 1}	1Watt, EIRP limited to 4 Watts.	Complies
15.247(d)	RSS 210 A8.2 (2)	Power Spectral Density	-7.5 dBm / 3kHz	8dBm/3kHz	Complies
15.247(c)	RSS 210 A8.5	Antenna Port Spurious Emissions 30MHz – 25 GHz	802.11bg modes < -20dBc 802.11n modes < -30dBc	< -20dBc < -30dBc ^{Note 2}	Complies
15.247(c) / 15.209	RSS 210 A8.5	Radiated Spurious Emissions 30MHz – 25 GHz	53.3dBμV/m @ 2389.9MHz	15.207 in restricted bands, all others < -30dBc ^{Note 2}	Complies (-0.7dB)
Note 1: EIRP calculated using antenna gain of 3.2 dBi for the highest EIRP system.					
Note 2: Limit of -30dBc used because the power for the 802.11n modes was measured using the UNII test procedure (maximum power averaged over a transmission burst).					

DIGITAL TRANSMISSION SYSTEMS (5725 –5850 MHz)

FCC Rule Part	RSS Rule Part	Description	Measured Value / Comments	Limit / Requirement	Result
15.247(a)	RSS 210 A8.2	Digital Modulation	Systems uses OFDM / DSSS techniques	System must utilize digital transmission technology	Complies
15.247 (a) (2)	RSS 210 A8.2 (1)	6dB Bandwidth		>500kHz	Complies
15.247 (b)	RSS 210 A8.2 (4)	Output Power (multipoint systems)	802.11a: 15.6dBm n 20MHz: 15.6dBm n 40MHz: 20.8dBm EIRP = 0.380 W ^{Note 1}	1Watt, EIRP limited to 4 Watts.	Complies
15.247(d)	RSS 210 A8.2 (2)	Power Spectral Density	-8.5 dBm / 3kHz	Maximum permitted is 8dBm/3kHz	Complies
15.247(c)	RSS 210 A8.5	Antenna Port Spurious Emissions – 30MHz – 40 GHz	802.11n 40MHz < -20dBc n20 and 802.11a < -30dBc	< -20dBc < -30dBc ^{Note 2}	Complies
15.247(c) / 15.209	RSS 210 A8.5 Table 2, 3	Radiated Spurious Emissions 30MHz – 40 GHz	47.1dBμV/m @ 11649.9MHz	15.207 in restricted bands, all others < -30dBc ^{Note 2}	Complies (-6.9dB)
Note 1: EIRP calculated using antenna gain of 5 dBi.					
Note 2: Limit of -30dBc used because the power for one or more modes was measured using the UNII test procedure (maximum power averaged over a transmission burst).					

GENERAL REQUIREMENTS APPLICABLE TO ALL BANDS

FCC Rule Part	RSS Rule part	Description	Measured Value / Comments	Limit / Requirement	Result (margin)
15.203	-	RF Connector	Non standard and typically integral to host system	Unique or integral	Complies
15.109	RSS GEN 7.2.3 Table 1	Receiver spurious emissions	34.9dB μ V/m @ 199.83MHz	Refer to page 19	Complies (-8.6dB)
15.207	RSS GEN Table 2	AC Conducted Emissions	33.2dB μ V @ 13.426MHz	Refer to page 18	Complies (-16.8dB)
15.247 (b) (5) 15.407 (f)	RSS 102	RF Exposure Requirements	Refer to MPE calculations, RSS 102 declaration and User Manual (page 8).	Refer to OET 65, FCC Part 1 and RSS 102	Complies
-	RSP 100 RSS GEN 7.1.5	User Manual	User Manual (page 11).	Statement required regarding non-interference	Complies
-	RSP 100 RSS GEN 7.1.5	User Manual	Antenna is intended to be integrated into the host system.	Statement for products with detachable antenna	N/A
-	RSP 100 RSS GEN 4.4.1	99% Bandwidth	802.11b: 15.4MHz 802.11a/g: 17.0MHz n 20MHz: 18.4 MHz n 40MHz 36.9MHz:	Information only	N/A

MEASUREMENT UNCERTAINTIES

ISO/IEC 17025 requires that an estimate of the measurement uncertainties associated with the emissions test results be included in the report. The measurement uncertainties given below are based on a 95% confidence level and were calculated in accordance with UKAS document LAB 34.

Measurement Type	Measurement Unit	Frequency Range	Expanded Uncertainty
RF power, conducted (power meter)	dBm	25 to 7000 MHz	± 0.52 dB
RF power, conducted (Spectrum analyzer)	dBm	25 to 7000 MHz	± 0.7 dB
Conducted emission of transmitter	dBm	25 to 26500 MHz	± 0.7 dB
Conducted emission of receiver	dBm	25 to 26500 MHz	± 0.7 dB
Radiated emission (substitution method)	dBm	25 to 26500 MHz	± 2.5 dB
Radiated emission (field strength)	dB μ V/m	25 to 1000 MHz	± 3.6 dB
		1000 to 40000 MHz	± 6.0 dB
Conducted Emissions (AC Power)	dB μ V	0.15 to 30 MHz	± 2.4 dB

EQUIPMENT UNDER TEST (EUT) DETAILS**GENERAL**

The Intel Corporation model Intel® Centrino® Advanced-N 6205 is a PCIe Half Mini Card form factor IEEE 802.11a/b/g/n wireless network adapter that operates in both the 2.4 GHz and 5.0 GHz spectra. The card supports 2x2 MIMO for 802.11n modes in both 20MHz and 40MHz channels. In legacy modes 1x2 operation is supported.

For radio testing purposes the card was installed in a test fixture that exposed all sides of the card.

The card is being certified with both full modular approval and limited modular approval. The two versions are electrically identical using the same hardware. The full modular version is intended for factory installation only by the oem (FCC ID:PD962205ANH; IC:1000M-62205ANH). The limited modular version is intended to allow the oem to permit user installation when the host system is provided with a bios locking feature that prevents unauthorized installation (FCC ID:PD962205ANHU; IC:1000M-62205ANHU). All versions are approved under Intel model 62205ANHMW with the exception of the limited modular approval for Canada which is approved as model 62205ANHU (see table below).

The samples were received on August 2, 2010 and tested on August 2, 3, 4, 5, 6, 9, 10, 12, 13, 26 and 27, 2010. The first sample was tested from August 6 through to August 9, 2010. The second sample was used for all subsequent tests due to the rf connector on the first sample breaking. The EUT consisted of the following component(s):

Manufacturer	Model	Description	MAC address	FCC ID / IC UPN
Intel Corporation	62205ANHMW	PCIe Half Mini Card 802.11a/b/g/n wireless network adapter	Sample #1: 001500633B2C	PD962205ANH PD962205ANHU 1000M-622ANH
	62205ANHU		Sample #2: 001500633B14	1000M- 62205ANHU

OTHER EUT DETAILS

The EUT antenna system consists of two PIFA antennas manufactured by the Shanghai Universe Communication Electron Co., Ltd.. The antenna connects to the EUT via a non-standard antenna connector, thereby meeting the requirements of FCC 15.203. Further the antenna connectors are typically located inside the host PC without access to the end user. Where the end user can install the module the systems are protected by a BiOS Lock mechanism to ensure the card is only used with the approved antennas in the approved host systems.

ENCLOSURE

The EUT does not have an enclosure as it is designed to be installed within the enclosure of a host computer or system.

MODIFICATIONS

No modifications were made to the EUT during the time the product was at Elliott.

SUPPORT EQUIPMENT

The following equipment was used as local support equipment for emissions testing:

Company	Model	Description	Serial Number	FCC ID
Intel	-	test fixture	-	-
Dell	prototype	Laptop	-	-

INTERFACE PORTS

The I/O cabling configuration during emissions testing was as follows:

Port		Description	Cable(s)	
From	To		Shielded/Unshielded	Length(m)
Fixture PCIe	Laptop PCIe	Ribbon	Shielded	1
Fixture USB	Laptop USB	-	Shielded	2
Fixture DC Power	DC Power Supply	-	Unshielded	1

EUT OPERATION

The EUT was installed into a test fixture that exposed all sides of the card. The test fixture interfaced to a laptop computer and dc power supply. The laptop computer was used to configure the EUT to continuously transmit at a specified output power or continuously receive on the channel specified in the test data. For transmit mode measurements the system was configured to operate in each of the available operating modes – 802.11b, 802.11g, 802.11a, 802.11n (20 MHz channel bandwidth) and 802.11n (40MHz channel bandwidth).

Legacy modes (SISO-only) were evaluated on each chain individually. The 802.11n modes were evaluated operating on each chain separately (SISO) and on both chains simultaneously (MIMO). Spurious measurements, other than band-edge measurements, were only performed on 802.11n modes with both chains transmitting simultaneously. For those tests the output power per chain was set to the higher single-chain power level to cover both SISO and MIMO operation.

The data rates used for all tests were the lowest data rates for each mode – 1Mb/s for 802.11b, 6Mb/s for 802.11a and 802.11g, 6.5MB/s for 802.11n (20MHz), and 13 Mb/s for 802.11n (40MHz). The device operates at its maximum output power at the lowest data rate (this was confirmed through separate measurements – refer to test data for actual measurements).

The PC was using the Intel test utility DRTU Version 1.1.3 and the device driver was version 13.0.0.238.

TEST SITE**GENERAL INFORMATION**

Final test measurements were taken at the test sites listed below. Pursuant to section 2.948 of the FCC's Rules and section 3.3 of RSP-100, construction, calibration, and equipment data has been filed with the Commission and with industry Canada.

Site	Registration Numbers		Location
	FCC	Canada	
Chamber 3	769238	2845B-3	41039 Boyce Road Fremont, CA 94538-2435
Chamber 4	211948	2845B-4	
Chamber 5	211948	2845B-5	

ANSI C63.4:2003 recommends that ambient noise at the test site be at least 6 dB below the allowable limits. Ambient levels are below this requirement. The test site(s) contain separate areas for radiated and conducted emissions testing. Considerable engineering effort has been expended to ensure that the facilities conform to all pertinent requirements of ANSI C63.4:2003.

CONDUCTED EMISSIONS CONSIDERATIONS

Conducted emissions testing is performed in conformance with ANSI C63.4:2003. Measurements are made with the EUT connected to the public power network through a nominal, standardized RF impedance, which is provided by a line impedance stabilization network, known as a LISN. A LISN is inserted in series with each current-carrying conductor in the EUT power cord.

RADIATED EMISSIONS CONSIDERATIONS

The FCC has determined that radiation measurements made in a shielded enclosure are not suitable for determining levels of radiated emissions. Radiated measurements are performed in an open field environment or in a semi-anechoic chamber. The test sites are maintained free of conductive objects within the CISPR defined elliptical area incorporated in ANSI C63.4:2003 guidelines and meet the Normalized Site Attenuation (NSA) requirements of ANSI C63.4:2003.

MEASUREMENT INSTRUMENTATION

RECEIVER SYSTEM

An EMI receiver as specified in CISPR 16-1-1 is used for emissions measurements. The receivers used can measure over the frequency range of 9 kHz up to 2000 MHz. These receivers allow both ease of measurement and high accuracy to be achieved. The receivers have Peak, Average, and CISPR (Quasi-peak) detectors built into their design so no external adapters are necessary. The receiver automatically sets the required bandwidth for the CISPR detector used during measurements. If the repetition frequency of the signal being measured is below 20Hz, peak measurements are made in lieu of Quasi-Peak measurements.

For measurements above the frequency range of the receivers, a spectrum analyzer is utilized because it provides visibility of the entire spectrum along with the precision and versatility required to support engineering analysis. Average measurements above 1000MHz are performed on the spectrum analyzer using the linear-average method with a resolution bandwidth of 1 MHz and a video bandwidth of 10 Hz, unless the signal is pulsed in which case the average (or video) bandwidth of the measuring instrument is reduced to onset of pulse desensitization and then increased.

INSTRUMENT CONTROL COMPUTER

The receivers utilize either a Rohde & Schwarz EZM Spectrum Monitor/Controller or contain an internal Spectrum Monitor/Controller to view and convert the receiver measurements to the field strength at an antenna or voltage developed at the LISN measurement port, which is then compared directly with the appropriate specification limit. This provides faster, more accurate readings by performing the conversions described under Sample Calculations within the Test Procedures section of this report. Results are printed in a graphic and/or tabular format, as appropriate. A personal computer is used to record all measurements made with the receivers.

The Spectrum Monitor provides a visual display of the signal being measured. In addition, the controller or a personal computer run automated data collection programs which control the receivers. This provides added accuracy since all site correction factors, such as cable loss and antenna factors are added automatically.

LINE IMPEDANCE STABILIZATION NETWORK (LISN)

Line conducted measurements utilize a fifty microhenry Line Impedance Stabilization Network as the monitoring point. The LISN used also contains a 250 uH CISPR adapter. This network provides for calibrated radio frequency noise measurements by the design of the internal low pass and high pass filters on the EUT and measurement ports, respectively.

FILTERS/ATTENUATORS

External filters and precision attenuators are often connected between the receiving antenna or LISN and the receiver. This eliminates saturation effects and non-linear operation due to high amplitude transient events.

ANTENNAS

A loop antenna is used below 30 MHz. For the measurement range 30 MHz to 1000 MHz either a combination of a biconical antenna and a log periodic or a bi-log antenna is used. Above 1000 MHz, horn antennas are used. The antenna calibration factors to convert the received voltage to an electric field strength are included with appropriate cable loss and amplifier gain factors to determine an overall site factor, which is then programmed into the test receivers or incorporated into the test software.

ANTENNA MAST AND EQUIPMENT TURNTABLE

The antennas used to measure the radiated electric field strength are mounted on a non-conductive antenna mast equipped with a motor-drive to vary the antenna height. Measurements below 30 MHz are made with the loop antenna at a fixed height of 1m above the ground plane.

ANSI C63.4:2003 specifies that the test height above ground for table mounted devices shall be 80 centimeters. Floor mounted equipment shall be placed on the ground plane if the device is normally used on a conductive floor or separated from the ground plane by insulating material from 3 to 12 mm if the device is normally used on a non-conductive floor. During radiated measurements, the EUT is positioned on a motorized turntable in conformance with this requirement.

INSTRUMENT CALIBRATION

All test equipment is regularly checked to ensure that performance is maintained in accordance with the manufacturer's specifications. All antennas are calibrated at regular intervals with respect to tuned half-wave dipoles. An exhibit of this report contains the list of test equipment used and calibration information.

TEST PROCEDURES

EUT AND CABLE PLACEMENT

The regulations require that interconnecting cables be connected to the available ports of the unit and that the placement of the unit and the attached cables simulate the worst case orientation that can be expected from a typical installation, so far as practicable. To this end, the position of the unit and associated cabling is varied within the guidelines of ANSI C63.4:2003, and the worst-case orientation is used for final measurements.

CONDUCTED EMISSIONS

Conducted emissions are measured at the plug end of the power cord supplied with the EUT. Excess power cord length is wrapped in a bundle between 30 and 40 centimeters in length near the center of the cord. Preliminary measurements are made to determine the highest amplitude emission relative to the specification limit for all the modes of operation. Placement of system components and varying of cable positions are performed in each mode. A final peak mode scan is then performed in the position and mode for which the highest emission was noted on all current carrying conductors of the power cord.

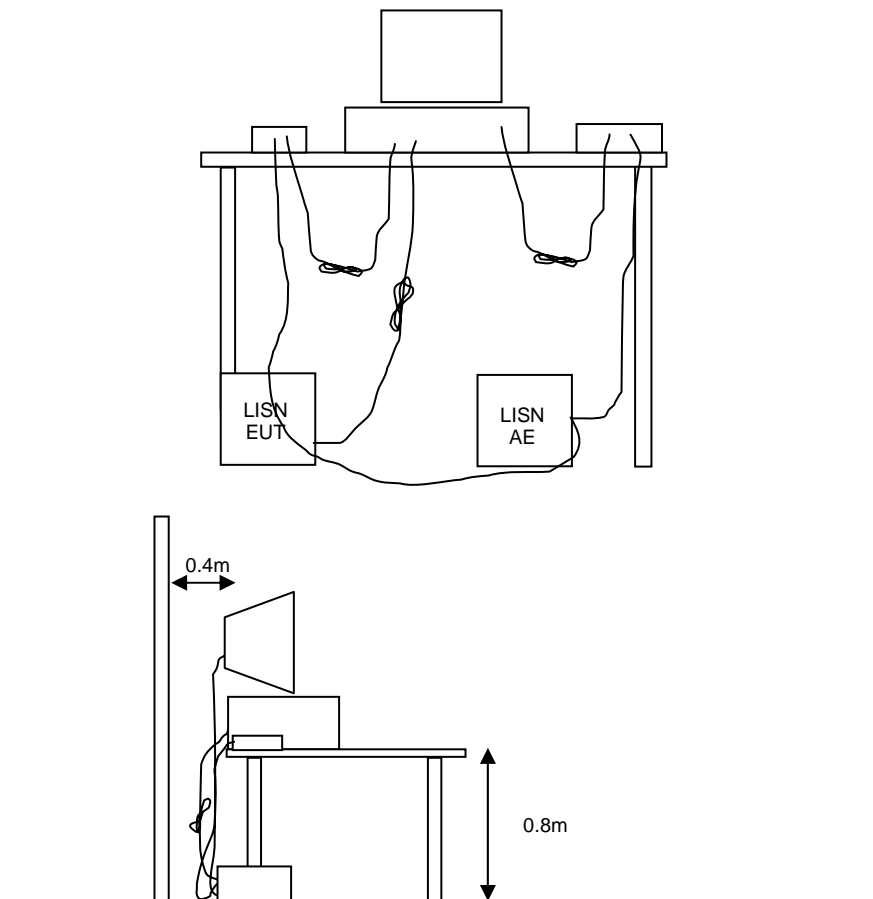

RADIATED EMISSIONS

A preliminary scan of the radiated emissions is performed in which all significant EUT frequencies are identified with the system in a nominal configuration. At least two scans are performed, one scan for each antenna polarization (horizontal and vertical; loop parallel and perpendicular to the EUT). During the preliminary scans, the EUT is rotated through 360°, the antenna height is varied (for measurements above 30 MHz) and cable positions are varied to determine the highest emission relative to the limit. Preliminary scans may be performed in a fully anechoic chamber for the purposes of identifying the frequencies of the highest emissions from the EUT.

A speaker is provided in the receiver to aid in discriminating between EUT and ambient emissions. Other methods used during the preliminary scan for EUT emissions involve scanning with near field magnetic loops, monitoring I/O cables with RF current clamps, and cycling power to the EUT.

Final maximization is a phase in which the highest amplitude emissions identified in the spectral search are viewed while the EUT azimuth angle is varied from 0 to 360 degrees relative to the receiving antenna. The azimuth, which results in the highest emission is then maintained while varying the antenna height from one to four meters (for measurements above 30 MHz, measurements below 30 MHz are made with the loop antenna at a fixed height of 1m). The result is the identification of the highest amplitude for each of the highest peaks. Each recorded level is corrected in the receiver using appropriate factors for cables, connectors, antennas, and preamplifier gain.

When testing above 18 GHz, the receive antenna is located at 1 meter from the EUT and the antenna height is restricted to a maximum of 2.5 meters.

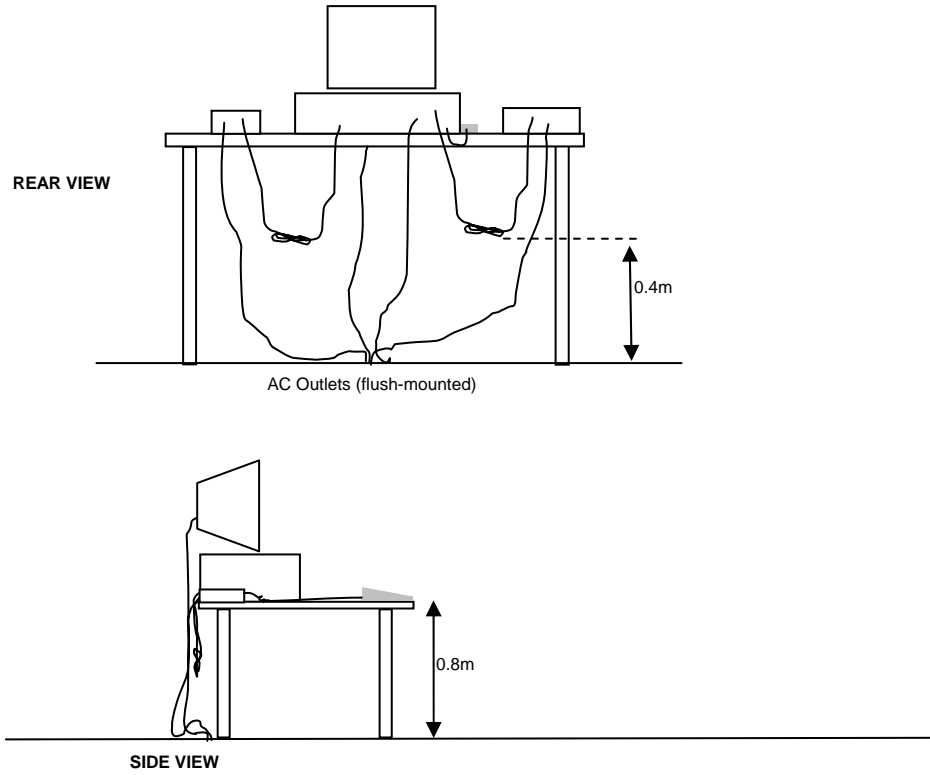

Typical Test Configuration for Radiated Field Strength Measurements

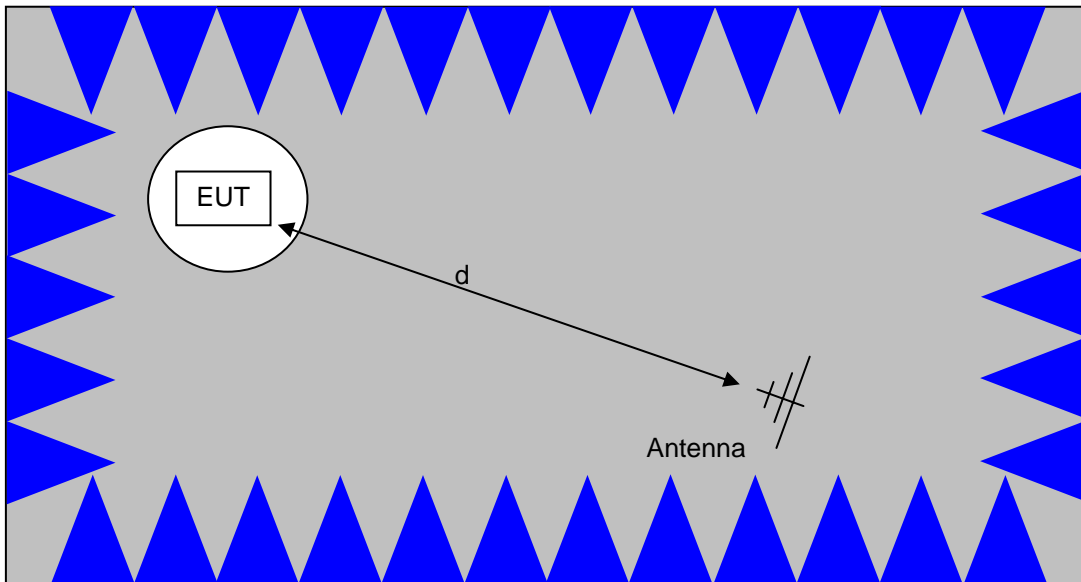

The anechoic materials on the walls and ceiling ensure compliance with the normalized site attenuation requirements of CISPR 16 / CISPR 22 / ANSI C63.4 for an alternate test site at the measurement distances used.

Floor-standing equipment is placed on the floor with insulating supports between the unit and the ground plane.

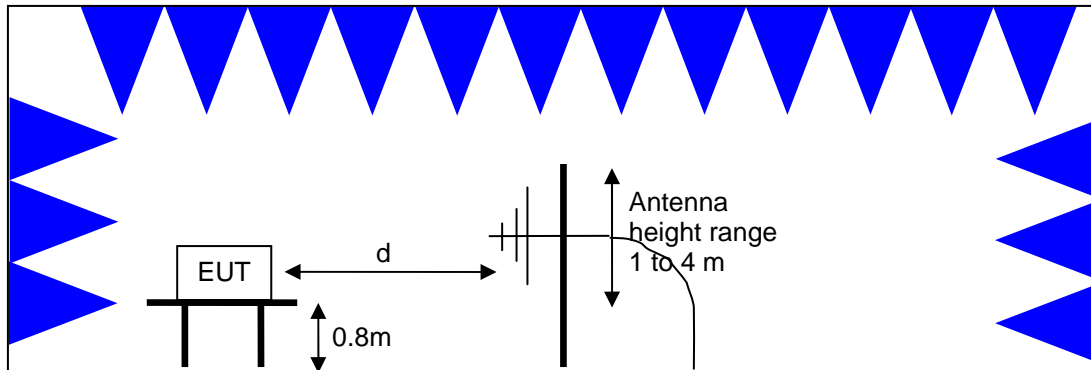

Test Configuration for Radiated Field Strength Measurements
Semi-Anechoic Chamber, Plan and Side Views

BANDWIDTH MEASUREMENTS

The 6dB, 20dB and/or 26dB signal bandwidth is measured in using the bandwidths recommended by ANSI C63.4. When required, the 99% bandwidth is measured using the methods detailed in RSS GEN.

SPECIFICATION LIMITS AND SAMPLE CALCULATIONS

The limits for conducted emissions are given in units of microvolts, and the limits for radiated emissions are given in units of microvolts per meter at a specified test distance. Data is measured in the logarithmic form of decibels relative to one microvolt, or dB microvolts (dBuV). For radiated emissions, the measured data is converted to the field strength at the antenna in dB microvolts per meter (dBuV/m). The results are then converted to the linear forms of uV and uV/m for comparison to published specifications.

For reference, converting the specification limits from linear to decibel form is accomplished by taking the base ten logarithm, then multiplying by 20. These limits in both linear and logarithmic form are as follows:

CONDUCTED EMISSIONS SPECIFICATION LIMITS: FCC 15.207; FCC 15.107(a), RSS GEN

The table below shows the limits for the emissions on the AC power line from an intentional radiator and a receiver.

Frequency (MHz)	Average Limit (dBuV)	Quasi Peak Limit (dBuV)
0.150 to 0.500	Linear decrease on logarithmic frequency axis between 56.0 and 46.0	Linear decrease on logarithmic frequency axis between 66.0 and 56.0
0.500 to 5.000	46.0	56.0
5.000 to 30.000	50.0	60.0

GENERAL TRANSMITTER RADIATED EMISSIONS SPECIFICATION LIMITS

The table below shows the limits for the spurious emissions from transmitters that fall in restricted bands¹ (with the exception of transmitters operating under FCC Part 15 Subpart D and RSS 210 Annex 9), the limits for all emissions from a low power device operating under the general rules of RSS 310 (tables 3 and 4), RSS 210 (table 2) and FCC Part 15 Subpart C section 15.209.

Frequency Range (MHz)	Limit (uV/m)	Limit (dBuV/m @ 3m)
0.009-0.490	2400/F _{KHz} @ 300m	67.6-20*log ₁₀ (F _{KHz}) @ 300m
0.490-1.705	24000/F _{KHz} @ 30m	87.6-20*log ₁₀ (F _{KHz}) @ 30m
1.705 to 30	30 @ 30m	29.5 @ 30m
30 to 88	100 @ 3m	40 @ 3m
88 to 216	150 @ 3m	43.5 @ 3m
216 to 960	200 @ 3m	46.0 @ 3m
Above 960	500 @ 3m	54.0 @ 3m

RECEIVER RADIATED SPURIOUS EMISSIONS SPECIFICATION LIMITS

The table below shows the limits for the spurious emissions from receivers as detailed in FCC Part 15.109, RSS 210 Table 2, RSS GEN Table 1 and RSS 310 Table 3. Note that receivers operating outside of the frequency range 30 MHz – 960 MHz are exempt from the requirements of 15.109.

Frequency Range (MHz)	Limit (uV/m @ 3m)	Limit (dBuV/m @ 3m)
30 to 88	100	40
88 to 216	150	43.5
216 to 960	200	46.0
Above 960	500	54.0

¹ The restricted bands are detailed in FCC 15.203, RSS 210 Table 1 and RSS 310 Table 2

OUTPUT POWER LIMITS – DIGITAL TRANSMISSION SYSTEMS

The table below shows the limits for output power and output power density. Where the signal bandwidth is less than 20 MHz the maximum output power is reduced to the power spectral density limit plus 10 times the log of the bandwidth (in MHz).

Operating Frequency (MHz)	Output Power	Power Spectral Density
902 – 928	1 Watt (30 dBm)	8 dBm/3kHz
2400 – 2483.5	1 Watt (30 dBm)	8 dBm/3kHz
5725 – 5850	1 Watt (30 dBm)	8 dBm/3kHz

The maximum permitted output power is reduced by 1dB for every dB the antenna gain exceeds 6dBi. Fixed point-to-point applications using the 5725 – 5850 MHz band are not subject to this restriction.

TRANSMIT MODE SPURIOUS RADIATED EMISSIONS LIMITS – FHSS and DTS SYSTEMS

The limits for unwanted (spurious) emissions from the transmitter falling in the restricted bands are those specified in the general limits sections of FCC Part 15 and RSS 210. All other unwanted (spurious) emissions shall be at least 20dB below the level of the highest in-band signal level (30dB if the power is measured using the sample detector/power averaging method).

SAMPLE CALCULATIONS - CONDUCTED EMISSIONS

Receiver readings are compared directly to the conducted emissions specification limit (decibel form) as follows:

$$R_r - S = M$$

where:

R_r = Receiver Reading in dBuV

S = Specification Limit in dBuV

M = Margin to Specification in +/- dB

SAMPLE CALCULATIONS - RADIATED EMISSIONS

Receiver readings are compared directly to the specification limit (decibel form). The receiver internally corrects for cable loss, preamplifier gain, and antenna factor. The calculations are in the reverse direction of the actual signal flow, thus cable loss is added and the amplifier gain is subtracted. The Antenna Factor converts the voltage at the antenna coaxial connector to the field strength at the antenna elements.

A distance factor, when used for electric field measurements above 30MHz, is calculated by using the following formula:

$$F_d = 20 * \text{LOG}_{10} (D_m/D_s)$$

where:

$$F_d = \text{Distance Factor in dB}$$

$$D_m = \text{Measurement Distance in meters}$$

$$D_s = \text{Specification Distance in meters}$$

For electric field measurements below 30MHz the extrapolation factor is either determined by making measurements at multiple distances or a theoretical value is calculated using the formula:

$$F_d = 40 * \text{LOG}_{10} (D_m/D_s)$$

Measurement Distance is the distance at which the measurements were taken and Specification Distance is the distance at which the specification limits are based. The antenna factor converts the voltage at the antenna coaxial connector to the field strength at the antenna elements.

The margin of a given emission peak relative to the limit is calculated as follows:

$$R_c = R_r + F_d$$

and

$$M = R_c - L_s$$

where:

$$R_r = \text{Receiver Reading in dBuV/m}$$

$$F_d = \text{Distance Factor in dB}$$

$$R_c = \text{Corrected Reading in dBuV/m}$$

$$L_s = \text{Specification Limit in dBuV/m}$$

$$M = \text{Margin in dB Relative to Spec}$$

Appendix A Test Equipment Calibration Data**Radiated Spurious Emissions, 1 – 40GHz**

<u>Manufacturer</u>	<u>Description</u>	<u>Model</u>	<u>Asset #</u>	<u>Cal Due</u>
EMCO	Antenna, Horn, 1-18 GHz	3115	487	7/6/2012
Rohde & Schwarz	Power Meter, Single Channel	NRVS	1290	10/22/2010
Hewlett Packard	SpecAn 9 kHz - 40 GHz, FT (SA40) Blue	8564E (84125C)	1393	4/14/2011
Rohde & Schwarz	Power Sensor 100 uW - 10 Watts	NRV-Z53	1555	2/5/2011
Rohde & Schwarz	Attenuator, 20 dB , 50 ohm, 10W, DC-18 GHz	20dB, 10W, Type N	1556	2/5/2011
Rohde & Schwarz	Power Sensor, 1 uW-100 mW, DC-18 GHz, 50ohms	NRV-Z51	1070	5/17/2011
Rohde & Schwarz	Power Meter, Dual Channel	NRVD	1071	6/1/2011
EMCO	Antenna, Horn, 1-18 GHz	3115	1561	6/22/2012
Micro-Tronics	Band Reject Filter, 5725-5875 MHz	BRC50705-02	1728	2/1/2011
Micro-Tronics	Band Reject Filter, 2400-2500 MHz	BRM50702-02	1731	11/4/2010
Hewlett Packard	Head (Inc W1-W4, 1946, 1947) Purple	84125C	1772	5/6/2011
A.H. Systems	Blue System Horn, 18-40GHz	SAS-574, p/n: 2581	2159	3/18/2011

Antenna Port Conducted

<u>Manufacturer</u>	<u>Description</u>	<u>Model</u>	<u>Asset #</u>	<u>Cal Due</u>
Rohde & Schwarz	Power Meter, Single Channel	NRVS	1290	10/22/2010
Hewlett Packard	SpecAn 9 kHz - 40 GHz, FT (SA40) Blue	8564E (84125C)	1393	4/14/2011
Rohde & Schwarz	Power Sensor 100 uW - 2 Watts (w/ 20 dB pad, SN BJ5155)	NRV-Z32	1536	9/2/2010
Rohde & Schwarz	Power Sensor, 1 uW-100 mW, DC-18 GHz, 50ohms	NRV-Z51	1070	5/17/2011
Rohde & Schwarz	Power Meter, Dual Channel	NRVD	1071	6/1/2011

Radiated Emissions, 30 - 1,000 MHz and Conducted Emissions, 13-Aug-10

<u>Manufacturer</u>	<u>Description</u>	<u>Model</u>	<u>Asset #</u>	<u>Cal Due</u>
Solar Electronics	LISN	8028-50-TS-24-BNC support	904	3/2/2011
Rohde & Schwarz	Pulse Limiter	ESH3 Z2	1401	4/20/2011
Com-Power Corp.	Preamplifier, 30-1000 MHz	PA-103	1632	4/23/2011
Sunol Sciences	Biconilog, 30-3000 MHz	JB3	1657	5/28/2012
Rohde & Schwarz	EMI Test Receiver, 20 Hz-7 GHz	ESIB7	1756	3/16/2011
Fischer Custom Comm	LISN, 25A, 150kHz to 30MHz, 25 Amp,	FCC-LISN-50-25-2-09	2001	10/21/2010

Appendix B Test Data

T80123 166 Pages



EMC Test Data

Client:	Intel Corporation	Job Number:	J80050
Model:	62205ANHMW (Intel® Centrino® Advanced-N 6205)	T-Log Number:	T80123
		Account Manager:	Christine Krebil
Contact:	Steven Hackett		-
Emissions Standard(s):	FCC 15.247 / FCC 15 E / RSS 210 / FCC 15 B	Class:	B
Immunity Standard(s):	-	Environment:	Radio

EMC Test Data

For The

Intel Corporation

Model

62205ANHMW (Intel® Centrino® Advanced-N 6205)

Date of Last Test: 8/26/2010

In normal operating modes the card uses power settings stored on EEPROM to set the output power. For a given nominal output power the actual transmit power is reduced as the data rate increases, therefore testing was performed at the lowest data rate in each mode as this data rate to determine compliance with the requirements at the highest power setting.

The following power measurements were made using an average power meter and the with the device configured in a continuous transmit mode on Chain A at the various data rates in each mode to verify this:

Mode	Data Rate	Power
802.11b	1	13.7
	2	13.7
	5.5	13.4
	11	13.4
802.11g (802.11a)	6	15.1
	9	14.8
	12	14.7
	18	14.7
	24	14.5
	36	14.6
	48	13.3
	54	11.2
802.11n 20MHz	6.5	14.9
	13	14.8
	19.5	14.5
	26	14.4
	39	14.2
	52	13.4
	58.5	10.7
	65	9.2
802.11n 40MHz	13.5	14.9
	27	14.8
	40.5	14.8
	54	14.7
	81	14.5
	108	13.5
	121.5	10.8
	135	9.2

Client:	Intel Corporation	Job Number:	J80050
Model:	62205ANHMW (Intel® Centrino® Advanced-N 6205)	T-Log Number:	T80123
Contact:	Steven Hackett	Account Manager:	Christine Krebil
Standard:	FCC 15.247 / FCC 15 E / RSS 210 / FCC 15 B	Class:	B

Radiated Emissions 30-1000 MHz, Wireless Module (DTS/NII/RSS 210)
(Elliott Laboratories Fremont Facility, Semi-Anechoic Chamber)

Test Specific Details

Objective: The objective of this test session is to perform final qualification testing of the EUT with respect to the specification listed above.

Date of Test: 8/13/2010
Test Engineer: Mark Hill
Test Location: FT #3

Config. Used: Modular Test
Config Change: None
Host Unit Voltage 120V/60Hz

General Test Configuration

The EUT and any local support equipment were located on the turntable for radiated emissions testing. Any remote support equipment was located outside the semi-anechoic chamber. Any cables running to remote support equipment were routed through metal conduit and when possible passed through a ferrite clamp upon exiting the chamber.

The test distance and extrapolation factor (if applicable) are detailed under each run description.

Note, preliminary testing indicates that the emissions were maximized by orientation of the EUT and elevation of the measurement antenna. Maximized testing indicated that the emissions were maximized by orientation of the EUT, elevation of the measurement antenna, and manipulation of the EUT's interface cables.

Ambient Conditions:

Temperature: 22 °C
Rel. Humidity: 37 %

Summary of Results

Run #	Test Performed	Limit	Result	Margin
1	Radiated Emissions 30 - 1000 MHz	FCC 15.209 / RSS 210	Pass	34.9dBµV/m @ 199.83MHz (-8.6dB)

Note - preliminary measurements indicated that the radiated emissions from the combination of test fixture and EUT were not affected by the modules operating frequency or mode (transmit versus receive mode). The system was therefore evaluated against the most stringent set of limits from FCC 15.247, FCC 15E and RSS 210 with the device operating at max power per chain on both chains in 802.11n 20MHz mode at 2437 MHz.

Modifications Made During Testing

No modifications were made to the EUT during testing

Deviations From The Standard

No deviations were made from the requirements of the standard.

Client:	Intel Corporation	Job Number:	J80050
Model:	62205ANHMW (Intel® Centrino® Advanced-N 6205)	T-Log Number:	T80123
Contact:	Steven Hackett	Account Manager:	Christine Krebil
Standard:	FCC 15.247 / FCC 15 E / RSS 210 / FCC 15 B	Class:	B

Run #1: Preliminary Radiated Emissions, 30 - 1000 MHz
Configured to TX at 16.5dBm on each chain (settings 33/31) on channel 6, HT8

Frequency Range	Test Distance	Limit Distance	Extrapolation Factor
30 - 1000 MHz	3	3	0.0

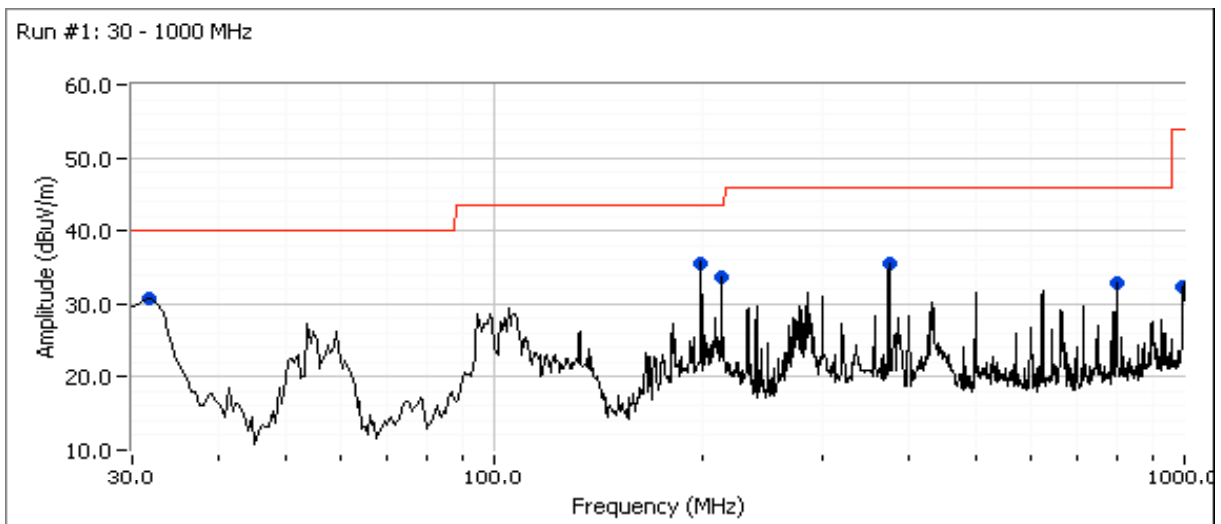

Preliminary peak readings captured during pre-scan

Frequency	Level	Pol	FCC 15.209 / RSS 210		Detector	Azimuth	Height	Comments
MHz	dB μ V/m	v/h	Limit	Margin	Pk/QP/Avg	degrees	meters	
199.830	35.5	H	43.5	-8.0	Peak	232	1.5	
32.144	30.8	V	40.0	-9.2	Peak	83	1.0	
213.950	33.6	H	43.5	-9.9	Peak	262	1.5	
374.346	35.6	H	46.0	-10.4	Peak	283	1.0	
796.607	32.9	H	46.0	-13.1	Peak	171	1.0	
996.867	32.3	H	54.0	-21.7	Peak	238	1.5	

Maximized quasi-peak readings (includes manipulation of EUT interface cables)

Frequency	Level	Pol	FCC 15.209 / RSS 210		Detector	Azimuth	Height	Comments
MHz	dB μ V/m	v/h	Limit	Margin	Pk/QP/Avg	degrees	meters	
199.830	34.9	H	43.5	-8.6	QP	251	1.5	QP (1.00s)
32.144	29.0	V	40.0	-11.0	QP	56	1.0	QP (1.00s)
374.346	33.2	H	46.0	-12.8	QP	259	1.0	QP (1.00s)
213.950	30.1	H	43.5	-13.4	QP	261	1.5	QP (1.00s)
796.607	31.8	H	46.0	-14.2	QP	163	1.0	QP (1.00s)
996.867	28.3	H	54.0	-25.7	QP	231	1.5	QP (1.00s)

Client:	Intel Corporation	Job Number:	J80050
Model:	62205ANHMW (Intel® Centrino® Advanced-N 6205)	T-Log Number:	T80123
Contact:	Steven Hackett	Account Manager:	Christine Krebil
Standard:	FCC 15.247 / FCC 15 E / RSS 210 / FCC 15 B	Class:	N/A

**RSS 210 and FCC 15.247 (DTS) Radiated Emissions
Band Edge Measurements**

Summary of Results

MAC Address: 001500633B2C DRTU Tool Version 1.1.3 Driver version 13.0.0.238 Sample: 1340

Run #	Mode	Channel		Measured Power	Test Performed	Limit	Result / Margin
Run # 1	n 40MHz Chain A	#3 2422MHz	9.0	9.1	Restricted Band Edge at 2400 MHz	15.209	51.2dBµV/m @ 2389.8MHz (-2.8dB)
		#9 2452MHz	9.5	9.6	Restricted Band Edge at 2483.5 MHz	15.209	52.9dBµV/m @ 2483.6MHz (-1.1dB)
Run # 2	n 40MHz Chain A	#4 2427MHz	10.5	10.7	Restricted Band Edge at 2400 MHz	15.209	51.8dBµV/m @ 2390.0MHz (-2.2dB)
		#8 2447MHz	10.5	10.3	Restricted Band Edge at 2483.5 MHz	15.209	52.3dBµV/m @ 2483.5MHz (-1.7dB)
Run # 3	n 40MHz Chain A	#5 2432MHz	12.5	12.4	Restricted Band Edge at 2400 MHz	15.209	50.1dBµV/m @ 2390.0MHz (-3.9dB)
		#7 2442MHz	12.5	12.6	Restricted Band Edge at 2483.5 MHz	15.209	51.8dBµV/m @ 2484.2MHz (-2.2dB)
Run # 4	n 40MHz Chain B	#3 2422MHz	9.5	9.6	Restricted Band Edge at 2400 MHz	15.209	44.3dBµV/m @ 2390.0MHz (-9.7dB)
		#9 2452MHz	10.0	10.2	Restricted Band Edge at 2483.5 MHz	15.209	50.4dBµV/m @ 2483.5MHz (-3.6dB)
Run # 5	n 40MHz Chain B	#4 2427MHz	11.5	11.7	Restricted Band Edge at 2400 MHz	15.209	51.7dBµV/m @ 2390.0MHz (-2.3dB)
		#8 2447MHz	11.5	11.6	Restricted Band Edge at 2483.5 MHz	15.209	51.0dBµV/m @ 2483.5MHz (-3.0dB)
Run # 6	n 40MHz Chain B	#5 2432MHz	13.0	13.0	Restricted Band Edge at 2400 MHz	15.209	48.5dBµV/m @ 2390.0MHz (-5.5dB)
		#7 2442MHz	13.0	13.0	Restricted Band Edge at 2483.5 MHz	15.209	50.5dBµV/m @ 2483.5MHz (-3.5dB)
Run # 7	n 40MHz Chain A+B	#3 2422MHz	A: 6.5 B: 6.5	A: 6.5 B: 6.5	Restricted Band Edge at 2390 MHz	15.209	48.2dBµV/m @ 2390.0MHz (-5.8dB)
		#9 2452MHz	A: 7.0 B: 7.0	A: 7.0 B: 7.0	Restricted Band Edge at 2483.5 MHz	15.209	49.1dBµV/m @ 2484.8MHz (-4.9dB)
Run # 7	n 40MHz Chain A+B	#3 2422MHz	A: 8.0 B: 8.0	A: 8 B: 8	Restricted Band Edge at 2390 MHz	15.209	50.8dBµV/m @ 2390.0MHz (-3.2dB)
		#9 2452MHz	A: 8.5 B: 8.5	A: 8.6 B: 8.6	Restricted Band Edge at 2483.5 MHz	15.209	51.3dBµV/m @ 2484.5MHz (-2.7dB)

Client: Intel Corporation	Job Number: J80050
Model: 62205ANHMW (Intel® Centrino® Advanced-N 6205)	T-Log Number: T80123
	Account Manager: Christine Krebil
Contact: Steven Hackett	
Standard: FCC 15.247 / FCC 15 E / RSS 210 / FCC 15 B	Class: N/A

Run #	Mode	Channel		Measured Power	Test Performed	Limit	Result / Margin
Run # 8	n 40MHz Chain A+B	#4 2427MHz	A: 10.0 B: 10.0	A: 10.3 B: 10.1	Restricted Band Edge at 2390 MHz	15.209	52.0dBμV/m @ 2389.7MHz (-2.0dB)
		#8 2447MHz	A: 10.0 B: 10.0	A: 10.2 B: 10.2	Restricted Band Edge at 2483.5 MHz	15.209	51.7dBμV/m @ 2484.3MHz (-2.3dB)

Note - the measured powers are the average powers (measured with average power sensor) and are used for reference purposes only. Power is set using " GAIN CONTROL" mode in the DRTU tool.

Test Specific Details

Objective: The objective of this test session is to perform engineering evaluation testing of the EUT with respect to the specification listed above.

General Test Configuration

The EUT was installed into a test fixture such that the EUT was exposed (i.e. outside of a host PC). For radiated emissions testing the measurement antenna was located 3 meters from the EUT.

Ambient Conditions:

Rel. Humidity: 15 - 55 %
Temperature: 18 - 25 °C

Modifications Made During Testing

No modifications were made to the EUT during testing

Deviations From The Standard

No deviations were made from the requirements of the standard.

Marker Delta Measurements

Three sets of marker deltas are measured using the following settings: RB=VB=100kHz; RB=1MHz,VB=1MHz; RB=1MHz, VB=10Hz. Marker deltas are made conducted (analyzer connected to EUT rf port via 10dB pad) for single chain operation and radiated (at a distance of ~ 50cm) for MIMO modes. The fundamental field strength is always measured at a 3m test distance.

Client:	Intel Corporation	Job Number:	J80050
Model:	62205ANHMW (Intel® Centrino® Advanced-N 6205)	T-Log Number:	T80123
Contact:	Steven Hackett	Account Manager:	Christine Krebil
Standard:	FCC 15.247 / FCC 15 E / RSS 210 / FCC 15 B	Class:	N/A

Run # 1, Band Edge Field Strength - n 40MHz, Chain A

Date of Test: 8/2/2010

Test Location: Chamber #3

Test Engineer: Suhaila Khushzad & David Bare

Config Change: none

Run # 1a, EUT on Channel #3 2422MHz - n 40MHz, Chain A

	Target (dBm)	Power Settings Measured (dBm)	Software Setting
Chain A	9.0	9.1	20.5

Fundamental Signal Field Strength

Frequency MHz	Level dB μ V/m	Pol v/h	15.209 / 15.247		Detector Pk/QP/Avg	Azimuth degrees	Height meters	Comments
			Limit	Margin				
2434.670	85.8	V	-	-	AVG	186	1.5	RB 1 MHz;VB 10 Hz;Pk
2434.470	94.0	V	-	-	PK	186	1.5	RB 1 MHz;VB 3 MHz;Pk
2414.270	91.0	H	-	-	AVG	245	1.0	RB 1 MHz;VB 10 Hz;Pk
2413.130	98.9	H	-	-	PK	245	1.0	RB 1 MHz;VB 3 MHz;Pk

2390 MHz Band Edge Signal Radiated Field Strength - Marker Delta

	H	V	
Fundamental emission level @ 3m in 1MHz RBW:	98.9	94.0	Peak Measurement (RB=VB=1MHz)
Fundamental emission level @ 3m in 1MHz RBW:	91.0	85.8	Average Measurement (RB=1MHz, VB=10Hz)
<i>Delta Marker - 100kHz</i>	<i>38.5 dB</i>		-< this can only be used if band edge signal is highest within 2MHz of band edge.
Calculated Band-Edge Measurement (Peak):	60.4 dB μ V/m		
Calculated Band-Edge Measurement (Avg):	52.5 dB μ V/m	Margin	Level
<i>Delta Marker - 1MHz/1MHz:</i>	<i>37.3 dB</i>	-2.8	51.2
<i>Delta Marker - 1MHz/10Hz:</i>	<i>39.8 dB</i>	-13.6	60.4
Calculated Band-Edge Measurement (Peak):	61.6 dB μ V/m	Using 100kHz delta value	
Calculated Band-Edge Measurement (Avg):	51.2 dB μ V/m	Using 1MHz delta value	

Frequency MHz	Level dB μ V/m	Pol v/h	FCC 15.209		Detector Pk/QP/Avg	Azimuth degrees	Height meters	Comments
			Limit	Margin				
2389.810	51.2	-	54.0	-2.8	Avg	-	-	Using 1MHz delta value

Client: Intel Corporation	Job Number: J80050
Model: 62205ANHMW (Intel® Centrino® Advanced-N 6205)	T-Log Number: T80123
	Account Manager: Christine Krebil
Contact: Steven Hackett	
Standard: FCC 15.247 / FCC 15 E / RSS 210 / FCC 15 B	Class: N/A

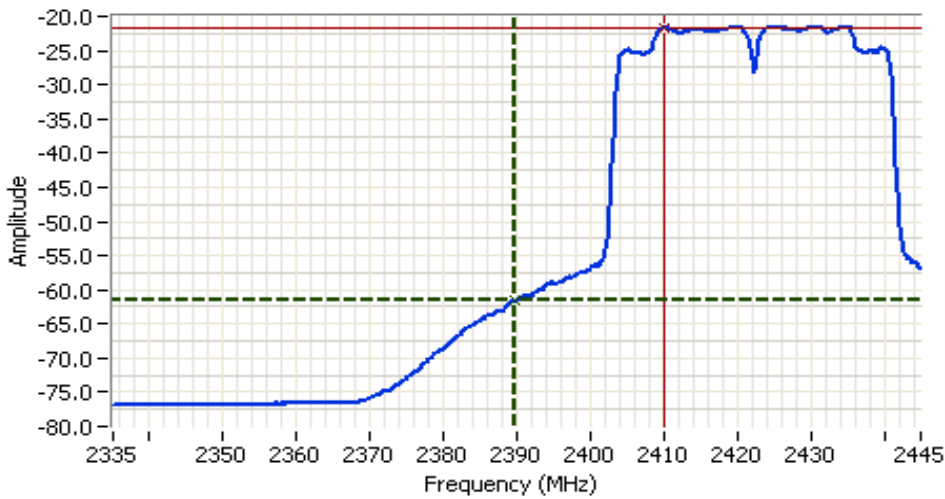

Analyzer Settings

HP8564E,EMI
CF: 2390.000 MHz
SPAN: 110.000 MHz
RB 1.000 MHz
VB 10 Hz
Detector Sample
Att 10
RL Offset 0.00
Sweep Time 41.0s
Ref Lvl: 0.00DBM

Comments

BE @ 2390 MHz
Avg

Cursor 1	2389.8167	-61.50	
Cursor 2	2410.1667	-21.67	

Delta Freq. 20.350

Delta Amplitude 39.83



Client: Intel Corporation	Job Number: J80050
Model: 62205ANHMW (Intel® Centrino® Advanced-N 6205)	T-Log Number: T80123
Contact: Steven Hackett	Account Manager: Christine Krebil
Standard: FCC 15.247 / FCC 15 E / RSS 210 / FCC 15 B	Class: N/A

Run # 1b, EUT on Channel #9 2452MHz - n 40MHz, Chain A

	Target (dBm)	Power Settings Measured (dBm)	Software Setting
Chain A	9.5	9.6	21.0

Fundamental Signal Field Strength

Frequency	Level	Pol	15.209 / 15.247		Detector	Azimuth	Height	Comments
MHz	dB μ V/m	v/h	Limit	Margin	Pk/QP/Avg	degrees	meters	
2439.870	91.7	H	-	-	AVG	247	1.0	RB 1 MHz;VB 10 Hz;Pk
2444.330	100.7	H	-	-	PK	247	1.0	RB 1 MHz;VB 3 MHz;Pk
2439.870	87.3	V	-	-	AVG	222	1.8	RB 1 MHz;VB 10 Hz;Pk
2440.800	95.6	V	-	-	PK	222	1.8	RB 1 MHz;VB 3 MHz;Pk

2483.5 MHz Band Edge Signal Radiated Field Strength - Marker Delta

	H	V	
Fundamental emission level @ 3m in 1MHz RBW:	100.7	95.6	Peak Measurement (RB=VB=1MHz)
Fundamental emission level @ 3m in 1MHz RBW:	91.7	87.3	Average Measurement (RB=1MHz, VB=10Hz)
<i>Delta Marker - 100kHz</i>		<i>38.0 dB</i>	-< this can only be used if band edge signal is highest within 2MHz of band edge.
Calculated Band-Edge Measurement (Peak):	62.7 dB μ V/m		
Calculated Band-Edge Measurement (Avg):	53.7 dB μ V/m		Margin
<i>Delta Marker - 1MHz/1MHz:</i>		<i>34.0 dB</i>	-1.1
<i>Delta Marker - 1MHz/10Hz:</i>		38.8 dB	-11.3
Calculated Band-Edge Measurement (Peak):	66.7 dB μ V/m		Using 100kHz delta value
Calculated Band-Edge Measurement (Avg):	52.9 dB μ V/m		Using 1MHz delta value

Frequency	Level	Pol	FCC 15.209		Detector	Azimuth	Height	Comments
MHz	dB μ V/m	v/h	Limit	Margin	Pk/QP/Avg	degrees	meters	
2483.550	52.9	-	54.0	-1.1	Avg	-	-	Using 1MHz delta value

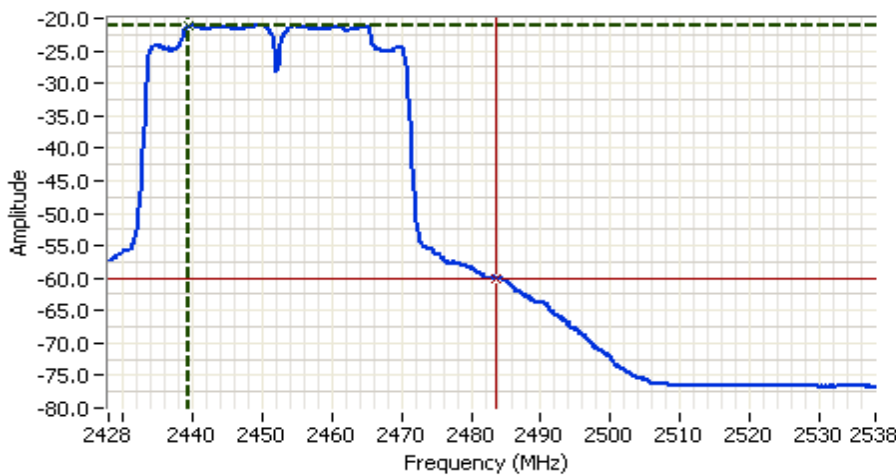

Analyzer Settings

HP8564E,EMI
 CF: 2483.000 MHz
 SPAN: 110.000 MHz
 RB 1.000 MHz
 VB 10 Hz
 Detector Sample
 Att 10
 RL Offset 0.00
 Sweep Time 41.0s
 Ref Lvl: 0.000dBm

Comments

BE @ 2483.5 MHz
 Avg

Cursor 1	2439.5500	-21.17	Delta Freq.	44.000
Cursor 2	2483.5500	-60.00	Delta Amplitude	38.83



Client:	Intel Corporation	Job Number:	J80050
Model:	62205ANHMW (Intel® Centrino® Advanced-N 6205)	T-Log Number:	T80123
Contact:	Steven Hackett	Account Manager:	Christine Krebil
Standard:	FCC 15.247 / FCC 15 E / RSS 210 / FCC 15 B	Class:	N/A

Run # 2, Band Edge Field Strength - n 40MHz, Chain A

Date of Test: 8/2/2010

Test Location: Chamber #3

Test Engineer: Rafael Varelas

Config Change: none

Run # 2a, EUT on Channel #4 2427MHz - n 40MHz, Chain A

	Power Settings		
	Target (dBm)	Measured (dBm)	Software Setting
Chain A	16.0	10.7	22.5

Fundamental Signal Field Strength

Frequency	Level	Pol	15.209 / 15.247		Detector	Azimuth	Height	Comments
MHz	dB μ V/m	v/h	Limit	Margin	Pk/QP/Avg	degrees	meters	
2425.500	91.8	H	-	-	AVG	246	1.1	RB 1 MHz;VB 10 Hz;Pk
2425.660	100.3	H	-	-	PK	246	1.1	RB 1 MHz;VB 3 MHz;Pk
2415.070	88.5	V	-	-	AVG	223	1.0	RB 1 MHz;VB 10 Hz;Pk
2419.530	97.3	V	-	-	PK	223	1.0	RB 1 MHz;VB 3 MHz;Pk

2390 MHz Band Edge Signal Radiated Field Strength - Marker Delta

	H	V	
Fundamental emission level @ 3m in 1MHz RBW:	100.3	97.3	Peak Measurement (RB=VB=1MHz)
Fundamental emission level @ 3m in 1MHz RBW:	91.8	88.5	Average Measurement (RB=1MHz, VB=10Hz)
<i>Delta Marker - 100kHz</i>	<i>38.0 dB</i>		-< this can only be used if band edge signal is highest within 2MHz of band edge.
Calculated Band-Edge Measurement (Peak):	62.3 dB μ V/m		
Calculated Band-Edge Measurement (Avg):	53.8 dB μ V/m	Margin	Level
<i>Delta Marker - 1MHz/1MHz:</i>	<i>36.5 dB</i>	-2.2	51.8
<i>Delta Marker - 1MHz/10Hz:</i>	<i>40.0 dB</i>	-11.7	62.3
Calculated Band-Edge Measurement (Peak):	63.8 dB μ V/m	Using 100kHz delta value	
Calculated Band-Edge Measurement (Avg):	51.8 dB μ V/m	Using 1MHz delta value	

Frequency	Level	Pol	FCC 15.209		Detector	Azimuth	Height	Comments
MHz	dB μ V/m	v/h	Limit	Margin	Pk/QP/Avg	degrees	meters	
2390.000	51.8	-	54.0	-2.2	Avg	-	-	Using 1MHz delta value

Client: Intel Corporation	Job Number: J80050
Model: 62205ANHMW (Intel® Centrino® Advanced-N 6205)	T-Log Number: T80123
	Account Manager: Christine Krebil
Contact: Steven Hackett	
Standard: FCC 15.247 / FCC 15 E / RSS 210 / FCC 15 B	Class: N/A

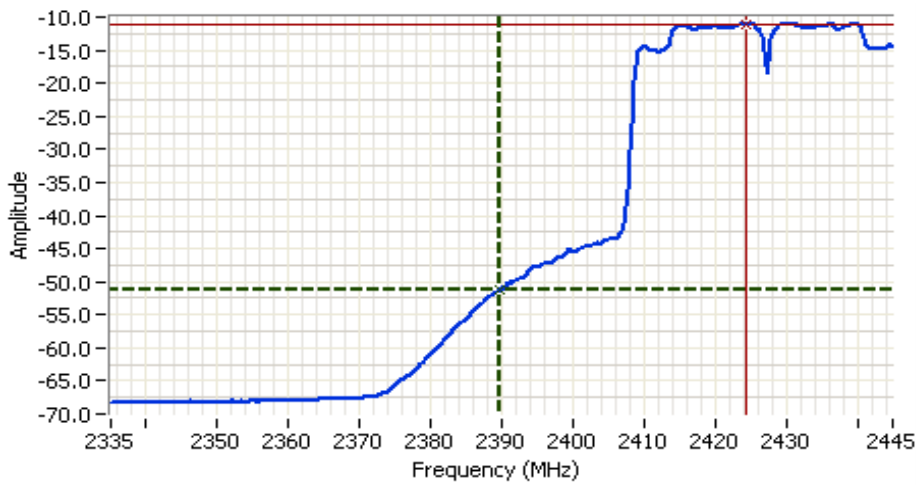

Analyzer Settings

HP8564E,EMICF: 2390.000 MHz
 SPAN: 110.000 MHz
 RB: 1.000 MHz
 VB: 10 Hz
 Detector: Sample
 Attn: 10 DB
 RL Offset: 10.0 DB
 Sweep Time: 41.0s
 Ref Lvl: 4.9 DBM

Comments

BE @ 2390 MHz
 Avg

Cursor 1	2389.8167	-51.10	
Cursor 2	2424.2834	-11.10	

Delta Freq. 34.467
 Delta Amplitude 40.00



Client: Intel Corporation	Job Number: J80050
Model: 62205ANHMW (Intel® Centrino® Advanced-N 6205)	T-Log Number: T80123
Contact: Steven Hackett	Account Manager: Christine Krebil
Standard: FCC 15.247 / FCC 15 E / RSS 210 / FCC 15 B	Class: N/A

Run # 2b, EUT on Channel #8 2447MHz - n 40MHz, Chain A

	Target (dBm)	Power Settings Measured (dBm)	Software Setting
Chain A	16.0	10.3	22.0

Fundamental Signal Field Strength

Frequency	Level	Pol	15.209 / 15.247		Detector	Azimuth	Height	Comments
MHz	dB μ V/m	v/h	Limit	Margin	Pk/QP/Avg	degrees	meters	
2443.930	92.6	H	-	-	AVG	245	1.0	RB 1 MHz;VB 10 Hz;Pk
2445.000	101.3	H	-	-	PK	245	1.0	RB 1 MHz;VB 3 MHz;Pk
2443.930	87.3	V	-	-	AVG	184	1.5	RB 1 MHz;VB 10 Hz;Pk
2444.270	95.3	V	-	-	PK	184	1.5	RB 1 MHz;VB 3 MHz;Pk

2483.5 MHz Band Edge Signal Radiated Field Strength - Marker Delta

	H	V	
Fundamental emission level @ 3m in 1MHz RBW:	101.3	95.3	Peak Measurement (RB=VB=1MHz)
Fundamental emission level @ 3m in 1MHz RBW:	92.6	87.3	Average Measurement (RB=1MHz, VB=10Hz)
Delta Marker - 100kHz		39.3 dB	-< this can only be used if band edge signal is highest within 2MHz of band edge.
Calculated Band-Edge Measurement (Peak):		62.0 dB μ V/m	
Calculated Band-Edge Measurement (Avg):		53.3 dB μ V/m	Margin
Delta Marker - 1MHz/1MHz:		37.5 dB	-1.7
Delta Marker - 1MHz/10Hz:		40.3 dB	-12.0
Calculated Band-Edge Measurement (Peak):		63.8 dB μ V/m	Using 100kHz delta value
Calculated Band-Edge Measurement (Avg):		52.3 dB μ V/m	Using 1MHz delta value

Frequency	Level	Pol	FCC 15.209		Detector	Azimuth	Height	Comments
MHz	dB μ V/m	v/h	Limit	Margin	Pk/QP/Avg	degrees	meters	
2483.500	52.3	-	54.0	-1.7	Avg	-	-	Using 1MHz delta value



Analyzer Settings

HP8564E,EMI
 CF: 2483.500 MHz
 SPAN: 110.000 MHz
 RB 1.000 MHz
 VB 10 Hz
 Detector Sample
 Att 10
 RL Offset 0.00
 Sweep Time 41.0s
 Ref Lvl:0.00DBM

Comments

Cursor 1	2434.9167	-20.33	
Cursor 2	2483.5000	-60.67	

Delta Freq. 48.583
 Delta Amplitude 40.33



Client: Intel Corporation	Job Number: J80050
Model: 62205ANHMW (Intel® Centrino® Advanced-N 6205)	T-Log Number: T80123
	Account Manager: Christine Krebil
Contact: Steven Hackett	
Standard: FCC 15.247 / FCC 15 E / RSS 210 / FCC 15 B	Class: N/A

Run # 3, Band Edge Field Strength - n 40MHz, Chain A
 Run # 3a, EUT on Channel #5 2432MHz - n 40MHz, Chain A
 Date of Test: 8/10/2010
 Test Engineer: Mehran Birgani

Test Location: Chamber #3
 Config Change: none

	Target (dBm)	Power Settings Measured (dBm)	Software Setting
Chain A	12.5	12.4	26.0

Fundamental Signal Field Strength

Frequency MHz	Level dB μ V/m	Pol v/h	15.209 / 15.247		Detector Pk/QP/Avg	Azimuth degrees	Height meters	Comments
			Limit	Margin				
2429.560	91.0	V	-	-	AVG	253	2.2	POS; RB 1 MHz; VB: 10 Hz
2430.360	97.7	V	-	-	PK	253	2.2	POS; RB 1 MHz; VB: 10 MHz
2444.600	93.1	H	-	-	AVG	318	1.3	RB 1 MHz;VB 10 Hz;Pk
2444.600	101.3	H	-	-	PK	318	1.3	RB 1 MHz;VB 3 MHz;Pk

2390 MHz Band Edge Signal Radiated Field Strength - Marker Delta

	H	V	
Fundamental emission level @ 3m in 1MHz RBW:	101.3	97.7	Peak Measurement (RB=VB=1MHz)
Fundamental emission level @ 3m in 1MHz RBW:	93.1	91.0	Average Measurement (RB=1MHz, VB=10Hz)
<i>Delta Marker - 100kHz</i>	42.0 dB		-< this can only be used if band edge signal is highest within 2MHz of band edge.
Calculated Band-Edge Measurement (Peak):	59.3 dB μ V/m		
Calculated Band-Edge Measurement (Avg):	51.1 dB μ V/m	Margin	Level
<i>Delta Marker - 1MHz/1MHz:</i>	38.5 dB	-3.9	50.1
<i>Delta Marker - 1MHz/10Hz:</i>	43.0 dB	-14.7	59.3
Calculated Band-Edge Measurement (Peak):	62.8 dB μ V/m	Using 100kHz delta value	
Calculated Band-Edge Measurement (Avg):	50.1 dB μ V/m	Using 1MHz delta value	

Frequency MHz	Level dB μ V/m	Pol v/h	FCC 15.209		Detector Pk/QP/Avg	Azimuth degrees	Height meters	Comments
			Limit	Margin				
2390.000	50.1	-	54.0	-3.9	Avg	-	-	Using 1MHz delta value

Client: Intel Corporation	Job Number: J80050
Model: 62205ANHMW (Intel® Centrino® Advanced-N 6205)	T-Log Number: T80123
	Account Manager: Christine Krebil
Contact: Steven Hackett	
Standard: FCC 15.247 / FCC 15 E / RSS 210 / FCC 15 B	Class: N/A

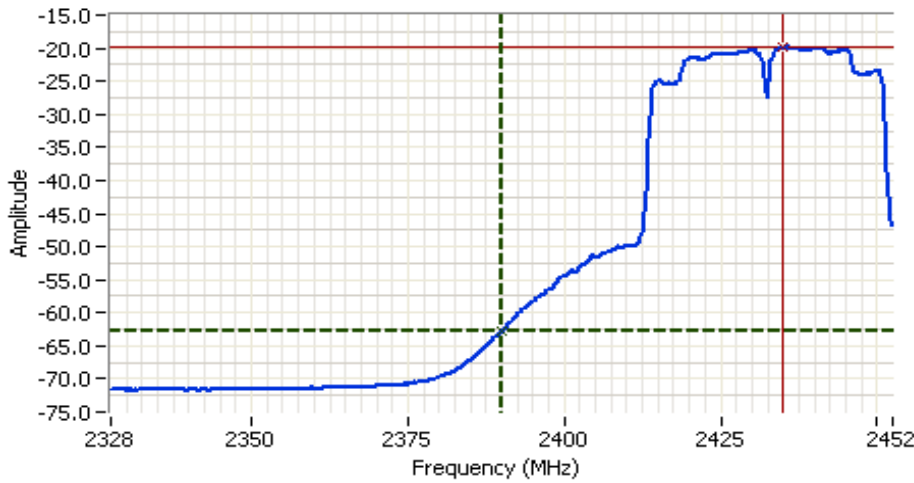

Analyzer Settings

HP8564E,EMICF: 2390.000
MHz
SPAN: 125.000 MHz
RB: 1.000 MHz
VB: 10 Hz
Detector: Sample
Attr: 10 DB
RL Offset: 10.0 DB
Sweep Time: 47.0s
Ref Lvl: -11.9 DBM

Comments

BE @ 2390 MHz
Avg-CH5

Cursor 1	2390.0000	-62.90	
Cursor 2	2435.0000	-19.90	

Delta Freq. 45.000
Delta Amplitude 43.00



Client: Intel Corporation	Job Number: J80050
Model: 62205ANHMW (Intel® Centrino® Advanced-N 6205)	T-Log Number: T80123
	Account Manager: Christine Krebil
Contact: Steven Hackett	
Standard: FCC 15.247 / FCC 15 E / RSS 210 / FCC 15 B	Class: N/A

Run # 3b, EUT on Channel #7 2442MHz - n 40MHz, Chain A

Date of Test: 8/2/2010 Test Location: Chamber #3
 Test Engineer: D. Bare, M. Birgani Config Change: none

	Target (dBm)	Power Settings Measured (dBm)	Software Setting
Chain A	16.0	12.6	24.0

Fundamental Signal Field Strength

Frequency	Level	Pol	15.209 / 15.247		Detector	Azimuth	Height	Comments
MHz	dBμV/m	v/h	Limit	Margin	Pk/QP/Avg	degrees	meters	
2445.200	92.6	H	-	-	AVG	252	1.3	RB 1 MHz;VB 10 Hz;Pk
2454.870	100.9	H	-	-	PK	252	1.3	RB 1 MHz;VB 3 MHz;Pk
2430.130	90.8	V	-	-	AVG	167	1.2	RB 1 MHz;VB 10 Hz;Pk
2434.530	98.9	V	-	-	PK	167	1.2	RB 1 MHz;VB 3 MHz;Pk

2483.5 MHz Band Edge Signal Radiated Field Strength - Marker Delta

	H	V				
Fundamental emission level @ 3m in 1MHz RBW:	100.9	98.9	Peak Measurement (RB=VB=1MHz)			
Fundamental emission level @ 3m in 1MHz RBW:	92.6	90.8	Average Measurement (RB=1MHz, VB=10Hz)			
<i>Delta Marker - 100kHz</i>	40.8 dB		-< this can only be used if band edge signal is highest within 2MHz of band edge.			
Calculated Band-Edge Measurement (Peak):	60.1 dBuV/m					
Calculated Band-Edge Measurement (Avg):	51.8 dBuV/m		Margin	Level	Limit	Detector
<i>Delta Marker - 1MHz/1MHz:</i>	37.5 dB		-2.2	51.8	54	Avg
<i>Delta Marker - 1MHz/10Hz:</i>	40.5 dB		-13.9	60.1	74	Pk
Calculated Band-Edge Measurement (Peak):	63.4 dBuV/m		Using 100kHz delta value			
Calculated Band-Edge Measurement (Avg):	52.1 dBuV/m		Using 100kHz delta value			

Frequency	Level	Pol	FCC 15.209		Detector	Azimuth	Height	Comments
MHz	dBμV/m	v/h	Limit	Margin	Pk/QP/Avg	degrees	meters	
2484.167	51.8	-	54.0	-2.2	Avg	-	-	Using 100kHz delta value

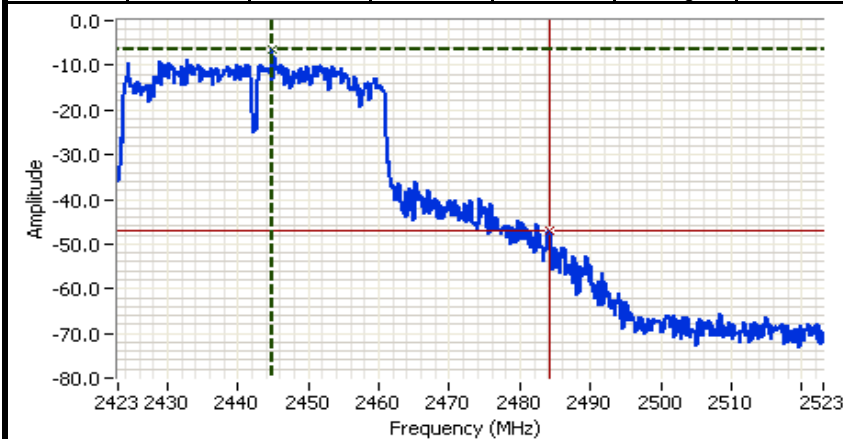

Analyzer Settings
 HP8564E,EMICF: 2473.000 MHz
 SPAN: 100.000 MHz
 RB: 100 kHz
 VB: 100 kHz
 Detector: POS
 Attn: 10 DB
 RL Offset: 10.0 DB
 Sweep Time: 55.0ms
 Ref Lvl: 4.3 DBM

Comments

Cursor 1	2444.8333	-6.37	Delta Freq.	39.333
Cursor 2	2484.1667	-47.20	Delta Amplitude	40.83



Client:	Intel Corporation	Job Number:	J80050
Model:	62205ANHMW (Intel® Centrino® Advanced-N 6205)	T-Log Number:	T80123
Contact:	Steven Hackett	Account Manager:	Christine Krebil
Standard:	FCC 15.247 / FCC 15 E / RSS 210 / FCC 15 B	Class:	N/A

Run # 4, Band Edge Field Strength - n 40MHz, Chain B

Date of Test: 8/2/2010

Test Location: Chamber #3

Test Engineer: Mehran Birgani

Config Change: none

Run # 4a, EUT on Channel #3 2422MHz - n 40MHz, Chain B

	Target (dBm)	Power Settings Measured (dBm)	Software Setting
Chain B	9.5	9.6	18.5

Fundamental Signal Field Strength

Frequency MHz	Level dBμV/m	Pol v/h	15.209 / 15.247		Detector Pk/QP/Avg	Azimuth degrees	Height meters	Comments
			Limit	Margin				
2411.400	87.2	V	-	-	AVG	117	1.0	RB 1 MHz;VB 10 Hz;Pk
2411.730	95.2	V	-	-	PK	117	1.0	RB 1 MHz;VB 3 MHz;Pk
2411.470	89.0	H	-	-	AVG	10	2.1	RB 1 MHz;VB 10 Hz;Pk
2411.930	97.2	H	-	-	PK	10	2.1	RB 1 MHz;VB 3 MHz;Pk
2412.470	84.7	V	-	-	-	117	1.0	RB 100 kHz;VB 100 kHz;Pk
2410.270	87.3	H	-	-	-	10	2.1	RB 100 kHz;VB 100 kHz;Pk

2390 MHz Band Edge Signal Radiated Field Strength - Marker Delta

	H	V	
Fundamental emission level @ 3m in 1MHz RBW:	97.2	95.2	Peak Measurement (RB=VB=1MHz)
Fundamental emission level @ 3m in 1MHz RBW:	89.0	87.2	Average Measurement (RB=1MHz, VB=10Hz)
<i>Delta Marker - 100kHz</i>	44.7 dB		-< this can only be used if band edge signal is highest within 2MHz of band edge.
Calculated Band-Edge Measurement (Peak):	52.5 dBuV/m		
Calculated Band-Edge Measurement (Avg):	44.3 dBuV/m		Margin
<i>Delta Marker - 1MHz/1MHz:</i>	47.0 dB		Level
<i>Delta Marker - 1MHz/10Hz:</i>	21.8 dB		Limit
Calculated Band-Edge Measurement (Peak):	50.2 dBuV/m		Detector
Calculated Band-Edge Measurement (Avg):	67.2 dBuV/m		

Frequency MHz	Level dBμV/m	Pol v/h	FCC 15.209		Detector Pk/QP/Avg	Azimuth degrees	Height meters	Comments
			Limit	Margin				
2390.000	44.3	-	54.0	-9.7	Avg	-	-	Using 100kHz delta value

Client: Intel Corporation	Job Number: J80050
Model: 62205ANHMW (Intel® Centrino® Advanced-N 6205)	T-Log Number: T80123
Contact: Steven Hackett	Account Manager: Christine Krebil
Standard: FCC 15.247 / FCC 15 E / RSS 210 / FCC 15 B	Class: N/A

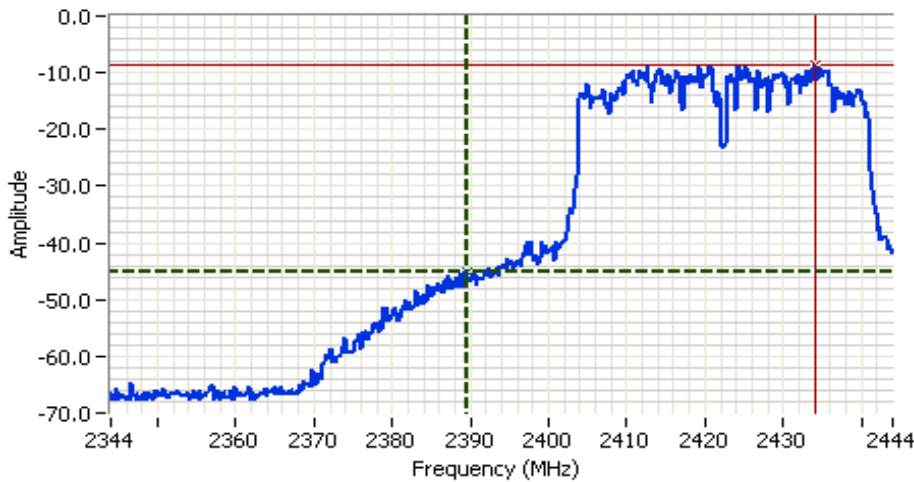

Analyzer Settings

HP8564E,EMICF: 2394.000
MHz
SPAN: 100.000 MHz
RB: 100 kHz
VB: 100 kHz
Detector: POS
Attrn: 10 DB
RL Offset: 10.0 DB
Sweep Time: 2.0s
Ref Lvl: 4.7 DBM

Comments

Cursor 1	2389.5000	-44.97	
Cursor 2	2434.1667	-8.47	

Delta Freq. 44.667
Delta Amplitude 36.50



Client: Intel Corporation	Job Number: J80050
Model: 62205ANHMW (Intel® Centrino® Advanced-N 6205)	T-Log Number: T80123
Contact: Steven Hackett	Account Manager: Christine Krebil
Standard: FCC 15.247 / FCC 15 E / RSS 210 / FCC 15 B	Class: N/A

Run # 4b, EUT on Channel #9 2452MHz - n 40MHz, Chain B

Date of Test: 8/3/2010 Test Location: Chamber #3
 Test Engineer: Rafael Varelas Config Change: none

	Target (dBm)	Power Settings Measured (dBm)	Software Setting
Chain B	10.0	10.2	22.5

Fundamental Signal Field Strength

Frequency	Level	Pol	15.209 / 15.247		Detector	Azimuth	Height	Comments
MHz	dBμV/m	v/h	Limit	Margin	Pk/QP/Avg	degrees	meters	
2440.130	84.5	V	-	-	AVG	118	1.0	RB 1 MHz;VB 10 Hz;Pk
2440.600	93.1	V	-	-	PK	118	1.0	RB 1 MHz;VB 3 MHz;Pk
2444.200	88.4	H	-	-	AVG	22	2.0	RB 1 MHz;VB 10 Hz;Pk
2450.200	97.0	H	-	-	PK	22	2.0	RB 1 MHz;VB 3 MHz;Pk

2483.5 MHz Band Edge Signal Radiated Field Strength - Marker Delta

	H	V	
Fundamental emission level @ 3m in 1MHz RBW:	97.0	93.1	Peak Measurement (RB=VB=1MHz)
Fundamental emission level @ 3m in 1MHz RBW:	88.4	84.5	Average Measurement (RB=1MHz, VB=10Hz)
<i>Delta Marker - 100kHz</i>		<i>35.3 dB</i>	-< this can only be used if band edge signal is highest within 2MHz of band edge.
Calculated Band-Edge Measurement (Peak):	61.7 dBuV/m		
Calculated Band-Edge Measurement (Avg):	53.1 dBuV/m	Margin	Level
<i>Delta Marker - 1MHz/1MHz:</i>		<i>35.5 dB</i>	Limit
<i>Delta Marker - 1MHz/10Hz:</i>		38.0 dB	Detector
Calculated Band-Edge Measurement (Peak):	61.5 dBuV/m	-3.6	50.4
Calculated Band-Edge Measurement (Avg):	50.4 dBuV/m	-12.5	61.5
			74
			Pk
			Using 1MHz delta value
			Using 1MHz delta value

Frequency	Level	Pol	FCC 15.209		Detector	Azimuth	Height	Comments
MHz	dBμV/m	v/h	Limit	Margin	Pk/QP/Avg	degrees	meters	
2483.500	50.4	-	54.0	-3.6	Avg	-	-	Using 1MHz delta value

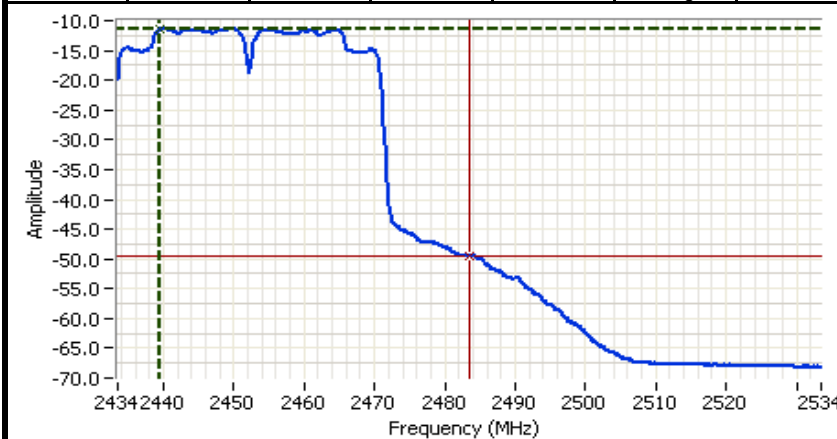

Analyzer Settings
 HP8564E,EMICF: 2483.500
 MHz
 SPAN: 100.000 MHz
 RB: 1.000 MHz
 VB: 10 Hz
 Detector: Sample
 Attn: 10 DB
 RL Offset: 10.0 DB
 Sweep Time: 37.0s
 Ref Lvl: 5.5 DBM

Comments
 BE @ 2483.5 MHz
 Avg

Cursor 1	2439.5000	-11.50	
Cursor 2	2483.5000	-49.50	

Delta Freq. 44.000
 Delta Amplitude 38.00



Client:	Intel Corporation	Job Number:	J80050
Model:	62205ANHMW (Intel® Centrino® Advanced-N 6205)	T-Log Number:	T80123
		Account Manager:	Christine Krebil
Contact:	Steven Hackett		
Standard:	FCC 15.247 / FCC 15 E / RSS 210 / FCC 15 B	Class:	N/A

Run # 5, Band Edge Field Strength - n 40MHz, Chain B

Date of Test: 8/3/2010

Test Location: Chamber #3

Test Engineer: Rafael Varelas

Config Change: none

Run # 5a, EUT on Channel #4 2427MHz - n 40MHz, Chain B

	Power Settings		
	Target (dBm)	Measured (dBm)	Software Setting
Chain B	16.0	11.7	23.5

Fundamental Signal Field Strength

Frequency MHz	Level dB μ V/m	Pol v/h	15.209 / 15.247		Detector Pk/QP/Avg	Azimuth degrees	Height meters	Comments
			Limit	Margin				
2414.9	90.7	H	-	-	AVG	17	2.0	RB 1 MHz;VB 10 Hz;Pk
2414.8	98.9	H	-	-	PK	17	2.0	RB 1 MHz;VB 3 MHz;Pk
2414.5	85.8	V	-	-	AVG	93	2.1	RB 1 MHz;VB 10 Hz;Pk
2415.5	94.0	V	-	-	PK	93	2.1	RB 1 MHz;VB 3 MHz;Pk

2390 MHz Band Edge Signal Radiated Field Strength - Marker Delta

	H	V	
Fundamental emission level @ 3m in 1MHz RBW:	98.9	94.0	Peak Measurement (RB=VB=1MHz)
Fundamental emission level @ 3m in 1MHz RBW:	90.7	85.8	Average Measurement (RB=1MHz, VB=10Hz)
<i>Delta Marker - 100kHz</i>	<i>37.8 dB</i>		-< this can only be used if band edge signal is highest within 2MHz of band edge.
Calculated Band-Edge Measurement (Peak):	61.1 dB μ V/m		
Calculated Band-Edge Measurement (Avg):	52.9 dB μ V/m	Margin	Level
<i>Delta Marker - 1MHz/1MHz:</i>	<i>35.5 dB</i>	-2.3	51.7
<i>Delta Marker - 1MHz/10Hz:</i>	39.0 dB	-12.9	61.1
Calculated Band-Edge Measurement (Peak):	63.4 dB μ V/m	Using 100kHz delta value	
Calculated Band-Edge Measurement (Avg):	51.7 dB μ V/m	Using 1MHz delta value	

Frequency MHz	Level dB μ V/m	Pol v/h	FCC 15.209		Detector Pk/QP/Avg	Azimuth degrees	Height meters	Comments
			Limit	Margin				
2390.000	51.7	-	54.0	-2.3	Avg	-	-	Using 1MHz delta value

Client: Intel Corporation	Job Number: J80050
Model: 62205ANHMW (Intel® Centrino® Advanced-N 6205)	T-Log Number: T80123
	Account Manager: Christine Krebil
Contact: Steven Hackett	
Standard: FCC 15.247 / FCC 15 E / RSS 210 / FCC 15 B	Class: N/A

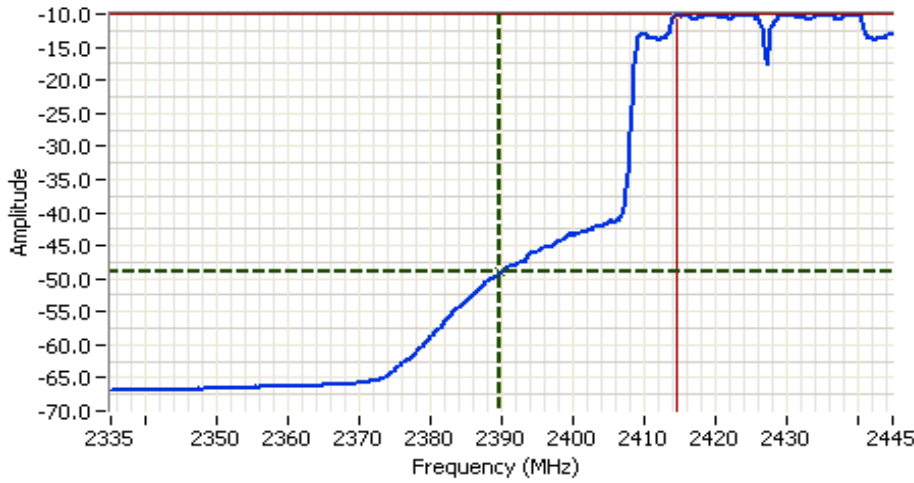

Analyzer Settings

HP8564E,EMICF: 2390.000
MHz
SPAN: 110.000 MHz
RB: 1.000 MHz
VB: 10 Hz
Detector: Sample
Attrn: 10 DB
RL Offset: 10.0 DB
Sweep Time: 41.0s
Ref Lvl: 8.6 DBM

Comments

BE @ 2390 MHz
Avg

Cursor 1	2389.8167	-49.07	
Cursor 2	2414.7500	-10.07	

Delta Freq. 24.933
Delta Amplitude 39.00



Client: Intel Corporation	Job Number: J80050
Model: 62205ANHMW (Intel® Centrino® Advanced-N 6205)	T-Log Number: T80123
Contact: Steven Hackett	Account Manager: Christine Krebil
Standard: FCC 15.247 / FCC 15 E / RSS 210 / FCC 15 B	Class: N/A

Run # 5b, EUT on Channel #8 2447MHz - n 40MHz, Chain B

	Target (dBm)	Power Settings Measured (dBm)	Software Setting
Chain B	16.0	11.6	23.5

Fundamental Signal Field Strength

Frequency	Level	Pol	15.209 / 15.247		Detector	Azimuth	Height	Comments
MHz	dB μ V/m	v/h	Limit	Margin	Pk/QP/Avg	degrees	meters	
2444.070	90.8	H	-	-	AVG	41	1.2	RB 1 MHz;VB 10 Hz;Pk
2443.330	99.3	H	-	-	PK	41	1.2	RB 1 MHz;VB 3 MHz;Pk
2444.670	84.0	V	-	-	AVG	117	1.4	RB 1 MHz;VB 10 Hz;Pk
2443.930	92.0	V	-	-	PK	117	1.4	RB 1 MHz;VB 3 MHz;Pk

2483.5 MHz Band Edge Signal Radiated Field Strength - Marker Delta

	H	V	
Fundamental emission level @ 3m in 1MHz RBW:	99.3	92.0	Peak Measurement (RB=VB=1MHz)
Fundamental emission level @ 3m in 1MHz RBW:	90.8	84.0	Average Measurement (RB=1MHz, VB=10Hz)
Delta Marker - 100kHz		38.3 dB	-< this can only be used if band edge signal is highest within 2MHz of band edge.
Calculated Band-Edge Measurement (Peak):		61.0 dB μ V/m	
Calculated Band-Edge Measurement (Avg):		52.5 dB μ V/m	Margin
Delta Marker - 1MHz/1MHz:		33.7 dB	-3.0
Delta Marker - 1MHz/10Hz:		39.8 dB	-13.0
Calculated Band-Edge Measurement (Peak):		65.6 dB μ V/m	Using 100kHz delta value
Calculated Band-Edge Measurement (Avg):		51.0 dB μ V/m	Using 1MHz delta value

Frequency	Level	Pol	FCC 15.209		Detector	Azimuth	Height	Comments
MHz	dB μ V/m	v/h	Limit	Margin	Pk/QP/Avg	degrees	meters	
2483.500	51.0	-	54.0	-3.0	Avg	-	-	Using 1MHz delta value



Analyzer Settings
 HP8564E,EMICF: 2483.500 MHz
 SPAN: 100.000 MHz
 RB: 1.000 MHz
 VB: 10 Hz
 Detector: Sample
 Attn: 10 DB
 RL Offset: 10.0 DB
 Sweep Time: 37.0s
 Ref Lvl: 10.0 DBM

Comments
 BE @ 2483.5 MHz
 Avg

Cursor 1	2444.6667	-9.83	Delta Freq.	38.833
Cursor 2	2483.5000	-49.67	Delta Amplitude	39.83



Client: Intel Corporation	Job Number: J80050
Model: 62205ANHMW (Intel® Centrino® Advanced-N 6205)	T-Log Number: T80123
	Account Manager: Christine Krebil
Contact: Steven Hackett	
Standard: FCC 15.247 / FCC 15 E / RSS 210 / FCC 15 B	Class: N/A

Run # 6, Band Edge Field Strength - n 40MHz, Chain B

Date of Test: 8/10/2010

Test Location: Chamber #3

Test Engineer: Mehran Birgani

Config Change: none

Run # 6a, EUT on Channel #5 2432MHz - n 40MHz, Chain B

	Target (dBm)	Power Settings Measured (dBm)	Software Setting
Chain B	13.0	13.0	24.5

Fundamental Signal Field Strength

Frequency MHz	Level dB μ V/m	Pol v/h	15.209 / 15.247		Detector Pk/QP/Avg	Azimuth degrees	Height meters	Comments
			Limit	Margin				
2434.850	89.1	V	-	-	AVG	111	1.0	POS; RB 1 MHz; VB: 10 Hz
2439.250	97.8	V	-	-	PK	111	1.0	POS; RB 1 MHz; VB: 10 MHz
2435.400	91.2	H	-	-	AVG	360	1.0	RB 1 MHz;VB 10 Hz;Pk
2442.600	100.0	H	-	-	PK	360	1.0	RB 1 MHz;VB 3 MHz;Pk

2390 MHz Band Edge Signal Radiated Field Strength - Marker Delta

	H	V	
Fundamental emission level @ 3m in 1MHz RBW:	100.0	97.8	Peak Measurement (RB=VB=1MHz)
Fundamental emission level @ 3m in 1MHz RBW:	91.2	89.1	Average Measurement (RB=1MHz, VB=10Hz)
<i>Delta Marker - 100kHz</i>	42.7 dB		-< this can only be used if band edge signal is highest within 2MHz of band edge.
Calculated Band-Edge Measurement (Peak):	57.3 dB μ V/m		
Calculated Band-Edge Measurement (Avg):	48.5 dB μ V/m		Margin
<i>Delta Marker - 1MHz/1MHz:</i>	<i>39.0 dB</i>		-5.5
<i>Delta Marker - 1MHz/10Hz:</i>	<i>42.2 dB</i>		48.5
Calculated Band-Edge Measurement (Peak):	61.0 dB μ V/m		54
Calculated Band-Edge Measurement (Avg):	49.0 dB μ V/m		74
			Pk
			Using 100kHz delta value
			Using 100kHz delta value

Frequency MHz	Level dB μ V/m	Pol v/h	FCC 15.209		Detector Pk/QP/Avg	Azimuth degrees	Height meters	Comments
			Limit	Margin				
2390.000	48.5	-	54.0	-5.5	Avg	-	-	Using 100kHz delta value

Client: Intel Corporation	Job Number: J80050
Model: 62205ANHMW (Intel® Centrino® Advanced-N 6205)	T-Log Number: T80123
	Account Manager: Christine Krebil
Contact: Steven Hackett	
Standard: FCC 15.247 / FCC 15 E / RSS 210 / FCC 15 B	Class: N/A

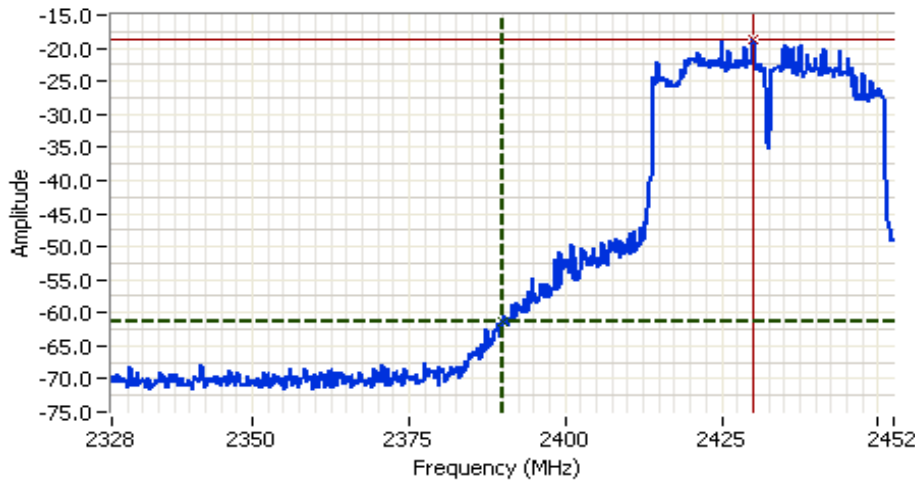

Analyzer Settings

HP8564E,EMICF: 2390.000
MHz
SPAN: 125.000 MHz
RB: 100 kHz
VB: 100 kHz
Detector: POS
Attr: 10 DB
RL Offset: 10.0 DB
Sweep Time: 69.0ms
Ref Lvl: -11.9 DBM

Comments

BE @ 2390 MHz
PK-CH5

Cursor 1	2390.0000	-61.40	
Cursor 2	2430.0000	-18.73	

Delta Freq. 40.000
Delta Amplitude 42.67



Client: Intel Corporation	Job Number: J80050
Model: 62205ANHMW (Intel® Centrino® Advanced-N 6205)	T-Log Number: T80123
Contact: Steven Hackett	Account Manager: Christine Krebil
Standard: FCC 15.247 / FCC 15 E / RSS 210 / FCC 15 B	Class: N/A

Run # 6b, EUT on Channel #7 2442MHz - n 40MHz, Chain B

	Target (dBm)	Power Settings Measured (dBm)	Software Setting
Chain B	13.0	13.0	24.5

Fundamental Signal Field Strength

Frequency	Level	Pol	15.209 / 15.247		Detector	Azimuth	Height	Comments
MHz	dB μ V/m	v/h	Limit	Margin	Pk/QP/Avg	degrees	meters	
2429.860	90.4	V	-	-	AVG	111	1.0	POS; RB 1 MHz; VB: 10 Hz
2436.510	98.5	V	-	-	PK	111	1.0	POS; RB 1 MHz; VB: 10 MHz
2438.800	91.3	H	-	-	AVG	2	1.0	RB 1 MHz;VB 10 Hz;Pk
2434.330	99.7	H	-	-	PK	2	1.0	RB 1 MHz;VB 3 MHz;Pk

2483.5 MHz Band Edge Signal Radiated Field Strength - Marker Delta

	H	V	
Fundamental emission level @ 3m in 1MHz RBW:	99.7	98.5	Peak Measurement (RB=VB=1MHz)
Fundamental emission level @ 3m in 1MHz RBW:	91.3	90.4	Average Measurement (RB=1MHz, VB=10Hz)
Delta Marker - 100kHz		40.8 dB	-< this can only be used if band edge signal is highest within 2MHz of band edge.
Calculated Band-Edge Measurement (Peak):		58.9 dB μ V/m	
Calculated Band-Edge Measurement (Avg):		50.5 dB μ V/m	Margin
Delta Marker - 1MHz/1MHz:		37.2 dB	Level
Delta Marker - 1MHz/10Hz:		40.8 dB	Limit
Calculated Band-Edge Measurement (Peak):		62.5 dB μ V/m	Detector
Calculated Band-Edge Measurement (Avg):		50.5 dB μ V/m	

Frequency	Level	Pol	FCC 15.209		Detector	Azimuth	Height	Comments
MHz	dB μ V/m	v/h	Limit	Margin	Pk/QP/Avg	degrees	meters	
2483.500	50.5	-	54.0	-3.5	Avg	-	-	Using 1MHz delta value

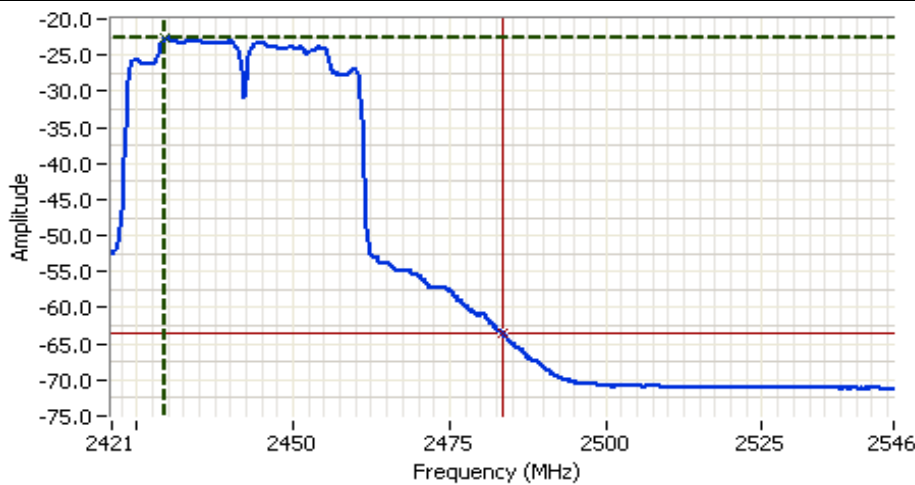

Analyzer Settings
 HP8564E,EMICF: 2483.500 MHz
 SPAN: 125.000 MHz
 RB: 1.000 MHz
 VB: 10 Hz
 Detector: Sample
 Attrn: 10 DB
 RL Offset: 10.0 DB
 Sweep Time: 47.0s
 Ref Lvl: -18.0 DBM

Comments
 BE @ 2483.5
 Avg-CH7

Cursor 1	2429.5417	-22.67	Delta Freq.	53.958
Cursor 2	2483.5000	-63.50	Delta Amplitude	40.83



Client:	Intel Corporation	Job Number:	J80050
Model:	62205ANHMW (Intel® Centrino® Advanced-N 6205)	T-Log Number:	T80123
Contact:	Steven Hackett	Account Manager:	Christine Krebil
Standard:	FCC 15.247 / FCC 15 E / RSS 210 / FCC 15 B	Class:	N/A

Run # 7, Band Edge Field Strength - n 40MHz, Chain A+B - new target of 8dBm per chain 8/25/2010
 Date of Test: 8/26/2010 Test Location: FT#7
 Test Engineer: Mark Hill Config Change: none

Sample: 0015000633B14

Run # 7a, EUT on Channel #3 2422MHz - n 40MHz, Chain A+B

Chain	Target (dBm)				Measured (dBm)				Software Setting
	A	B	C	Total	A	B	C	Total	
	8.0	8.0		11.0	8.0	8.0		11.0	23.5, 22

Fundamental Signal Field Strength

Frequency	Level	Pol	15.209 / 15.247		Detector	Azimuth	Height	Comments
MHz	dB μ V/m	v/h	Limit	Margin	Pk/QP/Avg	degrees	meters	
2419.800	89.3	H	-	-	AVG	224	1.1	RB 1 MHz;VB 10 Hz;Pk
2419.530	98.9	H	-	-	PK	224	1.1	RB 1 MHz;VB 3 MHz;Pk
2434.870	87.1	V	-	-	AVG	86	1.0	RB 1 MHz;VB 10 Hz;Pk
2434.800	97.2	V	-	-	PK	86	1.0	RB 1 MHz;VB 3 MHz;Pk

2390 MHz Band Edge Signal Radiated Field Strength - Marker Delta

	H	V	
Fundamental emission level @ 3m in 1MHz RBW:	98.9	97.2	Peak Measurement (RB=VB=1MHz)
Fundamental emission level @ 3m in 1MHz RBW:	89.3	87.1	Average Measurement (RB=1MHz, VB=10Hz)
<i>Delta Marker - 100kHz</i>	38.5 dB		<- this can only be used if band edge signal is highest within 2MHz of band edge.
Calculated Band-Edge Measurement (Peak):	60.4 dB μ V/m		
Calculated Band-Edge Measurement (Avg):	50.8 dB μ V/m	Margin	Level
<i>Delta Marker - 1MHz/1MHz:</i>	34.0 dB	-3.2	50.8
<i>Delta Marker - 1MHz/10Hz:</i>	37.5 dB	-13.6	60.4
Calculated Band-Edge Measurement (Peak):	64.9 dB μ V/m	Using 100kHz delta value	
Calculated Band-Edge Measurement (Avg):	51.8 dB μ V/m	Using 100kHz delta value	

Frequency	Level	Pol	FCC 15.209		Detector	Azimuth	Height	Comments
MHz	dB μ V/m	v/h	Limit	Margin	Pk/QP/Avg	degrees	meters	
2390.000	50.8	-	54.0	-3.2	Avg	-	-	Using 100kHz delta value

Client: Intel Corporation	Job Number: J80050
Model: 62205ANHMW (Intel® Centrino® Advanced-N 6205)	T-Log Number: T80123
	Account Manager: Christine Krebil
Contact: Steven Hackett	
Standard: FCC 15.247 / FCC 15 E / RSS 210 / FCC 15 B	Class: N/A

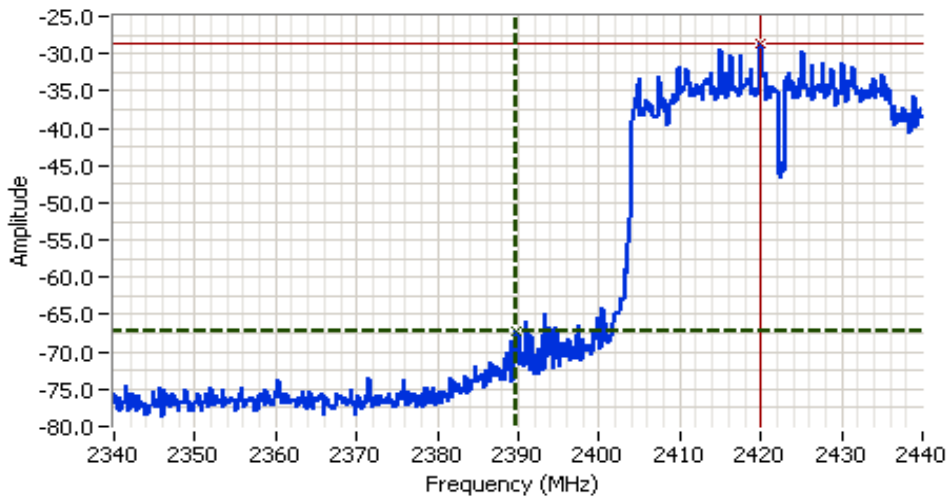

Analyzer Settings

HP8564E,EMI
 CF: 2390.000 MHz
 SPAN: 100.000 MHz
 RB 100 kHz
 VB 100 kHz
 Detector POS
 Att 10
 RL Offset 0.00
 Sweep Time 55.0ms
 Ref Lvl:0.00DBM

Comments

802.11 n40 A+B, CH 3

Cursor 1	2389.8333	-67.17	
Cursor 2	2420.0000	-28.67	

Delta Freq. 30.167
 Delta Amplitude 38.50



Run # 7b, EUT on Channel #9 2452MHz - n 40MHz, Chain A+B

Sample: 0015000633B14

Date of Test: 8/27/2010

Test Location: FT Chamber#4

Test Engineer: Joseph Cadigal

Config Change: none

Chain	Target (dBm)				Measured (dBm)				Software Setting
	A	B	C	Total	A	B	C	Total	
	8.5	8.5		11.5	8.6	8.6		11.6	24,22.5

Fundamental Signal Field Strength

Frequency	Level	Pol	15.209 / 15.247		Detector	Azimuth	Height	Comments
MHz	dB μ V/m	v/h	Limit	Margin	Pk/QP/Avg	degrees	meters	
2449.270	87.9	V	-	-	AVG	171	1.2	RB 1 MHz;VB 10 Hz;Pk
2443.270	97.9	V	-	-	PK	171	1.2	RB 1 MHz;VB 3 MHz;Pk
2454.730	91.1	H	-	-	AVG	344	1.2	RB 1 MHz;VB 10 Hz;Pk
2459.870	101.3	H	-	-	PK	344	1.2	RB 1 MHz;VB 3 MHz;Pk

Direct Measurement of Field Strength at the bandedge

Frequency	Level	Pol	FCC 15.209		Detector	Azimuth	Height	Comments
MHz	dB μ V/m	v/h	Limit	Margin	Pk/QP/Avg	degrees	meters	
2484.510	51.3	H	54.0	-2.7	AVG	356	1.1	RB 1 MHz;VB 10 Hz;Pk
2484.980	66.8	H	74.0	-7.2	PK	356	1.1	RB 1 MHz;VB 3 MHz;Pk
2484.360	49.9	V	54.0	-4.1	AVG	172	1.2	RB 1 MHz;VB 10 Hz;Pk
2484.130	60.2	V	74.0	-13.8	PK	169	1.0	RB 1 MHz;VB 3 MHz;Pk

Client: Intel Corporation	Job Number: J80050
Model: 62205ANHMW (Intel® Centrino® Advanced-N 6205)	T-Log Number: T80123
	Account Manager: Christine Krebil
Contact: Steven Hackett	
Standard: FCC 15.247 / FCC 15 E / RSS 210 / FCC 15 B	Class: N/A

Run # 8, Band Edge Field Strength - n 40MHz, Chain A+B - New Target powers 8/25/2010
 Date of Test: 8/26/2010 Test Location: FT #7
 Test Engineer: Mark Hill Config Change: none

Sample: 0015000633B14

Run # 8a, EUT on Channel #4 2427MHz - n 40MHz, Chain A+B

Chain	Target (dBm)				Power Settings Measured (dBm)				Software Setting
	A	B	C	Total	A	B	C	Total	
	10.0	10.0		13.0	10.3	10.1		13.2	26.5, 24.5

Fundamental Signal Field Strength

Frequency	Level	Pol	15.209 / 15.247		Detector	Azimuth	Height	Comments
MHz	dBµV/m	v/h	Limit	Margin	Pk/QP/Avg	degrees	meters	
2424.330	91.3	H	-	-	AVG	176	1.0	RB 1 MHz;VB 10 Hz;Pk
2421.800	101.6	H	-	-	PK	176	1.0	RB 1 MHz;VB 3 MHz;Pk
2439.870	89.4	V	-	-	AVG	80	1.0	RB 1 MHz;VB 10 Hz;Pk
2439.800	99.2	V	-	-	PK	80	1.0	RB 1 MHz;VB 3 MHz;Pk

Direct Measurement of Field Strength at the bandedge

Frequency	Level	Pol	FCC 15.209		Detector	Azimuth	Height	Comments
MHz	dBµV/m	v/h	Limit	Margin	Pk/QP/Avg	degrees	meters	
2389.670	52.0	H	54.0	-2.0	AVG	176	1.1	RB 1 MHz;VB 10 Hz;Pk
2389.800	66.4	H	74.0	-7.6	PK	176	1.1	RB 1 MHz;VB 3 MHz;Pk

Run # 8b, EUT on Channel #8 2447MHz - n 40MHz, Chain A+B

Sample: 0015000633B14

Chain	Target (dBm)				Power Settings Measured (dBm)				Software Setting
	A	B	C	Total	A	B	C	Total	
	10.0	10.0		13.0	10.2	10.2		13.2	26, 24.5

Fundamental Signal Field Strength

Frequency	Level	Pol	15.209 / 15.247		Detector	Azimuth	Height	Comments
MHz	dBµV/m	v/h	Limit	Margin	Pk/QP/Avg	degrees	meters	
2444.400	91.7	H	-	-	AVG	174	1.0	RB 1 MHz;VB 10 Hz;Pk
2443.670	102.1	H	-	-	PK	174	1.0	RB 1 MHz;VB 3 MHz;Pk
2449.800	88.9	V	-	-	AVG	178	1.0	RB 1 MHz;VB 10 Hz;Pk
2442.270	99.3	V	-	-	PK	178	1.0	RB 1 MHz;VB 3 MHz;Pk

Direct Measurement of Field Strength at the bandedge

Frequency	Level	Pol	FCC 15.209		Detector	Azimuth	Height	Comments
MHz	dBµV/m	v/h	Limit	Margin	Pk/QP/Avg	degrees	meters	
2484.300	51.7	H	54.0	-2.3	AVG	183	1.0	RB 1 MHz;VB 10 Hz;Pk
2484.900	66.4	H	74.0	-7.6	PK	183	1.0	RB 1 MHz;VB 3 MHz;Pk

Client:	Intel Corporation	Job Number:	J80050
Model:	62205ANHMW (Intel® Centrino® Advanced-N 6205)	T-Log Number:	T80123
Contact:	Steven Hackett	Account Manager:	Christine Krebil
Standard:	FCC 15.247 / FCC 15 E / RSS 210 / FCC 15 B	Class:	N/A

**RSS 210 and FCC 15.247 (DTS) Radiated Emissions
Band Edge Measurements - 802.11b, 802.11g and 802.11n (20MHz)**

Summary of Results

MAC Address: 001500633B2C and 001500633B14 DRTU Tool Version 1.1.3 Driver version 13.0.0.238 Sample: 1340

Run #	Mode	Channel		Measured Power	Test Performed	Limit	Result / Margin
Run # 1	n 20MHz Chain A	#1 2412MHz		13.1	Restricted Band Edge at 2400 MHz	15.209	53.1dBµV/m @ 2390.0MHz (-0.9dB)
		#11 2462MHz		12.4	Restricted Band Edge at 2483.5 MHz	15.209	51.4dBµV/m @ 2483.5MHz (-2.6dB)
Run # 2	n 20MHz Chain B	#1 2412MHz		12.9	Restricted Band Edge at 2400 MHz	15.209	49.3dBµV/m @ 2390.0MHz (-4.7dB)
		#11 2462MHz		12.8	Restricted Band Edge at 2483.5 MHz	15.209	49.8dBµV/m @ 2483.6MHz (-4.2dB)
Run # 3	n 20MHz Chain A	#2 2417MHz		16.1	Restricted Band Edge at 2400 MHz	15.209	53.3dBµV/m @ 2389.9MHz (-0.7dB)
		#10 2457MHz		16.0	Restricted Band Edge at 2483.5 MHz	15.209	52.3dBµV/m @ 2483.5MHz (-1.7dB)
Run # 4	n 20MHz Chain B	#2 2417MHz		16.7	Restricted Band Edge at 2400 MHz	15.209	51.2dBµV/m @ 2390.0MHz (-2.8dB)
		#10 2457MHz		16.7	Restricted Band Edge at 2483.5 MHz	15.209	51.6dBµV/m @ 2485.0MHz (-2.4dB)
Run # 5	802.11g Chain A	#1 2412MHz		14.0	Restricted Band Edge at 2400 MHz	15.209	52.3dBµV/m @ 2390.0MHz (-1.7dB)
		#11 2462MHz		14.1	Restricted Band Edge at 2483.5 MHz	15.209	51.8dBµV/m @ 2483.5MHz (-2.2dB)
Run # 6	802.11g Chain B	#1 2412MHz		14.0	Restricted Band Edge at 2400 MHz	15.209	49.2dBµV/m @ 2390.0MHz (-4.8dB)
		#11 2462MHz		14.2	Restricted Band Edge at 2483.5 MHz	15.209	51.5dBµV/m @ 2483.5MHz (-2.5dB)
Run # 7	802.11b Chain A	#1 2412MHz		15.8	Restricted Band Edge at 2400 MHz	15.209	43.9dBµV/m @ 2386.4MHz (-10.1dB)
		#11 2462MHz		15.5	Restricted Band Edge at 2483.5 MHz	15.209	44.3dBµV/m @ 2483.5MHz (-9.7dB)
Run # 8	802.11b Chain B	#1 2412MHz		15.8	Restricted Band Edge at 2400 MHz	15.209	46.4dBµV/m @ 2386.3MHz (-7.6dB)
		#11 2462MHz		15.8	Restricted Band Edge at 2483.5 MHz	15.209	41.4dBµV/m @ 2483.5MHz (-12.6dB)
Run # 9	n 20MHz Chain A+B	#1 2412MHz	A: 11.5 B: 11.5	A: 11.6 B: 11.6	Restricted Band Edge at 2390 MHz	15.209	48.9dBµV/m @ 2389.5MHz (-5.1dB)
		#11 2462MHz	A: 11.5 B: 11.5	A: 11.9 B: 11.7	Restricted Band Edge at 2483.5 MHz	15.209	52.5dBµV/m @ 2484.9MHz (-1.5dB)

Client:	Intel Corporation	Job Number:	J80050
Model:	62205ANHMW (Intel® Centrino® Advanced-N 6205)	T-Log Number:	T80123
		Account Manager:	Christine Krebil
Contact:	Steven Hackett		
Standard:	FCC 15.247 / FCC 15 E / RSS 210 / FCC 15 B	Class:	N/A

Note - the measured powers are the average powers (measured with average power sensor) and are used for reference purposes only. Power is set using " **GAIN CONTROL**" mode in the DRTU tool.

Test Specific Details

Objective: The objective of this test session is to perform engineering evaluation testing of the EUT with respect to the specification listed above.

General Test Configuration

The EUT was installed into a test fixture such that the EUT was exposed (i.e. outside of a host PC). For radiated emissions testing the measurement antenna was located 3 meters from the EUT.

Ambient Conditions:

Rel. Humidity: 15 - 55 %
Temperature: 18 - 25 °C

Modifications Made During Testing

No modifications were made to the EUT during testing

Deviations From The Standard

No deviations were made from the requirements of the standard.

Marker Delta Measurements

Three sets of marker deltas are measured using the following settings: RB=VB=100kHz; RB=1MHz,VB=1MHz; RB=1MHz, VB=10Hz. Marker deltas are made conducted (analyzer connected to EUT rf port a 20dB pad) for single chain operation and radiated (at a distance of ~ 50cm) for MIMO modes.

The fundamental field strength is always measured at a 3m test distance.

Client:	Intel Corporation	Job Number:	J80050
Model:	62205ANHMW (Intel® Centrino® Advanced-N 6205)	T-Log Number:	T80123
		Account Manager:	Christine Krebil
Contact:	Steven Hackett		
Standard:	FCC 15.247 / FCC 15 E / RSS 210 / FCC 15 B	Class:	N/A

Run # 1, Band Edge Field Strength - n 20MHz, Chain A

Date of Test: 8/3/2010

Test Location: Chamber #3

Test Engineer: Suhaila Khushzad

Config Change: none

Run # 1a, EUT on Channel #1 2412MHz - n 20MHz, Chain A

	Target (dBm)	Power Settings Measured (dBm)	Software Setting
Chain A	13.0	13.1	25.5

Fundamental Signal Field Strength

Frequency	Level	Pol	15.209 / 15.247		Detector	Azimuth	Height	Comments
MHz	dB μ V/m	v/h	Limit	Margin	PK/QP/Avg	degrees	meters	
2415.000	98.8	H	-	-	AVG	245	1.0	RB 1 MHz;VB 10 Hz;Pk
2416.330	106.9	H	-	-	PK	245	1.0	RB 1 MHz;VB 3 MHz;Pk
2415.470	94.9	V	-	-	AVG	230	1.8	RB 1 MHz;VB 10 Hz;Pk
2416.470	103.2	V	-	-	PK	230	1.8	RB 1 MHz;VB 3 MHz;Pk

2390 MHz Band Edge Signal Radiated Field Strength - Marker Delta

	H	V	
Fundamental emission level @ 3m in 1MHz RBW:	106.9	103.2	Peak Measurement (RB=VB=1MHz)
Fundamental emission level @ 3m in 1MHz RBW:	98.8	94.9	Average Measurement (RB=1MHz, VB=10Hz)
<i>Delta Marker - 100kHz</i>	<i>45.0 dB</i>		<- this can only be used if band edge signal is highest within 2MHz of band edge.
Calculated Band-Edge Measurement (Peak):	61.9 dB μ V/m		
Calculated Band-Edge Measurement (Avg):	53.8 dB μ V/m	Margin	Level
<i>Delta Marker - 1MHz/1MHz:</i>	<i>35.5 dB</i>	-0.9	53.1
<i>Delta Marker - 1MHz/10Hz:</i>	<i>45.7 dB</i>	-12.1	61.9
Calculated Band-Edge Measurement (Peak):	71.4 dB μ V/m	Using 100kHz delta value	
Calculated Band-Edge Measurement (Avg):	53.1 dB μ V/m	Using 1MHz delta value	

Frequency	Level	Pol	FCC 15.209		Detector	Azimuth	Height	Comments
MHz	dB μ V/m	v/h	Limit	Margin	PK/QP/Avg	degrees	meters	
2390.000	53.1	-	54.0	-0.9	Avg	-	-	Using 1MHz delta value

Client: Intel Corporation	Job Number: J80050
Model: 62205ANHMW (Intel® Centrino® Advanced-N 6205)	T-Log Number: T80123
	Account Manager: Christine Krebil
Contact: Steven Hackett	
Standard: FCC 15.247 / FCC 15 E / RSS 210 / FCC 15 B	Class: N/A

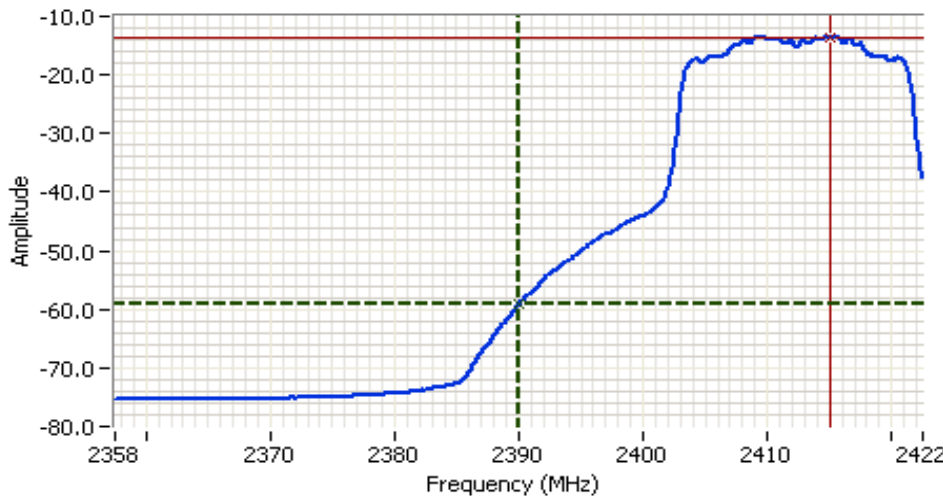

Analyzer Settings

HP8564E,EMI
 CF: 2390.000 MHz
 SPAN:65.000 MHz
 RB 1.000 MHz
 VB 10 Hz
 Detector Sample
 Att 10
 RL Offset 0.00
 Sweep Time 25.0s
 Ref Lvl:0.00DBM

Comments

BE @ 2390 MHz
 Avg-CH1

Cursor 1	2390.0000	-59.17	
Cursor 2	2415.1333	-13.50	

Delta Freq. 25.133
 Delta Amplitude 45.67



Client:	Intel Corporation	Job Number:	J80050
Model:	62205ANHMW (Intel® Centrino® Advanced-N 6205)	T-Log Number:	T80123
Contact:	Steven Hackett	Account Manager:	Christine Krebil
Standard:	FCC 15.247 / FCC 15 E / RSS 210 / FCC 15 B	Class:	N/A

Run # 1b, EUT on Channel #11 2462MHz - n 20MHz, Chain A

	Target (dBm)	Power Settings Measured (dBm)	Software Setting
Chain A	13.0	12.4	24.0

Fundamental Signal Field Strength

Frequency	Level	Pol	15.209 / 15.247		Detector	Azimuth	Height	Comments
MHz	dB μ V/m	v/h	Limit	Margin	PK/QP/Avg	degrees	meters	
2465.130	97.7	H	-	-	AVG	253	1.0	RB 1 MHz;VB 10 Hz;Pk
2464.600	105.8	H	-	-	PK	253	1.0	RB 1 MHz;VB 3 MHz;Pk
2465.400	93.0	V	-	-	AVG	231	1.8	RB 1 MHz;VB 10 Hz;Pk
2465.400	101.0	V	-	-	PK	231	1.8	RB 1 MHz;VB 3 MHz;Pk

2483.5 MHz Band Edge Signal Radiated Field Strength - Marker Delta

	H	V				
Fundamental emission level @ 3m in 1MHz RBW:	105.8	101.0	Peak Measurement (RB=VB=1MHz)			
Fundamental emission level @ 3m in 1MHz RBW:	97.7	93.0	Average Measurement (RB=1MHz, VB=10Hz)			
<i>Delta Marker - 100kHz</i>	46.3 dB		-< this can only be used if band edge signal is highest within 2MHz of band edge.			
Calculated Band-Edge Measurement (Peak):	59.5 dB μ V/m					
Calculated Band-Edge Measurement (Avg):	51.4 dB μ V/m		Margin	Level	Limit	Detector
<i>Delta Marker - 1MHz/1MHz:</i>	37.3 dB		-2.6	51.4	54	Avg
<i>Delta Marker - 1MHz/10Hz:</i>	45.7 dB		-14.5	59.5	74	Pk
Calculated Band-Edge Measurement (Peak):	68.5 dB μ V/m		Using 100kHz delta value			
Calculated Band-Edge Measurement (Avg):	52.0 dB μ V/m		Using 100kHz delta value			

Frequency	Level	Pol	FCC 15.209		Detector	Azimuth	Height	Comments
MHz	dB μ V/m	v/h	Limit	Margin	PK/QP/Avg	degrees	meters	
2483.500	51.4	-	54.0	-2.6	Avg	-	-	Using 100kHz delta value

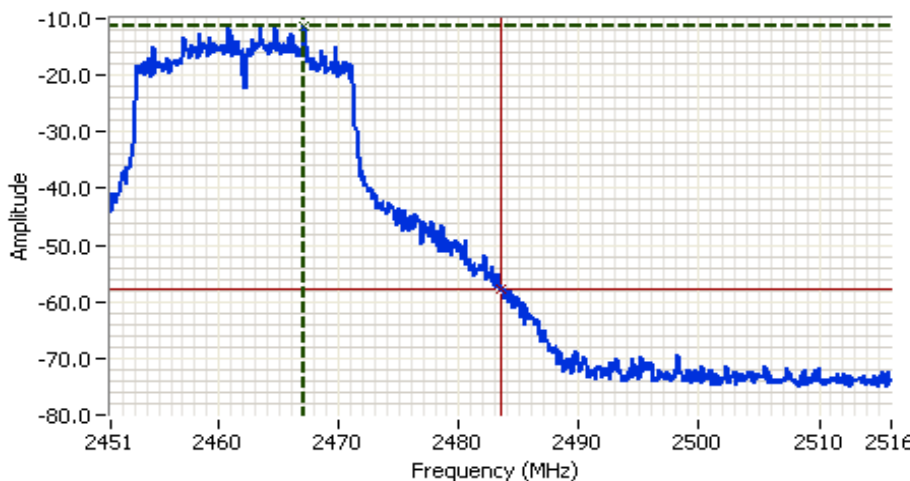

Analyzer Settings

HP8564E,EMI
 CF: 2483.500 MHz
 SPAN:65.000 MHz
 RB 100 kHz
 VB 100 kHz
 Detector POS
 Att 10
 RL Offset 0.00
 Sweep Time 50.0ms
 Ref Lvl:0.00DBM

Comments

BE @ 2483.5 MHz
 100kHz-CH1

Cursor 1	2467.1416	-11.33	Delta Freq.	16.358
Cursor 2	2483.5000	-57.67	Delta Amplitude	46.33



Client:	Intel Corporation	Job Number:	J80050
Model:	62205ANHMW (Intel® Centrino® Advanced-N 6205)	T-Log Number:	T80123
Contact:	Steven Hackett	Account Manager:	Christine Krebil
Standard:	FCC 15.247 / FCC 15 E / RSS 210 / FCC 15 B	Class:	N/A

Run # 2, Band Edge Field Strength - n 20MHz, Chain B

Date of Test: 8/3/2010

Test Location: Chamber #3

Test Engineer: Mehran Birgani

Config Change: none

Run # 2a, EUT on Channel #1 2412MHz - n 20MHz, Chain B

	Target (dBm)	Power Settings Measured (dBm)	Software Setting
Chain B	13.0	12.9	25.0

Fundamental Signal Field Strength

Frequency	Level	Pol	15.209 / 15.247		Detector	Azimuth	Height	Comments
MHz	dB μ V/m	v/h	Limit	Margin	PK/QP/Avg	degrees	meters	
2415.230	92.0	V	-	-	AVG	263	1.0	RB 1 MHz;VB 10 Hz;Pk
2414.470	100.3	V	-	-	PK	263	1.0	RB 1 MHz;VB 3 MHz;Pk
2415.230	96.1	H	-	-	AVG	194	1.0	RB 1 MHz;VB 10 Hz;Pk
2415.300	104.3	H	-	-	PK	194	1.0	RB 1 MHz;VB 3 MHz;Pk

2390 MHz Band Edge Signal Radiated Field Strength - Marker Delta

	H	V	
Fundamental emission level @ 3m in 1MHz RBW:	104.3	100.3	Peak Measurement (RB=VB=1MHz)
Fundamental emission level @ 3m in 1MHz RBW:	96.1	92.0	Average Measurement (RB=1MHz, VB=10Hz)
<i>Delta Marker - 100kHz</i>	<i>45.3 dB</i>		-< this can only be used if band edge signal is highest within 2MHz of band edge.
Calculated Band-Edge Measurement (Peak):	59.0 dB μ V/m		
Calculated Band-Edge Measurement (Avg):	50.8 dB μ V/m	Margin	Level
<i>Delta Marker - 1MHz/1MHz:</i>	<i>36.0 dB</i>	-4.7	49.3
<i>Delta Marker - 1MHz/10Hz:</i>	<i>46.8 dB</i>	-15.0	59.0
Calculated Band-Edge Measurement (Peak):	68.3 dB μ V/m	Using 100kHz delta value	
Calculated Band-Edge Measurement (Avg):	49.3 dB μ V/m	Using 1MHz delta value	

Frequency	Level	Pol	FCC 15.209		Detector	Azimuth	Height	Comments
MHz	dB μ V/m	v/h	Limit	Margin	PK/QP/Avg	degrees	meters	
2390.000	49.3	-	54.0	-4.7	Avg	-	-	Using 1MHz delta value

Client: Intel Corporation	Job Number: J80050
Model: 62205ANHMW (Intel® Centrino® Advanced-N 6205)	T-Log Number: T80123
	Account Manager: Christine Krebil
Contact: Steven Hackett	
Standard: FCC 15.247 / FCC 15 E / RSS 210 / FCC 15 B	Class: N/A

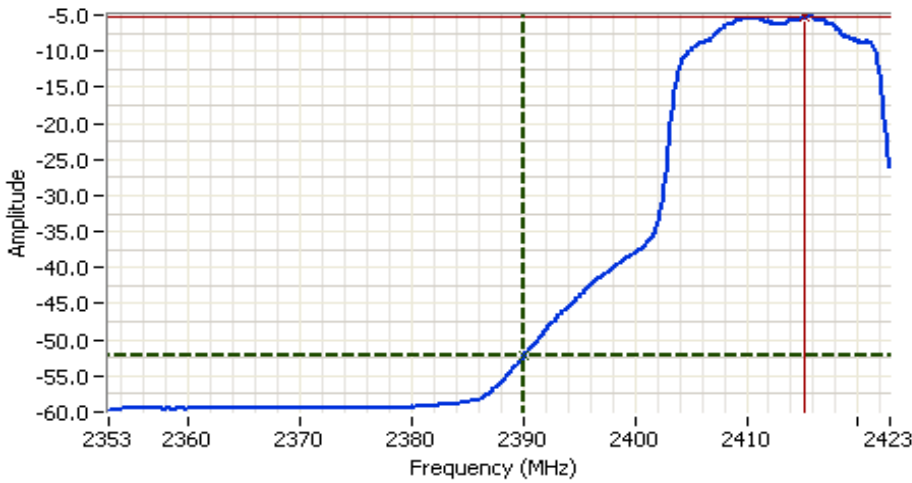

Analyzer Settings
 HP8564E,EMICF: 2387.850 MHz
 SPAN: 70.000 MHz
 RB: 1.000 MHz
 VB: 10 Hz
 Detector: Sample
 Attn: 20 DB
 RL Offset: 10.0 DB
 Sweep Time: 2.0s
 Ref Lvl: 14.3 DBM

Comments

Cursor 1	2390.0667	-52.20	
Cursor 2	2415.2666	-5.37	

Delta Freq. 25.200
 Delta Amplitude 46.83



Client:	Intel Corporation	Job Number:	J80050
Model:	62205ANHMW (Intel® Centrino® Advanced-N 6205)	T-Log Number:	T80123
Contact:	Steven Hackett	Account Manager:	Christine Krebil
Standard:	FCC 15.247 / FCC 15 E / RSS 210 / FCC 15 B	Class:	N/A

Run # 2b, EUT on Channel #11 2462MHz - n 20MHz, Chain B

	Target (dBm)	Power Settings Measured (dBm)	Software Setting
Chain B	13.0	12.8	25.0

Fundamental Signal Field Strength

Frequency	Level	Pol	15.209 / 15.247		Detector	Azimuth	Height	Comments
MHz	dB μ V/m	v/h	Limit	Margin	PK/QP/Avg	degrees	meters	
2463.470	87.8	V	-	-	AVG	198	1.0	RB 1 MHz;VB 10 Hz;Pk
2463.900	96.1	V	-	-	PK	198	1.0	RB 1 MHz;VB 3 MHz;Pk
2460.730	96.5	H	-	-	AVG	192	1.0	RB 1 MHz;VB 10 Hz;Pk
2460.900	104.7	H	-	-	PK	192	1.0	RB 1 MHz;VB 3 MHz;Pk

2483.5 MHz Band Edge Signal Radiated Field Strength - Marker Delta

	H	V				
Fundamental emission level @ 3m in 1MHz RBW:	104.7	96.1	Peak Measurement (RB=VB=1MHz)			
Fundamental emission level @ 3m in 1MHz RBW:	96.5	87.8	Average Measurement (RB=1MHz, VB=10Hz)			
<i>Delta Marker - 100kHz</i>	46.7	96.1	-< this can only be used if band edge signal is highest within 2MHz of band edge.			
Calculated Band-Edge Measurement (Peak):	58.0 dB μ V/m		Margin	Level	Limit	Detector
Calculated Band-Edge Measurement (Avg):	49.8 dB μ V/m		-4.2	49.8	54	Avg
<i>Delta Marker - 1MHz/1MHz:</i>	37.7 dB		-16.0	58.0	74	Pk
<i>Delta Marker - 1MHz/10Hz:</i>	45.0 dB					
Calculated Band-Edge Measurement (Peak):	67.0 dB μ V/m		Using 100kHz delta value			
Calculated Band-Edge Measurement (Avg):	51.5 dB μ V/m		Using 100kHz delta value			

Frequency	Level	Pol	FCC 15.209		Detector	Azimuth	Height	Comments
MHz	dB μ V/m	v/h	Limit	Margin	PK/QP/Avg	degrees	meters	
2483.583	49.8	-	54.0	-4.2	Avg	-	-	Using 100kHz delta value

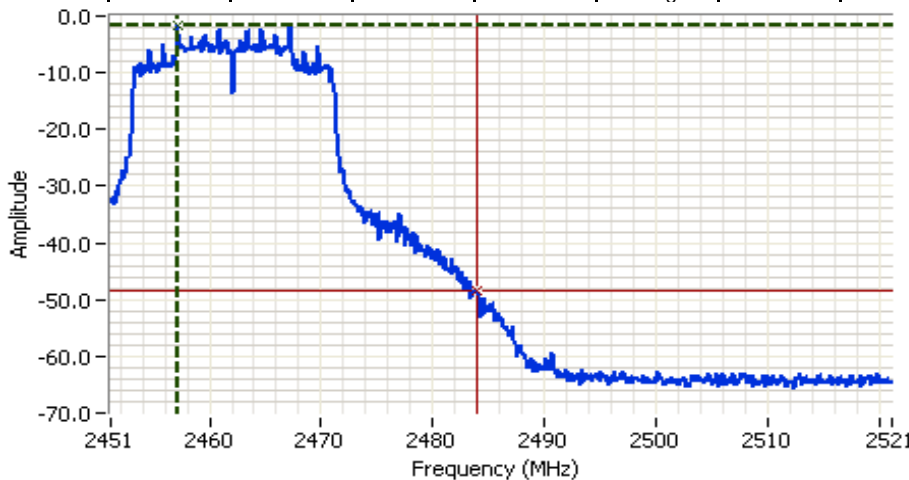

Analyzer Settings
 HP8564E,EMICF: 2486.150 MHz
 SPAN: 70.000 MHz
 RB: 100 kHz
 VB: 100 kHz
 Detector: POS
 Attn: 10 DB
 RL Offset: 10.0 DB
 Sweep Time: 2.0s
 Ref Lvl: 8.5 DBM

Comments

Cursor 1	2457.1001	-1.67	Delta Freq.	26.833
Cursor 2	2483.9333	-48.33	Delta Amplitude	46.67



Client:	Intel Corporation	Job Number:	J80050
Model:	62205ANHMW (Intel® Centrino® Advanced-N 6205)	T-Log Number:	T80123
Contact:	Steven Hackett	Account Manager:	Christine Krebil
Standard:	FCC 15.247 / FCC 15 E / RSS 210 / FCC 15 B	Class:	N/A

Run # 3, Band Edge Field Strength - n 20MHz, Chain A
Run # 3a, EUT on Channel #2 2417MHz - n 20MHz, Chain A

Date of Test: 8/10/2010 Test Location: Chamber #3
Test Engineer: Mehran Birgani Config Change: none

	Target (dBm)	Power Settings Measured (dBm)	Software Setting
Chain A	16.0	16.1	31.0

Fundamental Signal Field Strength

Frequency	Level	Pol	15.209 / 15.247		Detector	Azimuth	Height	Comments
MHz	dBuV/m	v/h	Limit	Margin	PK/QP/Avg	degrees	meters	
2420.230	94.3	V	-	-	AVG	232	1.9	POS; RB 1 MHz; VB: 10 Hz
2418.540	102.3	V	-	-	PK	232	1.9	POS; RB 1 MHz; VB: 10 MHz
2413.970	100.1	H	-	-	AVG	320	1.3	RB 1 MHz;VB 10 Hz;Pk
2414.200	108.2	H	-	-	PK	320	1.3	RB 1 MHz;VB 3 MHz;Pk

2390 MHz Band Edge Signal Radiated Field Strength - Marker Delta

	H	V	
Fundamental emission level @ 3m in 1MHz RBW:	108.2	102.3	Peak Measurement (RB=VB=1MHz)
Fundamental emission level @ 3m in 1MHz RBW:	100.1	94.3	Average Measurement (RB=1MHz, VB=10Hz)
<i>Delta Marker - 100kHz</i>	45.5 dB		-< this can only be used if band edge signal is highest within 2MHz of band edge.
Calculated Band-Edge Measurement (Peak):	62.7 dBuV/m		
Calculated Band-Edge Measurement (Avg):	54.6 dBuV/m	Margin	Level
<i>Delta Marker - 1MHz/1MHz:</i>	40.2 dB	-0.7	53.3
<i>Delta Marker - 1MHz/10Hz:</i>	46.8 dB	-11.3	62.7
Calculated Band-Edge Measurement (Peak):	68.0 dBuV/m	Using 100kHz delta value	
Calculated Band-Edge Measurement (Avg):	53.3 dBuV/m	Using 1MHz delta value	

Frequency	Level	Pol	FCC 15.209		Detector	Azimuth	Height	Comments
MHz	dBuV/m	v/h	Limit	Margin	PK/QP/Avg	degrees	meters	
2389.875	53.3	-	54.0	-0.7	Avg	-	-	Using 1MHz delta value

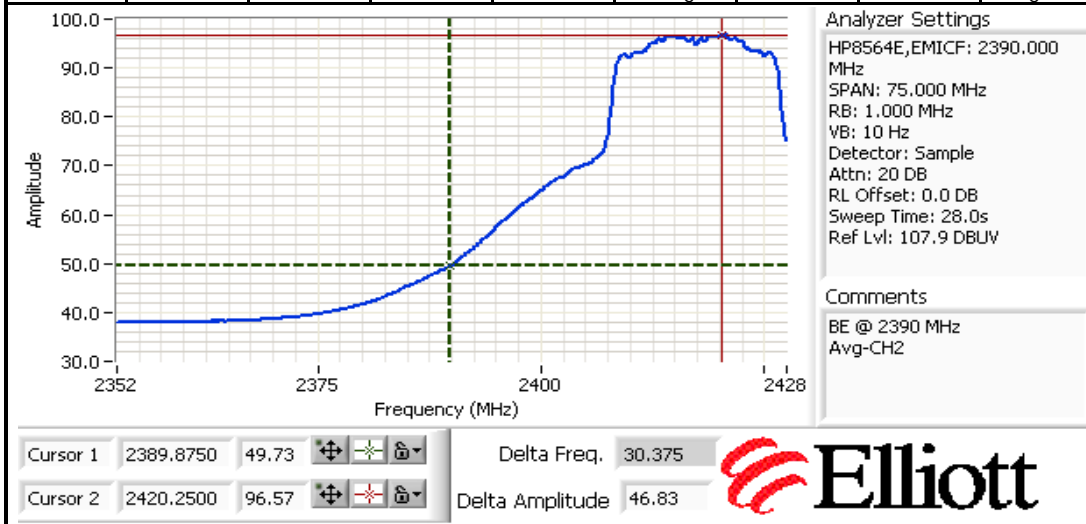

Client:	Intel Corporation	Job Number:	J80050
Model:	62205ANHMW (Intel® Centrino® Advanced-N 6205)	T-Log Number:	T80123
Contact:	Steven Hackett	Account Manager:	Christine Krebil
Standard:	FCC 15.247 / FCC 15 E / RSS 210 / FCC 15 B	Class:	N/A

Run # 3b, EUT on Channel #10 2457MHz - n 20MHz, Chain A

	Target (dBm)	Power Settings Measured (dBm)	Software Setting
Chain A	16.5	16.0	29.0

Fundamental Signal Field Strength

Frequency	Level	Pol	15.209 / 15.247		Detector	Azimuth	Height	Comments
MHz	dB μ V/m	v/h	Limit	Margin	PK/QP/Avg	degrees	meters	
2455.510	101.1	H	-	-	AVG	249	1.4	RB 1 MHz;VB 10 Hz;Pk
2455.880	107.8	H	-	-	PK	249	1.4	RB 1 MHz;VB 3 MHz;Pk
2453.900	96.3	V	-	-	AVG	168	1.0	RB 1 MHz;VB 10 Hz;Pk
2454.070	104.6	V	-	-	PK	168	1.0	RB 1 MHz;VB 3 MHz;Pk

2483.5 MHz Band Edge Signal Radiated Field Strength - Marker Delta

	H	V				
Fundamental emission level @ 3m in 1MHz RBW:	107.8	104.6	Peak Measurement (RB=VB=1MHz)			
Fundamental emission level @ 3m in 1MHz RBW:	101.1	96.3	Average Measurement (RB=1MHz, VB=10Hz)			
<i>Delta Marker - 100kHz</i>			47.2 dB			
Calculated Band-Edge Measurement (Peak):			60.6 dB μ V/m			
Calculated Band-Edge Measurement (Avg):			53.9 dB μ V/m			
<i>Delta Marker - 1MHz/1MHz:</i>			41.8 dB			
<i>Delta Marker - 1MHz/10Hz:</i>			48.8 dB			
Calculated Band-Edge Measurement (Peak):			66.0 dB μ V/m			
Calculated Band-Edge Measurement (Avg):			52.3 dB μ V/m			
	Margin	Level	Limit	Detector		
	-1.7	52.3	54	Avg		
	-13.4	60.6	74	Pk		
	Using 100kHz delta value					
	Using 1MHz delta value					

Frequency	Level	Pol	FCC 15.209		Detector	Azimuth	Height	Comments
MHz	dB μ V/m	v/h	Limit	Margin	PK/QP/Avg	degrees	meters	
2483.500	52.3	-	54.0	-1.7	Avg	-	-	Using 1MHz delta value

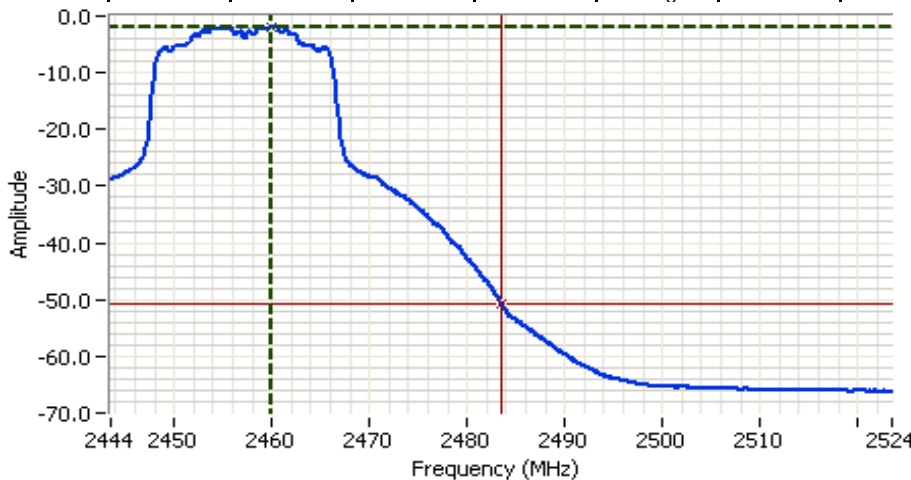

Analyzer Settings
 HP8564E,EMICF: 2483.500 MHz
 SPAN: 80.000 MHz
 RB: 1.000 MHz
 VB: 10 Hz
 Detector: Sample
 Attn: 10 DB
 RL Offset: 10.0 DB
 Sweep Time: 30.0s
 Ref Lvl: 8.3 DBM

Comments

Cursor 1	2460.0334	-1.87	Delta Freq.	23.467
Cursor 2	2483.5000	-50.70	Delta Amplitude	48.83



Client:	Intel Corporation	Job Number:	J80050
Model:	62205ANHMW (Intel® Centrino® Advanced-N 6205)	T-Log Number:	T80123
Contact:	Steven Hackett	Account Manager:	Christine Krebil
Standard:	FCC 15.247 / FCC 15 E / RSS 210 / FCC 15 B	Class:	N/A

Run # 4, Band Edge Field Strength - n 20MHz, Chain B

Date of Test: 8/3/2010

Test Location: Chamber #3

Test Engineer: Mehran Birgani

Config Change: none

Run # 4a, EUT on Channel #2 2417MHz - n 20MHz, Chain B

	Target (dBm)	Power Settings Measured (dBm)	Software Setting
Chain B	16.5	16.7	29.5

Fundamental Signal Field Strength

Frequency	Level	Pol	15.209 / 15.247		Detector	Azimuth	Height	Comments
MHz	dB μ V/m	v/h	Limit	Margin	Pk/QP/Avg	degrees	meters	
2413.870	94.8	V	-	-	AVG	96	1.0	RB 1 MHz;VB 10 Hz;Pk
2413.170	103.1	V	-	-	PK	96	1.0	RB 1 MHz;VB 3 MHz;Pk
2419.970	100.5	H	-	-	AVG	193	1.0	RB 1 MHz;VB 10 Hz;Pk
2420.370	109.0	H	-	-	PK	193	1.0	RB 1 MHz;VB 3 MHz;Pk

2390 MHz Band Edge Signal Radiated Field Strength - Marker Delta

	H	V	
Fundamental emission level @ 3m in 1MHz RBW:	109.0	103.1	Peak Measurement (RB=VB=1MHz)
Fundamental emission level @ 3m in 1MHz RBW:	100.5	94.8	Average Measurement (RB=1MHz, VB=10Hz)
<i>Delta Marker - 100kHz</i>	48.3 dB		-< this can only be used if band edge signal is highest within 2MHz of band edge.
Calculated Band-Edge Measurement (Peak):	60.7 dB μ V/m		
Calculated Band-Edge Measurement (Avg):	52.2 dB μ V/m	Margin	Level
<i>Delta Marker - 1MHz/1MHz:</i>	41.0 dB	-2.8	51.2
<i>Delta Marker - 1MHz/10Hz:</i>	49.3 dB	-13.3	60.7
Calculated Band-Edge Measurement (Peak):	68.0 dB μ V/m	Using 100kHz delta value	
Calculated Band-Edge Measurement (Avg):	51.2 dB μ V/m	Using 1MHz delta value	

Frequency	Level	Pol	FCC 15.209		Detector	Azimuth	Height	Comments
MHz	dB μ V/m	v/h	Limit	Margin	Pk/QP/Avg	degrees	meters	
2390.000	51.2	-	54.0	-2.8	Avg	-	-	Using 1MHz delta value

Client: Intel Corporation	Job Number: J80050
Model: 62205ANHMW (Intel® Centrino® Advanced-N 6205)	T-Log Number: T80123
	Account Manager: Christine Krebil
Contact: Steven Hackett	
Standard: FCC 15.247 / FCC 15 E / RSS 210 / FCC 15 B	Class: N/A

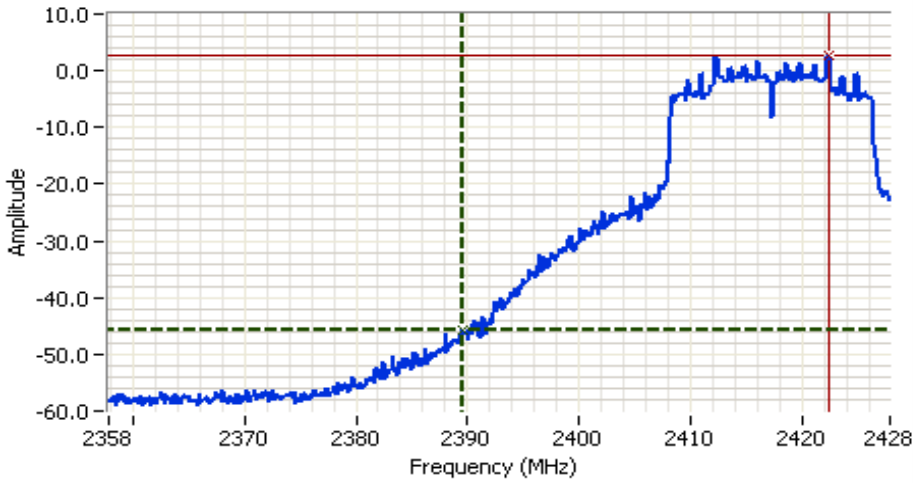

Analyzer Settings

HP8564E,EMICF: 2392.850 MHz
 SPAN: 70.000 MHz
 RB: 100 kHz
 VB: 100 kHz
 Detector: POS
 Attn: 20 DB
 RL Offset: 10.0 DB
 Sweep Time: 2.0s
 Ref Lvl: 13.6 DBM

Comments

Cursor 1	2389.5833	-45.73	⊕ ⊖	Delta Freq.	32.783
Cursor 2	2422.3667	2.60	⊕ ⊖	Delta Amplitude	48.33



Client:	Intel Corporation	Job Number:	J80050
Model:	62205ANHMW (Intel® Centrino® Advanced-N 6205)	T-Log Number:	T80123
Contact:	Steven Hackett	Account Manager:	Christine Krebil
Standard:	FCC 15.247 / FCC 15 E / RSS 210 / FCC 15 B	Class:	N/A

Run # 4b, EUT on Channel #10 2457MHz - n 20MHz, Chain B

Date of Test: 8/3/2010 Test Location: FT Chamber #3
 Test Engineer: Rafael Varelas Config Change: none

	Target (dBm)	Power Settings Measured (dBm)	Software Setting
Chain B	16.5	16.7	29.5

Fundamental Signal Field Strength

Frequency	Level	Pol	15.209 / 15.247		Detector	Azimuth	Height	Comments
MHz	dBμV/m	v/h	Limit	Margin	Pk/QP/Avg	degrees	meters	
2453.930	92.9	V	-	-	AVG	316	1.0	RB 1 MHz;VB 10 Hz;Pk
2452.130	100.9	V	-	-	PK	316	1.0	RB 1 MHz;VB 3 MHz;Pk
2459.930	100.3	H	-	-	AVG	194	1.0	RB 1 MHz;VB 10 Hz;Pk
2461.370	108.5	H	-	-	PK	194	1.0	RB 1 MHz;VB 3 MHz;Pk

2483.5 MHz Band Edge Signal Radiated Field Strength - Marker Delta

	H	V		Margin	Level	Limit	Detector
Fundamental emission level @ 3m in 1MHz RBW:	108.5	100.9					
Fundamental emission level @ 3m in 1MHz RBW:	100.3	92.9					
<i>Delta Marker - 100kHz</i>	48.7 dB						
Calculated Band-Edge Measurement (Peak):	59.8 dBuV/m						
Calculated Band-Edge Measurement (Avg):	51.6 dBuV/m						
<i>Delta Marker - 1MHz/1MHz:</i>	38.8 dB		-2.4	51.6	54	Avg	
<i>Delta Marker - 1MHz/10Hz:</i>	47.5 dB		-14.2	59.8	74	Pk	
Calculated Band-Edge Measurement (Peak):	69.7 dBuV/m						Using 100kHz delta value
Calculated Band-Edge Measurement (Avg):	52.8 dBuV/m						Using 100kHz delta value

Peak Measurement (RB=VB=1MHz)
 Average Measurement (RB=1MHz, VB=10Hz)
 <- this can only be used if band edge signal is highest within 2MHz of band edge.

Frequency	Level	Pol	FCC 15.209		Detector	Azimuth	Height	Comments
MHz	dBμV/m	v/h	Limit	Margin	Pk/QP/Avg	degrees	meters	
2485.000	51.6	-	54.0	-2.4	Avg	-	-	Using 100kHz delta value

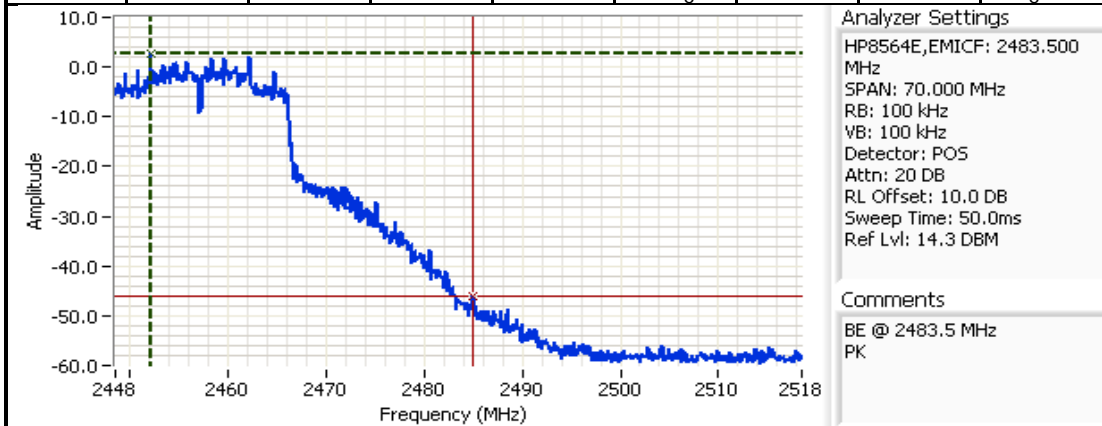

Analyzer Settings
 HP8564E,EMICF: 2483.500 MHz
 SPAN: 70.000 MHz
 RB: 100 kHz
 VB: 100 kHz
 Detector: POS
 Attn: 20 DB
 RL Offset: 10.0 DB
 Sweep Time: 50.0ms
 Ref Lvl: 14.3 DBM

Comments
 BE @ 2483.5 MHz
 PK

Cursor 1	2452.1167	2.63	Delta Freq.	32.900
Cursor 2	2485.0166	-46.03	Delta Amplitude	48.67



Client:	Intel Corporation	Job Number:	J80050
Model:	62205ANHMW (Intel® Centrino® Advanced-N 6205)	T-Log Number:	T80123
Contact:	Steven Hackett	Account Manager:	Christine Krebil
Standard:	FCC 15.247 / FCC 15 E / RSS 210 / FCC 15 B	Class:	N/A

Run # 5, Band Edge Field Strength - 802.11g, Chain A

Date of Test: 8/3/2010

Test Location: FT Chamber #3

Test Engineer: Rafael Varelas

Config Change: none

Run # 5a, EUT on Channel #1 2412MHz - 802.11g, Chain A

	Target (dBm)	Power Settings Measured (dBm)	Software Setting
Chain A	14.0	14.0	26.5

Fundamental Signal Field Strength

Frequency	Level	Pol	15.209 / 15.247		Detector	Azimuth	Height	Comments
MHz	dBuV/m	v/h	Limit	Margin	PK/QP/Avg	degrees	meters	
2414.930	93.7	V	-	-	AVG	163	1.0	RB 1 MHz;VB 10 Hz;Pk
2415.400	101.9	V	-	-	PK	163	1.0	RB 1 MHz;VB 3 MHz;Pk
2415.130	96.3	H	-	-	AVG	342	1.0	RB 1 MHz;VB 10 Hz;Pk
2416.430	104.4	H	-	-	PK	342	1.0	RB 1 MHz;VB 3 MHz;Pk

2390 MHz Band Edge Signal Radiated Field Strength - Marker Delta

	H	V		Margin	Level	Limit	Detector
Fundamental emission level @ 3m in 1MHz RBW:	104.4	101.9					
Fundamental emission level @ 3m in 1MHz RBW:	96.3	93.7					
<i>Delta Marker - 100kHz</i>	43.0 dB						
Calculated Band-Edge Measurement (Peak):	61.4 dBuV/m						
Calculated Band-Edge Measurement (Avg):	53.3 dBuV/m						
<i>Delta Marker - 1MHz/1MHz:</i>	34.0 dB		-1.7		52.3	54	Avg
<i>Delta Marker - 1MHz/10Hz:</i>	44.0 dB		-12.6		61.4	74	Pk
Calculated Band-Edge Measurement (Peak):	70.4 dBuV/m						Using 100kHz delta value
Calculated Band-Edge Measurement (Avg):	52.3 dBuV/m						Using 1MHz delta value

Peak Measurement (RB=VB=1MHz)
Average Measurement (RB=1MHz, VB=10Hz)
-< this can only be used if band edge signal is highest within 2MHz of band edge.

Frequency	Level	Pol	FCC 15.209		Detector	Azimuth	Height	Comments
MHz	dBuV/m	v/h	Limit	Margin	PK/QP/Avg	degrees	meters	
2390.000	52.3	-	54.0	-1.7	Avg	-	-	Using 1MHz delta value

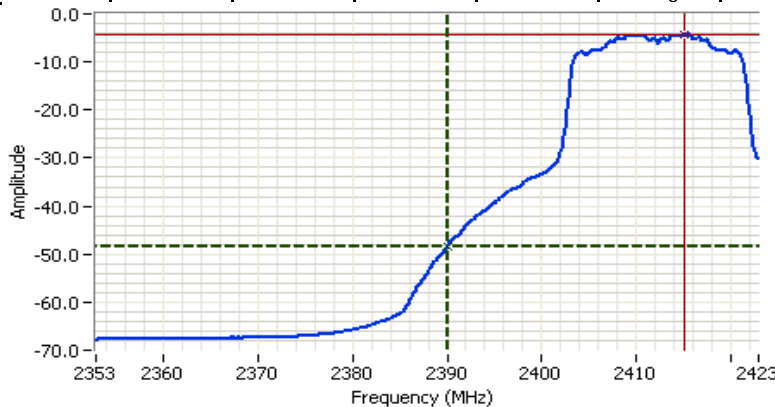

Analyzer Settings
 HP8564E,EMICF: 2387.900
 MHz
 SPAN: 70.000 MHz
 RB: 1.000 MHz
 VB: 10 Hz
 Detector: Sample
 Attn: 10 DB
 RL Offset: 10.0 DB
 Sweep Time: 26.0s
 Ref Lvl: -1.5 DBM

Comments

Cursor 1	2390.0000	-48.33	Delta Freq.	25.083
Cursor 2	2415.0833	-4.33	Delta Amplitude	44.00



Client:	Intel Corporation	Job Number:	J80050
Model:	62205ANHMW (Intel® Centrino® Advanced-N 6205)	T-Log Number:	T80123
Contact:	Steven Hackett	Account Manager:	Christine Krebil
Standard:	FCC 15.247 / FCC 15 E / RSS 210 / FCC 15 B	Class:	N/A

Run # 5b, EUT on Channel #11 2462MHz - 802.11g, Chain A

	Target (dBm)	Power Settings Measured (dBm)	Software Setting
Chain A	14.0	14.1	26.0

Fundamental Signal Field Strength

Frequency	Level	Pol	15.209 / 15.247		Detector	Azimuth	Height	Comments
MHz	dB μ V/m	v/h	Limit	Margin	PK/QP/Avg	degrees	meters	
2459.670	94.0	V	-	-	AVG	235	1.0	RB 1 MHz;VB 10 Hz;Pk
2464.600	102.2	V	-	-	PK	235	1.0	RB 1 MHz;VB 3 MHz;Pk
2466.570	98.0	H	-	-	AVG	258	1.0	RB 1 MHz;VB 10 Hz;Pk
2465.070	106.2	H	-	-	PK	258	1.0	RB 1 MHz;VB 3 MHz;Pk

2483.5 MHz Band Edge Signal Radiated Field Strength - Marker Delta

	H	V				
Fundamental emission level @ 3m in 1MHz RBW:	106.2	102.2	Peak Measurement (RB=VB=1MHz)			
Fundamental emission level @ 3m in 1MHz RBW:	98.0	94.0	Average Measurement (RB=1MHz, VB=10Hz)			
<i>Delta Marker - 100kHz</i>			<i>45.3 dB</i>			
Calculated Band-Edge Measurement (Peak):			60.9 dB μ V/m			
Calculated Band-Edge Measurement (Avg):			52.7 dB μ V/m			
<i>Delta Marker - 1MHz/1MHz:</i>			<i>37.7 dB</i>			
<i>Delta Marker - 1MHz/10Hz:</i>			<i>46.2 dB</i>			
Calculated Band-Edge Measurement (Peak):			68.5 dB μ V/m			
Calculated Band-Edge Measurement (Avg):			51.8 dB μ V/m			
	Margin	Level	Limit	Detector		
	-2.2	51.8	54	Avg		
	-13.1	60.9	74	Pk		
	Using 100kHz delta value					
	Using 1MHz delta value					

Frequency	Level	Pol	FCC 15.209		Detector	Azimuth	Height	Comments
MHz	dB μ V/m	v/h	Limit	Margin	PK/QP/Avg	degrees	meters	
2483.500	51.8	-	54.0	-2.2	Avg	-	-	Using 1MHz delta value

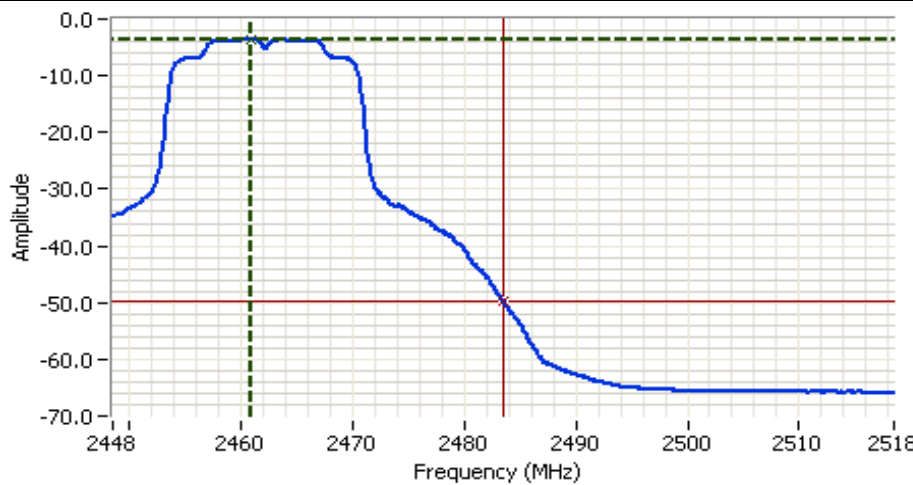

Analyzer Settings

HP8564E,EMICF: 2483.500 MHz
 SPAN: 70.000 MHz
 RB: 1.000 MHz
 VB: 10 Hz
 Detector: Sample
 Attn: 10 DB
 RL Offset: 10.0 DB
 Sweep Time: 26.0s
 Ref Lvl: 9.6 DBM

Comments

BE @ 2483.5 MHz
Avg

Cursor 1	2460.8667	-3.57		Delta Freq.	22.633
Cursor 2	2483.5000	-49.73		Delta Amplitude	46.17



Client:	Intel Corporation	Job Number:	J80050
Model:	62205ANHMW (Intel® Centrino® Advanced-N 6205)	T-Log Number:	T80123
Contact:	Steven Hackett	Account Manager:	Christine Krebil
Standard:	FCC 15.247 / FCC 15 E / RSS 210 / FCC 15 B	Class:	N/A

Run # 6, Band Edge Field Strength - 802.11g, Chain B

Date of Test: 8/3/2010

Test Location: FT Chamber #3

Test Engineer: Rafael Varelas

Config Change: none

Run # 6a, EUT on Channel #1 2412MHz - 802.11g, Chain B

	Target (dBm)	Power Settings Measured (dBm)	Software Setting
Chain B	14.0	14.0	26.0

Fundamental Signal Field Strength

Frequency	Level	Pol	15.209 / 15.247		Detector	Azimuth	Height	Comments
MHz	dB μ V/m	v/h	Limit	Margin	Pk/QP/Avg	degrees	meters	
2414.900	92.6	V	-	-	AVG	263	1.0	RB 1 MHz;VB 10 Hz;Pk
2416.500	100.8	V	-	-	PK	263	1.0	RB 1 MHz;VB 3 MHz;Pk
2410.300	98.2	H	-	-	AVG	24	1.0	RB 1 MHz;VB 10 Hz;Pk
2415.130	106.3	H	-	-	PK	24	1.0	RB 1 MHz;VB 3 MHz;Pk

2390 MHz Band Edge Signal Radiated Field Strength - Marker Delta

	H	V	
Fundamental emission level @ 3m in 1MHz RBW:	106.3	100.8	Peak Measurement (RB=VB=1MHz)
Fundamental emission level @ 3m in 1MHz RBW:	98.2	92.6	Average Measurement (RB=1MHz, VB=10Hz)
<i>Delta Marker - 100kHz</i>	48.2 dB		-< this can only be used if band edge signal is highest within 2MHz of band edge.
Calculated Band-Edge Measurement (Peak):	58.1 dB μ V/m		
Calculated Band-Edge Measurement (Avg):	50.0 dB μ V/m	Margin	Level
<i>Delta Marker - 1MHz/1MHz:</i>	40.3 dB	-4.8	49.2
<i>Delta Marker - 1MHz/10Hz:</i>	49.0 dB	-15.9	58.1
Calculated Band-Edge Measurement (Peak):	66.0 dB μ V/m	Using 100kHz delta value	
Calculated Band-Edge Measurement (Avg):	49.2 dB μ V/m	Using 1MHz delta value	

Frequency	Level	Pol	FCC 15.209		Detector	Azimuth	Height	Comments
MHz	dB μ V/m	v/h	Limit	Margin	Pk/QP/Avg	degrees	meters	
2390.000	49.2	-	54.0	-4.8	Avg	-	-	Using 1MHz delta value

Client: Intel Corporation	Job Number: J80050
Model: 62205ANHMW (Intel® Centrino® Advanced-N 6205)	T-Log Number: T80123
	Account Manager: Christine Krebil
Contact: Steven Hackett	
Standard: FCC 15.247 / FCC 15 E / RSS 210 / FCC 15 B	Class: N/A

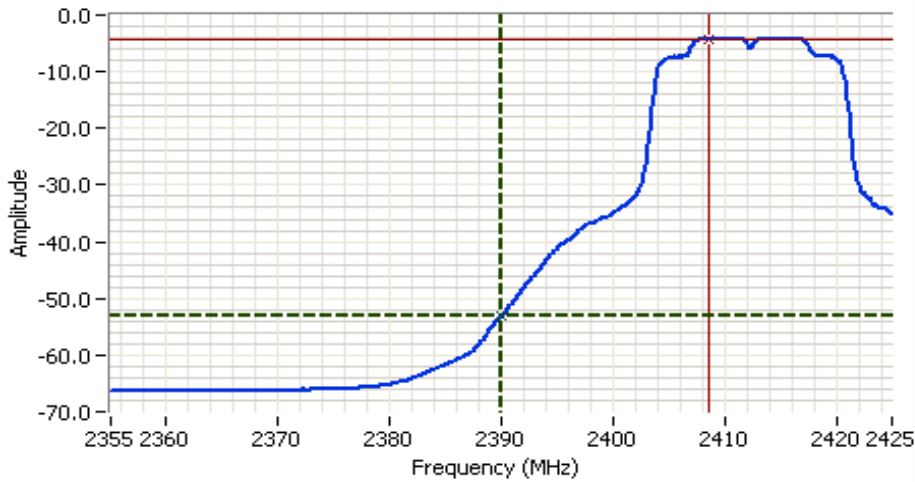

Analyzer Settings

HP8564E,EMICF: 2390.000 MHz
 SPAN: 70.000 MHz
 RB: 1.000 MHz
 VB: 10 Hz
 Detector: Sample
 Attn: 10 DB
 RL Offset: 10.0 DB
 Sweep Time: 26.0s
 Ref Lvl: 9.6 DBM

Comments

BE @ 2390 MHz
 Avg

Cursor 1	2390.0000	-53.23	Delta Freq.	18.550
Cursor 2	2408.5500	-4.23	Delta Amplitude	49.00



Client:	Intel Corporation	Job Number:	J80050
Model:	62205ANHMW (Intel® Centrino® Advanced-N 6205)	T-Log Number:	T80123
Contact:	Steven Hackett	Account Manager:	Christine Krebil
Standard:	FCC 15.247 / FCC 15 E / RSS 210 / FCC 15 B	Class:	N/A

Run # 6b, EUT on Channel #11 2462MHz - 802.11g, Chain B

	Target (dBm)	Power Settings Measured (dBm)	Software Setting
Chain B	14.0	14.2	26.5

Fundamental Signal Field Strength

Frequency MHz	Level dBμV/m	Pol v/h	15.209 / 15.247		Detector PK/QP/Avg	Azimuth degrees	Height meters	Comments
			Limit	Margin				
2457.500	88.8	V	-	-	AVG	315	1.0	RB 1 MHz;VB 10 Hz;Pk
2458.200	96.7	V	-	-	PK	315	1.0	RB 1 MHz;VB 3 MHz;Pk
2466.570	98.3	H	-	-	AVG	196	1.0	RB 1 MHz;VB 10 Hz;Pk
2465.470	106.4	H	-	-	PK	196	1.0	RB 1 MHz;VB 3 MHz;Pk

2483.5 MHz Band Edge Signal Radiated Field Strength - Marker Delta

	H	V		Margin	Level	Limit	Detector
Fundamental emission level @ 3m in 1MHz RBW:	106.4	96.7					Peak Measurement (RB=VB=1MHz)
Fundamental emission level @ 3m in 1MHz RBW:	98.3	88.8					Average Measurement (RB=1MHz, VB=10Hz)
<i>Delta Marker - 100kHz</i>	45.2 dB						-< this can only be used if band edge signal is highest within 2MHz of band edge.
Calculated Band-Edge Measurement (Peak):	61.2 dBuV/m						
Calculated Band-Edge Measurement (Avg):	53.1 dBuV/m						
<i>Delta Marker - 1MHz/1MHz:</i>	39.8 dB			-2.5	51.5	54	Avg
<i>Delta Marker - 1MHz/10Hz:</i>	46.8 dB			-12.8	61.2	74	Pk
Calculated Band-Edge Measurement (Peak):	66.6 dBuV/m						Using 100kHz delta value
Calculated Band-Edge Measurement (Avg):	51.5 dBuV/m						Using 1MHz delta value

Frequency MHz	Level dBμV/m	Pol v/h	FCC 15.209		Detector PK/QP/Avg	Azimuth degrees	Height meters	Comments
			Limit	Margin				
2483.500	51.5	-	54.0	-2.5	Avg	-	-	Using 1MHz delta value

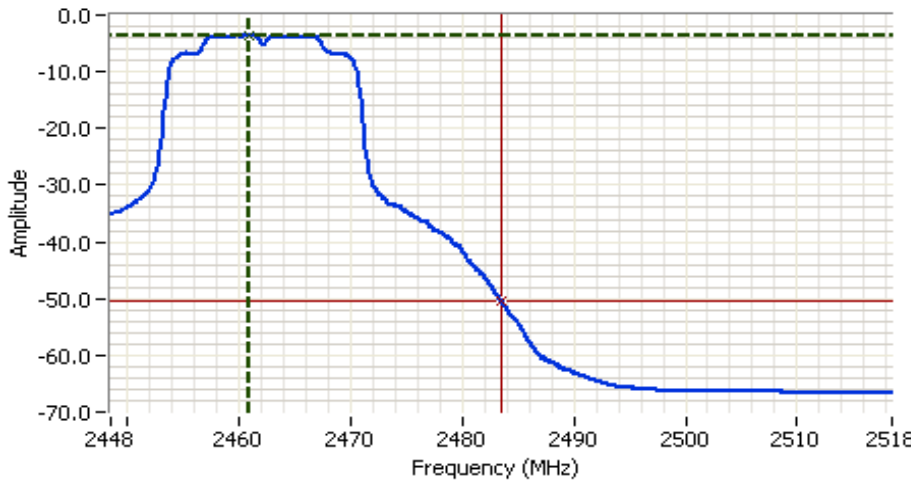

Analyzer Settings

HP8564E,EMICF: 2483.500 MHz
 SPAN: 70.000 MHz
 RB: 1.000 MHz
 VB: 10 Hz
 Detector: Sample
 Attn: 10 DB
 RL Offset: 10.0 DB
 Sweep Time: 26.0s
 Ref Lvl: 7.1 DBM

Comments

BE @ 2483.5 MHz
 Avg

Cursor 1	2460.8667	-3.57		Delta Freq.	22.633
Cursor 2	2483.5000	-50.40		Delta Amplitude	46.83



Client:	Intel Corporation	Job Number:	J80050
Model:	62205ANHMW (Intel® Centrino® Advanced-N 6205)	T-Log Number:	T80123
Contact:	Steven Hackett	Account Manager:	Christine Krebil
Standard:	FCC 15.247 / FCC 15 E / RSS 210 / FCC 15 B	Class:	N/A

Run # 7, Band Edge Field Strength - 802.11b, Chain A

Date of Test: 8/3/2010

Test Location: FT Chamber #3

Test Engineer: Rafael Varelas

Config Change: none

Run # 7a, EUT on Channel #1 2412MHz - 802.11b, Chain A

	Target (dBm)	Power Settings Measured (dBm)	Software Setting
Chain A	15.5	15.8	23.5

Fundamental Signal Field Strength

Frequency	Level	Pol	15.209 / 15.247		Detector	Azimuth	Height	Comments
MHz	dBuV/m	v/h	Limit	Margin	PK/QP/Avg	degrees	meters	
2413.870	98.2	V	-	-	AVG	234	1.1	RB 1 MHz;VB 10 Hz;Pk
2413.070	101.3	V	-	-	PK	234	1.1	RB 1 MHz;VB 3 MHz;Pk
2413.830	102.7	H	-	-	AVG	247	1.1	RB 1 MHz;VB 10 Hz;Pk
2413.100	106.1	H	-	-	PK	247	1.1	RB 1 MHz;VB 3 MHz;Pk

2390 MHz Band Edge Signal Radiated Field Strength - Marker Delta

	H	V				
Fundamental emission level @ 3m in 1MHz RBW:	106.1	101.3	Peak Measurement (RB=VB=1MHz)			
Fundamental emission level @ 3m in 1MHz RBW:	102.7	98.2	Average Measurement (RB=1MHz, VB=10Hz)			
<i>Delta Marker - 100kHz</i>	<i>56.8 dB</i>		-< this can only be used if band edge signal is highest within 2MHz of band edge.			
Calculated Band-Edge Measurement (Peak):	49.3 dBuV/m					
Calculated Band-Edge Measurement (Avg):	45.9 dBuV/m		Margin	Level	Limit	Detector
<i>Delta Marker - 1MHz/1MHz:</i>	<i>45.3 dB</i>		-10.1	43.9	54	Avg
<i>Delta Marker - 1MHz/10Hz:</i>	<i>58.8 dB</i>		-24.7	49.3	74	PK
Calculated Band-Edge Measurement (Peak):	60.8 dBuV/m		Using 100kHz delta value			
Calculated Band-Edge Measurement (Avg):	43.9 dBuV/m		Using 1MHz delta value			

Frequency	Level	Pol	FCC 15.209		Detector	Azimuth	Height	Comments
MHz	dBuV/m	v/h	Limit	Margin	PK/QP/Avg	degrees	meters	
2386.380	43.9	-	54.0	-10.1	Avg	-	-	Using 1MHz delta value

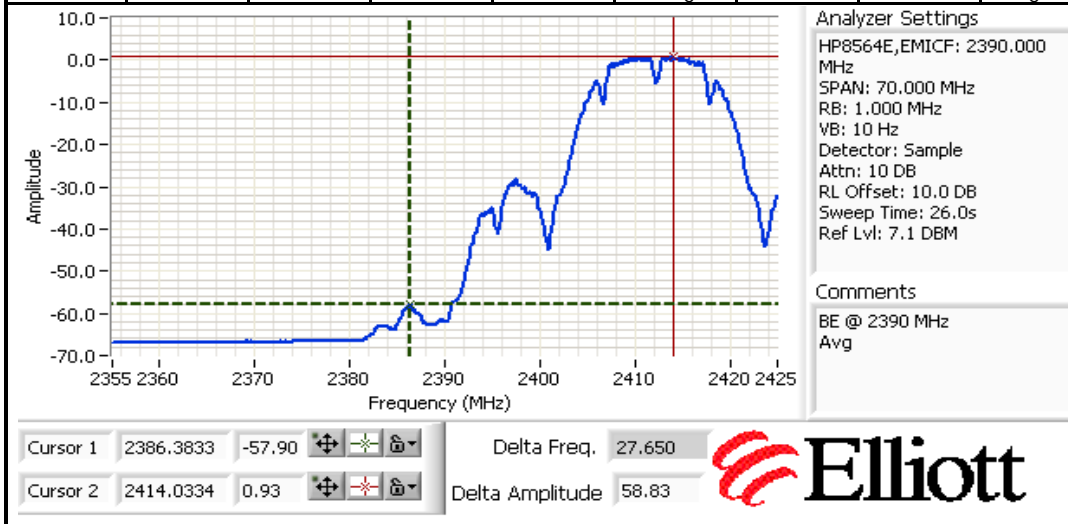

Client: Intel Corporation	Job Number: J80050
Model: 62205ANHMW (Intel® Centrino® Advanced-N 6205)	T-Log Number: T80123
Contact: Steven Hackett	Account Manager: Christine Krebil
Standard: FCC 15.247 / FCC 15 E / RSS 210 / FCC 15 B	Class: N/A

Run # 7b, EUT on Channel #11 2462MHz - 802.11b, Chain A

Date of Test: 8/4/2010 Test Location: Chamber #3
 Test Engineer: Suhaila Khushzad Config Change: none

	Target (dBm)	Power Settings Measured (dBm)	Software Setting
Chain A	15.5	15.5	23.0

Fundamental Signal Field Strength

Frequency MHz	Level dBuV/m	Pol v/h	15.209 / 15.247 Limit	Margin	Detector Pk/QP/Avg	Azimuth degrees	Height meters	Comments
2460.470	101.3	H	-	-	AVG	253	1.0	RB 1 MHz;VB 10 Hz;Pk
2461.330	104.4	H	-	-	PK	253	1.0	RB 1 MHz;VB 3 MHz;Pk
2460.470	101.6	V	-	-	AVG	254	1.0	RB 1 MHz;VB 10 Hz;Pk
2460.800	104.7	V	-	-	PK	254	1.0	RB 1 MHz;VB 3 MHz;Pk

2483.5 MHz Band Edge Signal Radiated Field Strength - Marker Delta

	H	V		Margin	Level	Limit	Detector
Fundamental emission level @ 3m in 1MHz RBW:	104.4	104.7					
Fundamental emission level @ 3m in 1MHz RBW:	101.3	101.6					
<i>Delta Marker - 100kHz</i>	54.2 dB						
Calculated Band-Edge Measurement (Peak):	50.5 dBuV/m						
Calculated Band-Edge Measurement (Avg):	47.4 dBuV/m						
<i>Delta Marker - 1MHz/1MHz:</i>	-9.7	44.3	54	Avg			
<i>Delta Marker - 1MHz/10Hz:</i>	-23.5	50.5	74	Pk			
Calculated Band-Edge Measurement (Peak):	58.2 dBuV/m		Using 100kHz delta value				
Calculated Band-Edge Measurement (Avg):	44.3 dBuV/m		Using 1MHz delta value				

Peak Measurement (RB=VB=1MHz)
 Average Measurement (RB=1MHz, VB=10Hz)
 <- this can only be used if band edge signal is highest within 2MHz of band edge.

Frequency MHz	Level dBuV/m	Pol v/h	FCC 15.209 Limit	Margin	Detector Pk/QP/Avg	Azimuth degrees	Height meters	Comments
2483.500	44.3	-	54.0	-9.7	Avg	-	-	Using 1MHz delta value

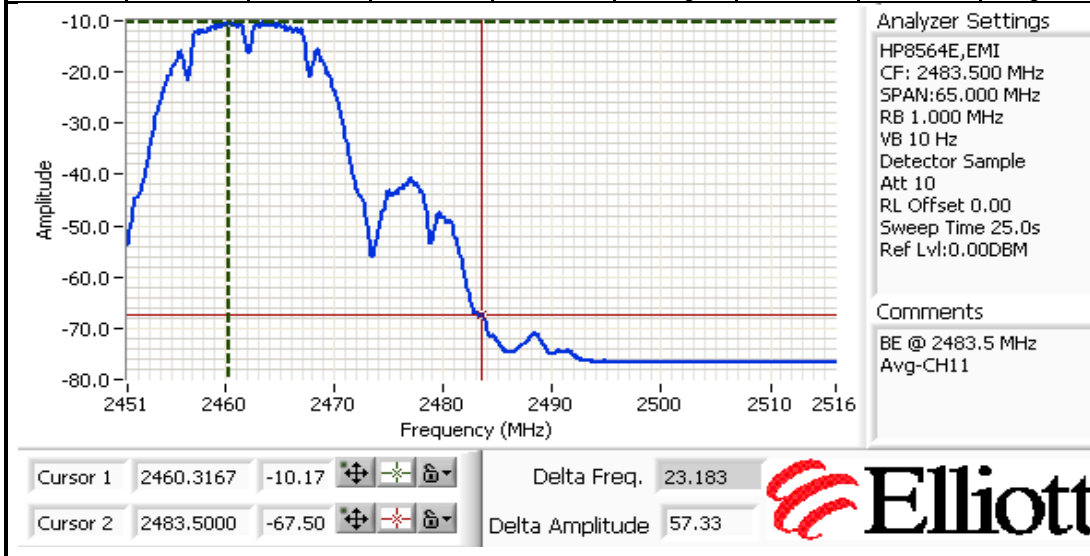

Client:	Intel Corporation	Job Number:	J80050
Model:	62205ANHMW (Intel® Centrino® Advanced-N 6205)	T-Log Number:	T80123
Contact:	Steven Hackett	Account Manager:	Christine Krebil
Standard:	FCC 15.247 / FCC 15 E / RSS 210 / FCC 15 B	Class:	N/A

Run # 8, Band Edge Field Strength - 802.11b, Chain B
Run # 8a, EUT on Channel #1 2412MHz - 802.11b, Chain B

	Target (dBm)	Power Settings Measured (dBm)	Software Setting
Chain B	15.5	15.8	23.5

Fundamental Signal Field Strength

Frequency	Level	Pol	15.209 / 15.247		Detector	Azimuth	Height	Comments
MHz	dBμV/m	v/h	Limit	Margin	Pk/QP/Avg	degrees	meters	
2413.870	101.4	H	-	-	AVG	21	1.0	RB 1 MHz;VB 10 Hz;Pk
2413.200	104.7	H	-	-	PK	21	1.0	RB 1 MHz;VB 3 MHz;Pk
2413.930	97.1	V	-	-	AVG	94	1.8	RB 1 MHz;VB 10 Hz;Pk
2413.270	100.3	V	-	-	PK	94	1.8	RB 1 MHz;VB 3 MHz;Pk

2390 MHz Band Edge Signal Radiated Field Strength - Marker Delta

	H	V				
Fundamental emission level @ 3m in 1MHz RBW:	104.7	100.3	Peak Measurement (RB=VB=1MHz)			
Fundamental emission level @ 3m in 1MHz RBW:	101.4	97.1	Average Measurement (RB=1MHz, VB=10Hz)			
<i>Delta Marker - 100kHz</i>	<i>54.2 dB</i>		-< this can only be used if band edge signal is highest within 2MHz of band edge.			
Calculated Band-Edge Measurement (Peak):	50.5 dBuV/m					
Calculated Band-Edge Measurement (Avg):	47.2 dBuV/m		Margin	Level	Limit	Detector
<i>Delta Marker - 1MHz/1MHz:</i>	<i>51.2 dB</i>		-7.6	46.4	54	Avg
<i>Delta Marker - 1MHz/10Hz:</i>	<i>55.0 dB</i>		-23.5	50.5	74	Pk
Calculated Band-Edge Measurement (Peak):	53.5 dBuV/m		Using 100kHz delta value			
Calculated Band-Edge Measurement (Avg):	46.4 dBuV/m		Using 1MHz delta value			

Frequency	Level	Pol	FCC 15.209		Detector	Azimuth	Height	Comments
MHz	dBμV/m	v/h	Limit	Margin	Pk/QP/Avg	degrees	meters	
2386.310	46.4	-	54.0	-7.6	Avg	-	-	Using 1MHz delta value

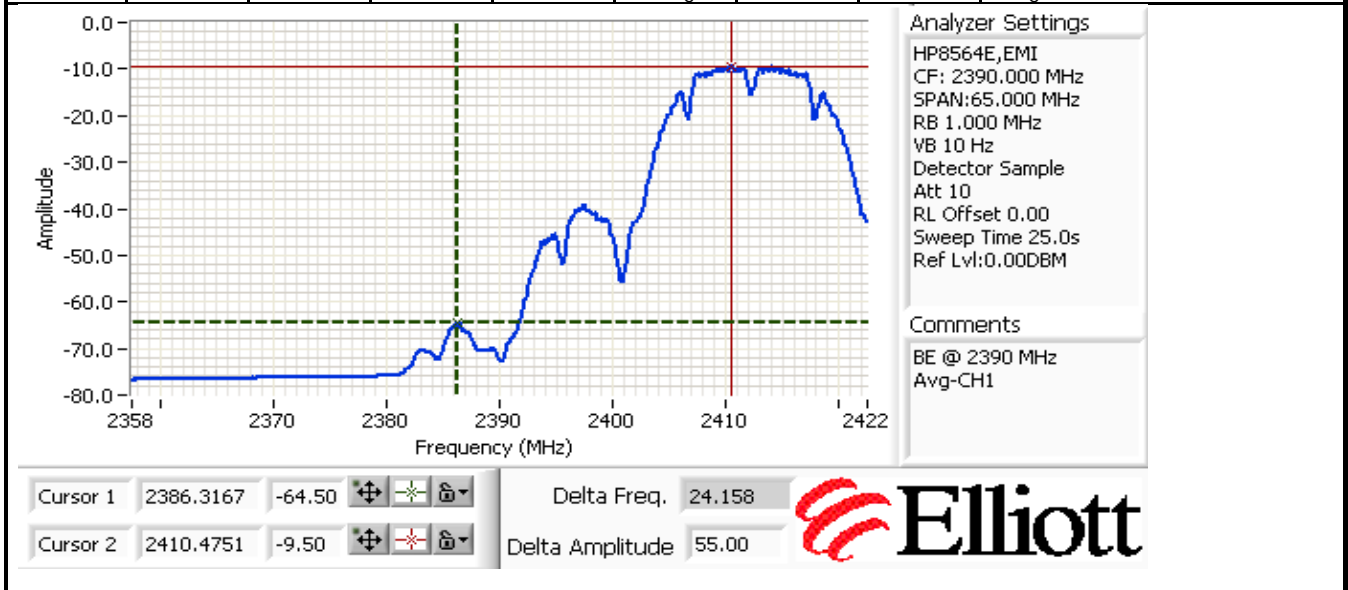

Client:	Intel Corporation	Job Number:	J80050
Model:	62205ANHMW (Intel® Centrino® Advanced-N 6205)	T-Log Number:	T80123
Contact:	Steven Hackett	Account Manager:	Christine Krebil
Standard:	FCC 15.247 / FCC 15 E / RSS 210 / FCC 15 B	Class:	N/A

Run # 8b, EUT on Channel #11 2462MHz - 802.11b, Chain B

	Target (dBm)	Power Settings Measured (dBm)	Software Setting
Chain B	15.5	15.8	23.5

Fundamental Signal Field Strength

Frequency	Level	Pol	15.209 / 15.247		Detector	Azimuth	Height	Comments
MHz	dBμV/m	v/h	Limit	Margin	PK/QP/Avg	degrees	meters	
2460.470	100.9	H	-	-	AVG	194	1.0	RB 1 MHz;VB 10 Hz;Pk
2463.330	104.1	H	-	-	PK	194	1.0	RB 1 MHz;VB 3 MHz;Pk
2464.070	93.3	V	-	-	AVG	197	1.0	RB 1 MHz;VB 10 Hz;Pk
2463.330	96.7	V	-	-	PK	197	1.0	RB 1 MHz;VB 3 MHz;Pk

2483.5 MHz Band Edge Signal Radiated Field Strength - Marker Delta

	H	V		Margin	Level	Limit	Detector
Fundamental emission level @ 3m in 1MHz RBW:	104.1	96.7					Peak Measurement (RB=VB=1MHz)
Fundamental emission level @ 3m in 1MHz RBW:	100.9	93.3					Average Measurement (RB=1MHz, VB=10Hz)
<i>Delta Marker - 100kHz</i>		<i>57.2 dB</i>					<- this can only be used if band edge signal is highest within 2MHz of band edge.
Calculated Band-Edge Measurement (Peak):		46.9 dBuV/m					
Calculated Band-Edge Measurement (Avg):		43.7 dBuV/m					
<i>Delta Marker - 1MHz/1MHz:</i>		<i>53.3 dB</i>		-12.6	41.4	54	Avg
<i>Delta Marker - 1MHz/10Hz:</i>		<i>59.5 dB</i>		-27.1	46.9	74	Pk
Calculated Band-Edge Measurement (Peak):		50.8 dBuV/m					Using 100kHz delta value
Calculated Band-Edge Measurement (Avg):		41.4 dBuV/m					Using 1MHz delta value

Frequency	Level	Pol	FCC 15.209		Detector	Azimuth	Height	Comments
MHz	dBμV/m	v/h	Limit	Margin	PK/QP/Avg	degrees	meters	
2483.500	41.4	-	54.0	-12.6	Avg	-	-	Using 1MHz delta value

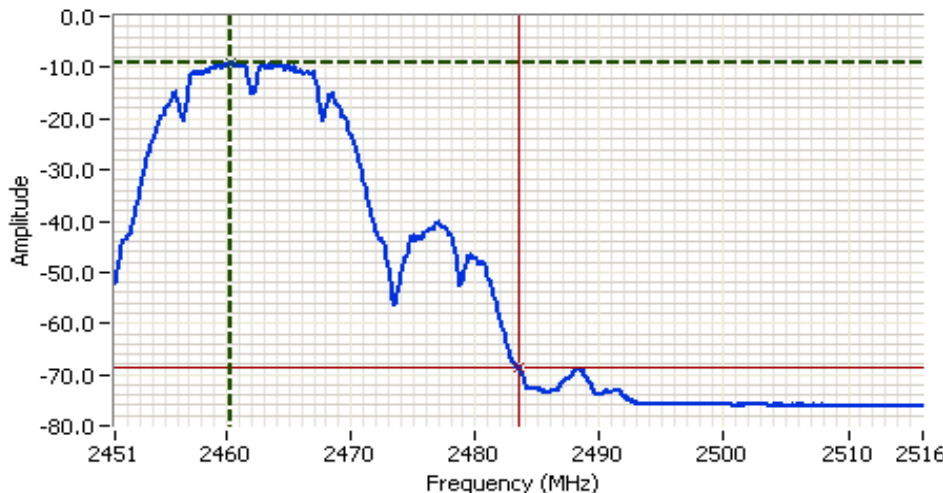

Analyzer Settings

HP8564E,EMI
 CF: 2483.500 MHz
 SPAN:65.000 MHz
 RB 1.000 MHz
 VB 10 Hz
 Detector Sample
 Att 10
 RL Offset 0.00
 Sweep Time 25.0s
 Ref Lvl:0.00DBM

Comments

BE @ 2483.5 MHz
 Avg-CH11

Cursor 1	2460.3167	-9.00	
Cursor 2	2483.5000	-68.50	

Delta Freq.	23.183
Delta Amplitude	59.50



Client:	Intel Corporation	Job Number:	J80050
Model:	62205ANHMW (Intel® Centrino® Advanced-N 6205)	T-Log Number:	T80123
Contact:	Steven Hackett	Account Manager:	Christine Krebil
Standard:	FCC 15.247 / FCC 15 E / RSS 210 / FCC 15 B	Class:	N/A

Run # 9, Band Edge Field Strength - n 20MHz, Chain A+B - new target powers 8/25/2010
 Date of Test: 8/26/2010 Test Location: FT#7
 Test Engineer: Mark Hill Config Change: none

Sample: 0015000633B14

Run # 9a, EUT on Channel #1 2412MHz - n 20MHz, Chain A+B

Chain	Target (dBm)				Power Settings Measured (dBm)				Software Setting
	A	B	C	Total	A	B	C	Total	
	11.5	11.5		14.5	11.6	11.6		14.6	28.5, 26.5

Fundamental Signal Field Strength

Frequency	Level	Pol	15.209 / 15.247		Detector	Azimuth	Height	Comments
MHz	dB μ V/m	v/h	Limit	Margin	Pk/QP/Avg	degrees	meters	
2416.730	93.7	H	120.0	-26.3	AVG	74	1.0	RB 1 MHz;VB 10 Hz;Pk
2416.100	104.1	H	120.0	-15.9	PK	74	1.0	RB 1 MHz;VB 3 MHz;Pk
2413.280	93.1	V	120.0	-26.9	AVG	242	1.2	RB 1 MHz;VB 10 Hz;Pk
2410.600	102.5	V	120.0	-17.5	PK	242	1.2	RB 1 MHz;VB 3 MHz;Pk

2390 MHz Band Edge Signal Radiated Field Strength - Marker Delta

	H	V	
Fundamental emission level @ 3m in 1MHz RBW:	104.1	102.5	Peak Measurement (RB=VB=1MHz)
Fundamental emission level @ 3m in 1MHz RBW:	93.7	93.1	Average Measurement (RB=1MHz, VB=10Hz)
<i>Delta Marker - 100kHz</i>	44.8 dB		<- this can only be used if band edge signal is highest within 2MHz of band edge.
Calculated Band-Edge Measurement (Peak):	59.3 dB μ V/m		
Calculated Band-Edge Measurement (Avg):	48.9 dB μ V/m	Margin	Level
<i>Delta Marker - 1MHz/1MHz:</i>	40.8 dB	-5.1	48.9
<i>Delta Marker - 1MHz/10Hz:</i>	41.3 dB	-14.7	59.3
Calculated Band-Edge Measurement (Peak):	63.3 dB μ V/m		54
Calculated Band-Edge Measurement (Avg):	52.4 dB μ V/m		74
			Using 100kHz delta value
			Using 100kHz delta value

Frequency	Level	Pol	FCC 15.209		Detector	Azimuth	Height	Comments
MHz	dB μ V/m	v/h	Limit	Margin	Pk/QP/Avg	degrees	meters	
2389.450	48.9	-	54.0	-5.1	Avg	-	-	Using 100kHz delta value

Client: Intel Corporation	Job Number: J80050
Model: 62205ANHMW (Intel® Centrino® Advanced-N 6205)	T-Log Number: T80123
	Account Manager: Christine Krebil
Contact: Steven Hackett	
Standard: FCC 15.247 / FCC 15 E / RSS 210 / FCC 15 B	Class: N/A

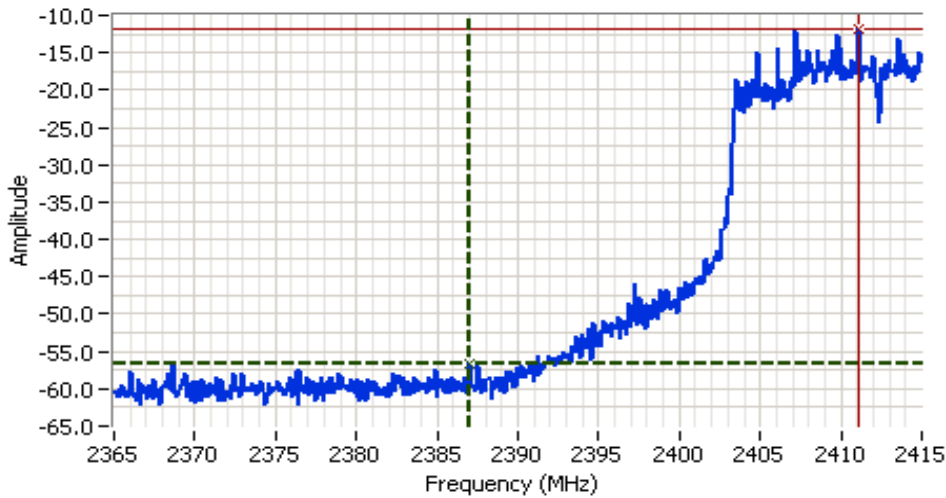

Analyzer Settings

HP8564E, EMI
 CF: 2390.000 MHz
 SPAN: 50.000 MHz
 RB 100 kHz
 VB 100 kHz
 Detector POS
 Att 20
 RL Offset 10.00
 Sweep Time 50.0ms
 Ref Lvl: 14.30DBM

Comments

802.11 n20 A+B, CH 1

Cursor 1	2387.0000	-56.53	
Cursor 2	2411.0833	-11.70	

Delta Freq. 24.083

Delta Amplitude 44.83



Client:	Intel Corporation	Job Number:	J80050
Model:	62205ANHMW (Intel® Centrino® Advanced-N 6205)	T-Log Number:	T80123
Contact:	Steven Hackett	Account Manager:	Christine Krebil
Standard:	FCC 15.247 / FCC 15 E / RSS 210 / FCC 15 B	Class:	N/A

Run # 9b, EUT on Channel #11 2462MHz - n 20MHz, Chain A+B

Chain	Target (dBm)				Power Settings Measured (dBm)				Software Setting
	A	B	C	Total	A	B	C	Total	
	11.5	11.5		14.5	11.9	11.7		14.8	

Fundamental Signal Field Strength

Frequency MHz	Level dBμV/m	Pol v/h	15.209 / 15.247		Detector	Azimuth degrees	Height meters	Comments
			Limit	Margin				
2460.730	95.2	H	-	-	AVG	176	1.3	RB 1 MHz;VB 10 Hz;Pk
2460.800	105.6	H	-	-	PK	176	1.3	RB 1 MHz;VB 3 MHz;Pk
2457.730	94.0	V	-	-	AVG	180	1.2	RB 1 MHz;VB 10 Hz;Pk
2457.770	104.5	V	-	-	PK	180	1.2	RB 1 MHz;VB 3 MHz;Pk

2483.5 MHz Band Edge Signal Radiated Field Strength - Marker Delta

	H	V				
Fundamental emission level @ 3m in 1MHz RBW:	105.6	104.5	Peak Measurement (RB=VB=1MHz)			
Fundamental emission level @ 3m in 1MHz RBW:	95.2	94.0	Average Measurement (RB=1MHz, VB=10Hz)			
<i>Delta Marker - 100kHz</i>	42.7 dB		-< this can only be used if band edge signal is highest within 2MHz of band edge.			
Calculated Band-Edge Measurement (Peak):	62.9 dBuV/m					
Calculated Band-Edge Measurement (Avg):	52.5 dBuV/m		Margin	Level	Limit	Detector
<i>Delta Marker - 1MHz/1MHz:</i>	39.5 dB		-1.5	52.5	54	Avg
<i>Delta Marker - 1MHz/10Hz:</i>	39.8 dB		-11.1	62.9	74	Pk
Calculated Band-Edge Measurement (Peak):	66.1 dBuV/m		Using 100kHz delta value			
Calculated Band-Edge Measurement (Avg):	55.4 dBuV/m		Using 100kHz delta value			

Frequency MHz	Level dBμV/m	Pol v/h	FCC 15.209		Detector	Azimuth degrees	Height meters	Comments
			Limit	Margin				
2484.916	52.5	-	54.0	-1.5	Avg	-	-	Using 100kHz delta value

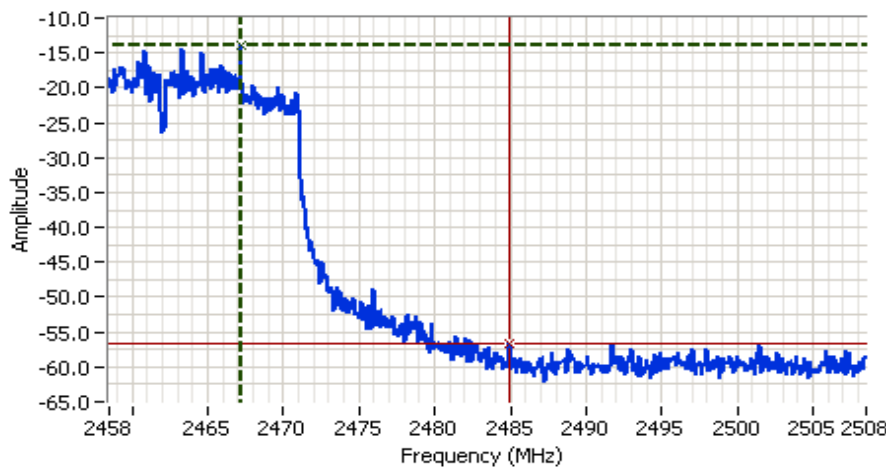

Analyzer Settings

HP8564E, EMI
CF: 2483.500 MHz
SPAN: 50.000 MHz
RB 100 kHz
VB 100 kHz
Detector POS
Att 20
RL Offset 10.00
Sweep Time 50.0ms
Ref Lvl: 14.30DBM

Comments

802.11 n20 A+B, CH 11

Cursor 1	2467.1667	-14.03		
Cursor 2	2484.9167	-56.70		

Delta Freq.	17.750
Delta Amplitude	42.67



Client:	Intel Corporation	Job Number:	J80050
Model:	62205ANHMW (Intel® Centrino® Advanced-N 6205)	T-Log Number:	T80123
Contact:	Steven Hackett	Account Manager:	Christine Krebil
Standard:	FCC 15.247 / FCC 15 E / RSS 210 / FCC 15 B	Class:	N/A

RSS 210 and FCC 15.247 (2.4GHz DTS) Transmitter and Receiver Spurious

Summary of Results

MAC Address: 001500633B2C DRTU Tool Version 1.1.3 Driver version 13.0.0.238 Sample: 1340

Run #	Mode	Channel	Target Power	Measured Power	Test Performed	Limit	Result / Margin
Run # 1	802.11b Chain A	#1 2412MHz	15.5	15.7	Radiated Emissions, 1 - 26 GHz	FCC 15.209 / 15.247	43.6dBµV/m @ 4824.0MHz (-10.4dB)
		#6 2437MHz	15.5	15.8			46.8dBµV/m @ 4874.0MHz (-7.2dB)
		#11 2462MHz	15.5	15.8			47.9dBµV/m @ 4924.0MHz (-6.1dB)
Run # 2	802.11b Chain B	#1 2412MHz	15.5	15.8	Radiated Emissions, 1 - 26 GHz	FCC 15.209 / 15.247	44.0dBµV/m @ 7500.1MHz (-10.0dB)
		#6 2437MHz	15.5	15.8			44.1dBµV/m @ 7500.0MHz (-9.9dB)
		#11 2462MHz	15.5	15.8			43.5dBµV/m @ 4924.0MHz (-10.5dB)

Center channel in 802.11g and n modes (OFDM) to determine the worst case. For n modes we are testing with both chains operating simultaneously at the maximum single chain power to cover both single- and dual-chain operation.

Run # 3	802.11g Chain A/B	#6 A 2437MHz	16.5	16.6	Radiated Emissions, 1 - 26 GHz	FCC 15.209 / 15.247	45.6dBµV/m @ 7500.1MHz (-8.4dB)
		#6 B 2437MHz	16.5	16.7			39.0dBµV/m @ 4874.1MHz (-15.0dB)

Switched to sample MAC Address: 001500633B14 due to broken rf connector on original sample.

Run # 4	n20 / n40 Chain A+B	#6 n20 2437MHz	A:16.5 B:16.5	16.4 16.4	Radiated Emissions, 1 - 26 GHz	FCC 15.209 / 15.247	41.9dBµV/m @ 4873.5MHz (-12.1dB)
		#6 n40 2437MHz	A:16.5 B:16.5	16.4 16.3			37.0dBµV/m @ 4874.2MHz (-17.0dB)

Top and bottom channels in worst case OFDM mode:

Run # 5	802.11g Chain A	#1 2412MHz	A: 16.5	16.7	Radiated Emissions, 1 - 26 GHz	FCC 15.209 / 15.247	37.8dBµV/m @ 1592.9MHz (-16.2dB)
		#11 2462MHz	A: 16.5	16.4			42.0dBµV/m @ 4925.7MHz (-12.0dB)

Note - the target and measured power are average powers (measured with average power sensor) and are used for reference purposes only.

Client:	Intel Corporation	Job Number:	J80050
Model:	62205ANHMW (Intel® Centrino® Advanced-N 6205)	T-Log Number:	T80123
Contact:	Steven Hackett	Account Manager:	Christine Krebil
Standard:	FCC 15.247 / FCC 15 E / RSS 210 / FCC 15 B	Class:	N/A

Receiver Spurious Emissions

Run # 6	Receive Chain A, Chain B and Chain A+B	#6A 2437MHz	-	-	Radiated Emissions, 1 - 26 GHz	FCC 15.209 / 15.247	37.8dBµV/m @ 1328.7MHz (-16.2dB)
		#6B 2437MHz	-	-			36.4dBµV/m @ 2517.5MHz (-17.6dB)
		#6A+B 2437MHz	-	-			32.3dBµV/m @ 1594.2MHz (-21.7dB)

Test Specific Details

Objective: The objective of this test session is to perform engineering evaluation testing of the EUT with respect to the specification listed above.

General Test Configuration

The EUT was installed into a test fixture such that the EUT was exposed (i.e. outside of a host PC).
For radiated emissions testing the measurement antenna was located 3 meters from the EUT.

Ambient Conditions:

Rel. Humidity: 15 - 55 %
Temperature: 18 - 25 °C

Modifications Made During Testing

No modifications were made to the EUT during testing

Deviations From The Standard

No deviations were made from the requirements of the standard.

Client:	Intel Corporation	Job Number:	J80050
Model:	62205ANHMW (Intel® Centrino® Advanced-N 6205)	T-Log Number:	T80123
Contact:	Steven Hackett	Account Manager:	Christine Krebil
Standard:	FCC 15.247 / FCC 15 E / RSS 210 / FCC 15 B	Class:	N/A

Run # 1, Radiated Spurious Emissions, 1-26GHz, 802.11b, Chain A

Date of Test: 8/5/2010 Test Location: FT Chamber #3
 Test Engineer: Rafael Varelas Config Change: None

Run # 1a, EUT on Channel #1 2412MHz - 802.11b, Chain A

	Target (dBm)	Power Settings Measured (dBm)	Software Setting
Chain A	15.5	15.7	23.5

Spurious Radiated Emissions:

Frequency	Level	Pol	15.209/15.247		Detector	Azimuth	Height	Comments
MHz	dB μ V/m	v/h	Limit	Margin	Pk/QP/Avg	degrees	meters	
4824.000	43.6	V	54.0	-10.4	AVG	179	1.0	RB 1 MHz;VB 10 Hz;Pk
4824.060	47.4	V	74.0	-26.6	PK	179	1.0	RB 1 MHz;VB 3 MHz;Pk

Note 1: For emissions in restricted bands, the limit of 15.209 was used. For all other emissions, the limit is -30dBc for peak measurements in a measurement bandwidth of 100kHz.

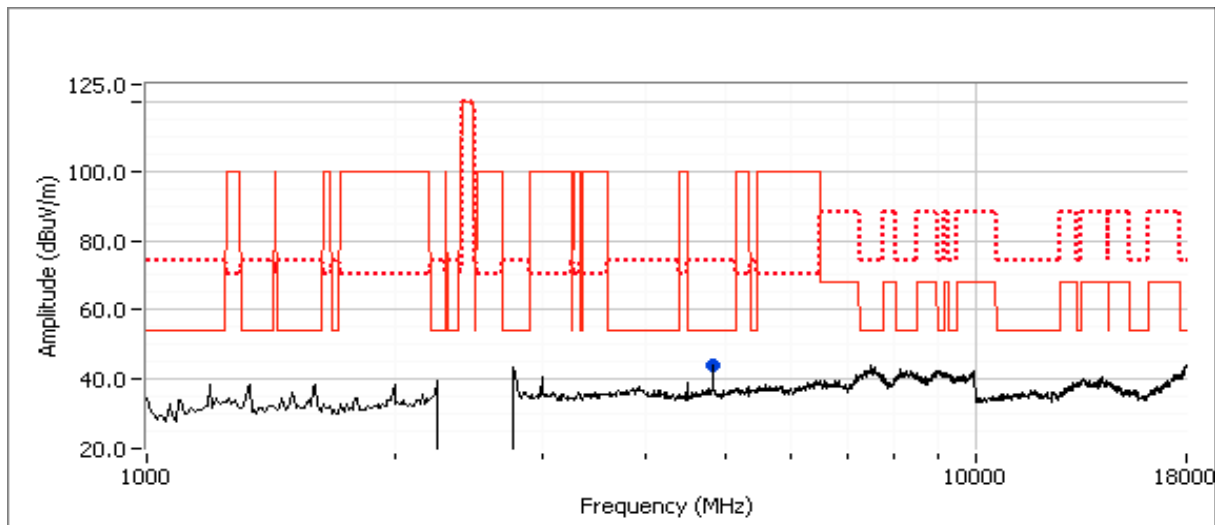

Client:	Intel Corporation	Job Number:	J80050
Model:	62205ANHMW (Intel® Centrino® Advanced-N 6205)	T-Log Number:	T80123
Contact:	Steven Hackett	Account Manager:	Christine Krebil
Standard:	FCC 15.247 / FCC 15 E / RSS 210 / FCC 15 B	Class:	N/A

Run # 1b: , EUT on Channel #6 2437MHz - 802.11b, Chain A

	Target (dBm)	Power Settings Measured (dBm)	Software Setting
Chain A	15.5	15.8	23.5

Spurious Radiated Emissions:

Frequency	Level	Pol	15.209/15.247		Detector	Azimuth	Height	Comments
MHz	dB μ V/m	v/h	Limit	Margin	Pk/QP/Avg	degrees	meters	
4873.980	46.8	V	54.0	-7.2	AVG	198	1.0	RB 1 MHz;VB 10 Hz;Pk
4874.020	49.5	V	74.0	-24.5	PK	198	1.0	RB 1 MHz;VB 3 MHz;Pk

Note 1: For emissions in restricted bands, the limit of 15.209 was used. For all other emissions, the limit is -30dBc for peak measurements in a measurement bandwidth of 100kHz.

Note 2: No emissions observed above 18GHz when scanning with the measurement antenna within 20cm of the device.

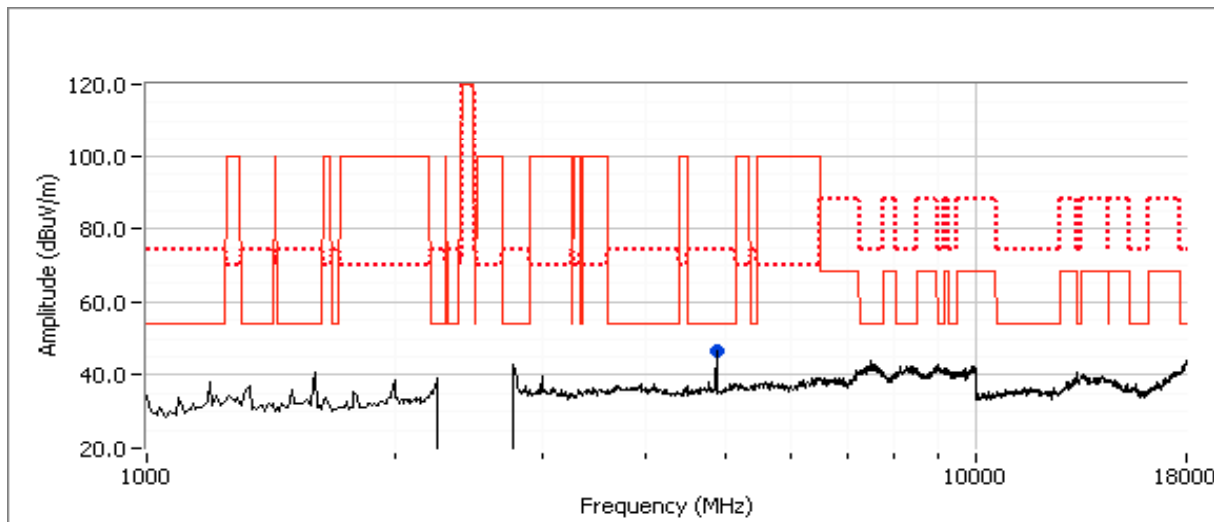

Client:	Intel Corporation	Job Number:	J80050
Model:	62205ANHMW (Intel® Centrino® Advanced-N 6205)	T-Log Number:	T80123
Contact:	Steven Hackett	Account Manager:	Christine Krebil
Standard:	FCC 15.247 / FCC 15 E / RSS 210 / FCC 15 B	Class:	N/A

Run # 1c : , EUT on Channel #11 2462MHz - 802.11b, Chain A

	Target (dBm)	Power Settings Measured (dBm)	Software Setting
Chain A	15.5	15.8	23.5

Spurious Radiated Emissions:

Frequency	Level	Pol	15.209/15.247		Detector	Azimuth	Height	Comments
MHz	dB μ V/m	v/h	Limit	Margin	Pk/QP/Avg	degrees	meters	
4923.980	47.9	V	54.0	-6.1	AVG	195	1.0	RB 1 MHz;VB 10 Hz;Pk
4923.980	51.0	V	74.0	-23.0	PK	195	1.0	RB 1 MHz;VB 3 MHz;Pk
7500.060	43.5	V	54.0	-10.5	AVG	103	1.1	RB 1 MHz;VB 10 Hz;Pk
7500.180	49.9	V	74.0	-24.1	PK	103	1.1	RB 1 MHz;VB 3 MHz;Pk

Note 1: For emissions in restricted bands, the limit of 15.209 was used. For all other emissions, the limit is -30dBc for peak measurements in a measurement bandwidth of 100kHz.

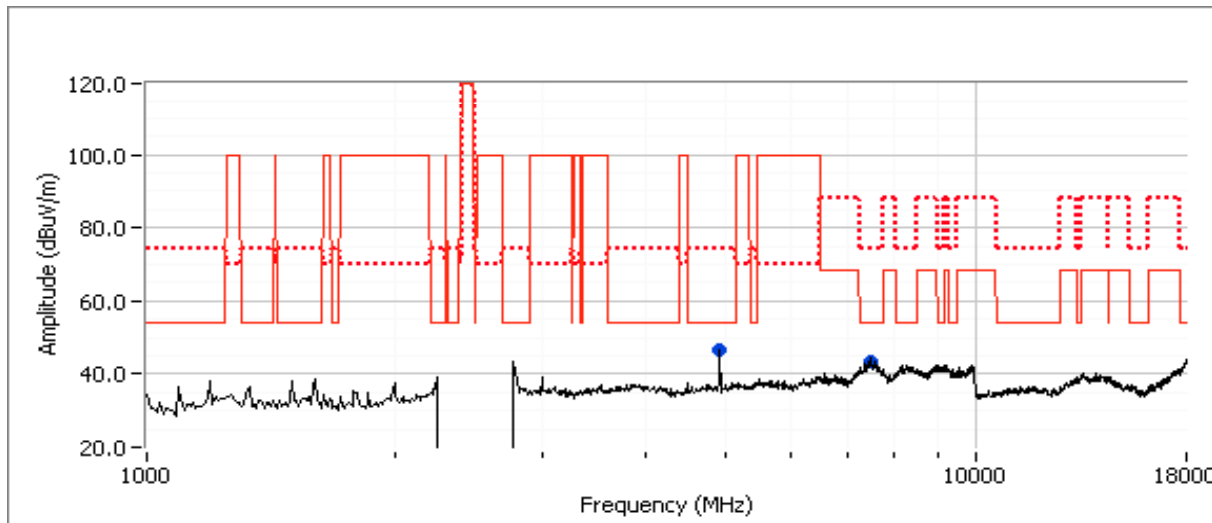

Client:	Intel Corporation	Job Number:	J80050
Model:	62205ANHMW (Intel® Centrino® Advanced-N 6205)	T-Log Number:	T80123
Contact:	Steven Hackett	Account Manager:	Christine Krebil
Standard:	FCC 15.247 / FCC 15 E / RSS 210 / FCC 15 B	Class:	N/A

Run # 2, Radiated Spurious Emissions, 1-26GHz, 802.11b, Chain B

Date of Test: 8/5/2010
 Test Engineer: Rafael Varelas
 Test Location: FT Chamber #3
 Config Change: None

Run # 2a, EUT on Channel #1 2412MHz - 802.11b, Chain B

	Target (dBm)	Power Settings Measured (dBm)	Software Setting
Chain B	15.5	15.8	23.5

Spurious Radiated Emissions:

Frequency	Level	Pol	15.209/15.247		Detector	Azimuth	Height	Comments
MHz	dB μ V/m	v/h	Limit	Margin	Pk/QP/Avg	degrees	meters	
7500.090	44.0	V	54.0	-10.0	AVG	101	1.1	RB 1 MHz;VB 10 Hz;Pk
7499.860	50.9	V	74.0	-23.1	PK	101	1.1	RB 1 MHz;VB 3 MHz;Pk
4824.000	42.6	V	54.0	-11.4	AVG	172	1.1	RB 1 MHz;VB 10 Hz;Pk
4824.120	47.3	V	74.0	-26.7	PK	172	1.1	RB 1 MHz;VB 3 MHz;Pk

Note 1: For emissions in restricted bands, the limit of 15.209 was used. For all other emissions, the limit is -30dBc for peak measurements in a measurement bandwidth of 100kHz.

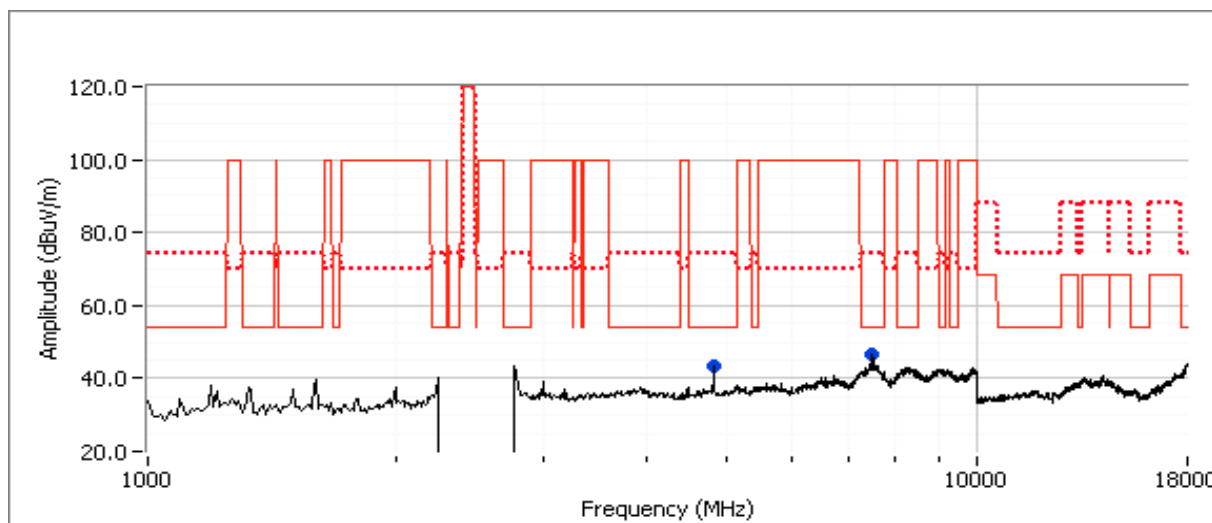

Client:	Intel Corporation	Job Number:	J80050
Model:	62205ANHMW (Intel® Centrino® Advanced-N 6205)	T-Log Number:	T80123
Contact:	Steven Hackett	Account Manager:	Christine Krebil
Standard:	FCC 15.247 / FCC 15 E / RSS 210 / FCC 15 B	Class:	N/A

Run # 2b: , EUT on Channel #6 2437MHz - 802.11b, Chain B

	Target (dBm)	Power Settings Measured (dBm)	Software Setting
Chain B	15.5	15.8	23.5

Spurious Radiated Emissions:

Frequency	Level	Pol	15.209/15.247		Detector	Azimuth	Height	Comments
MHz	dB μ V/m	v/h	Limit	Margin	Pk/QP/Avg	degrees	meters	
7500.040	44.1	V	54.0	-9.9	AVG	106	1.1	RB 1 MHz;VB 10 Hz;Pk
7500.180	52.0	V	74.0	-22.0	PK	106	1.1	RB 1 MHz;VB 3 MHz;Pk
4873.990	43.3	V	54.0	-10.7	AVG	179	1.0	RB 1 MHz;VB 10 Hz;Pk
4873.920	47.4	V	74.0	-26.6	PK	179	1.0	RB 1 MHz;VB 3 MHz;Pk

Note 1: For emissions in restricted bands, the limit of 15.209 was used. For all other emissions, the limit is -30dBc for peak measurements in a measurement bandwidth of 100kHz.

Note 2: No emissions observed above 18GHz when scanning with the measurement antenna within 20cm of the device.

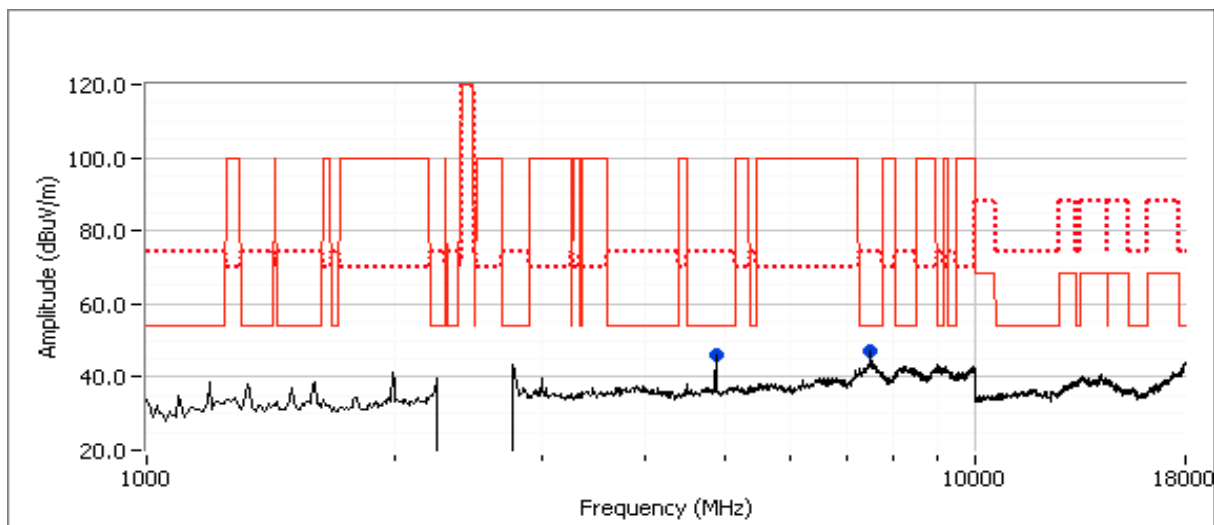

Client:	Intel Corporation	Job Number:	J80050
Model:	62205ANHMW (Intel® Centrino® Advanced-N 6205)	T-Log Number:	T80123
Contact:	Steven Hackett	Account Manager:	Christine Krebil
Standard:	FCC 15.247 / FCC 15 E / RSS 210 / FCC 15 B	Class:	N/A

Run # 2c: , EUT on Channel #11 2462MHz - 802.11b, Chain B

	Target (dBm)	Power Settings Measured (dBm)	Software Setting
Chain B	15.5	15.8	23.5

Spurious Radiated Emissions:

Frequency	Level	Pol	15.209/15.247		Detector	Azimuth	Height	Comments
MHz	dB μ V/m	v/h	Limit	Margin	Pk/QP/Avg	degrees	meters	
4924.000	43.5	V	54.0	-10.5	AVG	183	1.1	RB 1 MHz;VB 10 Hz;Pk
4923.980	47.6	V	74.0	-26.4	PK	183	1.1	RB 1 MHz;VB 3 MHz;Pk
7499.960	42.2	V	54.0	-11.8	AVG	147	1.0	RB 1 MHz;VB 10 Hz;Pk
7500.070	51.2	V	74.0	-22.8	PK	147	1.0	RB 1 MHz;VB 3 MHz;Pk

Note 1: For emissions in restricted bands, the limit of 15.209 was used. For all other emissions, the limit is -30dBc for peak measurements in a measurement bandwidth of 100kHz.

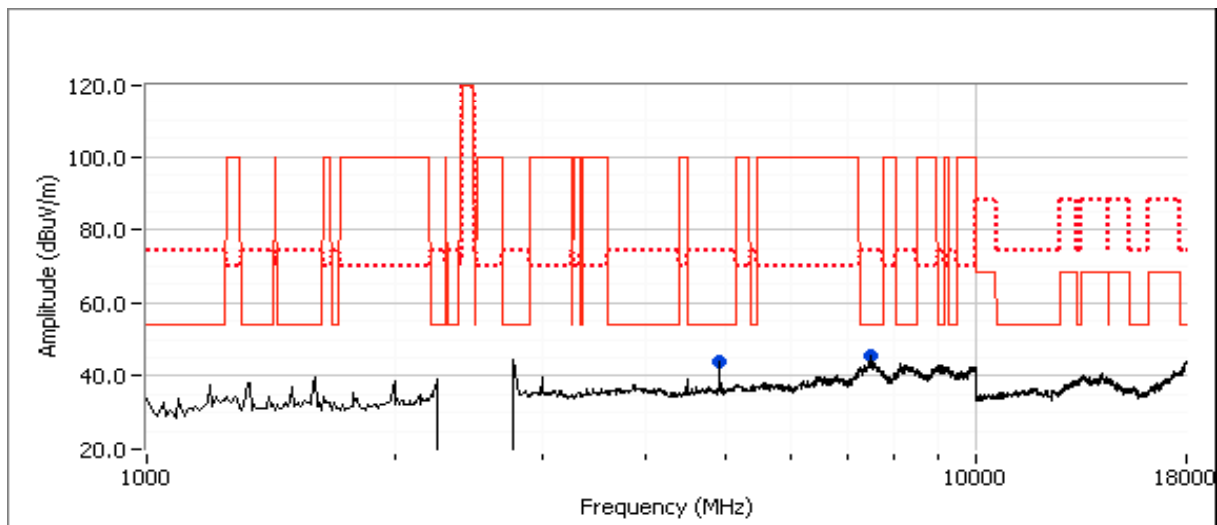

Client:	Intel Corporation	Job Number:	J80050
Model:	62205ANHMW (Intel® Centrino® Advanced-N 6205)	T-Log Number:	T80123
Contact:	Steven Hackett	Account Manager:	Christine Krebil
Standard:	FCC 15.247 / FCC 15 E / RSS 210 / FCC 15 B	Class:	N/A

Run # 3, Radiated Spurious Emissions, 1-26GHz, 802.11g, Chain A

Date of Test: 8/6/2010

Test Location: FT Chamber #3

Test Engineer: David Bare

Config Change: None

Run # 3a, EUT on Channel #6 A 2437MHz - 802.11g, Chain A

	Target (dBm)	Power Settings Measured (dBm)	Software Setting
Chain A/B	16.5	16.6	29.5

Spurious Radiated Emissions:

Frequency	Level	Pol	15.209/15.247		Detector	Azimuth	Height	Comments
MHz	dB μ V/m	v/h	Limit	Margin	PK/QP/Avg	degrees	meters	
1594.680	45.9	V	74.0	-28.1	PK	174	1.4	
1595.960	32.1	V	54.0	-21.9	AVG	174	1.4	
4872.590	51.1	V	74.0	-22.9	PK	164	1.1	
4873.740	39.8	V	54.0	-14.2	AVG	164	1.1	
7500.110	45.6	V	54.0	-8.4	Peak	114	1.3	

Note 1:

For emissions in restricted bands, the limit of 15.209 was used. For all other emissions, the limit is -30dBc for peak measurements in a measurement bandwidth of 100kHz.

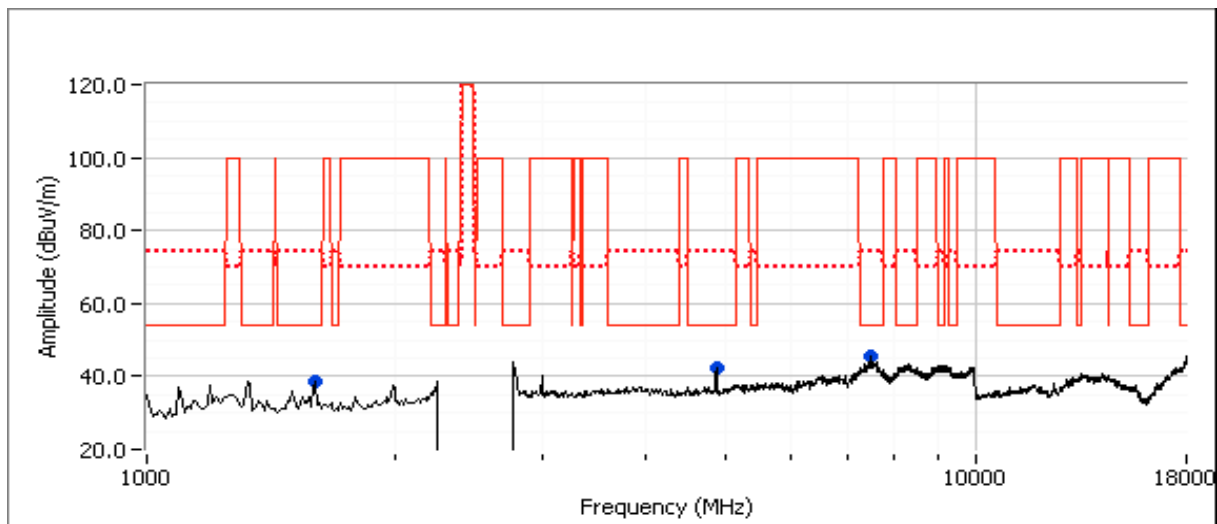

Client:	Intel Corporation	Job Number:	J80050
Model:	62205ANHMW (Intel® Centrino® Advanced-N 6205)	T-Log Number:	T80123
Contact:	Steven Hackett	Account Manager:	Christine Krebil
Standard:	FCC 15.247 / FCC 15 E / RSS 210 / FCC 15 B	Class:	N/A

Run # 3b: , EUT on Channel #6 B 2437MHz - 802.11g, Chain B

	Target (dBm)	Power Settings Measured (dBm)	Software Setting
Chain A/B	16.5	16.7	29.5

Spurious Radiated Emissions:

Frequency	Level	Pol	15.209/15.247		Detector	Azimuth	Height	Comments
MHz	dB μ V/m	v/h	Limit	Margin	PK/QP/Avg	degrees	meters	
4871.650	51.0	V	74.0	-23.0	PK	181	1.0	
4874.050	39.0	V	54.0	-15.0	AVG	181	1.0	
7306.850	47.5	V	74.0	-26.5	PK	150	1.0	
7309.850	35.5	V	54.0	-18.5	AVG	150	1.0	

Note 1: For emissions in restricted bands, the limit of 15.209 was used. For all other emissions, the limit is -30dBc for peak measurements in a measurement bandwidth of 100kHz.

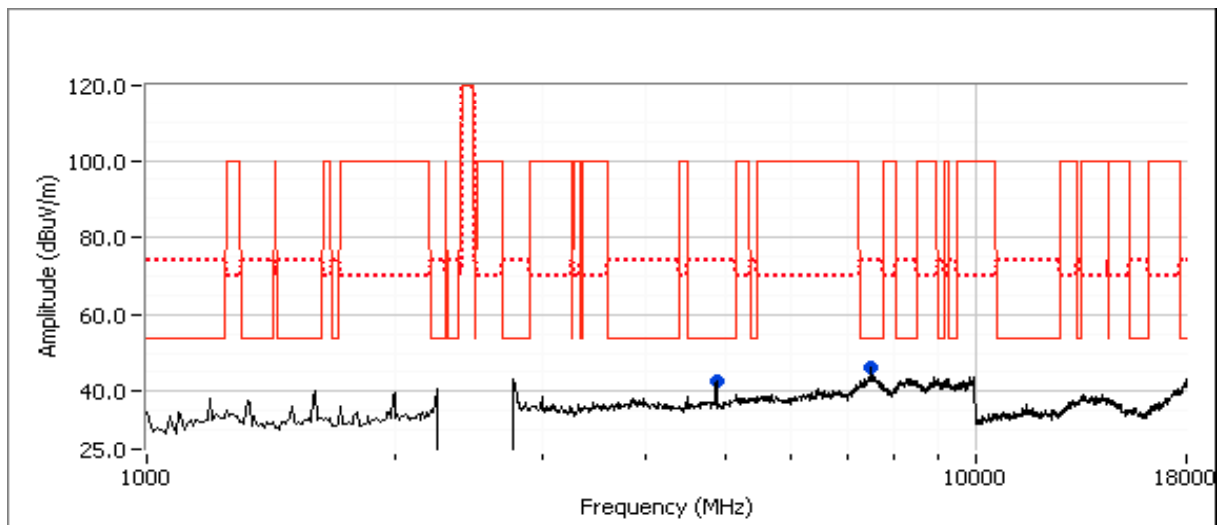

Client:	Intel Corporation	Job Number:	J80050
Model:	62205ANHMW (Intel® Centrino® Advanced-N 6205)	T-Log Number:	T80123
Contact:	Steven Hackett	Account Manager:	Christine Krebil
Standard:	FCC 15.247 / FCC 15 E / RSS 210 / FCC 15 B	Class:	N/A

Run # 4, Radiated Spurious Emissions, 1-26GHz, n20 / n40, Chain A+B

Date of Test: 8/9/2010

Test Location: CH #5

Test Engineer: John Caizzi

Config Change: Backup sample, see EUT Description.

Run # 4a, EUT on Channel #6 n20 2437MHz, Chain A+B

Chain	Power Settings								Software Setting
	Target (dBm)				Measured (dBm)				
	A	B	C	Total	A	B	C	Total	
	16.5	16.5		19.5	16.4	16.4		19.4	31.0 / 31.0

Spurious Radiated Emissions:

Frequency	Level	Pol	15.209/15.247		Detector	Azimuth	Height	Comments
MHz	dB μ V/m	v/h	Limit	Margin	PK/QP/Avg	degrees	meters	
4873.530	41.9	V	54.0	-12.1	AVG	9	1.02	
4871.530	54.0	V	74.0	-20.0	PK	9	1.02	

Note 1: For emissions in restricted bands, the limit of 15.209 was used. For all other emissions, the limit is -30dBc for peak measurements in a measurement bandwidth of 100kHz.

Note 2: No emissions observed above 18GHz when scanning with the measurement antenna within 20cm of the device.

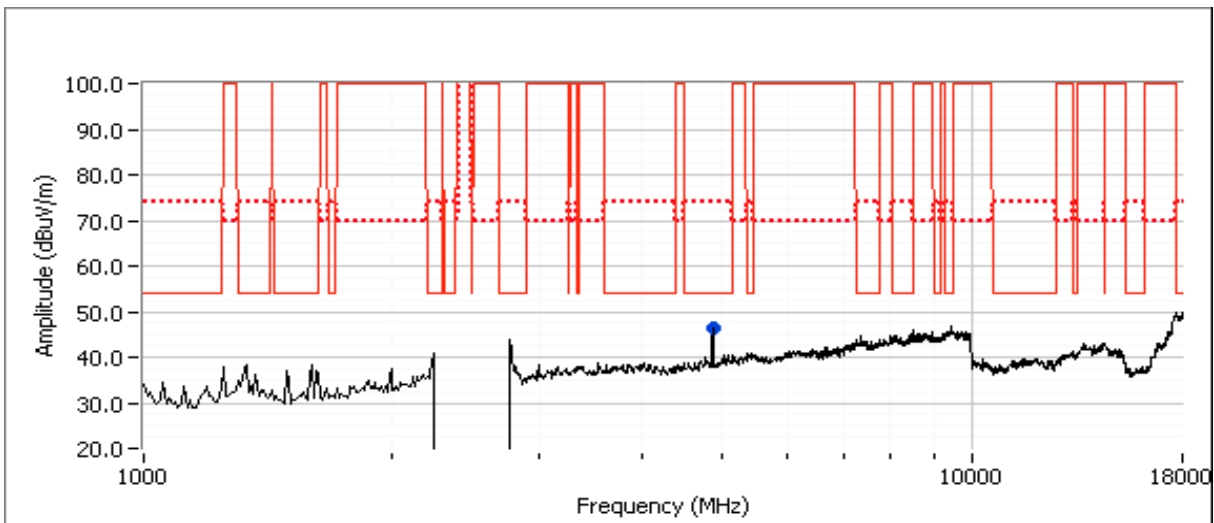

Client:	Intel Corporation	Job Number:	J80050
Model:	62205ANHMW (Intel® Centrino® Advanced-N 6205)	T-Log Number:	T80123
Contact:	Steven Hackett	Account Manager:	Christine Krebil
Standard:	FCC 15.247 / FCC 15 E / RSS 210 / FCC 15 B	Class:	N/A

Run # 4b: , EUT on Channel #6 n40 2437MHz - Chain A+B

Chain	Target (dBm)				Power Settings Measured (dBm)				Software Setting
	A	B	C	Total	A	B	C	Total	
	16.5	16.5		19.5	16.4	16.3		19.4	31.0 / 30.5

Spurious Radiated Emissions:

Frequency	Level	Pol	15.209/15.247		Detector	Azimuth	Height	Comments
MHz	dB μ V/m	v/h	Limit	Margin	Pk/QP/Avg	degrees	meters	
4874.200	37.0	V	54.0	-17.0	AVG	21	1.02	
4874.130	49.5	V	74.0	-24.5	PK	21	1.02	
1330.000	39.0	V	54.0	-15.0	Peak	262	1.3	

Note 1: For emissions in restricted bands, the limit of 15.209 was used. For all other emissions, the limit is -30dBc for peak measurements in a measurement bandwidth of 100kHz.

Note 2: No emissions observed above 18GHz when scanning with the measurement antenna within 20cm of the device.

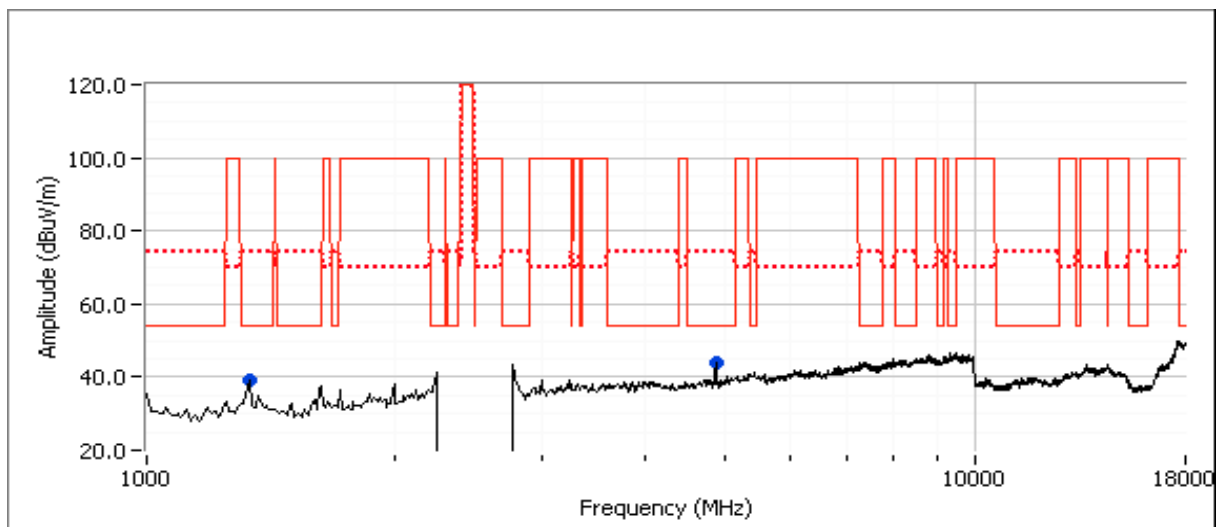

Client:	Intel Corporation	Job Number:	J80050
Model:	62205ANHMW (Intel® Centrino® Advanced-N 6205)	T-Log Number:	T80123
Contact:	Steven Hackett	Account Manager:	Christine Krebil
Standard:	FCC 15.247 / FCC 15 E / RSS 210 / FCC 15 B	Class:	N/A

Run # 5, Radiated Spurious Emissions, 1-26GHz, 802.11g, Chain A

Date of Test: 8/9/2010
Test Engineer: Mehran Birgani

Test Location: Chamber #5
Config Change: None

Run # 5a, EUT on Channel #1 2412MHz - 802.11g, Chain A

Chain	Target (dBm)				Power Settings Measured (dBm)				Software Setting
	A	B	C	Total	A	B	C	Total	
	16.5			16.5	16.7			16.7	32.0

Spurious Radiated Emissions:

Frequency	Level	Pol	15.209/15.247		Detector	Azimuth	Height	Comments
MHz	dB μ V/m	v/h	Limit	Margin	Pk/QP/Avg	degrees	meters	
1592.890	37.8	V	54.0	-16.2	Peak	327	1.3	

Note 1: For emissions in restricted bands, the limit of 15.209 was used. For all other emissions, the limit is -30dBc for peak measurements in a measurement bandwidth of 100kHz.

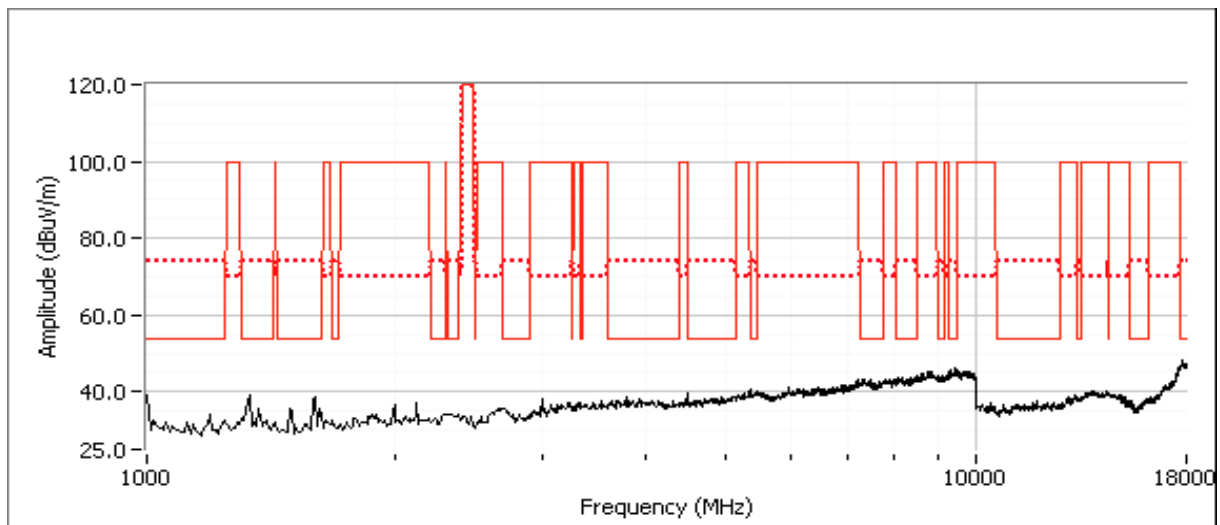

Client:	Intel Corporation	Job Number:	J80050
Model:	62205ANHMW (Intel® Centrino® Advanced-N 6205)	T-Log Number:	T80123
Contact:	Steven Hackett	Account Manager:	Christine Krebil
Standard:	FCC 15.247 / FCC 15 E / RSS 210 / FCC 15 B	Class:	N/A

Run # 5b: , EUT on Channel #11 2462MHz - 802.11g, Chain A

Chain	Target (dBm)				Power Settings Measured (dBm)				Software Setting
	A	B	C	Total	A	B	C	Total	
	16.5			16.5	16.4			16.4	30.0

Spurious Radiated Emissions:

Frequency	Level	Pol	15.209/15.247		Detector	Azimuth	Height	Comments
MHz	dB μ V/m	v/h	Limit	Margin	Pk/QP/Avg	degrees	meters	
4925.700	42.0	V	54.0	-12.0	AVG	12	1.0	Chain A
4925.430	54.3	V	74.0	-19.7	PK	12	1.0	Chain A
4923.970	36.6	V	54.0	-17.4	AVG	0	1.0	Chain B (setting 29, 16.5dBm)
4926.370	48.5	V	74.0	-25.5	PK	0	1.0	Chain B (setting 29, 16.5dBm)

Note 1: For emissions in restricted bands, the limit of 15.209 was used. For all other emissions, the limit is -30dBc for peak measurements in a measurement bandwidth of 100kHz.

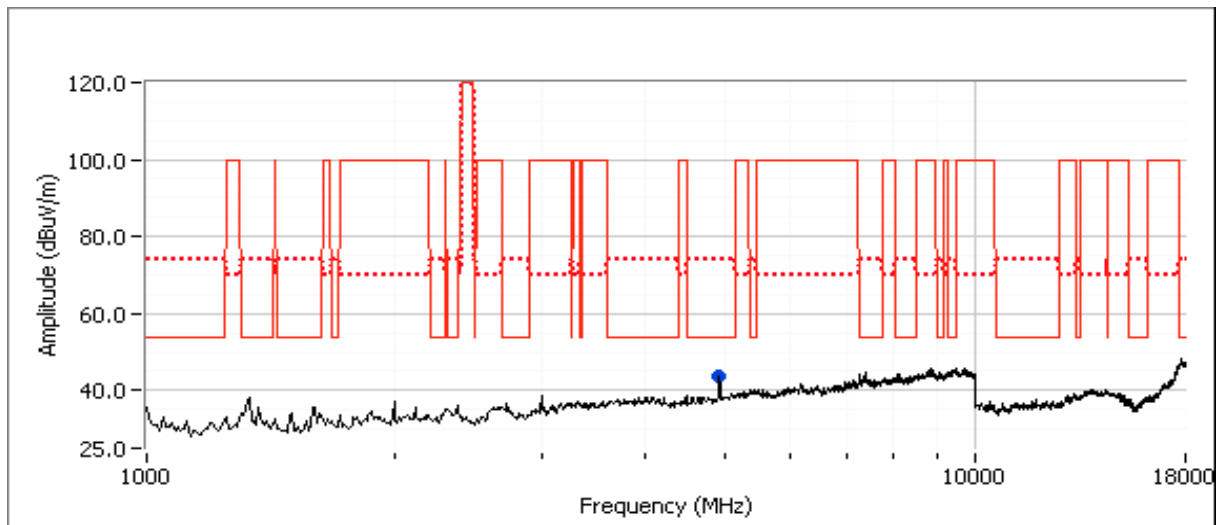

Client:	Intel Corporation	Job Number:	J80050
Model:	62205ANHMW (Intel® Centrino® Advanced-N 6205)	T-Log Number:	T80123
Contact:	Steven Hackett	Account Manager:	Christine Krebil
Standard:	FCC 15.247 / FCC 15 E / RSS 210 / FCC 15 B	Class:	N/A

Run # 6, Radiated Spurious Emissions, 1-26GHz, Receive Mode Chain A, Chain B and Chain A+B

Date of Test: 8/9/2010
 Test Location: FT Chamber #5
 Test Engineer: Mehran Birgani
 Config Change: none

Run # 6a, EUT on Channel #6 2437MHz - Receive, Chain A

Spurious Radiated Emissions:

Frequency	Level	Pol	15.209/15.247		Detector	Azimuth	Height	Comments
MHz	dB μ V/m	v/h	Limit	Margin	Pk/QP/Avg	degrees	meters	
1328.670	37.8	V	54.0	-16.2	AVG	33	1.0	RB 1 MHz;VB 10 Hz;Pk
1330.970	52.5	V	74.0	-21.5	PK	33	1.0	RB 1 MHz;VB 3 MHz;Pk
1590.120	23.2	V	54.0	-30.8	AVG	351	1.0	RB 1 MHz;VB 10 Hz;Pk
1599.220	32.2	V	74.0	-41.8	PK	351	1.0	RB 1 MHz;VB 3 MHz;Pk

Note 1: For emissions in restricted bands, the limit of 15.209 was used. For all other emissions, the limit is -30dBc for peak measurements in a measurement bandwidth of 100kHz.

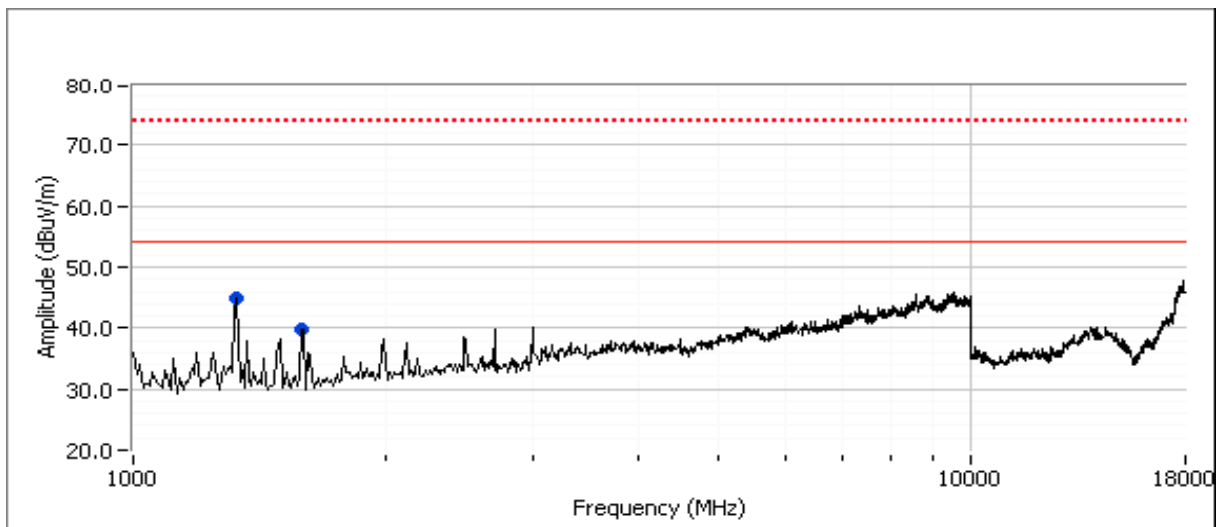

Client:	Intel Corporation	Job Number:	J80050
Model:	62205ANHMW (Intel® Centrino® Advanced-N 6205)	T-Log Number:	T80123
Contact:	Steven Hackett	Account Manager:	Christine Krebil
Standard:	FCC 15.247 / FCC 15 E / RSS 210 / FCC 15 B	Class:	N/A

Run # 6b: , EUT on Channel #6B 2437MHz - Receive, Chain B

Date of Test: 8/9/2010

Test Engineer: Rafael Varelas

Test Location: FT Chamber #5

Config Change: none

Spurious Radiated Emissions:

Frequency MHz	Level dB μ V/m	Pol v/h	15.209/15.247		Detector Pk/QP/Avg	Azimuth degrees	Height meters	Comments
			Limit	Margin				
2517.520	36.4	V	54.0	-17.6	AVG	293	1.0	RB 1 MHz;VB 10 Hz;Pk
2526.160	42.3	V	74.0	-31.7	PK	293	1.0	RB 1 MHz;VB 3 MHz;Pk
1321.450	30.1	H	54.0	-23.9	AVG	46	1.6	RB 1 MHz;VB 10 Hz;Pk
1321.650	42.2	H	74.0	-31.8	PK	46	1.6	RB 1 MHz;VB 3 MHz;Pk
1590.150	31.4	V	54.0	-22.6	AVG	355	1.0	RB 1 MHz;VB 10 Hz;Pk
1598.710	43.0	V	74.0	-31.0	PK	355	1.0	RB 1 MHz;VB 3 MHz;Pk

Note 1: For emissions in restricted bands, the limit of 15.209 was used. For all other emissions, the limit is -30dBc for peak measurements in a measurement bandwidth of 100kHz.

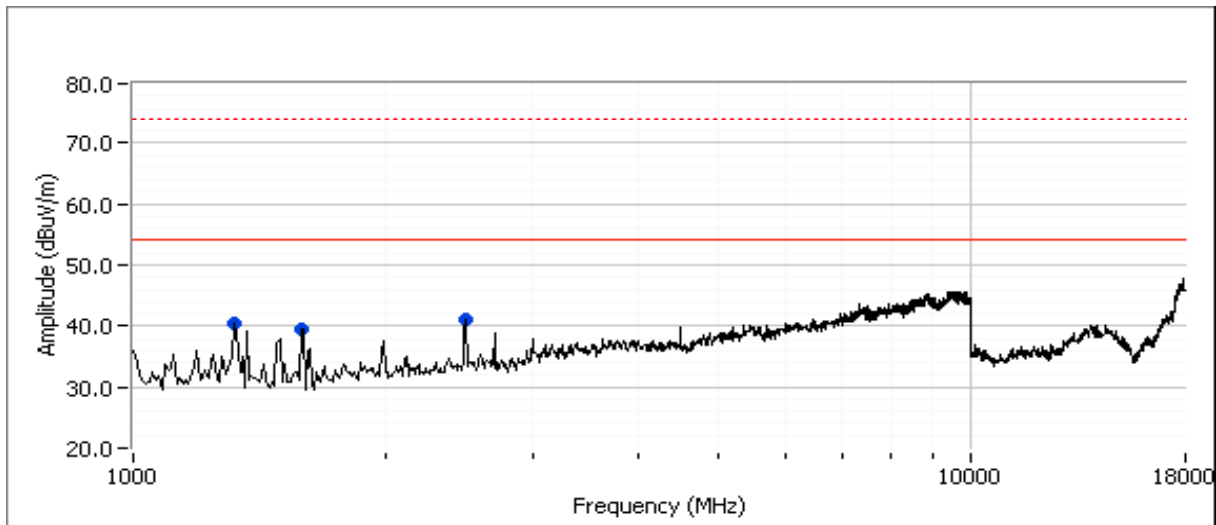

Client:	Intel Corporation	Job Number:	J80050
Model:	62205ANHMW (Intel® Centrino® Advanced-N 6205)	T-Log Number:	T80123
Contact:	Steven Hackett	Account Manager:	Christine Krebil
Standard:	FCC 15.247 / FCC 15 E / RSS 210 / FCC 15 B	Class:	N/A

Run # 6c : , EUT on Channel #6 A+B 2437MHz - Receive, Chain A+B

Spurious Radiated Emissions:

Frequency MHz	Level dB μ V/m	Pol v/h	15.209/15.247		Detector Pk/QP/Avg	Azimuth degrees	Height meters	Comments
			Limit	Margin				
1594.160	32.3	V	54.0	-21.7	AVG	321	1.3	RB 1 MHz;VB 10 Hz;Pk
1595.960	44.4	V	74.0	-29.6	PK	321	1.3	RB 1 MHz;VB 3 MHz;Pk
1314.260	30.8	H	54.0	-23.2	AVG	296	1.9	RB 1 MHz;VB 10 Hz;Pk
1313.900	39.8	H	74.0	-34.2	PK	296	1.9	RB 1 MHz;VB 3 MHz;Pk
3011.770	31.8	V	54.0	-22.2	AVG	30	1.0	RB 1 MHz;VB 10 Hz;Pk
3016.770	43.4	V	74.0	-30.6	PK	30	1.0	RB 1 MHz;VB 3 MHz;Pk

Note 1: For emissions in restricted bands, the limit of 15.209 was used. For all other emissions, the limit is -30dBc for peak measurements in a measurement bandwidth of 100kHz.

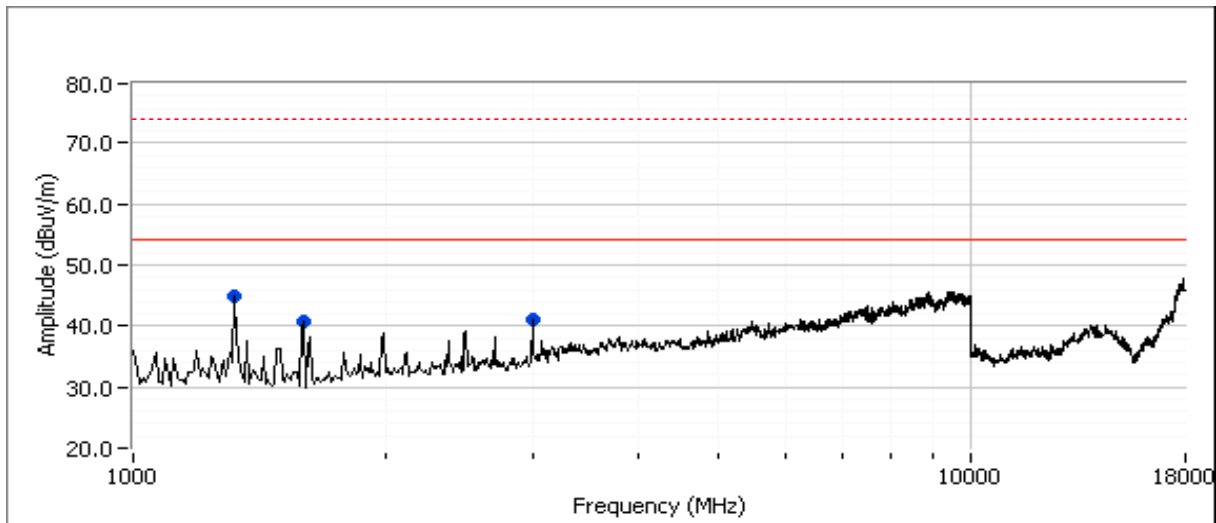

Client:	Intel Corporation	Job Number:	J80050
Model:	62205ANHMW (Intel® Centrino® Advanced-N 6205)	T-Log Number:	T80123
Contact:	Steven Hackett	Account Manager:	Christine Krebil
Standard:	FCC 15.247 / FCC 15 E / RSS 210 / FCC 15 B	Class:	N/A

RSS 210 and FCC 15.247 (5GHz DTS) Transmitter and Receiver Spurious

Test Specific Details

Objective: The objective of this test session is to perform final qualification testing of the EUT with respect to the specification listed above.

General Test Configuration

The EUT was installed into a test fixture such that the EUT was exposed (i.e. outside of a host PC).
For radiated emissions testing the measurement antenna was located 3 meters from the EUT.

Summary of Results

MAC Address: 001500633B14 DRTU Tool Version 1.1.3 Driver version 13.0.0.238 Sample: 1340

Run #	Mode	Channel	Target Power	Measured Power	Test Performed	Limit	Result / Margin
First set of measurements - center channel in each band to determine which mode has the highest emissions. SISO modes evaluated at the same per chain power as the highest single chain power to cover both MIMO & SISO operation.							
Run # 1	n40 Chain A+B	#159 5795MHz	A: 16.5 B: 16.5	A: 16.7 B: 16.8	Radiated Emissions, 1 - 40 GHz	FCC 15.209/15.247	43.6dBµV/m @ 11590.6MHz (-10.4dB)
Run # 2	n20 Chain A+B	#157 5785MHz	A: 16.5 B: 16.5	A: 16.7 B: 16.7	Radiated Emissions, 1 - 40 GHz	FCC 15.209/15.247	46.9dBµV/m @ 11569.7MHz (-7.1dB)
Run # 3	802.11a Chain A	#157 5785MHz	16.5	16.7	Radiated Emissions, 1 - 40 GHz	FCC 15.209/15.247	46.8dBµV/m @ 11570.0MHz (-7.2dB)
	802.11a Chain B	#157 5785MHz	16.5	16.7	Radiated Emissions, 1 - 40 GHz	FCC 15.209/15.247	40.7dBµV/m @ 11569.9MHz (-13.3dB)
Final measurements - top and bottom channels in each band in the worst case mode for each band.							
Run # 4	n20 Chain A+B	#149 5745MHz	A: 16.5 B: 16.5	A: 16.7 B: 16.8	Radiated Emissions, 1 - 40 GHz	FCC 15.209/15.247	44.4dBµV/m @ 11489.0MHz (-9.6dB)
		#165 5825MHz	A: 16.5 B: 16.5	A: 16.6 B: 16.8			47.1dBµV/m @ 11649.9MHz (-6.9dB)
Run # 5	Receive Chain A, Chain B and Chain A+B	#157A 5795MHz	-	-	Radiated Emissions, 1 - 18 GHz	RSS 210	35.2dBµV/m @ 1328.9MHz (-18.8dB)
		#157B 5795MHz	-	-			39.8dBµV/m @ 1328.3MHz (-14.2dB)
		#157A+B 5795MHz	-	-			39.4dBµV/m @ 1329.6MHz (-14.6dB)

Note - the target and measured power are average powers (measured with average power sensor) and are used for reference purposes only. Power is set using " GAIN CONTROL" mode in the DRTU tool.

Client:	Intel Corporation	Job Number:	J80050
Model:	62205ANHMW (Intel® Centrino® Advanced-N 6205)	T-Log Number:	T80123
		Account Manager:	Christine Krebil
Contact:	Steven Hackett		
Standard:	FCC 15.247 / FCC 15 E / RSS 210 / FCC 15 B	Class:	N/A

Ambient Conditions:

Rel. Humidity: 15 - 55 %
 Temperature: 18 - 25 °C

Modifications Made During Testing

No modifications were made to the EUT during testing

Deviations From The Standard

No deviations were made from the requirements of the standard.

Client:	Intel Corporation	Job Number:	J80050
Model:	62205ANHMW (Intel® Centrino® Advanced-N 6205)	T-Log Number:	T80123
Contact:	Steven Hackett	Account Manager:	Christine Krebil
Standard:	FCC 15.247 / FCC 15 E / RSS 210 / FCC 15 B	Class:	N/A

Run # 1, Radiated Spurious Emissions, 1-40GHz, n40, Chain A+B
 Date of Test: 8/9/2010 Test Location: FT Chamber #5
 Test Engineer: Rafael Varelas Config Change: none

For emissions in restricted bands, the limit of 15.209 was used. For all other emissions, the limit is -30dBc eirp measured in 100kHz.

Run # 1a: EUT on Channel #159 5795MHz - n40, Chain A+B

Chain	Target (dBm)				Power Settings Measured (dBm)				Software Setting
	A	B	C	Total	A	B	C	Total	
	16.5	16.5		19.5	16.7	16.8		19.8	33.0/32.5

Spurious Radiated Emissions:

Frequency	Level	Pol	15.209/15.247		Detector	Azimuth	Height	Comments
MHz	dB μ V/m	v/h	Limit	Margin	Pk/QP/Avg	degrees	meters	
11590.570	43.6	V	54.0	-10.4	AVG	43	1.5	RB 1 MHz;VB 10 Hz;Pk
11590.120	56.8	V	74.0	-17.2	PK	43	1.5	RB 1 MHz;VB 3 MHz;Pk
2489.210	40.5	V	54.0	-13.5	Peak	321	1.3	
17380.520	48.6	H	70.0	-21.4	Peak	304	1.0	

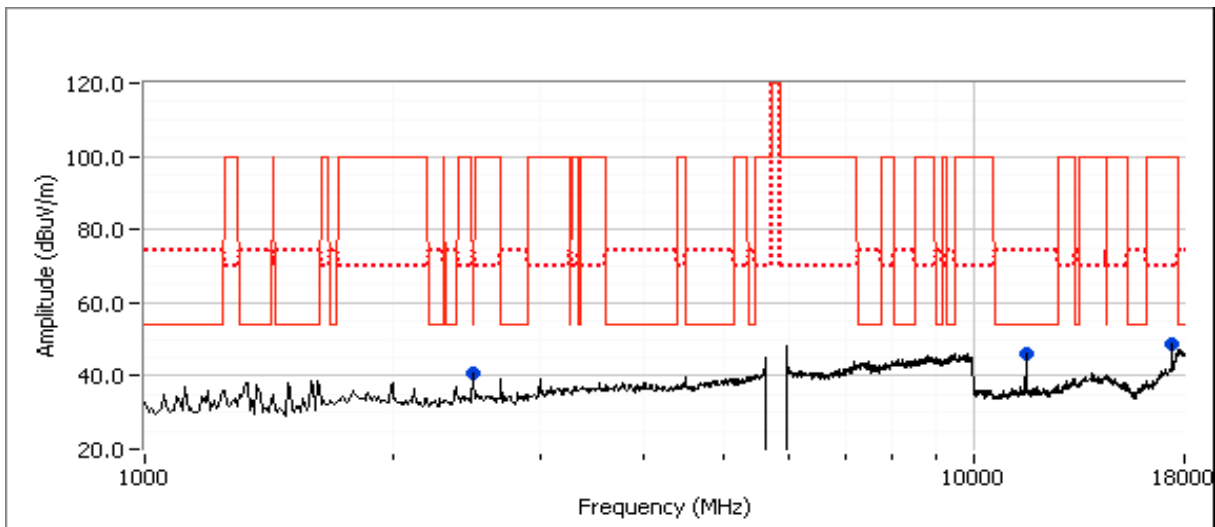

Client:	Intel Corporation	Job Number:	J80050
Model:	62205ANHMW (Intel® Centrino® Advanced-N 6205)	T-Log Number:	T80123
Contact:	Steven Hackett	Account Manager:	Christine Krebil
Standard:	FCC 15.247 / FCC 15 E / RSS 210 / FCC 15 B	Class:	N/A

Run # 2, Radiated Spurious Emissions, 1-40GHz, n20, Chain A+B
 Date of Test: 8/9/2010 Test Location: FT Chamber #5
 Test Engineer: Rafael Varelas Config Change: none

For emissions in restricted bands, the limit of 15.209 was used. For all other emissions, the limit is -30dBc eirp measured in 100kHz.

Run # 2a: EUT on Channel #157 5785MHz - n20, Chain A+B

Chain	Target (dBm)				Power Settings Measured (dBm)				Software Setting
	A	B	C	Total	A	B	C	Total	
	16.5	16.5		19.5	16.7	16.7		19.7	32.0/31.5

Spurious Radiated Emissions:

Frequency	Level	Pol	15.209/15.247		Detector	Azimuth	Height	Comments
MHz	dB μ V/m	v/h	Limit	Margin	PK/QP/Avg	degrees	meters	
11569.720	46.9	V	54.0	-7.1	AVG	360	1.9	RB 1 MHz;VB 10 Hz;Pk
11570.320	60.3	V	74.0	-13.7	PK	360	1.9	RB 1 MHz;VB 3 MHz;Pk
1866.660	44.6	H	70.0	-25.4	Peak	77	1.3	

Note 1: No emissions observed above 18GHz when scanning with the measurement antenna within 20cm of the device.

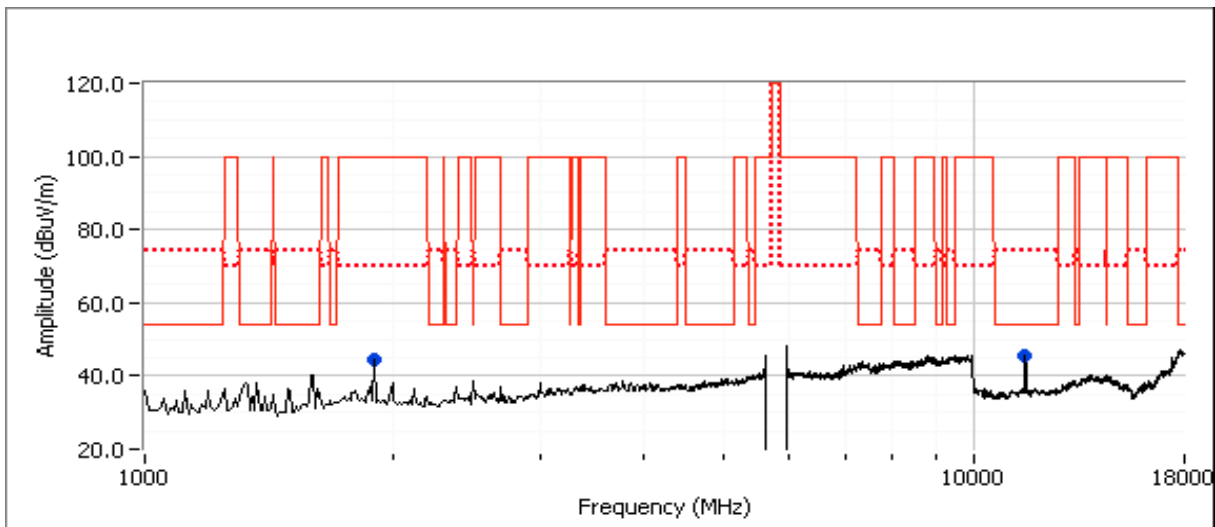

Client:	Intel Corporation	Job Number:	J80050
Model:	62205ANHMW (Intel® Centrino® Advanced-N 6205)	T-Log Number:	T80123
Contact:	Steven Hackett	Account Manager:	Christine Krebil
Standard:	FCC 15.247 / FCC 15 E / RSS 210 / FCC 15 B	Class:	N/A

Run # 3b: EUT on Channel #157 5785MHz - 802.11a Chain B

	Target (dBm)	Power Settings Measured (dBm)	Software Setting
Chain B	16.5	16.7	26.0

Spurious Radiated Emissions:

Frequency MHz	Level dB μ V/m	Pol v/h	15.209/15.247		Detector PK/QP/Avg	Azimuth degrees	Height meters	Comments
			Limit	Margin				
11569.890	40.7	V	54.0	-13.3	AVG	0	1.0	MHz;VB 10 Hz;Pk
11569.180	52.6	V	74.0	-21.4	PK	0	1.0	MHz;VB 3 MHz;Pk
2494.170	40.1	V	54.0	-13.9	Peak	301	1.0	

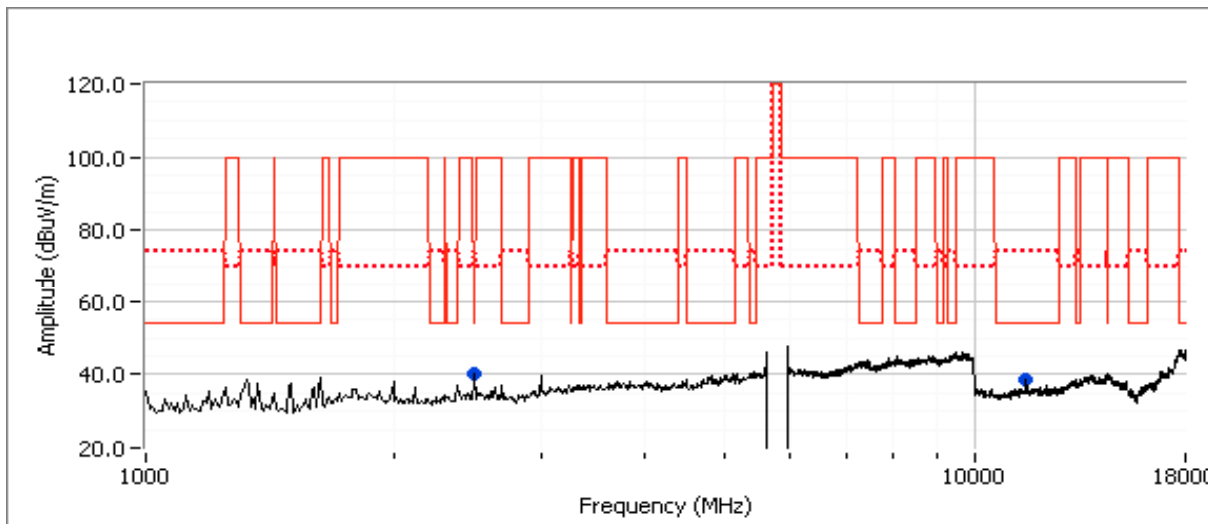

Client:	Intel Corporation	Job Number:	J80050
Model:	62205ANHMW (Intel® Centrino® Advanced-N 6205)	T-Log Number:	T80123
Contact:	Steven Hackett	Account Manager:	Christine Krebil
Standard:	FCC 15.247 / FCC 15 E / RSS 210 / FCC 15 B	Class:	N/A

Run # 4, Radiated Spurious Emissions, 1-40GHz, n20, Chain A+B
 Date of Test: 8/9/2010 Test Location: FT Chamber #5
 Test Engineer: Rafael Varelas Config Change: none

For emissions in restricted bands, the limit of 15.209 was used. For all other emissions, the limit is -30dBc eirp measured in 100kHz.

Run # 4a: EUT on Channel #149 5745MHz - n20, Chain A+B

Chain	Target (dBm)				Power Settings Measured (dBm)				Software Setting
	A	B	C	Total	A	B	C	Total	
	16.5	16.5		19.5	16.7	16.8		19.8	

Spurious Radiated Emissions:

Frequency	Level	Pol	15.209/15.247		Detector	Azimuth	Height	Comments
MHz	dB μ V/m	v/h	Limit	Margin	Pk/QP/Avg	degrees	meters	
11488.980	44.4	V	54.0	-9.6	AVG	266	1.6	RB 1 MHz;VB 10 Hz;Pk
11490.320	57.4	V	74.0	-16.6	PK	266	1.6	RB 1 MHz;VB 3 MHz;Pk
2489.120	39.2	V	54.0	-14.8	Peak	310	1.3	
17234.540	45.8	H	70.0	-24.2	Peak	313	1.0	

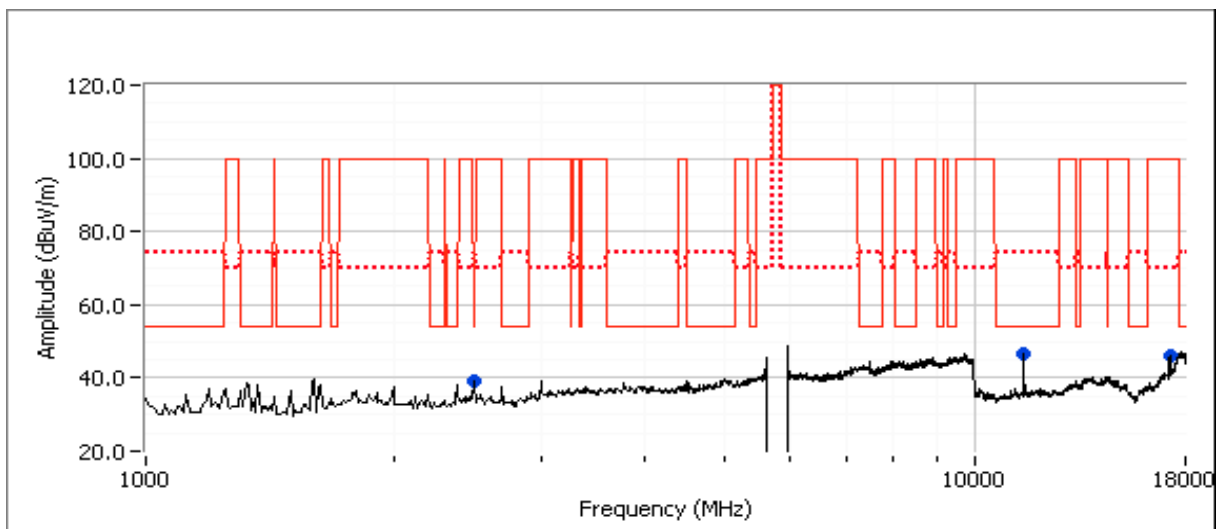

Client:	Intel Corporation	Job Number:	J80050
Model:	62205ANHMW (Intel® Centrino® Advanced-N 6205)	T-Log Number:	T80123
Contact:	Steven Hackett	Account Manager:	Christine Krebil
Standard:	FCC 15.247 / FCC 15 E / RSS 210 / FCC 15 B	Class:	N/A

Run # 4b: EUT on Channel #165 5825MHz - n20, Chain A+B

Chain	Target (dBm)				Power Settings Measured (dBm)				Software Setting
	A	B	C	Total	A	B	C	Total	
	16.5	16.5		19.5	16.6	16.8		19.7	31.5/31.5

Spurious Radiated Emissions:

Frequency	Level	Pol	15.209/15.247		Detector	Azimuth	Height	Comments
MHz	dB μ V/m	v/h	Limit	Margin	Pk/QP/Avg	degrees	meters	
11649.850	47.1	V	54.0	-6.9	AVG	117	1.7	RB 1 MHz;VB 10 Hz;Pk
11650.050	60.1	V	74.0	-13.9	PK	117	1.7	RB 1 MHz;VB 3 MHz;Pk
2491.330	38.9	V	54.0	-15.1	Peak	321	1.3	
17479.050	48.9	H	70.0	-21.1	Peak	45	1.0	

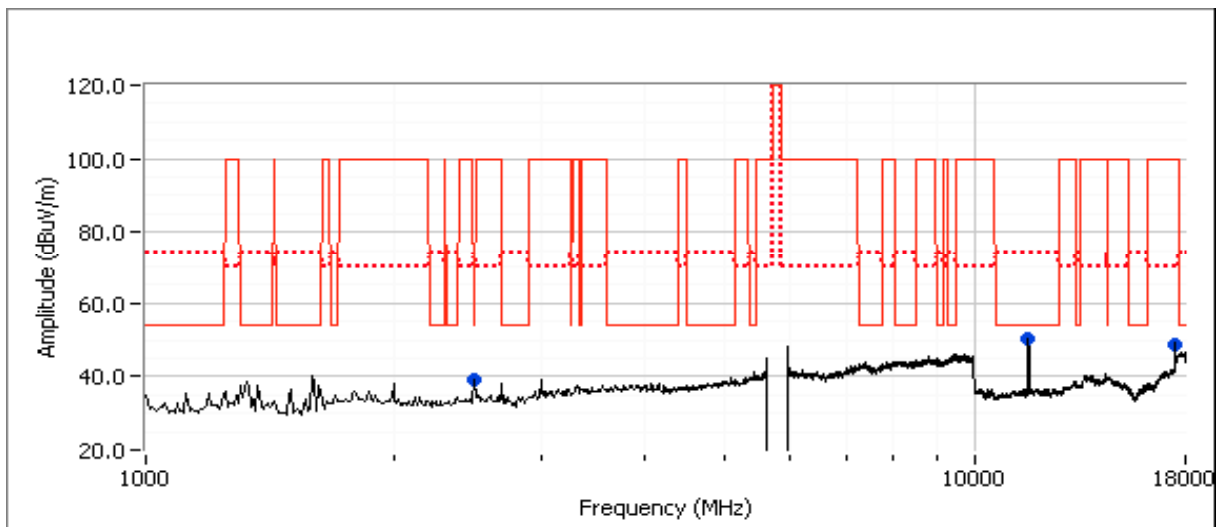

Client:	Intel Corporation	Job Number:	J80050
Model:	62205ANHMW (Intel® Centrino® Advanced-N 6205)	T-Log Number:	T80123
Contact:	Steven Hackett	Account Manager:	Christine Krebil
Standard:	FCC 15.247 / FCC 15 E / RSS 210 / FCC 15 B	Class:	N/A

Run # 5, Radiated Spurious Emissions, 1-18GHz, Receive Mode Chain A, Chain B and Chain A+B

Date of Test: 8/9/2010
 Test Location: FT Chamber #5
 Test Engineer: Rafael Varelas
 Config Change: none

Run # 5a, EUT on 5785MHz - Receive, Chain A

Spurious Radiated Emissions:

Frequency MHz	Level dB μ V/m	Pol v/h	RSS 210		Detector Pk/QP/Avg	Azimuth degrees	Height meters	Comments
			Limit	Margin				
1328.870	35.2	V	54.0	-18.8	AVG	259	1.0	RB 1 MHz;VB 10 Hz;Pk
1331.270	49.5	V	74.0	-24.5	PK	259	1.0	RB 1 MHz;VB 3 MHz;Pk
2489.970	32.7	V	54.0	-21.3	AVG	338	1.0	RB 1 MHz;VB 10 Hz;Pk
2490.630	47.4	V	74.0	-26.6	PK	338	1.0	RB 1 MHz;VB 3 MHz;Pk

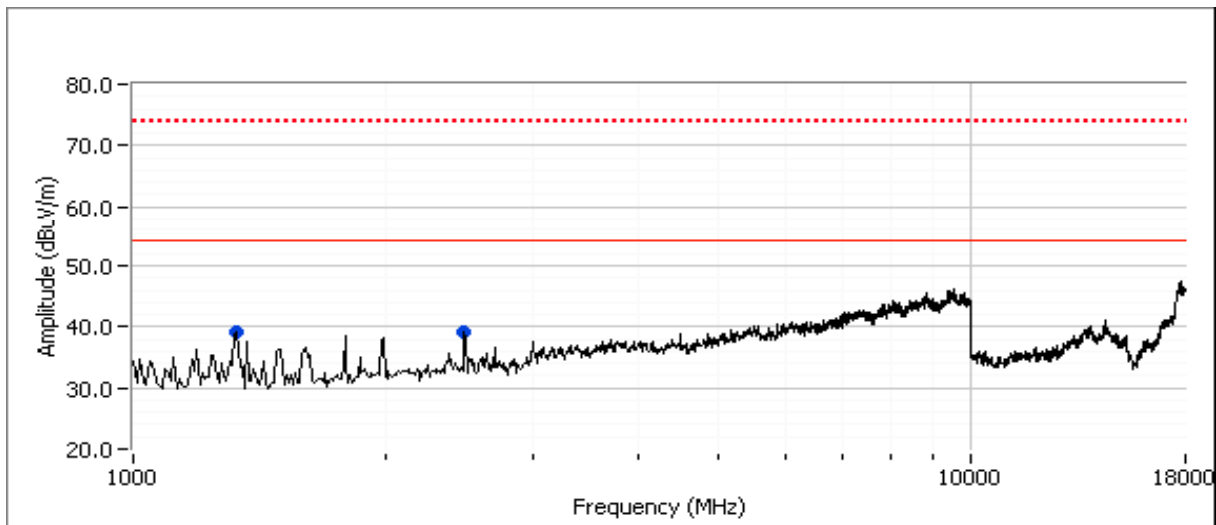

Client:	Intel Corporation	Job Number:	J80050
Model:	62205ANHMW (Intel® Centrino® Advanced-N 6205)	T-Log Number:	T80123
Contact:	Steven Hackett	Account Manager:	Christine Krebil
Standard:	FCC 15.247 / FCC 15 E / RSS 210 / FCC 15 B	Class:	N/A

Run # 5b, EUT on 5785MHz - Receive, Chain B

Spurious Radiated Emissions:

Frequency MHz	Level dB μ V/m	Pol v/h	RSS 210		Detector PK/QP/Avg	Azimuth degrees	Height meters	Comments
			Limit	Margin				
1328.270	39.8	V	54.0	-14.2	AVG	261	1.4	RB 1 MHz;VB 10 Hz;Pk
1331.530	51.6	V	74.0	-22.4	PK	261	1.4	RB 1 MHz;VB 3 MHz;Pk
2490.610	32.6	V	54.0	-21.4	AVG	296	1.0	RB 1 MHz;VB 10 Hz;Pk
2497.010	49.3	V	74.0	-24.7	PK	296	1.0	RB 1 MHz;VB 3 MHz;Pk

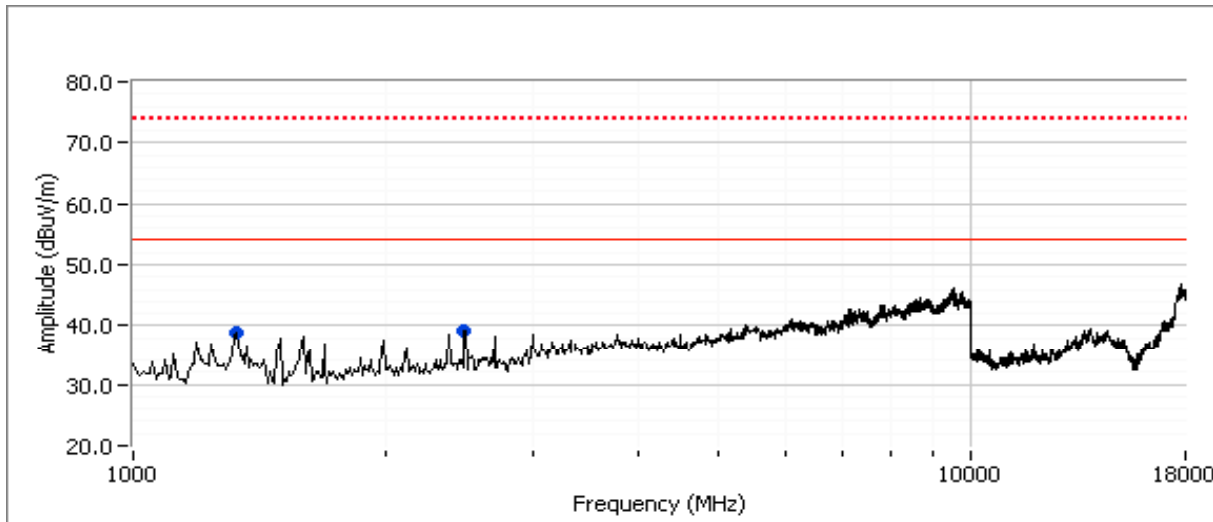

Client:	Intel Corporation	Job Number:	J80050
Model:	62205ANHMW (Intel® Centrino® Advanced-N 6205)	T-Log Number:	T80123
Contact:	Steven Hackett	Account Manager:	Christine Krebil
Standard:	FCC 15.247 / FCC 15 E / RSS 210 / FCC 15 B	Class:	N/A

Run # 5c, EUT on 5785MHz - Receive, Chain A+B

Spurious Radiated Emissions:

Frequency MHz	Level dB μ V/m	Pol v/h	RSS 210		Detector PK/QP/Avg	Azimuth degrees	Height meters	Comments
			Limit	Margin				
1329.610	39.4	V	54.0	-14.6	AVG	275	1.4	RB 1 MHz;VB 10 Hz;Pk
1330.880	55.0	V	74.0	-19.0	PK	275	1.4	RB 1 MHz;VB 3 MHz;Pk
2489.930	33.1	V	54.0	-20.9	AVG	317	1.2	RB 1 MHz;VB 10 Hz;Pk
2490.700	48.8	V	74.0	-25.2	PK	317	1.2	RB 1 MHz;VB 3 MHz;Pk

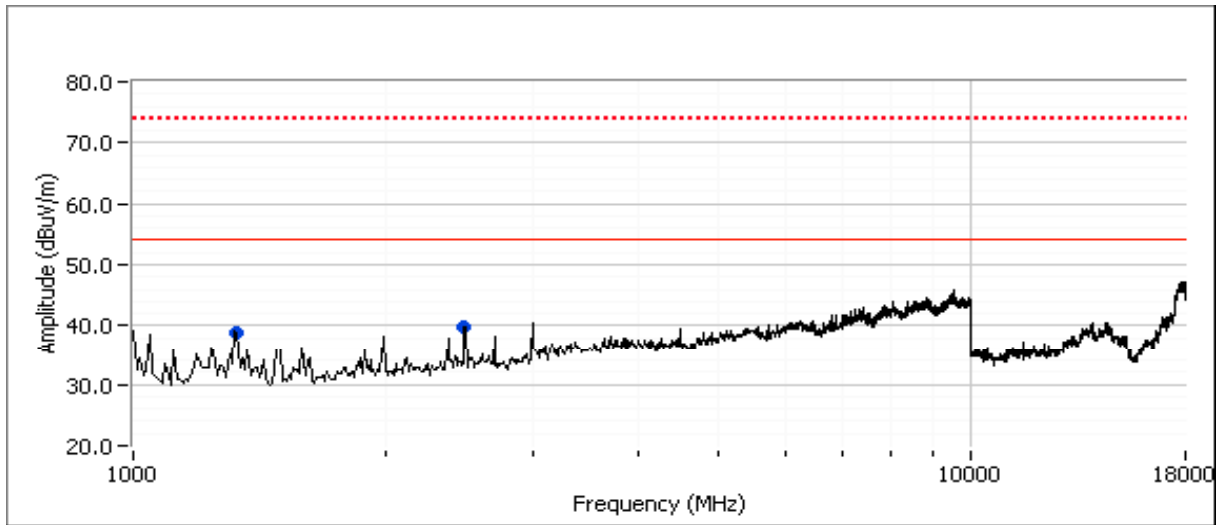

Client:	Intel Corporation	Job Number:	J80050
Model:	62205ANHMW (Intel® Centrino® Advanced-N 6205)	T-Log Number:	T80123
Contact:	Steven Hackett	Account Manager:	Christine Krebil
Standard:	FCC 15.247 / FCC 15 E / RSS 210 / FCC 15 B	Class:	N/A

**RSS 210 and FCC 15.247 (DTS) Antenna Port Measurements
Power, PSD, Bandwidth and Spurious Emissions**

Test Specific Details

Objective: The objective of this test session is to perform final qualification testing of the EUT with respect to the specification listed above.

Date of Test: 8/12/2010
 Test Engineer: Rafael Varelas/Mark Hill
 Test Location: FT Chamber #3

Config. Used: 1
 Config Change: none
 Host Unit Voltage 120V/60Hz

General Test Configuration

The EUT was connected to the spectrum analyzer or power meter via a suitable attenuator. All measurements were made on a single chain.

All measurements have been corrected to allow for the external attenuators used.

Ambient Conditions:

Temperature: 22 °C
 Rel. Humidity: 37 %

Summary of Results

MAC Address: 001500633B14 DRTU Tool Version 1.1.3 Driver version 13.0.0.238 Sample: 1340

Run #	Pwr setting	Avg Pwr	Test Performed	Limit	Pass / Fail	Result / Margin
1	-	15.5	802.11b Output Power	15.247(b)	Pass	17.1 dBm
1	-	16.5	802.11g Output Power	15.247(b)	Pass	20.7 dBm
2	-	15.5	802.11b Power spectral Density	15.247(d)	Pass	-10.0 dBm/3kHz
2	-	16.6	802.11g Power spectral Density	15.247(d)	Pass	-7.5 dBm/3kHz
3	-	15.5	802.11b Minimum 6dB Bandwidth	15.247(a)	Pass	10.33 MHz
3	-	15.5	802.11b 99% Bandwidth	RSS GEN	-	15.39 MHz
3	-	14.0	802.11g Minimum 6dB Bandwidth	15.247(a)	Pass	16.17 MHz
3	-	14.0	802.11g 99% Bandwidth	RSS GEN	-	16.97 MHz
4	-	-	802.11b/g Spurious emissions	15.247(b)	Pass	All emissions below -20dBc limit

Modifications Made During Testing

No modifications were made to the EUT during testing

Deviations From The Standard

No deviations were made from the requirements of the standard.

Client:	Intel Corporation	Job Number:	J80050
Model:	62205ANHMW (Intel® Centrino® Advanced-N 6205)	T-Log Number:	T80123
Contact:	Steven Hackett	Account Manager:	Christine Krebil
Standard:	FCC 15.247 / FCC 15 E / RSS 210 / FCC 15 B	Class:	N/A

Run #1: Output Power

Power Setting ²	Frequency (MHz)	Output Power		Antenna Gain (dBi)	Result	EIRP		Output Power	
		(dBm) ¹	mW			dBm	W	(dBm) ³	mW
802.11b Mode, Chain A									
25.5	2412	17.0	50.1	3.2	Pass	20.2	0.106	15.5	35.5
25.0	2437	17.1	51.3	3.2	Pass	20.3	0.107	15.7	37.2
24.0	2462	16.7	46.8	3.2	Pass	19.9	0.098	15.5	35.5
802.11b Mode, Chain B									
23.0	2412	16.9	49.0	3.2	Pass	20.1	0.103	15.6	36.3
23.0	2437	17.0	50.1	3.2	Pass	20.2	0.106	15.7	37.2
23.0	2462	17.0	50.1	3.2	Pass	20.2	0.106	15.6	36.3
802.11g Mode, Chain A									
28.5	2412	19.0	79.4	3.2	Pass	22.2	0.167	14.0	25.1
31.0	2437	20.5	112.2	3.2	Pass	23.7	0.237	16.6	45.7
27.5	2462	19.0	79.4	3.2	Pass	22.2	0.167	14.0	25.1
802.11g Mode, Chain B									
26.0	2412	19.2	83.2	3.2	Pass	22.4	0.175	14.1	25.7
29.0	2437	20.7	117.5	3.2	Pass	23.9	0.248	16.5	44.7
26.0	2462	19.3	85.1	3.2	Pass	22.5	0.179	14.1	25.7

Note 1: Power measured using a peak power meter.

Note 2: Power setting - the software power setting used during testing, included for reference only.

Note 3: Power measured using average power meter and is included for reference only.

Client:	Intel Corporation	Job Number:	J80050
Model:	62205ANHMW (Intel® Centrino® Advanced-N 6205)	T-Log Number:	T80123
Contact:	Steven Hackett	Account Manager:	Christine Krebil
Standard:	FCC 15.247 / FCC 15 E / RSS 210 / FCC 15 B	Class:	N/A

Run #2: Power spectral Density

Power Setting	Frequency (MHz)	PSD	Limit dBm/3kHz	Result
		(dBm/3kHz) ^{Note 1}		
802.11b Mode, Chain A				
25.5	2413.987	-10.8	8.0	Pass
25	2436.448	-10.0	8.0	Pass
24	2460.987	-10.5	8.0	Pass
802.11b Mode, Chain B				
23	2413.987	-10.5	8.0	Pass
23	2437.988	-10.0	8.0	Pass
23	2462.987	-10.3	8.0	Pass
802.11g Mode, Chain A				
28.5	2414.475	-10.8	8.0	Pass
31	2435.393	-7.5	8.0	Pass
27.5	2459.167	-11.4	8.0	Pass
802.11g Mode, Chain B				
26	2414.449	-11.0	8.0	Pass
29	2435.736	-7.8	8.0	Pass
26	2460.103	-12.0	8.0	Pass

Note 1: Power spectral density measured using RB=3 kHz, VB=10kHz, analyzer with peak detector and with a sweep time set to ensure a dwell time of at least 1 second per 3kHz. The measurement is made at the frequency of PPSD determined from preliminary scans using RB=3kHz using multiple sweeps at a faster rate over the 6dB bandwidth of the signal.

Client:	Intel Corporation	Job Number:	J80050
Model:	62205ANHMW (Intel® Centrino® Advanced-N 6205)	T-Log Number:	T80123
Contact:	Steven Hackett	Account Manager:	Christine Krebil
Standard:	FCC 15.247 / FCC 15 E / RSS 210 / FCC 15 B	Class:	N/A

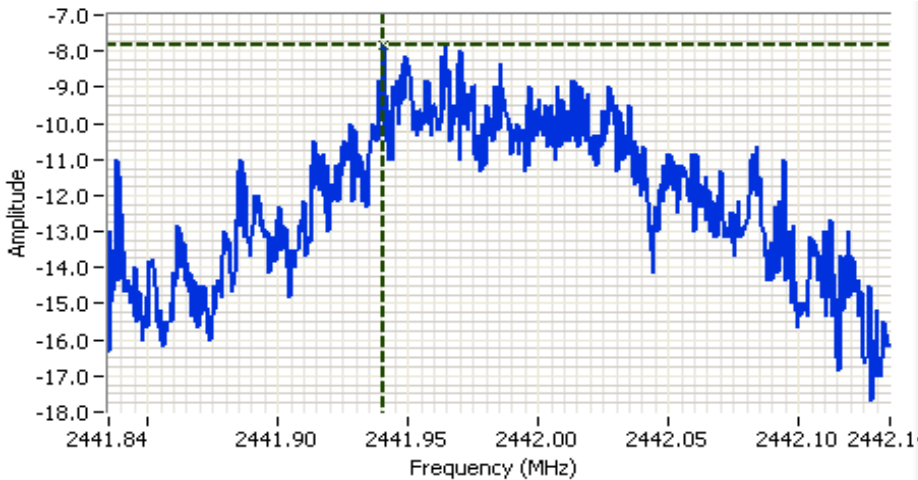

Analyzer Settings

HP8564E,EMICF: 2441.985 MHz
 SPAN: 300 kHz
 RB: 3.00 kHz
 VB: 10.0 kHz
 Detector: POS
 Attn: 10 DB
 RL Offset: 11.0 DB
 Sweep Time: 100.0s
 Ref Lvl: 11.0 DBM

Comments

Ch 6, Chain B

Cursor 1 2441.9405 -7.83

0.0000 0.00

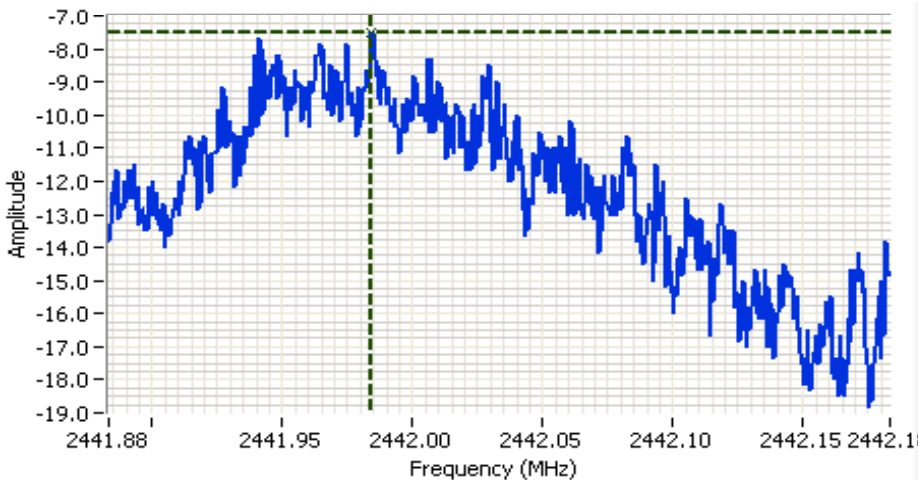

Analyzer Settings

HP8564E,EMICF: 2442.033 MHz
 SPAN: 300 kHz
 RB: 3.00 kHz
 VB: 10.0 kHz
 Detector: POS
 Attn: 10 DB
 RL Offset: 11.0 DB
 Sweep Time: 100.0s
 Ref Lvl: 11.0 DBM

Comments

Ch 6, Chain A

Cursor 1 2441.9843 -7.50

0.0000 0.00



Client:	Intel Corporation	Job Number:	J80050
Model:	62205ANHMW (Intel® Centrino® Advanced-N 6205)	T-Log Number:	T80123
Contact:	Steven Hackett	Account Manager:	Christine Krebil
Standard:	FCC 15.247 / FCC 15 E / RSS 210 / FCC 15 B	Class:	N/A

Run #3: Signal Bandwidth

Power Setting	Frequency (MHz)	Resolution Bandwidth	Bandwidth (MHz)	
			6dB	99%
802.11b Mode				
25	2437, Chain A	100kHz	11.17	15.39
23	2437, Chain B	100kHz	10.33	15.23
23	2412, Chain B	100kHz	12.25	15.14
23	2462, Chain B	100kHz	11.5	15.14
802.11g Mode				
31	2437, Chain A	100kHz	16.5	16.97
29	2437, Chain B	100kHz	16.17	16.97
26	2412, Chain B	100kHz	16.42	16.81
26	2462, Chain B	100kHz	16.42	16.89

Note 1: 99% bandwidth measured in accordance with RSS GEN, with RB > 1% of the span and VB > 3xRB (taken from power measurement plots)

Note 2: 6dB bandwidth measured on the center channel for each chain and then on the top and bottom channels for the chain with the narrowest 6dB bandwidth.

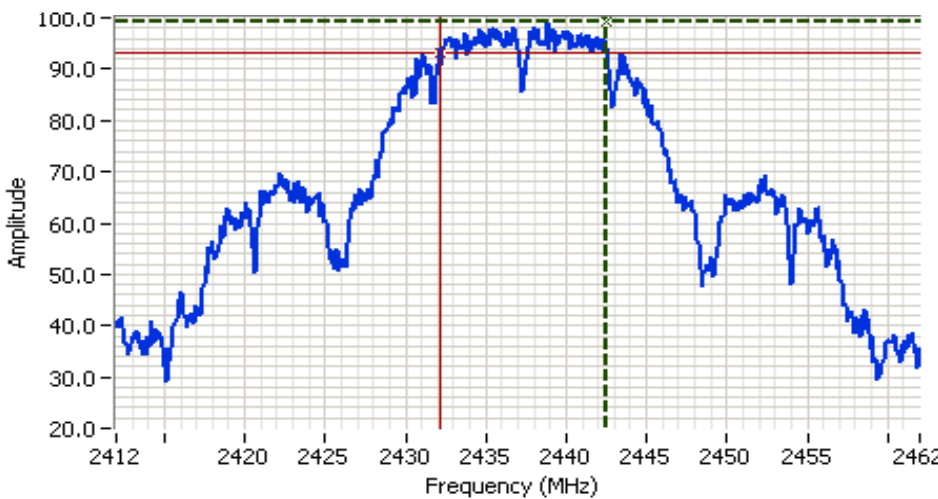

Analyzer Settings

HP8564E,EMI
 CF: 2437.000 MHz
 SPAN:50.000 MHz
 RB 100 kHz
 VB 100 kHz
 Detector POS
 Att 10
 RL Offset 0.00
 Sweep Time 50.0ms
 Ref Lvl:105.00DBUV

Comments

6dB BW: 10.333 MHz
 Ch 6, Chain B

Cursor 1	2442.5000	99.17		Delta Freq.	10.333
Cursor 2	2432.1667	93.17		Delta Amplitude	6.00



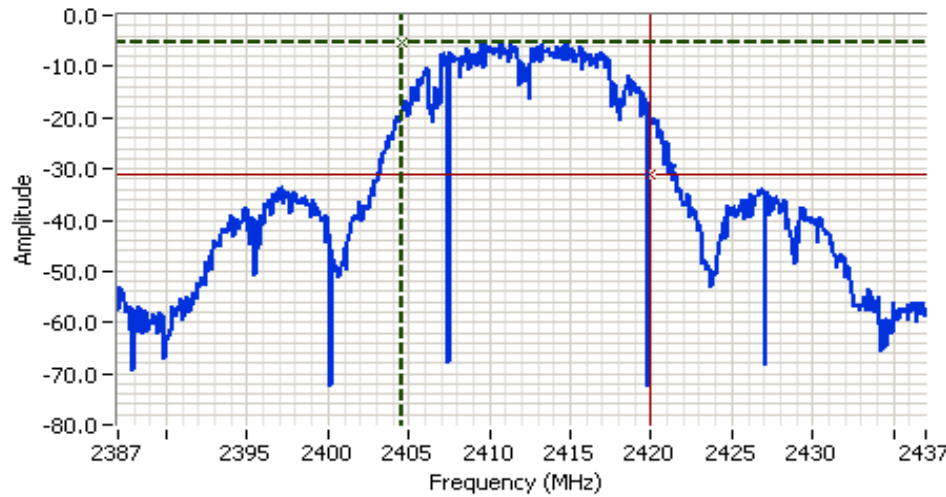

Client: Intel Corporation	Job Number: J80050
Model: 62205ANHMW (Intel® Centrino® Advanced-N 6205)	T-Log Number: T80123
Contact: Steven Hackett	Account Manager: Christine Krebil
Standard: FCC 15.247 / FCC 15 E / RSS 210 / FCC 15 B	Class: N/A



Analyzer Settings
 HP8564E,EMI
 CF: 2412.000 MHz
 SPAN:50.000 MHz
 RB 1.000 MHz
 VB 3.000 MHz
 Detector Sample
 Att 20
 RL Offset 0.00
 Sweep Time 50.0ms
 Ref Lvl:4.80DBM

Comments
 99% power BW:
 15.308 MHz
 Ch 1, Chain A

Cursor 1 2404.6373 -5.20 

Cursor 2 2419.9451 -31.20 

Delta Freq. 15.308

Delta Amplitude 26.00



Analyzer Settings
 HP8564E,EMI
 CF: 2437.000 MHz
 SPAN:50.000 MHz
 RB 100 kHz
 VB 100 kHz
 Detector POS
 Att 10
 RL Offset 0.00
 Sweep Time 50.0ms
 Ref Lvl:105.00DBUV

Comments
 6dB BW: 16.167 MHz
 Ch 6, Chain B

Cursor 1 2445.2500 95.67 

Cursor 2 2429.0833 89.67 

Delta Freq. 16.167

Delta Amplitude 6.00



Client:	Intel Corporation	Job Number:	J80050
Model:	62205ANHMW (Intel® Centrino® Advanced-N 6205)	T-Log Number:	T80123
Contact:	Steven Hackett	Account Manager:	Christine Krebil
Standard:	FCC 15.247 / FCC 15 E / RSS 210 / FCC 15 B	Class:	N/A

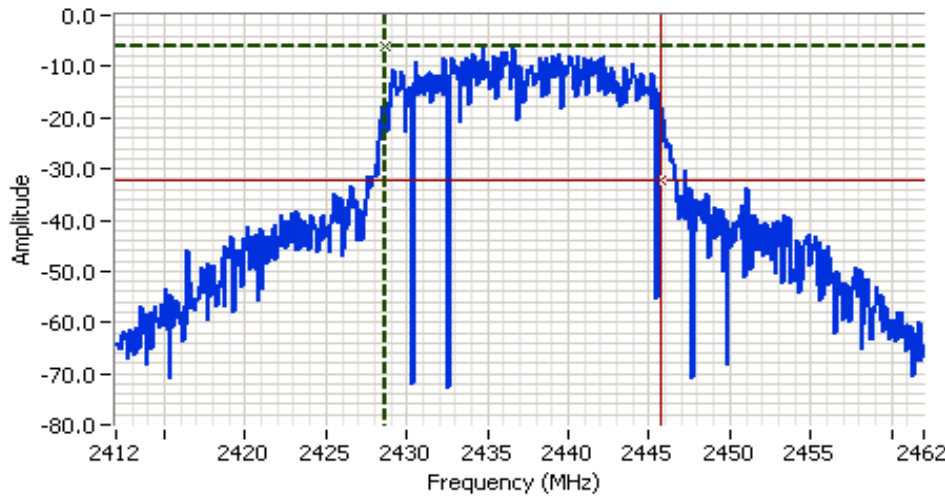

Analyzer Settings

HP8564E,EMI
 CF: 2437.000 MHz
 SPAN:50.000 MHz
 RB 1.000 MHz
 VB 3.000 MHz
 Detector Sample
 Att 20
 RL Offset 0.00
 Sweep Time 50.0ms
 Ref Lvl:4.80DBM

Comments

99% power BW:
 16.972 MHz
 Ch 6, Chain B

Cursor 1	2428.7221	-6.20	
Cursor 2	2445.6938	-32.20	

Delta Freq. 16.972
 Delta Amplitude 26.00



Client:	Intel Corporation	Job Number:	J80050
Model:	62205ANHMW (Intel® Centrino® Advanced-N 6205)	T-Log Number:	T80123
Contact:	Steven Hackett	Account Manager:	Christine Krebil
Standard:	FCC 15.247 / FCC 15 E / RSS 210 / FCC 15 B	Class:	N/A

Run #4: Out of Band Spurious Emissions

Mode	Chain	Frequency (MHz)	Limit	Result
802.11b	A	2412	-20dBc	Pass
		2437	-20dBc	Pass
		2462	-20dBc	Pass
	B	2412	-20dBc	Pass
		2437	-20dBc	Pass
		2462	-20dBc	Pass
802.11g	A	2412	-20dBc	Pass
		2437	-20dBc	Pass
		2462	-20dBc	Pass
	B	2412	-20dBc	Pass
		2437	-20dBc	Pass
		2462	-20dBc	Pass

Plots for low channel, 802.11b mode Chains A and B, power setting(s) = 25.5/23

Additional plots for each chain showing compliance with -30dBc limit from 2390 MHz to 2400 MHz. Radiated measurements used to show compliance with the limits in the restricted band below 2390 MHz.

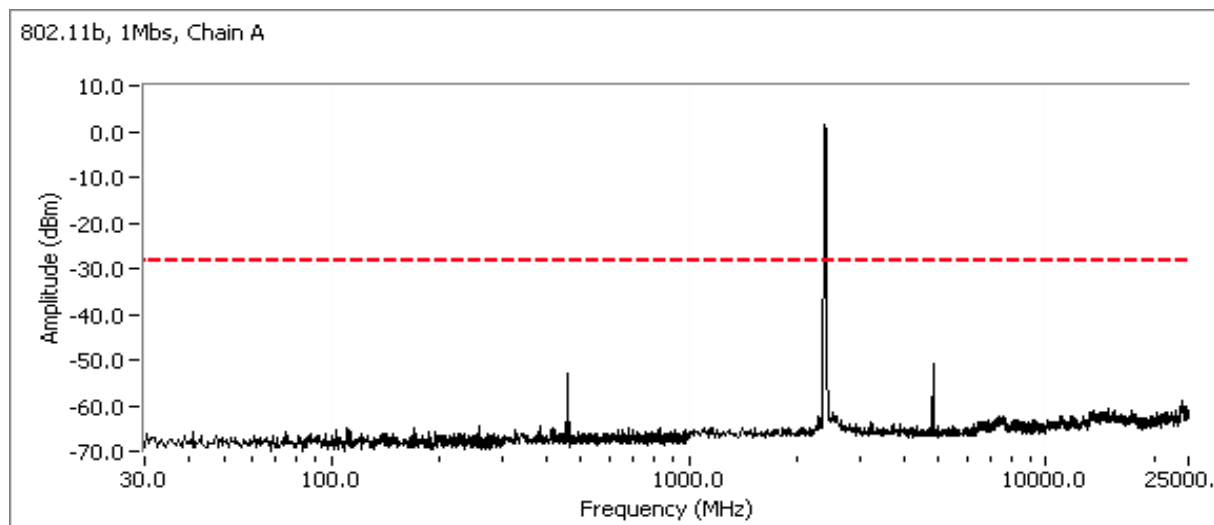

Client:	Intel Corporation	Job Number:	J80050
Model:	62205ANHMW (Intel® Centrino® Advanced-N 6205)	T-Log Number:	T80123
Contact:	Steven Hackett	Account Manager:	Christine Krebil
Standard:	FCC 15.247 / FCC 15 E / RSS 210 / FCC 15 B	Class:	N/A

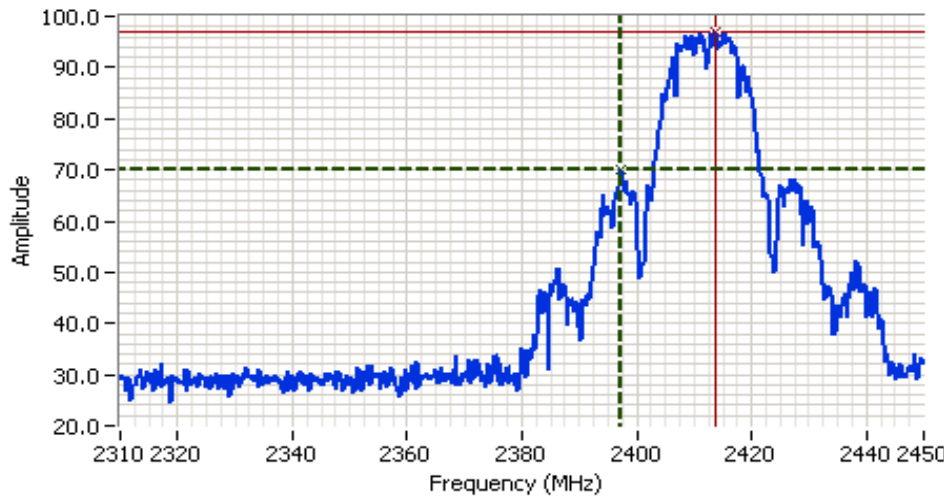

Analyzer Settings
 HP8564E,EMI
 CF: 2380.000 MHz
 SPAN:140.000 MHz
 RB 100 kHz
 VB 100 kHz
 Detector POS
 Att 10
 RL Offset 0.00
 Sweep Time 77.0ms
 Ref Lvl:105.00DBUV

Comments
 802.11b,1Mbps, channel 1, Chain A, pwr setting = 25.5

Cursor 1	2397.2666	70.00	+	-	Δ	Delta Freq.	16.567
Cursor 2	2413.8333	96.83	+	-	Δ	Delta Amplitude	26.83

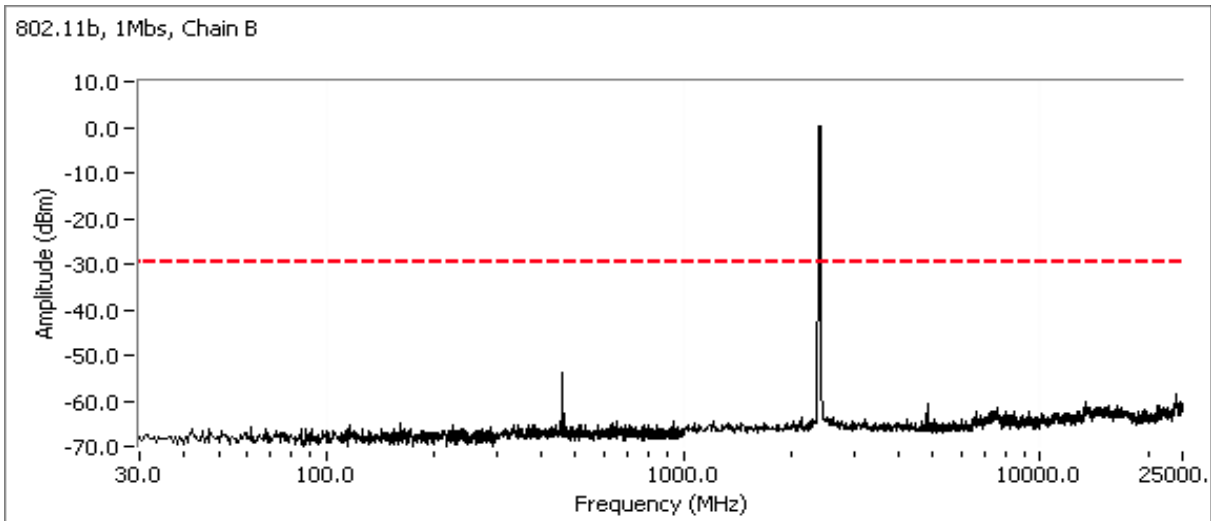

Client:	Intel Corporation	Job Number:	J80050
Model:	62205ANHMW (Intel® Centrino® Advanced-N 6205)	T-Log Number:	T80123
Contact:	Steven Hackett	Account Manager:	Christine Krebil
Standard:	FCC 15.247 / FCC 15 E / RSS 210 / FCC 15 B	Class:	N/A

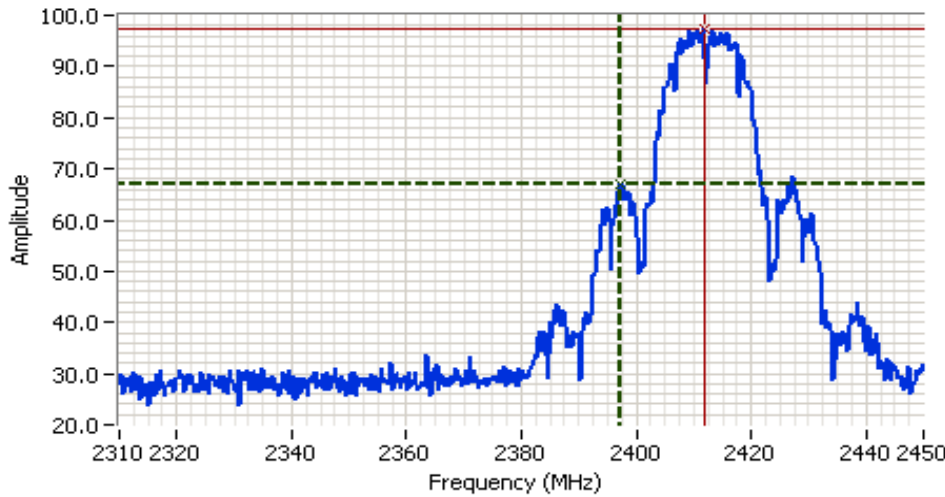

Analyzer Settings

HP8564E,EMI
 CF: 2380.000 MHz
 SPAN:140.000 MHz
 RB 100 kHz
 VB 100 kHz
 Detector POS
 Att 10
 RL Offset 0.00
 Sweep Time 77.0ms
 Ref Lvl:105.00DBUV

Comments

802.11b,1Mbs, channel 1, Chain B, pwr setting = 23

Cursor 1 2397.2666 67.17 

Cursor 2 2411.7334 97.33 

Delta Freq. 14.467

Delta Amplitude 30.17



Plots for center channel, 802.11b mode Chains A and B, power setting(s) = 25/23

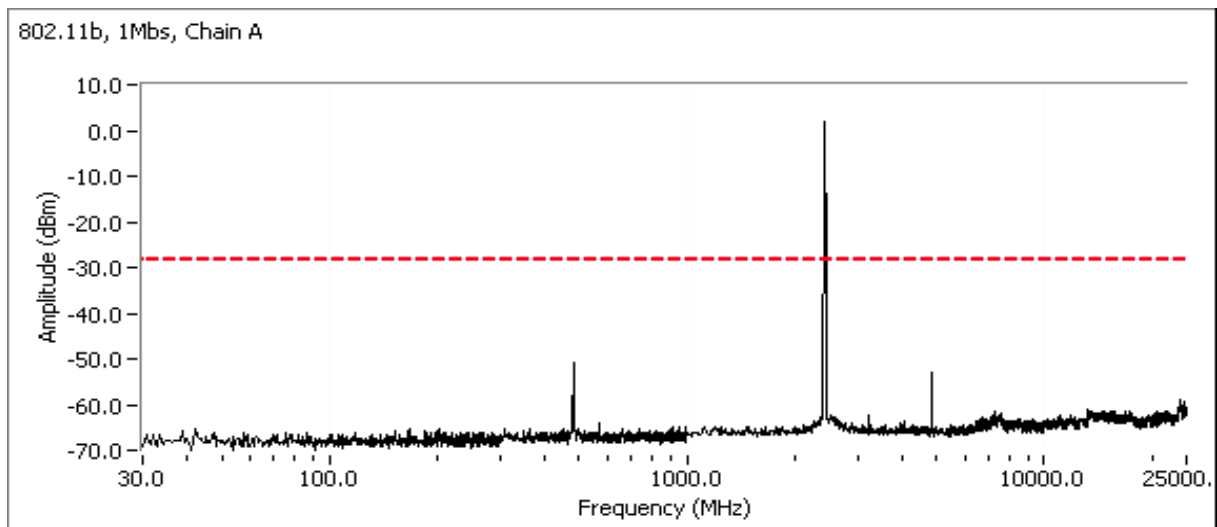

Client:	Intel Corporation	Job Number:	J80050
Model:	62205ANHMW (Intel® Centrino® Advanced-N 6205)	T-Log Number:	T80123
Contact:	Steven Hackett	Account Manager:	Christine Krebil
Standard:	FCC 15.247 / FCC 15 E / RSS 210 / FCC 15 B	Class:	N/A

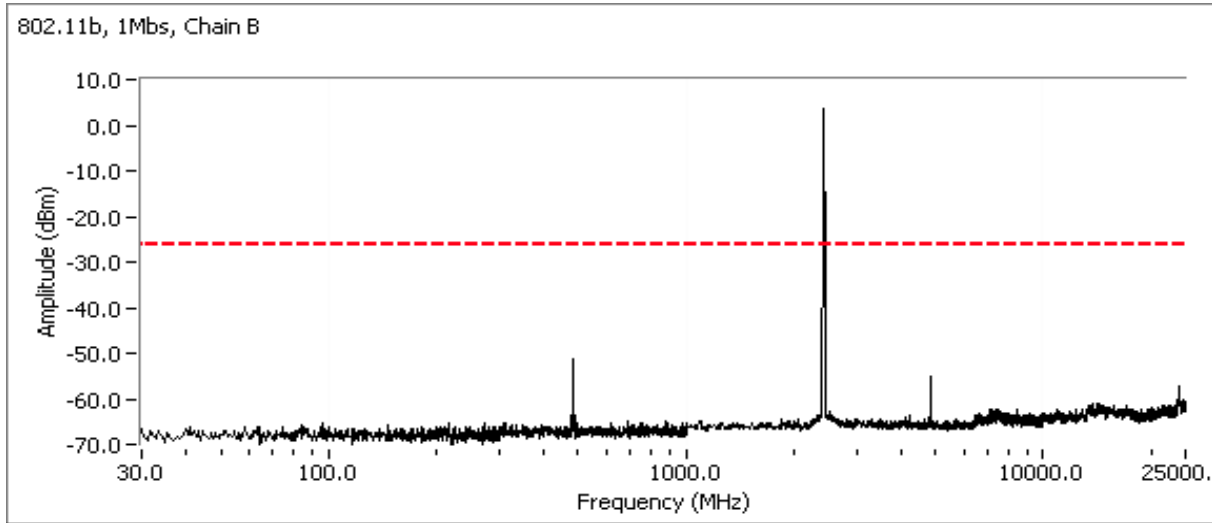

Plots for high channel, 802.11b mode Chains A and B, power setting(s) = 24/23

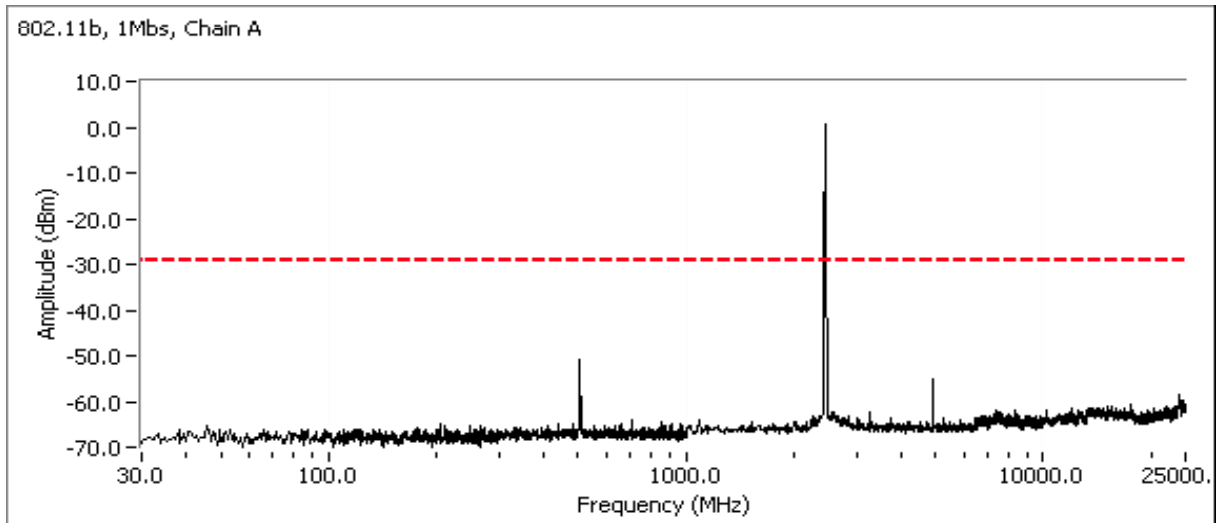

Client:	Intel Corporation	Job Number:	J80050
Model:	62205ANHMW (Intel® Centrino® Advanced-N 6205)	T-Log Number:	T80123
Contact:	Steven Hackett	Account Manager:	Christine Krebil
Standard:	FCC 15.247 / FCC 15 E / RSS 210 / FCC 15 B	Class:	N/A

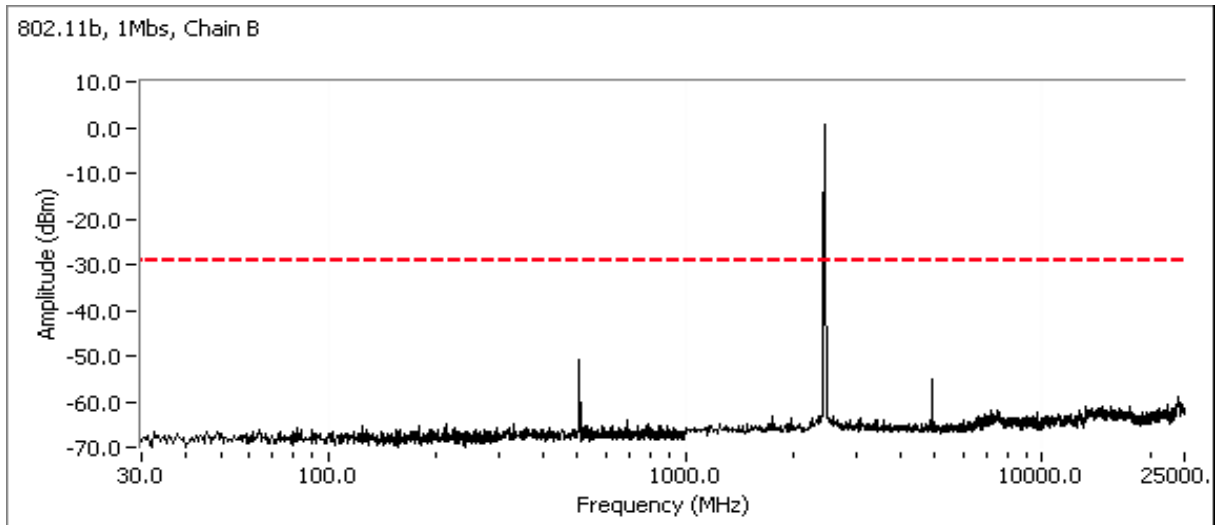

Plots for low channel, 802.11g mode Chains A and B, power setting(s) = 28.5/26

Additional plots for each chain showing compliance with -30dBc limit from 2390 MHz to 2400 MHz. Radiated measurements used to show compliance with the limits in the restricted band below 2390 MHz.

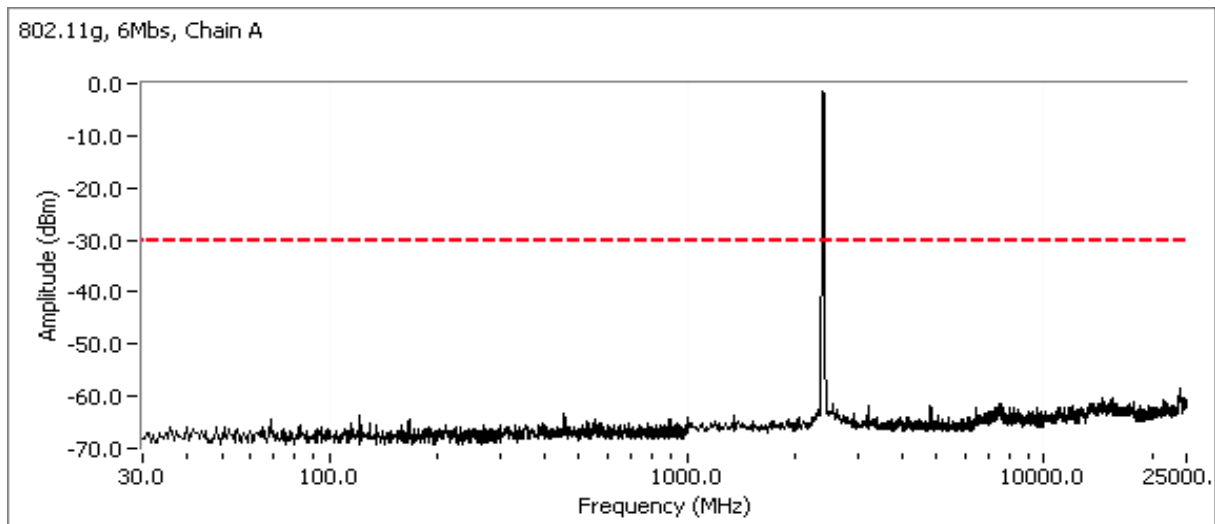

Client:	Intel Corporation	Job Number:	J80050
Model:	62205ANHMW (Intel® Centrino® Advanced-N 6205)	T-Log Number:	T80123
Contact:	Steven Hackett	Account Manager:	Christine Krebil
Standard:	FCC 15.247 / FCC 15 E / RSS 210 / FCC 15 B	Class:	N/A

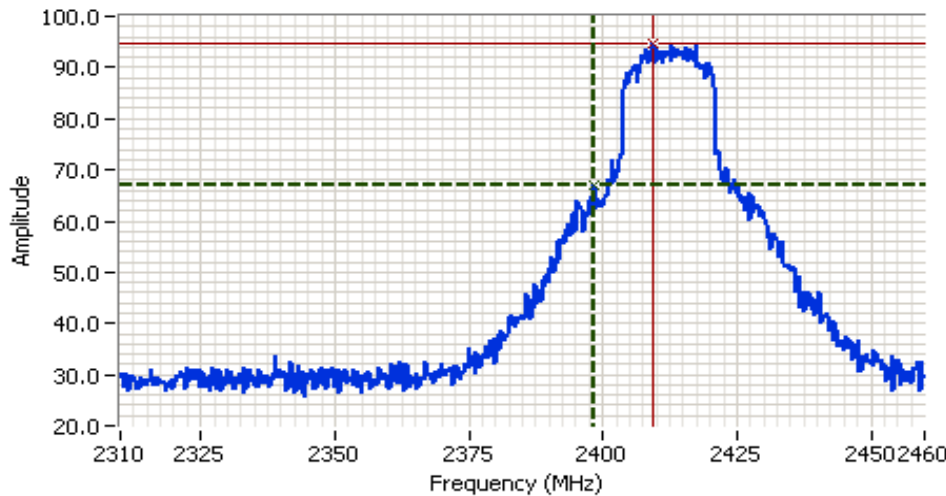

Analyzer Settings

HP8564E,EMI
 CF: 2385.000 MHz
 SPAN:150.000 MHz
 RB 100 kHz
 VB 100 kHz
 Detector POS
 Att 10
 RL Offset 0.00
 Sweep Time 83.0ms
 Ref Lvl:105.00DBU

Comments

802.11g, 6Mbps,
 channel 1, Chain A,
 pwr setting = 28.5

Cursor 1 2398.5000 66.83 

Cursor 2 2409.5000 94.83 

Delta Freq. 11.000

Delta Amplitude 28.00

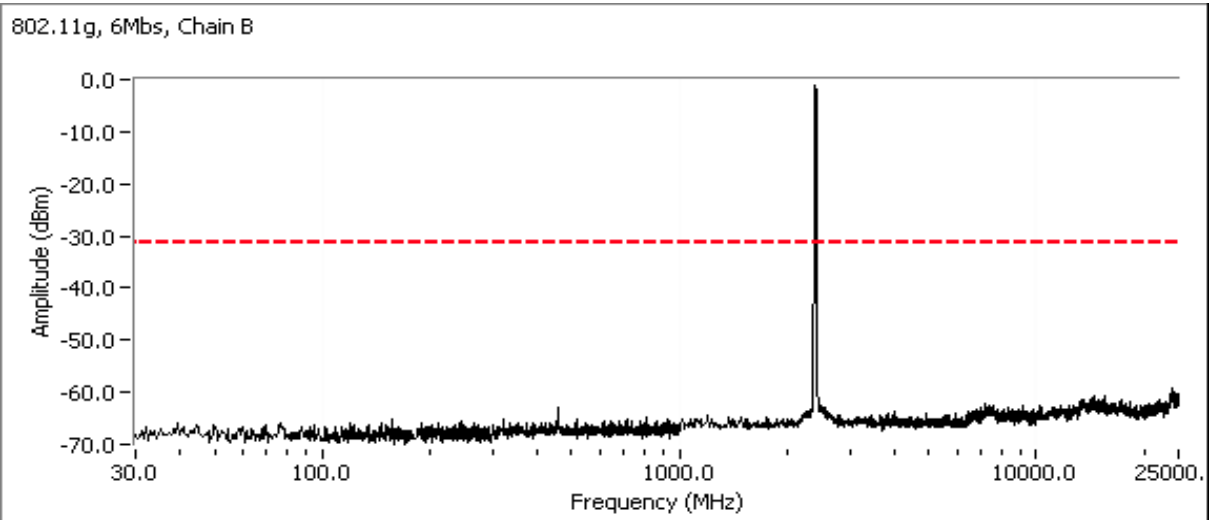

Client:	Intel Corporation	Job Number:	J80050
Model:	62205ANHMW (Intel® Centrino® Advanced-N 6205)	T-Log Number:	T80123
Contact:	Steven Hackett	Account Manager:	Christine Krebil
Standard:	FCC 15.247 / FCC 15 E / RSS 210 / FCC 15 B	Class:	N/A

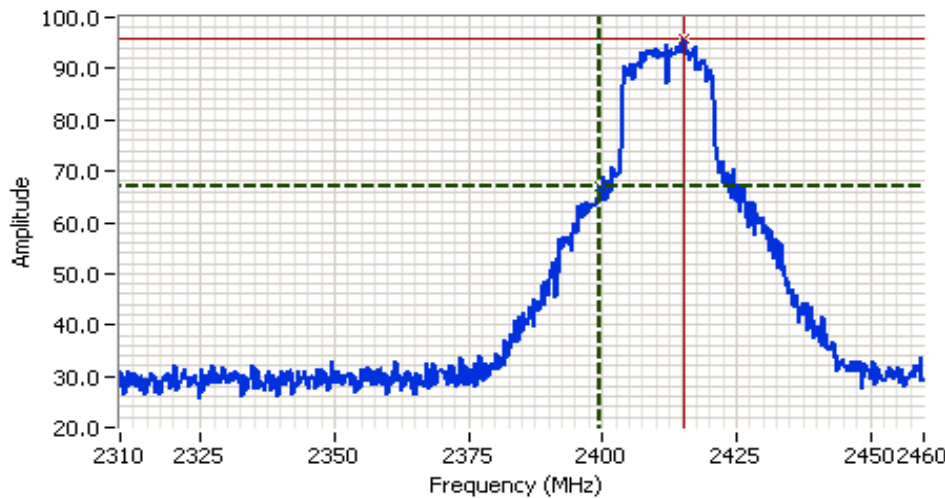

Analyzer Settings
 HP8564E,EMI
 CF: 2385.000 MHz
 SPAN:150.000 MHz
 RB 100 kHz
 VB 100 kHz
 Detector POS
 Att 10
 RL Offset 0.00
 Sweep Time 83.0ms
 Ref Lvl:105.00DBUV

Comments
 802.11g, 6Mbps,
 channel 1, Chain B, pwr
 setting = 26

Cursor 1 2399.5000 67.00
 Cursor 2 2415.2500 95.67
 Delta Freq. 15.750
 Delta Amplitude 28.67



Plots for center channel, 802.11g mode Chains A and B, power setting(s) = 31/29

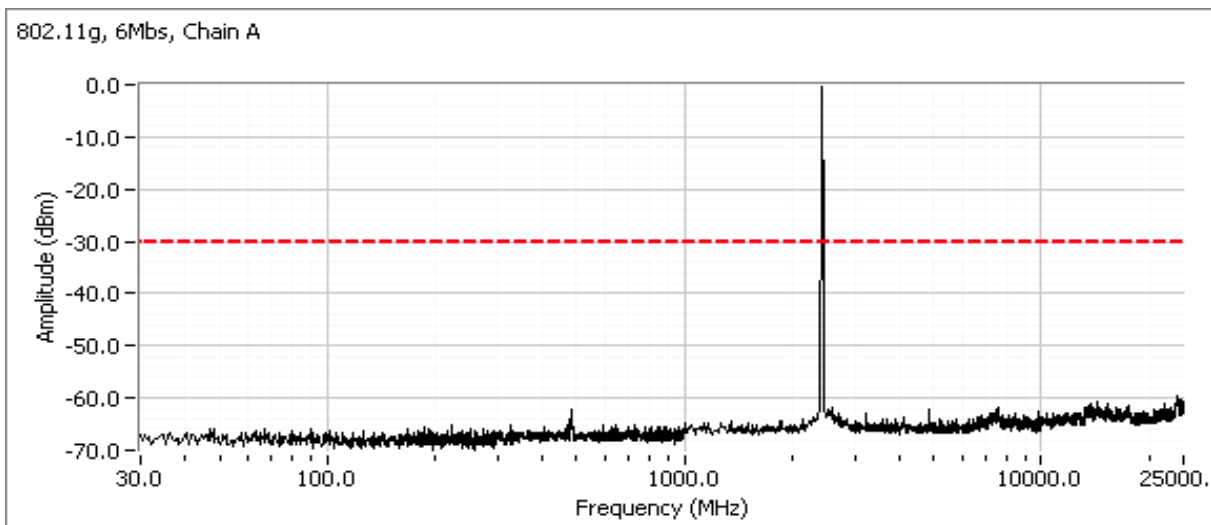

Client:	Intel Corporation	Job Number:	J80050
Model:	62205ANHMW (Intel® Centrino® Advanced-N 6205)	T-Log Number:	T80123
Contact:	Steven Hackett	Account Manager:	Christine Krebil
Standard:	FCC 15.247 / FCC 15 E / RSS 210 / FCC 15 B	Class:	N/A

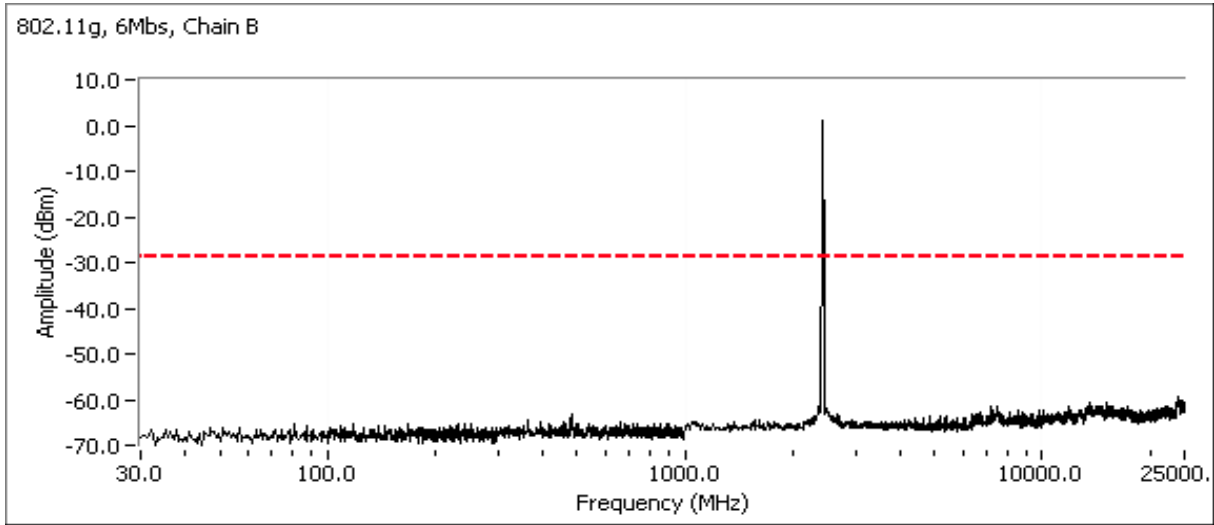

Plots for high channel, 802.11g mode Chains A and B, power setting(s) = 27.5/26

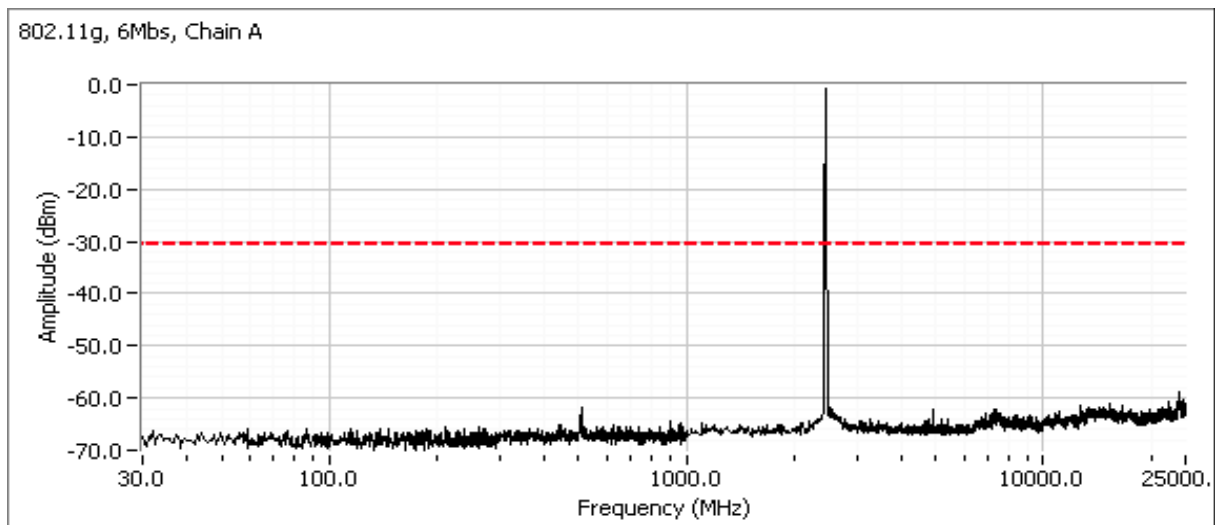

Client:	Intel Corporation	Job Number:	J80050
Model:	62205ANHMW (Intel® Centrino® Advanced-N 6205)	T-Log Number:	T80123
Contact:	Steven Hackett	Account Manager:	Christine Krebil
Standard:	FCC 15.247 / FCC 15 E / RSS 210 / FCC 15 B	Class:	N/A

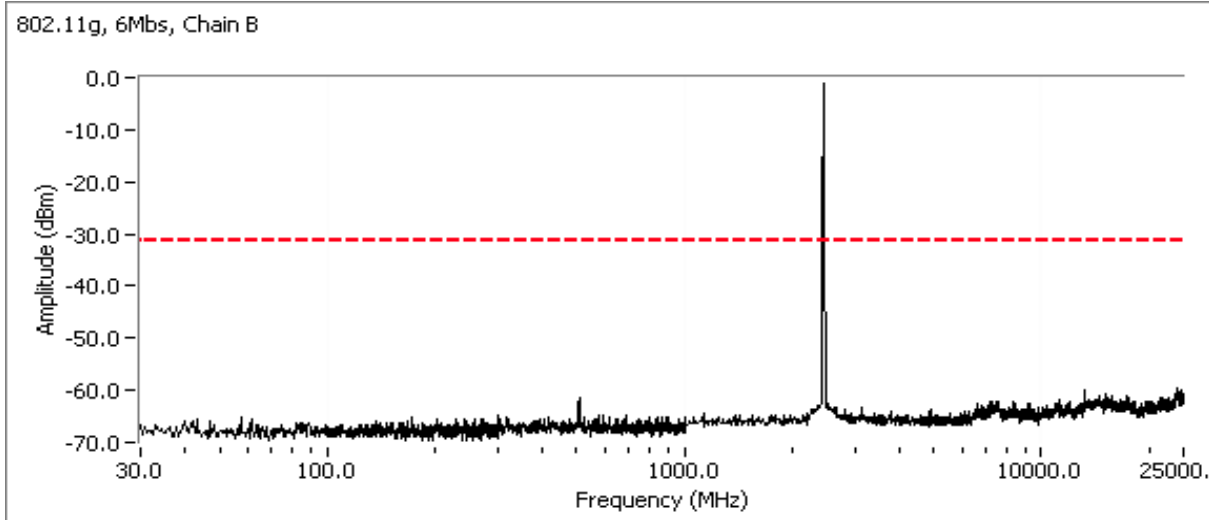

Client:	Intel Corporation	Job Number:	J80050
Model:	62205ANHMW (Intel® Centrino® Advanced-N 6205)	T-Log Number:	T80123
Contact:	Steven Hackett	Account Manager:	Christine Krebil
Standard:	FCC 15.247 / FCC 15 E / RSS 210 / FCC 15 B	Class:	N/A

**RSS 210 and FCC 15.247 (DTS) Antenna Port Measurements
Power, PSD, Bandwidth and Spurious Emissions**

Test Specific Details

Objective: The objective of this test session is to perform final qualification testing of the EUT with respect to the specification listed above.

Date of Test: 8/12/2010
 Test Engineer: Rafael Varelas
 Test Location: FT Chamber #3

Config. Used: 1
 Config Change: none
 Host Unit Voltage 120V/60Hz

General Test Configuration

The EUT was connected to the spectrum analyzer or power meter via a suitable attenuator. All measurements were made on a single chain. All measurements have been corrected to allow for the external attenuators used.

Ambient Conditions:

Temperature: 21.8 °C
 Rel. Humidity: 38 %

Summary of Results

MAC Address: 001500633B14 DRTU Tool Version 1.1.3 Driver version 13.0.0.238 Sample: 1340

Run #	Pwr setting	Avg Pwr	Test Performed	Limit	Pass / Fail	Result / Margin
1	-	16.8	802.11n 20MHz Output Power	15.247(b)	Pass	15.6 dBm
1	-	16.6	802.11n 40MHz Output Power	15.247(b)	Pass	15.1 dBm
2	-	16.8	802.11n 20MHz Power spectral	15.247(d)	Pass	-7.8 dBm/3kHz
2	-	16.6	802.11n 40MHz Power spectral	15.247(d)	Pass	-10.7 dBm/3kHz
3	-	13.1	802.11n 20MHz Minimum 6dB	15.247(a)	Pass	15.1 MHz
3	-	16.8	802.11n 20MHz 99% Bandwidth	RSS GEN	-	18.4 MHz
3	-	16.6	802.11n 40MHz Minimum 6dB	15.247(a)	Pass	35.3 MHz
3	-	16.6	802.11n 40MHz 99% Bandwidth	RSS GEN	-	36.9 MHz
4	-	-	802.11n 20MHz/40MHz Spurious emissions	15.247(b)	Pass	All emissions below -30dBc limit

Note: Used -30dBc as limit for spurious. As powers were measured using a peak power meter the limit actually required is -20dBc. The peak power was measured to remain consistent with the legacy mode power measurements in SISO mode where the device did not meet the -30dBc requirement at the 2400MHz band edge. As the n modes met the -30dBc requirements at the band edges the -30dBc was used to demonstrate compliance for the MIMO mode (which operate at a lower power per chain power), and the MIMO powers were measured using the NII average power method.

Client:	Intel Corporation	Job Number:	J80050
Model:	62205ANHMW (Intel® Centrino® Advanced-N 6205)	T-Log Number:	T80123
Contact:	Steven Hackett	Account Manager:	Christine Krebil
Standard:	FCC 15.247 / FCC 15 E / RSS 210 / FCC 15 B	Class:	N/A

Modifications Made During Testing

No modifications were made to the EUT during testing

Deviations From The Standard

No deviations were made from the requirements of the standard.

Run #1: Output Power

Power Setting ²	Frequency (MHz)	Output Power		Antenna Gain (dBi)	Result	EIRP ^{Note 2}		Output Power	
		(dBm) ¹	mW			dBm	W	(dBm) ³	mW
802.11n 20MHz Mode, Chain A									
27.5	2412	11.1	12.9	3.2	Pass	14.3	0.027	13.1	20.4
31	2437	14.8	30.2	3.2	Pass	18.0	0.064	16.5	44.7
26.5	2462	11.0	12.6	3.2	Pass	14.2	0.027	12.4	17.4
802.11n 20MHz Mode, Chain B									
25	2412	11.9	15.5	3.2	Pass	15.1	0.033	13.1	20.4
29.5	2437	15.6	36.3	3.2	Pass	18.8	0.077	16.8	47.9
25	2462	11.4	13.8	3.2	Pass	14.6	0.029	12.8	19.1
802.11n 40MHz Mode, Chain A									
22.5	2422	7.5	5.6	3.2	Pass	10.7	0.012	9.1	8.1
31	2437	15.1	32.4	3.2	Pass	18.3	0.068	16.6	45.7
22.5	2452	8.2	6.6	3.2	Pass	11.4	0.014	9.6	9.1
802.11n 40MHz Mode, Chain B									
21	2422	8.5	7.1	3.2	Pass	11.7	0.015	9.6	9.1
29	2437	15.0	31.6	3.2	Pass	18.2	0.067	16.4	43.7
21.5	2452	8.6	7.2	3.2	Pass	11.8	0.015	10.0	10.0

Note 1:	Output power measured using a spectrum analyzer (see plots below) with RBW=1MHz, VB=3 MHz, sample detector, power averaging on (transmitted signal was continuous) and power integration over 40 MHz (option #2, method 1 in KDB 558074, equivalent to method 1 of DA-02-2138A1 for U-NII devices). Spurious limit becomes -30dBc.
Note 2:	Power setting - the software power setting used during testing, included for reference only.
Note 3:	Power measured using average power meter and is included for reference only.

Client:	Intel Corporation	Job Number:	J80050
Model:	62205ANHMW (Intel® Centrino® Advanced-N 6205)	T-Log Number:	T80123
Contact:	Steven Hackett	Account Manager:	Christine Krebil
Standard:	FCC 15.247 / FCC 15 E / RSS 210 / FCC 15 B	Class:	N/A

Run #2: Power spectral Density

Power Setting	Frequency (MHz)	PSD	Limit dBm/3kHz	Result
		(dBm/3kHz) ^{Note 1}		
802.11n 20MHz Mode, Chain A				
27.5	2412	-13.5	8.0	Pass
31	2437	-7.8	8.0	Pass
26.5	2462	-11.5	8.0	Pass
802.11n 20MHz Mode, Chain B				
25	2412	-11.8	8.0	Pass
29.5	2437	-9.0	8.0	Pass
25	2462	-11.2	8.0	Pass
802.11n 40MHz Mode, Chain A				
22.5	2422	-16.0	8.0	Pass
31	2437	-10.7	8.0	Pass
22.5	2452	-16.2	8.0	Pass
802.11n 40MHz Mode, Chain B				
21	2422	-17.3	8.0	Pass
29	2437	-11.0	8.0	Pass
21.5	2452	-16.2	8.0	Pass

Note 1: Power spectral density measured using RB=3 kHz, VB=10kHz, analyzer with peak detector and with a sweep time set to ensure a dwell time of at least 1 second per 3kHz. The measurement is made at the frequency of PPSD determined from preliminary scans using RB=3kHz using multiple sweeps at a faster rate over the 6dB bandwidth of the signal.

Client: Intel Corporation	Job Number: J80050
Model: 62205ANHMW (Intel® Centrino® Advanced-N 6205)	T-Log Number: T80123
Contact: Steven Hackett	Account Manager: Christine Krebil
Standard: FCC 15.247 / FCC 15 E / RSS 210 / FCC 15 B	Class: N/A

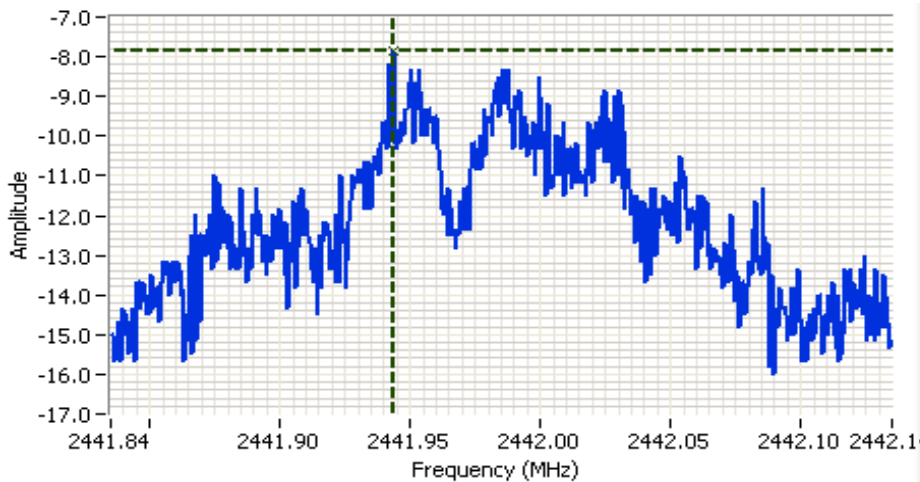

Analyzer Settings
 HP8564E,EMICF: 2441.985 MHz
 SPAN: 300 kHz
 RB: 3.00 kHz
 VB: 10.0 kHz
 Detector: POS
 Attn: 10 DB
 RL Offset: 11.0 DB
 Sweep Time: 100.0s
 Ref Lvl: 11.0 DBM

Comments
 Ch 6, Chain A

Cursor 1 2441.9435 -7.83
 0.0000 0.00

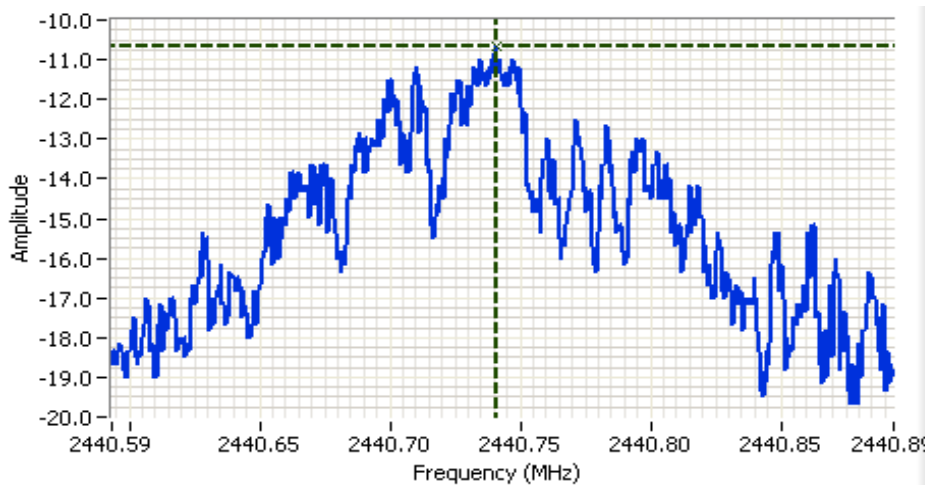

Analyzer Settings
 HP8564E,EMICF: 2440.743 MHz
 SPAN: 300 kHz
 RB: 3.00 kHz
 VB: 10.0 kHz
 Detector: POS
 Attn: 10 DB
 RL Offset: 11.0 DB
 Sweep Time: 100.0s
 Ref Lvl: 11.0 DBM

Comments
 Ch 6, Chain A

Cursor 1 2440.7408 -10.67
 0.0000 0.00



Client:	Intel Corporation	Job Number:	J80050
Model:	62205ANHMW (Intel® Centrino® Advanced-N 6205)	T-Log Number:	T80123
		Account Manager:	Christine Krebil
Contact:	Steven Hackett		
Standard:	FCC 15.247 / FCC 15 E / RSS 210 / FCC 15 B	Class:	N/A

Run #3: Signal Bandwidth

Power Setting	Frequency (MHz)	Resolution Bandwidth	Bandwidth (MHz)	
			6dB	99%
802.11n 20MHz Mode				
31	2437, Chain A	100kHz	15.2	18.3
29.5	2437, Chain B	100kHz	15.3	18.4
27.5	2412, Chain A	100kHz	15.1	18.1
26.5	2462, Chain A	100kHz	15.3	18.1
802.11n 40MHz Mode				
31	2437, Chain A	100kHz	35.3	36.9
29	2437, Chain B	100kHz	35.5	36.9
22.5	2422, Chain A	100kHz	35.7	36.6
22.5	2452, Chain A	100kHz	36	36.8

Note 1:	99% bandwidth measured in accordance with RSS GEN, with RB > 1% of the span and VB > 3xRB (taken from power measurement plots)
Note 2:	6dB bandwidth measured on the center channel for each chain and then on the top and bottom channels for the chain with the narrowest 6dB bandwidth.

Client:	Intel Corporation	Job Number:	J80050
Model:	62205ANHMW (Intel® Centrino® Advanced-N 6205)	T-Log Number:	T80123
Contact:	Steven Hackett	Account Manager:	Christine Krebil
Standard:	FCC 15.247 / FCC 15 E / RSS 210 / FCC 15 B	Class:	N/A



Analyzer Settings
 HP8564E,EMICF: 2412.000 MHz
 SPAN: 50.000 MHz
 RB: 100 kHz
 VB: 100 kHz
 Detector: Normal
 Attn: 10 DB
 RL Offset: 0.0 DB
 Sweep Time: 50.0ms
 Ref Lvl: 0.0 DBM

Comments
 6dB BW: 15.083 MHz
 Ch 1, Chain A

Cursor 1 2419.8333 -9.83
 Cursor 2 2404.7500 -15.83

Delta Freq. 15.083
 Delta Amplitude 6.00



Analyzer Settings
 HP8564E,EMICF: 2437.000 MHz
 SPAN: 100.000 MHz
 RB: 100 kHz
 VB: 100 kHz
 Detector: Normal
 Attn: 10 DB
 RL Offset: 0.0 DB
 Sweep Time: 55.0ms
 Ref Lvl: 0.0 DBM

Comments
 6dB BW: 35.333 MHz
 Ch 6, Chain A

Cursor 1 2455.3333 -12.00
 Cursor 2 2420.0000 -18.00

Delta Freq. 35.333
 Delta Amplitude 6.00



Client:	Intel Corporation	Job Number:	J80050
Model:	62205ANHMW (Intel® Centrino® Advanced-N 6205)	T-Log Number:	T80123
Contact:	Steven Hackett	Account Manager:	Christine Krebil
Standard:	FCC 15.247 / FCC 15 E / RSS 210 / FCC 15 B	Class:	N/A

Run #4: Out of Band Spurious Emissions

Mode	Chain	Frequency (MHz)	Limit	Result
802.11n 20MHz	A	2412	-30dBc	Pass
		2437	-30dBc	Pass
		2462	-30dBc	Pass
	B	2412	-30dBc	Pass
		2437	-30dBc	Pass
		2462	-30dBc	Pass
802.11n 40MHz	A	2422	-30dBc	Pass
		2437	-30dBc	Pass
		2452	-30dBc	Pass
	B	2422	-30dBc	Pass
		2437	-30dBc	Pass
		2452	-30dBc	Pass

Note: Used -30dBc as limit for spurious. As powers were measured using a peak power meter the limit actually required is -20dBc. The peak power was measured to remain consistent with the legacy mode power measurements where the device did not meet the -30dBc

Plots for low channel, 802.11n 20MHz mode Chains A and B, power setting(s) = 27.5/25.0

Additional plots for each chain showing compliance with -30dBc limit from 2390 MHz to 2400 MHz. Radiated measurements used to show compliance with the limits in the restricted band below 2390 MHz.

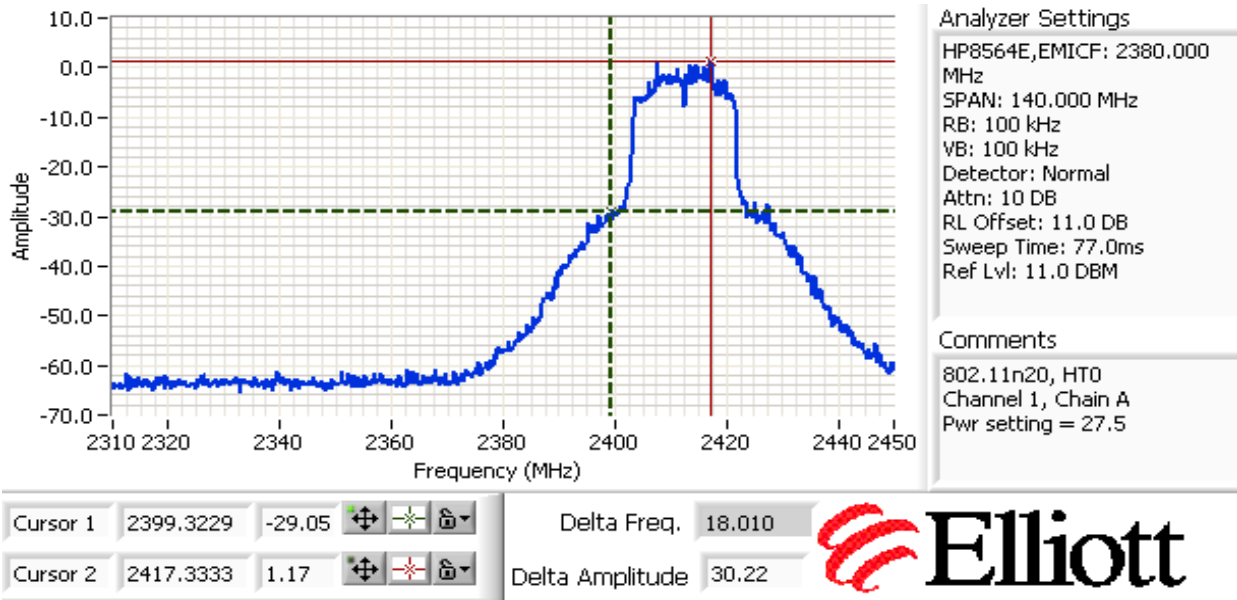

Client:	Intel Corporation	Job Number:	J80050
Model:	62205ANHMW (Intel® Centrino® Advanced-N 6205)	T-Log Number:	T80123
Contact:	Steven Hackett	Account Manager:	Christine Krebil
Standard:	FCC 15.247 / FCC 15 E / RSS 210 / FCC 15 B	Class:	N/A

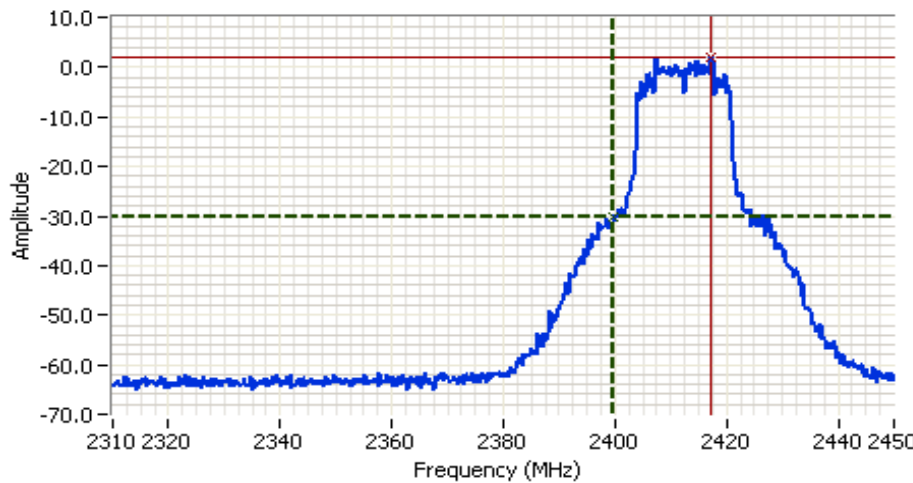
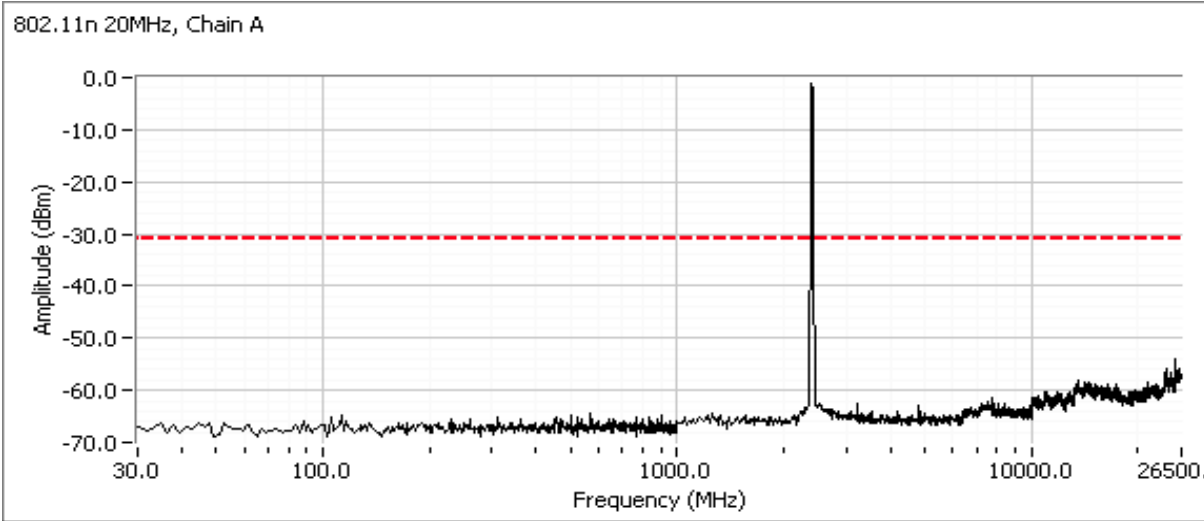

Analyzer Settings
 HP8564E,EMICF: 2380.000 MHz
 SPAN: 140.000 MHz
 RB: 100 kHz
 VB: 100 kHz
 Detector: Normal
 Attn: 10 DB
 RL Offset: 11.0 DB
 Sweep Time: 77.0ms
 Ref Lvl: 11.0 DBM

Comments

802.11n20, HTO
 Channel 1, Chain B
 Pwr setting = 25.0

Cursor 1	2399.6875	-30.19	
Cursor 2	2417.3333	2.00	

Delta Freq. 17.646
 Delta Amplitude 32.19

Client:	Intel Corporation	Job Number:	J80050
Model:	62205ANHMW (Intel® Centrino® Advanced-N 6205)	T-Log Number:	T80123
Contact:	Steven Hackett	Account Manager:	Christine Krebil
Standard:	FCC 15.247 / FCC 15 E / RSS 210 / FCC 15 B	Class:	N/A

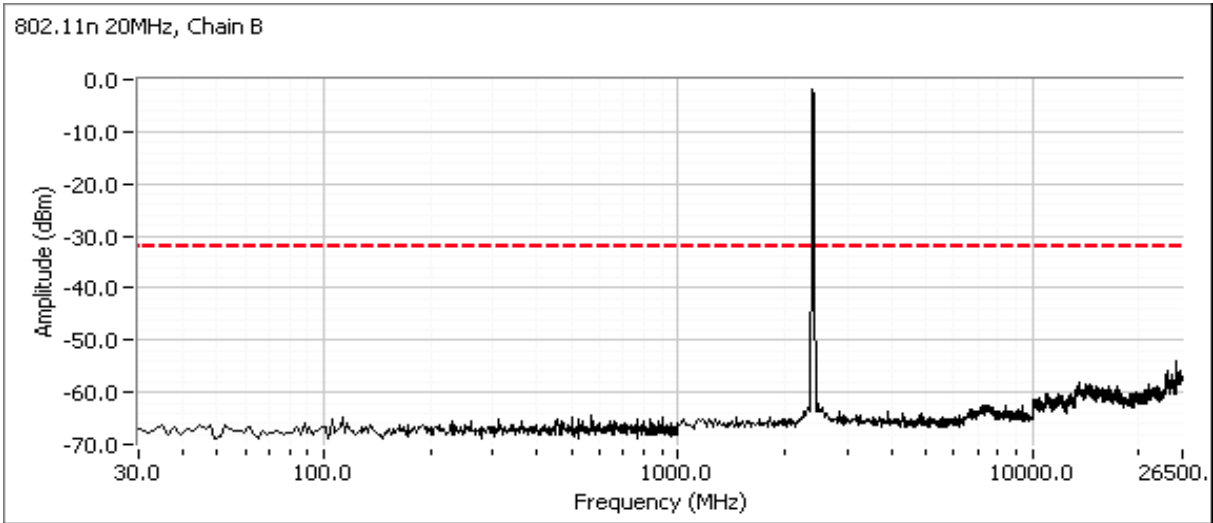

Plots for center channel, 802.11n 20MHz mode Chains A and B, power setting(s) = 31/29.5

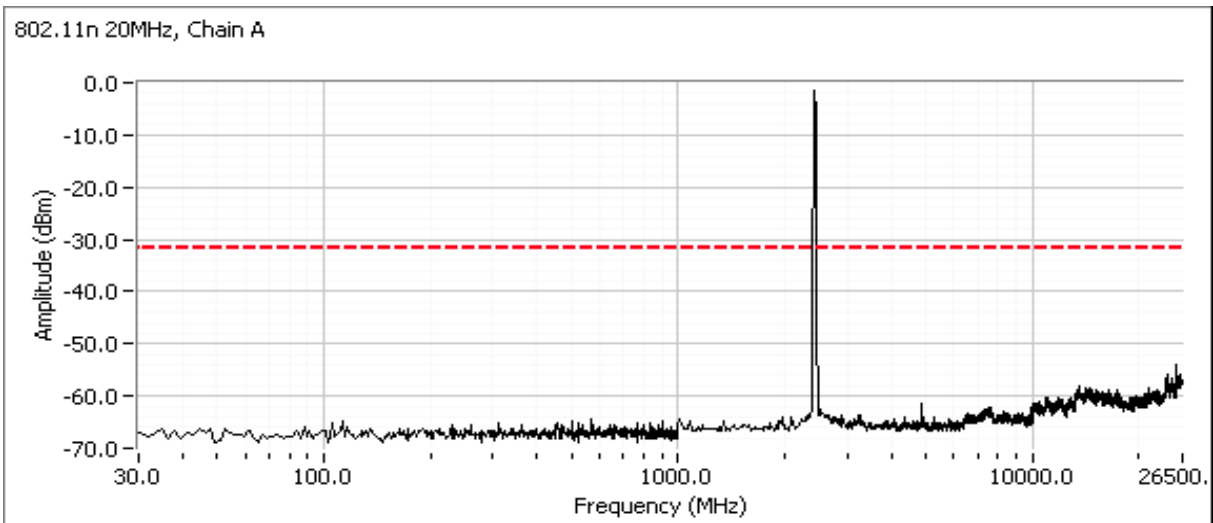

Client:	Intel Corporation	Job Number:	J80050
Model:	62205ANHMW (Intel® Centrino® Advanced-N 6205)	T-Log Number:	T80123
Contact:	Steven Hackett	Account Manager:	Christine Krebil
Standard:	FCC 15.247 / FCC 15 E / RSS 210 / FCC 15 B	Class:	N/A

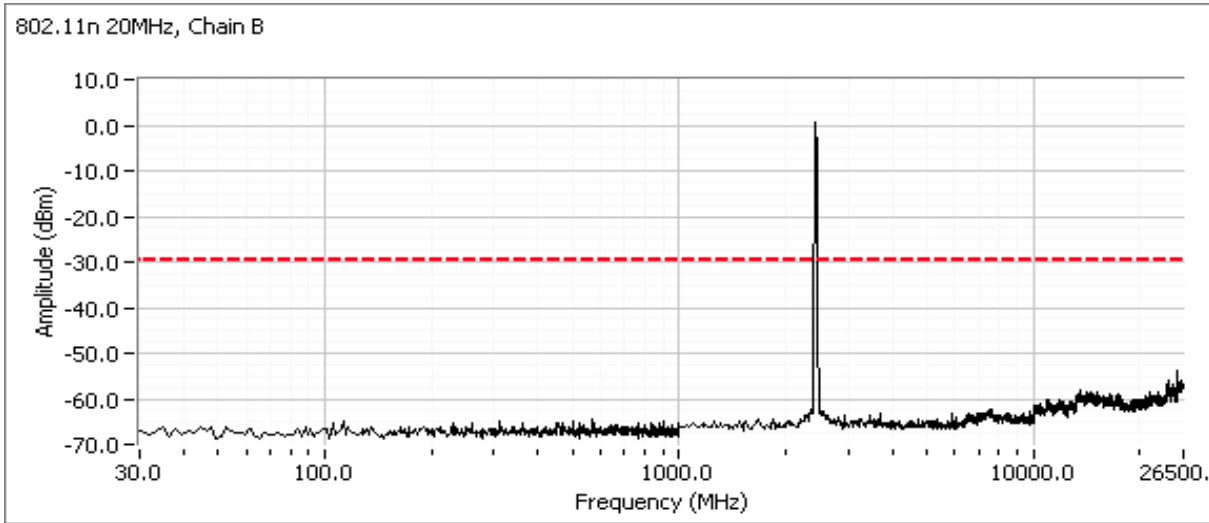

Plots for high channel, 802.11n 20MHz mode Chains A and B, power setting(s) = 26.5/25.0

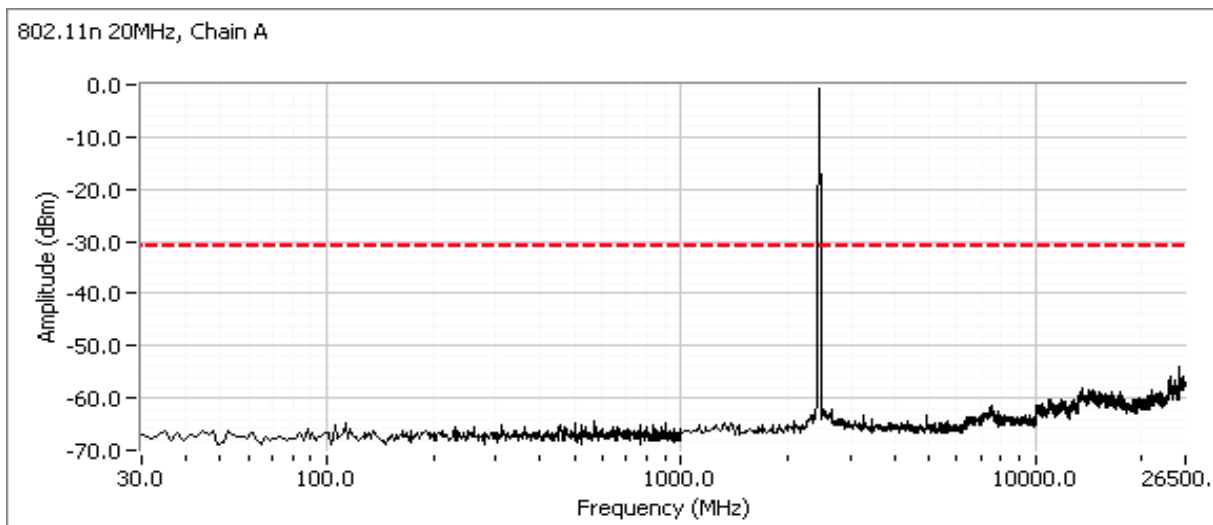

Client:	Intel Corporation	Job Number:	J80050
Model:	62205ANHMW (Intel® Centrino® Advanced-N 6205)	T-Log Number:	T80123
Contact:	Steven Hackett	Account Manager:	Christine Krebil
Standard:	FCC 15.247 / FCC 15 E / RSS 210 / FCC 15 B	Class:	N/A

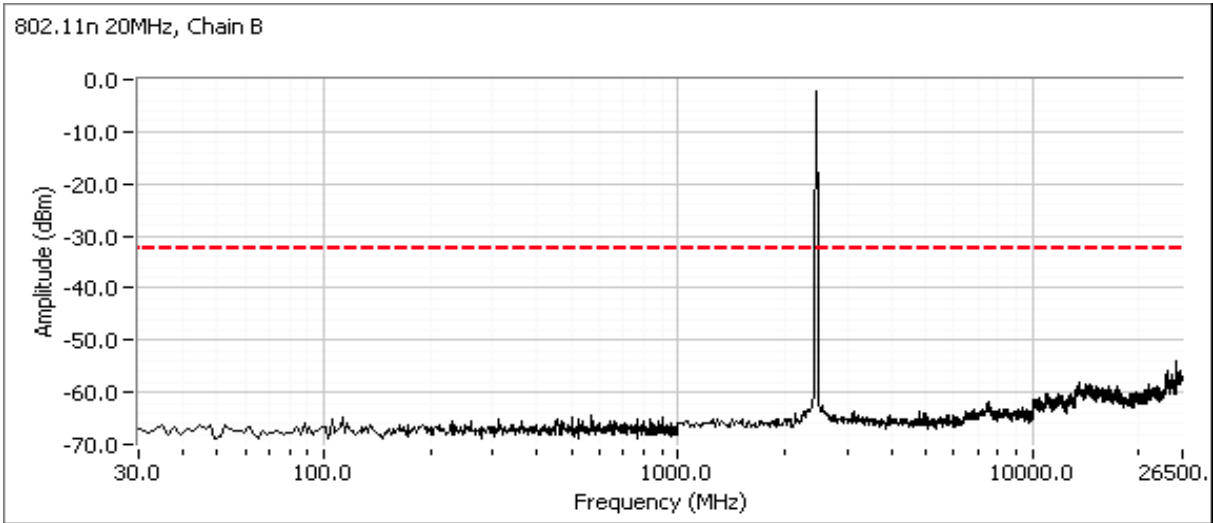

Client:	Intel Corporation	Job Number:	J80050
Model:	62205ANHMW (Intel® Centrino® Advanced-N 6205)	T-Log Number:	T80123
Contact:	Steven Hackett	Account Manager:	Christine Krebil
Standard:	FCC 15.247 / FCC 15 E / RSS 210 / FCC 15 B	Class:	N/A

Plots for low channel, 802.11n 40MHz mode Chains A and B, power setting(s) = 22.5/21.0

Additional plots for each chain showing compliance with -30dBc limit from 2390 MHz to 2400 MHz. Radiated measurements used to show compliance with the limits in the restricted band below 2390 MHz.

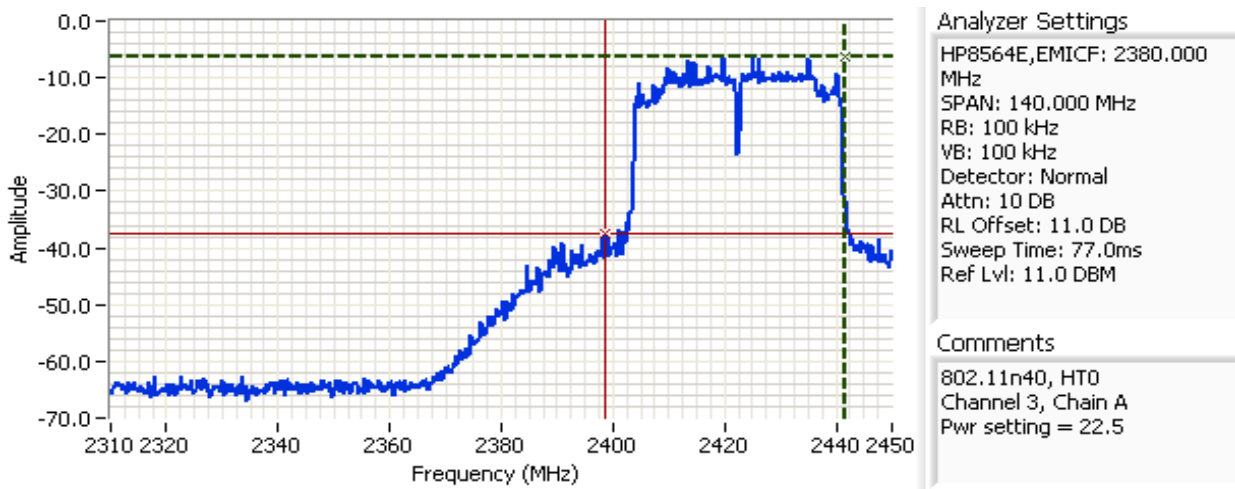

Cursor 1 2441.6000 -6.17

Cursor 2 2398.5937 -37.49

Delta Freq. 43.006

Delta Amplitude 31.32

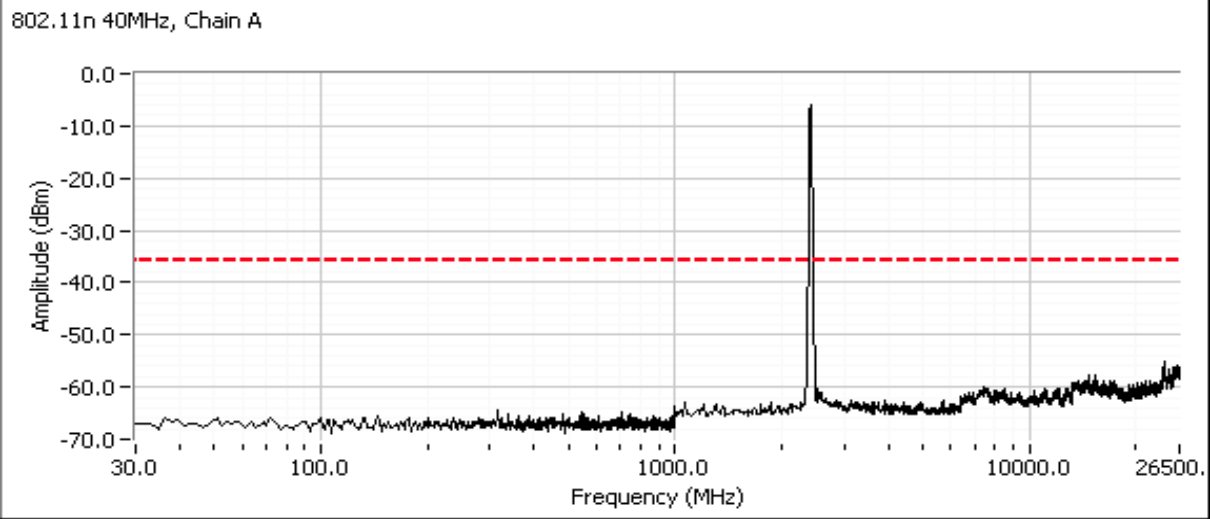

Client:	Intel Corporation	Job Number:	J80050
Model:	62205ANHMW (Intel® Centrino® Advanced-N 6205)	T-Log Number:	T80123
Contact:	Steven Hackett	Account Manager:	Christine Krebil
Standard:	FCC 15.247 / FCC 15 E / RSS 210 / FCC 15 B	Class:	N/A

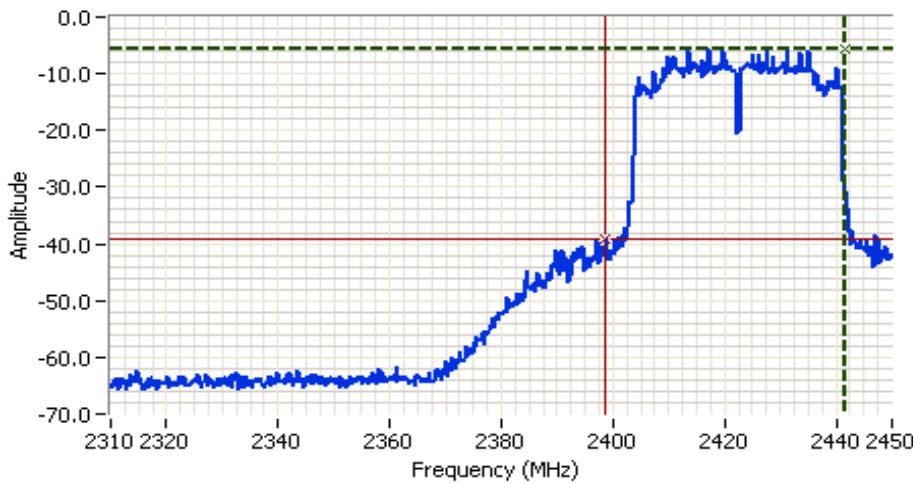

Analyzer Settings
 HP8564E,EMICF: 2380.000 MHz
 SPAN: 140.000 MHz
 RB: 100 kHz
 VB: 100 kHz
 Detector: Normal
 Attn: 10 DB
 RL Offset: 11.0 DB
 Sweep Time: 77.0ms
 Ref Lvl: 11.0 DBM

Comments

802.11n40, HTO
 Channel 3, Chain B
 Pwr setting = 21.0

Cursor 1 2441.6000 -5.67
 Cursor 2 2398.5937 -39.15

Delta Freq. 43.006

Delta Amplitude 33.48



802.11n 40MHz, Chain B

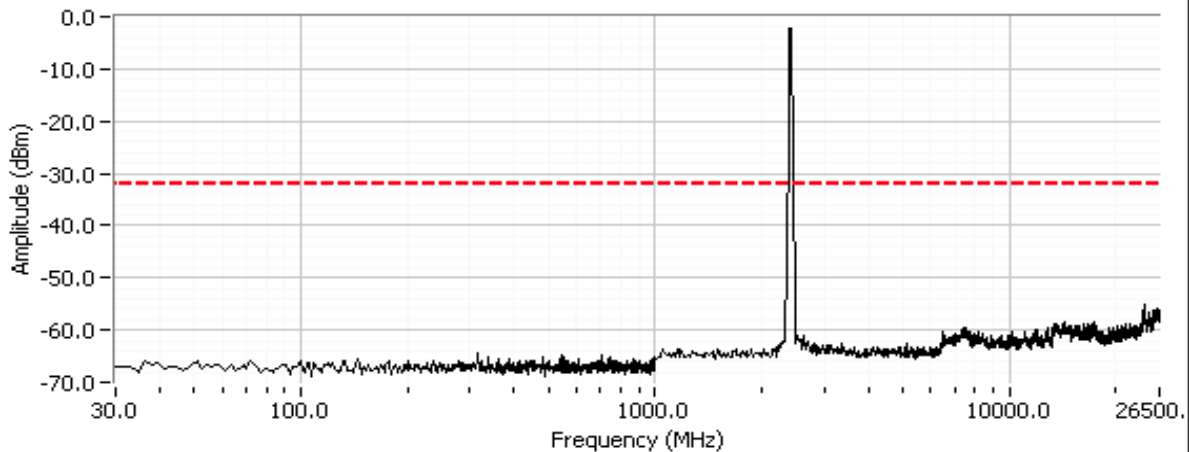

Client:	Intel Corporation	Job Number:	J80050
Model:	62205ANHMW (Intel® Centrino® Advanced-N 6205)	T-Log Number:	T80123
Contact:	Steven Hackett	Account Manager:	Christine Krebil
Standard:	FCC 15.247 / FCC 15 E / RSS 210 / FCC 15 B	Class:	N/A

Plots for center channel, 802.11n 40MHz mode Chains A and B, power setting(s) = 31/29

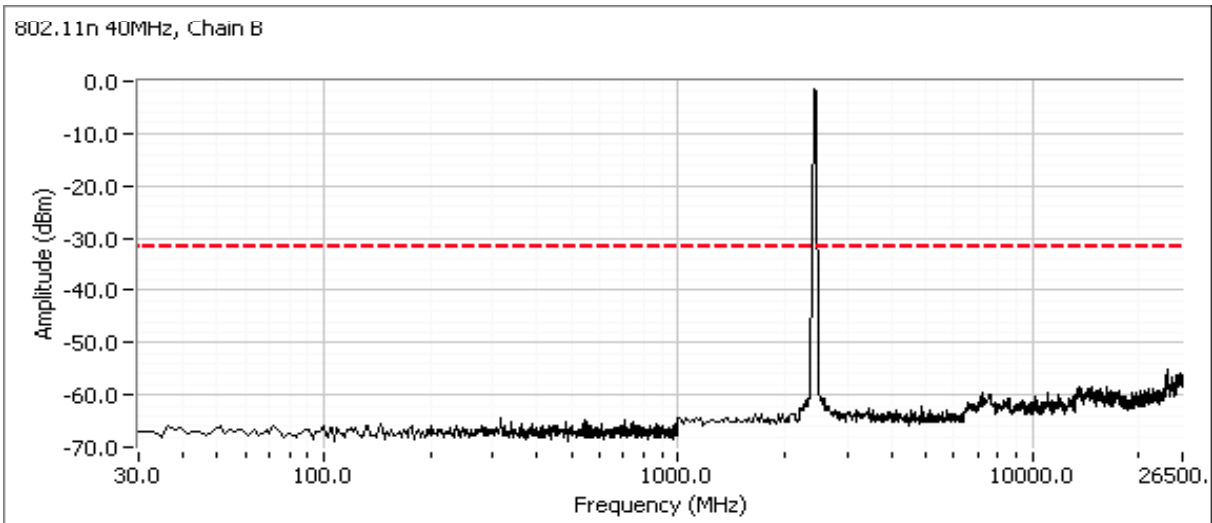
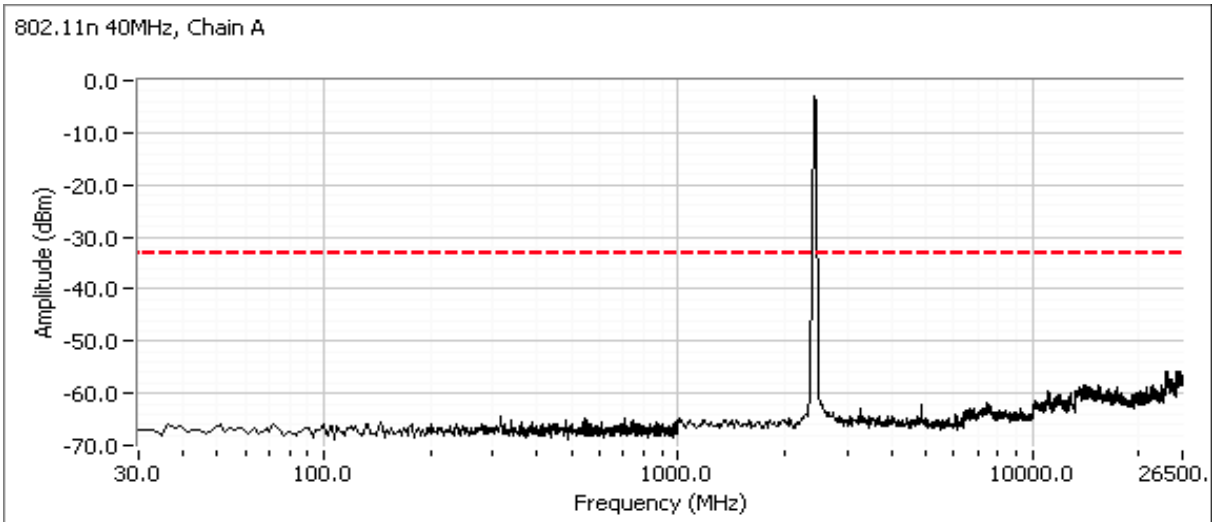

Client:	Intel Corporation	Job Number:	J80050
Model:	62205ANHMW (Intel® Centrino® Advanced-N 6205)	T-Log Number:	T80123
Contact:	Steven Hackett	Account Manager:	Christine Krebil
Standard:	FCC 15.247 / FCC 15 E / RSS 210 / FCC 15 B	Class:	N/A

Plots for high channel, 802.11n 40MHz mode Chains A and B, power setting(s) = 22.5/21.5

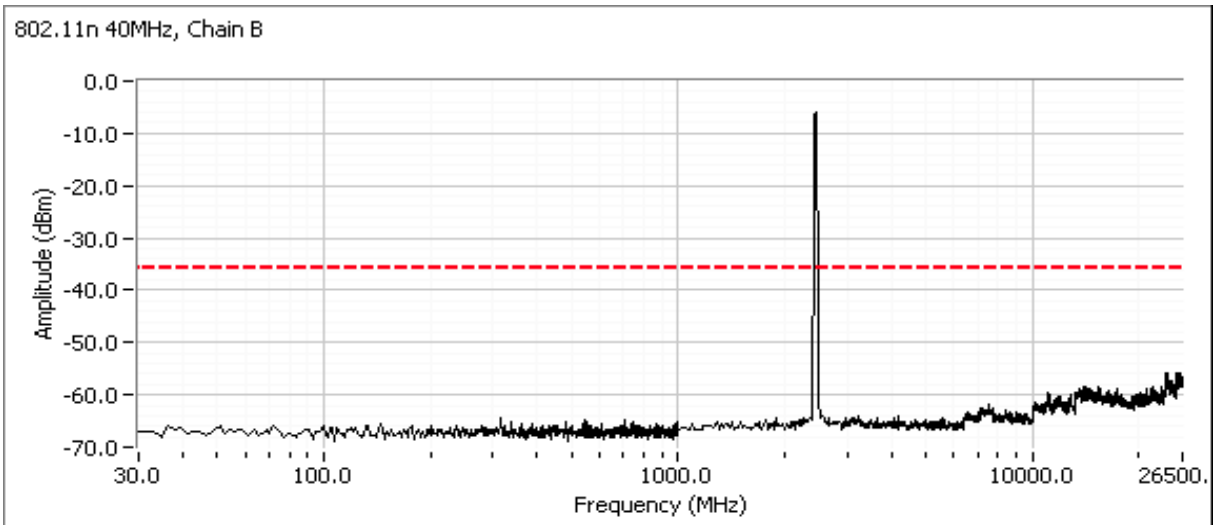
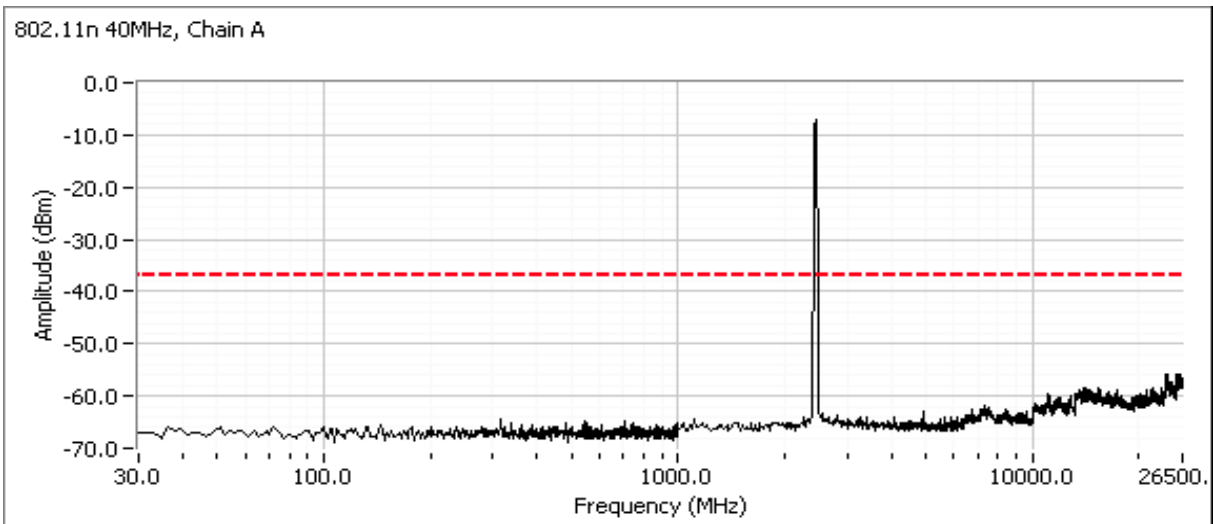

Client:	Intel Corporation	Job Number:	J80050
Model:	62205ANHMW (Intel® Centrino® Advanced-N 6205)	T-Log Number:	T80123
Contact:	Steven Hackett	Account Manager:	Christine Krebil
Standard:	FCC 15.247 / FCC 15 E / RSS 210 / FCC 15 B	Class:	N/A

**RSS 210 and FCC 15.247 (DTS) Antenna Port Measurements
MIMO and Smart Antenna Systems (2400-2483.5MHz)
Power, PSD - 802.11n MIMO Modes**

Test Specific Details

Objective: The objective of this test session is to perform final qualification testing of the EUT with respect to the specification listed above.

Date of Test: 8/12/2010
Test Engineer: Rafael Varelas
Test Location: FT Chamber #3

Config. Used: 1
Config Change: none
Host Unit Voltage 120V/60Hz

General Test Configuration

The EUT was connected to the spectrum analyzer or power meter via a suitable attenuator. All measurements were made on each chain individually. All measurements have been corrected to allow for the external attenuators used.

Ambient Conditions:

Temperature: 21.8 °C
Rel. Humidity: 38 %

Summary of Results

MAC Address: 001500633B14 DRTU Tool Version 1.1.3 Driver version 13.0.0.238 Sample: 1340

Run #	Pwr setting	Avg Pwr	Test Performed	Limit	Pass / Fail	Result / Margin
802.11n 20MHz						
1	-	16.7	Output Power	15.247(b)	Pass	15.4 dBm
1	-	16.8	Power spectral Density (PSD)	15.247(d)	Pass	-7.5 dBm/3kHz
802.11n 40MHz						
1	-	16.7	Output Power	15.247(b)	Pass	15.2 dBm
1	-	16.7	Power spectral Density (PSD)	15.247(d)	Pass	-10.2 dBm/3kHz
-	-	-	Minimum 6dB Bandwidth n20	15.247(a)	Pass	Covered by single chain measurements (SISO mode)
-	-	-	99% Bandwidth n20	RSS GEN	Pass	
-	-	-	Spurious emissions n20 and n40	15.247(b)	Pass	

Modifications Made During Testing

No modifications were made to the EUT during testing

Deviations From The Standard

No deviations were made from the requirements of the standard.

Client:	Intel Corporation	Job Number:	J80050
Model:	62205ANHMW (Intel® Centrino® Advanced-N 6205)	T-Log Number:	T80123
Contact:	Steven Hackett	Account Manager:	Christine Krebil
Standard:	FCC 15.247 / FCC 15 E / RSS 210 / FCC 15 B	Class:	N/A

Run #1: Output Power
 Operating Mode: 802.11n, 20MHz
 Transmitted signal on chain is coherent ? No

2412 MHz	Chain A	Chain B	Chain 3	Chain 4	Total Across All Chains		Limit	
Power Setting ^{Note 3}	28.5	26.5						
Average Power ^{Note 4}	11.6	11.6						
Output Power (dBm) ^{Note 1}	10.2	10.1			13.2 dBm	0.021 W	30.0 dBm	1.000 W
Antenna Gain (dBi) ^{Note 2}	3.2	3.2				3.2 dBi	Pass	
eirp (dBm) ^{Note 2}	13.4	13.3			16.4 dBm	0.043 W		

2437 MHz	Chain A	Chain B	Chain 3	Chain 4	Total Across All Chains		Limit	
Power Setting ^{Note 3}	29.5	28.0						
Average Power ^{Note 4}	13.7	13.7						
Output Power (dBm) ^{Note 1}	12.5	12.3			15.4 dBm	0.035 W	30.0 dBm	1.000 W
Antenna Gain (dBi) ^{Note 2}	3.2	3.2				3.2 dBi	Pass	
eirp (dBm) ^{Note 2}	15.7	15.5			18.6 dBm	0.073 W		

2462 MHz	Chain A	Chain B	Chain 3	Chain 4	Total Across All Chains		Limit	
Power Setting ^{Note 3}	28.0	26.5						
Average Power ^{Note 4}	11.9	11.7						
Output Power (dBm) ^{Note 1}	10.4	10.6			13.5 dBm	0.022 W	30.0 dBm	1.000 W
Antenna Gain (dBi) ^{Note 2}	3.2	3.2				3.2 dBi	Pass	
eirp (dBm) ^{Note 2}	13.6	13.8			16.7 dBm	0.047 W		

- Note 1: Output power measured using a spectrum analyzer (see plots below) with RBW=1MHz, VB=3 MHz, sample detector, power averaging on (transmitted signal was continuous) and power integration over 50 MHz for n20 (option #2, method 1 in KDB 558074, equivalent to method 1 of DA-02-2138A1 for U-NII devices).
 Spurious limit is -30dBc.
- Note 2: As there is no coherency between chains the total EIRP is the sum of the individual EIRPs and effective antenna gain equals the eirp divide by the sum of the power on each chain.
- Note 3: Power setting - test utility setting, for reference only
- Note 4: Average output power per chain measured with an average power meter, for reference only

Client:	Intel Corporation	Job Number:	J80050
Model:	62205ANHMW (Intel® Centrino® Advanced-N 6205)	T-Log Number:	T80123
Contact:	Steven Hackett	Account Manager:	Christine Krebil
Standard:	FCC 15.247 / FCC 15 E / RSS 210 / FCC 15 B	Class:	N/A

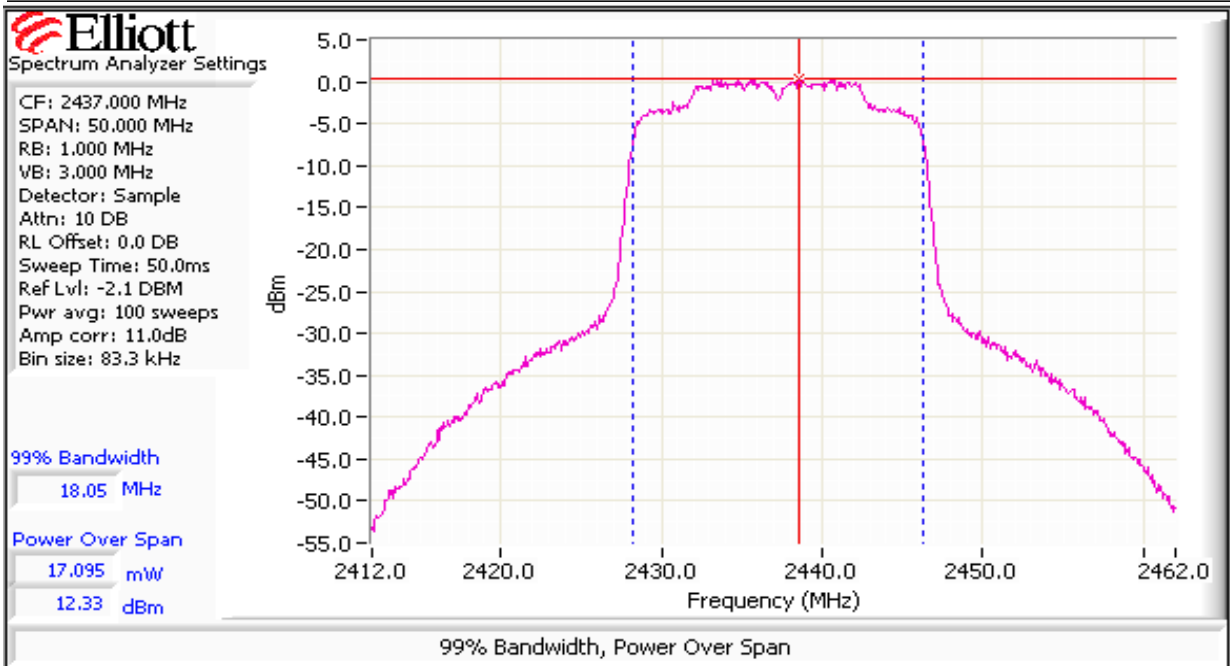
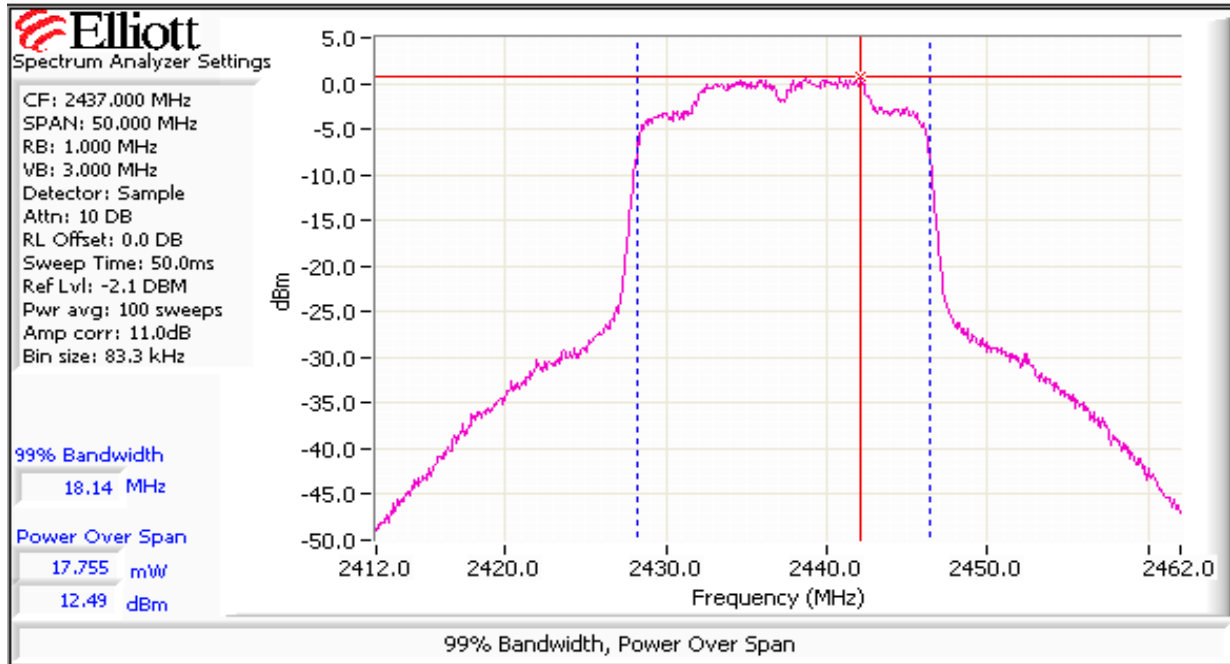

Client:	Intel Corporation	Job Number:	J80050
Model:	62205ANHMW (Intel® Centrino® Advanced-N 6205)	T-Log Number:	T80123
Contact:	Steven Hackett	Account Manager:	Christine Krebil
Standard:	FCC 15.247 / FCC 15 E / RSS 210 / FCC 15 B	Class:	N/A

Operating Mode: 802.11n, 40MHz

2422 MHz	Chain A	Chain B	Chain 3	Chain 4	Total Across All Chains		Limit	
Power Setting ^{Note 3}	23.5	22.0						
Average Power ^{Note 4}	8.0	8.0						
Output Power (dBm) ^{Note 1}	6.1	6.3			9.2 dBm	0.008 W	30.0 dBm	1.000 W
Antenna Gain (dBi) ^{Note 2}	3.2	3.2				3.2 dBi	Pass	
eirp (dBm) ^{Note 2}	9.3	9.5			12.4 dBm	0.017 W	Pass	

2437 MHz	Chain A	Chain B	Chain 3	Chain 4	Total Across All Chains		Limit	
Power Setting ^{Note 3}	29.5	28.0						
Average Power ^{Note 4}	13.7	13.7						
Output Power (dBm) ^{Note 1}	12.3	12.1			15.2 dBm	0.033 W	30.0 dBm	1.000 W
Antenna Gain (dBi) ^{Note 2}	3.2	3.2				3.2 dBi	Pass	
eirp (dBm) ^{Note 2}	15.5	15.3			18.4 dBm	0.069 W	Pass	

2452 MHz	Chain A	Chain B	Chain 3	Chain 4	Total Across All Chains		Limit	
Power Setting ^{Note 3}	24.0	22.5						
Average Power ^{Note 4}	8.6	8.6						
Output Power (dBm) ^{Note 1}	7.98	7.7			10.9 dBm	0.012 W	30.0 dBm	1.000 W
Antenna Gain (dBi) ^{Note 2}	3.2	3.2				3.2 dBi	Pass	
eirp (dBm) ^{Note 2}	11.18	10.9			14.1 dBm	0.025 W	Pass	

Note 1:	Output power measured using a spectrum analyzer (see plots below) with RBW=1MHz, VB=3 MHz, sample detector, power averaging on (transmitted signal was continuous) and power integration over 100 MHz for n40 (option #2, method 1 in KDB 558074, equivalent to method 1 of DA-02-2138A1 for U-NII devices). Spurious limit is -30dBc.
Note 2:	As there is no coherency between chains the total EIRP is the sum of the individual EIRPs and effective antenna gain equals the eirp divide by the sum of the power on each chain.
Note 3:	Power setting - test utility setting, for reference only
Note 4:	Average output power per chain measured with an average power meter, for reference only

Client:	Intel Corporation	Job Number:	J80050
Model:	62205ANHMW (Intel® Centrino® Advanced-N 6205)	T-Log Number:	T80123
Contact:	Steven Hackett	Account Manager:	Christine Krebil
Standard:	FCC 15.247 / FCC 15 E / RSS 210 / FCC 15 B	Class:	N/A

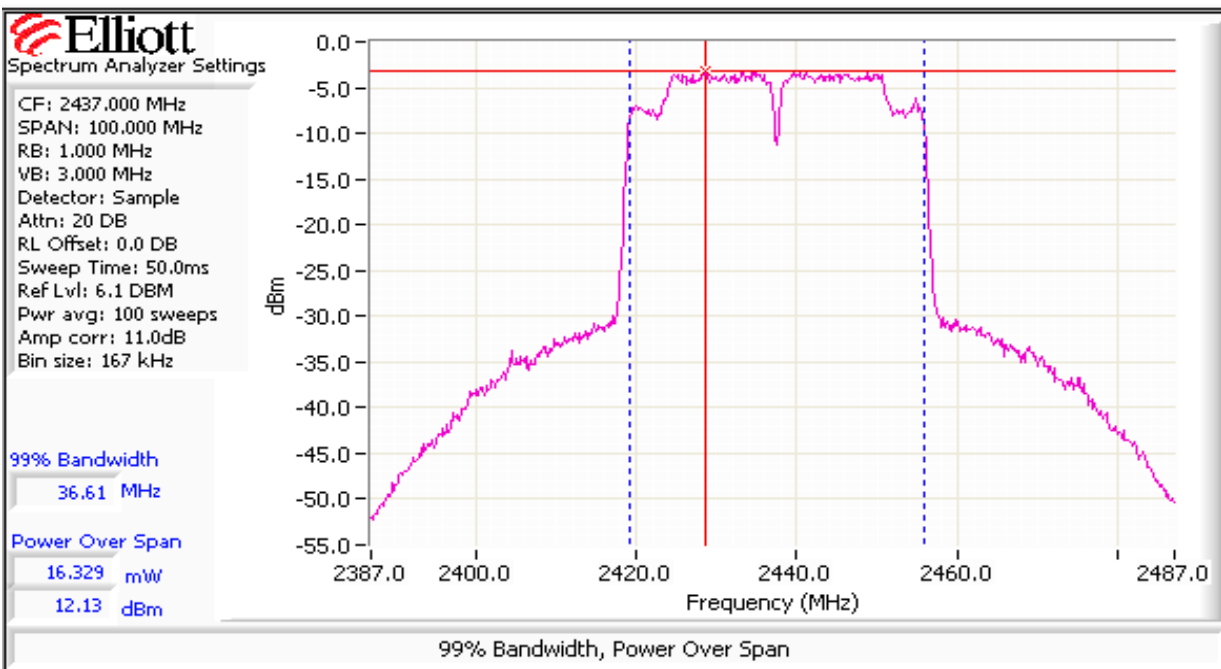
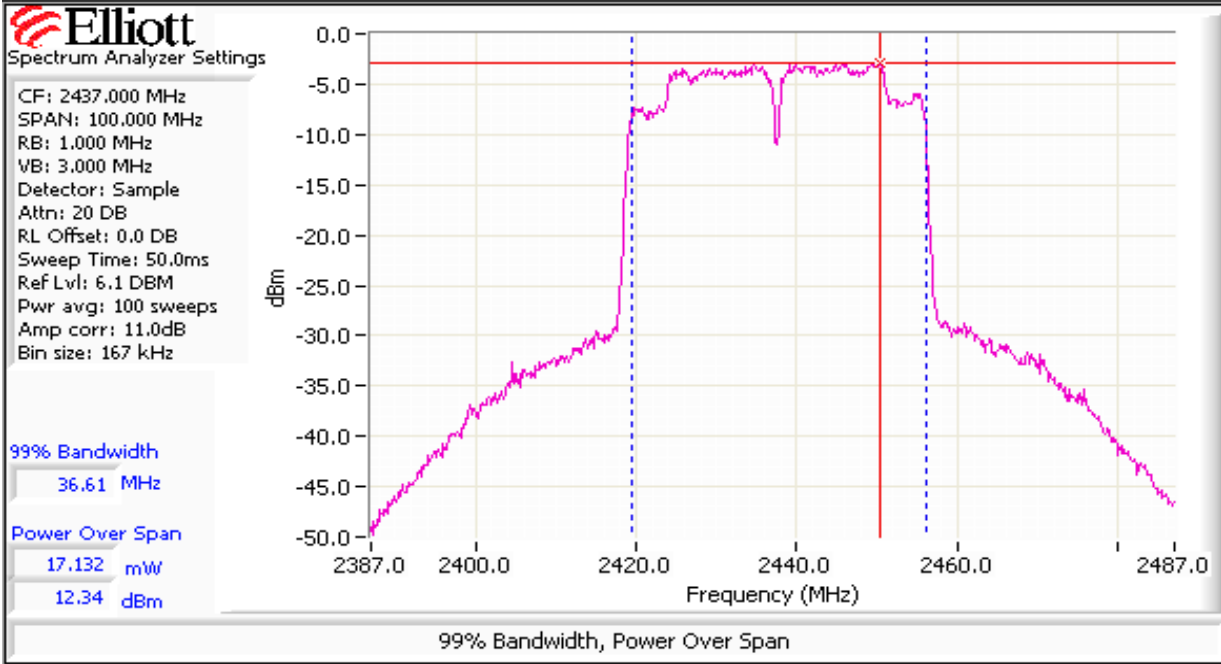

Client:	Intel Corporation	Job Number:	J80050
Model:	62205ANHMW (Intel® Centrino® Advanced-N 6205)	T-Log Number:	T80123
Contact:	Steven Hackett	Account Manager:	Christine Krebil
Standard:	FCC 15.247 / FCC 15 E / RSS 210 / FCC 15 B	Class:	N/A

Run #2: Power spectral Density

Power Setting	Frequency (MHz)	PSD (dBm/3kHz) ^{Note 1}				Total	Limit dBm/3kHz	Result
		Chain A	Chain B	Chain 3	Chain 4			
802.11n 20MHz								
28.5/26.5	2412	-10.8	-11.4			-8.1	8.0	Pass
29.5/28	2437	-10.3	-10.7			-7.5	8.0	Pass
28/26.5	2462	-10.7	-11.0			-7.8	8.0	Pass
802.11n 40MHz								
23.5/22	2422	-18.5	-19.7			-16.0	8.0	Pass
29.5/28	2437	-13.3	-13.2			-10.2	8.0	Pass
24,22.5	2452	-19.3	-18.8			-16.0	8.0	Pass

Note 1: Power spectral density measured using RB=3 kHz, VB=10kHz, analyzer with peak detector and with a sweep time set to ensure a dwell time of at least 1 second per 3kHz. The measurement is made at the frequency of PPSD determined from preliminary scans using RB=3kHz using multiple sweeps at a faster rate over the 6dB bandwidth of the signal.

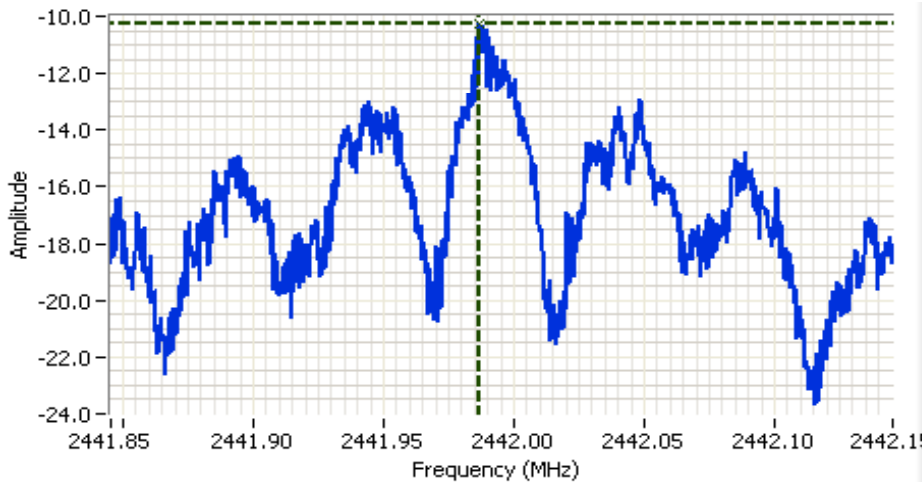

Analyzer Settings
 Agilent Technologies, E4446A
 CF: 2441.995 MHz
 SPAN: 300 kHz
 RB: 3.00 kHz
 VB: 10.0 kHz
 Detector: POS
 Attn: 10 DB
 RL Offset: 10.3 DB
 Sweep Time: 100.0s
 Ref Lvl: -6.7 DBM

Comments
 802.11n 20MHz
 Ch 6, chain A
 PSD: -10.3 dBm/3kHz

Cursor 1	2441.9870	-10.28	+	-
	0.0000	0.00	+	-

Client:	Intel Corporation	Job Number:	J80050
Model:	62205ANHMW (Intel® Centrino® Advanced-N 6205)	T-Log Number:	T80123
Contact:	Steven Hackett	Account Manager:	Christine Krebil
Standard:	FCC 15.247 / FCC 15 E / RSS 210 / FCC 15 B	Class:	N/A

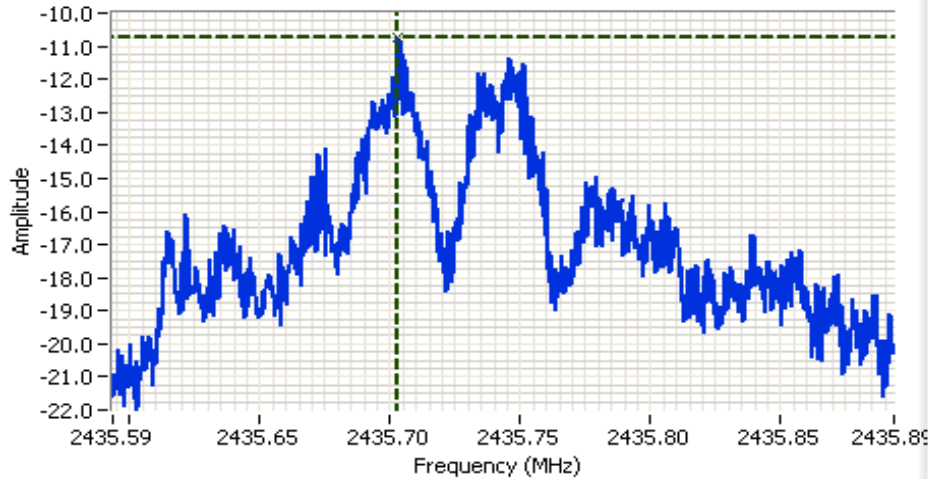

Analyzer Settings
 Agilent Technologies, E4446A
 CF: 2435.744 MHz
 SPAN: 300 kHz
 RB: 3.00 kHz
 VB: 10.0 kHz
 Detector: POS
 Attn: 10 DB
 RL Offset: 10.3 DB
 Sweep Time: 100.0s
 Ref Lvl: -6.7 DBM

Comments
 802.11n 20MHz
 Ch 6, chain B
 PSD: -10.7 dBm/3kHz

Cursor 1 2435.7028 -10.74 

0.0000 0.00 

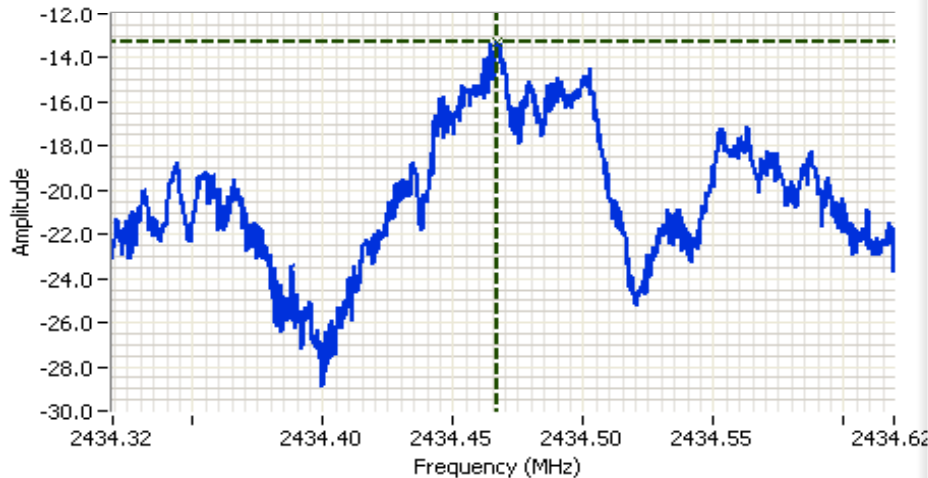

Analyzer Settings
 Agilent Technologies, E4446A
 CF: 2434.469 MHz
 SPAN: 300 kHz
 RB: 3.00 kHz
 VB: 10.0 kHz
 Detector: POS
 Attn: 10 DB
 RL Offset: 10.3 DB
 Sweep Time: 100.0s
 Ref Lvl: -6.7 DBM

Comments
 802.11n 40MHz
 Ch 6, chain A
 PSD: -13.3 dBm/3kHz

Cursor 1 2434.4670 -13.27 

0.0000 0.00 



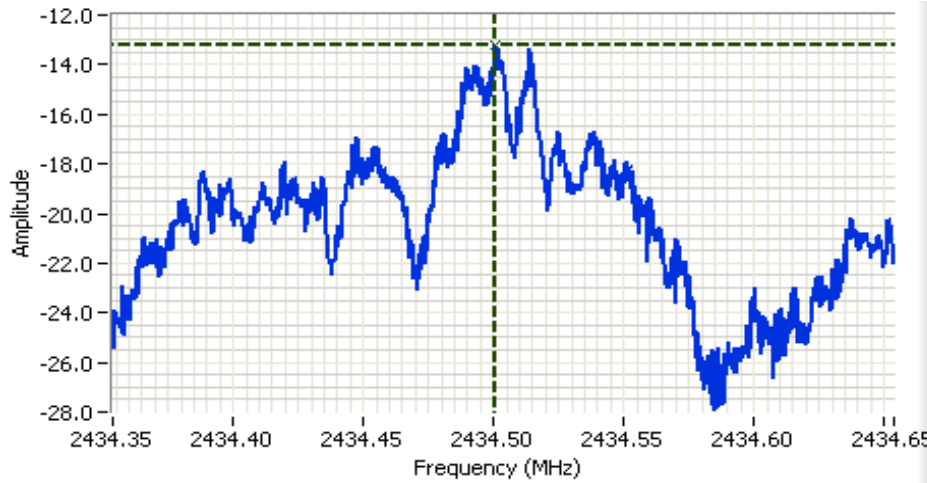

Client:	Intel Corporation	Job Number:	J80050
Model:	62205ANHMW (Intel® Centrino® Advanced-N 6205)	T-Log Number:	T80123
Contact:	Steven Hackett	Account Manager:	Christine Krebil
Standard:	FCC 15.247 / FCC 15 E / RSS 210 / FCC 15 B	Class:	N/A



Analyzer Settings
 Agilent Technologies, E4446A
 CF: 2434.504 MHz
 SPAN: 300 kHz
 RB: 3.00 kHz
 VB: 10.0 kHz
 Detector: POS
 Attn: 10 DB
 RL Offset: 10.3 DB
 Sweep Time: 100.0s
 Ref Lvl: -3.7 DBM

Comments
 802.11n 40MHz
 Ch 6, chain B
 PSD: -13.2 dBm/3kHz

Cursor 1 2434.5008 -13.21 

0.0000 0.00 



Run #3: Signal Bandwidth

Power Setting	Frequency (MHz)	Resolution Bandwidth	Bandwidth (MHz)	
			6dB	99%
26.5/24	2412	100kHz	17.5	18.1
29.5/28	2437	100kHz	15.0	18.1
25/24	2462	100kHz	16.3	18.1
22.5/20.5	2422	100kHz	35.1	36.6
29.5/28	2437	100kHz	34.7	36.6
22/21	2452	100kHz	35.1	36.4

Note 1: Measured on a single chain

Note 2: 99% bandwidth measured in accordance with RSS GEN, with RB > 1% of the span and VB > 3xRB

Client:	Intel Corporation	Job Number:	J80050
Model:	62205ANHMW (Intel® Centrino® Advanced-N 6205)	T-Log Number:	T80123
Contact:	Steven Hackett	Account Manager:	Christine Krebil
Standard:	FCC 15.247 / FCC 15 E / RSS 210 / FCC 15 B	Class:	N/A

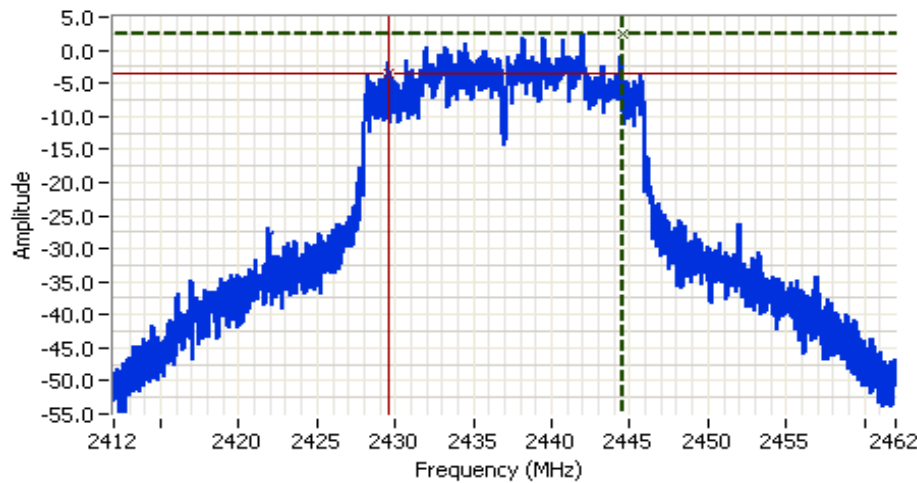

Analyzer Settings

Agilent Technologies, E4446A
 CF: 2437.000 MHz
 SPAN: 50.000 MHz
 RB: 100 kHz
 VB: 100 kHz
 Detector: Normal
 Attn: 10 DB
 RL Offset: 10.3 DB
 Sweep Time: 7.5ms
 Ref Lvl: 9.3 DBM

Comments

802.11n 20MHz
 Ch 1, chain A
 6dB BW: 15.0 MHz

Cursor 1	2444.5325	2.42	
Cursor 2	2429.5175	-3.58	

Delta Freq. 15.015
 Delta Amplitude 6.00

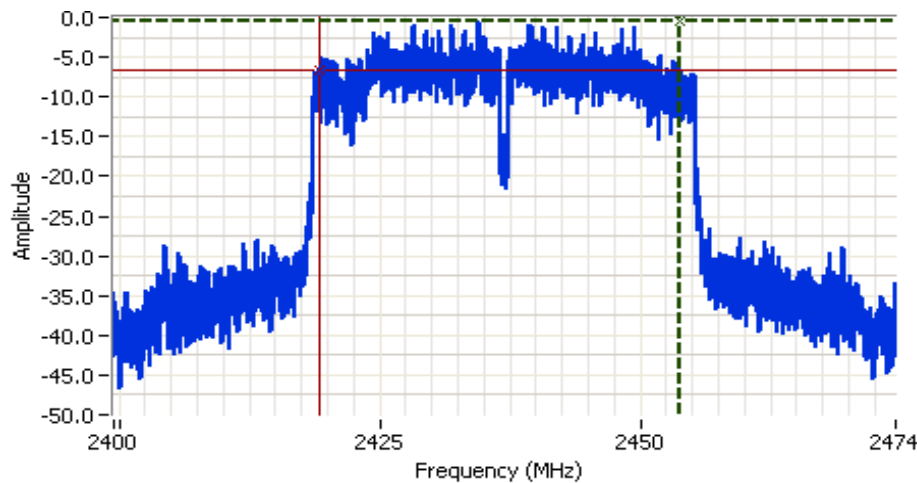

Analyzer Settings

Agilent Technologies, E4446A
 CF: 2437.000 MHz
 SPAN: 75.000 MHz
 RB: 100 kHz
 VB: 100 kHz
 Detector: Normal
 Attn: 10 DB
 RL Offset: 10.3 DB
 Sweep Time: 9.1ms
 Ref Lvl: 9.3 DBM

Comments

802.11n 40MHz
 Ch 6, chain B
 6dB BW: 34.7 MHz

Cursor 1	2453.8544	-0.56	
Cursor 2	2419.1697	-6.56	

Delta Freq. 34.685
 Delta Amplitude 6.00



Client:	Intel Corporation	Job Number:	J80050
Model:	62205ANHMW (Intel® Centrino® Advanced-N 6205)	T-Log Number:	T80123
Contact:	Steven Hackett	Account Manager:	Christine Krebil
Standard:	FCC 15.247 / FCC 15 E / RSS 210 / FCC 15 B	Class:	N/A

Run #4: Out of Band Spurious Emissions

#1	Power Setting Per Chain				Frequency (MHz)	Limit	Result
	#2	#3	#4				
26.5	24				2412	-30dBc	Pass
29.5	28				2437	-30dBc	Pass
25	24				2462	-30dBc	Pass
22.5	20.5				2422	-30dBc	Pass
29.5	28				2437	-30dBc	Pass
22	21				2452	-30dBc	Pass

Note 1: Measured on each chain individually

Plots for low channel, 802.11n 20MHz mode Chains A and B, power setting(s) = 26.5/24.0

Additional plot showing compliance with -30dBc limit from 2390 MHz to 2400 MHz. Radiated measurements used to show compliance with the limits in the restricted band below 2390 MHz.

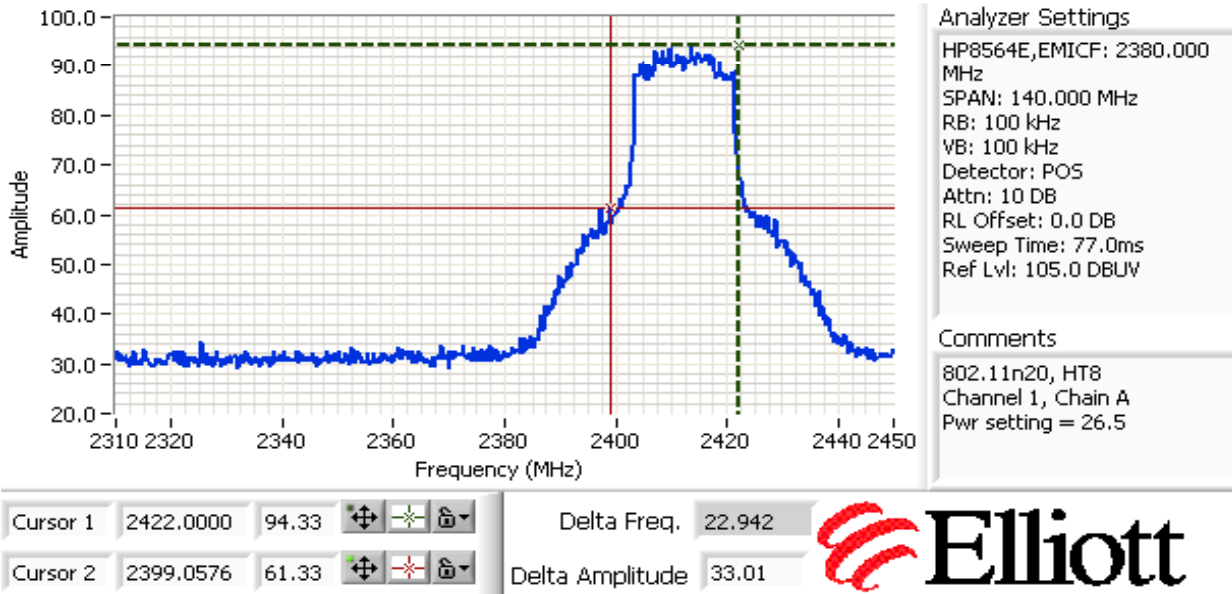

Client:	Intel Corporation	Job Number:	J80050
Model:	62205ANHMW (Intel® Centrino® Advanced-N 6205)	T-Log Number:	T80123
Contact:	Steven Hackett	Account Manager:	Christine Krebil
Standard:	FCC 15.247 / FCC 15 E / RSS 210 / FCC 15 B	Class:	N/A

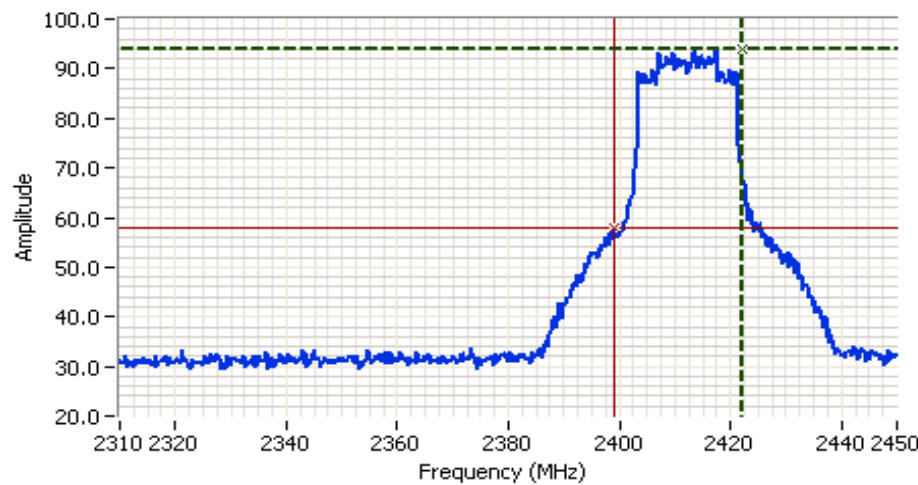
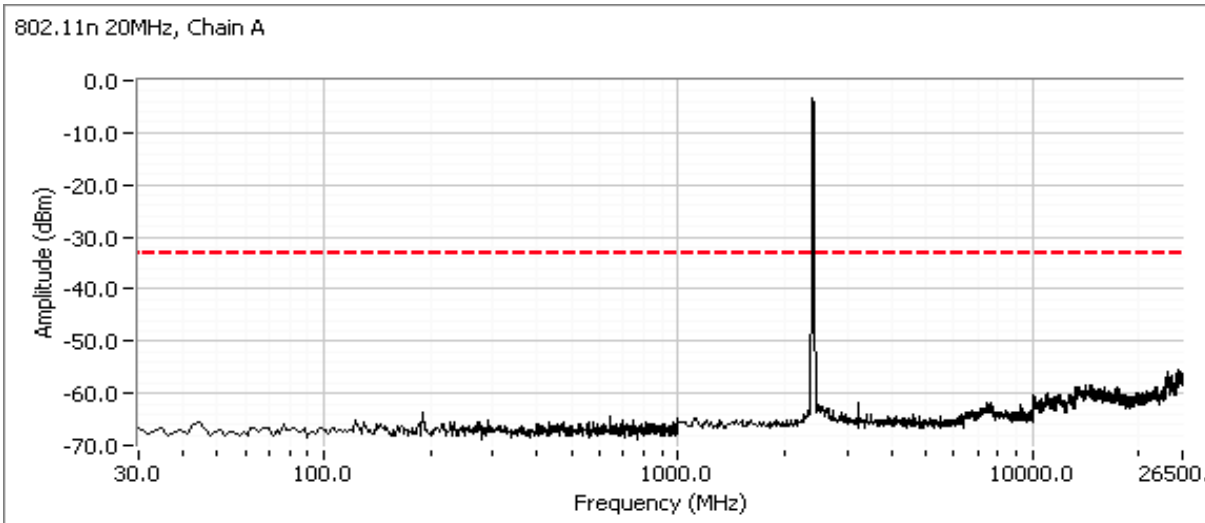

Analyzer Settings
 HP8564E,EMICF: 2380.000 MHz
 SPAN: 140.000 MHz
 RB: 100 kHz
 VB: 100 kHz
 Detector: POS
 Attn: 10 DB
 RL Offset: 0.0 DB
 Sweep Time: 77.0ms
 Ref Lvl: 105.0 DBUV

Comments
 802.11n20, HT8
 Channel 1, Chain B
 Pwr setting = 24.0

Cursor 1	2422.0000	94.00	Delta Freq.	22.942
Cursor 2	2399.0576	57.91	Delta Amplitude	36.09

Client:	Intel Corporation	Job Number:	J80050
Model:	62205ANHMW (Intel® Centrino® Advanced-N 6205)	T-Log Number:	T80123
Contact:	Steven Hackett	Account Manager:	Christine Krebil
Standard:	FCC 15.247 / FCC 15 E / RSS 210 / FCC 15 B	Class:	N/A

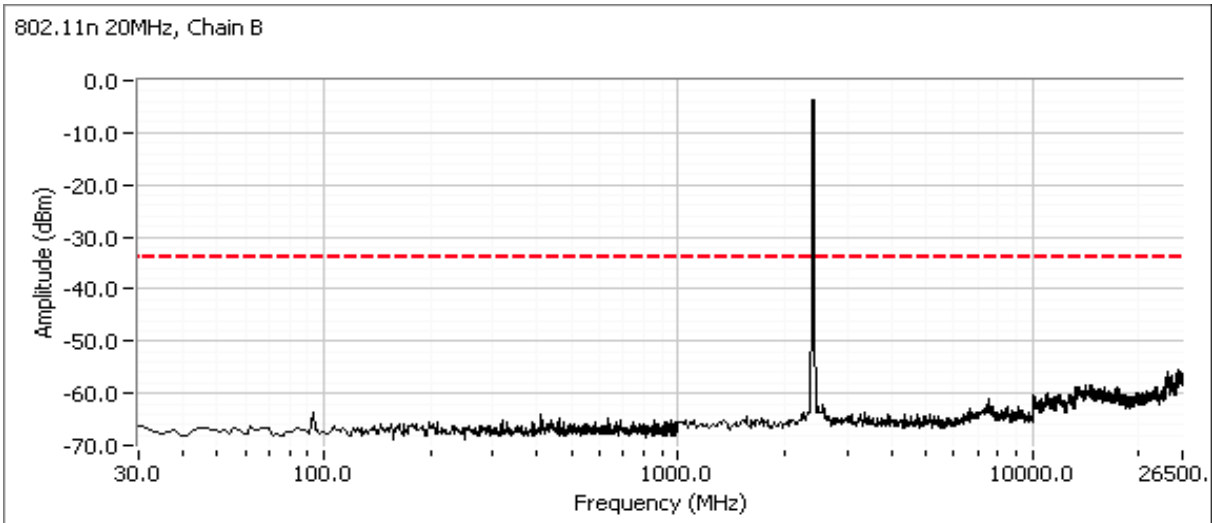

Plots for center channel, 802.11n 20MHz mode Chains A and B, power setting(s) = 29.5/28

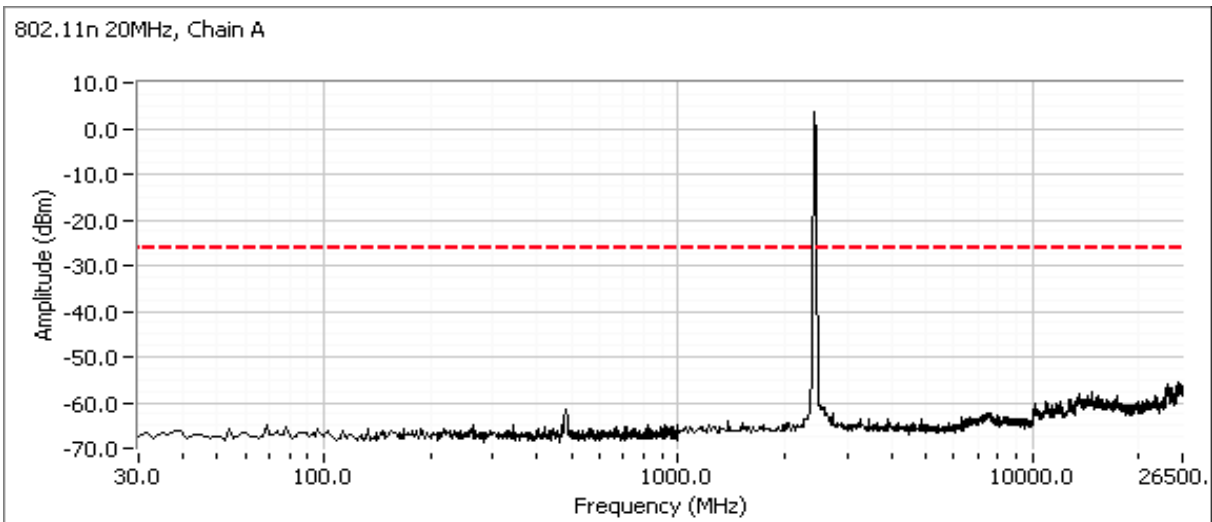

Client:	Intel Corporation	Job Number:	J80050
Model:	62205ANHMW (Intel® Centrino® Advanced-N 6205)	T-Log Number:	T80123
Contact:	Steven Hackett	Account Manager:	Christine Krebil
Standard:	FCC 15.247 / FCC 15 E / RSS 210 / FCC 15 B	Class:	N/A

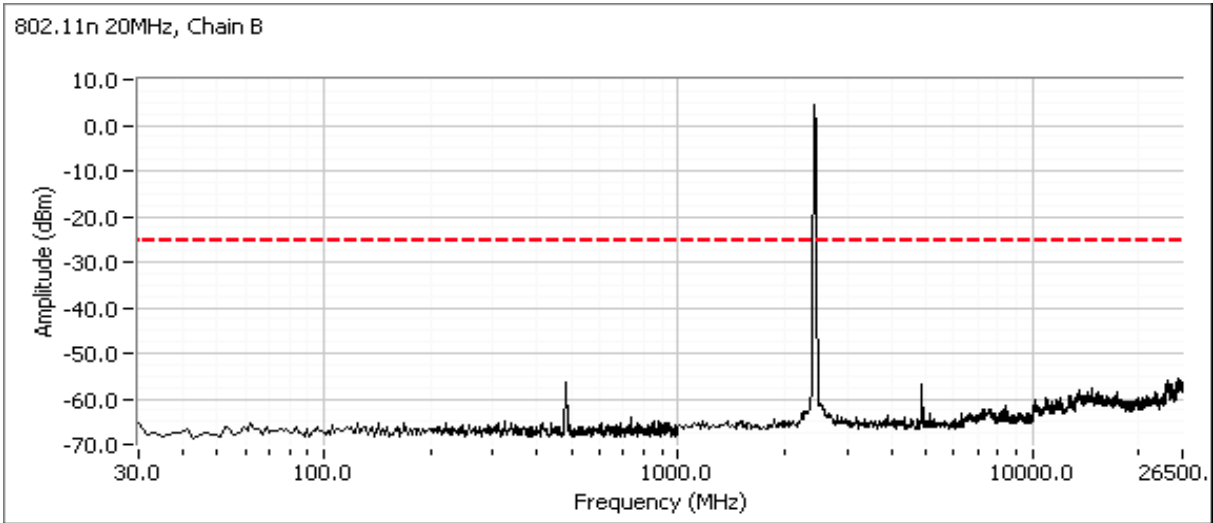

Plots for high channel, 802.11n 20MHz mode Chains A and B, power setting(s) = 25.0/24.0

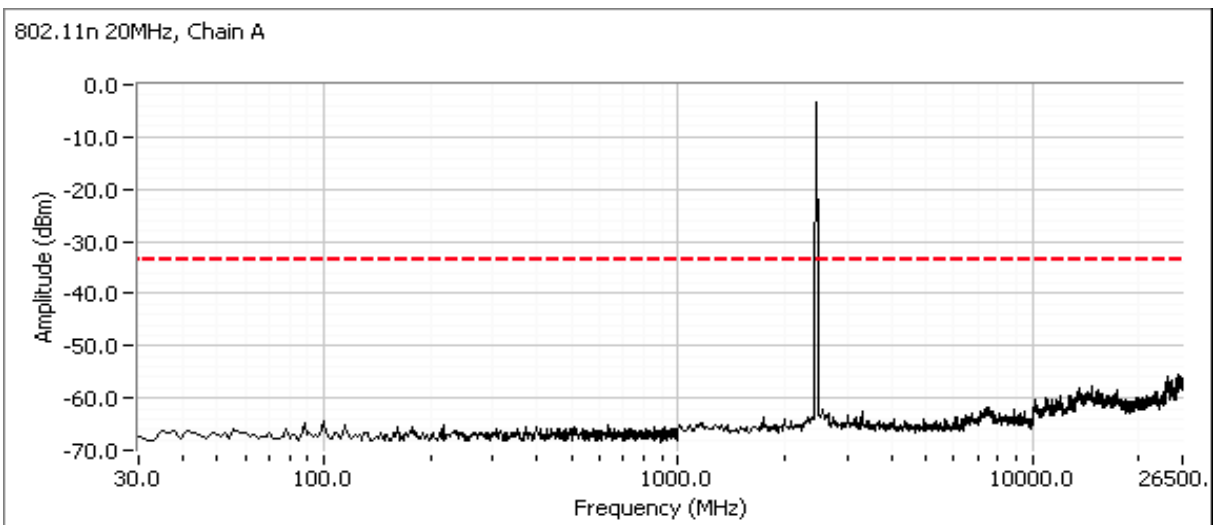

Client:	Intel Corporation	Job Number:	J80050
Model:	62205ANHMW (Intel® Centrino® Advanced-N 6205)	T-Log Number:	T80123
Contact:	Steven Hackett	Account Manager:	Christine Krebil
Standard:	FCC 15.247 / FCC 15 E / RSS 210 / FCC 15 B	Class:	N/A

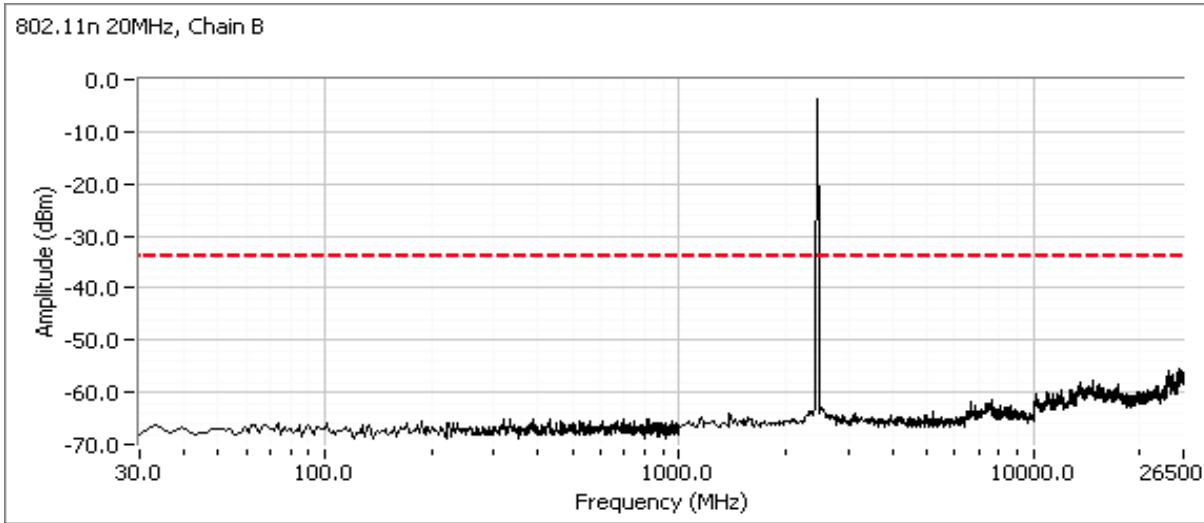

Plots for low channel, 802.11n 40MHz mode Chains A and B, power setting(s) = 22.5/20.5

Additional plot showing compliance with -30dBc limit from 2390 MHz to 2400 MHz. Radiated measurements used to show compliance with the limits in the restricted band below 2390 MHz.

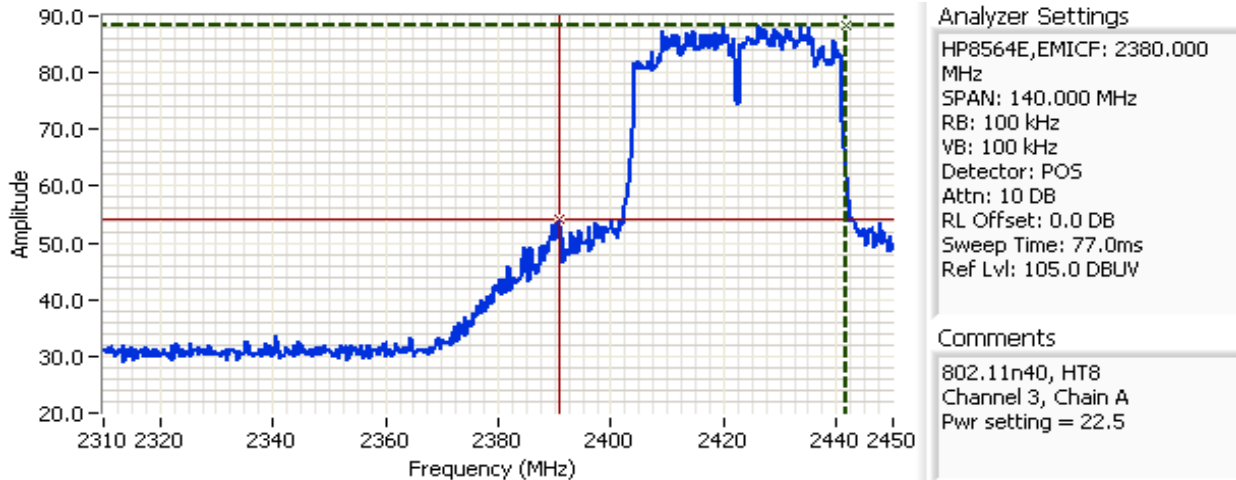

Analyzer Settings
 HP8564E,EMICF: 2380.000 MHz
 SPAN: 140.000 MHz
 RB: 100 kHz
 VB: 100 kHz
 Detector: POS
 Attn: 10 DB
 RL Offset: 0.0 DB
 Sweep Time: 77.0ms
 Ref Lvl: 105.0 DBUV

Comments
 802.11n40, HT8
 Channel 3, Chain A
 Pwr setting = 22.5

Cursor 1	2441.6000	88.33	⊕ ⊖ ⊞ ⊚
Cursor 2	2390.8247	54.17	⊕ ⊖ ⊞ ⊚

Delta Freq. 50.775
 Delta Amplitude 34.16

Client:	Intel Corporation	Job Number:	J80050
Model:	62205ANHMW (Intel® Centrino® Advanced-N 6205)	T-Log Number:	T80123
Contact:	Steven Hackett	Account Manager:	Christine Krebil
Standard:	FCC 15.247 / FCC 15 E / RSS 210 / FCC 15 B	Class:	N/A

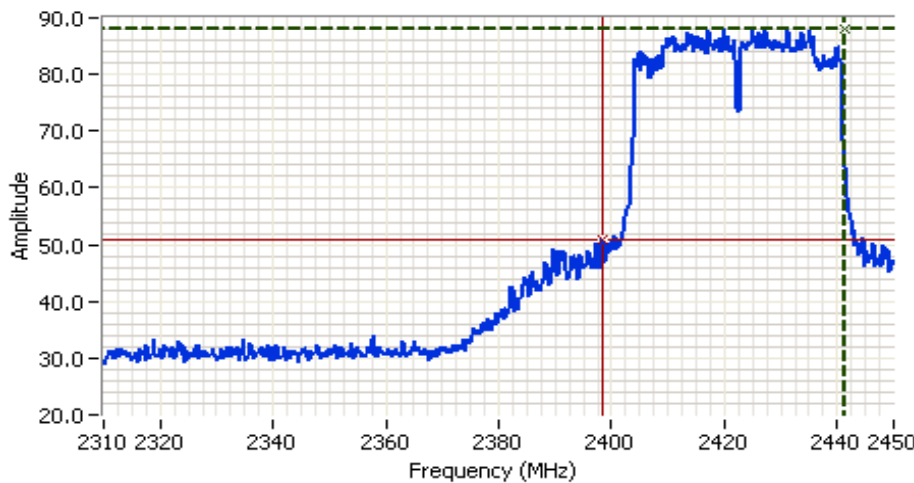
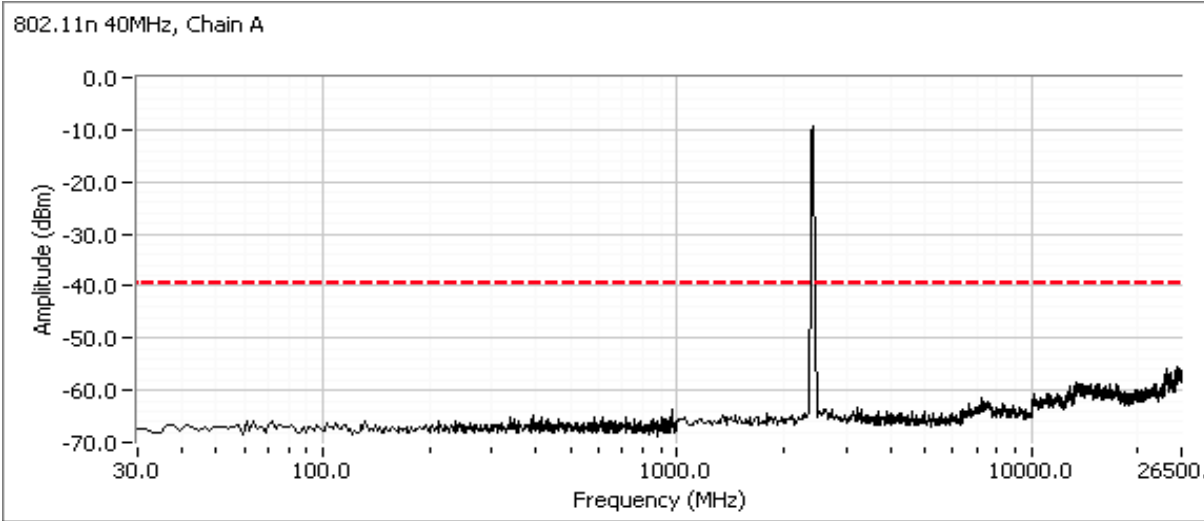

Analyzer Settings

HP8564E,EMICF: 2380.000 MHz
 SPAN: 140.000 MHz
 RB: 100 kHz
 VB: 100 kHz
 Detector: POS
 Attn: 10 DB
 RL Offset: 0.0 DB
 Sweep Time: 77.0ms
 Ref Lvl: 105.0 DBUV

Comments

802.11n40, HT8
 Channel 3, Chain B
 Pwr setting = 20.5

Cursor 1	2441.3667	88.17	+	-	+	-
Cursor 2	2398.4021	50.85	+	-	+	-

Delta Freq. 42.965
 Delta Amplitude 37.31

Client:	Intel Corporation	Job Number:	J80050
Model:	62205ANHMW (Intel® Centrino® Advanced-N 6205)	T-Log Number:	T80123
Contact:	Steven Hackett	Account Manager:	Christine Krebil
Standard:	FCC 15.247 / FCC 15 E / RSS 210 / FCC 15 B	Class:	N/A

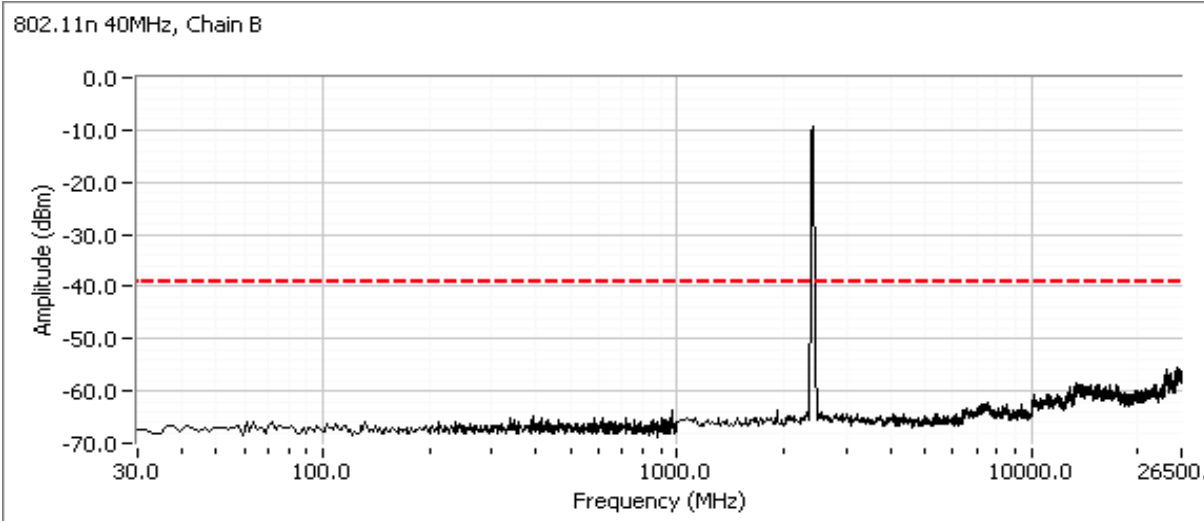

Plots for center channel, 802.11n 40MHz mode Chains A and B, power setting(s) = 29.5/28

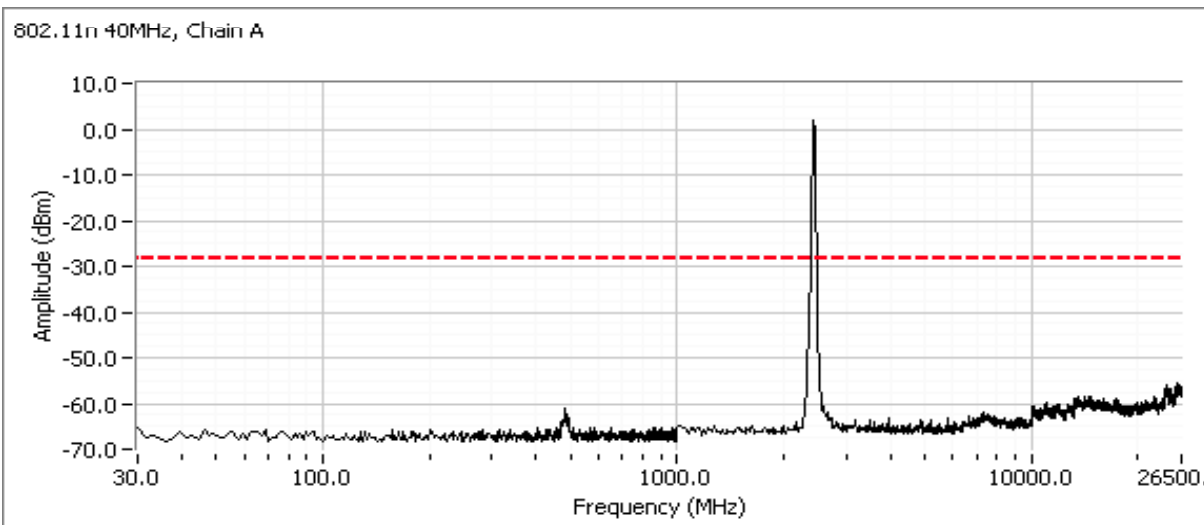

Client:	Intel Corporation	Job Number:	J80050
Model:	62205ANHMW (Intel® Centrino® Advanced-N 6205)	T-Log Number:	T80123
Contact:	Steven Hackett	Account Manager:	Christine Krebil
Standard:	FCC 15.247 / FCC 15 E / RSS 210 / FCC 15 B	Class:	N/A

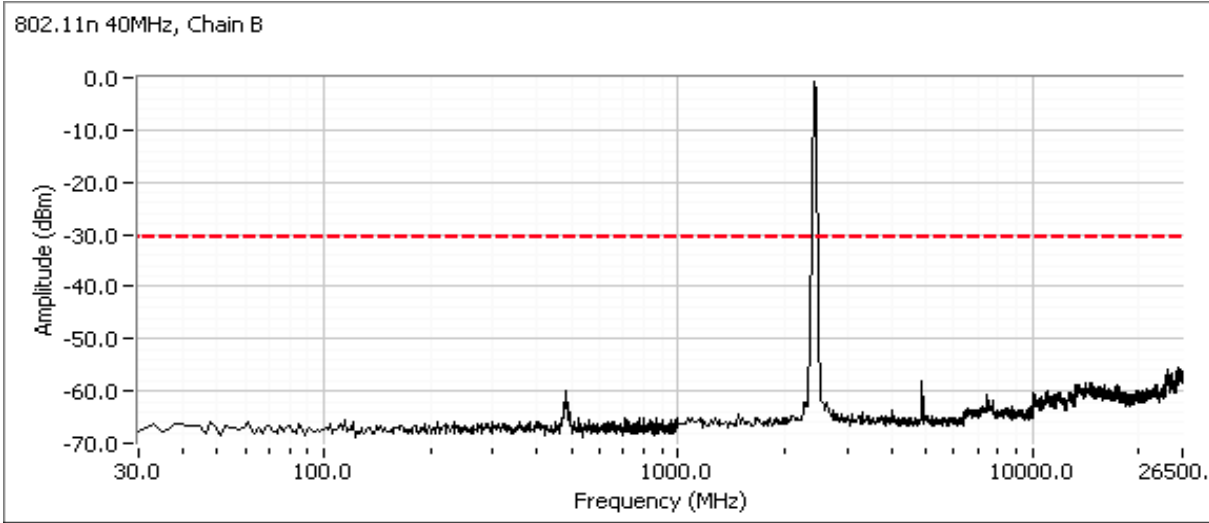

Plots for high channel, 802.11n 40MHz mode Chains A and B, power setting(s) = 22/21

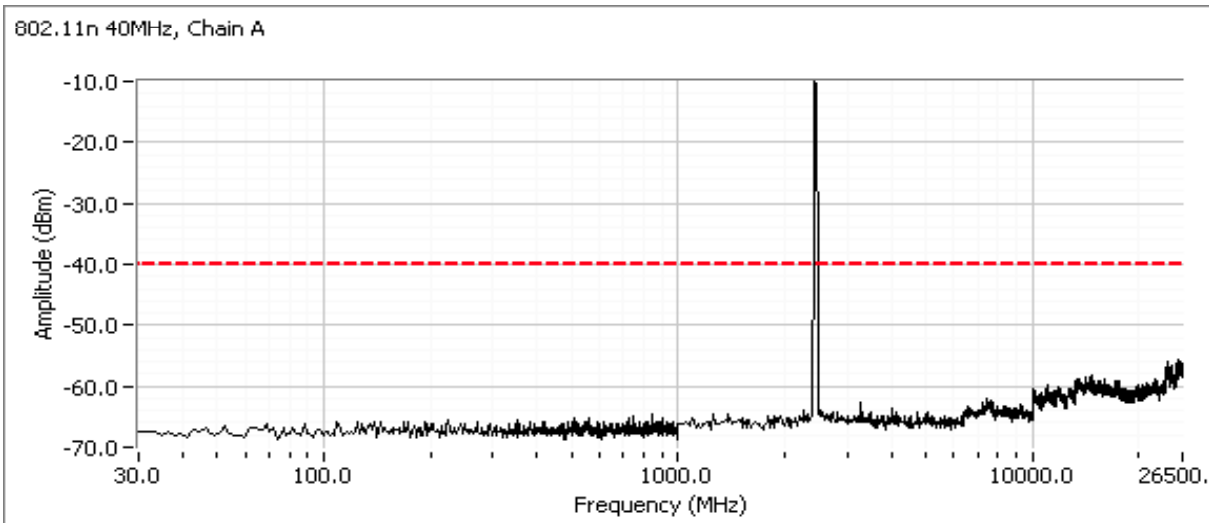

Client:	Intel Corporation	Job Number:	J80050
Model:	62205ANHMW (Intel® Centrino® Advanced-N 6205)	T-Log Number:	T80123
Contact:	Steven Hackett	Account Manager:	Christine Krebil
Standard:	FCC 15.247 / FCC 15 E / RSS 210 / FCC 15 B	Class:	N/A

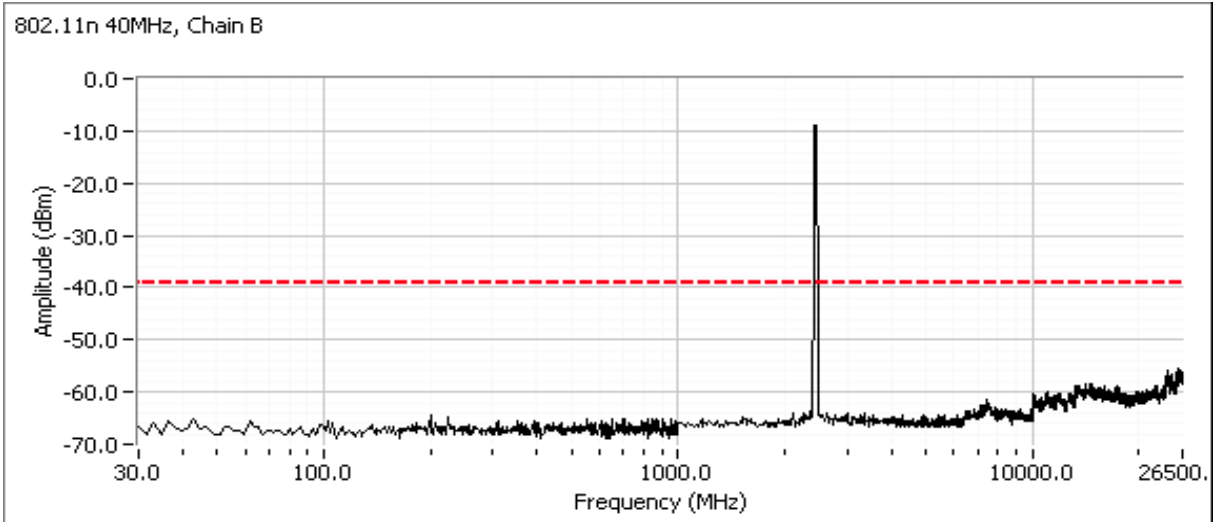

Client:	Intel Corporation	Job Number:	J80050
Model:	62205ANHMW (Intel® Centrino® Advanced-N 6205)	T-Log Number:	T80123
Contact:	Steven Hackett	Account Manager:	Christine Krebil
Standard:	FCC 15.247 / FCC 15 E / RSS 210 / FCC 15 B	Class:	N/A

**RSS 210 and FCC 15.247 (DTS) Antenna Port Measurements
Power, PSD, Bandwidth and Spurious Emissions**

Test Specific Details

Objective: The objective of this test session is to perform final qualification testing of the EUT with respect to the specification listed above.

Date of Test: 8/16/2010
 Test Engineer: John Caizzi/R. Varelas
 Test Location: FT EMC Lab #3

Config. Used: 1
 Config Change: None
 Host Unit Voltage 120V/60Hz

General Test Configuration

The EUT was connected to the spectrum analyzer or power meter via a suitable attenuator. All measurements were made on a single chain.

All measurements have been corrected to allow for the external attenuators used.

Ambient Conditions:

Temperature: 23 °C
 Rel. Humidity: 46 %

Summary of Results

Run #	Pwr setting	Avg Pwr	Test Performed	Limit	Pass / Fail	Result / Margin
1	28.5	16.6	802.11a Output Power	15.247(b)	Pass	15.6 dBm
2	28.5	16.6	802.11a Power spectral Density	15.247(d)	Pass	-9.3 dBm/3kHz
3	28.0	16.5	802.11a Minimum 6dB Bandwidth	15.247(a)	Pass	16.3 MHz
3	28.5	16.6	802.11a 99% Bandwidth	RSS GEN	-	18.8 MHz
4	-	-	802.11a Spurious emissions	15.247(b)	Pass	All emissions below -30dBc limit

Modifications Made During Testing

No modifications were made to the EUT during testing

Deviations From The Standard

No deviations were made from the requirements of the standard.

Client:	Intel Corporation	Job Number:	J80050
Model:	62205ANHMW (Intel® Centrino® Advanced-N 6205)	T-Log Number:	T80123
Contact:	Steven Hackett	Account Manager:	Christine Krebil
Standard:	FCC 15.247 / FCC 15 E / RSS 210 / FCC 15 B	Class:	N/A

Run #1: Output Power

Power Setting ²	Frequency (MHz)	Output Power		Antenna Gain (dBi)	Result	EIRP ^{Note 2}		Output Power	
		(dBm) ¹	mW			dBm	W	(dBm) ³	mW
802.11a Mode, Chain A									
28.5	5745	15.6	36.2	5.0	Pass	20.6	0.115	16.6	45.7
28.0	5785	14.9	31.1	5.0	Pass	19.9	0.098	16.5	44.7
28.0	5825	14.8	30.3	5.0	Pass	19.8	0.096	16.5	44.7
802.11a Mode, Chain B									
26.0	5745	14.7	29.2	5.0	Pass	19.7	0.092	16.5	44.7
26.0	5785	14.3	26.9	5.0	Pass	19.3	0.085	16.5	44.7
26.0	5825	14.6	29.0	5.0	Pass	19.6	0.092	16.5	44.7

Note 1:	Output power measured using a spectrum analyzer (see plots below) with RBW=1MHz, VB=3 MHz, sample detector, power averaging on (transmitted signal was continuous) and power integration over 40 MHz (option #2, method 1 in KDB 558074, equivalent to method 1 of DA-02-2138A1 for U-NII devices). Spurious limit becomes -30dBc .
Note 2:	Power setting - the software power setting used during testing, included for reference only.
Note 3:	Power measured using average power meter and is included for reference only.

Client:	Intel Corporation	Job Number:	J80050
Model:	62205ANHMW (Intel® Centrino® Advanced-N 6205)	T-Log Number:	T80123
Contact:	Steven Hackett	Account Manager:	Christine Krebil
Standard:	FCC 15.247 / FCC 15 E / RSS 210 / FCC 15 B	Class:	N/A

Chain A

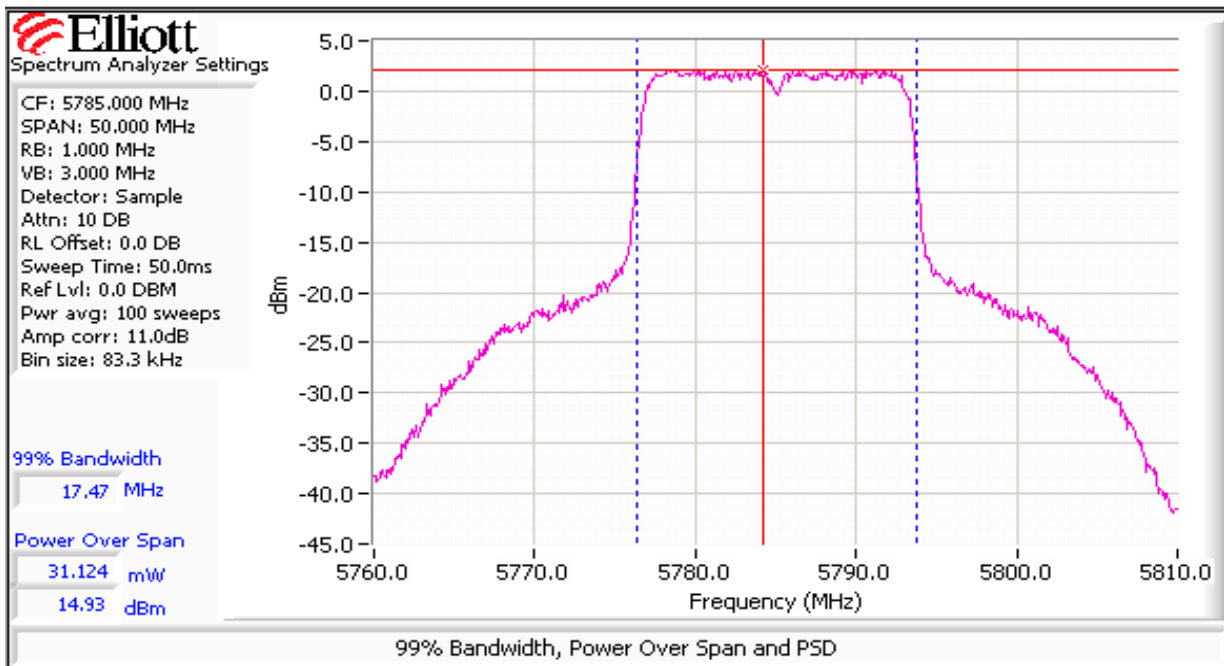
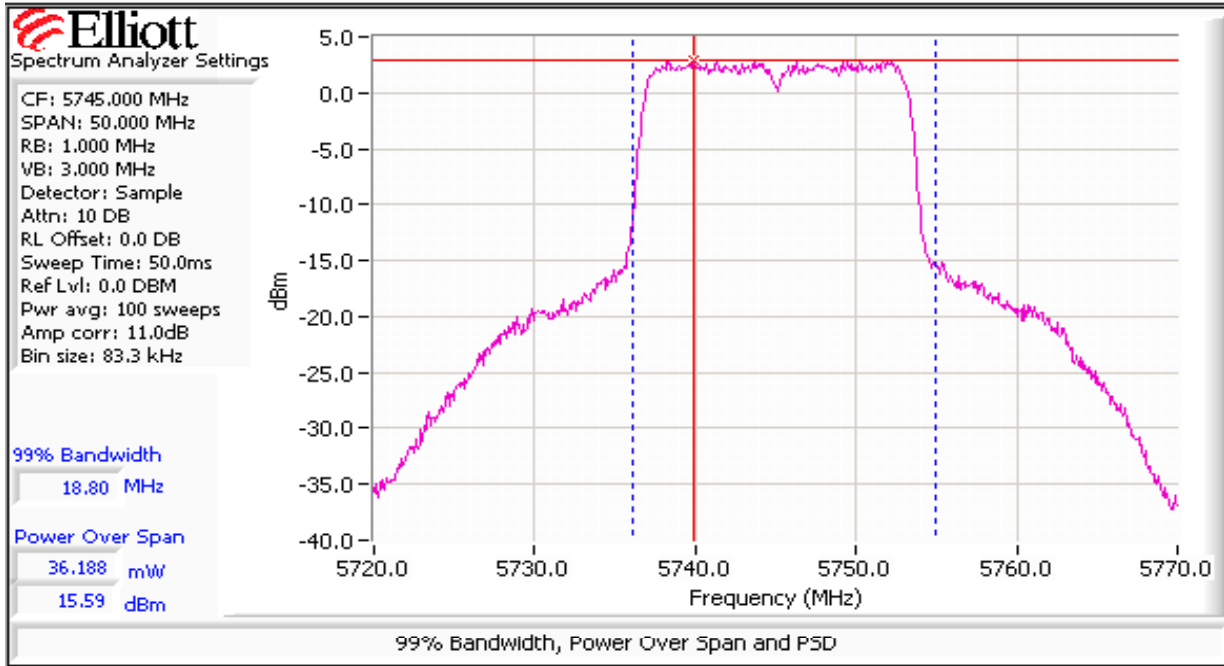

Client:	Intel Corporation	Job Number:	J80050
Model:	62205ANHMW (Intel® Centrino® Advanced-N 6205)	T-Log Number:	T80123
Contact:	Steven Hackett	Account Manager:	Christine Krebil
Standard:	FCC 15.247 / FCC 15 E / RSS 210 / FCC 15 B	Class:	N/A

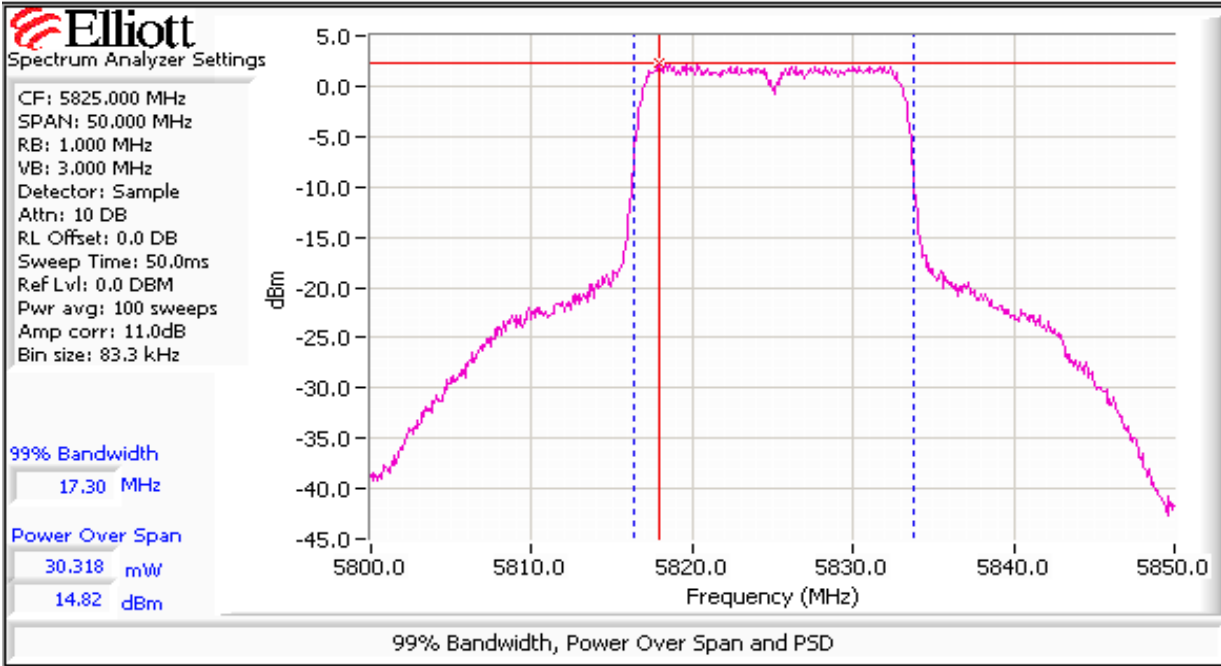

Chain B

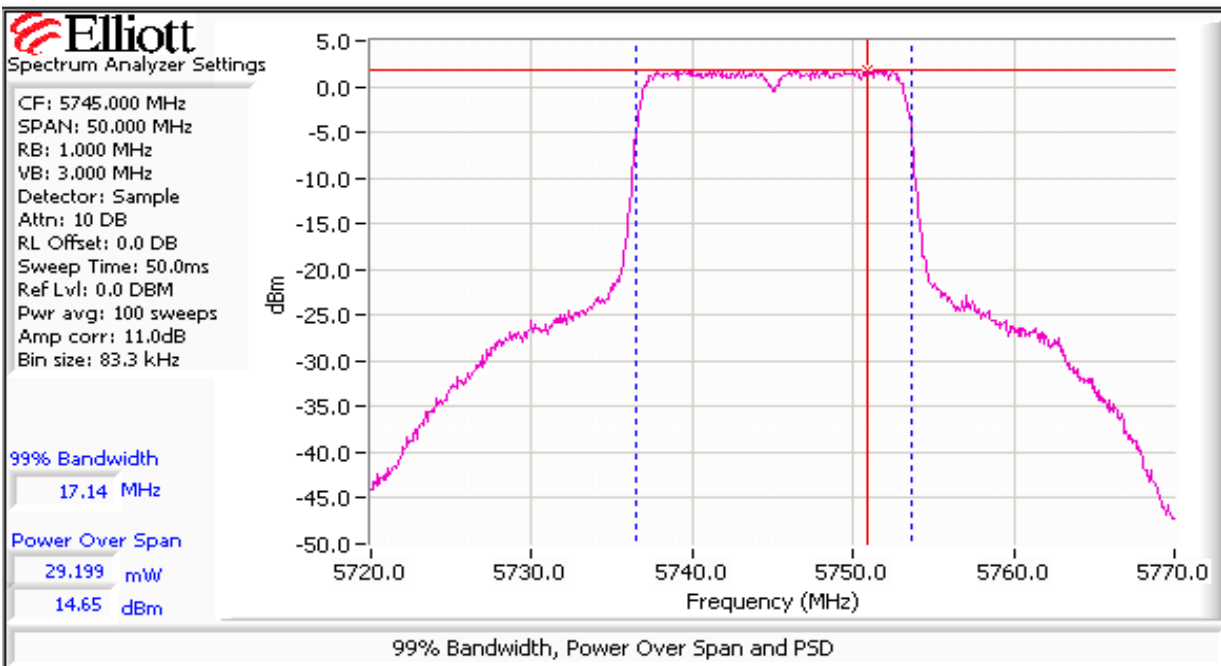

Client:	Intel Corporation	Job Number:	J80050
Model:	62205ANHMW (Intel® Centrino® Advanced-N 6205)	T-Log Number:	T80123
Contact:	Steven Hackett	Account Manager:	Christine Krebil
Standard:	FCC 15.247 / FCC 15 E / RSS 210 / FCC 15 B	Class:	N/A

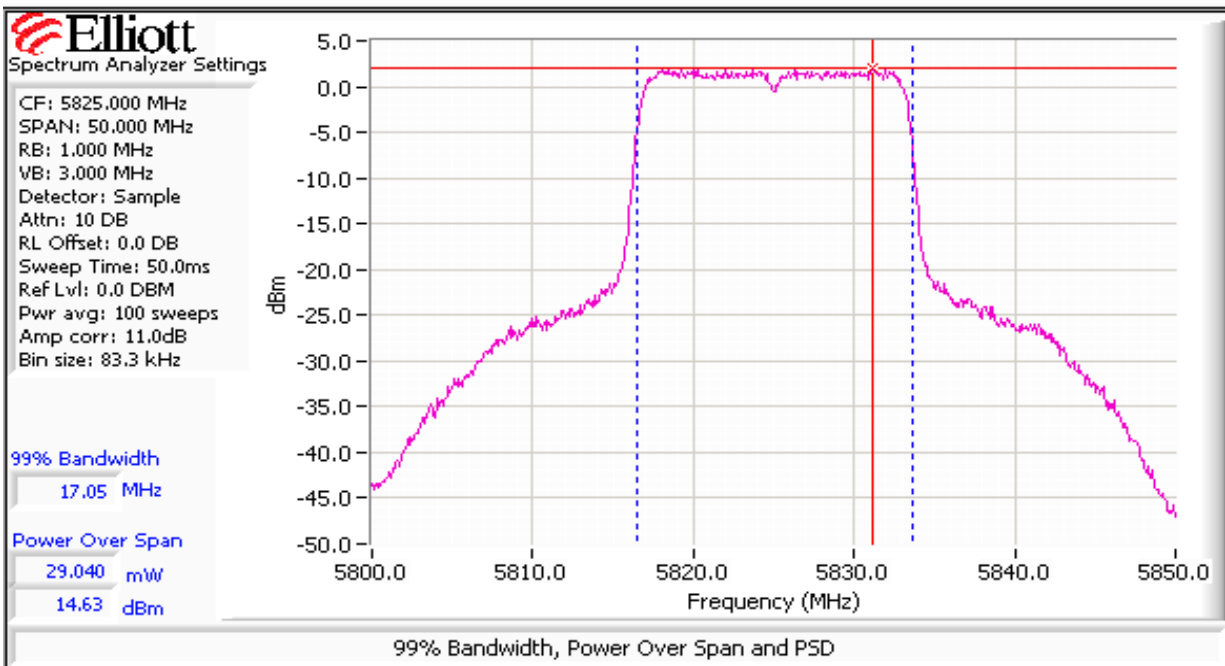
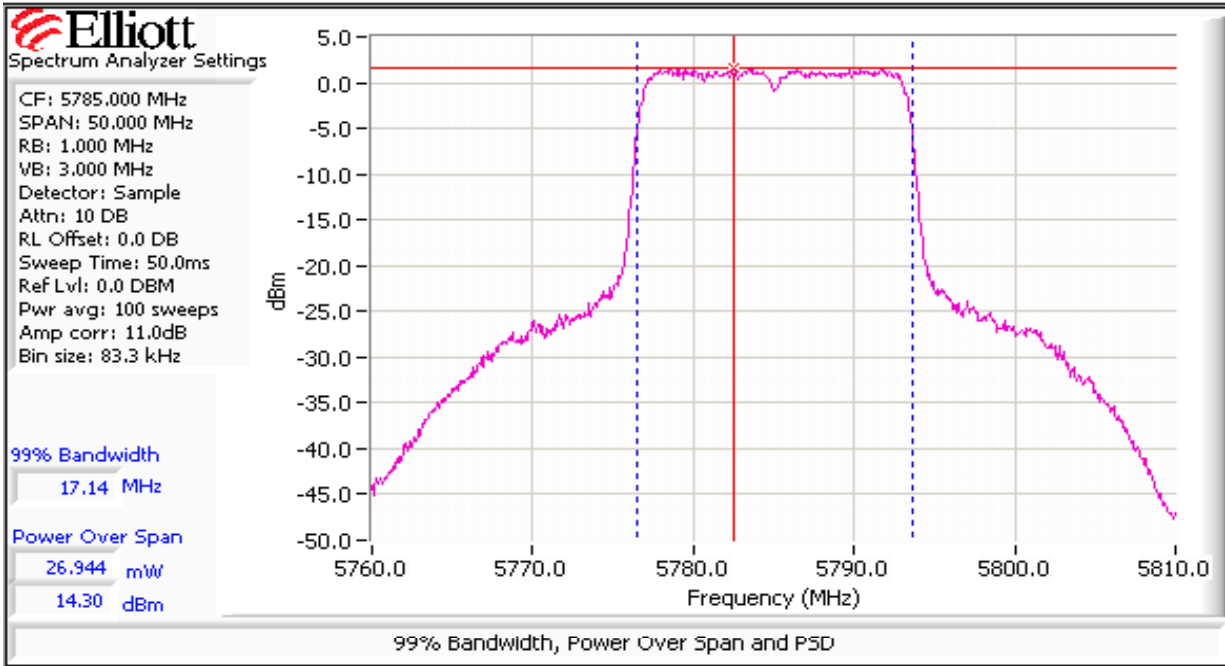

Client:	Intel Corporation	Job Number:	J80050
Model:	62205ANHMW (Intel® Centrino® Advanced-N 6205)	T-Log Number:	T80123
Contact:	Steven Hackett	Account Manager:	Christine Krebil
Standard:	FCC 15.247 / FCC 15 E / RSS 210 / FCC 15 B	Class:	N/A

Run #2: Power spectral Density

Power Setting	Frequency (MHz)	PSD	Limit dBm/3kHz	Result
		(dBm/3kHz) ^{Note 1}		
802.11a Mode, Chain A				
28.5	5745	-9.3	8.0	Pass
28	5785	-10.2	8.0	Pass
28	5825	-9.8	8.0	Pass
802.11a Mode, Chain B				
26	5745	-11.2	8.0	Pass
26	5785	-11.2	8.0	Pass
26	5825	-10.8	8.0	Pass

Note 1: Power spectral density measured using RB=3 kHz, VB=10kHz, analyzer with peak detector and with a sweep time set to ensure a dwell time of at least 1 second per 3kHz. The measurement is made at the frequency of PPSD determined from preliminary scans using RB=3kHz using multiple sweeps at a faster rate over the 6dB bandwidth of the signal.

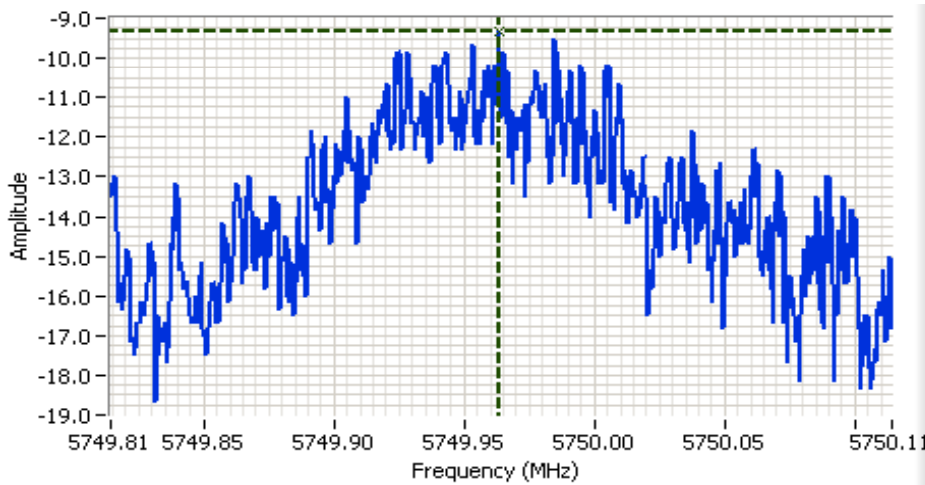

Analyzer Settings

HP8564E,EMICF: 5749.964 MHz
 SPAN: 300 kHz
 RB: 3.00 kHz
 VB: 10.0 kHz
 Detector: Normal
 Attn: 10 DB
 RL Offset: 11.0 DB
 Sweep Time: 100.0s
 Ref Lvl: 11.0 DBM

Comments

PSD 5745 MHz Chain A

Cursor 1	5749.9632	-9.33		
	0.0000	0.00		



Client:	Intel Corporation	Job Number:	J80050
Model:	62205ANHMW (Intel® Centrino® Advanced-N 6205)	T-Log Number:	T80123
Contact:	Steven Hackett	Account Manager:	Christine Krebil
Standard:	FCC 15.247 / FCC 15 E / RSS 210 / FCC 15 B	Class:	N/A

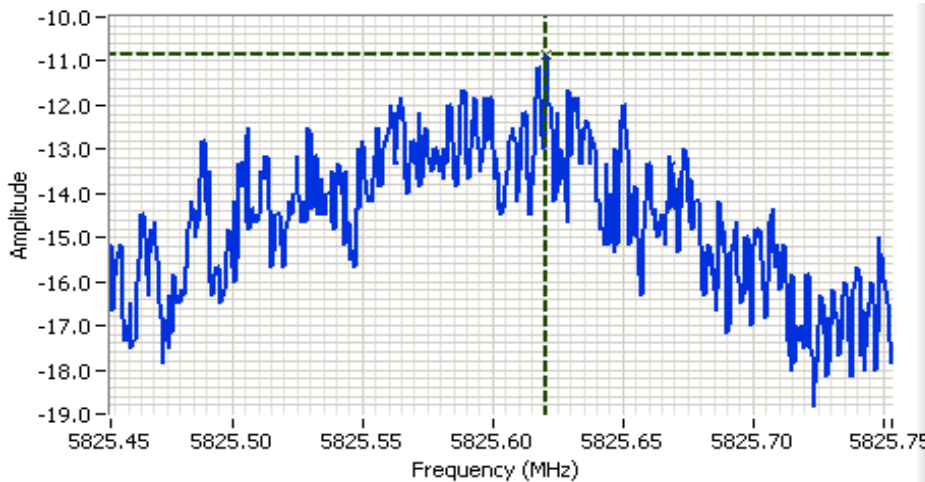

Analyzer Settings
 HP8564E,EMICF: 5825.603 MHz
 SPAN: 300 kHz
 RB: 3.00 kHz
 VB: 10.0 kHz
 Detector: POS
 Attn: 10 DB
 RL Offset: 11.0 DB
 Sweep Time: 100.0s
 Ref Lvl: 11.0 DBM

Comments
 PSD @ 5825 MHz
 Chain B

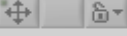
Cursor 1 5825.6208 -10.83 
 0.0000 0.00 



Run #3: Signal Bandwidth

Power Setting	Frequency (MHz)	Resolution Bandwidth	Bandwidth (MHz)	
			6dB	99%
802.11a Mode				
28.0	5785, Chain A	100 kHz	16.333	17.47
26.0	5785, Chain B	100 kHz	16.417	17.14
28.5	5745, Chain A	100 kHz	16.417	18.8
28.0	5825, Chain A	100 kHz	16.333	17.3

Note 1:	99% bandwidth measured in accordance with RSS GEN, with RB > 1% of the span and VB > 3xRB (taken from power measurement plots)
Note 2:	6dB bandwidth measured on the center channel for each chain and then on the top and bottom channels for the chain with the narrowest 6dB bandwidth.

Client:	Intel Corporation	Job Number:	J80050
Model:	62205ANHMW (Intel® Centrino® Advanced-N 6205)	T-Log Number:	T80123
Contact:	Steven Hackett	Account Manager:	Christine Krebil
Standard:	FCC 15.247 / FCC 15 E / RSS 210 / FCC 15 B	Class:	N/A

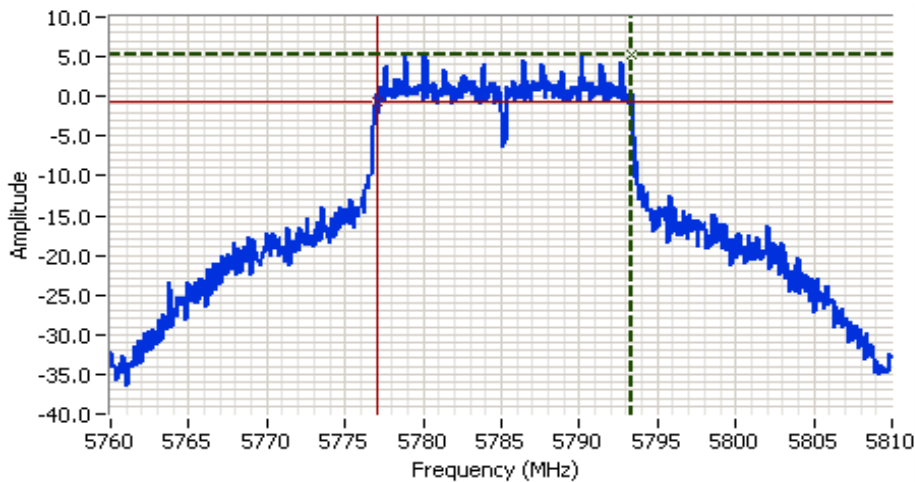

Analyzer Settings
 HP8564E,EMICF: 5785.000 MHz
 SPAN: 50.000 MHz
 RB: 100 kHz
 VB: 100 kHz
 Detector: POS
 Attn: 10 DB
 RL Offset: 11.0 DB
 Sweep Time: 50.0ms
 Ref Lvl: 11.0 DBM

Comments
 6dB BW: 16.333 MHz
 Chain A

Cursor 1 5793.3333 5.33 

Cursor 2 5777.0000 -0.67 

Delta Freq. 16.333

Delta Amplitude 6.00



Run #4: Out of Band Spurious Emissions

Mode	Chain	Frequency (MHz)	Limit	Result
802.11a	A	5745	-30dBc	Pass
		5785	-30dBc	Pass
		5825	-30dBc	Pass
	B	5745	-30dBc	Pass
		5785	-30dBc	Pass
		5825	-30dBc	Pass

Client:	Intel Corporation	Job Number:	J80050
Model:	62205ANHMW (Intel® Centrino® Advanced-N 6205)	T-Log Number:	T80123
Contact:	Steven Hackett	Account Manager:	Christine Krebil
Standard:	FCC 15.247 / FCC 15 E / RSS 210 / FCC 15 B	Class:	N/A

Plots for low channel, 802.11a mode Chains A and B, power setting(s) = 28.5/26.0

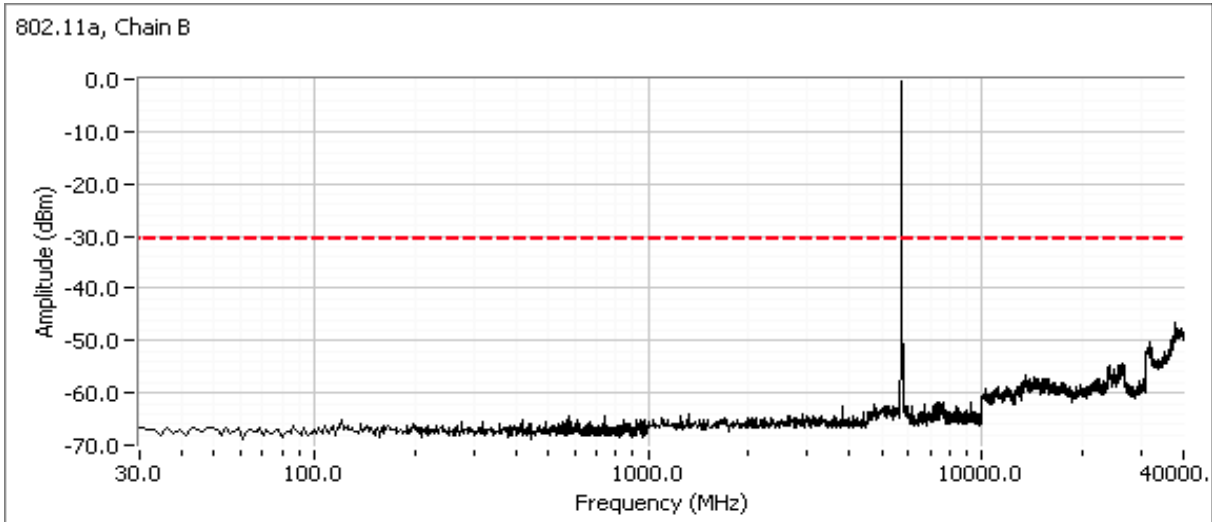
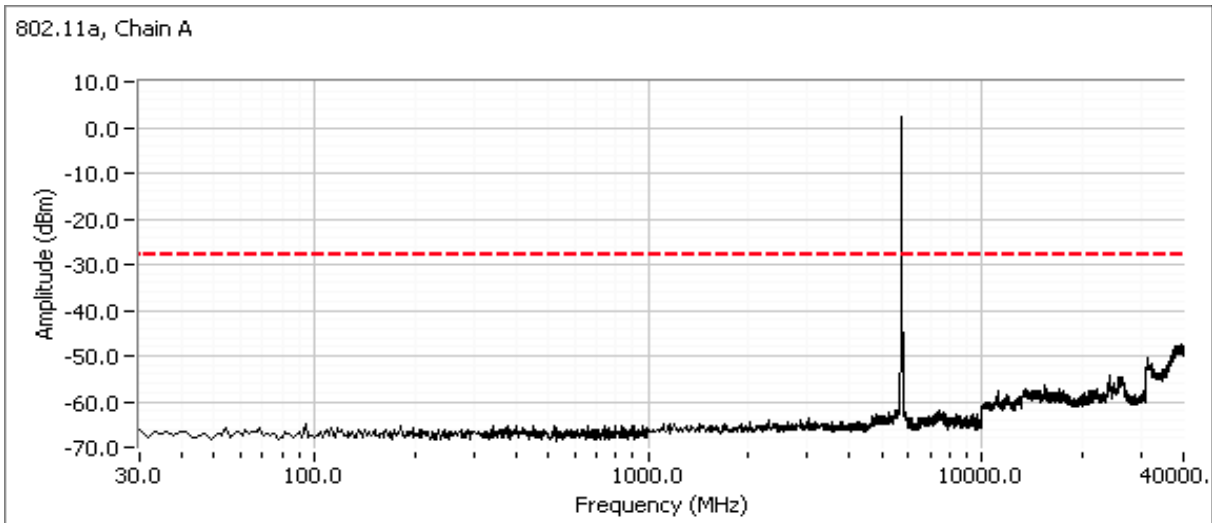

Client:	Intel Corporation	Job Number:	J80050
Model:	62205ANHMW (Intel® Centrino® Advanced-N 6205)	T-Log Number:	T80123
Contact:	Steven Hackett	Account Manager:	Christine Krebil
Standard:	FCC 15.247 / FCC 15 E / RSS 210 / FCC 15 B	Class:	N/A

Additional plots for each chain showing compliance with -30dBc limit at the 5725MHz band edge.

802.11a, Chain A, BE

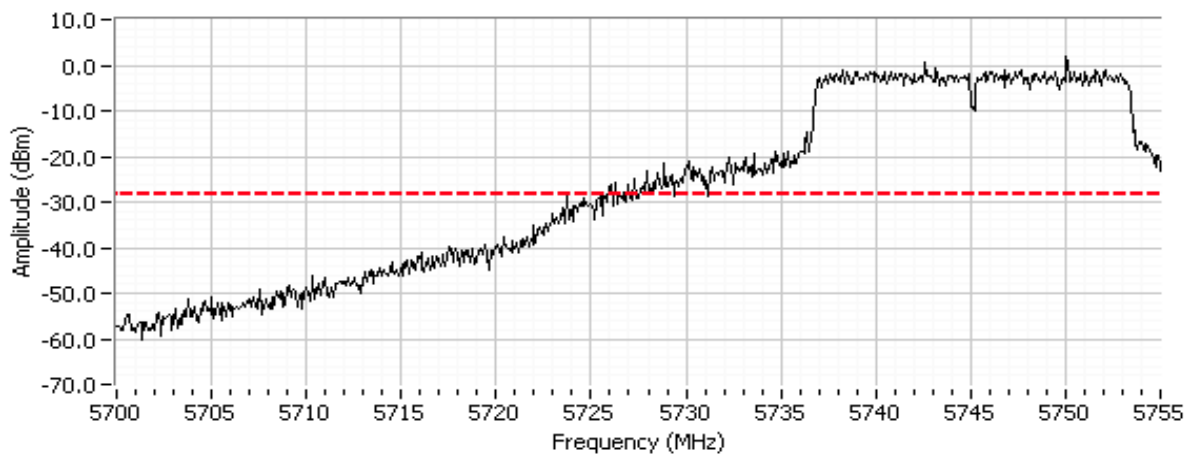

802.11a, Chain B, BE

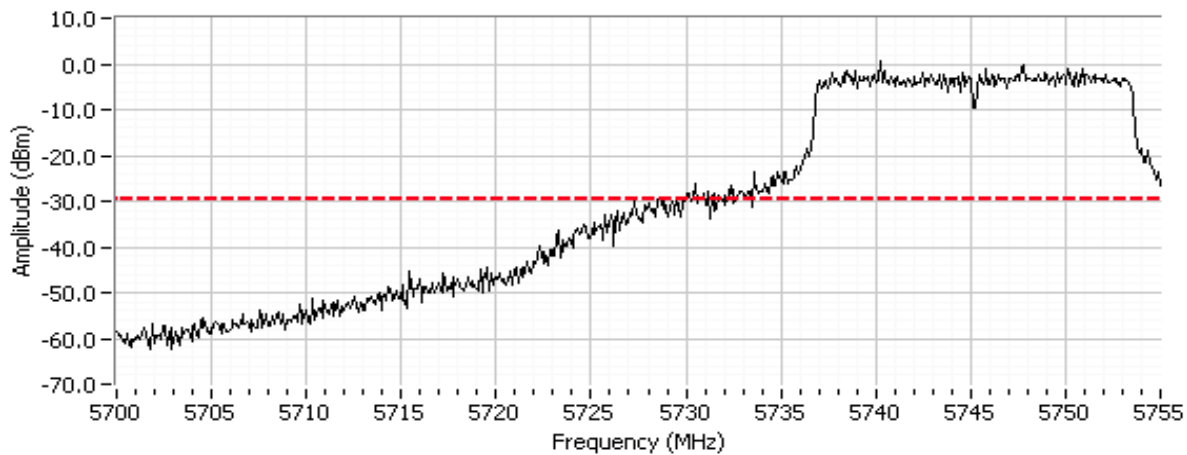

Client:	Intel Corporation	Job Number:	J80050
Model:	62205ANHMW (Intel® Centrino® Advanced-N 6205)	T-Log Number:	T80123
Contact:	Steven Hackett	Account Manager:	Christine Krebil
Standard:	FCC 15.247 / FCC 15 E / RSS 210 / FCC 15 B	Class:	N/A

Plots for center channel, 802.11a mode Chains A and B, power setting(s) = 28/26

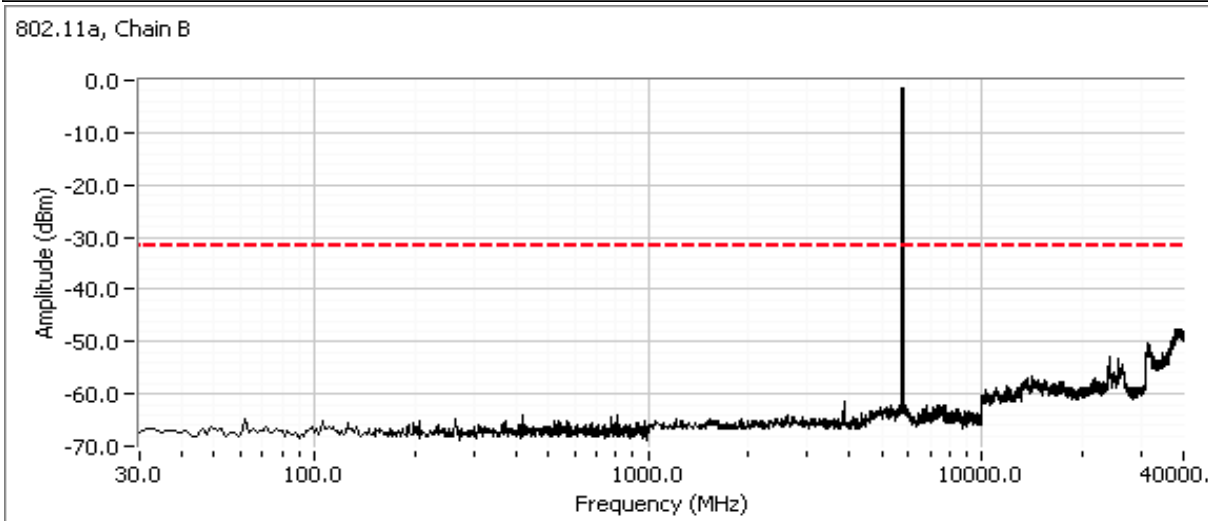
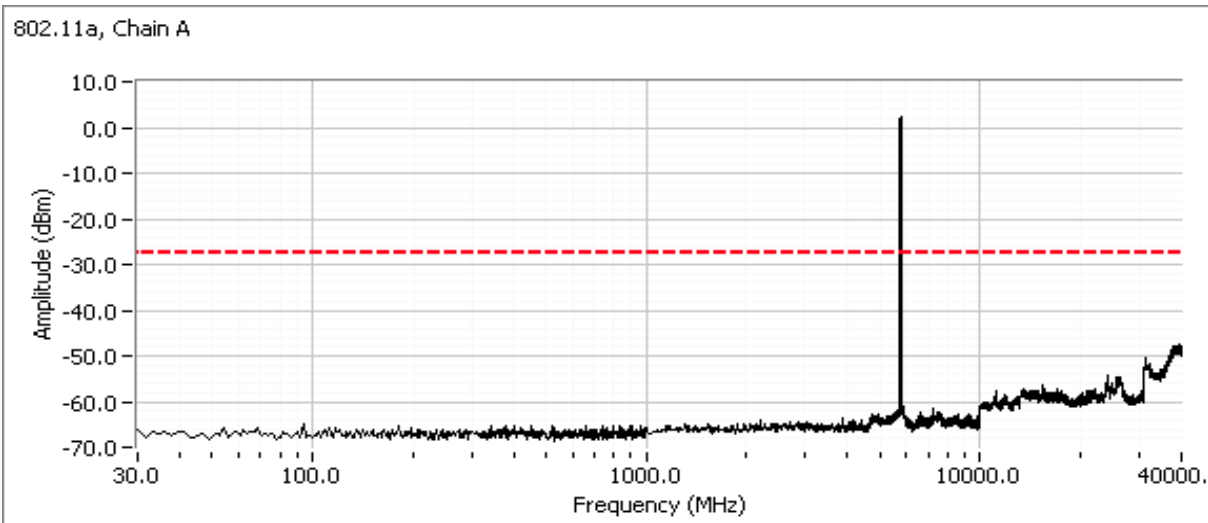

Client:	Intel Corporation	Job Number:	J80050
Model:	62205ANHMW (Intel® Centrino® Advanced-N 6205)	T-Log Number:	T80123
Contact:	Steven Hackett	Account Manager:	Christine Krebil
Standard:	FCC 15.247 / FCC 15 E / RSS 210 / FCC 15 B	Class:	N/A

Plots for high channel, 802.11a mode Chains A and B, power setting(s) = 28/26

802.11a, Chain A

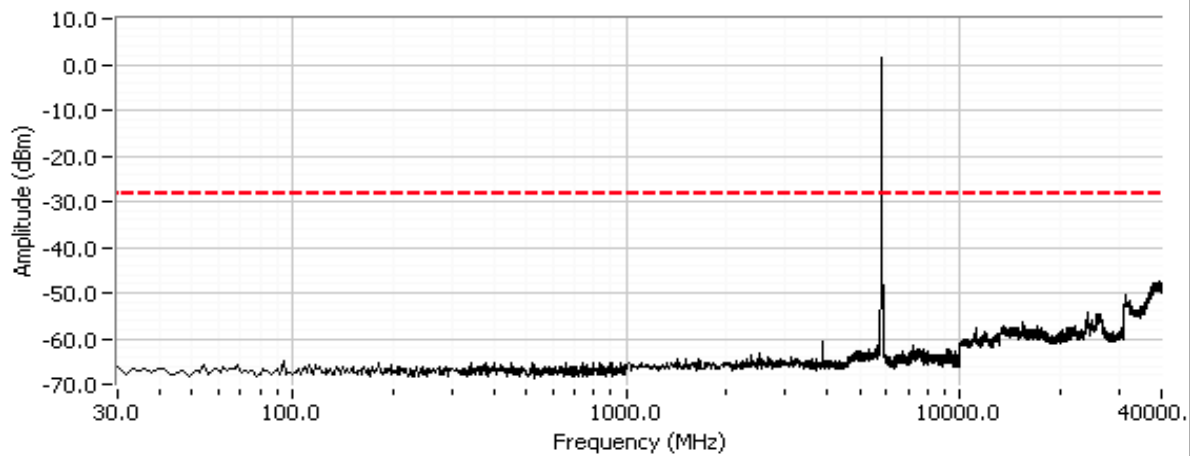

802.11a, Chain B

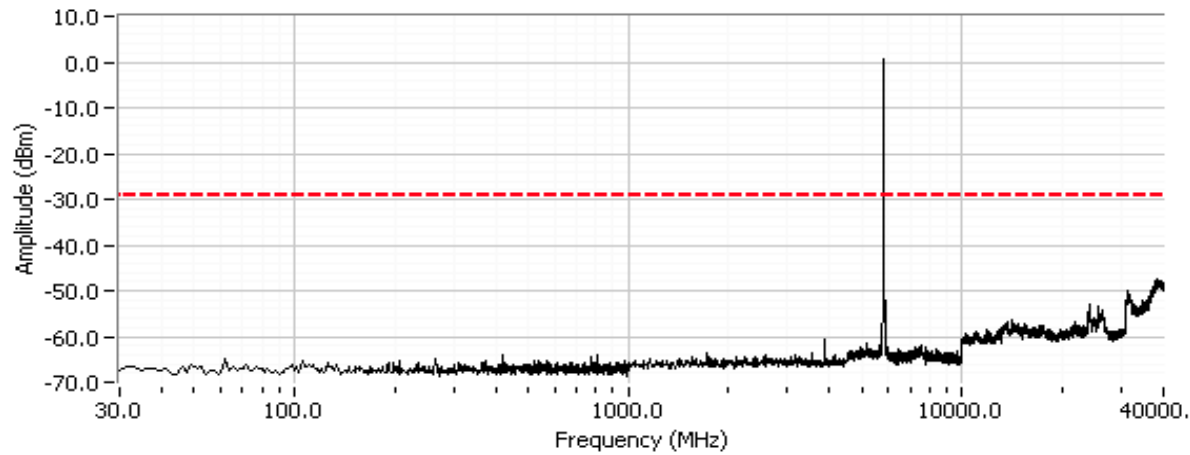

Client:	Intel Corporation	Job Number:	J80050
Model:	62205ANHMW (Intel® Centrino® Advanced-N 6205)	T-Log Number:	T80123
Contact:	Steven Hackett	Account Manager:	Christine Krebil
Standard:	FCC 15.247 / FCC 15 E / RSS 210 / FCC 15 B	Class:	N/A

Additional plots for each chain showing compliance with -30dBc limit at the 5850 MHz band edge.

802.11a, Chain A, BE

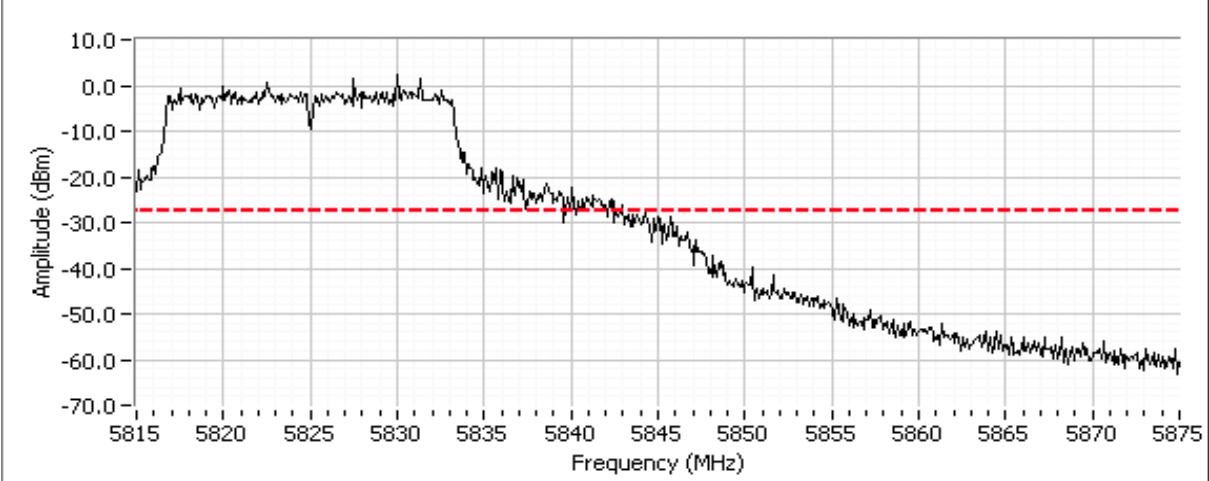

802.11a, Chain B, BE

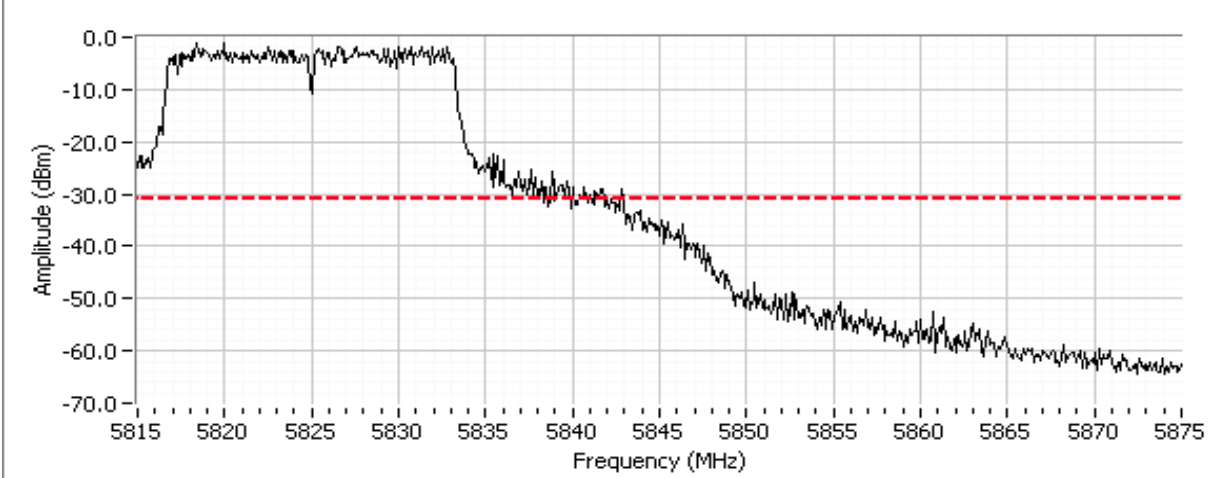

Client:	Intel Corporation	Job Number:	J80050
Model:	62205ANHMW (Intel® Centrino® Advanced-N 6205)	T-Log Number:	T80123
		Account Manager:	Christine Krebil
Contact:	Steven Hackett		
Standard:	FCC 15.247 / FCC 15 E / RSS 210 / FCC 15 B	Class:	N/A

**RSS 210 and FCC 15.247 (DTS) Antenna Port Measurements
Power, PSD, Bandwidth and Spurious Emissions**

Test Specific Details

Objective: The objective of this test session is to perform final qualification testing of the EUT with respect to the specification listed above.

Date of Test: 8/16/2010
Test Engineer: Rafael Varelas
Test Location: FT Lab #3

Config. Used: 1
Config Change: None
Host Unit Voltage 120V/60Hz

General Test Configuration

The EUT was connected to the spectrum analyzer or power meter via a suitable attenuator. All measurements were made on a single chain.

All measurements have been corrected to allow for the external attenuators used.

Ambient Conditions:

Temperature: 23 °C
Rel. Humidity: 46 %

Summary of Results

Run #	Pwr setting	Avg Pwr	Test Performed	Limit	Pass / Fail	Result / Margin
1	-	16.7	802.11n 20MHz Output Power	15.247(b)	Pass	15.6 dBm
1	-	16.5	802.11n 40MHz Output Power	15.247(b)	Pass	20.8 dBm
2	-	16.7	802.11n 20MHz Power spectral	15.247(d)	Pass	-8.5 dBm/3kHz
2	-	16.5	802.11n 40MHz Power spectral	15.247(d)	Pass	-9 dBm/3kHz
3	-	16.6	802.11n 20MHz Minimum 6dB	15.247(a)	Pass	17.5 MHz
3	-	16.7	802.11n 20MHz 99% Bandwidth	RSS GEN	-	18.6 MHz
3	-	16.7	802.11n 40MHz Minimum 6dB	15.247(a)	Pass	35.2 MHz
3	-	17	802.11n 40MHz 99% Bandwidth	RSS GEN	-	39.1 MHz
4	-	-	802.11n 20MHz Spurious emissions	15.247(b)	Pass	All emissions below -30dBc limit
4	-	-	802.11n 40MHz Spurious emissions	15.247(b)	Pass	All emissions below -20dBc limit

Modifications Made During Testing

No modifications were made to the EUT during testing

Client:	Intel Corporation	Job Number:	J80050
Model:	62205ANHMW (Intel® Centrino® Advanced-N 6205)	T-Log Number:	T80123
Contact:	Steven Hackett	Account Manager:	Christine Krebil
Standard:	FCC 15.247 / FCC 15 E / RSS 210 / FCC 15 B	Class:	N/A

Deviations From The Standard

No deviations were made from the requirements of the standard.

Run #1: Output Power - 802.11n20MHz

Power Setting ²	Frequency (MHz)	Output Power		Antenna Gain (dBi)	Result	EIRP ^{Note 2}		Output Power	
		(dBm) ¹	mW			dBm	W	(dBm) ³	mW
802.11n 20MHz Mode, Chain A									
28.5	5745	15.4	34.7	5.0	Pass	20.4	0.110	16.7	46.8
28.5	5785	15.4	34.7	5.0	Pass	20.4	0.110	16.7	46.8
28.5	5825	15.3	33.9	5.0	Pass	20.3	0.107	16.6	45.7
802.11n 20MHz Mode, Chain B									
27	5745	15.6	36.3	5.0	Pass	20.6	0.115	16.7	46.8
27	5785	15.2	33.1	5.0	Pass	20.2	0.105	16.6	45.7
27	5825	15.1	32.4	5.0	Pass	20.1	0.102	16.6	45.7

- Note 1: Output power measured using a spectrum analyzer (see plots below) with RBW=1MHz, VB=3 MHz, sample detector, power averaging on (transmitted signal was continuous) and power integration over 50 MHz (option #2, method 1 in KDB 558074, equivalent to method 1 of DA-02-2138A1 for U-NII devices). Spurious limit becomes -30dBc.
- Note 2: Power setting - the software power setting used during testing, included for reference only.
- Note 3: Power measured using average power meter and is included for reference only.

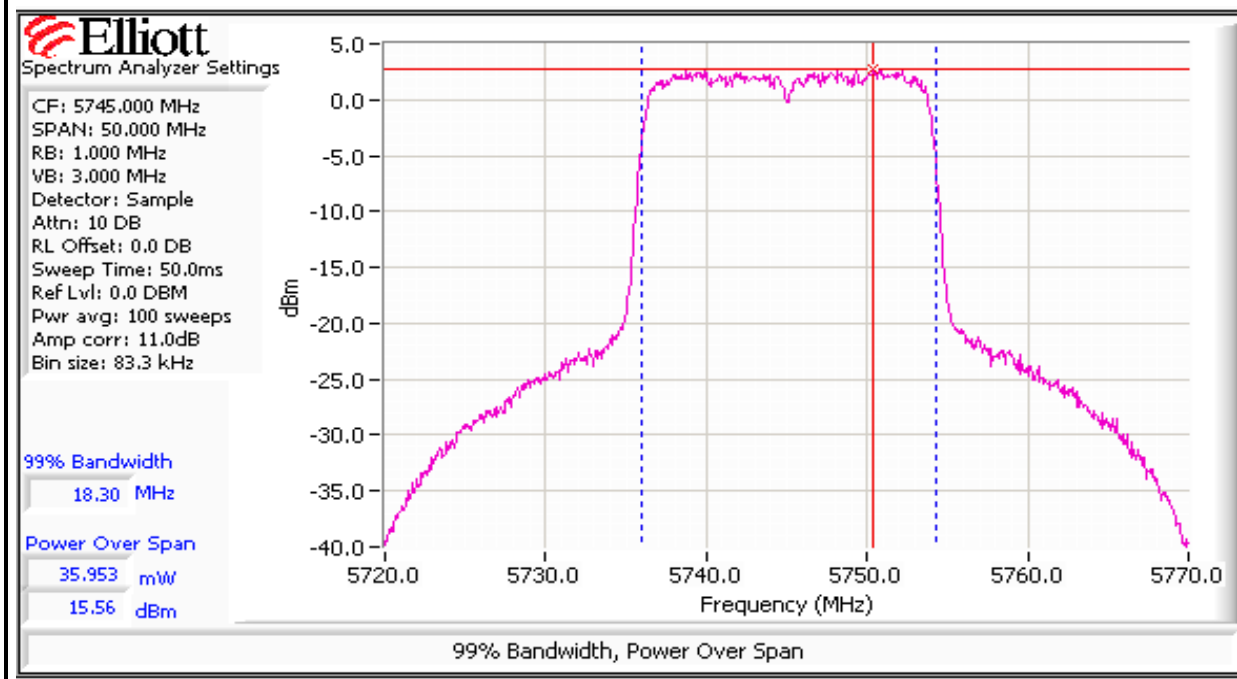

Client:	Intel Corporation	Job Number:	J80050
Model:	62205ANHMW (Intel® Centrino® Advanced-N 6205)	T-Log Number:	T80123
Contact:	Steven Hackett	Account Manager:	Christine Krebil
Standard:	FCC 15.247 / FCC 15 E / RSS 210 / FCC 15 B	Class:	N/A

Run #1: Output Power - 802.11n40MHz

Power Setting ²	Frequency (MHz)	Output Power		Antenna Gain (dBi)	Result	EIRP ^{Note 2}		Output Power	
		(dBm) ¹	mW			dBm	W	(dBm) ³	mW
802.11n 40MHz Mode, Chain A									
29.5	5755	20.2	104.7	5.0	Pass	25.2	0.331	16.7	46.8
29.5	5795	20.1	102.3	5.0	Pass	25.1	0.324	16.6	45.7
802.11n 40MHz Mode, Chain B									
28	5755	20.8	120.2	5.0	Pass	25.8	0.380	16.5	44.7
28	5795	20.7	117.5	5.0	Pass	25.7	0.372	16.6	45.7

- Note 1: Power measured using a peak power meter. Used for SISO n40 mode
- Note 2: Power setting - the software power setting used during testing, included for reference only.
- Note 3: Power measured using average power meter and is included for reference only.

Note : Peak power measurements made for n40MHz mode because this mode does not meet the -30dBc requirement at the 5725MHz band edge when operating on the lowest channel.

Run #2: Power spectral Density

Power Setting	Frequency (MHz)	PSD	Limit	Result
		(dBm/3kHz) ^{Note 1}		
802.11n 20MHz Mode, Chain A				
28.5	5745	-9.0	8.0	Pass
28.5	5785	-8.7	8.0	Pass
28.5	5825	-8.7	8.0	Pass
802.11n 20MHz Mode, Chain B				
27	5745	-8.5	8.0	Pass
27	5785	-9.5	8.0	Pass
27	5825	-9.0	8.0	Pass
802.11n 40MHz Mode, Chain A				
29.5	5755	-12.5	8.0	Pass
29.5	5795	-13.0	8.0	Pass
802.11n 40MHz Mode, Chain B				
28	5755	-9.0	8.0	Pass
28	5795	-11.0	8.0	Pass

Note 1: Power spectral density measured using RB=3 kHz, VB=10kHz, analyzer with peak detector and with a sweep time set to ensure a dwell time of at least 1 second per 3kHz. The measurement is made at the frequency of PPSD determined from preliminary scans using RB=3kHz using multiple sweeps at a faster rate over the 6dB bandwidth of the signal.

Client:	Intel Corporation	Job Number:	J80050
Model:	62205ANHMW (Intel® Centrino® Advanced-N 6205)	T-Log Number:	T80123
Contact:	Steven Hackett	Account Manager:	Christine Krebil
Standard:	FCC 15.247 / FCC 15 E / RSS 210 / FCC 15 B	Class:	N/A

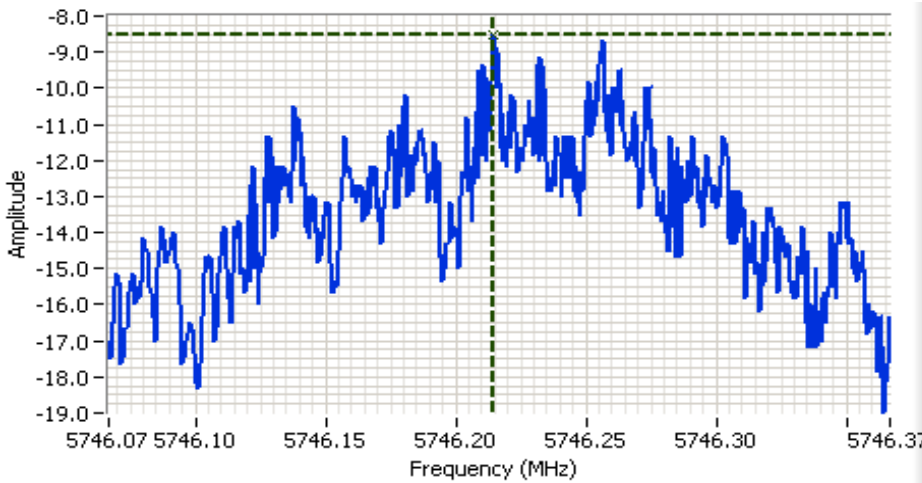

Analyzer Settings
 HP8564E,EMICF: 5746.217 MHz
 SPAN: 300 kHz
 RB: 3.00 kHz
 VB: 10.0 kHz
 Detector: POS
 Attn: 10 DB
 RL Offset: 11.0 DB
 Sweep Time: 100.0s
 Ref Lvl: 11.0 DBM

Comments
 PSD @ 5745 MHz
 Chain B

Cursor 1 5746.2147 -8.50 

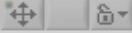
0.0000 0.00 

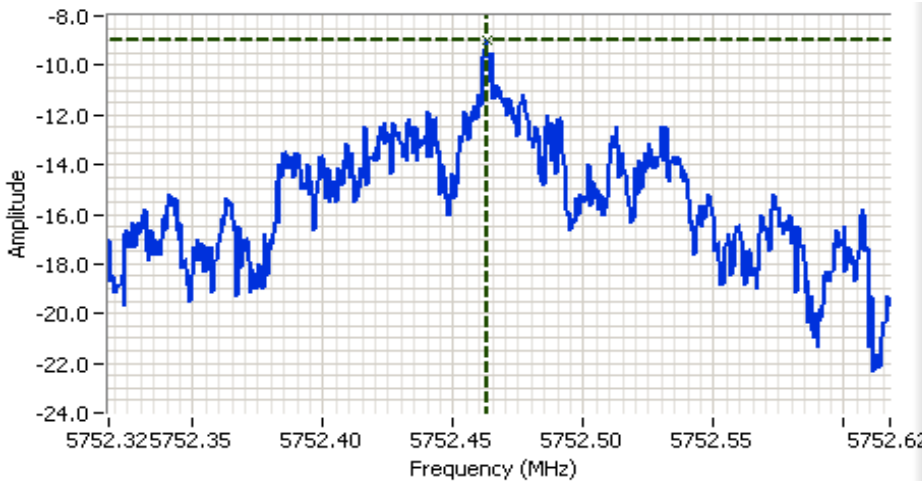

Analyzer Settings
 HP8564E,EMICF: 5752.468 MHz
 SPAN: 300 kHz
 RB: 3.00 kHz
 VB: 10.0 kHz
 Detector: POS
 Attn: 10 DB
 RL Offset: 11.0 DB
 Sweep Time: 100.0s
 Ref Lvl: 11.0 DBM

Comments
 PSD @ 5755 MHz
 Chain B

Cursor 1 5752.4627 -9.00 

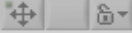
0.0000 0.00 



Client:	Intel Corporation	Job Number:	J80050
Model:	62205ANHMW (Intel® Centrino® Advanced-N 6205)	T-Log Number:	T80123
		Account Manager:	Christine Krebil
Contact:	Steven Hackett		
Standard:	FCC 15.247 / FCC 15 E / RSS 210 / FCC 15 B	Class:	N/A

Run #3: Signal Bandwidth

Power Setting	Frequency (MHz)	Resolution Bandwidth	Bandwidth (MHz)	
			6dB	99%
802.11n 20MHz Mode				
28.5	5785, Chain A	100kHz	17.6	18.6
27	5785, Chain B	100kHz	17.6	18.3
28.5	5745, Chain A	100kHz	17.6	18.6
28.5	5825, Chain A	100kHz	17.5	18.5
802.11n 40MHz Mode				
28	5755, Chain A	100kHz	35.2	39.1
28	5755, Chain B	100kHz	35.2	37.1
28	5795, Chain B	100kHz	35.2	37.1

Note 1:	99% bandwidth measured in accordance with RSS GEN, with RB > 1% of the span and VB > 3xRB (taken from power measurement plots)
Note 2:	6dB bandwidth measured on the center channel for each chain and then on the top and bottom channels for the chain with the narrowest 6dB bandwidth.

Client:	Intel Corporation	Job Number:	J80050
Model:	62205ANHMW (Intel® Centrino® Advanced-N 6205)	T-Log Number:	T80123
Contact:	Steven Hackett	Account Manager:	Christine Krebil
Standard:	FCC 15.247 / FCC 15 E / RSS 210 / FCC 15 B	Class:	N/A

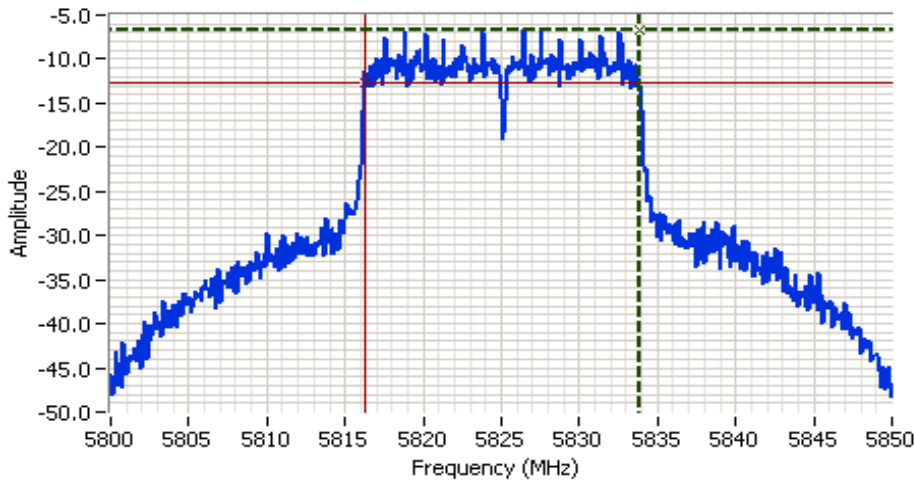

Analyzer Settings
 HP8564E,EMICF: 5825.000 MHz
 SPAN: 50.000 MHz
 RB: 100 kHz
 VB: 100 kHz
 Detector: Normal
 Attn: 10 DB
 RL Offset: 0.0 DB
 Sweep Time: 50.0ms
 Ref Lvl: 0.0 DBM

Comments
 6dB BW: 17.500 MHz
 Chain A

Cursor 1 5833.8333 -6.67
 Cursor 2 5816.3333 -12.67

Delta Freq. 17.500
 Delta Amplitude 6.00

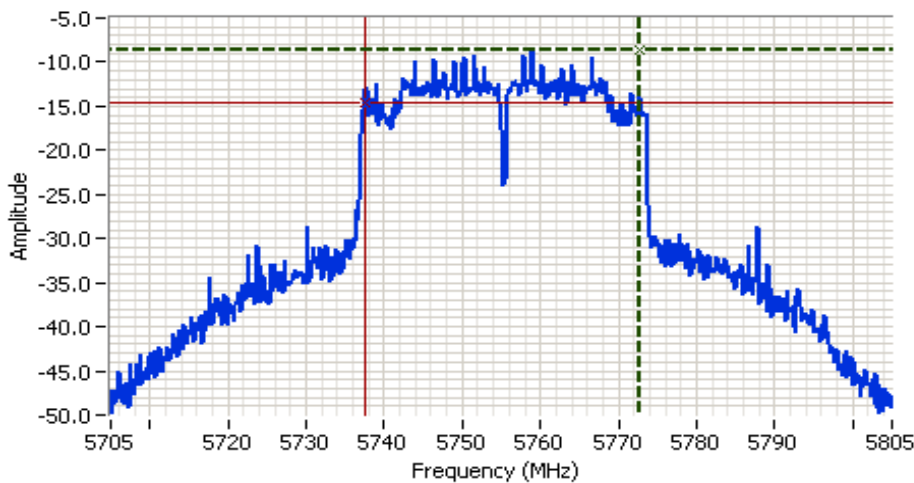

Analyzer Settings
 HP8564E,EMICF: 5755.000 MHz
 SPAN: 100.000 MHz
 RB: 100 kHz
 VB: 100 kHz
 Detector: Normal
 Attn: 10 DB
 RL Offset: 0.0 DB
 Sweep Time: 55.0ms
 Ref Lvl: 0.0 DBM

Comments
 6dB BW: 35.167 MHz
 Chain A

Cursor 1 5772.8333 -8.67
 Cursor 2 5737.6667 -14.67

Delta Freq. 35.167
 Delta Amplitude 6.00



Client:	Intel Corporation	Job Number:	J80050
Model:	62205ANHMW (Intel® Centrino® Advanced-N 6205)	T-Log Number:	T80123
Contact:	Steven Hackett	Account Manager:	Christine Krebil
Standard:	FCC 15.247 / FCC 15 E / RSS 210 / FCC 15 B	Class:	N/A

Run #4: Out of Band Spurious Emissions

Mode	Chain	Frequency (MHz)	Limit	Result
802.11n 20MHz	A	5745	-30dBc	Pass
		5785	-30dBc	Pass
		5825	-30dBc	Pass
	B	5745	-30dBc	Pass
		5785	-30dBc	Pass
		5825	-30dBc	Pass
802.11n 40MHz	A	5755	-20dBc	Pass
		5795	-20dBc	Pass
	B	5755	-20dBc	Pass
		5795	-20dBc	Pass

Note : -20dBc limit used for n40MHz mode because this mode does not meet the -30dBc requirement at the 5725MHz band edge when operating on the lowest channel. Power measurements made for n40MHz mode were made using a peak power meter.

Plots for low channel, 802.11n 20MHz mode Chains A and B, power setting(s) = 28.5/27

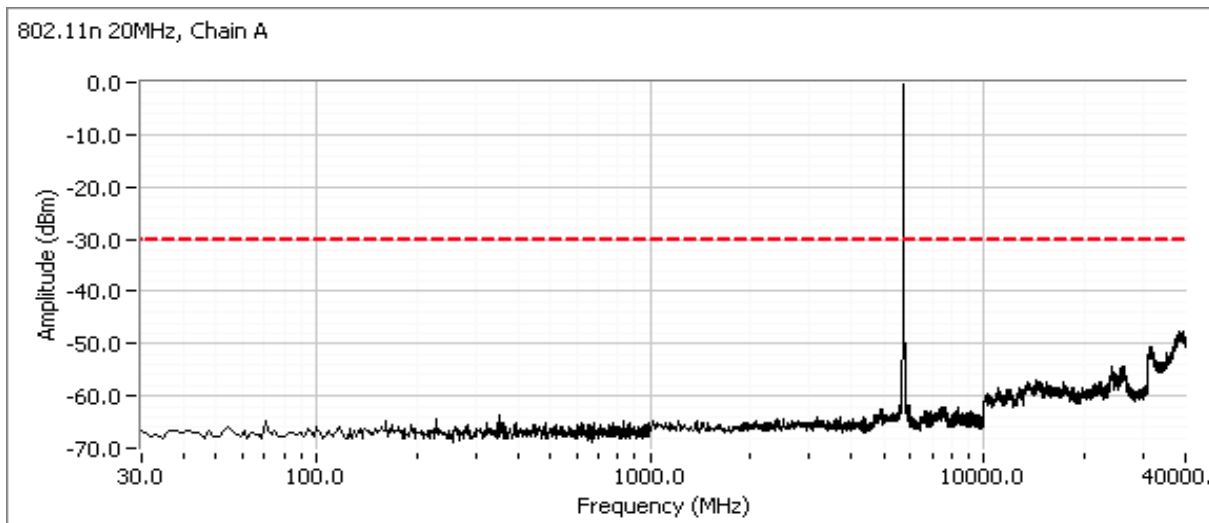

Client:	Intel Corporation	Job Number:	J80050
Model:	62205ANHMW (Intel® Centrino® Advanced-N 6205)	T-Log Number:	T80123
Contact:	Steven Hackett	Account Manager:	Christine Krebil
Standard:	FCC 15.247 / FCC 15 E / RSS 210 / FCC 15 B	Class:	N/A

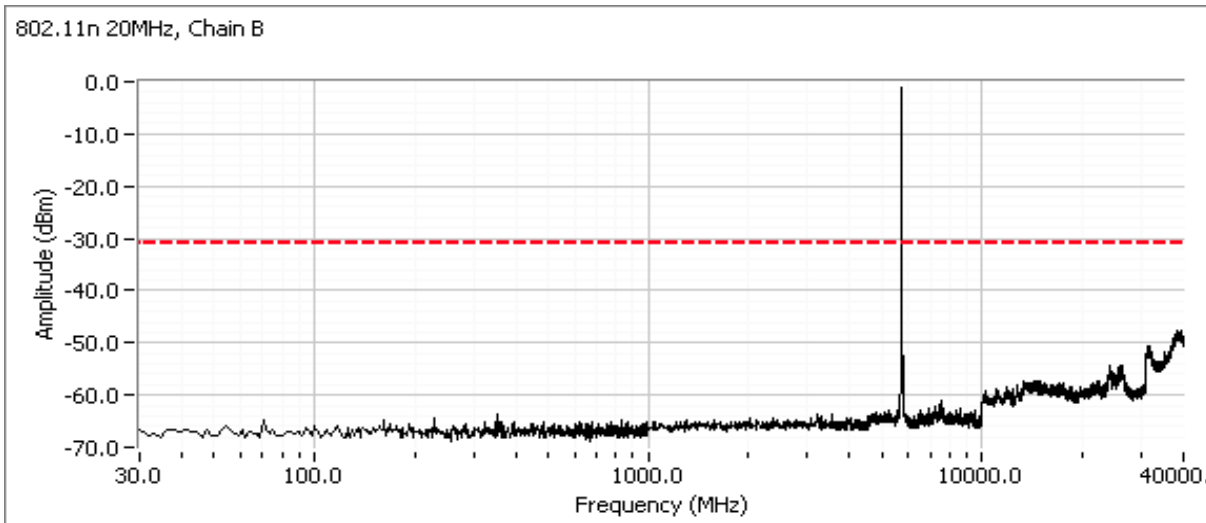

Additional plots for each chain showing compliance with -30dBc limit at the 5725MHz band edge.

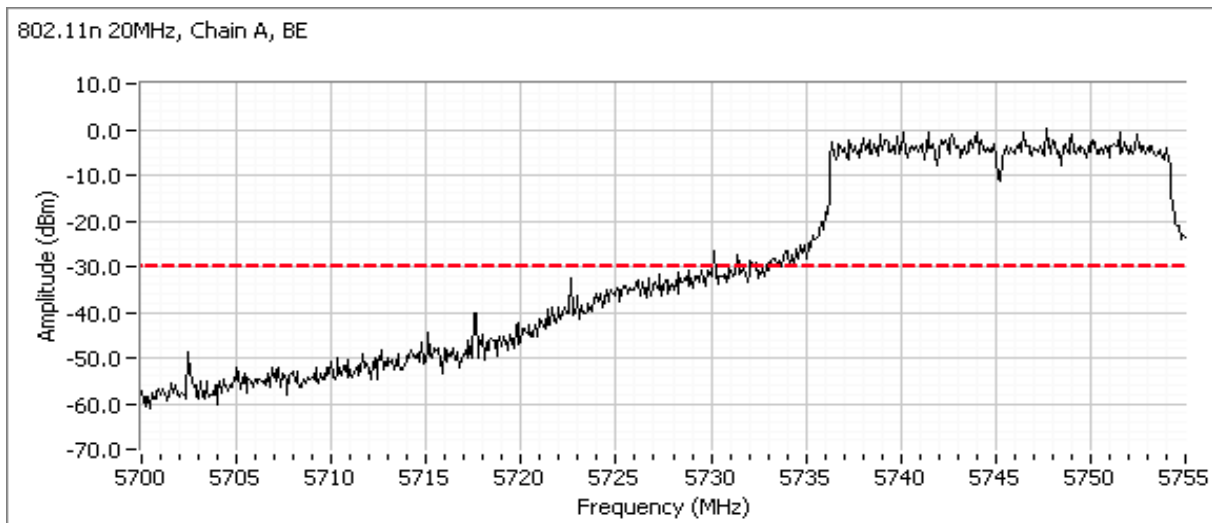

Client:	Intel Corporation	Job Number:	J80050
Model:	62205ANHMW (Intel® Centrino® Advanced-N 6205)	T-Log Number:	T80123
Contact:	Steven Hackett	Account Manager:	Christine Krebil
Standard:	FCC 15.247 / FCC 15 E / RSS 210 / FCC 15 B	Class:	N/A

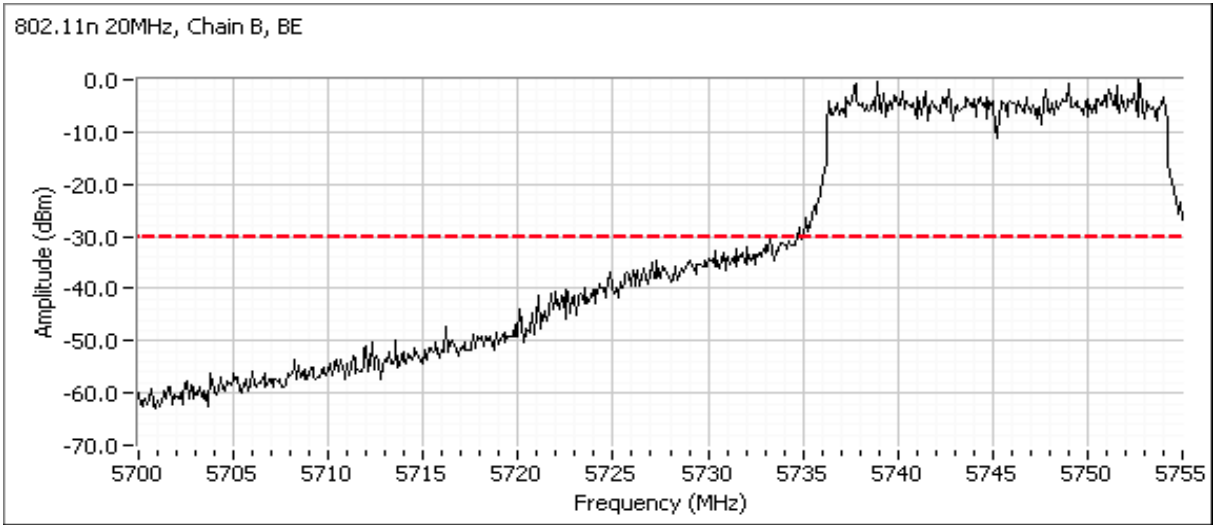

Plots for center channel, 802.11n 20MHz mode Chains A and B, power setting(s) = 28.5/27

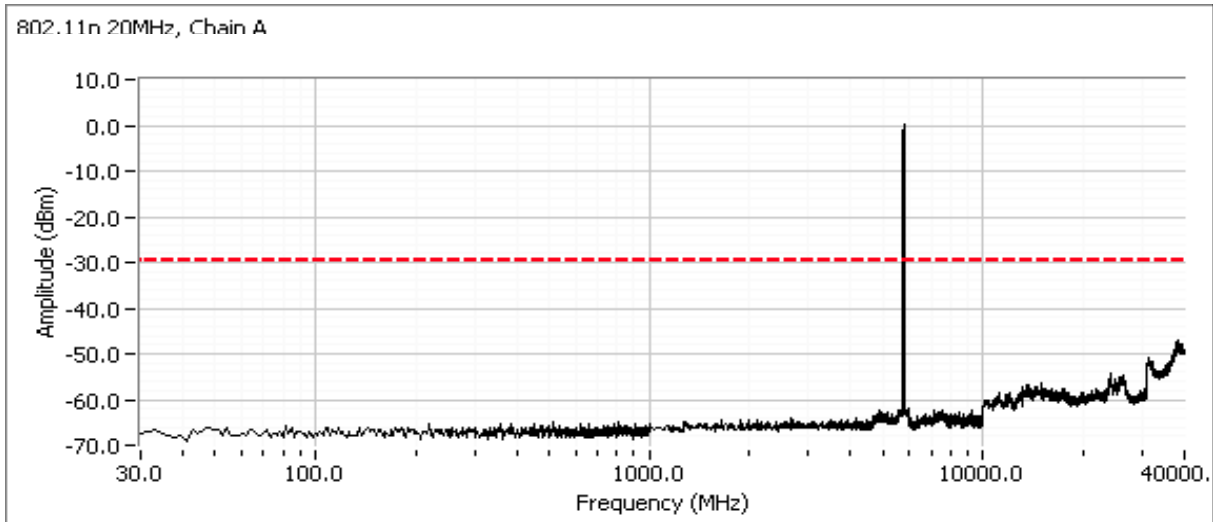

Client:	Intel Corporation	Job Number:	J80050
Model:	62205ANHMW (Intel® Centrino® Advanced-N 6205)	T-Log Number:	T80123
Contact:	Steven Hackett	Account Manager:	Christine Krebil
Standard:	FCC 15.247 / FCC 15 E / RSS 210 / FCC 15 B	Class:	N/A

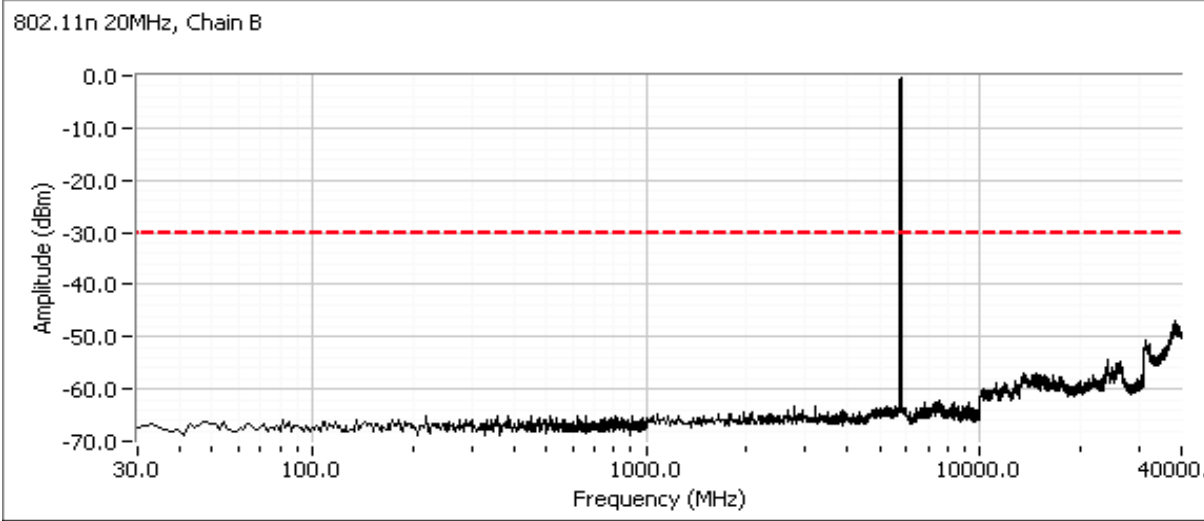

Plots for high channel, 802.11n 20MHz mode Chains A and B, power setting(s) = 28.5/27

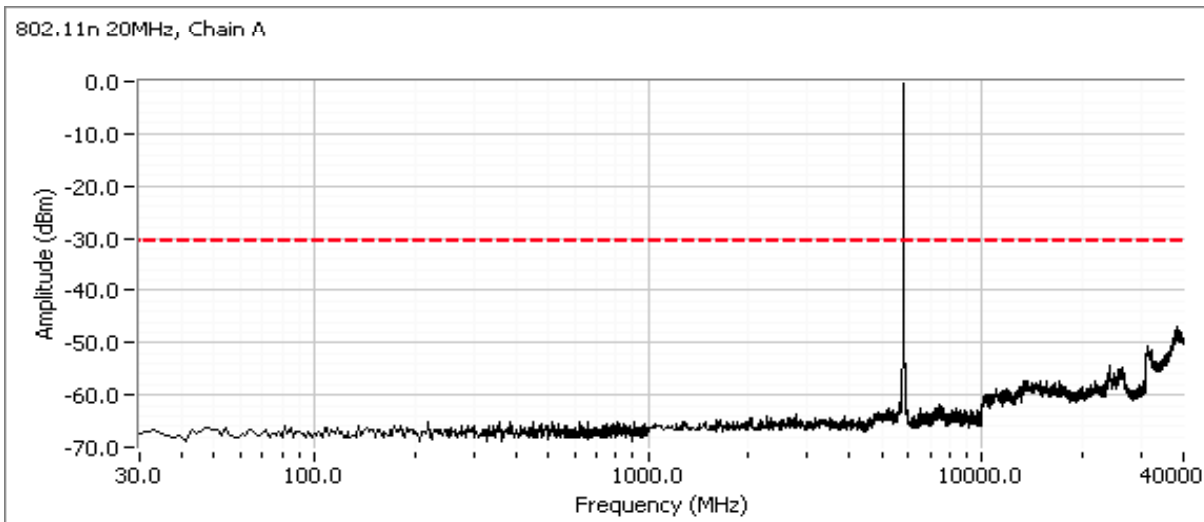

Client:	Intel Corporation	Job Number:	J80050
Model:	62205ANHMW (Intel® Centrino® Advanced-N 6205)	T-Log Number:	T80123
Contact:	Steven Hackett	Account Manager:	Christine Krebil
Standard:	FCC 15.247 / FCC 15 E / RSS 210 / FCC 15 B	Class:	N/A

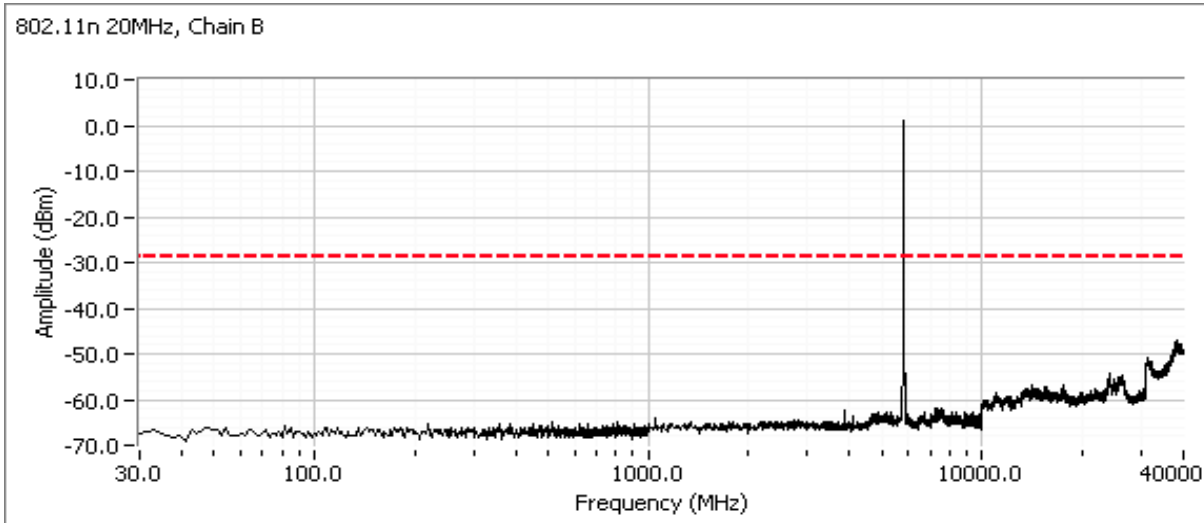

Additional plots for each chain showing compliance with -30dBc limit at the 5850 MHz band edge.

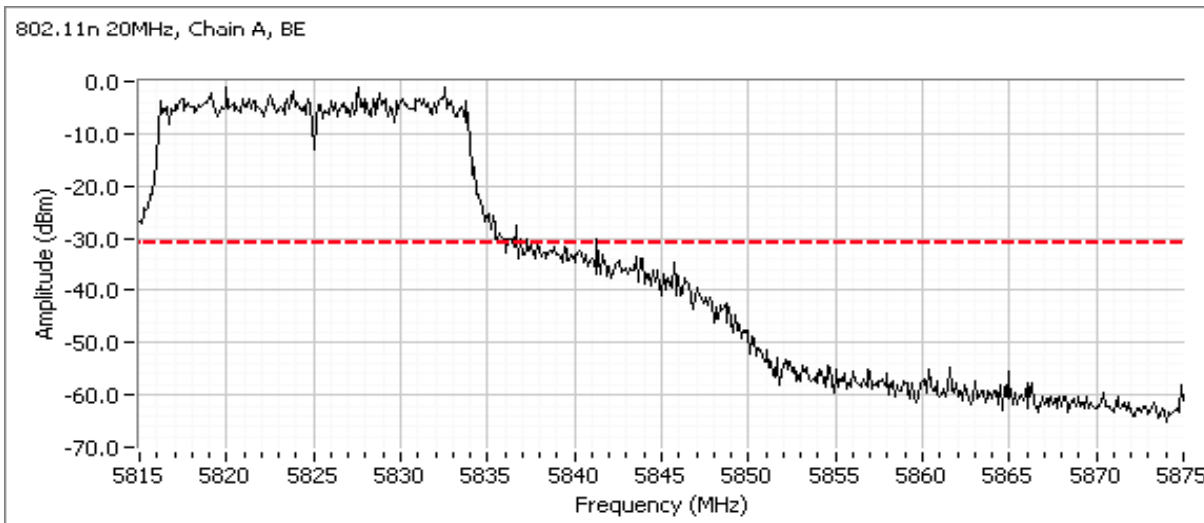

Client:	Intel Corporation	Job Number:	J80050
Model:	62205ANHMW (Intel® Centrino® Advanced-N 6205)	T-Log Number:	T80123
Contact:	Steven Hackett	Account Manager:	Christine Krebil
Standard:	FCC 15.247 / FCC 15 E / RSS 210 / FCC 15 B	Class:	N/A

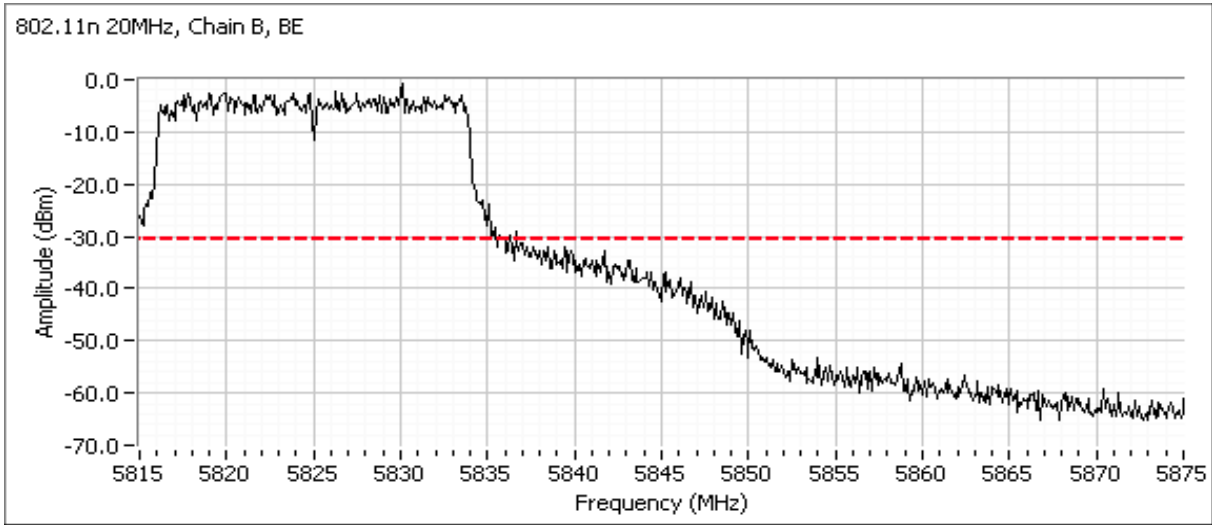

Client:	Intel Corporation	Job Number:	J80050
Model:	62205ANHMW (Intel® Centrino® Advanced-N 6205)	T-Log Number:	T80123
Contact:	Steven Hackett	Account Manager:	Christine Krebil
Standard:	FCC 15.247 / FCC 15 E / RSS 210 / FCC 15 B	Class:	N/A

Plots for low channel, 802.11n 40MHz mode Chains A and B, power setting(s) = 29.5/28

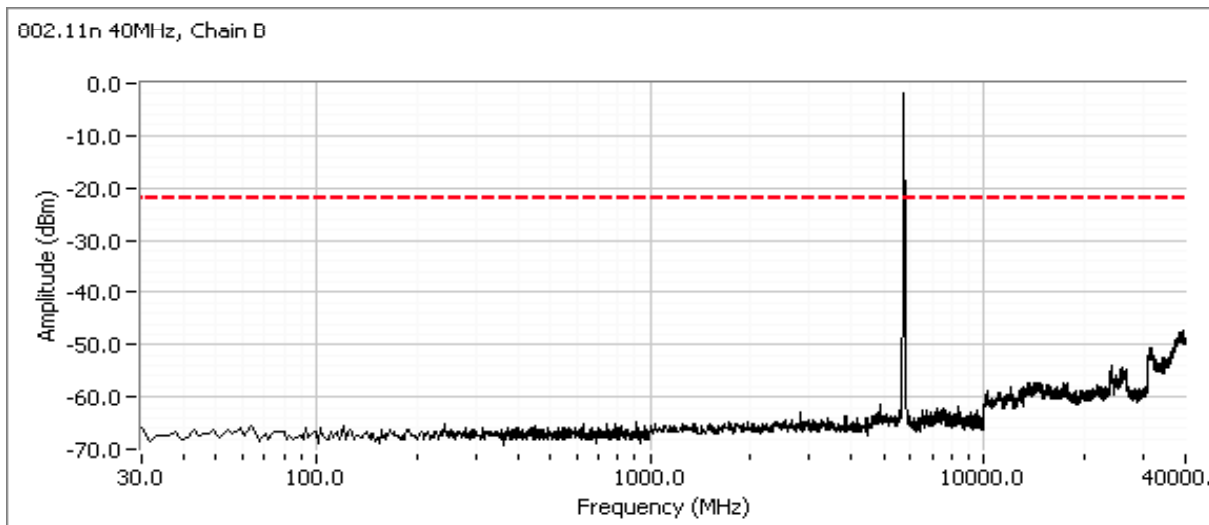
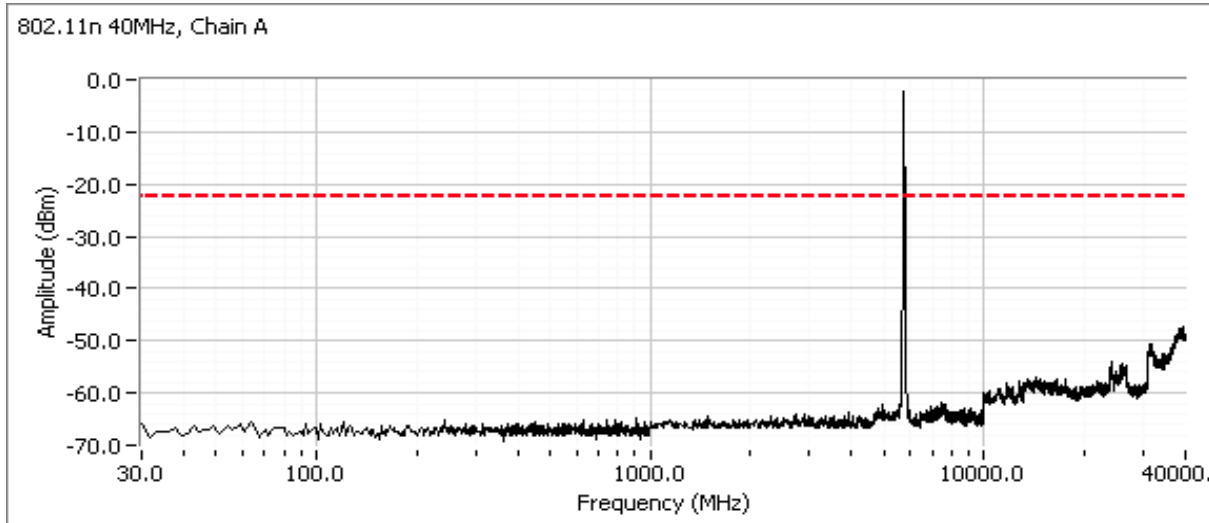

Client:	Intel Corporation	Job Number:	J80050
Model:	62205ANHMW (Intel® Centrino® Advanced-N 6205)	T-Log Number:	T80123
Contact:	Steven Hackett	Account Manager:	Christine Krebil
Standard:	FCC 15.247 / FCC 15 E / RSS 210 / FCC 15 B	Class:	N/A

Additional plots for each chain showing compliance with -20dBc limit at the 5725MHz band edge.

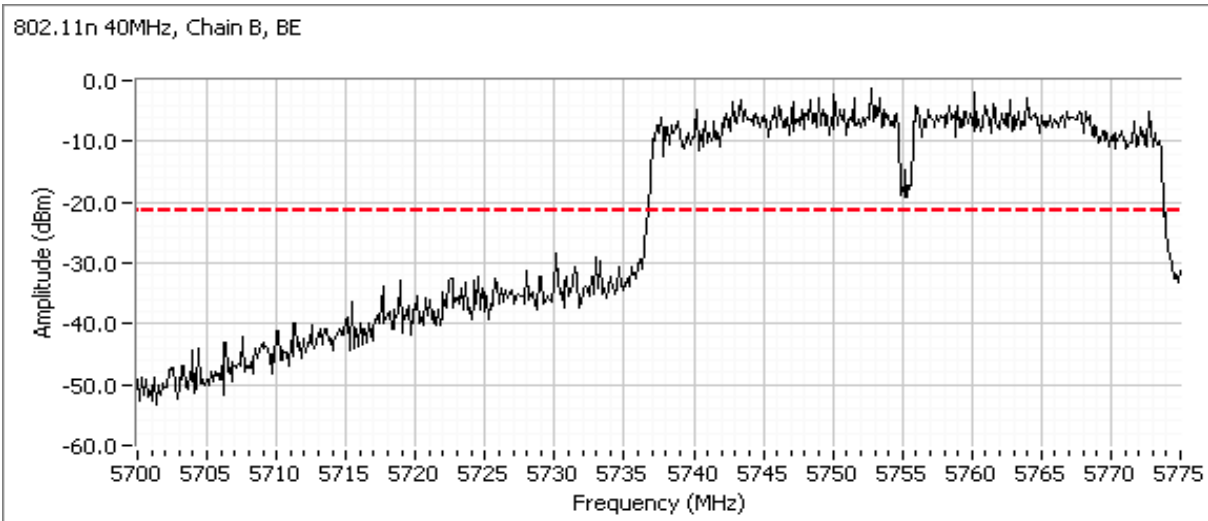
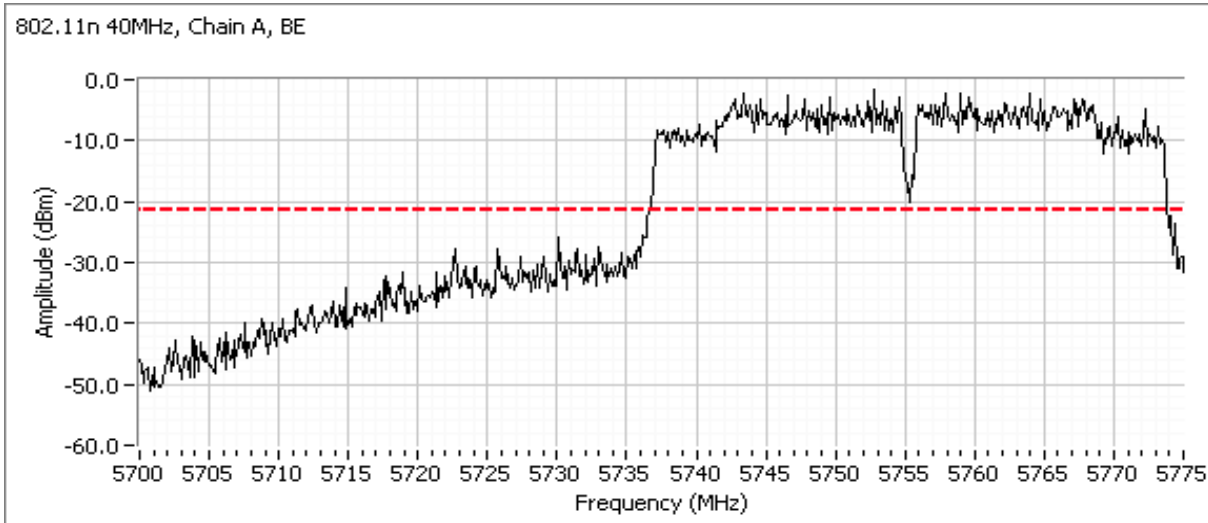

Client:	Intel Corporation	Job Number:	J80050
Model:	62205ANHMW (Intel® Centrino® Advanced-N 6205)	T-Log Number:	T80123
Contact:	Steven Hackett	Account Manager:	Christine Krebil
Standard:	FCC 15.247 / FCC 15 E / RSS 210 / FCC 15 B	Class:	N/A

Plots for high channel, 802.11n 40MHz mode Chains A and B, power setting(s) = 29.5/28

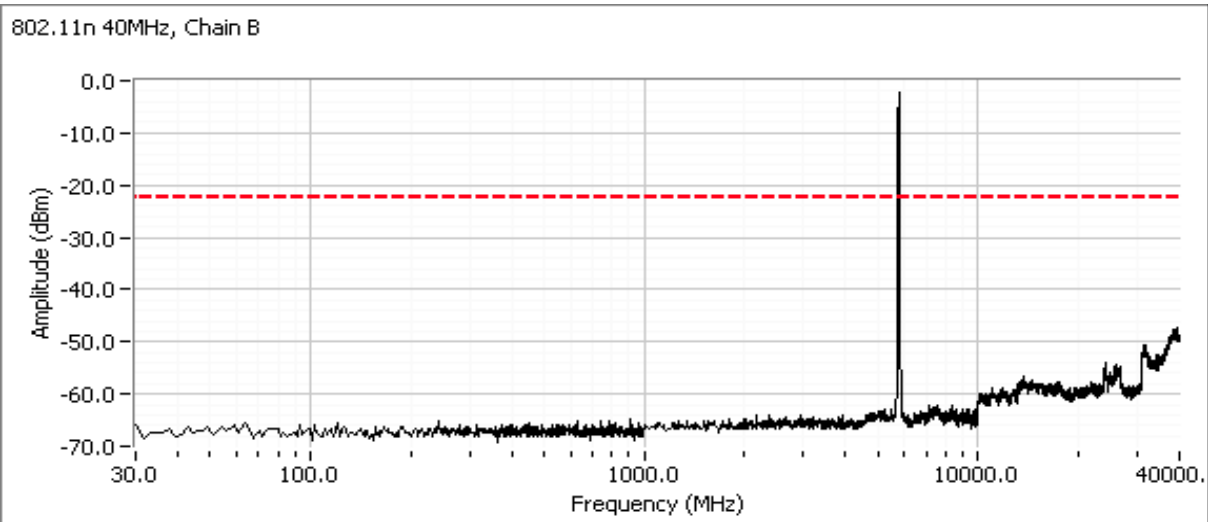
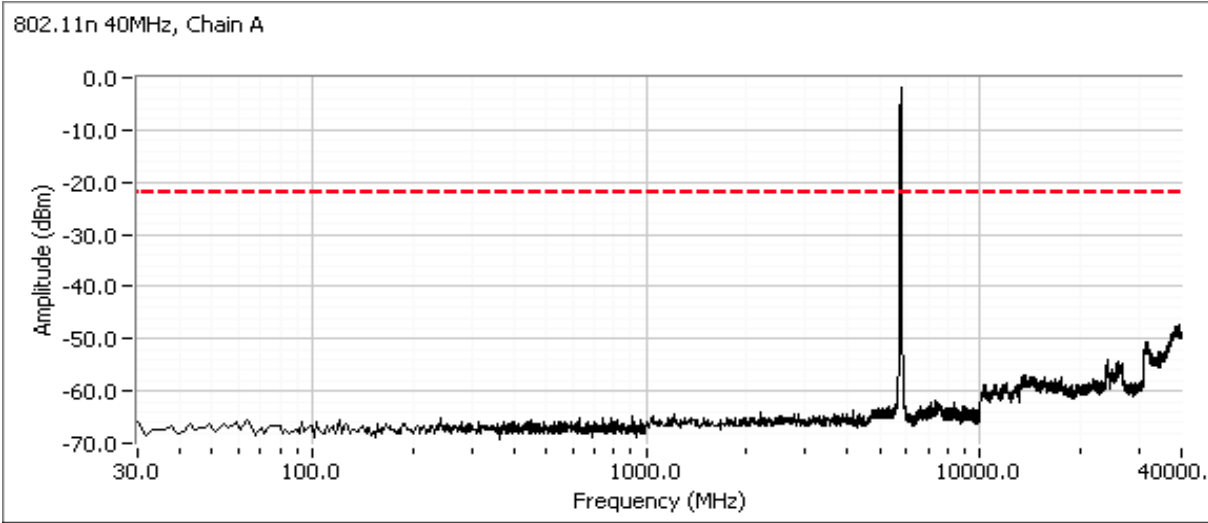

Client:	Intel Corporation	Job Number:	J80050
Model:	62205ANHMW (Intel® Centrino® Advanced-N 6205)	T-Log Number:	T80123
Contact:	Steven Hackett	Account Manager:	Christine Krebil
Standard:	FCC 15.247 / FCC 15 E / RSS 210 / FCC 15 B	Class:	N/A

Additional plots for each chain showing compliance with -20dBc limit at the 5850 MHz band edge.

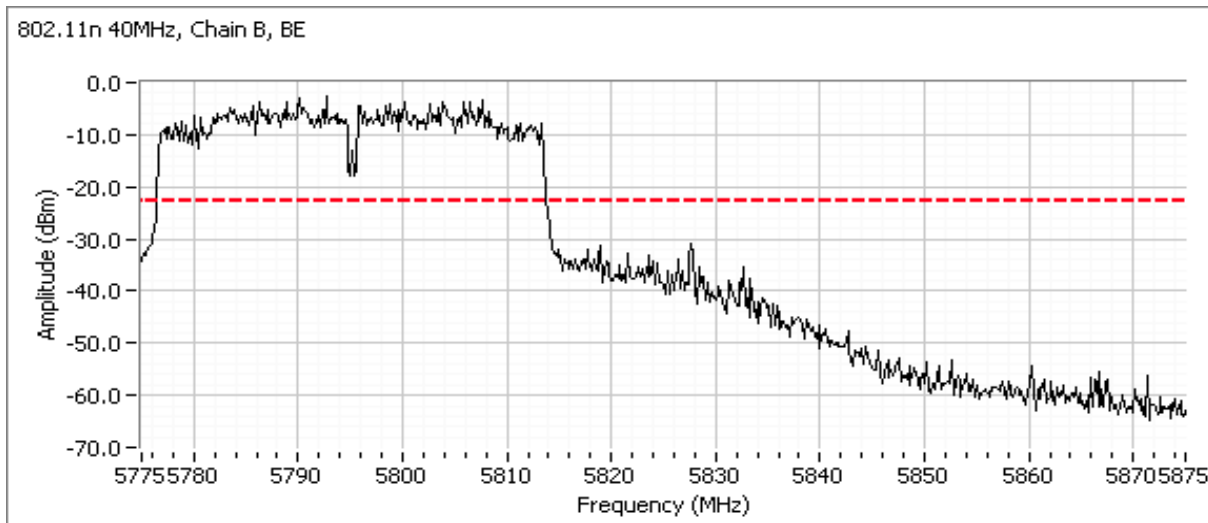
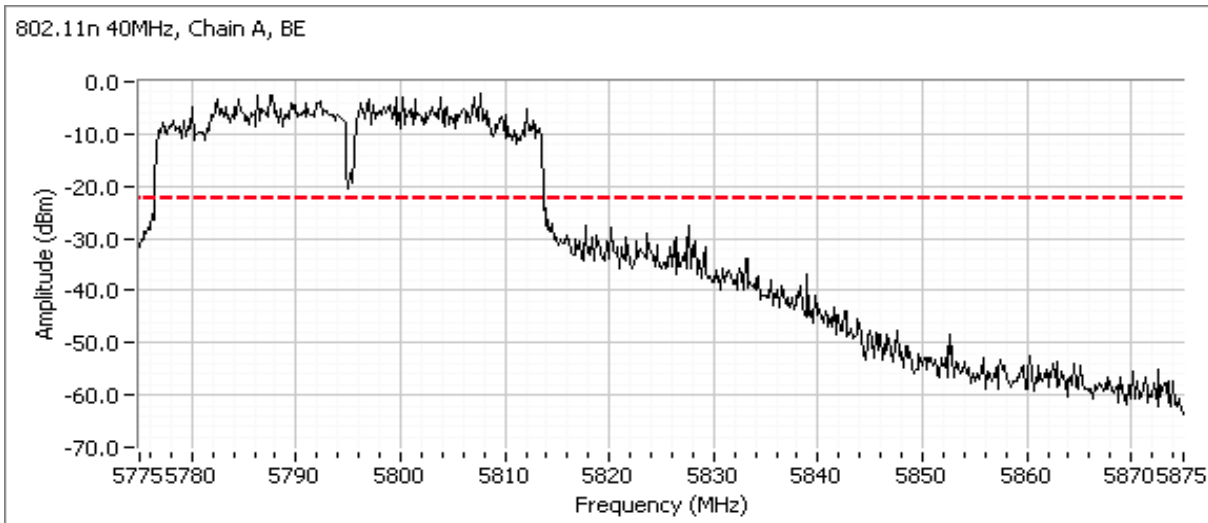

Client:	Intel Corporation	Job Number:	J80050
Model:	62205ANHMW (Intel® Centrino® Advanced-N 6205)	T-Log Number:	T80123
Contact:	Steven Hackett	Account Manager:	Christine Krebil
Standard:	FCC 15.247 / FCC 15 E / RSS 210 / FCC 15 B	Class:	N/A

**RSS 210 and FCC 15.247 (DTS) Antenna Port Measurements
MIMO and Smart Antenna Systems (2400-2483.5MHz)
Power, PSD - 802.11n MIMO Modes**

Test Specific Details

Objective: The objective of this test session is to perform final qualification testing of the EUT with respect to the specification listed above.

Date of Test: 8/16/2010
Test Engineer: Rafael Varelas
Test Location: FT Lab #3

Config. Used: 1
Config Change: None
Host Unit Voltage 120V/60Hz

General Test Configuration

The EUT was connected to the spectrum analyzer or power meter via a suitable attenuator. All measurements were made on each chain individually.

All measurements have been corrected to allow for the external attenuators used.

Ambient Conditions:

Temperature: 23 °C
Rel. Humidity: 46 %

Summary of Results

Run #	Pwr setting	Avg Pwr	Test Performed	Limit	Pass / Fail	Result / Margin
802.11n 20MHz						
1	-	16.7	Output Power	15.247(b)	Pass	15.5 dBm (NII avg)
1	-	16.7	Power spectral Density (PSD)	15.247(d)	Pass	-8.1 dBm/3kHz
802.11n 40MHz						
1	-	16.7	Output Power	15.247(b)	Pass	21.3 dBm (peak)
1	-	16.6	Power spectral Density (PSD)	15.247(d)	Pass	-9.5 dBm/3kHz
-	-	-	Minimum 6dB Bandwidth n20	15.247(a)		Covered by SISO measurements on each chain
-	-	-	99% Bandwidth n20	RSS GEN		
-	-	-	Spurious emissions n20 and n40	15.247(b)		

Modifications Made During Testing

No modifications were made to the EUT during testing

Deviations From The Standard

No deviations were made from the requirements of the standard.

Client:	Intel Corporation	Job Number:	J80050
Model:	62205ANHMW (Intel® Centrino® Advanced-N 6205)	T-Log Number:	T80123
Contact:	Steven Hackett	Account Manager:	Christine Krebil
Standard:	FCC 15.247 / FCC 15 E / RSS 210 / FCC 15 B	Class:	N/A

Run #1: Output Power
 Operating Mode: 802.11n, 20MHz
 Transmitted signal on chain is coherent ? No

5745 MHz	Chain A	Chain B	Chain 3	Chain 4	Total Across All Chains		Limit	
Power Setting ^{Note 3}	27.5	27.5			Total Across All Chains			
Average Power ^{Note 4}	13.6	13.7						
Output Power (dBm) ^{Note 1}	12.4	12.4			15.4 dBm	0.035 W	30.0 dBm	1.000 W
Antenna Gain (dBi) ^{Note 2}	5.0	5.0				5.0 dBi	Pass	
eirp (dBm) ^{Note 2}	17.4	17.4			20.4 dBm	0.110 W	Pass	

5785 MHz	Chain A	Chain B	Chain 3	Chain 4	Total Across All Chains		Limit	
Power Setting ^{Note 3}	28.0	27.5			Total Across All Chains			
Average Power ^{Note 4}	13.7	13.7						
Output Power (dBm) ^{Note 1}	12.7	12.2			15.5 dBm	0.035 W	30.0 dBm	1.000 W
Antenna Gain (dBi) ^{Note 2}	5.0	5.0				5.0 dBi	Pass	
eirp (dBm) ^{Note 2}	17.7	17.2			20.5 dBm	0.111 W	Pass	

5825 MHz	Chain A	Chain B	Chain 3	Chain 4	Total Across All Chains		Limit	
Power Setting ^{Note 3}	28.0	27.5			Total Across All Chains			
Average Power ^{Note 4}	13.6	13.7						
Output Power (dBm) ^{Note 1}	12.2	12			15.1 dBm	0.032 W	30.0 dBm	1.000 W
Antenna Gain (dBi) ^{Note 2}	5.0	5.0				5.0 dBi	Pass	
eirp (dBm) ^{Note 2}	17.2	17			20.1 dBm	0.103 W	Pass	

- Note 1: Output power measured using a spectrum analyzer (see plots below) with RBW=1MHz, VB=3 MHz, sample detector, power averaging on (transmitted signal was continuous) and power integration over 50 MHz (option #2, method 1 in KDB 558074, equivalent to method 1 of DA-02-2138A1 for U-NII devices). Spurious limit becomes -30dBc.
- Note 2: Power setting - the software power setting used during testing, included for reference only.
- Note 3: Power measured using average power meter and is included for reference only.

Client:	Intel Corporation	Job Number:	J80050
Model:	62205ANHMW (Intel® Centrino® Advanced-N 6205)	T-Log Number:	T80123
Contact:	Steven Hackett	Account Manager:	Christine Krebil
Standard:	FCC 15.247 / FCC 15 E / RSS 210 / FCC 15 B	Class:	N/A

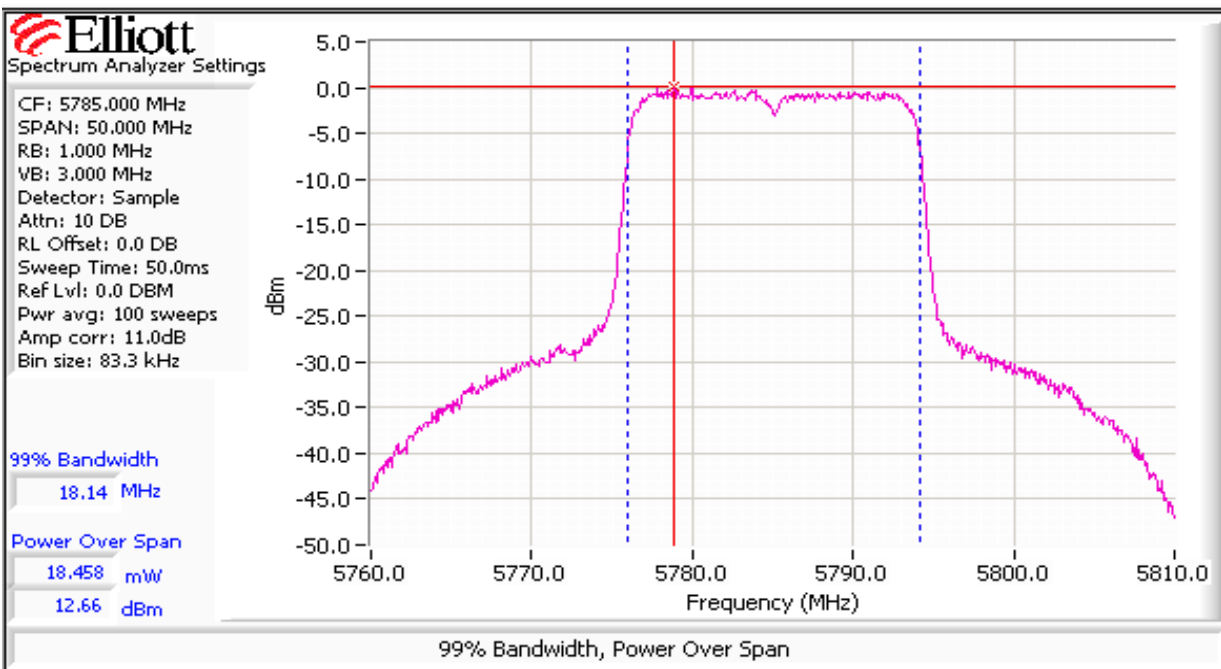
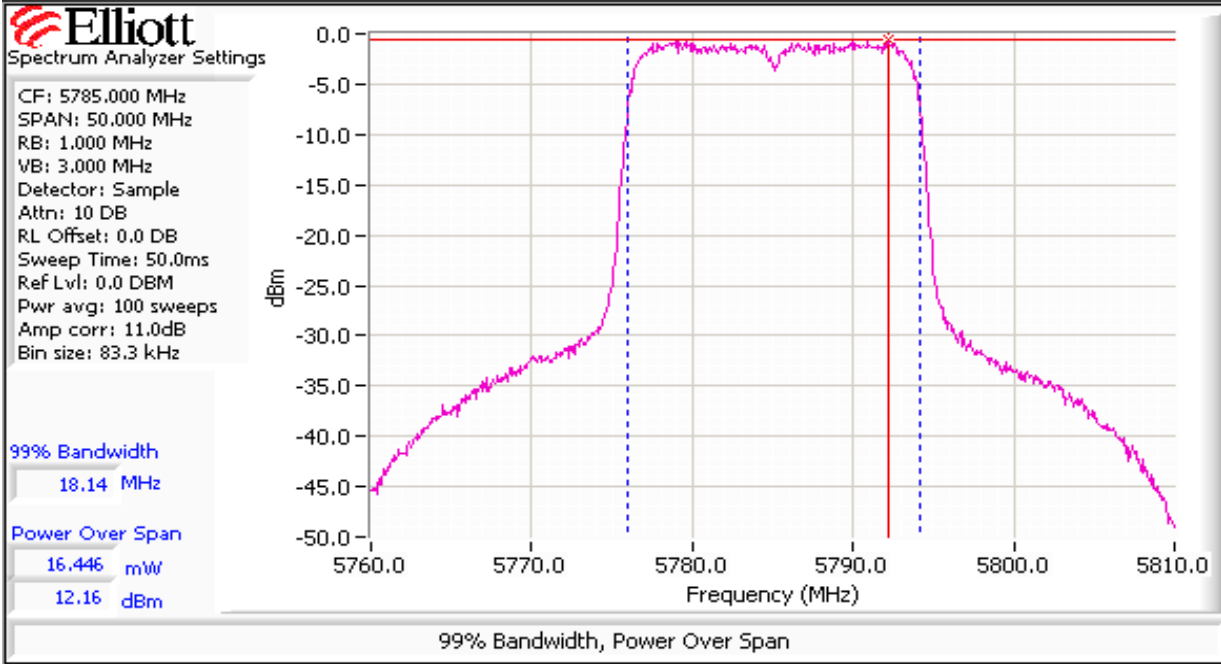

Client:	Intel Corporation	Job Number:	J80050
Model:	62205ANHMW (Intel® Centrino® Advanced-N 6205)	T-Log Number:	T80123
Contact:	Steven Hackett	Account Manager:	Christine Krebil
Standard:	FCC 15.247 / FCC 15 E / RSS 210 / FCC 15 B	Class:	N/A

Operating Mode: 802.11n, 40MHz

5755 MHz	Chain A	Chain B	Chain 3	Chain 4	Total Across All Chains		Limit	
Power Setting ^{Note 3}	28.5	28.5						
Average Power ^{Note 4}	13.6	13.7						
Output Power (dBm) ^{Note 1}	18.1	18.4			21.3 dBm	0.134 W	30.0 dBm	1.000 W
Antenna Gain (dBi) ^{Note 2}	5.0	5.0				5.0 dBi	Pass	
eirp (dBm) ^{Note 2}	23.1	23.4			26.3 dBm	0.423 W		

5795 MHz	Chain A	Chain B	Chain 3	Chain 4	Total Across All Chains		Limit	
Power Setting ^{Note 3}	28.5	28.5						
Average Power ^{Note 4}	13.5	13.7						
Output Power (dBm) ^{Note 1}	17.5	18.2			20.9 dBm	0.122 W	30.0 dBm	1.000 W
Antenna Gain (dBi) ^{Note 2}	5.0	5.0				5.0 dBi	Pass	
eirp (dBm) ^{Note 2}	22.5	23.2			25.9 dBm	0.387 W		

- Note 1: Peak power measurements made for n40MHz mode because this mode does not meet the -30dBc requirement at the 5725MHz band edge when operating on the lowest channel (refer to SISO mode measurements on individual chains).
- Note 2: As there is no coherency between chains the total EIRP is the sum of the individual EIRPs and effective antenna gain equals the eirp divide by the sum of the power on each chain.
- Note 3: Power setting - test utility setting, for reference only
- Note 4: Average output power per chain measured with an average power meter, for reference only

Client:	Intel Corporation	Job Number:	J80050
Model:	62205ANHMW (Intel® Centrino® Advanced-N 6205)	T-Log Number:	T80123
Contact:	Steven Hackett	Account Manager:	Christine Krebil
Standard:	FCC 15.247 / FCC 15 E / RSS 210 / FCC 15 B	Class:	N/A

Run #2: Power spectral Density

Power Setting	Frequency (MHz)	PSD (dBm/3kHz) ^{Note 1}				Total	Limit dBm/3kHz	Result
		Chain A	Chain B	Chain 3	Chain 4			
27.5/27.5	5745	-12.8	-11.2			-8.9	8.0	Pass
28/27.5	5785	-11.7	-10.7			-8.1	8.0	Pass
28/27.5	5825	-12.5	-11.8			-9.1	8.0	Pass
28.5/28.5	5755	-14.8	-15.0			-11.9	8.0	Pass
28.5/28.5	5795	-12.8	-12.3			-9.5	8.0	Pass

Note 1: Power spectral density measured using RB=3 kHz, VB=10kHz, analyzer with peak detector and with a sweep time set to ensure a dwell time of at least 1 second per 3kHz. The measurement is made at the frequency of PPSD determined from preliminary scans using RB=3kHz using multiple sweeps at a faster rate over the 6dB bandwidth of the signal.

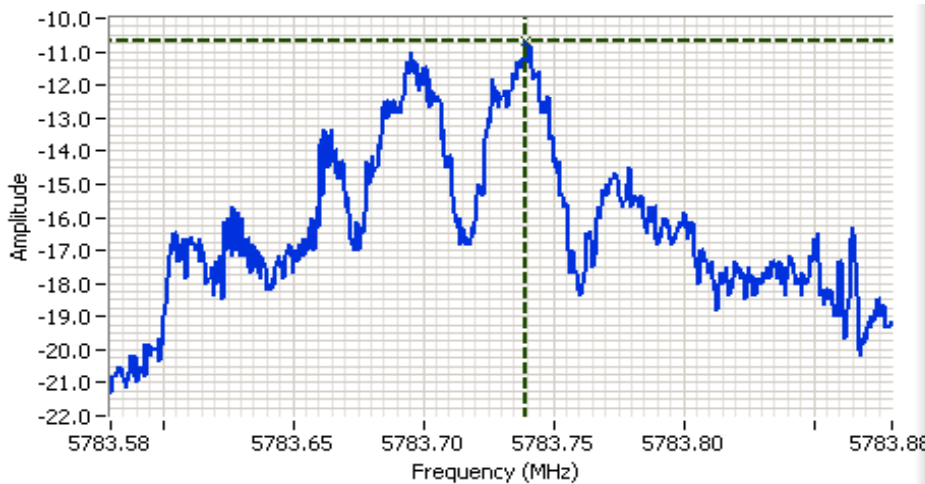

Analyzer Settings
 HP8564E,EMICF: 5783.730 MHz
 SPAN: 300 kHz
 RB: 3.00 kHz
 VB: 10.0 kHz
 Detector: POS
 Attn: 10 DB
 RL Offset: 11.0 DB
 Sweep Time: 100.0s
 Ref Lvl: 9.0 DBM

Comments
 PSD @ 5785 MHz
 Chain B

Cursor 1	5783.7395	-10.67		
	0.0000	0.00		

Client:	Intel Corporation	Job Number:	J80050
Model:	62205ANHMW (Intel® Centrino® Advanced-N 6205)	T-Log Number:	T80123
		Account Manager:	Christine Krebil
Contact:	Steven Hackett		
Standard:	FCC 15.247 / FCC 15 E / RSS 210 / FCC 15 B	Class:	B

Conducted Emissions - Wireless Module (DTS/III/RSS 210) *(Elliott Laboratories Fremont Facility, Semi-Anechoic Chamber)*

Test Specific Details

Objective: The objective of this test session is to perform final qualification testing of the EUT with respect to the specification listed above.

Date of Test: 8/13/2010
Test Engineer: Mark Hill
Test Location: FT #3

Config. Used: Module
Config Change: None
Host Unit Voltage 120V/60Hz

General Test Configuration

The test fixture was located on a wooden table inside the semi-anechoic chamber, 40 cm from a vertical coupling plane and 80cm from the LISN which was used to connect to the AC input of the DC power supply connected to the test fixture. A second LISN was used for all remaining support equipment.

Ambient Conditions: Temperature: 22 °C
Rel. Humidity: 37 %

Summary of Results

Run #	Test Performed	Limit	Result	Margin
1	CE, AC Power, 120V/60Hz	FCC 15.207/RSS GEN	Pass	33.2dBμV @ 13.426MHz (-16.8dB)

Modifications Made During Testing

No modifications were made to the EUT during testing

Deviations From The Standard

No deviations were made from the requirements of the standard.

Client:	Intel Corporation	Job Number:	J80050
Model:	62205ANHMW (Intel® Centrino® Advanced-N 6205)	T-Log Number:	T80123
Contact:	Steven Hackett	Account Manager:	Christine Krebil
Standard:	FCC 15.247 / FCC 15 E / RSS 210 / FCC 15 B	Class:	B

Run #1: AC Power Port Conducted Emissions, 0.15 - 30MHz, 120V/60Hz
 Configured to TX at 16.5dBm on each chain (settings 33/31) on channel 6, HT8

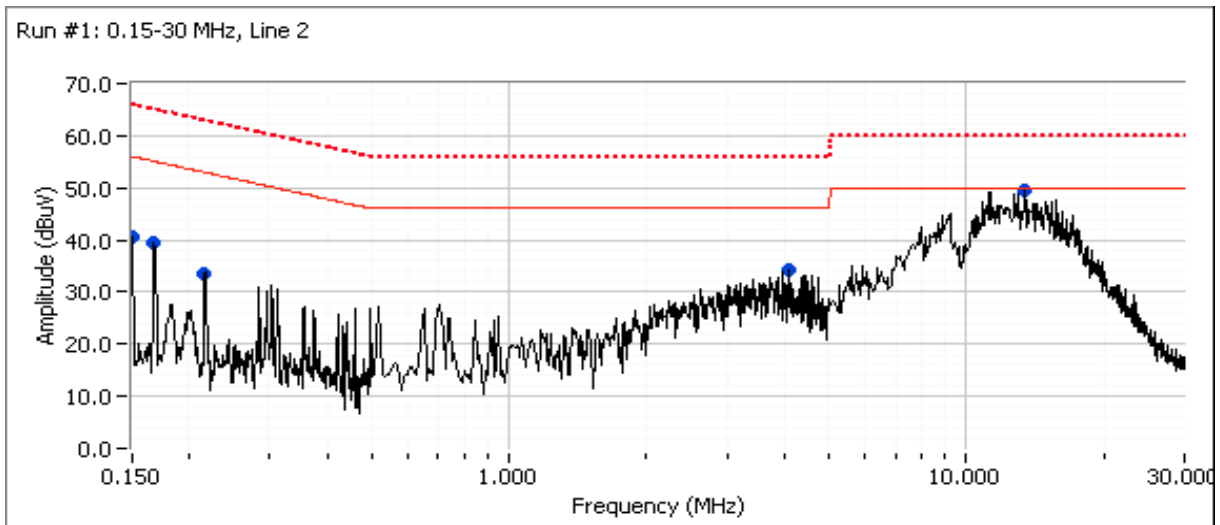
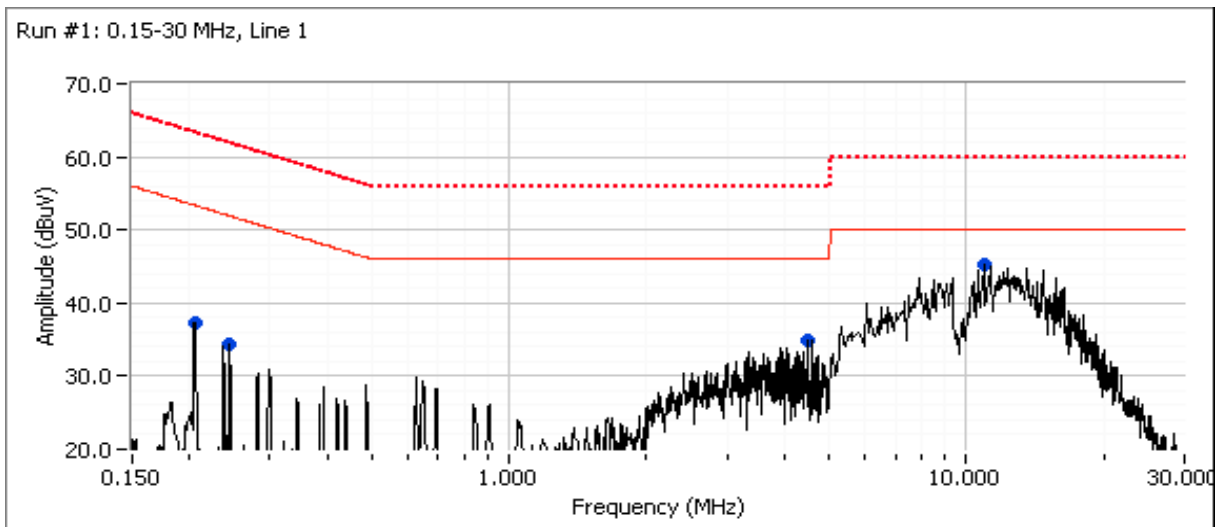

Client:	Intel Corporation	Job Number:	J80050
Model:	62205ANHMW (Intel® Centrino® Advanced-N 6205)	T-Log Number:	T80123
Contact:	Steven Hackett	Account Manager:	Christine Krebil
Standard:	FCC 15.247 / FCC 15 E / RSS 210 / FCC 15 B	Class:	B

Preliminary peak readings captured during pre-scan (peak readings vs. average limit)

Frequency MHz	Level dB μ V	AC Line	FCC 15.207/RSS GEN		Detector QP/Ave	Comments
			Limit	Margin		
13.426	49.5	Line 2	50.0	-0.5	Peak	
10.909	45.2	Line 1	50.0	-4.8	Peak	
4.488	35.0	Line 1	46.0	-11.0	Peak	
4.088	34.3	Line 2	46.0	-11.7	Peak	
0.150	40.7	Line 2	56.0	-15.3	Peak	
0.168	39.5	Line 2	55.1	-15.6	Peak	
0.205	37.4	Line 1	53.4	-16.0	Peak	
0.245	34.4	Line 1	51.9	-17.5	Peak	
0.217	33.5	Line 2	53.0	-19.5	Peak	

Final quasi-peak and average readings

Frequency MHz	Level dB μ V	AC Line	FCC 15.207/RSS GEN		Detector QP/Ave	Comments
			Limit	Margin		
13.426	33.2	Line 2	50.0	-16.8	AVG	AVG (0.10s)
13.426	42.6	Line 2	60.0	-17.4	QP	QP (1.00s)
10.909	39.1	Line 1	60.0	-20.9	QP	QP (1.00s)
10.909	27.9	Line 1	50.0	-22.1	AVG	AVG (0.10s)
4.488	28.7	Line 1	56.0	-27.3	QP	QP (1.00s)
4.088	28.2	Line 2	56.0	-27.8	QP	QP (1.00s)
0.150	36.1	Line 2	66.0	-29.9	QP	QP (1.00s)
0.168	35.0	Line 2	65.1	-30.1	QP	QP (1.00s)
4.488	15.7	Line 1	46.0	-30.3	AVG	AVG (0.10s)
4.088	14.7	Line 2	46.0	-31.3	AVG	AVG (0.10s)
0.205	30.4	Line 1	63.4	-33.0	QP	QP (1.00s)
0.245	28.7	Line 1	61.9	-33.2	QP	QP (1.00s)
0.217	28.5	Line 2	62.9	-34.4	QP	QP (1.00s)
0.205	14.8	Line 1	53.4	-38.6	AVG	AVG (0.10s)
0.245	12.3	Line 1	51.9	-39.6	AVG	AVG (0.10s)
0.217	11.5	Line 2	52.9	-41.4	AVG	AVG (0.10s)
0.150	13.9	Line 2	56.0	-42.1	AVG	AVG (0.10s)
0.168	12.8	Line 2	55.1	-42.3	AVG	AVG (0.10s)