



PARTIAL FCC TEST REPORT (BLUETOOTH)

REPORT NO.: RF120503C13A-2

MODEL NO.: TP00042A

FCC ID: GKR-TP00042AHB

RECEIVED: May 21, 2012

TESTED: Aug. 09 ~ Aug. 13, 2012

ISSUED: Aug. 17, 2012

APPLICANT: COMPAL ELECTRONICS, INC.

ADDRESS: No.581, Ruiguang Rd., Neihu District, Taipei City
11492, Taiwan (R.O.C.)

ISSUED BY: Bureau Veritas Consumer Products Services (H.K.)
Ltd., Taoyuan Branch

LAB ADDRESS: No. 47, 14th Ling, Chia Pau Vil., Lin Kou Dist., New
Taipei City, Taiwan (R.O.C)

TEST LOCATION: No. 47, 14th Ling, Chia Pau Vil., Lin Kou Dist., New
Taipei City, Taiwan (R.O.C)

This report should not be used by the client to claim product certification, approval, or endorsement by TAF or any government agencies.



This report is for your exclusive use. Any copying or replication of this report to or for any other person or entity, or use of our name or trademark, is permitted only with our prior written permission. This report sets forth our findings solely with respect to the test samples identified herein. The results set forth in this report are not indicative or representative of the quality or characteristics of the lot from which a test sample was taken or any similar or identical product unless specifically and expressly noted. Our report includes all of the tests requested by you and the results thereof based upon the information that you provided to us. You have 60 days from date of issuance of this report to notify us of any material error or omission caused by our negligence, provided, however, that such notice shall be in writing and shall specifically address the issue you wish to raise. A failure to raise such issue within the prescribed time shall constitute your unqualified acceptance of the completeness of this report, the tests conducted and the correctness of the report contents. Unless specific mention, the uncertainty of measurement has been explicitly taken into account to declare the compliance or non-compliance to the specification



Table of Contents

RELEASE CONTROL RECORD.....	3
1. CERTIFICATION.....	4
2. SUMMARY OF TEST RESULTS.....	5
2.1 MEASUREMENT UNCERTAINTY.....	5
3. GENERAL INFORMATION.....	6
3.1 GENERAL DESCRIPTION OF EUT.....	6
3.2 DESCRIPTION OF TEST MODES.....	8
3.2.1 TEST MODE APPLICABILITY AND TESTED CHANNEL DETAIL.....	9
3.3 GENERAL DESCRIPTION OF APPLIED STANDARDS.....	12
3.4 DESCRIPTION OF SUPPORT UNITS.....	12
3.4.1 CONFIGURATION OF SYSTEM UNDER TEST.....	12
4. TEST TYPES AND RESULTS (FOR BLUETOOTH EDR).....	13
4.1 RADIATED EMISSION AND BANDEDGE MEASUREMENT.....	13
4.1.1 LIMITS OF RADIATED EMISSION AND BANDEDGE MEASUREMENT.....	13
4.1.2 TEST INSTRUMENTS.....	14
4.1.3 TEST PROCEDURES.....	15
4.1.4 DEVIATION FROM TEST STANDARD.....	15
4.1.5 TEST SETUP.....	16
4.1.6 EUT OPERATING CONDITIONS.....	16
4.1.7 TEST RESULTS.....	17
4.2 CONDUCTED EMISSION MEASUREMENT.....	20
4.2.1 LIMITS OF CONDUCTED EMISSION MEASUREMENT.....	20
4.2.2 TEST INSTRUMENTS.....	20
4.2.3 TEST PROCEDURES.....	21
4.2.4 DEVIATION FROM TEST STANDARD.....	21
4.2.5 TEST SETUP.....	22
4.2.6 EUT OPERATING CONDITIONS.....	22
4.2.7 TEST RESULTS.....	23
5. TEST TYPES AND RESULTS (FOR BLUETOOTH LE 4.0).....	25
5.1 RADIATED EMISSION AND BANDEDGE MEASUREMENT.....	25
5.1.1 LIMITS OF RADIATED EMISSION AND BANDEDGE MEASUREMENT.....	25
5.1.2 TEST INSTRUMENTS.....	25
5.1.3 TEST PROCEDURES.....	25
5.1.4 DEVIATION FROM TEST STANDARD.....	25
5.1.5 TEST SETUP.....	25
5.1.6 EUT OPERATING CONDITIONS.....	25
5.1.7 TEST RESULTS.....	26
5.2 CONDUCTED EMISSION MEASUREMENT.....	29
5.2.1 LIMITS OF CONDUCTED EMISSION MEASUREMENT.....	29
5.2.2 TEST INSTRUMENTS.....	29
5.2.3 TEST PROCEDURES.....	29
5.2.4 DEVIATION FROM TEST STANDARD.....	29
5.2.5 TEST SETUP.....	29
5.2.6 EUT OPERATING CONDITIONS.....	29
5.2.7 TEST RESULTS.....	30
6. PHOTOGRAPHS OF THE TEST CONFIGURATION.....	32
7. INFORMATION ON THE TESTING LABORATORIES.....	33
8. APPENDIX A - MODIFICATIONS RECORDERS FOR ENGINEERING CHANGES TO THE EUT BY THE LAB.....	34



A D T

RELEASE CONTROL RECORD

ISSUE NO.	REASON FOR CHANGE	DATE ISSUED
RF120503C13A-2	Original release	Aug. 17, 2012



1. CERTIFICATION

PRODUCT: Convertible Tablet Computer

MODEL: TP00042A

BRAND: Lenovo

APPLICANT: COMPAL ELECTRONICS, INC.

TESTED: Aug. 09 ~ Aug. 13, 2012

TEST SAMPLE: ENGINEERING SAMPLE

STANDARDS: FCC Part 15, Subpart C (Section 15.247)

ANSI C63.10-2009

This report is issued as a supplementary report of BV ADT report no.: RF120503C13-2. This report shall be used by combining with its original report.

PREPARED BY :  , **DATE :** Aug. 17, 2012
Pettie Chen / Specialist

APPROVED BY :  , **DATE :** Aug. 17, 2012
Gary Chang / Technical Manager

2. SUMMARY OF TEST RESULTS

The EUT has been tested according to the following specifications:

APPLIED STANDARD: FCC Part 15, Subpart C (Bluetooth EDR)			
STANDARD SECTION	TEST TYPE AND LIMIT	RESULT	REMARK
15.207	AC Power Conducted Emission	PASS	Meet the requirement of limit. Minimum passing margin is -17.86dB at 0.15000MHz.
15.247(d)	Transmitter Radiated Emissions	PASS	Meet the requirement of limit. Minimum passing margin is -8.1dB at 31.62MHz.

APPLIED STANDARD: FCC PART 15, SUBPART C (SECTION 15.247) (Bluetooth LE 4.0)			
STANDARD SECTION	TEST TYPE AND LIMIT	RESULT	REMARK
15.207	AC Power Conducted Emission	PASS	Meet the requirement of limit. Minimum passing margin is -17.61dB at 0.15000MHz.
15.247(d) 15.209	Radiated Emissions	PASS	Meet the requirement of limit. Minimum passing margin is -5.2dB at 93.05MHz.

2.1 MEASUREMENT UNCERTAINTY

Where relevant, the following measurement uncertainty levels have been estimated for tests performed on the EUT as specified in CISPR 16-4-2:

MEASUREMENT	FREQUENCY	UNCERTAINTY
Conducted emissions	9kHz~30MHz	2.44 dB
Radiated emissions	30MHz ~ 1GHz	3.87 dB
	Above 1GHz	3.36 dB

This uncertainty represents an expanded uncertainty expressed at approximately the 95% confidence level using a coverage factor of k=2.



3. GENERAL INFORMATION

3.1 GENERAL DESCRIPTION OF EUT

EUT	Convertible Tablet Computer	
MODEL NO.	TP00042A	
POWER SUPPLY	20Vdc from adapter	
MODULATION TYPE	Bluetooth EDR	GFSK, $\pi/4$ -DQPSK, 8DPSK
	Bluetooth LE 4.0	GFSK
TRANSFER RATE	Bluetooth EDR	1/2/3Mbps
	Bluetooth LE 4.0	1Mbps
OPERATING FREQUENCY	2402 ~ 2480MHz	
NUMBER OF CHANNEL	Bluetooth EDR	79
	Bluetooth LE 4.0	40
CHANNEL SPACING	Bluetooth EDR	1MHz
	Bluetooth LE 4.0	2MHz
OUTPUT POWER	Bluetooth EDR	4.285mW
	Bluetooth LE 4.0	2.15mW
ANTENNA TYPE	Refer to NOTE as below	
ANTENNA CONNECTOR	NA	
DATA CABLE	NA	
I/O PORTS	Refer to user's manual	
ACCESSORY DEVICES	Adapter	

NOTE:

- This report is issued as a supplementary report of BV ADT report no.: RF120503C13-2. The difference compared with original report is changing the antenna. Therefore, we re-tested conducted emission and radiated emission tests and presented in this report.
- The EUT consumes power from the following adapter.

ADAPTER	
BRAND:	Lenovo
MODEL:	45N0185
INPUT:	100-240Vac, 50-60Hz, 1.5A
OUTPUT:	20Vdc, 3.25A
POWER LINE:	1.8m non-shielded cable with one core

- The WLAN module (model no.: BCM943228HMB and brand name: Broadcom) is collocated in this EUT.



A D T

4. The antenna information is listed as below.

WNC Antenna		
Antenna Type	PIFA	
Manufacturer	Wistron Neweb Corp.	
Model Name	Antenna Type	Model name
	WLAN MAIN L	81.EG915.G34
	WLAN AUX R	81.EG915.G35
Antenna Gain	WLAN Main	
	2.4~2.4835 GHz	-0.54
	5.15~5.25 GHz	0.12
	5.25~5.35 GHz	-0.41
	5.47~5.725 GHz	0.86
	5.725~5.85 GHz	0.86
	WLAN Aux.	
	2.4~2.4835 GHz	-1.09
	5.15~5.25 GHz	0.91
	5.25~5.35 GHz	0.91
	5.47~5.725 GHz	1.23
5.725~5.85 GHz	1.23	

5. The above EUT information is declared by the manufacturer and for more detailed features description, please refer to the manufacturer's specifications or User's Manual.

3.2 DESCRIPTION OF TEST MODES

For Bluetooth EDR:

79 channels are provided to this EUT:

CHANNEL	FREQ. (MHz)	CHANNEL	FREQ. (MHz)	CHANNEL	FREQ. (MHz)	CHANNEL	FREQ. (MHz)
0	2402	20	2422	40	2442	60	2462
1	2403	21	2423	41	2443	61	2463
2	2404	22	2424	42	2444	62	2464
3	2405	23	2425	43	2445	63	2465
4	2406	24	2426	44	2446	64	2466
5	2407	25	2427	45	2447	65	2467
6	2408	26	2428	46	2448	66	2468
7	2409	27	2429	47	2449	67	2469
8	2410	28	2430	48	2450	68	2470
9	2411	29	2431	49	2451	69	2471
10	2412	30	2432	50	2452	70	2472
11	2413	31	2433	51	2453	71	2473
12	2414	32	2434	52	2454	72	2474
13	2415	33	2435	53	2455	73	2475
14	2416	34	2436	54	2456	74	2476
15	2417	35	2437	55	2457	75	2477
16	2418	36	2438	56	2458	76	2478
17	2419	37	2439	57	2459	77	2479
18	2420	38	2440	58	2460	78	2480
19	2421	39	2441	59	2461		

For Bluetooth LE 4.0:

40 channels are provided to this EUT:

CHANNEL	FREQ. (MHz)	CHANNEL	FREQ. (MHz)	CHANNEL	FREQ. (MHz)	CHANNEL	FREQ. (MHz)
0	2402	10	2422	20	2442	30	2462
1	2404	11	2424	21	2444	31	2464
2	2406	12	2426	22	2446	32	2466
3	2408	13	2428	23	2448	33	2468
4	2410	14	2430	24	2450	34	2470
5	2412	15	2432	25	2452	35	2472
6	2414	16	2434	26	2454	36	2474
7	2416	17	2436	27	2456	37	2476
8	2418	18	2438	28	2458	38	2478
9	2420	19	2440	29	2460	39	2480

3.2.1 TEST MODE APPLICABILITY AND TESTED CHANNEL DETAIL

For Bluetooth EDR:

EUT CONFIGURE MODE	APPLICABLE TO			DESCRIPTION
	RE \geq 1G	RE $<$ 1G	PLC	
-	√	√	√	-

Where **RE \geq 1G**: Radiated Emission above 1GHz **RE $<$ 1G**: Radiated Emission below 1GHz
PLC: Power Line Conducted Emission

NOTE:

The EUT had been pre-tested on the positioned of each 3 axis. The worst case was found when positioned on **X-plane**.

RADIATED EMISSION TEST (ABOVE 1 GHz):

- Pre-Scan has been conducted to determine the worst-case mode from all possible combinations between available modulations, antenna ports (if EUT with antenna diversity architecture) and packet type.
- Following channel(s) was (were) selected for the final test as listed below.

EUT CONFIGURE MODE	AVAILABLE CHANNEL	TESTED CHANNEL	MODULATION TYPE	PACKET TYPE
-	0 to 78	0	8DPSK	DH5

RADIATED EMISSION TEST (BELOW 1 GHz):

- Pre-Scan has been conducted to determine the worst-case mode from all possible combinations between available modulations, antenna ports (if EUT with antenna diversity architecture) and packet type.
- Following channel(s) was (were) selected for the final test as listed below.

EUT CONFIGURE MODE	AVAILABLE CHANNEL	TESTED CHANNEL	MODULATION TYPE	PACKET TYPE
-	0 to 78	0	8DPSK	DH5

POWER LINE CONDUCTED EMISSION TEST:

- Pre-Scan has been conducted to determine the worst-case mode from all possible combinations between available modulations, antenna ports (if EUT with antenna diversity architecture), and packet types.
- Following channel(s) was (were) selected for the final test as listed below.

EUT CONFIGURE MODE	AVAILABLE CHANNEL	TESTED CHANNEL	MODULATION TYPE	PACKET TYPE
-	0 to 78	0	8DPSK	DH5



A D T

TEST CONDITION:

APPLICABLE TO	ENVIRONMENTAL CONDITIONS	INPUT POWER	TESTED BY
RE \geq 1G	26deg. C, 82%RH	120Vac, 60Hz	Nick Chen
RE<1G	28deg. C, 82%RH	120Vac, 60Hz	Nick Chen
PLC	25deg. C, 74%RH	120Vac, 60Hz	Antony Lee



FOR Bluetooth LE 4.0:

EUT CONFIGURE MODE	APPLICABLE TO			DESCRIPTION
	RE≥1G	RE<1G	PLC	
-	√	√	√	-

Where **RE≥1G**: Radiated Emission above 1GHz **RE<1G**: Radiated Emission below 1GHz
PLC: Power Line Conducted Emission

NOTE:

The EUT had been pre-tested on the positioned of each 3 axis. The worst case was found when positioned on **X-plane**.

RADIATED EMISSION TEST (ABOVE 1GHz):

- Pre-Scan has been conducted to determine the worst-case mode from all possible combinations between available modulations and antenna ports (if EUT with antenna diversity architecture).
- Following channel(s) was (were) selected for the final test as listed below.

EUT CONFIGURE MODE	AVAILABLE CHANNEL	TESTED CHANNEL	MODULATION TYPE	DATA RATE (Mbps)
-	0 to 39	0	GFSK	1.0

RADIATED EMISSION TEST (BELOW 1GHz):

- Pre-Scan has been conducted to determine the worst-case mode from all possible combinations between available modulations and antenna ports (if EUT with antenna diversity architecture).
- Following channel(s) was (were) selected for the final test as listed below.

EUT CONFIGURE MODE	AVAILABLE CHANNEL	TESTED CHANNEL	MODULATION TYPE	DATA RATE (Mbps)
-	0 to 39	0	GFSK	1.0

POWER LINE CONDUCTED EMISSION TEST:

- Pre-Scan has been conducted to determine the worst-case mode from all possible combinations between available modulations and antenna ports (if EUT with antenna diversity architecture).
- Following channel(s) was (were) selected for the final test as listed below.

EUT CONFIGURE MODE	AVAILABLE CHANNEL	TESTED CHANNEL	MODULATION TYPE	DATA RATE (Mbps)
-	0 to 39	0	GFSK	1.0

TEST CONDITION:

APPLICABLE TO	ENVIRONMENTAL CONDITIONS	INPUT POWER	TESTED BY
RE≥1G	26deg. C, 82%RH	120Vac, 60Hz	Nick Chen
RE<1G	28deg. C, 82%RH	120Vac, 60Hz	Nick Chen
PLC	25deg. C, 74%RH	120Vac, 60Hz	Antony Lee

3.3 GENERAL DESCRIPTION OF APPLIED STANDARDS

The EUT is a RF Product. According to the specifications of the manufacturer, it must comply with the requirements of the following standards:

FCC Part 15, Subpart C (15.247)

ANSI C63.10-2009

558074 D01 DTS Meas Guidance v01

FCC Public Notice DA 00-705

All test items have been performed and recorded as per the above standards.

3.4 DESCRIPTION OF SUPPORT UNITS

The EUT has been tested as an independent unit together with other necessary accessories or support units.

3.4.1 CONFIGURATION OF SYSTEM UNDER TEST

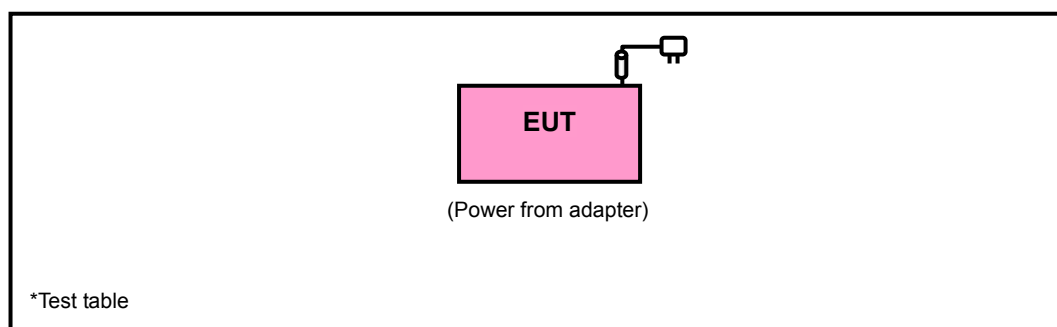



4. TEST TYPES AND RESULTS (FOR Bluetooth EDR)

4.1 RADIATED EMISSION AND BANDEDGE MEASUREMENT

4.1.1 LIMITS OF RADIATED EMISSION AND BANDEDGE MEASUREMENT

Radiated emissions which fall in the restricted bands must comply with the radiated emission limits specified as below table. Other emissions shall be at least 20dB below the highest level of the desired power:

FREQUENCIES (MHz)	FIELD STRENGTH (microvolts/meter)	MEASUREMENT DISTANCE (meters)
0.009 ~ 0.490	2400/F(kHz)	300
0.490 ~ 1.705	24000/F(kHz)	30
1.705 ~ 30.0	30	30
30 ~ 88	100	3
88 ~ 216	150	3
216 ~ 960	200	3
Above 960	500	3

NOTE:

1. The lower limit shall apply at the transition frequencies.
2. Emission level (dBuV/m) = 20 log Emission level (uV/m).
3. For frequencies above 1000MHz, the field strength limits are based on average detector, however, the peak field strength of any emission shall not exceed the maximum permitted average limits, specified above by more than 20dB under any condition of modulation.



A D T

4.1.2 TEST INSTRUMENTS

DESCRIPTION & MANUFACTURER	MODEL NO.	SERIAL NO.	DATE OF CALIBRATION	DUE DATE OF CALIBRATION
HP Preamplifier	8447D	2432A03504	Feb. 29, 2012	Feb. 28, 2013
HP Preamplifier	8449B	3008A01201	Feb. 29, 2012	Feb. 28, 2013
Agilent Spectrum Analyzer	E4446A	MY46180403	Jun. 13, 2012	Jun. 12, 2013
ROHDE & SCHWARZ Test Receiver	ESCS 30	838251/021	Oct. 14, 2011	Oct. 13, 2012
Schwarzbeck Antenna	VULB 9168	137	Apr. 03, 2012	Apr. 02, 2013
Schwarzbeck Antenna	VHBA 9123	480	May 22, 2012	May 21, 2013
ADT. Turn Table	TT100	0306	NA	NA
ADT. Tower	AT100	0306	NA	NA
Software	ADT_Radiated_V7.6.15.9.2	NA	NA	NA
SUHNER RF cable	SF102	CABLE-CH6	Aug. 19, 2011	Aug. 18, 2012
Schwarzbeck Horn Antenna	BBHA 9120-D1	D130	May 18, 2012	May 17, 2013
Highpass filter Wainwright Instruments	WHK 3.1/18G-10SS	SN 8	NA	NA

- NOTE:** 1. The calibration interval of the above test instruments is 12/24 months. And the calibrations are traceable to NML/ROC and NIST/USA.
2. The horn antenna and HP preamplifier (model: 8449B) are used only for the measurement of emission frequency above 1GHz if tested.
3. The test was performed in Chamber No. 6.
4. The Industry Canada Reference No. IC 7450E-6.

4.1.3 TEST PROCEDURES

- a. The EUT was placed on the top of a rotating table 0.8 meters above the ground at a 3 meter semi-anechoic chamber. The table was rotated 360 degrees to determine the position of the highest radiation.
- b. The EUT was set 3 meters away from the interference-receiving antenna, which was mounted on the top of a variable-height antenna tower.
- c. The antenna is a broadband antenna, and its height is varied from one meter to four meters above the ground to determine the maximum value of the field strength. Both horizontal and vertical polarizations of the antenna are set to make the measurement.
- d. For each suspected emission, the EUT was arranged to its worst case and then the antenna was tuned to heights from 1 meter to 4 meters and the rotatable table was turned from 0 degrees to 360 degrees to find the maximum reading.
- e. The test-receiver system was set to Peak Detect Function and Specified Bandwidth with Maximum Hold Mode.
- f. If the emission level of the EUT in peak mode was lower than the limit specified, then testing could be stopped and the peak values of the EUT would be reported. Otherwise the emissions would be re-tested one by one using peak, quasi-peak or average method as specified and then reported in a data sheet.

NOTE:

1. The resolution bandwidth and video bandwidth of test receiver/spectrum analyzer is 120kHz for Quasi-peak detection at frequency below 1GHz.
2. The resolution bandwidth of test receiver/spectrum analyzer is 1 MHz and video bandwidth is 3MHz for Peak detection at frequency above 1GHz.
3. All modes of operation were investigated and the worst-case emissions are reported.

4.1.4 DEVIATION FROM TEST STANDARD

No deviation.

4.1.5 TEST SETUP

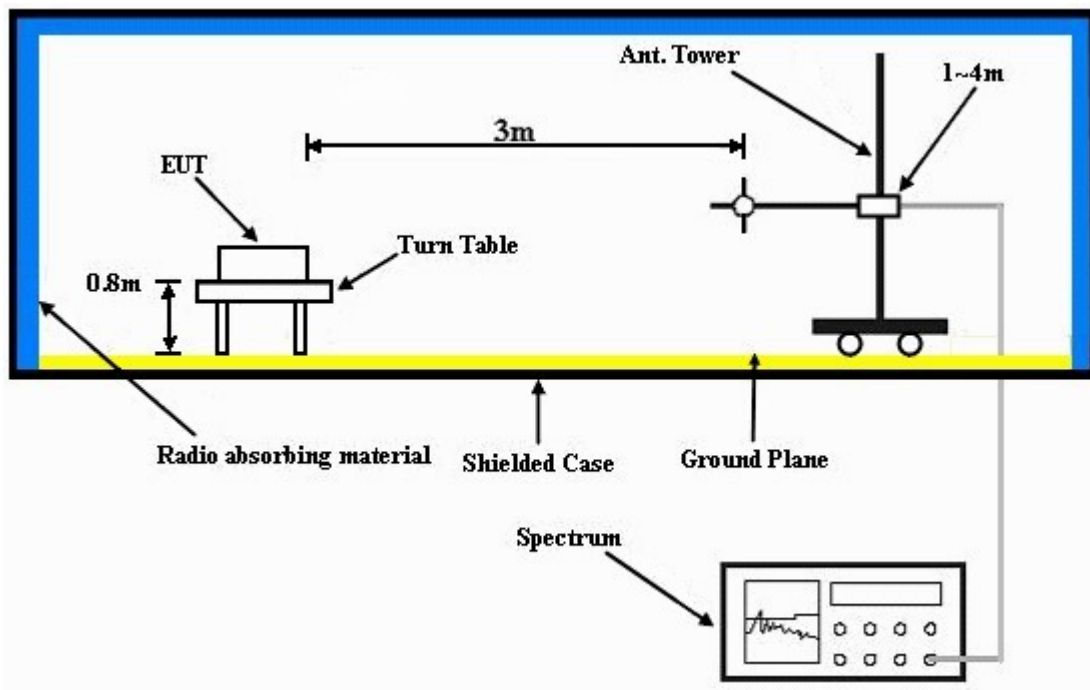

For the actual test configuration, please refer to the attached file (Test Setup Photo).

4.1.6 EUT OPERATING CONDITIONS

- a. Placed the EUT on a testing table.
- b. Use the software to control the EUT under transmission condition continuously at specific channel frequency.



4.1.7 TEST RESULTS

ABOVE 1GHz WORST-CASE DATA : 8DPSK

EUT TEST CONDITION		MEASUREMENT DETAIL	
CHANNEL	Channel 0	FREQUENCY RANGE	1 ~ 25GHz
INPUT POWER (SYSTEM)	120Vac, 60 Hz	DETECTOR FUNCTION	Peak (PK) Average (AV)
ENVIRONMENTAL CONDITIONS	26deg. C, 82%RH	TESTED BY	Nick Chen

ANTENNA POLARITY & TEST DISTANCE: HORIZONTAL AT 3 M								
NO.	FREQ. (MHz)	EMISSION LEVEL (dBuV/m)	LIMIT (dBuV/m)	MARGIN (dB)	ANTENNA HEIGHT (m)	TABLE ANGLE (Degree)	RAW VALUE (dBuV)	CORRECTION FACTOR (dB/m)
1	2390.00	55.8 PK	74.0	-18.2	1.04 H	318	25.55	30.24
2	2390.00	44.6 AV	54.0	-9.4	1.04 H	318	14.36	30.24
3	2400.00	36.0 PK	74.0	-38.0	1.04 H	318	5.74	30.29
4	2400.00	5.9 AV	54.0	-48.1	1.04 H	318	-24.36	30.29
5	*2402.00	95.2 PK			1.04 H	318	64.93	30.30
6	*2402.00	65.1 AV			1.04 H	318	34.83	30.30
7	3202.00	45.1 PK	74.0	-28.9	1.00 H	183	11.90	33.23
8	3202.00	36.3 AV	54.0	-17.7	1.00 H	183	3.06	33.23
9	4804.00	48.5 PK	74.0	-25.5	1.01 H	331	11.88	36.59
10	4804.00	18.4 AV	54.0	-35.6	1.01 H	331	-18.22	36.59

REMARKS:

1. Emission level (dBuV/m) = Raw Value (dBuV) + Correction Factor (dB/m).
2. Correction Factor (dB/m) = Antenna Factor (dB/m) + Cable Factor (dB).
3. The other emission levels were very low against the limit.
4. Margin value = Emission level – Limit value.
5. “ * “: Fundamental frequency.
6. The DH5 packet was the worse case duty cycle for a transmit dwell time on a channel, based upon bluetooth theory the transmitter is on 0.625 * 5 per 296.25 ms per channel. Therefore, the duty cycle correlation factor be equal to: $20\log(3.125 / 100) = -30.1$ dB.
7. Average value = peak reading + $20\log(\text{duty cycle})$.



EUT TEST CONDITION		MEASUREMENT DETAIL	
CHANNEL	Channel 0	FREQUENCY RANGE	1 ~ 25GHz
INPUT POWER (SYSTEM)	120Vac, 60 Hz	DETECTOR FUNCTION	Peak (PK) Average (AV)
ENVIRONMENTAL CONDITIONS	26deg. C, 82%RH	TESTED BY	Nick Chen

ANTENNA POLARITY & TEST DISTANCE: VERTICAL AT 3 M								
NO.	FREQ. (MHz)	EMISSION LEVEL (dBuV/m)	LIMIT (dBuV/m)	MARGIN (dB)	ANTENNA HEIGHT (m)	TABLE ANGLE (Degree)	RAW VALUE (dBuV)	CORRECTION FACTOR (dB/m)
1	2390.00	55.8 PK	74.0	-18.2	1.05 V	297	25.55	30.24
2	2390.00	44.3 AV	54.0	-9.7	1.05 V	297	14.03	30.24
3	2400.00	34.8 PK	74.0	-39.2	1.05 V	297	4.46	30.29
4	2400.00	4.7 AV	54.0	-49.3	1.05 V	297	-25.64	30.29
5	*2402.00	94.0 PK			1.05 V	297	63.65	30.30
6	*2402.00	63.9 AV			1.05 V	297	33.55	30.30
7	3202.00	43.7 PK	74.0	-30.3	1.00 V	254	10.44	33.23
8	3202.00	33.7 AV	54.0	-20.3	1.00 V	254	0.48	33.23
9	4804.00	47.6 PK	74.0	-26.4	1.02 V	293	11.03	36.59
10	4804.00	17.5 AV	54.0	-36.5	1.02 V	293	-19.07	36.59

REMARKS:

1. Emission level (dBuV/m) = Raw Value (dBuV) + Correction Factor (dB/m).
2. Correction Factor (dB/m) = Antenna Factor (dB/m) + Cable Factor (dB).
3. The other emission levels were very low against the limit.
4. Margin value = Emission level – Limit value.
5. “ * “: Fundamental frequency.
6. The DH5 packet was the worse case duty cycle for a transmit dwell time on a channel, based upon bluetooth theory the transmitter is on 0.625 * 5 per 296.25 ms per channel. Therefore, the duty cycle correlation factor be equal to: $20\log(3.125 / 100) = -30.1 \text{ dB}$.
7. Average value = peak reading + $20\log(\text{duty cycle})$.



BELOW 1GHz WORST-CASE DATA : 8DPSK

EUT TEST CONDITION		MEASUREMENT DETAIL	
CHANNEL	Channel 0	FREQUENCY RANGE	Below 1000MHz
INPUT POWER (SYSTEM)	120Vac, 60 Hz	DETECTOR FUNCTION	Quasi-Peak
ENVIRONMENTAL CONDITIONS	28deg. C, 82%RH	TESTED BY	Nick Chen

ANTENNA POLARITY & TEST DISTANCE: HORIZONTAL AT 3 M								
NO.	FREQ. (MHz)	EMISSION LEVEL (dBuV/m)	LIMIT (dBuV/m)	MARGIN (dB)	ANTENNA HEIGHT (m)	TABLE ANGLE (Degree)	RAW VALUE (dBuV)	CORRECTION FACTOR (dB/m)
1	93.05	32.6 QP	43.5	-10.9	1.49 H	9	23.84	8.76
2	287.05	33.3 QP	46.0	-12.7	1.00 H	227	18.15	15.15
3	338.78	36.4 QP	46.0	-9.6	1.00 H	130	19.73	16.71
4	369.50	32.2 QP	46.0	-13.8	1.00 H	235	14.74	17.49
5	409.92	35.3 QP	46.0	-10.7	1.00 H	230	16.76	18.53
6	427.70	33.2 QP	46.0	-12.8	1.00 H	227	14.14	19.08
7	476.20	35.3 QP	46.0	-10.7	1.49 H	104	14.83	20.48
8	489.13	33.7 QP	46.0	-12.3	1.49 H	104	12.87	20.83
9	524.70	32.4 QP	46.0	-13.6	1.49 H	208	10.77	21.63

ANTENNA POLARITY & TEST DISTANCE: VERTICAL AT 3 M								
NO.	FREQ. (MHz)	EMISSION LEVEL (dBuV/m)	LIMIT (dBuV/m)	MARGIN (dB)	ANTENNA HEIGHT (m)	TABLE ANGLE (Degree)	RAW VALUE (dBuV)	CORRECTION FACTOR (dB/m)
1	31.62	31.9 QP	40.0	-8.1	1.25 V	2	20.06	11.86
2	93.05	28.5 QP	43.5	-15.0	1.00 V	352	19.72	8.76
3	333.93	31.7 QP	46.0	-14.3	1.25 V	9	15.13	16.57
4	476.20	30.8 QP	46.0	-15.2	1.00 V	82	10.30	20.48
5	671.82	29.3 QP	46.0	-16.7	1.50 V	168	5.05	24.26
6	689.60	29.7 QP	46.0	-16.3	1.25 V	169	5.22	24.48

REMARKS:

1. Emission level (dBuV/m) = Raw Value (dBuV) + Correction Factor (dB/m).
2. Correction Factor (dB/m) = Antenna Factor (dB/m) + Cable Factor (dB).
3. The other emission levels were very low against the limit.
4. Margin value = Emission level – Limit value.



4.2 CONDUCTED EMISSION MEASUREMENT

4.2.1 LIMITS OF CONDUCTED EMISSION MEASUREMENT

FREQUENCY OF EMISSION (MHz)	CONDUCTED LIMIT (dB μ V)	
	Quasi-peak	Average
0.15 ~ 0.5	66 to 56	56 to 46
0.5 ~ 5	56	46
5 ~ 30	60	50

- NOTE:**
1. The lower limit shall apply at the transition frequencies.
 2. The limit decreases in line with the logarithm of the frequency in the range of 0.15 to 0.50 MHz.
 3. All emanations from a class A/B digital device or system, including any network of conductors and apparatus connected thereto, shall not exceed the level of field strengths specified above.

4.2.2 TEST INSTRUMENTS

DESCRIPTION & MANUFACTURER	MODEL NO.	SERIAL NO.	DATE OF CALIBRATION	DUE DATE OF CALIBRATION
ROHDE & SCHWARZ Test Receiver	ESCS 30	100276	Jan. 04, 2012	Jan. 03, 2013
ROHDE & SCHWARZ Artificial Mains Network (for EUT)	ESH3-Z5	100219	Nov. 24, 2011	Nov. 23, 2012
LISN With Adapter (for EUT)	AD10	C10Ada-001	Nov. 24, 2011	Nov. 23, 2012
ROHDE & SCHWARZ Artificial Mains Network (for peripherals)	ESH3-Z5	100218	Dec. 08, 2011	Dec. 07, 2012
Software	ADT Cond V7.3.7	NA	NA	NA
Software	ADT ISN V7.3.7	NA	NA	NA
RF cable (JYEBAO)	5D-FB	Cable-C10.01	Feb. 20, 2012	Feb. 19, 2013
SUHNER Terminator (For ROHDE & SCHWARZ LISN)	65BNC-5001	E1-010773	Feb. 22, 2012	Feb. 21, 2013

- NOTE:**
1. The calibration interval of the above test instruments is 12 months and the calibrations are traceable to NML/ROC and NIST/USA.
 2. The test was performed in Shielded Room No. 10.
 3. The VCCI Site Registration No. C-1852.

4.2.3 TEST PROCEDURES

- a. The EUT was placed 0.4 meters from the conducting wall of the shielded room with EUT being connected to the power mains through a line impedance stabilization network (LISN). Other support units were connected to the power mains through another LISN. The two LISNs provide 50 ohm/ 50uH of coupling impedance for the measuring instrument.
- b. Both lines of the power mains connected to the EUT were checked for maximum conducted interference.
- c. The frequency range from 150kHz to 30MHz was searched. Emission levels under (Limit - 20dB) was not recorded.

NOTE: All modes of operation were investigated and the worst-case emissions are reported.

4.2.4 DEVIATION FROM TEST STANDARD

No deviation.

4.2.5 TEST SETUP

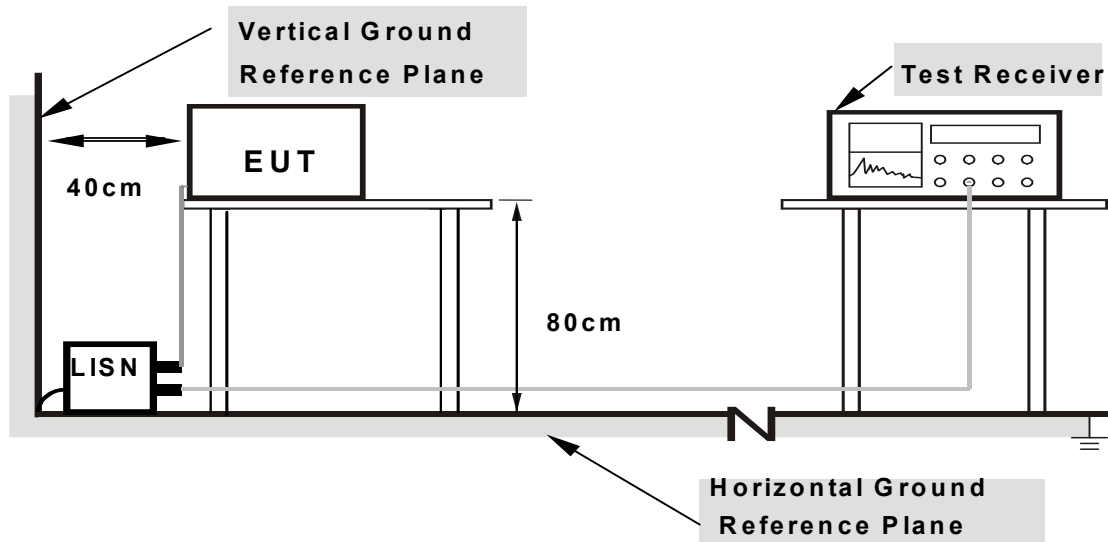

Note: 1.Support units were connected to second LISN.

2.Both of LISNs (AMN) are 80 cm from EUT and at least 80 from other units and other metal planes

For the actual test configuration, please refer to the attached file (Test Setup Photo).

4.2.6 EUT OPERATING CONDITIONS

Same as item 4.1.6.

4.2.7 TEST RESULTS

CONDUCTED WORST CASE DATA: 8DPSK

PHASE	Line 1	6dB BANDWIDTH	9kHz
-------	--------	---------------	------

No	Freq. [MHz]	Corr. Factor (dB)	Reading Value		Emission Level		Limit		Margin	
			[dB (uV)]		[dB (uV)]		[dB (uV)]		(dB)	
			Q.P.	AV.	Q.P.	AV.	Q.P.	AV.	Q.P.	AV.
1	0.15000	0.15	47.82	28.40	47.97	28.55	66.00	56.00	-18.03	-27.45
2	0.17734	0.15	44.12	28.21	44.27	28.36	64.61	54.61	-20.34	-26.25
3	0.20859	0.15	38.88	22.42	39.03	22.57	63.26	53.26	-24.23	-30.69
4	3.57422	0.39	21.01	13.25	21.40	13.64	56.00	46.00	-34.60	-32.36
5	11.38672	0.80	25.01	17.58	25.81	18.38	60.00	50.00	-34.19	-31.62
6	24.57031	1.38	23.80	17.68	25.18	19.06	60.00	50.00	-34.82	-30.94

REMARKS:

1. Q.P. and AV. are abbreviations of quasi-peak and average individually.
2. The emission levels of other frequencies were very low against the limit.
3. Margin value = Emission level - Limit value
4. Correction factor = Insertion loss + Cable loss
5. Emission Level = Correction Factor + Reading Value.

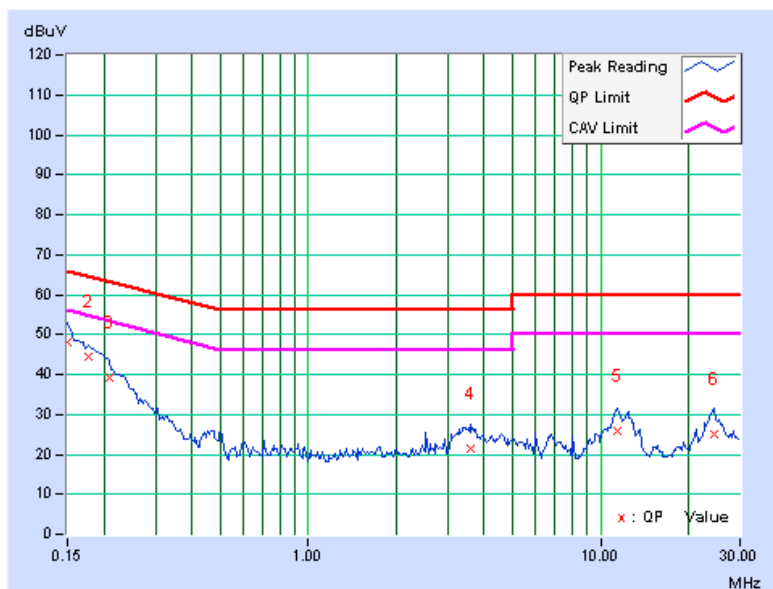



A D T

PHASE	Line 2	6dB BANDWIDTH	9kHz
-------	--------	---------------	------

No	Freq. [MHz]	Corr. Factor (dB)	Reading Value		Emission Level		Limit		Margin	
			[dB (uV)]		[dB (uV)]		[dB (uV)]		(dB)	
			Q.P.	AV.	Q.P.	AV.	Q.P.	AV.	Q.P.	AV.
1	0.15000	0.14	48.00	28.96	48.14	29.10	66.00	56.00	-17.86	-26.90
2	0.16953	0.14	45.87	28.41	46.01	28.55	64.98	54.98	-18.97	-26.43
3	0.20859	0.15	38.79	21.66	38.94	21.81	63.26	53.26	-24.32	-31.45
4	3.66016	0.37	20.75	14.16	21.12	14.53	56.00	46.00	-34.88	-31.47
5	12.28125	0.69	24.52	18.05	25.21	18.74	60.00	50.00	-34.79	-31.26
6	24.11328	0.98	23.34	17.22	24.32	18.20	60.00	50.00	-35.68	-31.80

REMARKS:

1. Q.P. and AV. are abbreviations of quasi-peak and average individually.
2. The emission levels of other frequencies were very low against the limit.
3. Margin value = Emission level - Limit value
4. Correction factor = Insertion loss + Cable loss
5. Emission Level = Correction Factor + Reading Value.

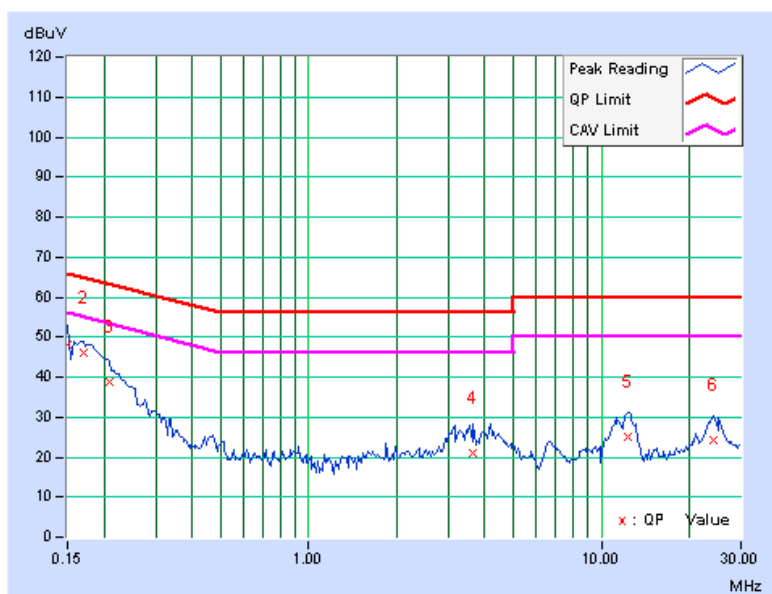

5. TEST TYPES AND RESULTS (FOR Bluetooth LE 4.0)

5.1 RADIATED EMISSION AND BANDEDGE MEASUREMENT

5.1.1 LIMITS OF RADIATED EMISSION AND BANDEDGE MEASUREMENT

Same as item 4.1.1.

5.1.2 TEST INSTRUMENTS

Same as item 4.1.2.

5.1.3 TEST PROCEDURES

Same as item 4.1.3.

5.1.4 DEVIATION FROM TEST STANDARD

No deviation.

5.1.5 TEST SETUP

Same as item 4.1.5.

5.1.6 EUT OPERATING CONDITIONS

Same as item 4.1.6.



5.1.7 TEST RESULTS

ABOVE 1GHz DATA

EUT TEST CONDITION		MEASUREMENT DETAIL	
CHANNEL	Channel 0	FREQUENCY RANGE	1 ~ 25GHz
INPUT POWER (SYSTEM)	120Vac, 60 Hz	DETECTOR FUNCTION	Peak (PK) Average (AV)
ENVIRONMENTAL CONDITIONS	26deg. C, 82%RH	TESTED BY	Nick Chen

ANTENNA POLARITY & TEST DISTANCE: HORIZONTAL AT 3 M								
NO.	FREQ. (MHz)	EMISSION LEVEL (dBuV/m)	LIMIT (dBuV/m)	MARGIN (dB)	ANTENNA HEIGHT (m)	TABLE ANGLE (Degree)	RAW VALUE (dBuV)	CORRECTION FACTOR (dB/m)
1	2390.00	55.8 PK	74.0	-18.2	1.05 H	324	25.55	30.24
2	2390.00	44.9 AV	54.0	-9.1	1.05 H	324	14.63	30.24
3	2400.00	41.7 PK	74.0	-32.3	1.05 H	324	11.38	30.29
4	2400.00	37.8 AV	54.0	-16.2	1.05 H	324	7.52	30.29
5	*2402.00	100.2 PK			1.05 H	324	69.87	30.30
6	*2402.00	96.3 AV			1.05 H	324	66.01	30.30
7	3202.00	45.4 PK	74.0	-28.6	1.08 H	6	12.17	33.23
8	3202.00	38.2 AV	54.0	-15.8	1.08 H	6	4.99	33.23
9	4804.00	44.9 PK	74.0	-29.1	1.00 H	332	8.34	36.59
10	4804.00	31.9 AV	54.0	-22.1	1.00 H	332	-4.73	36.59

REMARKS:

1. Emission level (dBuV/m) = Raw Value (dBuV) + Correction Factor (dB/m).
2. Correction Factor (dB/m) = Antenna Factor (dB/m) + Cable Factor (dB).
3. The other emission levels were very low against the limit.
4. Margin value = Emission level – Limit value.
5. “ * “: Fundamental frequency.



A D T

EUT TEST CONDITION		MEASUREMENT DETAIL	
CHANNEL	Channel 0	FREQUENCY RANGE	1 ~ 25GHz
INPUT POWER (SYSTEM)	120Vac, 60 Hz	DETECTOR FUNCTION	Peak (PK) Average (AV)
ENVIRONMENTAL CONDITIONS	26deg. C, 82%RH	TESTED BY	Nick Chen

ANTENNA POLARITY & TEST DISTANCE: VERTICAL AT 3 M								
NO.	FREQ. (MHz)	EMISSION LEVEL (dBuV/m)	LIMIT (dBuV/m)	MARGIN (dB)	ANTENNA HEIGHT (m)	TABLE ANGLE (Degree)	RAW VALUE (dBuV)	CORRECTION FACTOR (dB/m)
1	2390.00	55.3 PK	74.0	-18.8	1.05 V	296	25.01	30.24
2	2390.00	44.3 AV	54.0	-9.7	1.05 V	296	14.03	30.24
3	2400.00	40.1 PK	74.0	-33.9	1.05 V	296	9.82	30.29
4	2400.00	36.7 AV	54.0	-17.3	1.05 V	296	6.36	30.29
5	*2402.00	98.6 PK			1.05 V	296	68.31	30.30
6	*2402.00	95.2 AV			1.05 V	296	64.85	30.30
7	3202.00	44.5 PK	74.0	-29.5	1.00 V	205	11.31	33.23
8	3202.00	35.0 AV	54.0	-19.0	1.00 V	205	1.72	33.23
9	4804.00	45.6 PK	74.0	-28.4	1.07 V	254	9.03	36.59
10	4804.00	32.8 AV	54.0	-21.2	1.07 V	254	-3.78	36.59

REMARKS:

1. Emission level (dBuV/m) = Raw Value (dBuV) + Correction Factor (dB/m).
2. Correction Factor (dB/m) = Antenna Factor (dB/m) + Cable Factor (dB).
3. The other emission levels were very low against the limit.
4. Margin value = Emission level – Limit value.
5. “ * “: Fundamental frequency.



A D T

BELOW 1GHz WORST-CASE DATA

EUT TEST CONDITION		MEASUREMENT DETAIL	
CHANNEL	Channel 0	FREQUENCY RANGE	Below 1000MHz
INPUT POWER (SYSTEM)	120Vac, 60 Hz	DETECTOR FUNCTION	Quasi-Peak
ENVIRONMENTAL CONDITIONS	28deg. C, 82%RH	TESTED BY	Nick Chen

ANTENNA POLARITY & TEST DISTANCE: HORIZONTAL AT 3 M

NO.	FREQ. (MHz)	EMISSION LEVEL (dBuV/m)	LIMIT (dBuV/m)	MARGIN (dB)	ANTENNA HEIGHT (m)	TABLE ANGLE (Degree)	RAW VALUE (dBuV)	CORRECTION FACTOR (dB/m)
1	93.05	38.3 QP	43.5	-5.2	1.99 H	60	29.53	8.76
2	262.80	32.7 QP	46.0	-13.3	1.00 H	216	18.60	14.07
3	332.32	34.9 QP	46.0	-11.1	1.00 H	10	18.37	16.52
4	379.20	32.6 QP	46.0	-13.5	1.00 H	292	14.83	17.72
5	396.98	33.3 QP	46.0	-12.8	1.00 H	299	15.10	18.15
6	445.48	32.7 QP	46.0	-13.3	1.99 H	285	13.11	19.63
7	476.20	36.1 QP	46.0	-9.9	1.99 H	300	15.59	20.48
8	489.13	35.1 QP	46.0	-10.9	1.49 H	283	14.24	20.83
9	524.70	32.2 QP	46.0	-13.8	1.49 H	264	10.59	21.63
10	689.60	32.0 QP	46.0	-14.0	1.00 H	261	7.54	24.48

ANTENNA POLARITY & TEST DISTANCE: VERTICAL AT 3 M

NO.	FREQ. (MHz)	EMISSION LEVEL (dBuV/m)	LIMIT (dBuV/m)	MARGIN (dB)	ANTENNA HEIGHT (m)	TABLE ANGLE (Degree)	RAW VALUE (dBuV)	CORRECTION FACTOR (dB/m)
1	31.62	33.6 QP	40.0	-6.4	1.00 V	10	21.70	11.86
2	93.05	28.9 QP	43.5	-14.6	1.00 V	327	20.15	8.76
3	332.32	31.5 QP	46.0	-14.5	1.25 V	9	14.95	16.52
4	445.48	28.2 QP	46.0	-17.8	1.00 V	55	8.57	19.63
5	476.20	31.8 QP	46.0	-14.2	1.00 V	66	11.35	20.48
6	489.13	29.9 QP	46.0	-16.1	1.00 V	84	9.07	20.83
7	671.82	28.2 QP	46.0	-17.8	1.00 V	45	3.94	24.26
8	689.60	28.5 QP	46.0	-17.5	1.00 V	45	4.02	24.48
9	920.78	28.1 QP	46.0	-17.9	1.50 V	19	-0.05	28.13

REMARKS:

1. Emission level (dBuV/m) = Raw Value (dBuV) + Correction Factor (dB/m).
2. Correction Factor (dB/m) = Antenna Factor (dB/m) + Cable Factor (dB).
3. The other emission levels were very low against the limit.
4. Margin value = Emission level – Limit value.

5.2 CONDUCTED EMISSION MEASUREMENT

5.2.1 LIMITS OF CONDUCTED EMISSION MEASUREMENT

Same as item 4.2.1.

5.2.2 TEST INSTRUMENTS

Same as item 4.2.2.

5.2.3 TEST PROCEDURES

Same as item 4.2.3.

5.2.4 DEVIATION FROM TEST STANDARD

No deviation.

5.2.5 TEST SETUP

Same as item 4.2.5.

5.2.6 EUT OPERATING CONDITIONS

Same as item 4.2.6.

5.2.7 TEST RESULTS

CONDUCTED WORST CASE DATA:

PHASE	Line 1	6dB BANDWIDTH	9kHz
--------------	--------	----------------------	------

No	Freq. [MHz]	Corr. Factor (dB)	Reading Value [dB (uV)]		Emission Level [dB (uV)]		Limit [dB (uV)]		Margin (dB)	
			Q.P.	AV.	Q.P.	AV.	Q.P.	AV.	Q.P.	AV.
			1	0.15000	0.15	47.39	27.44	47.54	27.59	66.00
2	0.16953	0.15	45.83	28.63	45.98	28.78	64.98	54.98	-19.00	-26.20
3	0.22031	0.15	36.68	20.96	36.83	21.11	62.81	52.81	-25.97	-31.69
4	3.19531	0.37	21.11	14.25	21.48	14.62	56.00	46.00	-34.52	-31.38
5	11.48828	0.81	24.43	16.25	25.24	17.06	60.00	50.00	-34.76	-32.94
6	24.50781	1.38	23.14	16.83	24.52	18.21	60.00	50.00	-35.48	-31.79

REMARKS:

1. Q.P. and AV. are abbreviations of quasi-peak and average individually.
2. The emission levels of other frequencies were very low against the limit.
3. Margin value = Emission level - Limit value
4. Correction factor = Insertion loss + Cable loss
5. Emission Level = Correction Factor + Reading Value.

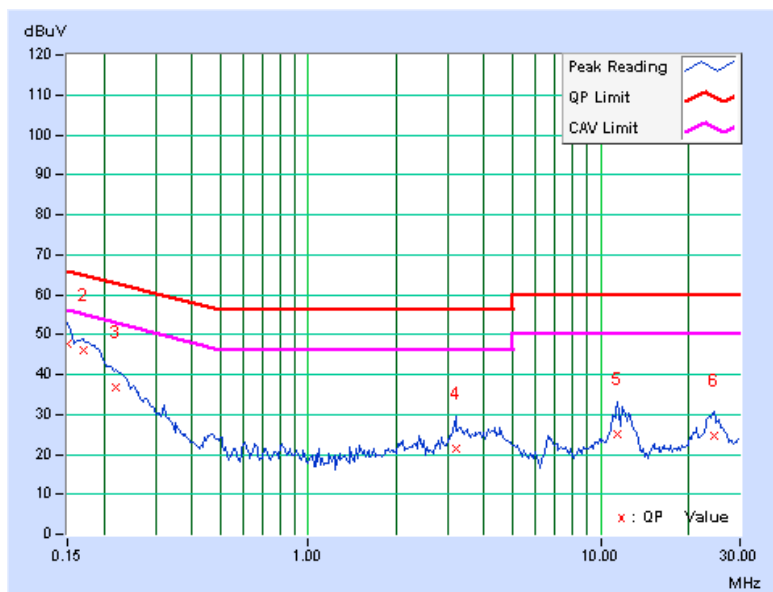



A D T

PHASE	Line 2	6dB BANDWIDTH	9kHz
-------	--------	---------------	------

No	Freq. [MHz]	Corr. Factor (dB)	Reading Value		Emission Level		Limit		Margin	
			[dB (uV)]		[dB (uV)]		[dB (uV)]		(dB)	
			Q.P.	AV.	Q.P.	AV.	Q.P.	AV.	Q.P.	AV.
1	0.15000	0.14	48.25	29.81	48.39	29.95	66.00	56.00	-17.61	-26.05
2	0.16562	0.14	43.30	24.46	43.44	24.60	65.18	55.18	-21.73	-30.57
3	0.22812	0.16	37.68	21.70	37.84	21.86	62.52	52.52	-24.68	-30.66
4	3.12500	0.34	21.01	13.95	21.35	14.29	56.00	46.00	-34.65	-31.71
5	11.41016	0.66	24.79	16.57	25.45	17.23	60.00	50.00	-34.55	-32.77
6	24.01563	0.98	23.35	17.31	24.33	18.29	60.00	50.00	-35.67	-31.71

REMARKS:

1. Q.P. and AV. are abbreviations of quasi-peak and average individually.
2. The emission levels of other frequencies were very low against the limit.
3. Margin value = Emission level - Limit value
4. Correction factor = Insertion loss + Cable loss
5. Emission Level = Correction Factor + Reading Value.

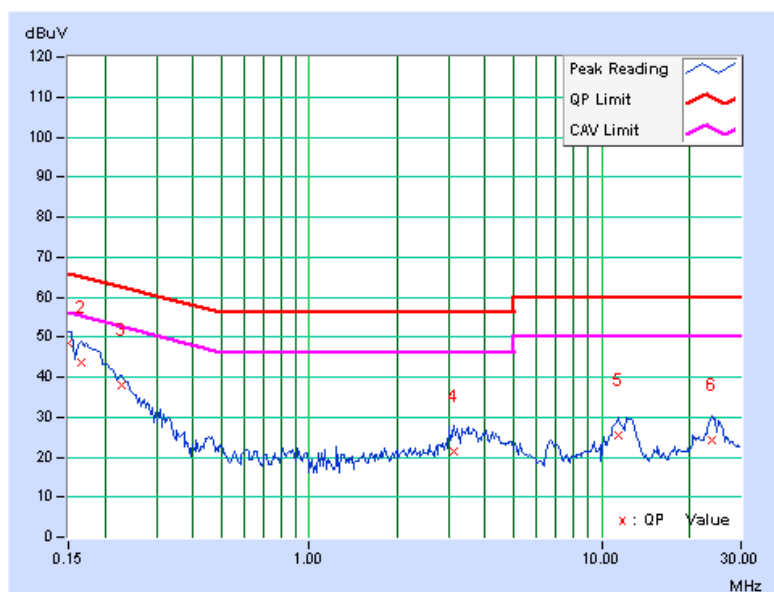

6. PHOTOGRAPHS OF THE TEST CONFIGURATION

Please refer to the attached file (Test Setup Photo).



7. INFORMATION ON THE TESTING LABORATORIES

We, Bureau Veritas Consumer Products Services (H.K.) Ltd., Taoyuan Branch, were founded in 1988 to provide our best service in EMC, Radio, Telecom and Safety consultation. Our laboratories are accredited and approved according to ISO/IEC 17025.

If you have any comments, please feel free to contact us at the following:

Linko EMC/RF Lab:

Tel: 886-2-26052180

Fax: 886-2-26051924

Hsin Chu EMC/RF Lab:

Tel: 886-3-5935343

Fax: 886-3-5935342

Hwa Ya EMC/RF/Safety Telecom Lab:

Tel: 886-3-3183232

Fax: 886-3-3270892

Email: service.adt@tw.bureauveritas.com

Web Site: www.adt.com.tw

The address and road map of all our labs can be found in our web site also.

8. APPENDIX A - MODIFICATIONS RECORDERS FOR ENGINEERING CHANGES TO THE EUT BY THE LAB

No modifications were made to the EUT by the lab during the test.

--- END ---