



FCC TEST REPORT (15.247)

REPORT NO.: RF120503C13
MODEL NO.: TP00042A
FCC ID: GKR-TP00042AHB
RECEIVED: May 03, 2012
TESTED: May 09 ~ May 31, 2012
ISSUED: Jul. 23, 2012

APPLICANT: COMPAL ELECTRONICS, INC.

ADDRESS: No.581, Ruiguang Rd., Neihu District, Taipei City
11492, Taiwan (R.O.C.)

ISSUED BY: Bureau Veritas Consumer Products Services
(H.K.) Ltd., Taoyuan Branch

LAB ADDRESS: No. 47, 14th Ling, Chia Pau Vil., Lin Kou Dist.,
New Taipei City, Taiwan (R.O.C.)

TEST LOCATION: No. 19, Hwa Ya 2nd Rd, Wen Hwa Tsuen, Kwei
Shan Hsiang, Taoyuan Hsien 333, Taiwan, R.O.C.

This report should not be used by the client to claim product certification, approval, or endorsement by TAF or any government agencies.



This report is for your exclusive use. Any copying or replication of this report to or for any other person or entity, or use of our name or trademark, is permitted only with our prior written permission. This report sets forth our findings solely with respect to the test samples identified herein. The results set forth in this report are not indicative or representative of the quality or characteristics of the lot from which a test sample was taken or any similar or identical product unless specifically and expressly noted. Our report includes all of the tests requested by you and the results thereof based upon the information that you provided to us. You have 60 days from date of issuance of this report to notify us of any material error or omission caused by our negligence, provided, however, that such notice shall be in writing and shall specifically address the issue you wish to raise. A failure to raise such issue within the prescribed time shall constitute your unqualified acceptance of the completeness of this report, the tests conducted and the correctness of the report contents. Unless specific mention, the uncertainty of measurement has been explicitly taken into account to declare the compliance or non-compliance to the specification.

TABLE OF CONTENTS

RELEASE CONTROL RECORD	5
1. CERTIFICATION.....	6
2. SUMMARY OF TEST RESULTS.....	7
2.1 MEASUREMENT UNCERTAINTY	7
3. GENERAL INFORMATION	8
3.1 GENERAL DESCRIPTION OF EUT.....	8
3.2 DESCRIPTION OF TEST MODES.....	10
3.2.1 TEST MODE APPLICABILITY AND TESTED CHANNEL DETAIL.....	11
3.3 DESCRIPTION OF SUPPORT UNITS	15
3.3.1 CONFIGURATION OF SYSTEM UNDER TEST	15
3.4 GENERAL DESCRIPTION OF APPLIED STANDARDS.....	15
4. TEST TYPES AND RESULTS (FOR 2.4GHz BAND)	16
4.1 RADIATED EMISSION AND BANDEDGE MEASUREMENT	16
4.1.1 LIMITS OF RADIATED EMISSION AND BANDEDGE MEASUREMENT	16
4.1.2 TEST INSTRUMENTS	17
4.1.3 TEST PROCEDURES.....	18
4.1.4 DEVIATION FROM TEST STANDARD	18
4.1.5 TEST SETUP.....	19
4.1.6 EUT OPERATING CONDITIONS.....	19
4.1.7 TEST RESULTS.....	20
4.2 CONDUCTED EMISSION MEASUREMENT	39
4.2.1 LIMITS OF CONDUCTED EMISSION MEASUREMENT	39
4.2.2 TEST INSTRUMENTS	39
4.2.3 TEST PROCEDURES.....	40
4.2.4 DEVIATION FROM TEST STANDARD	40
4.2.5 TEST SETUP.....	40
4.2.6 EUT OPERATING CONDITIONS.....	40
4.2.7 TEST RESULTS.....	41
4.3 6dB BANDWIDTH MEASUREMENT	43
4.3.1 LIMITS OF 6dB BANDWIDTH MEASUREMENT	43
4.3.2 TEST SETUP.....	43
4.3.3 TEST INSTRUMENTS	43
4.3.4 TEST PROCEDURE	43
4.3.5 DEVIATION FROM TEST STANDARD	43
4.3.6 EUT OPERATING CONDITIONS.....	43
4.3.7 TEST RESULTS.....	44
4.4 CONDUCTED OUTPUT POWER	46
4.4.1 LIMITS OF CONDUCTED OUTPUT POWER MEASUREMENT.....	46
4.4.2 TEST SETUP.....	46
4.4.3 TEST INSTRUMENTS	46
4.4.4 TEST PROCEDURES.....	46
4.4.5 DEVIATION FROM TEST STANDARD	46
4.4.6 EUT OPERATING CONDITIONS.....	46
4.4.7 TEST RESULTS.....	47
4.5 POWER SPECTRAL DENSITY MEASUREMENT	49
4.5.1 LIMITS OF POWER SPECTRAL DENSITY MEASUREMENT.....	49



4.5.2	TEST SETUP	49
4.5.3	TEST INSTRUMENTS	49
4.5.4	TEST PROCEDURE	49
4.5.5	DEVIATION FROM TEST STANDARD	49
4.5.6	EUT OPERATING CONDITION	49
4.5.7	TEST RESULTS.....	50
4.6	CONDUCTED OUT OF BAND EMISSION MEASUREMENT	52
4.6.1	LIMITS OF CONDUCTED OUT OF BAND EMISSION MEASUREMENT	52
4.6.2	TEST SETUP	52
4.6.3	TEST INSTRUMENTS	52
4.6.4	TEST PROCEDURE	52
4.6.5	DEVIATION FROM TEST STANDARD	53
4.6.6	EUT OPERATING CONDITION	53
4.6.7	TEST RESULTS.....	53
4.6.8	TEST RESULTS.....	54
5.	TEST TYPES AND RESULTS (FOR 5.0GHz BAND)	60
5.1	RADIATED EMISSION MEASUREMENT	60
5.1.1	LIMITS OF RADIATED EMISSION MEASUREMENT	60
5.1.2	TEST INSTRUMENTS	61
5.1.3	TEST PROCEDURES.....	61
5.1.4	DEVIATION FROM TEST STANDARD	61
5.1.5	TEST SETUP	61
5.1.6	EUT OPERATING CONDITIONS	61
5.1.7	TEST RESULTS.....	62
5.2	CONDUCTED EMISSION MEASUREMENT	76
5.2.1	LIMITS OF CONDUCTED EMISSION MEASUREMENT	76
5.2.2	TEST INSTRUMENTS	76
5.2.3	TEST PROCEDURES.....	76
5.2.4	DEVIATION FROM TEST STANDARD	76
5.2.5	TEST SETUP	76
5.2.6	EUT OPERATING CONDITIONS.....	76
5.2.7	TEST RESULTS.....	77
5.3	6dB BANDWIDTH MEASUREMENT	79
5.3.1	LIMITS OF 6dB BANDWIDTH MEASUREMENT	79
5.3.2	TEST SETUP	79
5.3.3	TEST INSTRUMENTS	79
5.3.4	TEST PROCEDURE	79
5.3.5	DEVIATION FROM TEST STANDARD	79
5.3.6	EUT OPERATING CONDITIONS.....	79
5.3.7	TEST RESULTS.....	80
5.4	CONDUCTED OUTPUT POWER	82
5.4.1	LIMITS OF CONDUCTED OUTPUT POWER MEASUREMENT.....	82
5.4.2	TEST SETUP	82
5.4.3	INSTRUMENTS	82
5.4.4	TEST PROCEDURES.....	82
5.4.5	DEVIATION FROM TEST STANDARD	82
5.4.6	EUT OPERATING CONDITIONS.....	82
5.4.7	TEST RESULTS.....	83
5.5	POWER SPECTRAL DENSITY MEASUREMENT	84
5.5.1	LIMITS OF POWER SPECTRAL DENSITY MEASUREMENT	84
5.5.2	TEST SETUP	84



A D T

5.5.3	TEST INSTRUMENTS	84
5.5.4	TEST PROCEDURE	84
5.5.5	DEVIATION FROM TEST STANDARD	84
5.5.6	EUT OPERATING CONDITION	84
5.5.7	TEST RESULTS.....	85
5.6	CONDUCTED OUT OF BAND EMISSION MEASUREMENT	86
5.6.1	LIMITS OF CONDUCTED OUT OF BAND EMISSION MEASUREMENT	86
5.6.2	TEST SETUP	86
5.6.3	TEST INSTRUMENTS	86
5.6.4	TEST PROCEDURE	86
5.6.5	DEVIATION FROM TEST STANDARD	86
5.6.6	EUT OPERATING CONDITION	86
5.6.7	TEST RESULTS.....	86
6.	PHOTOGRAPHS OF THE TEST CONFIGURATION	92
7.	INFORMATION ON THE TESTING LABORATORIES	93
8.	APPENDIX A - MODIFICATIONS RECORDERS FOR ENGINEERING CHANGES TO THE EUT BY THE LAB	94



A D T

RELEASE CONTROL RECORD

ISSUE NO.	REASON FOR CHANGE	DATE ISSUED
RF120503C13	Original release	Jul. 23, 2012



1. CERTIFICATION

PRODUCT: Convertible Tablet Computer
MODEL NO.: TP00042A
BRAND: Lenovo
APPLICANT: COMPAL ELECTRONICS, INC.
TESTED: May 09 ~ May 31, 2012
TEST SAMPLE: ENGINEERING SAMPLE
STANDARDS: **FCC Part 15, Subpart C (Section 15.247)**
ANSI C63.10-2009

The above equipment (model: TP00042A) has been tested by **Bureau Veritas Consumer Products Services (H.K.) Ltd., Taoyuan Branch**, and found compliance with the requirement of the above standards. The test record, data evaluation & Equipment Under Test (EUT) configurations represented herein are true and accurate accounts of the measurements of the sample's EMC characteristics under the conditions specified in this report.

PREPARED BY : Ivonne Wu , **DATE** : Jul. 23, 2012
Ivonne Wu / Senior Specialist

APPROVED BY : Gary Chang , **DATE** : Jul. 23, 2012
Gary Chang / Technical Manager

2. SUMMARY OF TEST RESULTS

The EUT has been tested according to the following specifications:

APPLIED STANDARD: FCC PART 15, SUBPART C (SECTION 15.247)			
STANDARD SECTION	TEST TYPE	RESULT	REMARK
15.207	AC Power Conducted Emission	PASS	Meet the requirement of limit. Minimum passing margin is -18.49dB at 0.38047MHz.
15.247(d) 15.209	Radiated Emissions	PASS	Meet the requirement of limit. Minimum passing margin is -1.1dB at 2483.50MHz.
15.247(d)	Band Edge Measurement	PASS	Meet the requirement of limit.
15.247(a)(2)	6dB bandwidth	PASS	Meet the requirement of limit.
15.247(b)	Conducted power	PASS	Meet the requirement of limit.
15.247(e)	Power Spectral Density	PASS	Meet the requirement of limit.
15.203	Antenna Requirement	PASS	Antenna connector is I-PEX

2.1 MEASUREMENT UNCERTAINTY

Where relevant, the following measurement uncertainty levels have been estimated for tests performed on the EUT as specified in CISPR 16-4-2:

MEASUREMENT	FREQUENCY	UNCERTAINTY
Conducted emissions	9kHz~30MHz	2.44 dB
Radiated emissions	30MHz ~ 200MHz	2.93 dB
	200MHz ~1000MHz	2.95 dB
	1GHz ~ 18GHz	2.26 dB
	18GHz ~ 40GHz	1.94 dB

This uncertainty represents an expanded uncertainty expressed at approximately the 95% confidence level using a coverage factor of $k = 2$.



3. GENERAL INFORMATION

3.1 GENERAL DESCRIPTION OF EUT

EUT	Convertible Tablet Computer
MODEL NO.	TP00042A
MODULE MODEL NO.	BCM943228HMB
POWER SUPPLY	20Vdc from adapter
MODULATION TYPE	CCK, DQPSK, DBPSK for DSSS 64QAM, 16QAM, QPSK, BPSK for OFDM
MODULATION TECHNOLOGY	DSSS, OFDM
TRANSFER RATE	802.11b: 11.0/ 5.5/ 2.0/ 1.0Mbps 802.11g: 54.0/ 48.0/ 36.0/ 24.0/ 18.0/ 12.0/ 9.0/ 6.0Mbps 802.11a: 54.0/ 48.0/ 36.0/ 24.0/ 18.0/ 12.0/ 9.0/ 6.0Mbps 802.11n: up to 300.0Mbps
OPERATING FREQUENCY	2.4GHz: 2412 ~ 2462MHz 5.0GHz: 5745 ~ 5825MHz
NUMBER OF CHANNEL	2.4GHz: 11 for 802.11b, 802.11g, 802.11n (20MHz) 7 for 802.11n (40MHz) 5.0GHz: 5 for 802.11a, 802.11n (20MHz) 2 for 802.11n (40MHz)
OUTPUT POWER	395.5mW for 2412 ~ 2462MHz 337.8mW for 5745 ~ 5825MHz
ANTENNA TYPE	Refer to NOTE as below
ANTENNA CONNECTOR	NA
DATA CABLE	NA
I/O PORTS	Refer to user's manual
ACCESSORY DEVICES	Adapter

NOTE:

1. The EUT incorporates a MIMO function. Physically, the EUT provides two completed transmitters and two receivers.

MODULATION MODE	TX FUNCTION
802.11b	1TX
802.11g	1TX
802.11a	1TX
802.11n (20MHz)	1TX / 2TX
802.11n (40MHz)	1TX / 2TX

2. The antenna information is listed as below.

JPC Antenna		
Antenna Type	PIFA	
Manufacturer	Jess-Link Product Co., LTD	
Model Name	Antenna Type	Model name
	WLAN MAIN L	PANT11A00034-1
	WLAN AUX R	PANT11A00035-1
Antenna Gain	WLAN Main	
	2.4~2.4835 GHz	-2.03
	5.15~5.25 GHz	-0.59
	5.25~5.35 GHz	-1.56
	5.47~5.725 GHz	0.21
	5.725~5.85 GHz	0.45
	WLAN Aux.	
	2.4~2.4835 GHz	-3.47
	5.15~5.25 GHz	-0.13
	5.25~5.35 GHz	-0.07
	5.47~5.725 GHz	-0.08
5.725~5.85 GHz	0.42	

3. The EUT consumes power from the following adapter.

ADAPTER	
BRAND:	Lenovo
MODEL:	45N0185
INPUT:	100-240Vac, 50-60Hz, 1.5A
OUTPUT:	20Vdc, 3.25A
POWER LINE:	1.8m non-shielded cable with one core

4. The above EUT information is declared by manufacturer and for more detailed features description, please refer to the manufacturer's specifications or user's manual.

3.2 DESCRIPTION OF TEST MODES

FOR 2.4GHz:

11 channels are provided for 802.11b, 802.11g and 802.11n (20MHz):

CHANNEL	FREQUENCY	CHANNEL	FREQUENCY
1	2412MHz	7	2442MHz
2	2417MHz	8	2447MHz
3	2422MHz	9	2452MHz
4	2427MHz	10	2457MHz
5	2432MHz	11	2462MHz
6	2437MHz		

7 channels are provided for 802.11n (40MHz):

CHANNEL	FREQUENCY	CHANNEL	FREQUENCY
3	2422MHz	7	2442MHz
4	2427MHz	8	2447MHz
5	2432MHz	9	2452MHz
6	2437MHz		

FOR 5.0GHz (5745 ~ 5825MHz):

5 channels are provided for 802.11a, 802.11n (20MHz):

CHANNEL	FREQUENCY	CHANNEL	FREQUENCY
149	5745MHz	161	5805MHz
153	5765MHz	165	5825MHz
157	5785MHz		

2 channels are provided for 802.11n (40MHz):

CHANNEL	FREQUENCY	CHANNEL	FREQUENCY
151	5755MHz	159	5795MHz

3.2.1 TEST MODE APPLICABILITY AND TESTED CHANNEL DETAIL

FOR 2.4GHz:

EUT CONFIGURE MODE	APPLICABLE TO				DESCRIPTION
	RE \geq 1G	RE<1G	PLC	APCM	
-	√	√	√	√	-

Where **RE \geq 1G**: Radiated Emission above 1GHz **RE<1G**: Radiated Emission below 1GHz
PLC: Power Line Conducted Emission **APCM**: Antenna Port Conducted Measurement

NOTE:

The EUT had been pre-tested on the positioned of each 3 axis. The worst case was found when positioned on **X-plane**.

RADIATED EMISSION TEST (ABOVE 1GHz):

- Pre-Scan has been conducted to determine the worst-case mode from all possible combinations between available modulations, data rates and antenna ports (if EUT with antenna diversity architecture).
- Following channel(s) was (were) selected for the final test as listed below.

MODE	AVAILABLE CHANNEL	TESTED CHANNEL	MODULATION TECHNOLOGY	MODULATION TYPE	DATA RATE (Mbps)	TX Function
802.11b	1 to 11	1, 6, 11	DSSS	DBPSK	1.0	1TX
802.11g	1 to 11	1, 6, 11	OFDM	BPSK	6.0	1TX
802.11n (20MHz)	1 to 11	1, 6, 11	OFDM	BPSK	7.2	1TX
802.11n (40MHz)	3 to 9	3, 6, 9	OFDM	BPSK	15.0	1TX
802.11n (20MHz)	1 to 11	1, 6, 11	OFDM	BPSK	14.4	2TX
802.11n (40MHz)	3 to 9	3, 6, 9	OFDM	BPSK	30.0	2TX

RADIATED EMISSION TEST (BELOW 1GHz):

- Pre-Scan has been conducted to determine the worst-case mode from all possible combinations between available modulations, data rates and antenna ports (if EUT with antenna diversity architecture).
- Following channel(s) was (were) selected for the final test as listed below.

MODE	AVAILABLE CHANNEL	TESTED CHANNEL	MODULATION TECHNOLOGY	MODULATION TYPE	DATA RATE (Mbps)	TX Function
802.11n (20MHz)	1 to 11	6	OFDM	BPSK	14.4	2TX

POWER LINE CONDUCTED EMISSION TEST:

- Pre-Scan has been conducted to determine the worst-case mode from all possible combinations between available modulations, data rates and antenna ports (if EUT with antenna diversity architecture).
- Following channel(s) was (were) selected for the final test as listed below.

MODE	AVAILABLE CHANNEL	TESTED CHANNEL	MODULATION TECHNOLOGY	MODULATION TYPE	DATA RATE (Mbps)	TX Function
802.11n (20MHz)	1 to 11	6	OFDM	BPSK	14.4	2TX



BANDEDGE MEASUREMENT:

- Pre-Scan has been conducted to determine the worst-case mode from all possible combinations between available modulations, data rates and antenna ports (if EUT with antenna diversity architecture).
- Following channel(s) was (were) selected for the final test as listed below.

MODE	AVAILABLE CHANNEL	TESTED CHANNEL	MODULATION TECHNOLOGY	MODULATION TYPE	DATA RATE (Mbps)	TX Function
802.11b	1 to 11	1, 11	DSSS	DBPSK	1.0	1TX
802.11g	1 to 11	1, 11	OFDM	BPSK	6.0	1TX
802.11n (20MHz)	1 to 11	1, 11	OFDM	BPSK	7.2	1TX
802.11n (40MHz)	3 to 9	3, 9	OFDM	BPSK	15.0	1TX
802.11n (20MHz)	1 to 11	1, 11	OFDM	BPSK	14.4	2TX
802.11n (40MHz)	3 to 9	3, 9	OFDM	BPSK	30.0	2TX

ANTENNA PORT CONDUCTED MEASUREMENT:

- This item includes all test value of each mode, but only includes spectrum plot of worst value of each mode.
- Pre-Scan has been conducted to determine the worst-case mode from all possible combinations between available modulations, data rates and antenna ports (if EUT with antenna diversity architecture).
- Following channel(s) was (were) selected for the final test as listed below.

MODE	AVAILABLE CHANNEL	TESTED CHANNEL	MODULATION TECHNOLOGY	MODULATION TYPE	DATA RATE (Mbps)	TX Function
802.11b	1 to 11	1, 6, 11	DSSS	DBPSK	1.0	1TX
802.11g	1 to 11	1, 6, 11	OFDM	BPSK	6.0	1TX
802.11n (20MHz)	1 to 11	1, 6, 11	OFDM	BPSK	7.2	1TX
802.11n (40MHz)	3 to 9	3, 6, 9	OFDM	BPSK	15.0	1TX
802.11n (20MHz)	1 to 11	1, 6, 11	OFDM	BPSK	14.4	2TX
802.11n (40MHz)	3 to 9	3, 6, 9	OFDM	BPSK	30.0	2TX

TEST CONDITION:

APPLICABLE TO	ENVIRONMENTAL CONDITIONS	INPUT POWER	TESTED BY
RE≥1G	21deg. C, 68%RH	120Vac, 60Hz	Chad Lee
RE<1G	25deg. C, 89%RH	120Vac, 60Hz	Chad Lee
PLC	25deg. C, 65%RH	120Vac, 60Hz	Brad Wu
APCM	21deg. C, 65%RH	120Vac, 60Hz	Brad Wu



FOR 5.0GHz (5745 ~ 5825MHz):

EUT CONFIGURE MODE	APPLICABLE TO				DESCRIPTION
	RE≥1G	RE<1G	PLC	APCM	
-	√	√	√	√	-

Where **RE≥1G**: Radiated Emission above 1GHz **RE<1G**: Radiated Emission below 1GHz
PLC: Power Line Conducted Emission **APCM**: Antenna Port Conducted Measurement

NOTE:
The EUT had been pre-tested on the positioned of each 3 axis. The worst case was found when positioned on **X-plane**.

RADIATED EMISSION TEST (ABOVE 1GHz):

- Pre-Scan has been conducted to determine the worst-case mode from all possible combinations between available modulations, data rates and antenna ports (if EUT with antenna diversity architecture).
- Following channel(s) was (were) selected for the final test as listed below.

MODE	AVAILABLE CHANNEL	TESTED CHANNEL	MODULATION TECHNOLOGY	MODULATION TYPE	DATA RATE (Mbps)	TX Function
802.11a	149 to 165	149, 157, 165	OFDM	BPSK	6.0	1TX
802.11n (20MHz)	149 to 165	149, 157, 165	OFDM	BPSK	7.2	1TX
802.11n (40MHz)	151 to 159	151, 159	OFDM	BPSK	15.0	1TX
802.11n (20MHz)	149 to 165	149, 157, 165	OFDM	BPSK	14.4	2TX
802.11n (40MHz)	151 to 159	151, 159	OFDM	BPSK	30.0	2TX

RADIATED EMISSION TEST (BELOW 1GHz):

- Pre-Scan has been conducted to determine the worst-case mode from all possible combinations between available modulations, data rates and antenna ports (if EUT with antenna diversity architecture).
- Following channel(s) was (were) selected for the final test as listed below.

MODE	AVAILABLE CHANNEL	TESTED CHANNEL	MODULATION TECHNOLOGY	MODULATION TYPE	DATA RATE (Mbps)	TX Function
802.11n (20MHz)	149 to 165	149	OFDM	BPSK	14.4	2TX

POWER LINE CONDUCTED EMISSION TEST:

- Pre-Scan has been conducted to determine the worst-case mode from all possible combinations between available modulations, data rates and antenna ports (if EUT with antenna diversity architecture).
- Following channel(s) was (were) selected for the final test as listed below.

MODE	AVAILABLE CHANNEL	TESTED CHANNEL	MODULATION TECHNOLOGY	MODULATION TYPE	DATA RATE (Mbps)	TX Function
802.11n (20MHz)	149 to 165	149	OFDM	BPSK	14.4	2TX

BANDEDGE MEASUREMENT:

- Pre-Scan has been conducted to determine the worst-case mode from all possible combinations between available modulations, data rates and antenna ports (if EUT with antenna diversity architecture).
- Following channel(s) was (were) selected for the final test as listed below.

MODE	AVAILABLE CHANNEL	TESTED CHANNEL	MODULATION TECHNOLOGY	MODULATION TYPE	DATA RATE (Mbps)	TX Function
802.11a	149 to 165	149, 165	OFDM	BPSK	6.0	1TX
802.11n (20MHz)	149 to 165	149, 165	OFDM	BPSK	7.2	1TX
802.11n (40MHz)	151 to 159	151, 159	OFDM	BPSK	15.0	1TX
802.11n (20MHz)	149 to 165	149, 165	OFDM	BPSK	14.4	2TX
802.11n (40MHz)	151 to 159	151, 159	OFDM	BPSK	30.0	2TX

ANTENNA PORT CONDUCTED MEASUREMENT:

- This item includes all test value of each mode, but only includes spectrum plot of worst value of each mode.
- Pre-Scan has been conducted to determine the worst-case mode from all possible combinations between available modulations, data rates and antenna ports (if EUT with antenna diversity architecture).
- Following channel(s) was (were) selected for the final test as listed below.

MODE	AVAILABLE CHANNEL	TESTED CHANNEL	MODULATION TECHNOLOGY	MODULATION TYPE	DATA RATE (Mbps)	TX Function
802.11a	149 to 165	149, 157, 165	OFDM	BPSK	6.0	1TX
802.11n (20MHz)	149 to 165	149, 157, 165	OFDM	BPSK	7.2	1TX
802.11n (40MHz)	151 to 159	151, 159	OFDM	BPSK	15.0	1TX
802.11n (20MHz)	149 to 165	149, 157, 165	OFDM	BPSK	14.4	2TX
802.11n (40MHz)	151 to 159	151, 159	OFDM	BPSK	30.0	2TX

TEST CONDITION:

APPLICABLE TO	ENVIRONMENTAL CONDITIONS	INPUT POWER	TESTED BY
RE≥1G	21deg. C, 68%RH	120Vac, 60Hz	Chad Lee
RE<1G	25deg. C, 89%RH	120Vac, 60Hz	Chad Lee
PLC	25deg. C, 65%RH	120Vac, 60Hz	Brad Wu
APCM	21deg. C, 65%RH	120Vac, 60Hz	Brad Wu

3.3 DESCRIPTION OF SUPPORT UNITS

The EUT has been tested as an independent unit together with other necessary accessories or support units.

3.3.1 CONFIGURATION OF SYSTEM UNDER TEST

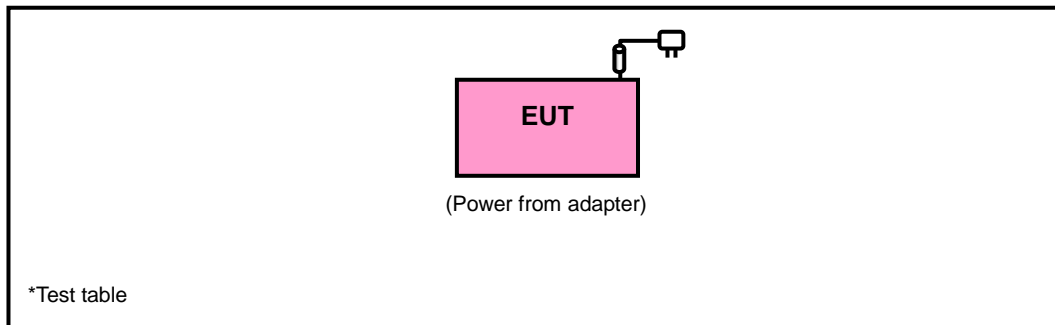

3.4 GENERAL DESCRIPTION OF APPLIED STANDARDS

The EUT is a RF Product. According to the specifications of the manufacturer, it must comply with the requirements of the following standards:

FCC Part 15, Subpart C (15.247)

ANSI C63.10-2009

KDB 558074 D01 DTS Meas Guidance v01

All test items have been performed and recorded as per the above standards.

NOTE: The EUT is also considered as a kind of computer peripheral, because the connection to computer is necessary for typical use. It has been verified to comply with the requirements of FCC Part 15, Subpart B, Class B (DoC). The test report has been issued separately.

4. TEST TYPES AND RESULTS (FOR 2.4GHz BAND)

4.1 RADIATED EMISSION AND BANDEDGE MEASUREMENT

4.1.1 LIMITS OF RADIATED EMISSION AND BANDEDGE MEASUREMENT

Radiated emissions which fall in the restricted bands must comply with the radiated emission limits specified as below table. Other emissions shall be at least 20dB below the highest level of the desired power:

FREQUENCIES (MHz)	FIELD STRENGTH (microvolts/meter)	MEASUREMENT DISTANCE (meters)
0.009 ~ 0.490	2400/F(kHz)	300
0.490 ~ 1.705	24000/F(kHz)	30
1.705 ~ 30.0	30	30
30 ~ 88	100	3
88 ~ 216	150	3
216 ~ 960	200	3
Above 960	500	3

NOTE:

1. The lower limit shall apply at the transition frequencies.
2. Emission level (dBuV/m) = 20 log Emission level (uV/m).
3. For frequencies above 1000MHz, the field strength limits are based on average detector, however, the peak field strength of any emission shall not exceed the maximum permitted average limits, specified above by more than 20dB under any condition of modulation.

4.1.2 TEST INSTRUMENTS

DESCRIPTION & MANUFACTURER	MODEL NO.	SERIAL NO.	DATE OF CALIBRATION	DUE DATE OF CALIBRATION
Test Receiver ROHDE & SCHWARZ	ESIB7	100188	May 11, 2012	May 10, 2013
Spectrum Analyzer ROHDE & SCHWARZ	FSP 40	100041	Jul. 21, 2011	Jul. 20, 2012
BILOG Antenna SCHWARZBECK	VULB9168	9168-157	Apr. 02, 2012	Apr. 01, 2013
RF signal cable Woken	8D-FB	N/A	Mar. 24, 2012	Mar. 23, 2013
HORN Antenna SCHWARZBECK	BBHA 9120 D *	9120D-405	Feb. 03, 2012	Feb. 02, 2013
HORN Antenna SCHWARZBECK	BBHA 9170	BBHA9170243	Jan. 03, 2012	Jan. 02, 2013
Loop Antenna	HFH2-Z2	100070	Jan. 31, 2012	Jan. 30, 2014
Preamplifier Agilent (Below 1GHz)	8447D	2944A10629	Oct. 29, 2011	Oct. 28, 2012
Preamplifier Agilent (Above 1GHz)	8449B	3008A01959	Oct. 29, 2011	Oct. 28, 2012
RF signal cable HUBER+SUHNER	SUCOFLEX 104	230132/4	Nov. 03, 2011	Nov. 02, 2012
RF signal cable HUBER+SUHNER	SUCOFLEX 104	309223/4+309218 /4	Nov. 03, 2011	Nov. 02, 2012
Software ADT	BV ADT_Radiated_ V7.6.15.9.3	NA	NA	NA
Antenna Tower ADT	AT100	AT93021702	NA	NA
Turn Table ADT	TT100	TT93021702	NA	NA
Controller ADT	SC100	SC93021702	NA	NA
Fix tool for Boresight antenna tower	BAF-01	2	NA	NA
26GHz ~ 40GHz Amplifier	EM26400	815221	Oct. 29, 2011	Oct. 28, 2012

- NOTE:** 1. The calibration interval of the above test instruments is 12 months and the calibrations are traceable to NML/ROC and NIST/USA.
2. The calibration interval of the loop antenna is 24 months and the calibrations are traceable to NML/ROC and NIST/USA.
3. The test was performed in HwaYa Chamber 2.
4. The horn antenna and HP preamplifier (model: 8449B) are used only for the measurement of emission frequency above 1GHz if tested.
5. The FCC Site Registration No. is 686814.
6. The IC Site Registration No. is IC7450F-2.

4.1.3 TEST PROCEDURES

- a. The EUT was placed on the top of a rotating table 0.8 meters above the ground at a 3 meters semi-anechoic chamber. The table was rotated 360 degrees to determine the position of the highest radiation.
- b. The EUT was set 3 meters away from the interference-receiving antenna, which was mounted on the top of a variable-height antenna tower.
- c. The antenna is a broadband antenna, and its height is varied from one meter to four meters above the ground to determine the maximum value of the field strength. Both horizontal and vertical polarizations of the antenna are set to make the measurement.
- d. For each suspected emission, the EUT was arranged to its worst case and then the antenna was tuned to heights from 1 meter to 4 meters and the rotatable table was turned from 0 degrees to 360 degrees to find the maximum reading.
- e. The test-receiver system was set to Peak Detect Function and Specified Bandwidth with Maximum Hold Mode.
- f. If the emission level of the EUT in peak mode was lower than the limit specified, then testing could be stopped and the peak values of the EUT would be reported. Otherwise the emissions would be re-tested one by one using peak, quasi-peak or average method as specified and then reported in a data sheet.

NOTE:

1. The resolution bandwidth and video bandwidth of test receiver/spectrum analyzer is 120kHz for Quasi-peak detection at frequency below 1GHz.
2. The resolution bandwidth of test receiver/spectrum analyzer is 100kHz and video bandwidth is 300kHz for Peak detection at frequency above 1GHz.
3. The resolution bandwidth of test receiver/spectrum analyzer is 1MHz and the video bandwidth is 1kHz for Average detection (AV) at frequency above 1GHz.
4. All modes of operation were investigated and the worst-case emissions are reported.

4.1.4 DEVIATION FROM TEST STANDARD

No deviation.

4.1.5 TEST SETUP

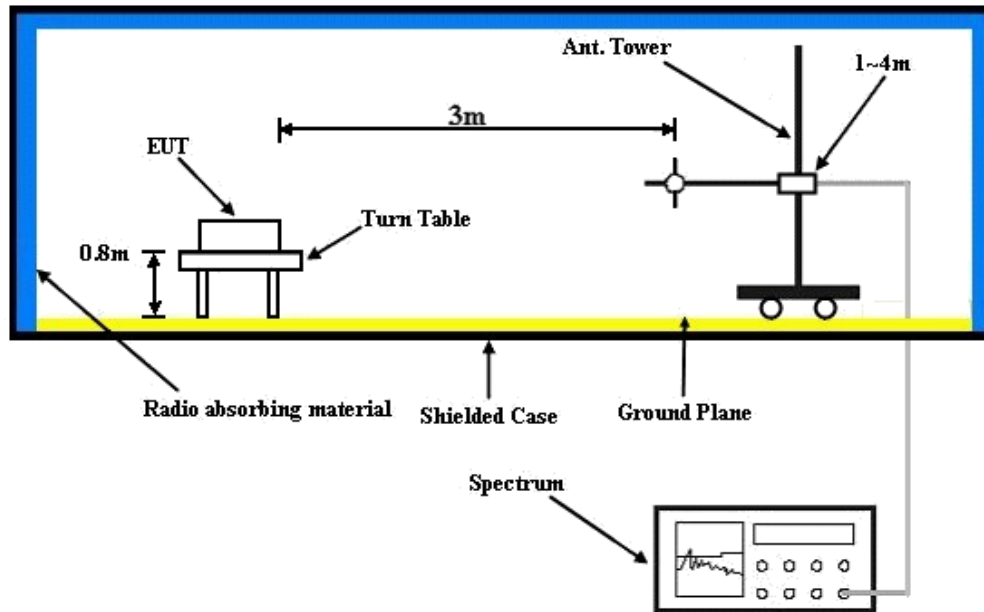

For the actual test configuration, please refer to the attached file (Test Setup Photo).

4.1.6 EUT OPERATING CONDITIONS

- a. Placed the EUT on a testing table.
- b. Use the software to control the EUT under transmission condition continuously at specific channel frequency.

4.1.7 TEST RESULTS

ABOVE 1GHz DATA:

802.11b: 1TX

EUT TEST CONDITION		MEASUREMENT DETAIL	
CHANNEL	Channel 1	FREQUENCY RANGE	1 ~ 25GHz
INPUT POWER (SYSTEM)	120Vac, 60 Hz	DETECTOR FUNCTION	Peak (PK) Average (AV)
ENVIRONMENTAL CONDITIONS	21deg. C, 68%RH	TESTED BY	Chad Lee

ANTENNA POLARITY & TEST DISTANCE: HORIZONTAL AT 3 M								
NO.	FREQ. (MHz)	EMISSION LEVEL (dBuV/m)	LIMIT (dBuV/m)	MARGIN (dB)	ANTENNA HEIGHT (m)	TABLE ANGLE (Degree)	RAW VALUE (dBuV)	CORRECTION FACTOR (dB/m)
1	2390.00	58.4 PK	74.0	-15.6	1.00 H	211	28.18	30.24
2	2390.00	47.7 AV	54.0	-6.3	1.00 H	211	17.49	30.24
3	*2412.00	110.3 PK			1.00 H	211	79.96	30.33
4	*2412.00	102.0 AV			1.00 H	211	71.63	30.33
5	4824.00	43.7 PK	74.0	-30.3	1.00 H	6	7.09	36.64
6	4824.00	31.7 AV	54.0	-22.3	1.00 H	6	-4.97	36.64
ANTENNA POLARITY & TEST DISTANCE: VERTICAL AT 3 M								
NO.	FREQ. (MHz)	EMISSION LEVEL (dBuV/m)	LIMIT (dBuV/m)	MARGIN (dB)	ANTENNA HEIGHT (m)	TABLE ANGLE (Degree)	RAW VALUE (dBuV)	CORRECTION FACTOR (dB/m)
1	2390.00	57.9 PK	74.0	-16.1	1.19 V	6	27.65	30.25
2	2390.00	45.4 AV	54.0	-8.6	1.19 V	6	15.11	30.25
3	*2412.00	100.9 PK			1.19 V	6	70.51	30.34
4	*2412.00	92.5 AV			1.19 V	6	62.12	30.34
5	4824.00	46.2 PK	74.0	-27.8	1.00 V	358	9.55	36.65
6	4824.00	35.6 AV	54.0	-18.4	1.00 V	358	-1.08	36.65

REMARKS:

1. Emission level (dBuV/m) = Raw Value (dBuV) + Correction Factor (dB/m).
2. Correction Factor (dB/m) = Antenna Factor (dB/m) + Cable Factor (dB).
3. The other emission levels were very low against the limit.
4. Margin value = Emission level – Limit value.
5. “ * “: Fundamental frequency.



A D T

EUT TEST CONDITION		MEASUREMENT DETAIL	
CHANNEL	Channel 6	FREQUENCY RANGE	1 ~ 25GHz
INPUT POWER (SYSTEM)	120Vac, 60 Hz	DETECTOR FUNCTION	Peak (PK) Average (AV)
ENVIRONMENTAL CONDITIONS	21deg. C, 68%RH	TESTED BY	Chad Lee

ANTENNA POLARITY & TEST DISTANCE: HORIZONTAL AT 3 M								
NO.	FREQ. (MHz)	EMISSION LEVEL (dBuV/m)	LIMIT (dBuV/m)	MARGIN (dB)	ANTENNA HEIGHT (m)	TABLE ANGLE (Degree)	RAW VALUE (dBuV)	CORRECTION FACTOR (dB/m)
1	*2437.00	109.5 PK			1.23 H	209	79.03	30.42
2	*2437.00	101.7 AV			1.23 H	209	71.25	30.42
3	4874.00	44.9 PK	74.0	-29.1	1.00 H	16	8.11	36.77
4	4874.00	32.2 AV	54.0	-21.9	1.00 H	16	-4.62	36.77
ANTENNA POLARITY & TEST DISTANCE: VERTICAL AT 3 M								
NO.	FREQ. (MHz)	EMISSION LEVEL (dBuV/m)	LIMIT (dBuV/m)	MARGIN (dB)	ANTENNA HEIGHT (m)	TABLE ANGLE (Degree)	RAW VALUE (dBuV)	CORRECTION FACTOR (dB/m)
1	*2437.00	99.9 PK			1.00 V	233	69.47	30.42
2	*2437.00	90.7 AV			1.00 V	233	60.25	30.42
3	4874.00	45.9 PK	74.0	-28.1	1.00 V	142	9.15	36.77
4	4874.00	35.8 AV	54.0	-18.2	1.00 V	142	-0.96	36.77

REMARKS:

1. Emission level (dBuV/m) = Raw Value (dBuV) + Correction Factor (dB/m).
2. Correction Factor (dB/m) = Antenna Factor (dB/m) + Cable Factor (dB).
3. The other emission levels were very low against the limit.
4. Margin value = Emission level – Limit value.
5. “ * “: Fundamental frequency.



A D T

EUT TEST CONDITION		MEASUREMENT DETAIL	
CHANNEL	Channel 11	FREQUENCY RANGE	1 ~ 25GHz
INPUT POWER (SYSTEM)	120Vac, 60 Hz	DETECTOR FUNCTION	Peak (PK) Average (AV)
ENVIRONMENTAL CONDITIONS	21deg. C, 68%RH	TESTED BY	Chad Lee

ANTENNA POLARITY & TEST DISTANCE: HORIZONTAL AT 3 M								
NO.	FREQ. (MHz)	EMISSION LEVEL (dBuV/m)	LIMIT (dBuV/m)	MARGIN (dB)	ANTENNA HEIGHT (m)	TABLE ANGLE (Degree)	RAW VALUE (dBuV)	CORRECTION FACTOR (dB/m)
1	*2462.00	108.4 PK			1.11 H	61	77.85	30.50
2	*2462.00	98.6 AV			1.11 H	61	68.14	30.50
3	2483.50	58.9 PK	74.0	-15.1	1.11 H	61	28.33	30.57
4	2483.50	47.5 AV	54.0	-6.5	1.11 H	61	16.95	30.57
5	4924.00	45.1 PK	74.0	-28.9	1.00 H	54	8.17	36.90
6	4924.00	32.0 AV	54.0	-22.0	1.00 H	54	-4.94	36.90
ANTENNA POLARITY & TEST DISTANCE: VERTICAL AT 3 M								
NO.	FREQ. (MHz)	EMISSION LEVEL (dBuV/m)	LIMIT (dBuV/m)	MARGIN (dB)	ANTENNA HEIGHT (m)	TABLE ANGLE (Degree)	RAW VALUE (dBuV)	CORRECTION FACTOR (dB/m)
1	*2462.00	100.3 PK			1.06 V	6	69.75	30.50
2	*2462.00	91.8 AV			1.06 V	6	61.34	30.50
3	2483.50	55.4 PK	74.0	-18.6	1.06 V	6	24.79	30.57
4	2483.50	45.3 AV	54.0	-8.7	1.06 V	6	14.75	30.57
5	4924.00	45.1 PK	74.0	-28.9	1.00 V	184	8.17	36.90
6	4924.00	35.3 AV	54.0	-18.7	1.00 V	184	-1.60	36.90

REMARKS:

1. Emission level (dBuV/m) = Raw Value (dBuV) + Correction Factor (dB/m).
2. Correction Factor (dB/m) = Antenna Factor (dB/m) + Cable Factor (dB).
3. The other emission levels were very low against the limit.
4. Margin value = Emission level – Limit value.
5. “ * “: Fundamental frequency.

802.11g: 1TX

EUT TEST CONDITION		MEASUREMENT DETAIL	
CHANNEL	Channel 1	FREQUENCY RANGE	1 ~ 25GHz
INPUT POWER (SYSTEM)	120Vac, 60 Hz	DETECTOR FUNCTION	Peak (PK) Average (AV)
ENVIRONMENTAL CONDITIONS	21deg. C, 68%RH	TESTED BY	Chad Lee

ANTENNA POLARITY & TEST DISTANCE: HORIZONTAL AT 3 M								
NO.	FREQ. (MHz)	EMISSION LEVEL (dBuV/m)	LIMIT (dBuV/m)	MARGIN (dB)	ANTENNA HEIGHT (m)	TABLE ANGLE (Degree)	RAW VALUE (dBuV)	CORRECTION FACTOR (dB/m)
1	2390.00	67.9 PK	74.0	-6.1	1.02 H	223	37.64	30.24
2	2390.00	51.6 AV	54.0	-2.4	1.02 H	223	21.40	30.24
3	*2412.00	107.8 PK			1.02 H	223	77.51	30.33
4	*2412.00	95.6 AV			1.02 H	223	65.25	30.33
5	4824.00	45.7 PK	74.0	-28.3	1.00 H	19	9.10	36.64
6	4824.00	35.5 AV	54.0	-18.5	1.00 H	19	-1.15	36.64

ANTENNA POLARITY & TEST DISTANCE: VERTICAL AT 3 M								
NO.	FREQ. (MHz)	EMISSION LEVEL (dBuV/m)	LIMIT (dBuV/m)	MARGIN (dB)	ANTENNA HEIGHT (m)	TABLE ANGLE (Degree)	RAW VALUE (dBuV)	CORRECTION FACTOR (dB/m)
1	2390.00	66.3 PK	74.0	-7.8	1.03 V	152	36.01	30.24
2	2390.00	50.3 AV	54.0	-3.8	1.03 V	152	20.01	30.24
3	*2412.00	102.3 PK			1.03 V	152	71.99	30.33
4	*2412.00	90.3 AV			1.03 V	152	59.92	30.33
5	4824.00	44.7 PK	74.0	-29.3	1.00 V	2	8.10	36.64
6	4824.00	30.7 AV	54.0	-23.3	1.00 V	2	-5.90	36.64

REMARKS:

1. Emission level (dBuV/m) = Raw Value (dBuV) + Correction Factor (dB/m).
2. Correction Factor (dB/m) = Antenna Factor (dB/m) + Cable Factor (dB).
3. The other emission levels were very low against the limit.
4. Margin value = Emission level – Limit value.
5. “ * “: Fundamental frequency.



A D T

EUT TEST CONDITION		MEASUREMENT DETAIL	
CHANNEL	Channel 6	FREQUENCY RANGE	1 ~ 25GHz
INPUT POWER (SYSTEM)	120Vac, 60 Hz	DETECTOR FUNCTION	Peak (PK) Average (AV)
ENVIRONMENTAL CONDITIONS	21deg. C, 68%RH	TESTED BY	Chad Lee

ANTENNA POLARITY & TEST DISTANCE: HORIZONTAL AT 3 M								
NO.	FREQ. (MHz)	EMISSION LEVEL (dBuV/m)	LIMIT (dBuV/m)	MARGIN (dB)	ANTENNA HEIGHT (m)	TABLE ANGLE (Degree)	RAW VALUE (dBuV)	CORRECTION FACTOR (dB/m)
1	*2437.00	107.6 PK			1.00 H	196	77.20	30.42
2	*2437.00	95.6 AV			1.00 H	196	65.19	30.42
3	4874.00	45.9 PK	74.0	-28.1	1.00 H	6	9.14	36.77
4	4874.00	35.7 AV	54.0	-18.3	1.00 H	6	-1.07	36.77
ANTENNA POLARITY & TEST DISTANCE: VERTICAL AT 3 M								
NO.	FREQ. (MHz)	EMISSION LEVEL (dBuV/m)	LIMIT (dBuV/m)	MARGIN (dB)	ANTENNA HEIGHT (m)	TABLE ANGLE (Degree)	RAW VALUE (dBuV)	CORRECTION FACTOR (dB/m)
1	*2437.00	102.3 PK			1.00 V	166	71.84	30.42
2	*2437.00	91.0 AV			1.00 V	166	60.59	30.42
3	4874.00	45.5 PK	74.0	-28.5	1.00 V	6	8.75	36.77
4	4874.00	31.8 AV	54.0	-22.2	1.00 V	6	-4.96	36.77

REMARKS:

1. Emission level (dBuV/m) = Raw Value (dBuV) + Correction Factor (dB/m).
2. Correction Factor (dB/m) = Antenna Factor (dB/m) + Cable Factor (dB).
3. The other emission levels were very low against the limit.
4. Margin value = Emission level – Limit value.
5. “ * “: Fundamental frequency.



A D T

EUT TEST CONDITION		MEASUREMENT DETAIL	
CHANNEL	Channel 11	FREQUENCY RANGE	1 ~ 25GHz
INPUT POWER (SYSTEM)	120Vac, 60 Hz	DETECTOR FUNCTION	Peak (PK) Average (AV)
ENVIRONMENTAL CONDITIONS	21deg. C, 68%RH	TESTED BY	Chad Lee

ANTENNA POLARITY & TEST DISTANCE: HORIZONTAL AT 3 M								
NO.	FREQ. (MHz)	EMISSION LEVEL (dBuV/m)	LIMIT (dBuV/m)	MARGIN (dB)	ANTENNA HEIGHT (m)	TABLE ANGLE (Degree)	RAW VALUE (dBuV)	CORRECTION FACTOR (dB/m)
1	*2462.00	108.4 PK			1.00 H	211	77.93	30.50
2	*2462.00	96.3 AV			1.00 H	211	65.84	30.50
3	2483.50	67.8 PK	74.0	-6.2	1.00 H	211	37.19	30.57
4	2483.50	52.3 AV	54.0	-1.7	1.00 H	211	21.75	30.57
5	4924.00	46.1 PK	74.0	-27.9	1.00 H	55	9.17	36.90
6	4924.00	35.9 AV	54.0	-18.1	1.00 H	55	-1.01	36.90
ANTENNA POLARITY & TEST DISTANCE: VERTICAL AT 3 M								
NO.	FREQ. (MHz)	EMISSION LEVEL (dBuV/m)	LIMIT (dBuV/m)	MARGIN (dB)	ANTENNA HEIGHT (m)	TABLE ANGLE (Degree)	RAW VALUE (dBuV)	CORRECTION FACTOR (dB/m)
1	*2462.00	102.9 PK			1.03 V	166	72.39	30.50
2	*2462.00	90.8 AV			1.03 V	166	60.31	30.50
3	2483.50	66.1 PK	74.0	-7.9	1.03 V	166	35.51	30.57
4	2483.50	51.8 AV	54.0	-2.2	1.03 V	166	21.21	30.57
5	4924.00	45.1 PK	74.0	-28.9	1.00 V	354	8.17	36.90
6	4924.00	32.3 AV	54.0	-21.7	1.00 V	354	-4.60	36.90

REMARKS:

1. Emission level (dBuV/m) = Raw Value (dBuV) + Correction Factor (dB/m).
2. Correction Factor (dB/m) = Antenna Factor (dB/m) + Cable Factor (dB).
3. The other emission levels were very low against the limit.
4. Margin value = Emission level – Limit value.
5. “ * “: Fundamental frequency.



A D T

802.11n (20MHz): 1TX

EUT TEST CONDITION		MEASUREMENT DETAIL	
CHANNEL	Channel 1	FREQUENCY RANGE	1 ~ 25GHz
INPUT POWER (SYSTEM)	120Vac, 60 Hz	DETECTOR FUNCTION	Peak (PK) Average (AV)
ENVIRONMENTAL CONDITIONS	21deg. C, 68%RH	TESTED BY	Chad Lee

ANTENNA POLARITY & TEST DISTANCE: HORIZONTAL AT 3 M								
NO.	FREQ. (MHz)	EMISSION LEVEL (dBuV/m)	LIMIT (dBuV/m)	MARGIN (dB)	ANTENNA HEIGHT (m)	TABLE ANGLE (Degree)	RAW VALUE (dBuV)	CORRECTION FACTOR (dB/m)
1	2390.00	72.3 PK	74.0	-1.8	1.00 H	191	42.00	30.25
2	2390.00	52.9 AV	54.0	-1.2	1.00 H	191	22.60	30.25
3	*2412.00	109.7 PK			1.00 H	191	79.38	30.34
4	*2412.00	97.6 AV			1.00 H	191	67.25	30.34
5	4824.00	45.7 PK	74.0	-28.3	1.00 H	184	9.09	36.65
6	4824.00	35.9 AV	54.0	-18.1	1.00 H	184	-0.72	36.65

ANTENNA POLARITY & TEST DISTANCE: VERTICAL AT 3 M								
NO.	FREQ. (MHz)	EMISSION LEVEL (dBuV/m)	LIMIT (dBuV/m)	MARGIN (dB)	ANTENNA HEIGHT (m)	TABLE ANGLE (Degree)	RAW VALUE (dBuV)	CORRECTION FACTOR (dB/m)
1	2390.00	71.4 PK	74.0	-2.6	1.05 V	235	41.20	30.24
2	2390.00	52.8 AV	54.0	-1.2	1.05 V	235	22.59	30.24
3	*2412.00	107.8 PK			1.05 V	235	77.44	30.33
4	*2412.00	95.6 AV			1.05 V	235	65.25	30.33
5	4824.00	45.1 PK	74.0	-28.9	1.00 V	14	8.43	36.64
6	4824.00	31.4 AV	54.0	-22.6	1.00 V	14	-5.24	36.64

REMARKS:

1. Emission level (dBuV/m) = Raw Value (dBuV) + Correction Factor (dB/m).
2. Correction Factor (dB/m) = Antenna Factor (dB/m) + Cable Factor (dB).
3. The other emission levels were very low against the limit.
4. Margin value = Emission level – Limit value.
5. “ * “: Fundamental frequency.



A D T

EUT TEST CONDITION		MEASUREMENT DETAIL	
CHANNEL	Channel 6	FREQUENCY RANGE	1 ~ 25GHz
INPUT POWER (SYSTEM)	120Vac, 60 Hz	DETECTOR FUNCTION	Peak (PK) Average (AV)
ENVIRONMENTAL CONDITIONS	21deg. C, 68%RH	TESTED BY	Chad Lee

ANTENNA POLARITY & TEST DISTANCE: HORIZONTAL AT 3 M								
NO.	FREQ. (MHz)	EMISSION LEVEL (dBuV/m)	LIMIT (dBuV/m)	MARGIN (dB)	ANTENNA HEIGHT (m)	TABLE ANGLE (Degree)	RAW VALUE (dBuV)	CORRECTION FACTOR (dB/m)
1	*2437.00	109.2 PK			1.00 H	111	78.80	30.42
2	*2437.00	96.7 AV			1.00 H	111	66.25	30.42
3	4874.00	46.9 PK	74.0	-27.1	1.00 H	16	10.15	36.77
4	4874.00	37.1 AV	54.0	-16.9	1.00 H	16	0.34	36.77

ANTENNA POLARITY & TEST DISTANCE: VERTICAL AT 3 M								
NO.	FREQ. (MHz)	EMISSION LEVEL (dBuV/m)	LIMIT (dBuV/m)	MARGIN (dB)	ANTENNA HEIGHT (m)	TABLE ANGLE (Degree)	RAW VALUE (dBuV)	CORRECTION FACTOR (dB/m)
1	*2437.00	106.7 PK			1.04 V	246	76.26	30.42
2	*2437.00	95.0 AV			1.04 V	246	64.58	30.42
3	4874.00	44.9 PK	74.0	-29.1	1.00 V	166	8.15	36.77
4	4874.00	31.8 AV	54.0	-22.2	1.00 V	166	-4.96	36.77

REMARKS:

1. Emission level (dBuV/m) = Raw Value (dBuV) + Correction Factor (dB/m).
2. Correction Factor (dB/m) = Antenna Factor (dB/m) + Cable Factor (dB).
3. The other emission levels were very low against the limit.
4. Margin value = Emission level – Limit value.
5. “ * “: Fundamental frequency.



A D T

EUT TEST CONDITION		MEASUREMENT DETAIL	
CHANNEL	Channel 11	FREQUENCY RANGE	1 ~ 25GHz
INPUT POWER (SYSTEM)	120Vac, 60 Hz	DETECTOR FUNCTION	Peak (PK) Average (AV)
ENVIRONMENTAL CONDITIONS	21deg. C, 68%RH	TESTED BY	Chad Lee

ANTENNA POLARITY & TEST DISTANCE: HORIZONTAL AT 3 M								
NO.	FREQ. (MHz)	EMISSION LEVEL (dBuV/m)	LIMIT (dBuV/m)	MARGIN (dB)	ANTENNA HEIGHT (m)	TABLE ANGLE (Degree)	RAW VALUE (dBuV)	CORRECTION FACTOR (dB/m)
1	*2462.00	110.1 PK			1.00 H	154	79.64	30.50
2	*2462.00	97.8 AV			1.00 H	154	67.25	30.50
3	2483.50	71.2 PK	74.0	-2.8	1.00 H	154	40.64	30.57
4	2483.50	52.9 AV	54.0	-1.1	1.00 H	154	22.36	30.57
5	4924.00	46.4 PK	74.0	-27.6	1.00 H	46	9.47	36.90
6	4924.00	36.6 AV	54.0	-17.5	1.00 H	46	-0.35	36.90
ANTENNA POLARITY & TEST DISTANCE: VERTICAL AT 3 M								
NO.	FREQ. (MHz)	EMISSION LEVEL (dBuV/m)	LIMIT (dBuV/m)	MARGIN (dB)	ANTENNA HEIGHT (m)	TABLE ANGLE (Degree)	RAW VALUE (dBuV)	CORRECTION FACTOR (dB/m)
1	*2462.00	106.4 PK			1.22 V	246	75.86	30.50
2	*2462.00	93.8 AV			1.22 V	246	63.25	30.50
3	2483.50	71.0 PK	74.0	-3.0	1.22 V	246	40.45	30.57
4	2483.50	52.2 AV	54.0	-1.8	1.22 V	246	21.67	30.57
5	4924.00	45.1 PK	74.0	-28.9	1.00 V	168	8.17	36.90
6	4924.00	31.9 AV	54.0	-22.1	1.00 V	168	-4.98	36.90

REMARKS:

1. Emission level (dBuV/m) = Raw Value (dBuV) + Correction Factor (dB/m).
2. Correction Factor (dB/m) = Antenna Factor (dB/m) + Cable Factor (dB).
3. The other emission levels were very low against the limit.
4. Margin value = Emission level – Limit value.
5. “ * “: Fundamental frequency.



A D T

802.11n (40MHz): 1TX

EUT TEST CONDITION		MEASUREMENT DETAIL	
CHANNEL	Channel 3	FREQUENCY RANGE	1 ~ 25GHz
INPUT POWER (SYSTEM)	120Vac, 60 Hz	DETECTOR FUNCTION	Peak (PK) Average (AV)
ENVIRONMENTAL CONDITIONS	21deg. C, 68%RH	TESTED BY	Chad Lee

ANTENNA POLARITY & TEST DISTANCE: HORIZONTAL AT 3 M								
NO.	FREQ. (MHz)	EMISSION LEVEL (dBuV/m)	LIMIT (dBuV/m)	MARGIN (dB)	ANTENNA HEIGHT (m)	TABLE ANGLE (Degree)	RAW VALUE (dBuV)	CORRECTION FACTOR (dB/m)
1	2390.00	72.4 PK	74.0	-1.6	1.00 H	220	42.15	30.24
2	2390.00	52.5 AV	54.0	-1.5	1.00 H	220	22.30	30.24
3	*2422.00	104.2 PK			1.00 H	220	73.86	30.36
4	*2422.00	90.8 AV			1.00 H	220	60.42	30.36
5	4844.00	45.8 PK	74.0	-28.2	1.00 H	23	9.11	36.69
6	4844.00	35.6 AV	54.0	-18.4	1.00 H	23	-1.08	36.69

ANTENNA POLARITY & TEST DISTANCE: VERTICAL AT 3 M								
NO.	FREQ. (MHz)	EMISSION LEVEL (dBuV/m)	LIMIT (dBuV/m)	MARGIN (dB)	ANTENNA HEIGHT (m)	TABLE ANGLE (Degree)	RAW VALUE (dBuV)	CORRECTION FACTOR (dB/m)
1	2390.00	66.3 PK	74.0	-7.7	1.03 V	244	36.08	30.24
2	2390.00	51.6 AV	54.0	-2.4	1.03 V	244	21.39	30.24
3	*2422.00	103.7 PK			1.03 V	244	73.37	30.36
4	*2422.00	90.6 AV			1.03 V	244	60.25	30.36
5	4844.00	45.1 PK	74.0	-29.0	1.00 V	18	8.36	36.69
6	4844.00	31.5 AV	54.0	-22.5	1.00 V	18	-5.19	36.69

REMARKS:

1. Emission level (dBuV/m) = Raw Value (dBuV) + Correction Factor (dB/m).
2. Correction Factor (dB/m) = Antenna Factor (dB/m) + Cable Factor (dB).
3. The other emission levels were very low against the limit.
4. Margin value = Emission level – Limit value.
5. “ * “: Fundamental frequency.



A D T

EUT TEST CONDITION		MEASUREMENT DETAIL	
CHANNEL	Channel 6	FREQUENCY RANGE	1 ~ 25GHz
INPUT POWER (SYSTEM)	120Vac, 60 Hz	DETECTOR FUNCTION	Peak (PK) Average (AV)
ENVIRONMENTAL CONDITIONS	21deg. C, 68%RH	TESTED BY	Chad Lee

ANTENNA POLARITY & TEST DISTANCE: HORIZONTAL AT 3 M								
NO.	FREQ. (MHz)	EMISSION LEVEL (dBuV/m)	LIMIT (dBuV/m)	MARGIN (dB)	ANTENNA HEIGHT (m)	TABLE ANGLE (Degree)	RAW VALUE (dBuV)	CORRECTION FACTOR (dB/m)
1	*2437.00	106.3 PK			1.00 H	148	75.88	30.42
2	*2437.00	91.8 AV			1.00 H	148	61.36	30.42
3	4874.00	45.9 PK	74.0	-28.1	1.00 H	8	9.15	36.77
4	4874.00	36.5 AV	54.0	-17.5	1.00 H	8	-0.25	36.77
ANTENNA POLARITY & TEST DISTANCE: VERTICAL AT 3 M								
NO.	FREQ. (MHz)	EMISSION LEVEL (dBuV/m)	LIMIT (dBuV/m)	MARGIN (dB)	ANTENNA HEIGHT (m)	TABLE ANGLE (Degree)	RAW VALUE (dBuV)	CORRECTION FACTOR (dB/m)
1	*2437.00	104.3 PK			1.05 V	256	73.83	30.42
2	*2437.00	90.5 AV			1.05 V	256	60.04	30.42
3	4874.00	45.5 PK	74.0	-28.5	1.14 V	18	8.76	36.77
4	4874.00	31.6 AV	54.0	-22.4	1.14 V	18	-5.14	36.77

REMARKS:

1. Emission level (dBuV/m) = Raw Value (dBuV) + Correction Factor (dB/m).
2. Correction Factor (dB/m) = Antenna Factor (dB/m) + Cable Factor (dB).
3. The other emission levels were very low against the limit.
4. Margin value = Emission level – Limit value.
5. “ * “: Fundamental frequency.



A D T

EUT TEST CONDITION		MEASUREMENT DETAIL	
CHANNEL	Channel 9	FREQUENCY RANGE	1 ~ 25GHz
INPUT POWER (SYSTEM)	120Vac, 60 Hz	DETECTOR FUNCTION	Peak (PK) Average (AV)
ENVIRONMENTAL CONDITIONS	21deg. C, 68%RH	TESTED BY	Chad Lee

ANTENNA POLARITY & TEST DISTANCE: HORIZONTAL AT 3 M								
NO.	FREQ. (MHz)	EMISSION LEVEL (dBuV/m)	LIMIT (dBuV/m)	MARGIN (dB)	ANTENNA HEIGHT (m)	TABLE ANGLE (Degree)	RAW VALUE (dBuV)	CORRECTION FACTOR (dB/m)
1	*2452.00	103.5 PK			1.00 H	211	73.02	30.47
2	*2452.00	90.8 AV			1.00 H	211	60.30	30.47
3	2483.50	72.9 PK	74.0	-1.1	1.00 H	211	42.37	30.57
4	2483.50	52.8 AV	54.0	-1.2	1.00 H	211	22.27	30.57
5	4904.00	46.4 PK	74.0	-27.7	1.00 H	1	9.50	36.85
6	4904.00	36.2 AV	54.0	-17.8	1.00 H	1	-0.68	36.85
ANTENNA POLARITY & TEST DISTANCE: VERTICAL AT 3 M								
NO.	FREQ. (MHz)	EMISSION LEVEL (dBuV/m)	LIMIT (dBuV/m)	MARGIN (dB)	ANTENNA HEIGHT (m)	TABLE ANGLE (Degree)	RAW VALUE (dBuV)	CORRECTION FACTOR (dB/m)
1	*2452.00	102.1 PK			1.00 V	160	71.63	30.47
2	*2452.00	88.8 AV			1.00 V	160	58.36	30.47
3	2483.50	71.9 PK	74.0	-2.1	1.00 V	160	41.32	30.57
4	2483.50	51.2 AV	54.0	-2.8	1.00 V	160	20.59	30.57
5	4904.00	45.0 PK	74.0	-29.0	1.00 V	174	8.17	36.85
6	4904.00	31.6 AV	54.0	-22.4	1.00 V	174	-5.24	36.85

REMARKS:

1. Emission level (dBuV/m) = Raw Value (dBuV) + Correction Factor (dB/m).
2. Correction Factor (dB/m) = Antenna Factor (dB/m) + Cable Factor (dB).
3. The other emission levels were very low against the limit.
4. Margin value = Emission level – Limit value.
5. “ * “: Fundamental frequency.



A D T

802.11n (20MHz): 2TX

EUT TEST CONDITION		MEASUREMENT DETAIL	
CHANNEL	Channel 1	FREQUENCY RANGE	1 ~ 25GHz
INPUT POWER (SYSTEM)	120Vac, 60 Hz	DETECTOR FUNCTION	Peak (PK) Average (AV)
ENVIRONMENTAL CONDITIONS	21deg. C, 68%RH	TESTED BY	Chad Lee

ANTENNA POLARITY & TEST DISTANCE: HORIZONTAL AT 3 M								
NO.	FREQ. (MHz)	EMISSION LEVEL (dBuV/m)	LIMIT (dBuV/m)	MARGIN (dB)	ANTENNA HEIGHT (m)	TABLE ANGLE (Degree)	RAW VALUE (dBuV)	CORRECTION FACTOR (dB/m)
1	2390.00	64.9 PK	74.0	-9.1	1.00 H	158	34.70	30.24
2	2390.00	50.4 AV	54.0	-3.6	1.00 H	158	20.19	30.24
3	*2412.00	109.2 PK			1.00 H	158	78.87	30.33
4	*2412.00	92.9 AV			1.00 H	158	62.55	30.33
5	4824.00	45.7 PK	74.0	-28.3	1.01 H	25	9.10	36.64
6	4824.00	36.3 AV	54.0	-17.7	1.01 H	25	-0.37	36.64
ANTENNA POLARITY & TEST DISTANCE: VERTICAL AT 3 M								
NO.	FREQ. (MHz)	EMISSION LEVEL (dBuV/m)	LIMIT (dBuV/m)	MARGIN (dB)	ANTENNA HEIGHT (m)	TABLE ANGLE (Degree)	RAW VALUE (dBuV)	CORRECTION FACTOR (dB/m)
1	2390.00	65.6 PK	74.0	-8.4	1.00 V	78	35.36	30.24
2	2390.00	49.5 AV	54.0	-4.5	1.00 V	78	19.22	30.24
3	*2412.00	105.2 PK			1.00 V	78	74.91	30.33
4	*2412.00	87.7 AV			1.00 V	78	57.36	30.33
5	4824.00	45.3 PK	74.0	-28.7	1.00 V	12	8.70	36.64
6	4824.00	31.4 AV	54.0	-22.6	1.00 V	12	-5.26	36.64

REMARKS:

1. Emission level (dBuV/m) = Raw Value (dBuV) + Correction Factor (dB/m).
2. Correction Factor (dB/m) = Antenna Factor (dB/m) + Cable Factor (dB).
3. The other emission levels were very low against the limit.
4. Margin value = Emission level – Limit value.
5. “ * “: Fundamental frequency.



A D T

EUT TEST CONDITION		MEASUREMENT DETAIL	
CHANNEL	Channel 6	FREQUENCY RANGE	1 ~ 25GHz
INPUT POWER (SYSTEM)	120Vac, 60 Hz	DETECTOR FUNCTION	Peak (PK) Average (AV)
ENVIRONMENTAL CONDITIONS	21deg. C, 68%RH	TESTED BY	Chad Lee

ANTENNA POLARITY & TEST DISTANCE: HORIZONTAL AT 3 M								
NO.	FREQ. (MHz)	EMISSION LEVEL (dBuV/m)	LIMIT (dBuV/m)	MARGIN (dB)	ANTENNA HEIGHT (m)	TABLE ANGLE (Degree)	RAW VALUE (dBuV)	CORRECTION FACTOR (dB/m)
1	*2437.00	110.3 PK			1.20 H	156	79.85	30.42
2	*2437.00	93.0 AV			1.20 H	156	62.55	30.42
3	4874.00	45.9 PK	74.0	-28.1	1.00 H	16	9.14	36.77
4	4874.00	35.8 AV	54.0	-18.2	1.00 H	16	-1.00	36.77

ANTENNA POLARITY & TEST DISTANCE: VERTICAL AT 3 M								
NO.	FREQ. (MHz)	EMISSION LEVEL (dBuV/m)	LIMIT (dBuV/m)	MARGIN (dB)	ANTENNA HEIGHT (m)	TABLE ANGLE (Degree)	RAW VALUE (dBuV)	CORRECTION FACTOR (dB/m)
1	*2437.00	106.1 PK			1.00 V	189	75.63	30.42
2	*2437.00	88.9 AV			1.00 V	189	58.44	30.42
3	4874.00	44.8 PK	74.0	-29.2	1.00 V	184	8.01	36.77
4	4874.00	31.4 AV	54.0	-22.6	1.00 V	184	-5.36	36.77

REMARKS:

1. Emission level (dBuV/m) = Raw Value (dBuV) + Correction Factor (dB/m).
2. Correction Factor (dB/m) = Antenna Factor (dB/m) + Cable Factor (dB).
3. The other emission levels were very low against the limit.
4. Margin value = Emission level – Limit value.
5. “ * “: Fundamental frequency.



A D T

EUT TEST CONDITION		MEASUREMENT DETAIL	
CHANNEL	Channel 11	FREQUENCY RANGE	1 ~ 25GHz
INPUT POWER (SYSTEM)	120Vac, 60 Hz	DETECTOR FUNCTION	Peak (PK) Average (AV)
ENVIRONMENTAL CONDITIONS	21deg. C, 68%RH	TESTED BY	Chad Lee

ANTENNA POLARITY & TEST DISTANCE: HORIZONTAL AT 3 M								
NO.	FREQ. (MHz)	EMISSION LEVEL (dBuV/m)	LIMIT (dBuV/m)	MARGIN (dB)	ANTENNA HEIGHT (m)	TABLE ANGLE (Degree)	RAW VALUE (dBuV)	CORRECTION FACTOR (dB/m)
1	*2462.00	109.9 PK			1.19 H	149	79.42	30.50
2	*2462.00	92.6 AV			1.19 H	149	62.14	30.50
3	2483.50	65.7 PK	74.0	-8.3	1.19 H	149	35.12	30.57
4	2483.50	50.9 AV	54.0	-3.1	1.19 H	149	20.34	30.57
5	4924.00	46.7 PK	74.0	-27.3	1.00 H	105	9.77	36.90
6	4924.00	35.0 AV	54.0	-19.0	1.00 H	105	-1.94	36.90
ANTENNA POLARITY & TEST DISTANCE: VERTICAL AT 3 M								
NO.	FREQ. (MHz)	EMISSION LEVEL (dBuV/m)	LIMIT (dBuV/m)	MARGIN (dB)	ANTENNA HEIGHT (m)	TABLE ANGLE (Degree)	RAW VALUE (dBuV)	CORRECTION FACTOR (dB/m)
1	*2462.00	106.5 PK			1.00 V	183	75.99	30.50
2	*2462.00	88.9 AV			1.00 V	183	58.39	30.50
3	2483.50	66.4 PK	74.0	-7.6	1.00 V	183	35.84	30.57
4	2483.50	49.9 AV	54.0	-4.1	1.00 V	183	19.33	30.57
5	4924.00	45.7 PK	74.0	-28.3	1.00 V	13	8.77	36.90
6	4924.00	31.3 AV	54.0	-22.7	1.00 V	13	-5.61	36.90

REMARKS:

1. Emission level (dBuV/m) = Raw Value (dBuV) + Correction Factor (dB/m).
2. Correction Factor (dB/m) = Antenna Factor (dB/m) + Cable Factor (dB).
3. The other emission levels were very low against the limit.
4. Margin value = Emission level – Limit value.
5. “ * “: Fundamental frequency.

802.11n (40MHz): 2TX

EUT TEST CONDITION		MEASUREMENT DETAIL	
CHANNEL	Channel 3	FREQUENCY RANGE	1 ~ 25GHz
INPUT POWER (SYSTEM)	120Vac, 60 Hz	DETECTOR FUNCTION	Peak (PK) Average (AV)
ENVIRONMENTAL CONDITIONS	21deg. C, 68%RH	TESTED BY	Chad Lee

ANTENNA POLARITY & TEST DISTANCE: HORIZONTAL AT 3 M								
NO.	FREQ. (MHz)	EMISSION LEVEL (dBuV/m)	LIMIT (dBuV/m)	MARGIN (dB)	ANTENNA HEIGHT (m)	TABLE ANGLE (Degree)	RAW VALUE (dBuV)	CORRECTION FACTOR (dB/m)
1	2390.00	65.8 PK	74.0	-8.2	1.02 H	191	35.56	30.24
2	2390.00	49.7 AV	54.0	-4.3	1.02 H	191	19.44	30.24
3	*2422.00	103.6 PK			1.02 H	191	73.23	30.36
4	*2422.00	84.7 AV			1.02 H	191	54.36	30.36
5	4844.00	47.0 PK	74.0	-27.0	1.00 H	185	10.34	36.69
6	4844.00	36.6 AV	54.0	-17.4	1.00 H	185	-0.10	36.69

ANTENNA POLARITY & TEST DISTANCE: VERTICAL AT 3 M								
NO.	FREQ. (MHz)	EMISSION LEVEL (dBuV/m)	LIMIT (dBuV/m)	MARGIN (dB)	ANTENNA HEIGHT (m)	TABLE ANGLE (Degree)	RAW VALUE (dBuV)	CORRECTION FACTOR (dB/m)
1	2390.00	63.2 PK	74.0	-10.8	1.04 V	243	32.92	30.24
2	2390.00	48.6 AV	54.0	-5.4	1.04 V	243	18.36	30.24
3	*2422.00	103.9 PK			1.04 V	243	73.55	30.36
4	*2422.00	83.5 AV			1.04 V	243	53.14	30.36
5	4844.00	44.7 PK	74.0	-29.3	1.00 V	159	8.01	36.69
6	4844.00	31.7 AV	54.0	-22.3	1.00 V	159	-5.00	36.69

REMARKS:

1. Emission level (dBuV/m) = Raw Value (dBuV) + Correction Factor (dB/m).
2. Correction Factor (dB/m) = Antenna Factor (dB/m) + Cable Factor (dB).
3. The other emission levels were very low against the limit.
4. Margin value = Emission level – Limit value.
5. “ * “: Fundamental frequency.



A D T

EUT TEST CONDITION		MEASUREMENT DETAIL	
CHANNEL	Channel 6	FREQUENCY RANGE	1 ~ 25GHz
INPUT POWER (SYSTEM)	120Vac, 60 Hz	DETECTOR FUNCTION	Peak (PK) Average (AV)
ENVIRONMENTAL CONDITIONS	21deg. C, 68%RH	TESTED BY	Chad Lee

ANTENNA POLARITY & TEST DISTANCE: HORIZONTAL AT 3 M								
NO.	FREQ. (MHz)	EMISSION LEVEL (dBuV/m)	LIMIT (dBuV/m)	MARGIN (dB)	ANTENNA HEIGHT (m)	TABLE ANGLE (Degree)	RAW VALUE (dBuV)	CORRECTION FACTOR (dB/m)
1	*2437.00	104.8 PK			1.00 H	118	74.36	30.42
2	*2437.00	84.7 AV			1.00 H	118	54.25	30.42
3	4874.00	46.1 PK	74.0	-27.9	1.02 H	20	9.34	36.77
4	4874.00	35.7 AV	54.0	-18.3	1.02 H	20	-1.07	36.77
ANTENNA POLARITY & TEST DISTANCE: VERTICAL AT 3 M								
NO.	FREQ. (MHz)	EMISSION LEVEL (dBuV/m)	LIMIT (dBuV/m)	MARGIN (dB)	ANTENNA HEIGHT (m)	TABLE ANGLE (Degree)	RAW VALUE (dBuV)	CORRECTION FACTOR (dB/m)
1	*2437.00	104.9 PK			1.00 V	76	74.46	30.42
2	*2437.00	84.8 AV			1.00 V	76	54.39	30.42
3	4874.00	44.6 PK	74.0	-29.4	1.00 V	78	7.86	36.77
4	4874.00	31.6 AV	54.0	-22.4	1.00 V	78	-5.19	36.77

REMARKS:

1. Emission level (dBuV/m) = Raw Value (dBuV) + Correction Factor (dB/m).
2. Correction Factor (dB/m) = Antenna Factor (dB/m) + Cable Factor (dB).
3. The other emission levels were very low against the limit.
4. Margin value = Emission level – Limit value.
5. “ * “: Fundamental frequency.



A D T

EUT TEST CONDITION		MEASUREMENT DETAIL	
CHANNEL	Channel 9	FREQUENCY RANGE	1 ~ 25GHz
INPUT POWER (SYSTEM)	120Vac, 60 Hz	DETECTOR FUNCTION	Peak (PK) Average (AV)
ENVIRONMENTAL CONDITIONS	21deg. C, 68%RH	TESTED BY	Chad Lee

ANTENNA POLARITY & TEST DISTANCE: HORIZONTAL AT 3 M								
NO.	FREQ. (MHz)	EMISSION LEVEL (dBuV/m)	LIMIT (dBuV/m)	MARGIN (dB)	ANTENNA HEIGHT (m)	TABLE ANGLE (Degree)	RAW VALUE (dBuV)	CORRECTION FACTOR (dB/m)
1	*2452.00	103.6 PK			1.00 H	165	73.15	30.47
2	*2452.00	84.0 AV			1.00 H	165	53.55	30.47
3	2483.50	71.8 PK	74.0	-2.2	1.00 H	142	41.25	30.57
4	2483.50	51.5 AV	54.0	-2.5	1.00 H	142	20.96	30.57
5	4904.00	46.4 PK	74.0	-27.7	1.00 H	289	9.50	36.85
6	4904.00	36.3 AV	54.0	-17.7	1.00 H	289	-0.56	36.85
ANTENNA POLARITY & TEST DISTANCE: VERTICAL AT 3 M								
NO.	FREQ. (MHz)	EMISSION LEVEL (dBuV/m)	LIMIT (dBuV/m)	MARGIN (dB)	ANTENNA HEIGHT (m)	TABLE ANGLE (Degree)	RAW VALUE (dBuV)	CORRECTION FACTOR (dB/m)
1	*2452.00	103.9 PK			1.11 V	285	73.45	30.47
2	*2452.00	84.2 AV			1.11 V	285	53.72	30.47
3	2483.50	70.8 PK	74.0	-3.2	1.11 V	285	40.26	30.57
4	2483.50	51.8 AV	54.0	-2.2	1.11 V	285	21.25	30.57
5	4904.00	45.0 PK	74.0	-29.0	1.00 V	106	8.17	36.85
6	4904.00	31.9 AV	54.0	-22.1	1.00 V	106	-4.94	36.85

REMARKS:

1. Emission level (dBuV/m) = Raw Value (dBuV) + Correction Factor (dB/m).
2. Correction Factor (dB/m) = Antenna Factor (dB/m) + Cable Factor (dB).
3. The other emission levels were very low against the limit.
4. Margin value = Emission level – Limit value.
5. “ * “: Fundamental frequency.

BELOW 1GHz WORST-CASE DATA :

802.11n (20MHz): 2TX

EUT TEST CONDITION		MEASUREMENT DETAIL	
CHANNEL	Channel 6	FREQUENCY RANGE	Below 1000MHz
INPUT POWER (SYSTEM)	120Vac, 60 Hz	DETECTOR FUNCTION	Quasi-Peak
ENVIRONMENTAL CONDITIONS	25deg. C, 89%RH	TESTED BY	Chad Lee

ANTENNA POLARITY & TEST DISTANCE: HORIZONTAL AT 3 M								
NO.	FREQ. (MHz)	EMISSION LEVEL (dBuV/m)	LIMIT (dBuV/m)	MARGIN (dB)	ANTENNA HEIGHT (m)	TABLE ANGLE (Degree)	RAW VALUE (dBuV)	CORRECTION FACTOR (dB/m)
1	203.54	32.5 QP	43.5	-11.0	1.00 H	136	21.20	11.26
2	509.43	34.3 QP	46.0	-11.7	1.50 H	85	13.04	21.26
3	662.12	33.0 QP	46.0	-13.0	1.00 H	112	9.00	24.04
4	687.33	33.4 QP	46.0	-12.6	1.00 H	103	9.01	24.37
5	738.23	36.1 QP	46.0	-9.9	1.00 H	118	10.92	25.21
6	763.92	38.2 QP	46.0	-7.8	1.00 H	121	12.58	25.65
ANTENNA POLARITY & TEST DISTANCE: VERTICAL AT 3 M								
NO.	FREQ. (MHz)	EMISSION LEVEL (dBuV/m)	LIMIT (dBuV/m)	MARGIN (dB)	ANTENNA HEIGHT (m)	TABLE ANGLE (Degree)	RAW VALUE (dBuV)	CORRECTION FACTOR (dB/m)
1	497.79	36.0 QP	46.0	-10.0	1.00 V	163	15.02	20.98
2	663.58	28.7 QP	46.0	-17.3	1.00 V	109	4.62	24.06
3	687.33	28.4 QP	46.0	-17.6	1.00 V	283	4.01	24.37
4	713.02	33.2 QP	46.0	-12.8	1.00 V	271	8.47	24.77
5	763.92	32.2 QP	46.0	-13.8	1.50 V	136	6.58	25.65
6	899.17	32.2 QP	46.0	-13.8	1.00 V	211	4.52	27.72

REMARKS:

1. Emission level (dBuV/m) = Raw Value (dBuV) + Correction Factor (dB/m).
2. Correction Factor (dB/m) = Antenna Factor (dB/m) + Cable Factor (dB).
3. The other emission levels were very low against the limit.
4. Margin value = Emission level – Limit value.

4.2 CONDUCTED EMISSION MEASUREMENT

4.2.1 LIMITS OF CONDUCTED EMISSION MEASUREMENT

FREQUENCY OF EMISSION (MHz)	CONDUCTED LIMIT (dB μ V)	
	Quasi-peak	Average
0.15 ~ 0.5	66 to 56	56 to 46
0.5 ~ 5	56	46
5 ~ 30	60	50

- NOTE:**
1. The lower limit shall apply at the transition frequencies.
 2. The limit decreases in line with the logarithm of the frequency in the range of 0.15 to 0.50MHz.
 3. All emanations from a class A/B digital device or system, including any network of conductors and apparatus connected thereto, shall not exceed the level of field strengths specified above.

4.2.2 TEST INSTRUMENTS

DESCRIPTION & MANUFACTURER	MODEL NO.	SERIAL NO.	DATE OF CALIBRATION	DUE DATE OF CALIBRATION
Test Receiver ROHDE & SCHWARZ	ESCS30	100289	Nov. 19, 2011	Nov. 18, 2012
RF signal cable Woken	5D-FB	Cable-HYCO2-01	Dec. 22, 2011	Dec. 21, 2012
LISN ROHDE & SCHWARZ	ESH2-Z5	100100	Dec. 30, 2011	Dec. 29, 2012
LISN ROHDE & SCHWARZ	ESH3-Z5	100312	Jul. 07, 2011	Jul. 06, 2012
Software ADT	ADT_Cond_ V7.3.7	NA	NA	NA

- NOTE:**
1. The calibration interval of the above test instruments is 12 months and the calibrations are traceable to NML/ROC and NIST/USA.
 2. The test was performed in HwaYa Shielded Room 2.
 3. The VCCI Site Registration No. is C-2047.

4.2.3 TEST PROCEDURES

- a. The EUT was placed 0.4 meters from the conducting wall of the shielded room with EUT being connected to the power mains through a line impedance stabilization network (LISN). Other support units were connected to the power mains through another LISN. The two LISNs provide 50 ohm/ 50uH of coupling impedance for the measuring instrument.
- b. Both lines of the power mains connected to the EUT were checked for maximum conducted interference.
- c. The frequency range from 150kHz to 30MHz was searched. Emission levels under (Limit - 20dB) was not recorded.

NOTE: All modes of operation were investigated and the worst-case emissions are reported.

4.2.4 DEVIATION FROM TEST STANDARD

No deviation.

4.2.5 TEST SETUP

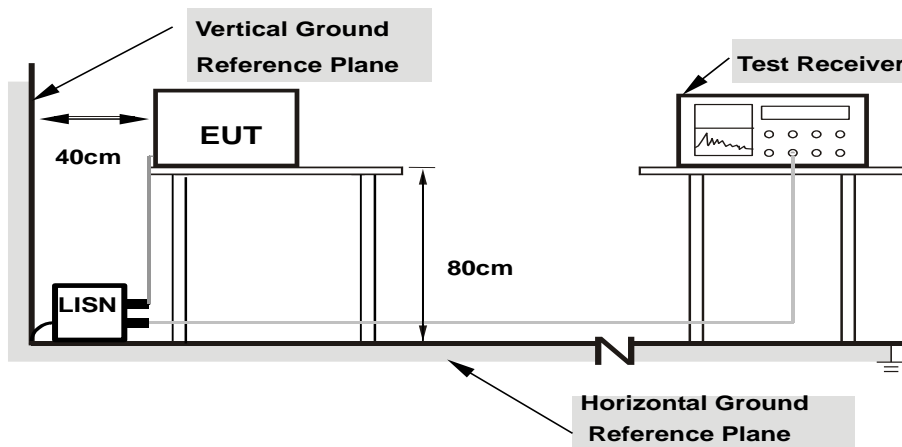

- Note:**
1. Support units were connected to second LISN.
 2. Both of LISNs (AMN) are 80 cm from EUT and at least 80 cm from other units and other metal planes

For the actual test configuration, please refer to the attached file (Test Setup Photo).

4.2.6 EUT OPERATING CONDITIONS

Same as 4.1.6.



A D T

4.2.7 TEST RESULTS

CONDUCTED WORST-CASE DATA :

802.11n (20MHz): 2TX

PHASE	Line 1	6dB BANDWIDTH	9kHz
-------	--------	---------------	------

No	Freq. [MHz]	Corr. Factor (dB)	Reading Value [dB (uV)]		Emission Level [dB (uV)]		Limit [dB (uV)]		Margin (dB)	
			Q.P.	AV.	Q.P.	AV.	Q.P.	AV.	Q.P.	AV.
			1	0.38828	0.20	32.85	27.32	33.05	27.52	58.10
2	1.79297	0.29	28.91	23.90	29.20	24.19	56.00	46.00	-26.80	-21.81
3	2.04297	0.30	29.06	21.79	29.36	22.09	56.00	46.00	-26.64	-23.91
4	6.71094	0.43	19.54	12.83	19.97	13.26	60.00	50.00	-40.03	-36.74
5	11.51953	0.52	21.22	14.41	21.74	14.93	60.00	50.00	-38.26	-35.07
6	17.99219	0.68	29.83	24.44	30.51	25.12	60.00	50.00	-29.49	-24.88

REMARKS:

1. Q.P. and AV. are abbreviations of quasi-peak and average individually.
2. The emission levels of other frequencies were very low against the limit.
3. Margin value = Emission level - Limit value
4. Correction factor = Insertion loss + Cable loss
5. Emission Level = Correction Factor + Reading Value.

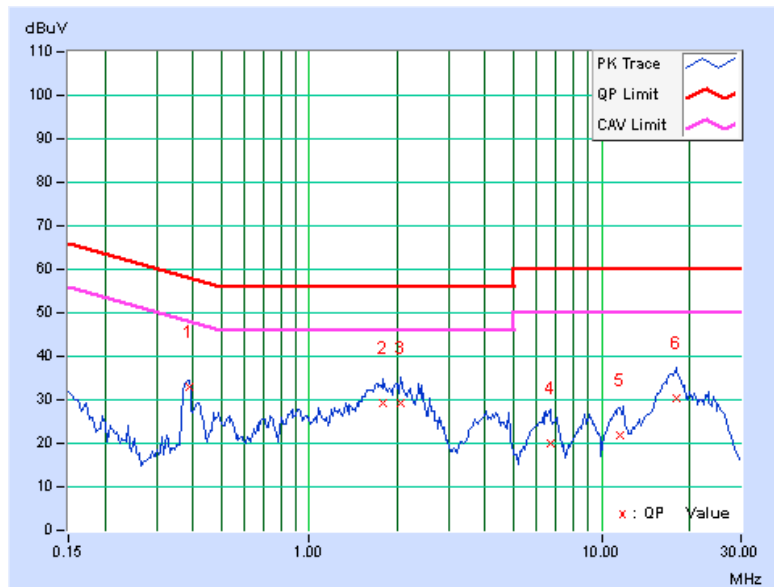



A D T

PHASE	Line 2	6dB BANDWIDTH	9kHz
-------	--------	---------------	------

No	Freq. [MHz]	Corr. Factor (dB)	Reading Value [dB (uV)]		Emission Level [dB (uV)]		Limit [dB (uV)]		Margin (dB)	
			Q.P.	AV.	Q.P.	AV.	Q.P.	AV.	Q.P.	AV.
			1	0.32188	0.17	27.03	17.93	27.20	18.10	59.66
2	0.42734	0.18	30.46	24.41	30.64	24.59	57.30	47.30	-26.66	-22.71
3	1.12500	0.20	25.25	18.67	25.45	18.87	56.00	46.00	-30.55	-27.13
4	1.96875	0.27	28.42	21.46	28.69	21.73	56.00	46.00	-27.31	-24.27
5	6.69141	0.47	21.36	15.22	21.83	15.69	60.00	50.00	-38.17	-34.31
6	18.28125	0.78	28.72	23.09	29.50	23.87	60.00	50.00	-30.50	-26.13

REMARKS:

1. Q.P. and AV. are abbreviations of quasi-peak and average individually.
2. The emission levels of other frequencies were very low against the limit.
3. Margin value = Emission level - Limit value
4. Correction factor = Insertion loss + Cable loss
5. Emission Level = Correction Factor + Reading Value.

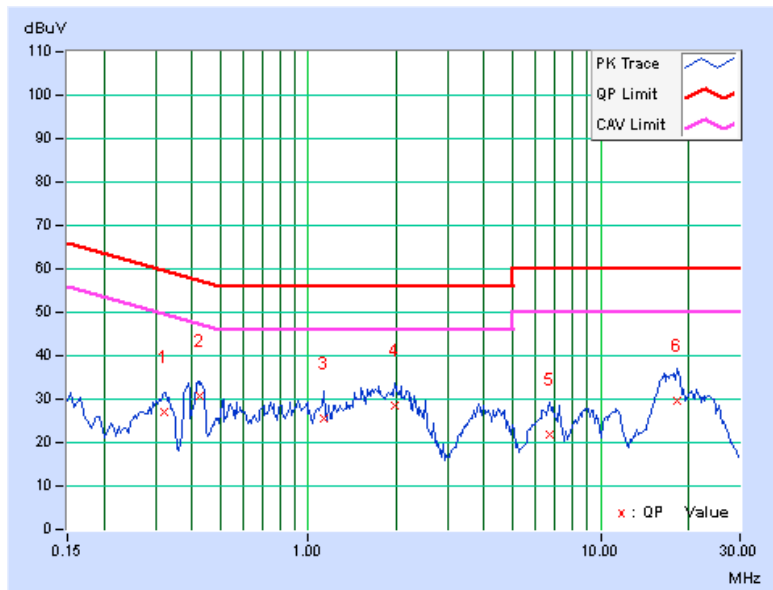

4.3 6dB BANDWIDTH MEASUREMENT

4.3.1 LIMITS OF 6dB BANDWIDTH MEASUREMENT

The minimum of 6dB Bandwidth Measurement is 0.5 MHz.

4.3.2 TEST SETUP

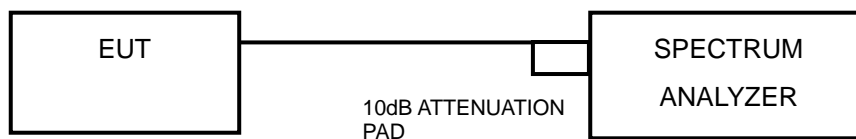

4.3.3 TEST INSTRUMENTS

Refer to section 4.1.2 to get information of above instrument.

4.3.4 TEST PROCEDURE

- a. Set resolution bandwidth (RBW) = approximately 1% of the emission bandwidth
- b. Set the video bandwidth (VBW) $\geq 3 \times$ RBW, Detector = Peak.
- c. Trace mode = max hold.
- d. Sweep = auto couple.
- e. Measure the maximum width of the emission that is constrained by the frequencies associated with the two amplitude points (upper and lower) that are attenuated by 6 dB relative to the maximum level measured in the fundamental emission

4.3.5 DEVIATION FROM TEST STANDARD

No deviation.

4.3.6 EUT OPERATING CONDITIONS

The software provided by client to enable the EUT under transmission condition continuously at lowest, middle and highest channel frequencies individually.



4.3.7 TEST RESULTS

802.11b

CHANNEL	FREQUENCY (MHz)	6dB BANDWIDTH (MHz)	MINIMUM LIMIT (MHz)	PASS / FAIL
1	2412	8.12	0.5	PASS
6	2437	8.12	0.5	PASS
11	2462	8.12	0.5	PASS

802.11g

CHANNEL	FREQUENCY (MHz)	6dB BANDWIDTH (MHz)	MINIMUM LIMIT (MHz)	PASS / FAIL
1	2412	15.76	0.5	PASS
6	2437	15.80	0.5	PASS
11	2462	15.92	0.5	PASS

802.11n (20MHz): 1TX

CHANNEL	FREQUENCY (MHz)	6dB BANDWIDTH (MHz)	MINIMUM LIMIT (MHz)	PASS / FAIL
1	2412	17.23	0.5	PASS
6	2437	17.29	0.5	PASS
11	2462	17.26	0.5	PASS

802.11n (40MHz): 1TX

CHANNEL	FREQUENCY (MHz)	6dB BANDWIDTH (MHz)	MINIMUM LIMIT (MHz)	PASS / FAIL
3	2422	36.32	0.5	PASS
6	2437	36.47	0.5	PASS
9	2452	36.52	0.5	PASS



802.11n (20MHz): 2TX

CHANNEL	FREQUENCY (MHz)	6dB BANDWIDTH (MHz)		MINIMUM LIMIT (MHz)	PASS / FAIL
		CHAIN 0	CHAIN 1		
1	2412	17.14	17.03	0.5	PASS
6	2437	17.31	17.07	0.5	PASS
11	2462	17.26	16.81	0.5	PASS

802.11n (40MHz): 2TX

CHANNEL	FREQUENCY (MHz)	6dB BANDWIDTH (MHz)		MINIMUM LIMIT (MHz)	PASS / FAIL
		CHAIN 0	CHAIN 1		
3	2422	36.43	36.65	0.5	PASS
6	2437	36.36	36.37	0.5	PASS
9	2452	36.15	36.50	0.5	PASS

4.4 CONDUCTED OUTPUT POWER

4.4.1 LIMITS OF CONDUCTED OUTPUT POWER MEASUREMENT

For systems using digital modulation in the 2400–2483.5 MHz bands: 1 Watt (30dBm)

4.4.2 TEST SETUP

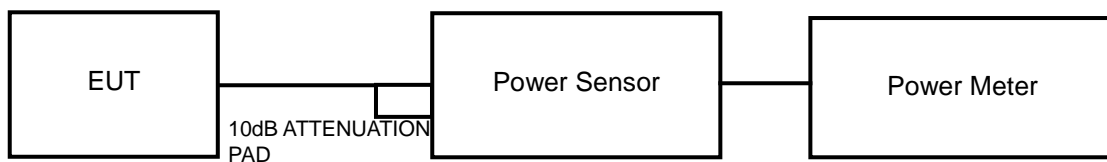

4.4.3 TEST INSTRUMENTS

Refer to section 4.1.2 to get information of above instrument.

4.4.4 TEST PROCEDURES

A peak power sensor was used on the output port of the EUT. A power meter was used to read the response of the peak power sensor. Record the peak power level.

4.4.5 DEVIATION FROM TEST STANDARD

No deviation.

4.4.6 EUT OPERATING CONDITIONS

Same as Item 4.3.6.



4.4.7 TEST RESULTS

802.11b: 1TX

CHANNEL	FREQUENCY (MHz)	PEAK POWER (mW)	PEAK POWER (dBm)	LIMIT (dBm)	PASS/FAIL
1	2412	187.932	22.74	30	PASS
6	2437	211.836	23.26	30	PASS
11	2462	205.589	23.13	30	PASS

802.11g: 1TX

CHANNEL	FREQUENCY (MHz)	PEAK POWER (mW)	PEAK POWER (dBm)	LIMIT (dBm)	PASS/FAIL
1	2412	342.768	25.35	30	PASS
6	2437	349.140	25.43	30	PASS
11	2462	319.154	25.04	30	PASS

802.11n (20MHz): 1TX

CHANNEL	FREQUENCY (MHz)	PEAK POWER (mW)	PEAK POWER (dBm)	LIMIT (dBm)	PASS/FAIL
1	2412	243.781	23.87	30	PASS
6	2437	270.396	24.32	30	PASS
11	2462	222.331	23.47	30	PASS

802.11n (40MHz): 1TX

CHANNEL	FREQUENCY (MHz)	PEAK POWER (mW)	PEAK POWER (dBm)	LIMIT (dBm)	PASS/FAIL
3	2422	220.800	23.44	30	PASS
6	2437	248.886	23.96	30	PASS
9	2452	233.346	23.68	30	PASS



A D T

802.11n (20MHz): 2TX

CHAN.	FREQUENCY (MHz)	PEAK POWER (dBm)		TOTAL POWER (mW)	TOTAL POWER (dBm)	LIMIT (dBm)	PASS / FAIL
		CHAIN 0	CHAIN 1				
1	2412	22.85	22.88	386.8	25.9	30	PASS
6	2437	22.86	23.06	395.5	26.0	30	PASS
11	2462	22.83	22.81	382.9	25.8	30	PASS

802.11n (40MHz): 2TX

CHAN.	FREQUENCY (MHz)	PEAK POWER (dBm)		TOTAL POWER (mW)	TOTAL POWER (dBm)	LIMIT (dBm)	PASS / FAIL
		CHAIN 0	CHAIN 1				
3	2422	22.17	22.41	339.0	25.3	30	PASS
6	2437	22.24	22.56	347.8	25.4	30	PASS
9	2452	22.11	22.31	332.8	25.2	30	PASS

4.5 POWER SPECTRAL DENSITY MEASUREMENT

4.5.1 LIMITS OF POWER SPECTRAL DENSITY MEASUREMENT

The Maximum of Power Spectral Density Measurement is 8dBm.

4.5.2 TEST SETUP

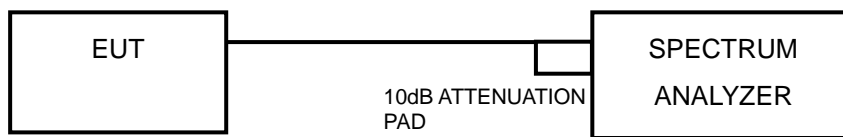

4.5.3 TEST INSTRUMENTS

Refer to section 4.1.2 to get information of above instrument.

4.5.4 TEST PROCEDURE

- a. Set the RBW = 100 kHz, VBW = 300 kHz, Detector = peak.
- b. Sweep time = auto couple, Trace mode = max hold, allow trace to fully stabilize.
- c. Use the peak marker function to determine the maximum power level in any 100 kHz band segment within the fundamental EBW.
- d. Scale the observed power level to an equivalent value in 3 kHz by adjusting (reducing) the measured power by a bandwidth correction factor (BWCF) where $BWCF = 10\log(3 \text{ kHz}/100\text{kHz})$

4.5.5 DEVIATION FROM TEST STANDARD

No deviation.

4.5.6 EUT OPERATING CONDITION

Same as Item 4.3.6

4.5.7 TEST RESULTS

802.11b: 1TX

Channel	FREQ. (MHz)	PSD (dBm/100kHz)	PSD (dBm/3kHz)	Limit (dBm/3kHz)	PASS /FAIL
1	2412	10.67	-4.56	8	PASS
6	2437	10.95	-4.28	8	PASS
11	2462	11.05	-4.18	8	PASS

802.11g: 1TX

Channel	FREQ. (MHz)	PSD (dBm/100kHz)	PSD (dBm/3kHz)	Limit (dBm/3kHz)	PASS /FAIL
1	2412	6.55	-8.68	8	PASS
6	2437	6.87	-8.36	8	PASS
11	2462	6.31	-8.92	8	PASS

802.11n (20MHz): 1TX

Channel	FREQ. (MHz)	PSD (dBm/100kHz)	PSD (dBm/3kHz)	Limit (dBm/3kHz)	PASS /FAIL
1	2412	3.55	-11.68	8	PASS
6	2437	4.23	-11	8	PASS
11	2462	3.29	-11.94	8	PASS

802.11n (40MHz): 1TX

Channel	FREQ. (MHz)	PSD (dBm/100kHz)	PSD (dBm/3kHz)	Limit (dBm/3kHz)	PASS /FAIL
3	2422	-0.82	-16.05	8	PASS
6	2437	-0.32	-15.55	8	PASS
9	2452	-0.42	-15.65	8	PASS



A D T

802.11n (20MHz): 2TX

TX chain	Channel	FREQ. (MHz)	PSD (dBm/100kHz)	PSD (dBm/3kHz)	10 log (N=2) dB	Total PSD (dBm/3kHz)	Limit (dBm/3kHz)	PASS /FAIL
0	1	2412	3.36	-11.87	3.01	-8.86	8	PASS
	6	2437	3.42	-11.81	3.01	-8.80	8	PASS
	11	2462	3.57	-11.66	3.01	-8.65	8	PASS
1	1	2412	3.86	-11.37	3.01	-8.36	8	PASS
	6	2437	3.93	-11.3	3.01	-8.29	8	PASS
	11	2462	3.74	-11.49	3.01	-8.48	8	PASS

802.11n (40MHz): 2TX

TX chain	Channel	FREQ. (MHz)	PSD (dBm/100kHz)	PSD (dBm/3kHz)	10 log (N=2) dB	Total PSD (dBm/3kHz)	Limit (dBm/3kHz)	PASS /FAIL
0	3	2422	0.11	-15.12	3.01	-12.11	8	PASS
	6	2437	-0.04	-15.27	3.01	-12.26	8	PASS
	9	2452	-0.20	-15.43	3.01	-12.42	8	PASS
1	3	2422	-0.05	-15.28	3.01	-12.27	8	PASS
	6	2437	-0.02	-15.25	3.01	-12.24	8	PASS
	9	2452	-0.25	-15.48	3.01	-12.47	8	PASS

4.6 CONDUCTED OUT OF BAND EMISSION MEASUREMENT

4.6.1 LIMITS OF CONDUCTED OUT OF BAND EMISSION MEASUREMENT

Below -20dB of the highest emission level of operating band (in 100kHz Resolution Bandwidth).

4.6.2 TEST SETUP

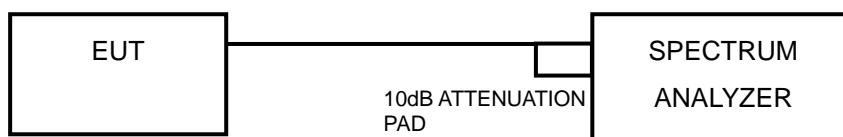

4.6.3 TEST INSTRUMENTS

Refer to section 4.1.2 to get information of above instrument.

4.6.4 TEST PROCEDURE

MEASUREMENT PROCEDURE REF

1. Set the RBW = 100 kHz.
2. Set the VBW \geq 300 kHz.
3. Detector = peak.
4. Sweep time = auto couple.
5. Trace mode = max hold.
6. Allow trace to fully stabilize.
7. Use the peak marker function to determine the maximum power level in any 100 kHz band segment within the fundamental EBW.

MEASUREMENT PROCEDURE OOB

1. Set RBW = 100 kHz.
2. Set VBW \geq 300 kHz.
3. Set span to encompass the spectrum to be examined.
4. Detector = peak.
5. Trace Mode = max hold.
6. Sweep = auto couple.

4.6.5 DEVIATION FROM TEST STANDARD

No deviation.

4.6.6 EUT OPERATING CONDITION

Same as Item 4.3.6

4.6.7 TEST RESULTS

The conducted emission test is performed on each TX port of operating mode without summing or adding $10\log(N)$ since the limit is relative emission limit. Only worst data of each operating mode is presented.

The spectrum plots are attached on the following pages. D1 line indicates the highest level, and D2 line indicates the 20dB offset below D1. It shows compliance with the requirement.



A D T

4.6.8 TEST RESULTS

802.11b: 1TX

CH 1

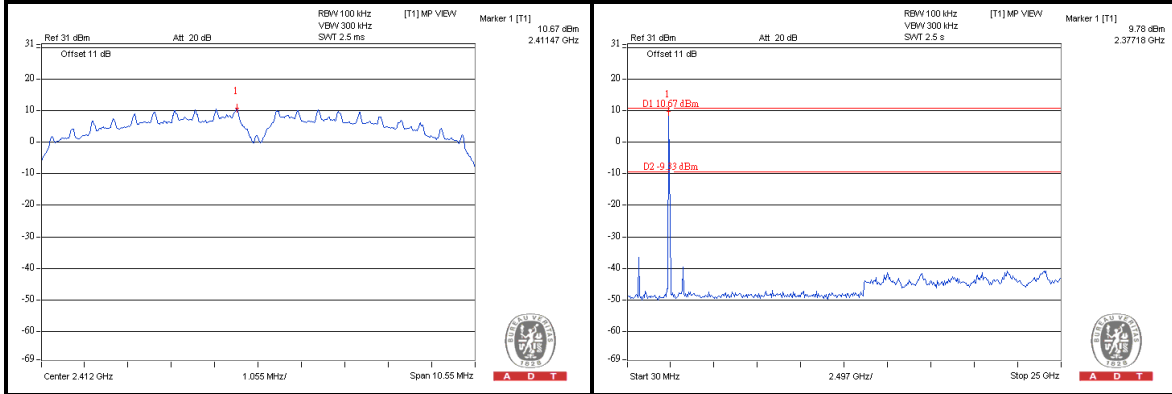

CH 6

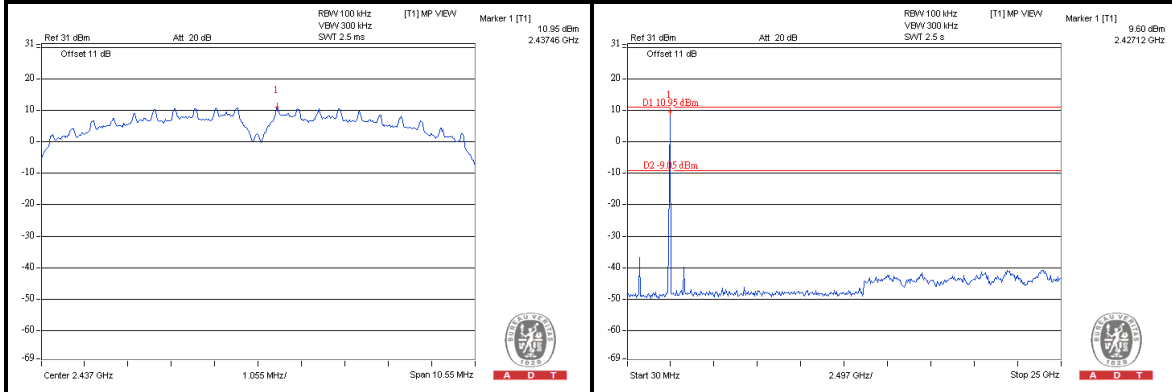

CH 11

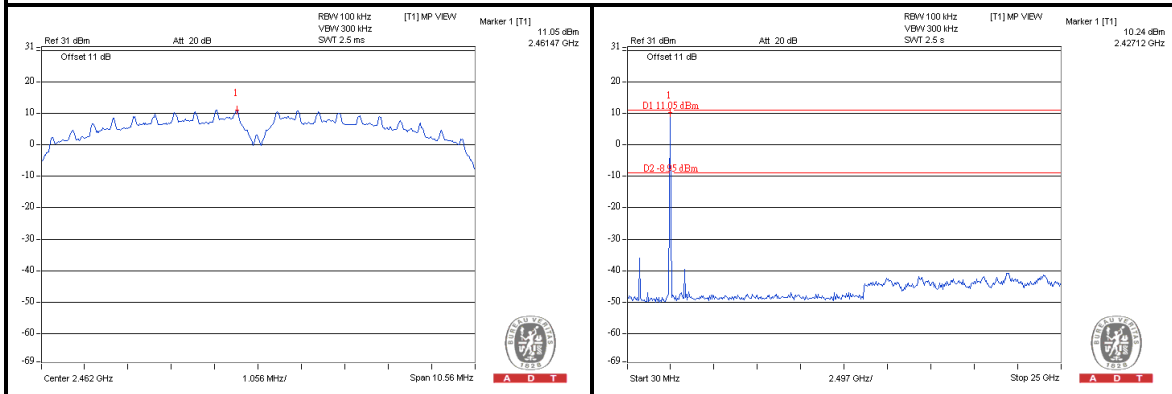



A D T

802.11g: 1TX

CH 1

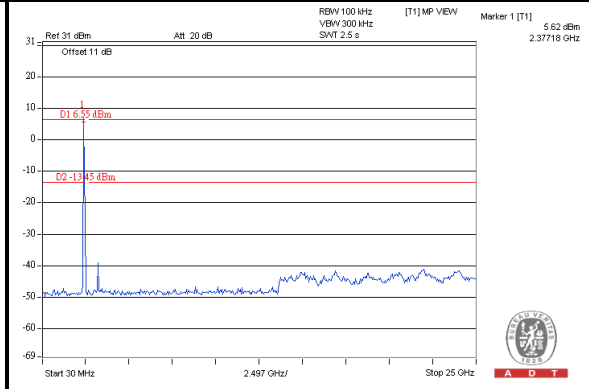
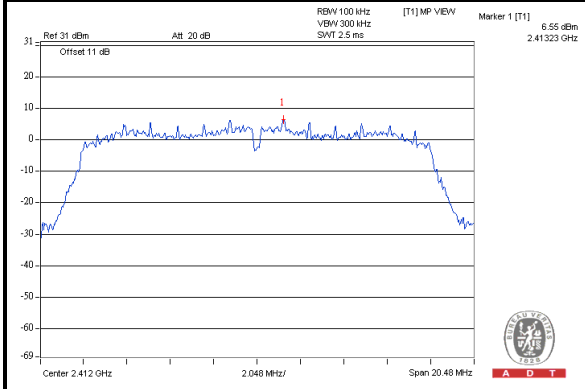

CH 6

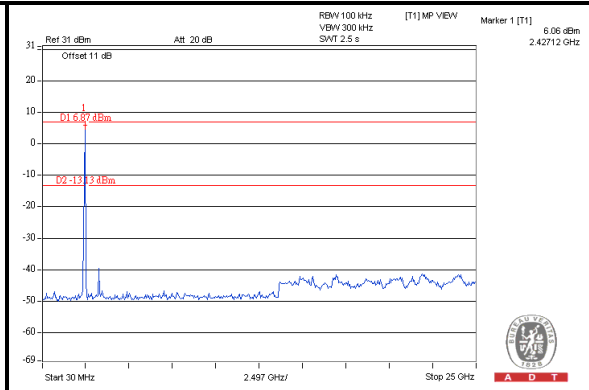
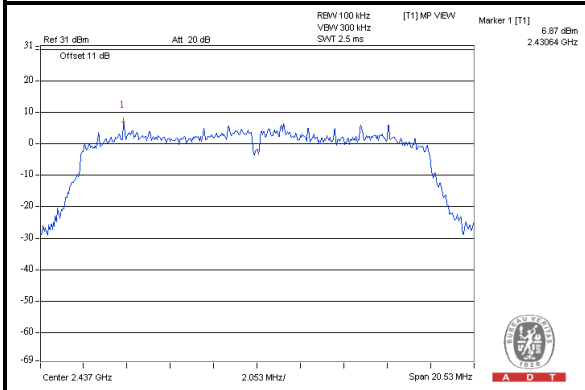

CH 11

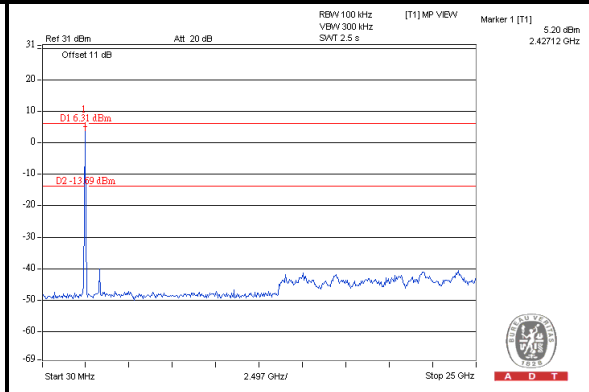
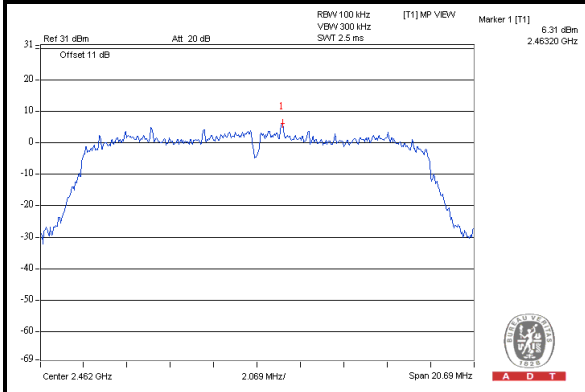



A D T

802.11n (20MHz): 1TX

CH 1

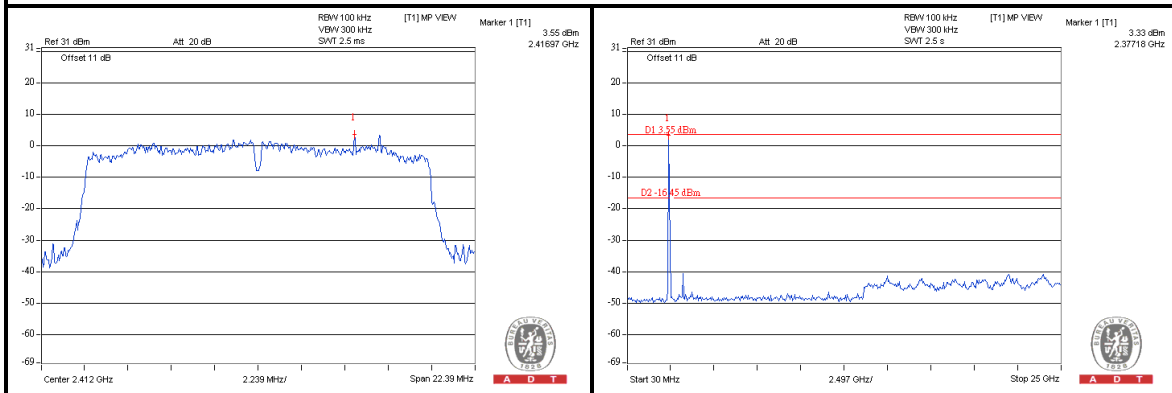

CH 6

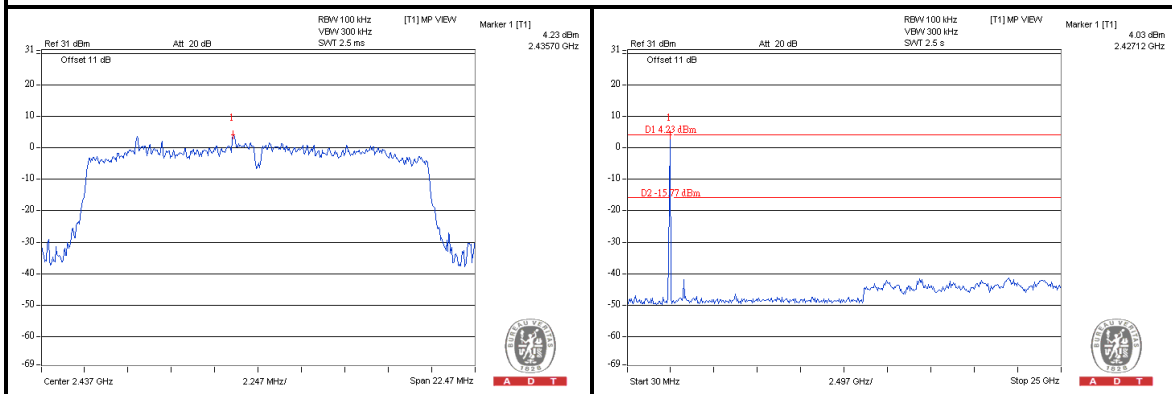

CH 11

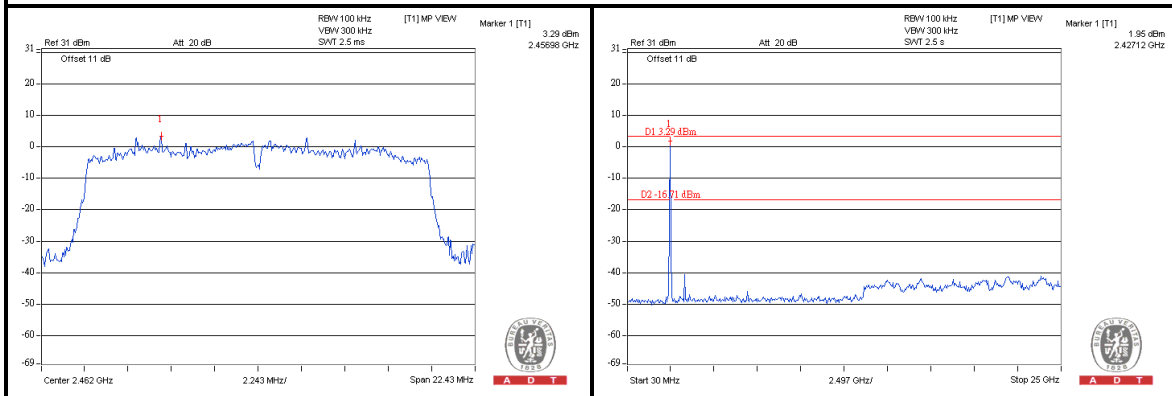



A D T

802.11n (40MHz): 1TX

CH 3

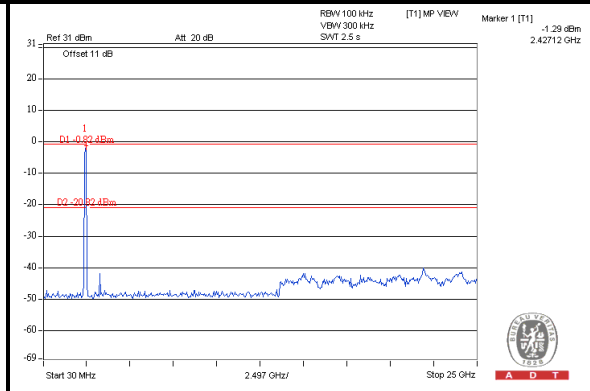
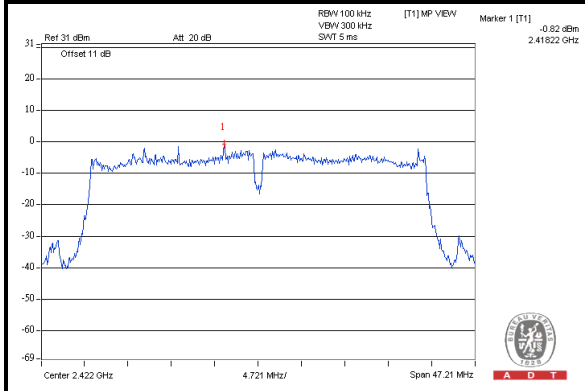

CH 6

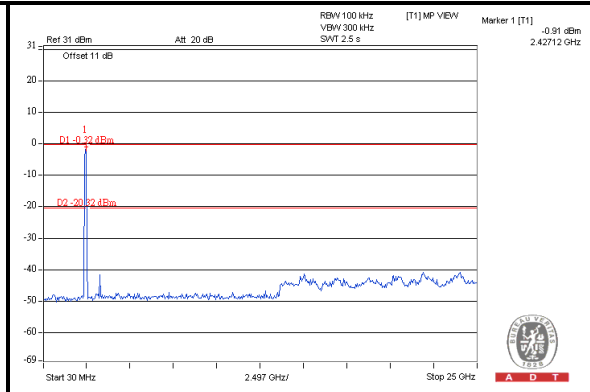
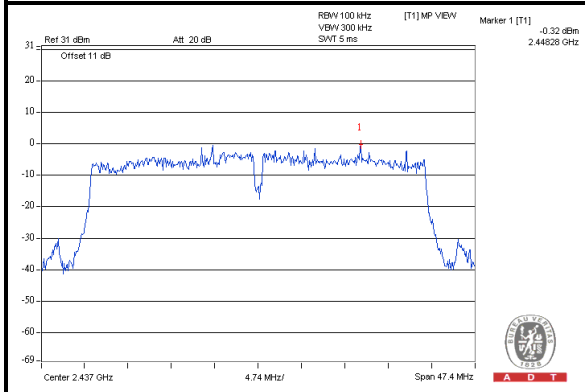

CH 9

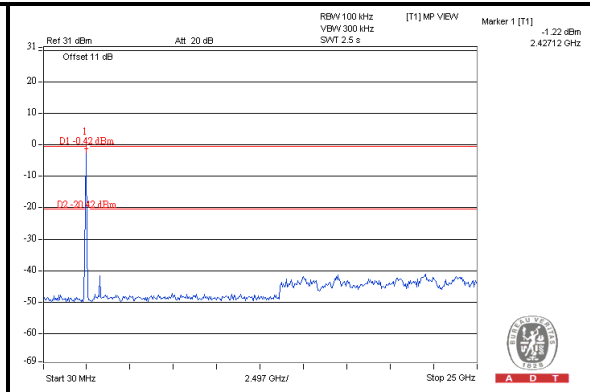
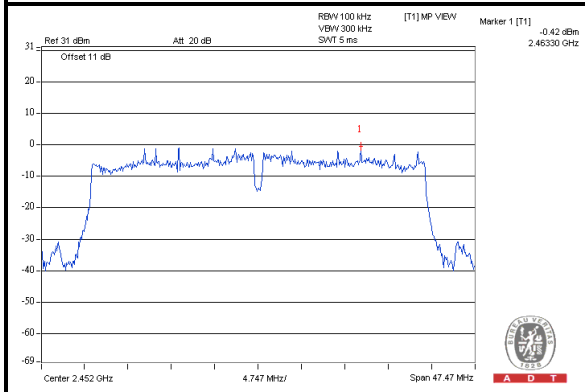



A D T

802.11n (20MHz): 2TX

CH 1

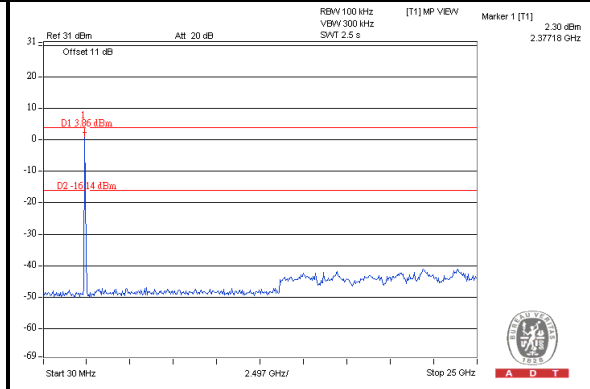
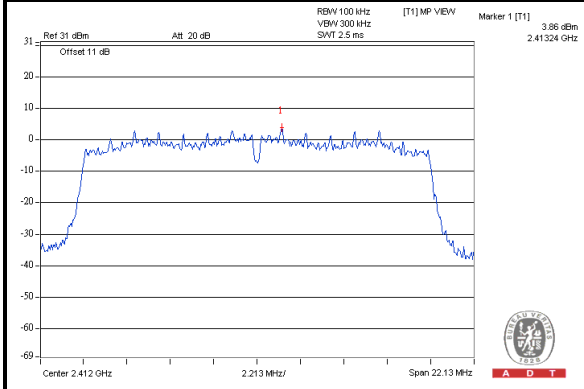

CH 6

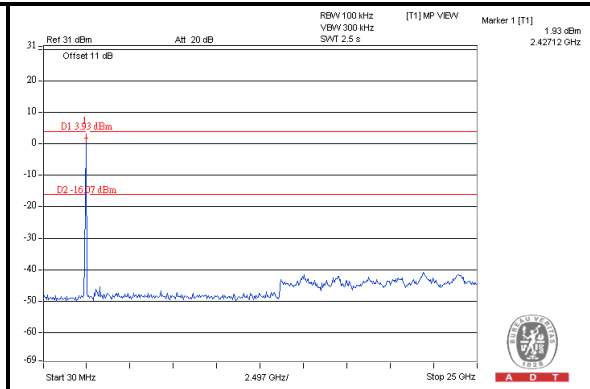
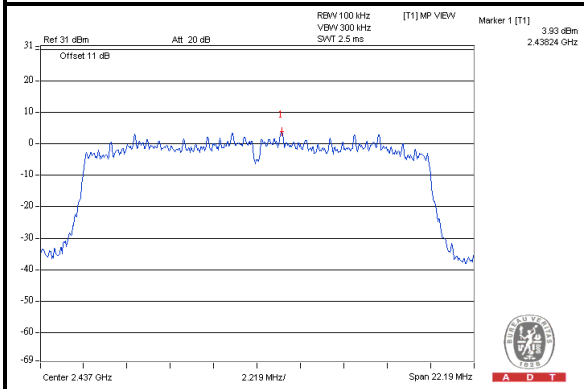

CH 11

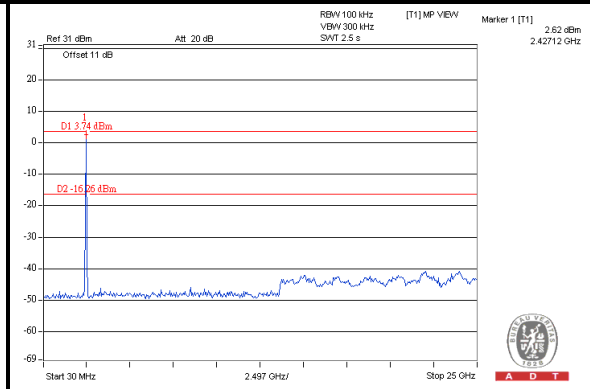
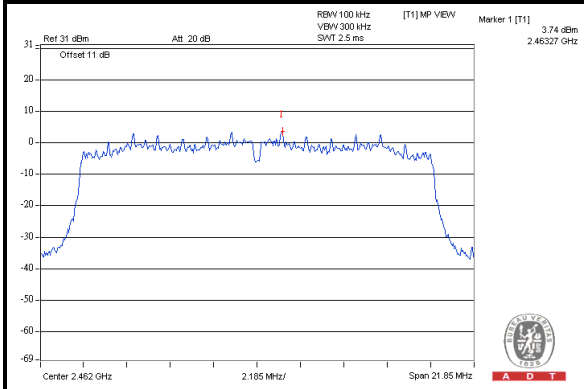



A D T

802.11n (40MHz): 2TX

CH 3

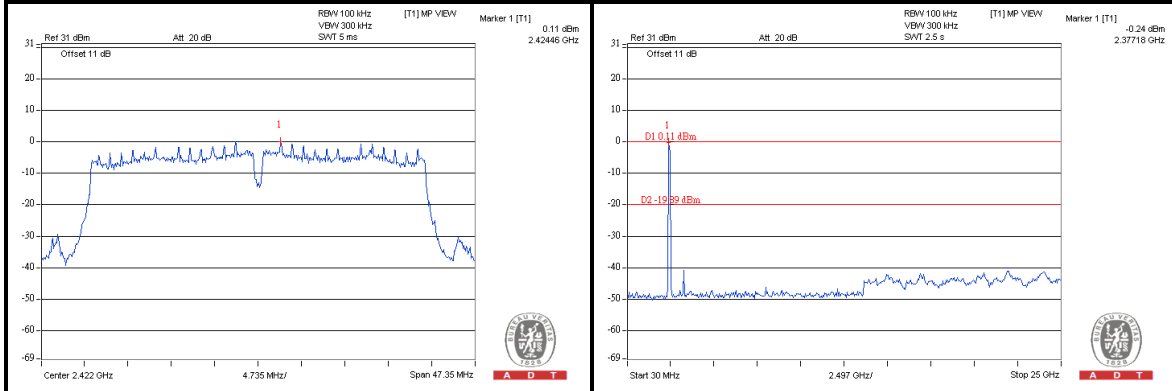

CH 6

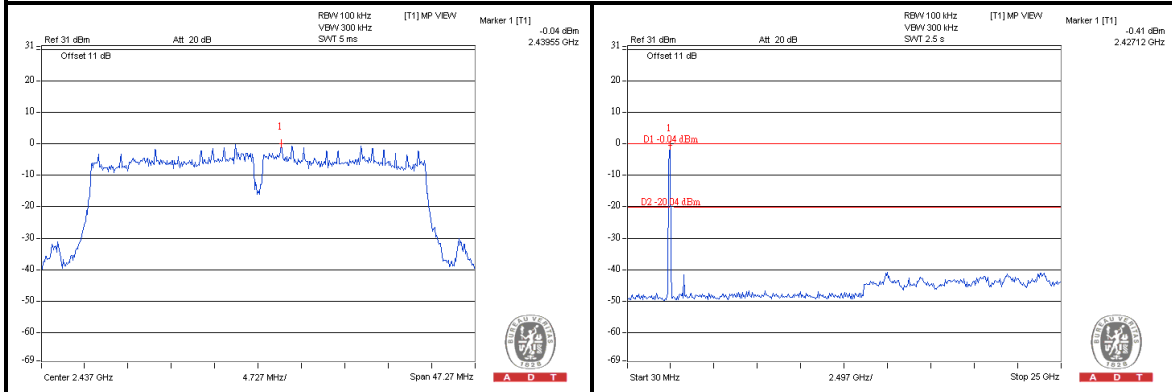

CH 9

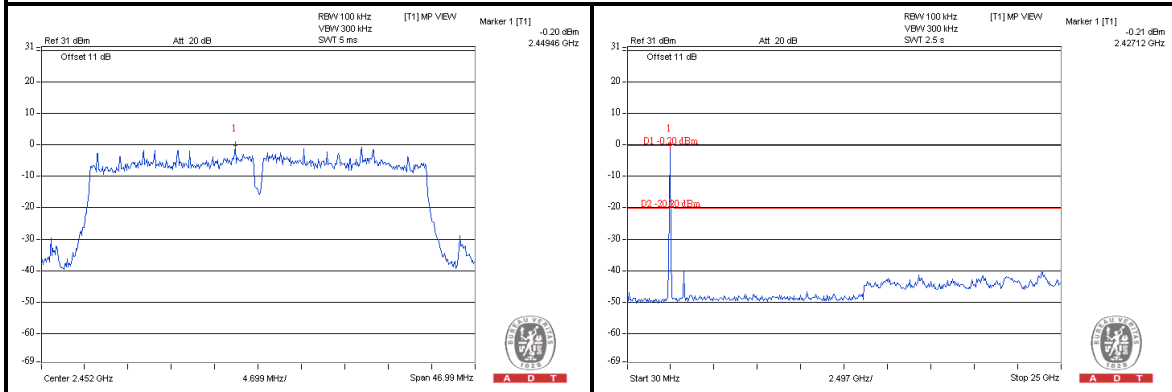

5. TEST TYPES AND RESULTS (FOR 5.0GHz BAND)

5.1 RADIATED EMISSION MEASUREMENT

5.1.1 LIMITS OF RADIATED EMISSION MEASUREMENT

Radiated emissions which fall in the restricted bands must comply with the radiated emission limits specified as below table. Other emissions shall be at least 20dB below the highest level of the desired power:

FREQUENCIES (MHz)	FIELD STRENGTH (microvolts/meter)	MEASUREMENT DISTANCE (meters)
0.009 ~ 0.490	2400/F(kHz)	300
0.490 ~ 1.705	24000/F(kHz)	30
1.705 ~ 30.0	30	30
30 ~ 88	100	3
88 ~ 216	150	3
216 ~ 960	200	3
Above 960	500	3

NOTE:

1. The lower limit shall apply at the transition frequencies.
2. Emission level (dBuV/m) = 20 log Emission level (uV/m).
3. For frequencies above 1000MHz, the field strength limits are based on average detector, however, the peak field strength of any emission shall not exceed the maximum permitted average limits, specified above by more than 20dB under any condition of modulation.

5.1.2 TEST INSTRUMENTS

Same as item 4.1.2.

5.1.3 TEST PROCEDURES

Same as item 4.1.3.

5.1.4 DEVIATION FROM TEST STANDARD

No deviation.

5.1.5 TEST SETUP

Same as item 4.1.5.

5.1.6 EUT OPERATING CONDITIONS

Same as 4.1.6.

5.1.7 TEST RESULTS

ABOVE 1GHz DATA:

802.11a: 1TX

EUT TEST CONDITION		MEASUREMENT DETAIL	
CHANNEL	Channel 149	FREQUENCY RANGE	1 ~ 40GHz
INPUT POWER (SYSTEM)	120Vac, 60 Hz	DETECTOR FUNCTION	Peak (PK) Average (AV)
ENVIRONMENTAL CONDITIONS	21deg. C, 68%RH	TESTED BY	Chad Lee

ANTENNA POLARITY & TEST DISTANCE: HORIZONTAL AT 3 M								
NO.	FREQ. (MHz)	EMISSION LEVEL (dBuV/m)	LIMIT (dBuV/m)	MARGIN (dB)	ANTENNA HEIGHT (m)	TABLE ANGLE (Degree)	RAW VALUE (dBuV)	CORRECTION FACTOR (dB/m)
1	#5725.00	73.6 PK	87.0	-13.5	1.00 H	197	35.24	38.31
2	#5725.00	51.3 AV	73.5	-22.3	1.00 H	197	12.97	38.31
3	*5745.00	107.0 PK			1.00 H	197	68.70	38.33
4	*5745.00	93.5 AV			1.00 H	197	55.21	38.33
5	11490.00	58.6 PK	74.0	-15.4	1.00 H	105	10.41	48.22
6	11490.00	48.5 AV	54.0	-5.5	1.00 H	105	0.24	48.22
ANTENNA POLARITY & TEST DISTANCE: VERTICAL AT 3 M								
NO.	FREQ. (MHz)	EMISSION LEVEL (dBuV/m)	LIMIT (dBuV/m)	MARGIN (dB)	ANTENNA HEIGHT (m)	TABLE ANGLE (Degree)	RAW VALUE (dBuV)	CORRECTION FACTOR (dB/m)
1	#5725.00	74.8 PK	88.3	-13.6	1.17 V	352	36.46	38.31
2	#5725.00	54.2 AV	74.6	-20.4	1.17 V	352	15.84	38.31
3	*5745.00	108.3 PK			1.17 V	352	69.99	38.33
4	*5745.00	94.6 AV			1.17 V	352	56.23	38.33
5	11490.00	57.7 PK	74.0	-16.3	1.00 V	2	9.49	48.22
6	11490.00	42.6 AV	54.0	-11.4	1.00 V	2	-5.62	48.22

REMARKS:

1. Emission level (dBuV/m) = Raw Value (dBuV) + Correction Factor (dB/m).
2. Correction Factor (dB/m) = Antenna Factor (dB/m) + Cable Factor (dB).
3. The other emission levels were very low against the limit.
4. Margin value = Emission level – Limit value.
5. “ * “: Fundamental frequency.
6. The limit value is defined as per 15.247.
7. "#":The radiated frequency is out the restricted band.



A D T

EUT TEST CONDITION		MEASUREMENT DETAIL	
CHANNEL	Channel 157	FREQUENCY RANGE	1 ~ 40GHz
INPUT POWER (SYSTEM)	120Vac, 60 Hz	DETECTOR FUNCTION	Peak (PK) Average (AV)
ENVIRONMENTAL CONDITIONS	21deg. C, 68%RH	TESTED BY	Chad Lee

ANTENNA POLARITY & TEST DISTANCE: HORIZONTAL AT 3 M								
NO.	FREQ. (MHz)	EMISSION LEVEL (dBuV/m)	LIMIT (dBuV/m)	MARGIN (dB)	ANTENNA HEIGHT (m)	TABLE ANGLE (Degree)	RAW VALUE (dBuV)	CORRECTION FACTOR (dB/m)
1	*5785.00	107.2 PK			1.03 H	184	68.76	38.39
2	*5785.00	94.3 AV			1.03 H	184	55.86	38.39
3	11570.00	58.2 PK	74.0	-15.8	1.00 H	182	10.01	48.21
4	11570.00	48.7 AV	54.0	-5.3	1.00 H	182	0.53	48.21
ANTENNA POLARITY & TEST DISTANCE: VERTICAL AT 3 M								
NO.	FREQ. (MHz)	EMISSION LEVEL (dBuV/m)	LIMIT (dBuV/m)	MARGIN (dB)	ANTENNA HEIGHT (m)	TABLE ANGLE (Degree)	RAW VALUE (dBuV)	CORRECTION FACTOR (dB/m)
1	*5785.00	108.2 PK			1.13 V	166	69.81	38.39
2	*5785.00	94.6 AV			1.13 V	166	56.24	38.39
3	11570.00	58.2 PK	74.0	-15.8	1.00 V	184	9.96	48.21
4	11570.00	43.4 AV	54.0	-10.6	1.00 V	184	-4.80	48.21

REMARKS:

1. Emission level (dBuV/m) = Raw Value (dBuV) + Correction Factor (dB/m).
2. Correction Factor (dB/m) = Antenna Factor (dB/m) + Cable Factor (dB).
3. The other emission levels were very low against the limit.
4. Margin value = Emission level – Limit value.
5. “ * “: Fundamental frequency.
6. The limit value is defined as per 15.247.



A D T

EUT TEST CONDITION		MEASUREMENT DETAIL	
CHANNEL	Channel 165	FREQUENCY RANGE	1 ~ 40GHz
INPUT POWER (SYSTEM)	120Vac, 60 Hz	DETECTOR FUNCTION	Peak (PK) Average (AV)
ENVIRONMENTAL CONDITIONS	21deg. C, 68%RH	TESTED BY	Chad Lee

ANTENNA POLARITY & TEST DISTANCE: HORIZONTAL AT 3 M								
NO.	FREQ. (MHz)	EMISSION LEVEL (dBuV/m)	LIMIT (dBuV/m)	MARGIN (dB)	ANTENNA HEIGHT (m)	TABLE ANGLE (Degree)	RAW VALUE (dBuV)	CORRECTION FACTOR (dB/m)
1	*5825.00	107.9 PK			1.11 H	196	69.49	38.45
2	*5825.00	94.7 AV			1.11 H	196	56.24	38.45
3	#5850.00	59.3 PK	87.9	-28.7	1.11 H	196	20.79	38.48
4	#5850.00	45.1 AV	74.7	-29.6	1.11 H	196	6.66	38.48
5	11650.00	59.0 PK	74.0	-15.0	1.14 H	10	10.86	48.16
6	11650.00	49.7 AV	54.0	-4.3	1.14 H	10	1.57	48.16
ANTENNA POLARITY & TEST DISTANCE: VERTICAL AT 3 M								
NO.	FREQ. (MHz)	EMISSION LEVEL (dBuV/m)	LIMIT (dBuV/m)	MARGIN (dB)	ANTENNA HEIGHT (m)	TABLE ANGLE (Degree)	RAW VALUE (dBuV)	CORRECTION FACTOR (dB/m)
1	*5825.00	108.7 PK			1.06 V	6	70.24	38.45
2	*5825.00	95.7 AV			1.06 V	6	57.21	38.45
3	#5850.00	62.3 PK	88.7	-26.4	1.06 V	6	23.86	38.48
4	#5850.00	47.2 AV	75.7	-28.4	1.06 V	6	8.74	38.48
5	11650.00	58.1 PK	74.0	-15.9	1.00 V	158	9.97	48.16
6	11650.00	43.0 AV	54.0	-11.0	1.00 V	158	-5.17	48.16

REMARKS:

1. Emission level (dBuV/m) = Raw Value (dBuV) + Correction Factor (dB/m).
2. Correction Factor (dB/m) = Antenna Factor (dB/m) + Cable Factor (dB).
3. The other emission levels were very low against the limit.
4. Margin value = Emission level – Limit value.
5. “ * “: Fundamental frequency.
6. The limit value is defined as per 15.247.
7. "#":The radiated frequency is out the restricted band.

802.11n (20MHz): 1TX

EUT TEST CONDITION		MEASUREMENT DETAIL	
CHANNEL	Channel 149	FREQUENCY RANGE	1 ~ 40GHz
INPUT POWER (SYSTEM)	120Vac, 60 Hz	DETECTOR FUNCTION	Peak (PK) Average (AV)
ENVIRONMENTAL CONDITIONS	21deg. C, 68%RH	TESTED BY	Chad Lee

ANTENNA POLARITY & TEST DISTANCE: HORIZONTAL AT 3 M								
NO.	FREQ. (MHz)	EMISSION LEVEL (dBuV/m)	LIMIT (dBuV/m)	MARGIN (dB)	ANTENNA HEIGHT (m)	TABLE ANGLE (Degree)	RAW VALUE (dBuV)	CORRECTION FACTOR (dB/m)
1	#5725.00	76.1 PK	86.7	-10.5	1.16 H	197	37.81	38.31
2	#5725.00	65.1 AV	73.5	-8.3	1.16 H	197	26.80	38.31
3	*5745.00	106.7 PK			1.16 H	197	68.32	38.33
4	*5745.00	93.5 AV			1.16 H	197	55.12	38.33
5	11490.00	59.7 PK	74.0	-14.3	1.00 H	119	11.47	48.22
6	11490.00	49.8 AV	54.0	-4.2	1.00 H	119	1.60	48.22

ANTENNA POLARITY & TEST DISTANCE: VERTICAL AT 3 M								
NO.	FREQ. (MHz)	EMISSION LEVEL (dBuV/m)	LIMIT (dBuV/m)	MARGIN (dB)	ANTENNA HEIGHT (m)	TABLE ANGLE (Degree)	RAW VALUE (dBuV)	CORRECTION FACTOR (dB/m)
1	#5725.00	77.2 PK	87.2	-10.0	1.17 V	8	38.89	38.31
2	#5725.00	66.8 AV	73.6	-6.8	1.17 V	8	28.47	38.31
3	*5745.00	107.2 PK			1.17 V	8	68.86	38.33
4	*5745.00	93.6 AV			1.17 V	8	55.22	38.33
5	11490.00	56.7 PK	74.0	-17.3	1.00 V	308	8.49	48.22
6	11490.00	42.3 AV	54.0	-11.7	1.00 V	308	-5.93	48.22

REMARKS:

1. Emission level (dBuV/m) = Raw Value (dBuV) + Correction Factor (dB/m).
2. Correction Factor (dB/m) = Antenna Factor (dB/m) + Cable Factor (dB).
3. The other emission levels were very low against the limit.
4. Margin value = Emission level – Limit value.
5. “ * “: Fundamental frequency.
6. The limit value is defined as per 15.247.
7. "#":The radiated frequency is out the restricted band.



A D T

EUT TEST CONDITION		MEASUREMENT DETAIL	
CHANNEL	Channel 157	FREQUENCY RANGE	1 ~ 40GHz
INPUT POWER (SYSTEM)	120Vac, 60 Hz	DETECTOR FUNCTION	Peak (PK) Average (AV)
ENVIRONMENTAL CONDITIONS	21deg. C, 68%RH	TESTED BY	Chad Lee

ANTENNA POLARITY & TEST DISTANCE: HORIZONTAL AT 3 M								
NO.	FREQ. (MHz)	EMISSION LEVEL (dBuV/m)	LIMIT (dBuV/m)	MARGIN (dB)	ANTENNA HEIGHT (m)	TABLE ANGLE (Degree)	RAW VALUE (dBuV)	CORRECTION FACTOR (dB/m)
1	*5785.00	106.9 PK			1.20 H	201	68.55	38.39
2	*5785.00	93.2 AV			1.20 H	201	54.83	38.39
3	11570.00	59.7 PK	74.0	-14.3	1.00 H	20	11.52	48.21
4	11570.00	50.0 AV	54.0	-4.0	1.00 H	20	1.75	48.21
ANTENNA POLARITY & TEST DISTANCE: VERTICAL AT 3 M								
NO.	FREQ. (MHz)	EMISSION LEVEL (dBuV/m)	LIMIT (dBuV/m)	MARGIN (dB)	ANTENNA HEIGHT (m)	TABLE ANGLE (Degree)	RAW VALUE (dBuV)	CORRECTION FACTOR (dB/m)
1	*5785.00	107.0 PK			1.16 V	10	68.64	38.39
2	*5785.00	93.5 AV			1.16 V	10	55.15	38.39
3	11570.00	56.8 PK	74.0	-17.2	1.00 V	148	8.62	48.21
4	11570.00	42.4 AV	54.0	-11.6	1.00 V	148	-5.85	48.21

REMARKS:

1. Emission level (dBuV/m) = Raw Value (dBuV) + Correction Factor (dB/m).
2. Correction Factor (dB/m) = Antenna Factor (dB/m) + Cable Factor (dB).
3. The other emission levels were very low against the limit.
4. Margin value = Emission level – Limit value.
5. “ * “: Fundamental frequency.
6. The limit value is defined as per 15.247.



A D T

EUT TEST CONDITION		MEASUREMENT DETAIL	
CHANNEL	Channel 165	FREQUENCY RANGE	1 ~ 40GHz
INPUT POWER (SYSTEM)	120Vac, 60 Hz	DETECTOR FUNCTION	Peak (PK) Average (AV)
ENVIRONMENTAL CONDITIONS	21deg. C, 68%RH	TESTED BY	Chad Lee

ANTENNA POLARITY & TEST DISTANCE: HORIZONTAL AT 3 M								
NO.	FREQ. (MHz)	EMISSION LEVEL (dBuV/m)	LIMIT (dBuV/m)	MARGIN (dB)	ANTENNA HEIGHT (m)	TABLE ANGLE (Degree)	RAW VALUE (dBuV)	CORRECTION FACTOR (dB/m)
1	*5825.00	106.4 PK			1.09 H	203	67.95	38.45
2	*5825.00	92.8 AV			1.09 H	203	54.32	38.45
3	#5850.00	62.1 PK	86.4	-24.3	1.09 H	203	23.66	38.48
4	#5850.00	45.2 AV	72.8	-27.5	1.09 H	203	6.75	38.48
5	11650.00	59.1 PK	74.0	-14.9	1.00 H	224	10.97	48.16
6	11650.00	49.6 AV	54.0	-4.4	1.00 H	224	1.45	48.16
ANTENNA POLARITY & TEST DISTANCE: VERTICAL AT 3 M								
NO.	FREQ. (MHz)	EMISSION LEVEL (dBuV/m)	LIMIT (dBuV/m)	MARGIN (dB)	ANTENNA HEIGHT (m)	TABLE ANGLE (Degree)	RAW VALUE (dBuV)	CORRECTION FACTOR (dB/m)
1	*5825.00	107.8 PK			1.14 V	6	69.36	38.45
2	*5825.00	94.7 AV			1.14 V	6	56.24	38.45
3	#5850.00	62.8 PK	87.8	-25.0	1.14 V	6	24.30	38.48
4	#5850.00	46.7 AV	74.7	-28.0	1.14 V	6	8.20	38.48
5	11650.00	58.1 PK	74.0	-15.9	1.00 V	109	9.97	48.16
6	11650.00	43.0 AV	54.0	-11.0	1.00 V	109	-5.17	48.16

REMARKS:

1. Emission level (dBuV/m) = Raw Value (dBuV) + Correction Factor (dB/m).
2. Correction Factor (dB/m) = Antenna Factor (dB/m) + Cable Factor (dB).
3. The other emission levels were very low against the limit.
4. Margin value = Emission level – Limit value.
5. “ * “: Fundamental frequency.
6. The limit value is defined as per 15.247.
7. "#":The radiated frequency is out the restricted band.

802.11n (40MHz): 1TX

EUT TEST CONDITION		MEASUREMENT DETAIL	
CHANNEL	Channel 151	FREQUENCY RANGE	1 ~ 40GHz
INPUT POWER (SYSTEM)	120Vac, 60 Hz	DETECTOR FUNCTION	Peak (PK) Average (AV)
ENVIRONMENTAL CONDITIONS	24deg. C, 86%RH	TESTED BY	Chad Lee

ANTENNA POLARITY & TEST DISTANCE: HORIZONTAL AT 3 M								
NO.	FREQ. (MHz)	EMISSION LEVEL (dBuV/m)	LIMIT (dBuV/m)	MARGIN (dB)	ANTENNA HEIGHT (m)	TABLE ANGLE (Degree)	RAW VALUE (dBuV)	CORRECTION FACTOR (dB/m)
1	#5725.00	72.4 PK	80.9	-8.6	1.07 H	314	32.37	39.99
2	#5725.00	48.2 AV	67.2	-19.1	1.07 H	314	8.20	39.99
3	*5755.00	100.9 PK			1.07 H	341	60.93	40.00
4	*5755.00	87.2 AV			1.07 H	341	47.24	40.00
5	11510.00	57.7 PK	74.0	-16.3	1.00 H	101	10.48	47.22
6	11510.00	47.8 AV	54.0	-6.2	1.00 H	101	0.62	47.22

ANTENNA POLARITY & TEST DISTANCE: VERTICAL AT 3 M								
NO.	FREQ. (MHz)	EMISSION LEVEL (dBuV/m)	LIMIT (dBuV/m)	MARGIN (dB)	ANTENNA HEIGHT (m)	TABLE ANGLE (Degree)	RAW VALUE (dBuV)	CORRECTION FACTOR (dB/m)
1	#5725.00	73.9 PK	82.0	-8.1	1.32 V	145	33.93	39.98
2	#5725.00	50.1 AV	70.1	-20.0	1.32 V	145	10.14	39.98
3	*5755.00	102.0 PK			1.34 V	145	62.03	39.99
4	*5755.00	90.1 AV			1.34 V	145	50.13	39.99
5	11510.00	57.8 PK	74.0	-16.2	1.00 V	109	10.58	47.22
6	11510.00	42.0 AV	54.0	-12.0	1.00 V	109	-5.19	47.22

REMARKS:

1. Emission level (dBuV/m) = Raw Value (dBuV) + Correction Factor (dB/m).
2. Correction Factor (dB/m) = Antenna Factor (dB/m) + Cable Factor (dB).
3. The other emission levels were very low against the limit.
4. Margin value = Emission level – Limit value.
5. “ * “: Fundamental frequency.
6. The limit value is defined as per 15.247.
7. "#":The radiated frequency is out the restricted band.



A D T

EUT TEST CONDITION		MEASUREMENT DETAIL	
CHANNEL	Channel 159	FREQUENCY RANGE	1 ~ 40GHz
INPUT POWER (SYSTEM)	120Vac, 60 Hz	DETECTOR FUNCTION	Peak (PK) Average (AV)
ENVIRONMENTAL CONDITIONS	24deg. C, 86%RH	TESTED BY	Chad Lee

ANTENNA POLARITY & TEST DISTANCE: HORIZONTAL AT 3 M								
NO.	FREQ. (MHz)	EMISSION LEVEL (dBuV/m)	LIMIT (dBuV/m)	MARGIN (dB)	ANTENNA HEIGHT (m)	TABLE ANGLE (Degree)	RAW VALUE (dBuV)	CORRECTION FACTOR (dB/m)
1	*5795.00	101.0 PK			1.31 H	180	60.95	40.01
2	*5795.00	88.8 AV			1.31 H	180	48.83	40.01
3	#5850.00	52.4 PK	81.0	-28.6	1.31 H	180	12.33	40.03
4	#5850.00	36.1 AV	68.8	-32.7	1.31 H	180	-3.89	40.03
5	11590.00	58.0 PK	74.0	-16.0	1.00 H	159	10.66	47.30
6	11590.00	48.0 AV	54.0	-6.0	1.00 H	159	0.66	47.30
ANTENNA POLARITY & TEST DISTANCE: VERTICAL AT 3 M								
NO.	FREQ. (MHz)	EMISSION LEVEL (dBuV/m)	LIMIT (dBuV/m)	MARGIN (dB)	ANTENNA HEIGHT (m)	TABLE ANGLE (Degree)	RAW VALUE (dBuV)	CORRECTION FACTOR (dB/m)
1	*5795.00	102.1 PK			1.21 V	16	62.12	40.01
2	*5795.00	90.1 AV			1.21 V	16	50.12	40.01
3	#5850.00	54.5 PK	82.1	-27.7	1.21 V	16	14.42	40.03
4	#5850.00	38.3 AV	70.1	-31.8	1.21 V	16	-1.69	40.03
5	11590.00	58.4 PK	74.0	-15.6	1.00 V	5	11.11	47.30
6	11590.00	43.2 AV	54.0	-10.8	1.00 V	5	-4.07	47.30

REMARKS:

1. Emission level (dBuV/m) = Raw Value (dBuV) + Correction Factor (dB/m).
2. Correction Factor (dB/m) = Antenna Factor (dB/m) + Cable Factor (dB).
3. The other emission levels were very low against the limit.
4. Margin value = Emission level – Limit value.
5. “ * “: Fundamental frequency.
6. The limit value is defined as per 15.247.
7. "#":The radiated frequency is out the restricted band.

802.11n (20MHz): 2TX

EUT TEST CONDITION		MEASUREMENT DETAIL	
CHANNEL	Channel 149	FREQUENCY RANGE	1 ~ 40GHz
INPUT POWER (SYSTEM)	120Vac, 60 Hz	DETECTOR FUNCTION	Peak (PK) Average (AV)
ENVIRONMENTAL CONDITIONS	24deg. C, 86%RH	TESTED BY	Chad Lee

ANTENNA POLARITY & TEST DISTANCE: HORIZONTAL AT 3 M								
NO.	FREQ. (MHz)	EMISSION LEVEL (dBuV/m)	LIMIT (dBuV/m)	MARGIN (dB)	ANTENNA HEIGHT (m)	TABLE ANGLE (Degree)	RAW VALUE (dBuV)	CORRECTION FACTOR (dB/m)
1	#5725.00	61.2 PK	81.7	-20.4	1.35 H	341	22.91	38.31
2	#5725.00	45.1 AV	68.5	-23.4	1.35 H	341	6.75	38.31
3	*5745.00	101.7 PK			1.35 H	341	63.33	38.33
4	*5745.00	88.5 AV			1.35 H	341	50.12	38.33
5	11490.00	57.3 PK	74.0	-16.7	1.00 H	163	9.09	48.22
6	11490.00	47.1 AV	54.0	-6.9	1.00 H	163	-1.11	48.22

ANTENNA POLARITY & TEST DISTANCE: VERTICAL AT 3 M								
NO.	FREQ. (MHz)	EMISSION LEVEL (dBuV/m)	LIMIT (dBuV/m)	MARGIN (dB)	ANTENNA HEIGHT (m)	TABLE ANGLE (Degree)	RAW VALUE (dBuV)	CORRECTION FACTOR (dB/m)
1	#5725.00	63.5 PK	84.5	-21.0	1.00 V	6	25.19	38.31
2	#5725.00	47.3 AV	71.6	-24.3	1.00 V	6	9.00	38.31
3	*5745.00	104.5 PK			1.28 V	146	66.20	38.33
4	*5745.00	91.6 AV			1.28 V	146	53.23	38.33
5	11490.00	55.7 PK	74.0	-18.3	1.00 V	159	7.49	48.22
6	11490.00	42.9 AV	54.0	-11.1	1.00 V	159	-5.29	48.22

REMARKS:

1. Emission level (dBuV/m) = Raw Value (dBuV) + Correction Factor (dB/m).
2. Correction Factor (dB/m) = Antenna Factor (dB/m) + Cable Factor (dB).
3. The other emission levels were very low against the limit.
4. Margin value = Emission level – Limit value.
5. “ * “: Fundamental frequency.
6. The limit value is defined as per 15.247.
7. "#":The radiated frequency is out the restricted band.



A D T

EUT TEST CONDITION		MEASUREMENT DETAIL	
CHANNEL	Channel 157	FREQUENCY RANGE	1 ~ 40GHz
INPUT POWER (SYSTEM)	120Vac, 60 Hz	DETECTOR FUNCTION	Peak (PK) Average (AV)
ENVIRONMENTAL CONDITIONS	24deg. C, 86%RH	TESTED BY	Chad Lee

ANTENNA POLARITY & TEST DISTANCE: HORIZONTAL AT 3 M								
NO.	FREQ. (MHz)	EMISSION LEVEL (dBuV/m)	LIMIT (dBuV/m)	MARGIN (dB)	ANTENNA HEIGHT (m)	TABLE ANGLE (Degree)	RAW VALUE (dBuV)	CORRECTION FACTOR (dB/m)
1	*5785.00	101.6 PK			1.33 H	310	63.23	38.39
2	*5785.00	88.4 AV			1.33 H	310	49.97	38.39
3	11570.00	56.4 PK	74.0	-17.6	1.00 H	158	8.15	48.21
4	11570.00	36.1 AV	54.0	-17.9	1.00 H	158	-12.07	48.21
ANTENNA POLARITY & TEST DISTANCE: VERTICAL AT 3 M								
NO.	FREQ. (MHz)	EMISSION LEVEL (dBuV/m)	LIMIT (dBuV/m)	MARGIN (dB)	ANTENNA HEIGHT (m)	TABLE ANGLE (Degree)	RAW VALUE (dBuV)	CORRECTION FACTOR (dB/m)
1	*5785.00	104.4 PK			1.28 V	146	65.97	38.39
2	*5785.00	91.2 AV			1.28 V	146	52.85	38.39
3	11570.00	56.4 PK	74.0	-17.6	1.00 V	9	8.15	48.21
4	11570.00	41.3 AV	54.0	-12.8	1.00 V	9	-6.96	48.21

REMARKS:

1. Emission level (dBuV/m) = Raw Value (dBuV) + Correction Factor (dB/m).
2. Correction Factor (dB/m) = Antenna Factor (dB/m) + Cable Factor (dB).
3. The other emission levels were very low against the limit.
4. Margin value = Emission level – Limit value.
5. “ * “: Fundamental frequency.
6. The limit value is defined as per 15.247.



A D T

EUT TEST CONDITION		MEASUREMENT DETAIL	
CHANNEL	Channel 165	FREQUENCY RANGE	1 ~ 40GHz
INPUT POWER (SYSTEM)	120Vac, 60 Hz	DETECTOR FUNCTION	Peak (PK) Average (AV)
ENVIRONMENTAL CONDITIONS	24deg. C, 86%RH	TESTED BY	Chad Lee

ANTENNA POLARITY & TEST DISTANCE: HORIZONTAL AT 3 M								
NO.	FREQ. (MHz)	EMISSION LEVEL (dBuV/m)	LIMIT (dBuV/m)	MARGIN (dB)	ANTENNA HEIGHT (m)	TABLE ANGLE (Degree)	RAW VALUE (dBuV)	CORRECTION FACTOR (dB/m)
1	*5825.00	101.2 PK			1.35 H	28	62.77	38.45
2	*5825.00	87.3 AV			1.35 H	28	48.80	38.45
3	#5850.00	52.2 PK	81.2	-29.1	1.35 H	28	13.68	38.48
4	#5850.00	37.3 AV	67.3	-30.0	1.35 H	28	-1.23	38.48
5	11650.00	57.3 PK	74.0	-16.7	1.00 H	153	9.17	48.16
6	11650.00	47.1 AV	54.0	-6.9	1.00 H	153	-1.02	48.16
ANTENNA POLARITY & TEST DISTANCE: VERTICAL AT 3 M								
NO.	FREQ. (MHz)	EMISSION LEVEL (dBuV/m)	LIMIT (dBuV/m)	MARGIN (dB)	ANTENNA HEIGHT (m)	TABLE ANGLE (Degree)	RAW VALUE (dBuV)	CORRECTION FACTOR (dB/m)
1	*5825.00	104.1 PK			1.36 V	346	65.64	38.45
2	*5825.00	90.6 AV			1.36 V	346	52.11	38.45
3	#5850.00	54.3 PK	84.1	-29.8	1.36 V	346	15.81	38.48
4	#5850.00	39.3 AV	70.6	-31.2	1.36 V	346	0.86	38.48
5	11650.00	57.1 PK	74.0	-16.9	1.12 V	341	8.97	48.16
6	11650.00	43.4 AV	54.0	-10.7	1.12 V	341	-4.81	48.16

REMARKS:

1. Emission level (dBuV/m) = Raw Value (dBuV) + Correction Factor (dB/m).
2. Correction Factor (dB/m) = Antenna Factor (dB/m) + Cable Factor (dB).
3. The other emission levels were very low against the limit.
4. Margin value = Emission level – Limit value.
5. “ * “: Fundamental frequency.
6. The limit value is defined as per 15.247.
7. "#":The radiated frequency is out the restricted band.

802.11n (40MHz): 2TX

EUT TEST CONDITION		MEASUREMENT DETAIL	
CHANNEL	Channel 151	FREQUENCY RANGE	1 ~ 40GHz
INPUT POWER (SYSTEM)	120Vac, 60 Hz	DETECTOR FUNCTION	Peak (PK) Average (AV)
ENVIRONMENTAL CONDITIONS	24deg. C, 86%RH	TESTED BY	Chad Lee

ANTENNA POLARITY & TEST DISTANCE: HORIZONTAL AT 3 M								
NO.	FREQ. (MHz)	EMISSION LEVEL (dBuV/m)	LIMIT (dBuV/m)	MARGIN (dB)	ANTENNA HEIGHT (m)	TABLE ANGLE (Degree)	RAW VALUE (dBuV)	CORRECTION FACTOR (dB/m)
1	#5725.00	65.3 PK	81.4	-16.0	1.15 H	339	25.36	39.98
2	#5725.00	46.8 AV	61.2	-14.4	1.15 H	339	6.86	39.98
3	*5755.00	101.4 PK			1.15 H	339	61.39	39.99
4	*5755.00	81.2 AV			1.15 H	339	41.22	39.99
5	11510.00	57.8 PK	74.0	-16.2	1.00 H	34	10.58	47.22
6	11510.00	48.3 AV	54.0	-5.7	1.00 H	34	1.06	47.22

ANTENNA POLARITY & TEST DISTANCE: VERTICAL AT 3 M								
NO.	FREQ. (MHz)	EMISSION LEVEL (dBuV/m)	LIMIT (dBuV/m)	MARGIN (dB)	ANTENNA HEIGHT (m)	TABLE ANGLE (Degree)	RAW VALUE (dBuV)	CORRECTION FACTOR (dB/m)
1	#5725.00	66.9 PK	82.3	-15.5	1.24 V	40	26.88	39.98
2	#5725.00	47.8 AV	62.9	-15.1	1.24 V	40	7.84	39.98
3	*5755.00	102.3 PK			1.24 V	40	62.33	39.99
4	*5755.00	82.9 AV			1.24 V	40	42.94	39.99
5	11510.00	57.3 PK	74.0	-16.7	1.00 V	110	10.09	47.22
6	11510.00	42.4 AV	54.0	-11.6	1.00 V	110	-4.82	47.22

REMARKS:

1. Emission level (dBuV/m) = Raw Value (dBuV) + Correction Factor (dB/m).
2. Correction Factor (dB/m) = Antenna Factor (dB/m) + Cable Factor (dB).
3. The other emission levels were very low against the limit.
4. Margin value = Emission level – Limit value.
5. “ * “: Fundamental frequency.
6. The limit value is defined as per 15.247.
7. "#":The radiated frequency is out the restricted band.



A D T

EUT TEST CONDITION		MEASUREMENT DETAIL	
CHANNEL	Channel 159	FREQUENCY RANGE	1 ~ 40GHz
INPUT POWER (SYSTEM)	120Vac, 60 Hz	DETECTOR FUNCTION	Peak (PK) Average (AV)
ENVIRONMENTAL CONDITIONS	24deg. C, 86%RH	TESTED BY	Chad Lee

ANTENNA POLARITY & TEST DISTANCE: HORIZONTAL AT 3 M								
NO.	FREQ. (MHz)	EMISSION LEVEL (dBuV/m)	LIMIT (dBuV/m)	MARGIN (dB)	ANTENNA HEIGHT (m)	TABLE ANGLE (Degree)	RAW VALUE (dBuV)	CORRECTION FACTOR (dB/m)
1	*5795.00	99.4 PK			1.11 H	16	59.35	40.01
2	*5795.00	79.9 AV			1.11 H	16	39.88	40.01
3	#5850.00	47.4 PK	79.4	-32.0	1.11 H	16	7.33	40.03
4	#5850.00	36.1 AV	59.9	-23.8	1.11 H	16	-3.93	40.03
5	11590.00	57.5 PK	74.0	-16.6	1.00 H	1	10.15	47.30
6	11590.00	48.0 AV	54.0	-6.0	1.00 H	1	0.70	47.30
ANTENNA POLARITY & TEST DISTANCE: VERTICAL AT 3 M								
NO.	FREQ. (MHz)	EMISSION LEVEL (dBuV/m)	LIMIT (dBuV/m)	MARGIN (dB)	ANTENNA HEIGHT (m)	TABLE ANGLE (Degree)	RAW VALUE (dBuV)	CORRECTION FACTOR (dB/m)
1	*5795.00	101.1 PK			1.25 V	341	61.05	40.01
2	*5795.00	81.4 AV			1.25 V	341	41.36	40.01
3	#5850.00	49.2 PK	81.1	-31.8	1.25 V	341	9.21	40.03
4	#5850.00	37.1 AV	61.4	-24.3	1.25 V	341	-2.92	40.03
5	11590.00	57.4 PK	74.0	-16.6	1.00 V	143	10.12	47.30
6	11590.00	42.6 AV	54.0	-11.4	1.00 V	143	-4.70	47.30

REMARKS:

1. Emission level (dBuV/m) = Raw Value (dBuV) + Correction Factor (dB/m).
2. Correction Factor (dB/m) = Antenna Factor (dB/m) + Cable Factor (dB).
3. The other emission levels were very low against the limit.
4. Margin value = Emission level – Limit value.
5. “ * “: Fundamental frequency.
6. The limit value is defined as per 15.247.
7. "#":The radiated frequency is out the restricted band.

BELOW 1GHz WORST-CASE DATA :

802.11n (20MHz): 2TX

EUT TEST CONDITION		MEASUREMENT DETAIL	
CHANNEL	Channel 149	FREQUENCY RANGE	Below 1000MHz
INPUT POWER (SYSTEM)	120Vac, 60 Hz	DETECTOR FUNCTION	Quasi-Peak
ENVIRONMENTAL CONDITIONS	25deg. C, 89%RH	TESTED BY	Chad Lee

ANTENNA POLARITY & TEST DISTANCE: HORIZONTAL AT 3 M								
NO.	FREQ. (MHz)	EMISSION LEVEL (dBuV/m)	LIMIT (dBuV/m)	MARGIN (dB)	ANTENNA HEIGHT (m)	TABLE ANGLE (Degree)	RAW VALUE (dBuV)	CORRECTION FACTOR (dB/m)
1	203.54	31.7 QP	43.5	-11.8	1.00 H	136	20.48	11.26
2	305.83	33.1 QP	46.0	-12.9	1.14 H	7	17.52	15.56
3	499.25	37.0 QP	46.0	-9.0	1.03 H	172	15.95	21.02
4	662.12	35.5 QP	46.0	-10.5	1.00 H	85	11.43	24.04
5	713.02	35.4 QP	46.0	-10.6	1.00 H	10	10.63	24.77
6	763.92	37.1 QP	46.0	-8.9	1.00 H	130	11.46	25.65

ANTENNA POLARITY & TEST DISTANCE: VERTICAL AT 3 M								
NO.	FREQ. (MHz)	EMISSION LEVEL (dBuV/m)	LIMIT (dBuV/m)	MARGIN (dB)	ANTENNA HEIGHT (m)	TABLE ANGLE (Degree)	RAW VALUE (dBuV)	CORRECTION FACTOR (dB/m)
1	42.60	29.2 QP	40.0	-10.9	1.00 V	235	15.19	13.96
2	500.21	33.8 QP	46.0	-12.2	1.00 V	145	12.77	21.04
3	663.58	29.7 QP	46.0	-16.3	1.00 V	103	5.65	24.06
4	713.02	31.8 QP	46.0	-14.2	1.00 V	283	7.06	24.77
5	763.92	29.7 QP	46.0	-16.3	1.00 V	247	4.05	25.65
6	831.30	31.4 QP	46.0	-14.7	1.00 V	10	4.59	26.76

REMARKS:

1. Emission level (dBuV/m) = Raw Value (dBuV) + Correction Factor (dB/m).
2. Correction Factor (dB/m) = Antenna Factor (dB/m) + Cable Factor (dB).
3. The other emission levels were very low against the limit.
4. Margin value = Emission level – Limit value.

5.2 CONDUCTED EMISSION MEASUREMENT

5.2.1 LIMITS OF CONDUCTED EMISSION MEASUREMENT

FREQUENCY OF EMISSION (MHz)	CONDUCTED LIMIT (dB μ V)	
	Quasi-peak	Average
0.15 ~ 0.5	66 to 56	56 to 46
0.5 ~ 5	56	46
5 ~ 30	60	50

- NOTE:**
1. The lower limit shall apply at the transition frequencies.
 2. The limit decreases in line with the logarithm of the frequency in the range of 0.15 to 0.50MHz.
 3. All emanations from a class A/B digital device or system, including any network of conductors and apparatus connected thereto, shall not exceed the level of field strengths specified above.

5.2.2 TEST INSTRUMENTS

Same as item 4.2.2.

5.2.3 TEST PROCEDURES

Same as item 4.2.3.

5.2.4 DEVIATION FROM TEST STANDARD

No deviation.

5.2.5 TEST SETUP

Same as item 4.2.5.

5.2.6 EUT OPERATING CONDITIONS

Same as 4.1.6



A D T

5.2.7 TEST RESULTS

CONDUCTED WORST-CASE DATA :

802.11a (20MHz): 2TX

PHASE	Line 1	6dB BANDWIDTH	9kHz
-------	--------	---------------	------

No	Freq. [MHz]	Corr. Factor (dB)	Reading Value [dB (uV)]		Emission Level [dB (uV)]		Limit [dB (uV)]		Margin (dB)	
			Q.P.	AV.	Q.P.	AV.	Q.P.	AV.	Q.P.	AV.
			1	0.16562	0.17	17.84	8.65	18.01	8.82	65.18
2	0.38047	0.20	31.73	29.58	31.93	29.78	58.27	48.27	-26.34	-18.49
3	1.94531	0.30	28.71	22.66	29.01	22.96	56.00	46.00	-26.99	-23.04
4	4.41406	0.40	21.28	12.92	21.68	13.32	56.00	46.00	-34.32	-32.68
5	11.26563	0.51	21.71	16.27	22.22	16.78	60.00	50.00	-37.78	-33.22
6	18.02344	0.68	29.38	23.53	30.06	24.21	60.00	50.00	-29.94	-25.79

REMARKS:

1. Q.P. and AV. are abbreviations of quasi-peak and average individually.
2. The emission levels of other frequencies were very low against the limit.
3. Margin value = Emission level - Limit value
4. Correction factor = Insertion loss + Cable loss
5. Emission Level = Correction Factor + Reading Value.

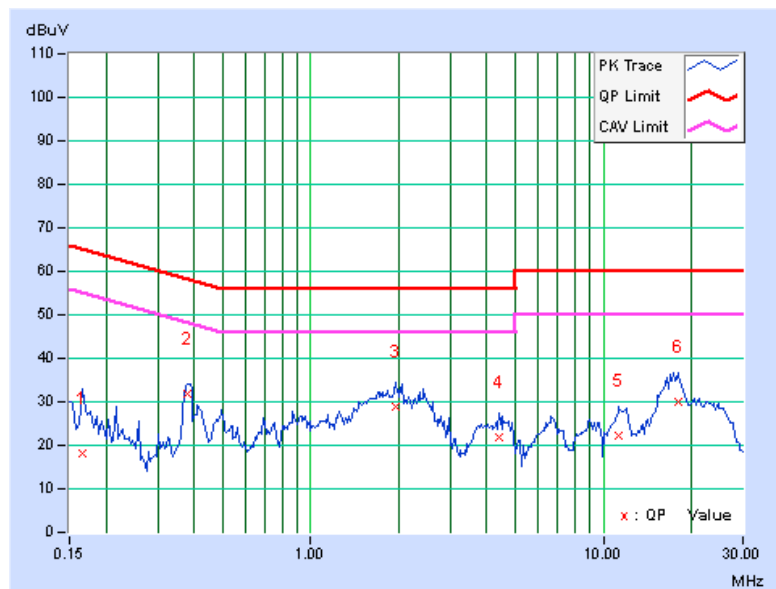



A D T

PHASE	Line 2	6dB BANDWIDTH	9kHz
-------	--------	---------------	------

No	Freq. [MHz]	Corr. Factor (dB)	Reading Value [dB (uV)]		Emission Level [dB (uV)]		Limit [dB (uV)]		Margin (dB)	
			Q.P.	AV.	Q.P.	AV.	Q.P.	AV.	Q.P.	AV.
			1	0.16172	0.17	26.58	18.69	26.75	18.86	65.38
2	0.38828	0.18	31.34	24.94	31.52	25.12	58.10	48.10	-26.58	-22.98
3	2.05859	0.27	28.15	20.21	28.42	20.48	56.00	46.00	-27.58	-25.52
4	3.89063	0.37	24.42	17.85	24.79	18.22	56.00	46.00	-31.21	-27.78
5	9.33594	0.55	19.44	12.19	19.99	12.74	60.00	50.00	-40.01	-37.26
6	16.59375	0.73	27.09	21.14	27.82	21.87	60.00	50.00	-32.18	-28.13

REMARKS:

1. Q.P. and AV. are abbreviations of quasi-peak and average individually.
2. The emission levels of other frequencies were very low against the limit.
3. Margin value = Emission level - Limit value
4. Correction factor = Insertion loss + Cable loss
5. Emission Level = Correction Factor + Reading Value.

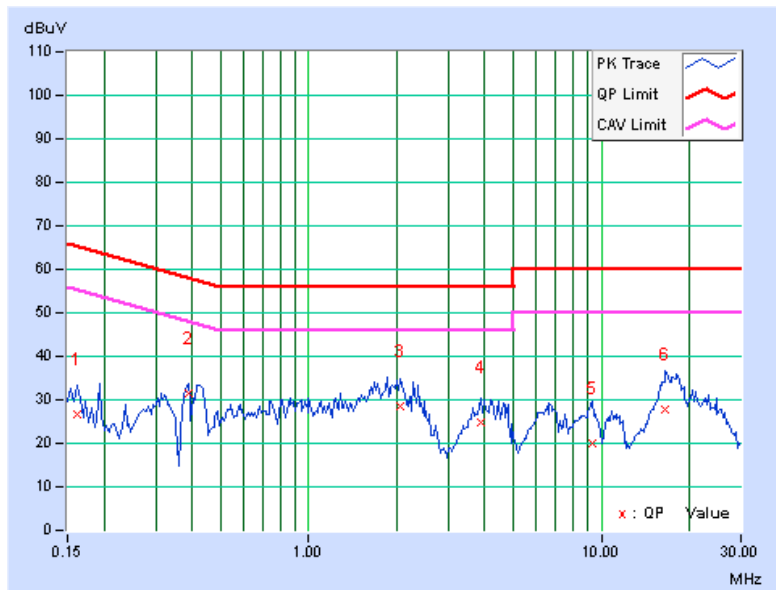

5.3 6dB BANDWIDTH MEASUREMENT

5.3.1 LIMITS OF 6dB BANDWIDTH MEASUREMENT

The minimum of 6dB Bandwidth Measurement is 0.5MHz.

5.3.2 TEST SETUP

Same as item 4.3.2.

5.3.3 TEST INSTRUMENTS

Refer to section 4.1.2 to get information of above instrument.

5.3.4 TEST PROCEDURE

Same as item 4.3.4.

5.3.5 DEVIATION FROM TEST STANDARD

No deviation.

5.3.6 EUT OPERATING CONDITIONS

Same as item 4.3.6.



5.3.7 TEST RESULTS

802.11a: 1TX

CHANNEL	FREQUENCY (MHz)	6dB BANDWIDTH (MHz)	MINIMUM LIMIT (MHz)	PASS / FAIL
149	5745	16.03	0.5	PASS
157	5785	16.00	0.5	PASS
165	5825	16.05	0.5	PASS

802.11n (20MHz): 1TX

CHANNEL	FREQUENCY (MHz)	6dB BANDWIDTH (MHz)	MINIMUM LIMIT (MHz)	PASS / FAIL
149	5745	17.02	0.5	PASS
157	5785	17.06	0.5	PASS
165	5825	16.99	0.5	PASS

802.11n (40MHz): 1TX

CHANNEL	FREQUENCY (MHz)	6dB BANDWIDTH (MHz)	MINIMUM LIMIT (MHz)	PASS / FAIL
151	5755	35.86	0.5	PASS
159	5795	36.05	0.5	PASS



802.11n (20MHz): 2TX

CHANNEL	FREQUENCY (MHz)	6dB BANDWIDTH (MHz)		MINIMUM LIMIT (MHz)	PASS / FAIL
		CHAIN 0	CHAIN 1		
149	5745	16.38	16.66	0.5	PASS
157	5785	17.18	17.00	0.5	PASS
165	5825	17.12	16.66	0.5	PASS

802.11n (20MHz): 2TX

CHANNEL	FREQUENCY (MHz)	6dB BANDWIDTH (MHz)		MINIMUM LIMIT (MHz)	PASS / FAIL
		CHAIN 0	CHAIN 1		
151	5755	35.99	36.00	0.5	PASS
159	5795	36.07	35.92	0.5	PASS

5.4 CONDUCTED OUTPUT POWER

5.4.1 LIMITS OF CONDUCTED OUTPUT POWER MEASUREMENT

For systems using digital modulation in the 5725 –5850 MHz bands: 1 Watt (30dBm)

5.4.2 TEST SETUP

Same as Item 4.4.2.

5.4.3 INSTRUMENTS

Refer to section 4.1.2 to get information of above instrument.

5.4.4 TEST PROCEDURES

Same as Item 4.4.4.

5.4.5 DEVIATION FROM TEST STANDARD

No deviation.

5.4.6 EUT OPERATING CONDITIONS

Same as Item 4.3.6.



5.4.7 TEST RESULTS

802.11a: 1TX

CHANNEL	FREQUENCY (MHz)	PEAK POWER (mW)	PEAK POWER (dBm)	LIMIT (dBm)	PASS/FAIL
149	5745	217.771	23.38	30	PASS
157	5785	230.675	23.63	30	PASS
165	5825	224.388	23.51	30	PASS

802.11n (20MHz): 1TX

CHANNEL	FREQUENCY (MHz)	PEAK POWER (mW)	PEAK POWER (dBm)	LIMIT (dBm)	PASS/FAIL
149	5745	204.644	23.11	30	PASS
157	5785	213.304	23.29	30	PASS
165	5825	207.014	23.16	30	PASS

802.11n (40MHz): 1TX

CHANNEL	FREQUENCY (MHz)	PEAK POWER (mW)	PEAK POWER (dBm)	LIMIT (dBm)	PASS/FAIL
151	5755	179.887	22.55	30	PASS
159	5795	182.390	22.61	30	PASS

802.11n (20MHz): 2TX

CHAN.	FREQUENCY (MHz)	PEAK POWER (dBm)		TOTAL POWER (mW)	TOTAL POWER (dBm)	LIMIT (dBm)	PASS / FAIL
		CHAIN 0	CHAIN 1				
149	5745	22.19	22.36	337.8	25.3	30	PASS
157	5785	22.04	22.38	332.9	25.2	30	PASS
165	5825	22.02	21.95	315.9	25.0	30	PASS

802.11n (40MHz): 2TX

CHAN.	FREQUENCY (MHz)	PEAK POWER (dBm)		TOTAL POWER (mW)	TOTAL POWER (dBm)	LIMIT (dBm)	PASS / FAIL
		CHAIN 0	CHAIN 1				
151	5755	18.48	18.92	148.5	21.7	30	PASS
159	5795	18.45	18.86	146.9	21.7	30	PASS

5.5 POWER SPECTRAL DENSITY MEASUREMENT

5.5.1 LIMITS OF POWER SPECTRAL DENSITY MEASUREMENT

The Maximum of Power Spectral Density Measurement is 8dBm.

5.5.2 TEST SETUP

Same as item 4.5.2.

5.5.3 TEST INSTRUMENTS

Refer to section 4.1.2 to get information of above instrument.

5.5.4 TEST PROCEDURE.

Same as item 4.5.4.

5.5.5 DEVIATION FROM TEST STANDARD

No deviation.

5.5.6 EUT OPERATING CONDITION

Same as item 4.3.6.

5.5.7 TEST RESULTS

802.11a: 1TX

Channel	FREQ. (MHz)	PSD (dBm/100kHz)	PSD (dBm/3kHz)	Limit (dBm/3kHz)	PASS /FAIL
149	5745	5.63	-9.6	8	PASS
157	5785	6.07	-9.16	8	PASS
165	5825	5.97	-9.26	8	PASS

802.11n (20MHz): 1TX

Channel	FREQ. (MHz)	PSD (dBm/100kHz)	PSD (dBm/3kHz)	Limit (dBm/3kHz)	PASS /FAIL
149	5745	5.50	-9.73	8	PASS
157	5785	5.90	-9.33	8	PASS
165	5825	5.53	-9.7	8	PASS

802.11n (40MHz): 1TX

Channel	FREQ. (MHz)	PSD (dBm/100kHz)	PSD (dBm/3kHz)	Limit (dBm/3kHz)	PASS /FAIL
151	5755	2.18	-13.05	8	PASS
159	5795	2.19	-13.04	8	PASS

802.11n (20MHz): 2TX

TX chain	Channel	FREQ. (MHz)	PSD (dBm/100kHz)	PSD (dBm/3kHz)	10 log (N=2) dB	Total PSD (dBm/3kHz)	Limit (dBm/3kHz)	PASS /FAIL
0	149	5745	2.89	-12.34	3.01	-9.33	8	PASS
	157	5785	2.82	-12.41	3.01	-9.40	8	PASS
	165	5825	2.78	-12.45	3.01	-9.44	8	PASS
1	149	5745	3.01	-12.22	3.01	-9.21	8	PASS
	157	5785	3.22	-12.01	3.01	-9	8	PASS
	165	5825	2.62	-12.61	3.01	-9.60	8	PASS

802.11n (40MHz): 2TX

TX chain	Channel	FREQ. (MHz)	PSD (dBm/100kHz)	PSD (dBm/3kHz)	10 log (N=2) dB	Total PSD (dBm/3kHz)	Limit (dBm/3kHz)	PASS /FAIL
0	151	5755	-1.72	-16.95	3.01	-13.94	8	PASS
	159	5795	-1.67	-16.9	3.01	-13.89	8	PASS
1	151	5755	0.43	-14.8	3.01	-11.79	8	PASS
	159	5795	0.24	-14.99	3.01	-11.98	8	PASS

5.6 CONDUCTED OUT OF BAND EMISSION MEASUREMENT

5.6.1 LIMITS OF CONDUCTED OUT OF BAND EMISSION MEASUREMENT

Below -20dB of the highest emission level of operating band (in 100kHz Resolution Bandwidth).

5.6.2 TEST SETUP

Same as Item 4.6.2

5.6.3 TEST INSTRUMENTS

Refer to section 4.1.2 to get information of above instrument.

5.6.4 TEST PROCEDURE

Same as Item 4.6.4

5.6.5 DEVIATION FROM TEST STANDARD

No deviation.

5.6.6 EUT OPERATING CONDITION

Same as Item 4.3.6

5.6.7 TEST RESULTS

The conducted emission test is performed on each TX port of operating mode without summing or adding $10\log(N)$ since the limit is relative emission limit. Only worst data of each operating mode is presented.

The spectrum plots are attached on the following pages. D1 line indicates the highest level, and D2 line indicates the 20dB offset below D1. It shows compliance with the requirement.



A D T

802.11a: 1TX

CH 149

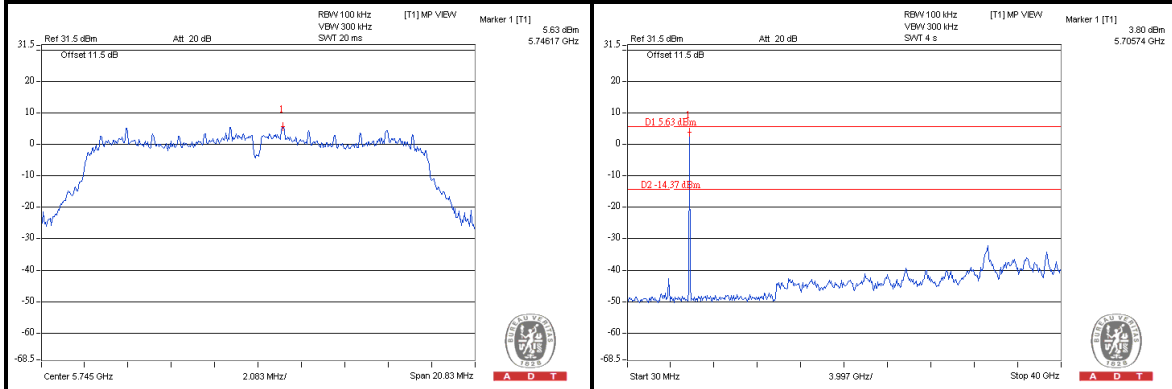

CH 157

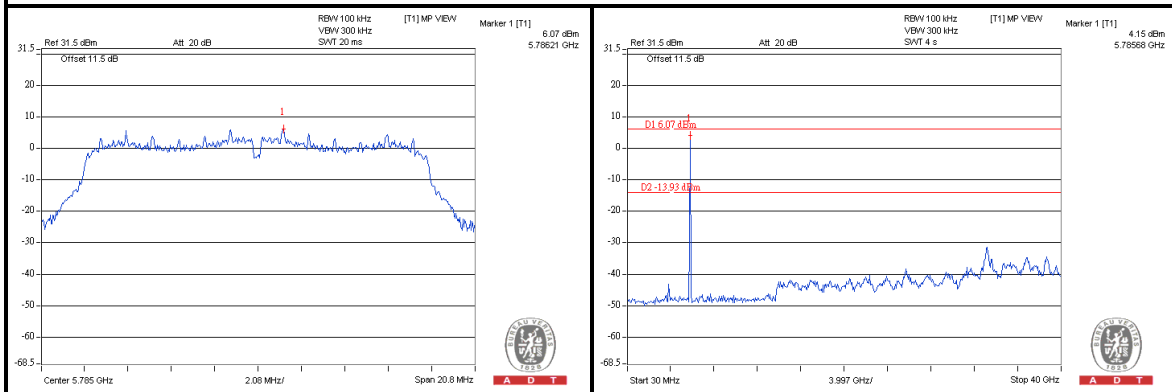

CH 165

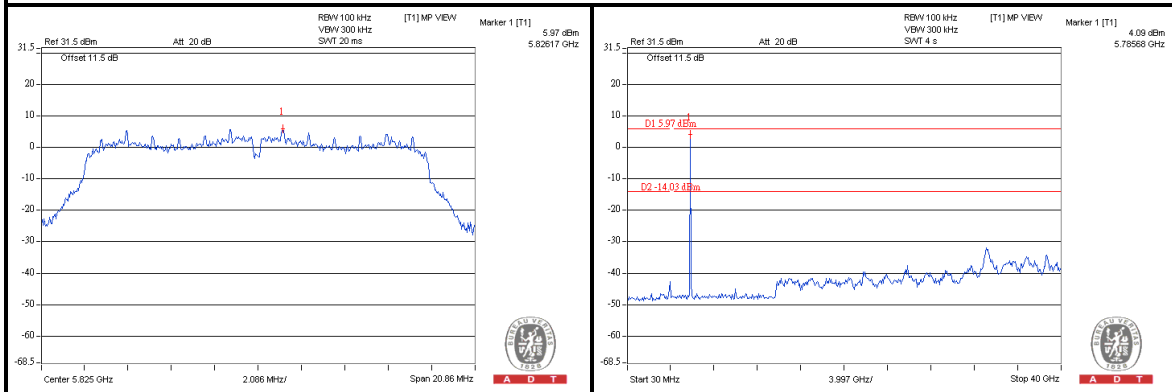



A D T

802.11n (20MHz): 1TX

CH 149

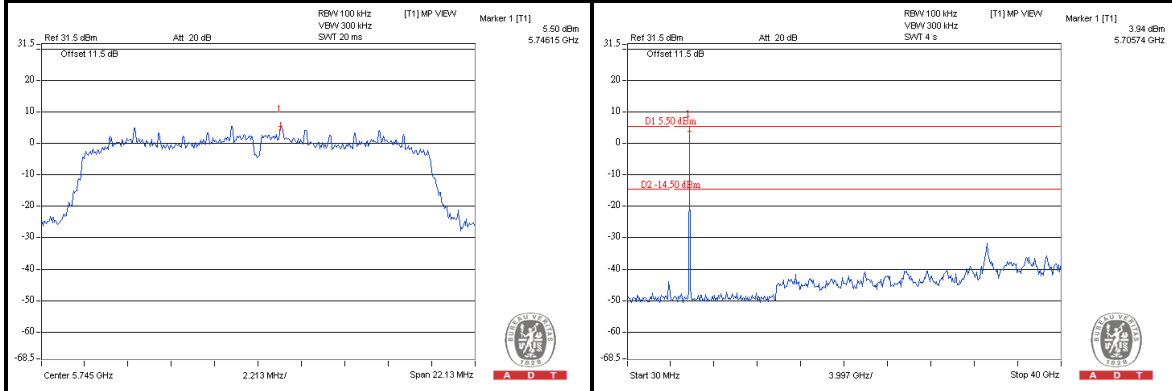

CH 157

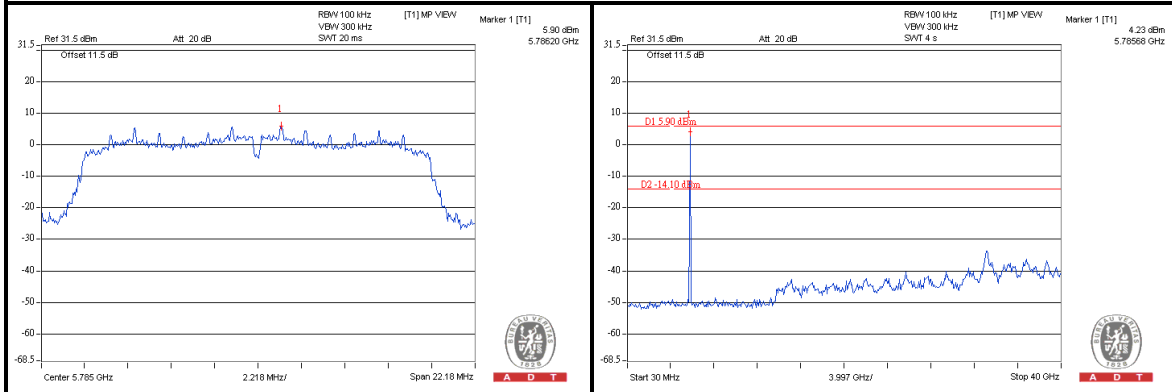

CH 165

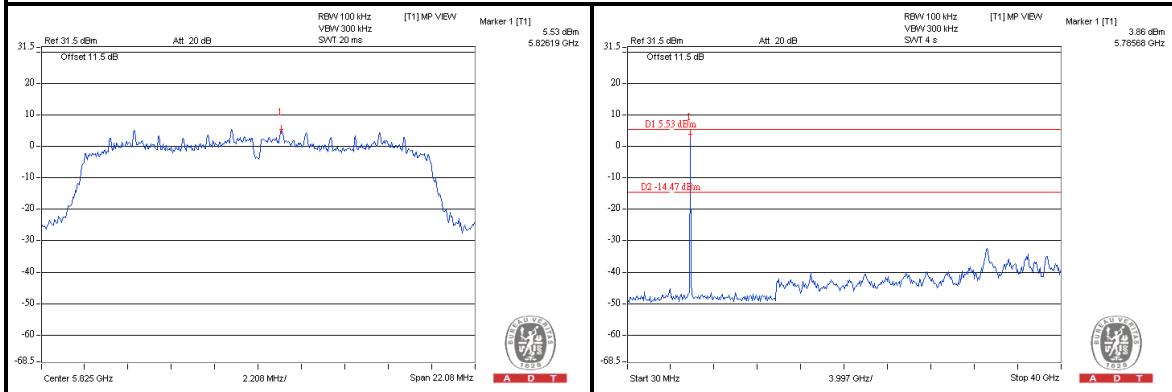



A D T

802.11n (40MHz): 1TX

CH 151

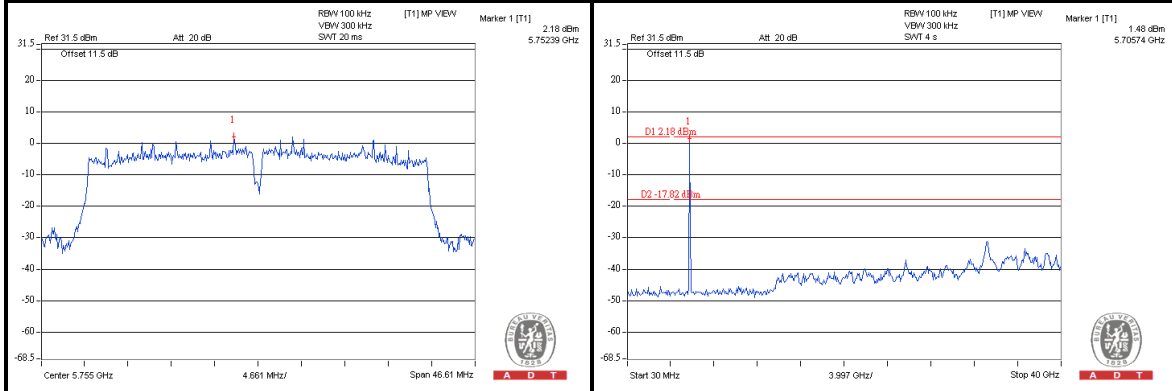

CH 159

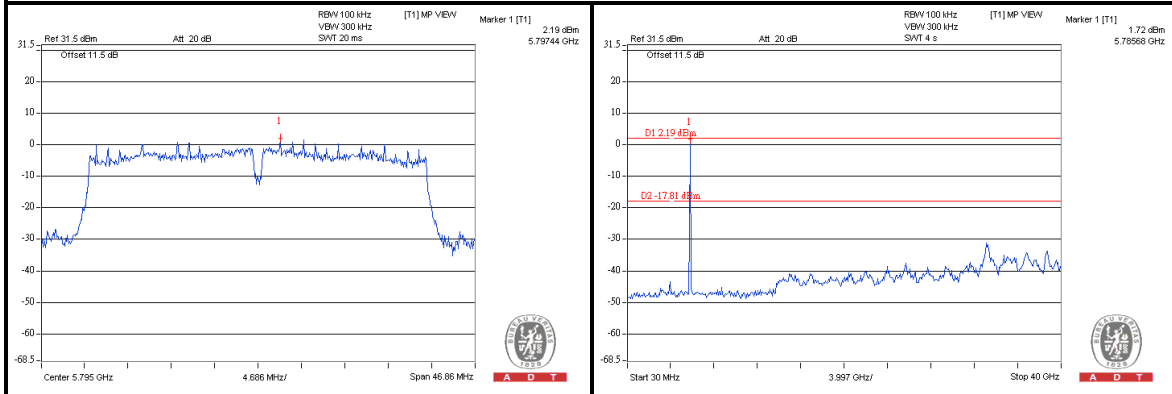



A D T

802.11n (20MHz): 2TX

CH 149

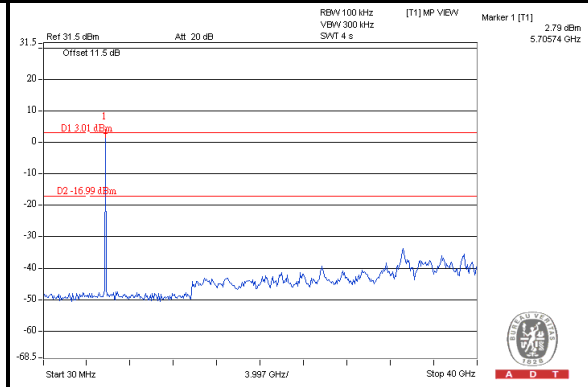
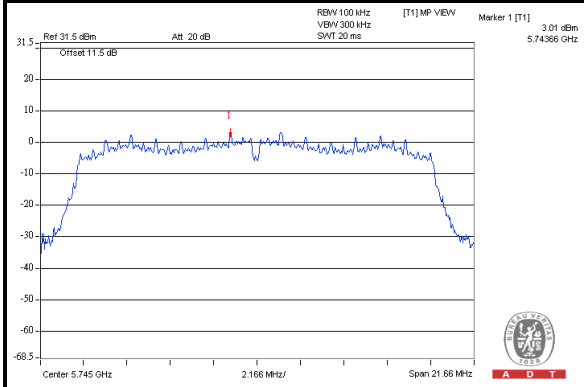

CH 157

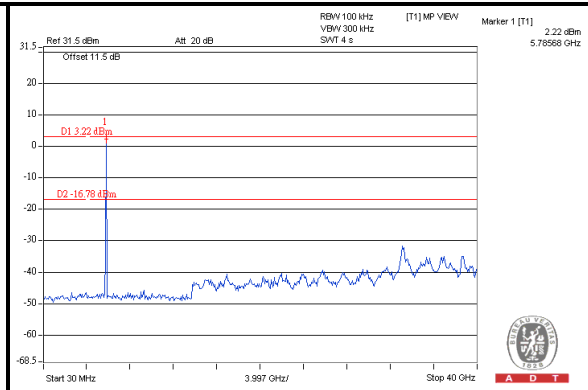
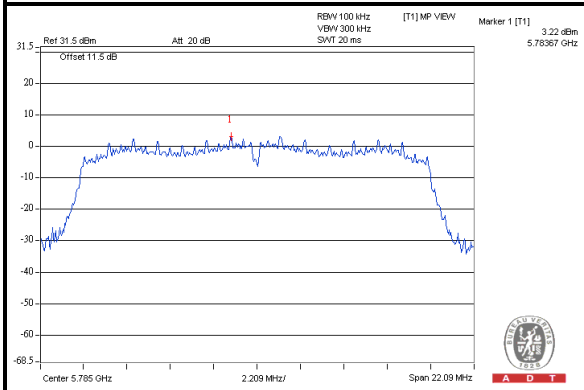

CH 165

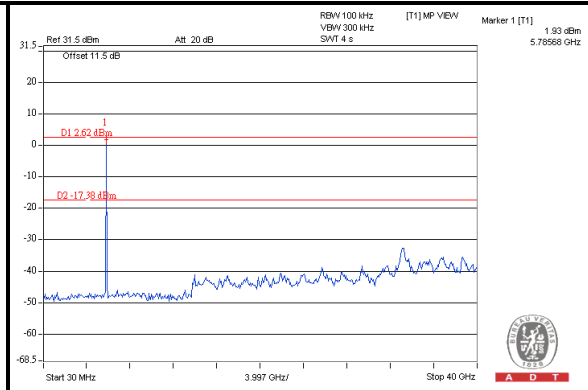
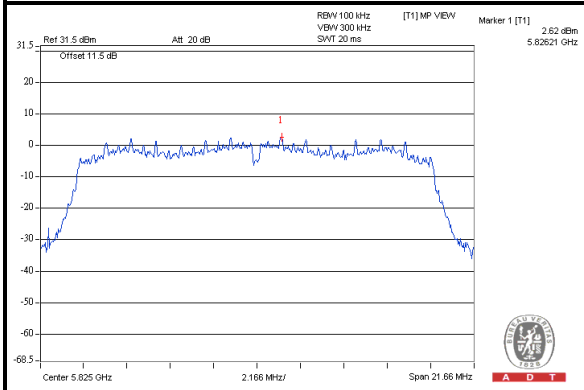



A D T

802.11n (40MHz): 2TX

CH 151

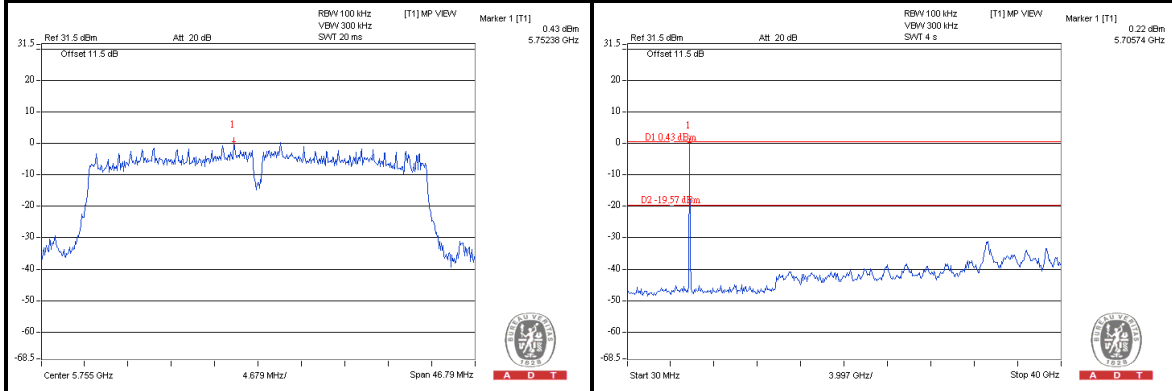

CH 159

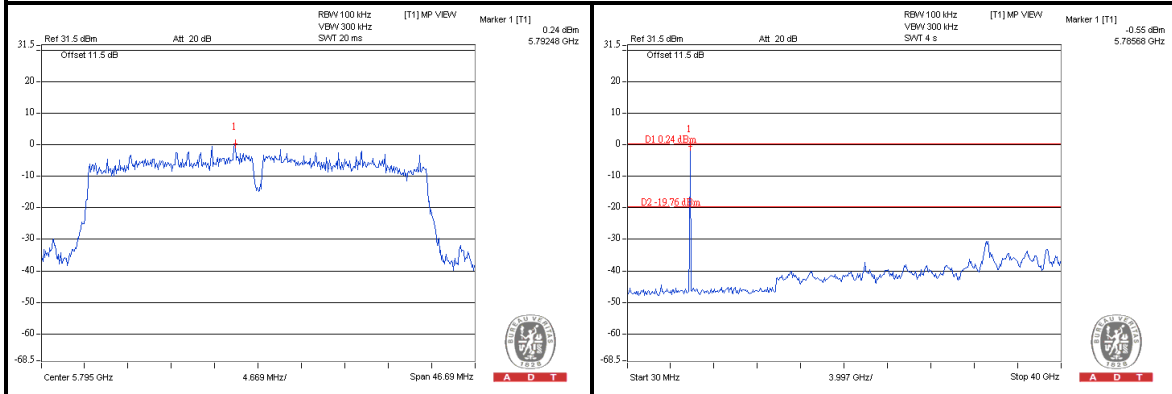



A D T

6. PHOTOGRAPHS OF THE TEST CONFIGURATION

Please refer to the attached file (Test Setup Photo).



7. INFORMATION ON THE TESTING LABORATORIES

We, Bureau Veritas Consumer Products Services (H.K.) Ltd., Taoyuan Branch, were founded in 1988 to provide our best service in EMC, Radio, Telecom and Safety consultation. Our laboratories are accredited and approved according to ISO/IEC 17025:

If you have any comments, please feel free to contact us at the following:

Linko EMC/RF Lab

Tel: 886-2-26052180

Fax: 886-2-26051924

Hsin Chu EMC/RF Lab

Tel: 886-3-5935343

Fax: 886-3-5935342

Hwa Ya EMC/RF/Safety/Telecom Lab

Tel: 886-3-3183232

Fax: 886-3-3270892

Email: service.adt@tw.bureauveritas.com

Web Site: www.adt.com.tw

The address and road map of all our labs can be found in our web site also.



A D T

8. APPENDIX A - MODIFICATIONS RECORDERS FOR ENGINEERING CHANGES TO THE EUT BY THE LAB

No modifications were made to the EUT by the lab during the test.

---END---