



# FCC TEST REPORT (BLUETOOTH)

**REPORT NO.:** RF120503C13B-2  
**MODEL NO.:** TP00042A  
**FCC ID:** GKR-TP00042ABR  
**RECEIVED:** May 03, 2012  
**TESTED:** May 16 ~ Aug. 13, 2012  
**ISSUED:** Aug. 22, 2012

**APPLICANT:** COMPAL ELECTRONICS, INC.

**ADDRESS:** No.581, Ruiguang Rd., Neihu District, Taipei City  
11492, Taiwan (R.O.C.)

**ISSUED BY:** Bureau Veritas Consumer Products Services (H.K.)  
Ltd., Taoyuan Branch

**LAB ADDRESS:** No. 47, 14th Ling, Chia Pau Vil., Lin Kou Dist., New  
Taipei City, Taiwan ( R.O.C )

**TEST LOCATION:** No. 19, Hwa Ya 2nd Rd, Wen Hwa Tsuen, Kwei  
Shan Hsiang, Taoyuan Hsien 333, Taiwan, R.O.C.

This report should not be used by the client to claim  
product certification, approval, or endorsement by  
TAF or any government agencies.



This report is for your exclusive use. Any copying or replication of this report to or for any other person or entity, or use of our name or trademark, is permitted only with our prior written permission. This report sets forth our findings solely with respect to the test samples identified herein. The results set forth in this report are not indicative or representative of the quality or characteristics of the lot from which a test sample was taken or any similar or identical product unless specifically and expressly noted. Our report includes all of the tests requested by you and the results thereof based upon the information that you provided to us. You have 60 days from date of issuance of this report to notify us of any material error or omission caused by our negligence, provided, however, that such notice shall be in writing and shall specifically address the issue you wish to raise. A failure to raise such issue within the prescribed time shall constitute your unqualified acceptance of the completeness of this report, the tests conducted and the correctness of the report contents. Unless specific mention, the uncertainty of measurement has been explicitly taken into account to declare the compliance or non-compliance to the specification

## Table of Contents

RELEASE CONTROL RECORD .....	5
1. CERTIFICATION .....	6
2. SUMMARY OF TEST RESULTS .....	7
2.1 MEASUREMENT UNCERTAINTY .....	8
3. GENERAL INFORMATION .....	9
3.1 GENERAL DESCRIPTION OF EUT .....	9
3.2 DESCRIPTION OF TEST MODES .....	11
3.2.1 TEST MODE APPLICABILITY AND TESTED CHANNEL DETAIL .....	12
3.3 GENERAL DESCRIPTION OF APPLIED STANDARDS .....	15
3.4 DESCRIPTION OF SUPPORT UNITS .....	16
3.4.1 CONFIGURATION OF SYSTEM UNDER TEST .....	16
4. TEST TYPES AND RESULTS (FOR BLUETOOTH EDR) .....	17
4.1 RADIATED EMISSION AND BANDEDGE MEASUREMENT .....	17
4.1.1 LIMITS OF RADIATED EMISSION AND BANDEDGE MEASUREMENT .....	17
4.1.2 TEST INSTRUMENTS .....	18
4.1.3 TEST PROCEDURES .....	19
4.1.4 DEVIATION FROM TEST STANDARD .....	19
4.1.5 TEST SETUP .....	20
4.1.6 EUT OPERATING CONDITIONS .....	20
4.1.7 TEST RESULTS .....	21
4.2 CONDUCTED EMISSION MEASUREMENT .....	30
4.2.1 LIMITS OF CONDUCTED EMISSION MEASUREMENT .....	30
4.2.2 TEST INSTRUMENTS .....	30
4.2.3 TEST PROCEDURES .....	31
4.2.4 DEVIATION FROM TEST STANDARD .....	31
4.2.5 TEST SETUP .....	32
4.2.6 EUT OPERATING CONDITIONS .....	32
4.2.7 TEST RESULTS .....	33
4.3 NUMBER OF HOPPING FREQUENCY USED .....	35
4.3.1 LIMIT OF HOPPING FREQUENCY USED .....	35
4.3.2 TEST SETUP .....	35
4.3.3 TEST INSTRUMENTS .....	35
4.3.4 TEST PROCEDURES .....	35
4.3.5 DEVIATION FROM TEST STANDARD .....	35
4.3.6 TEST RESULTS .....	35
4.4 DWELL TIME ON EACH CHANNEL .....	37
4.4.1 LIMIT OF DWELL TIME USED .....	37
4.4.2 TEST SETUP .....	37
4.4.3 TEST INSTRUMENTS .....	37
4.4.4 TEST PROCEDURES .....	37
4.4.5 DEVIATION FROM TEST STANDARD .....	37
4.4.6 TEST RESULTS .....	38
4.5 CHANNEL BANDWIDTH .....	44
4.5.1 LIMITS OF CHANNEL BANDWIDTH .....	44
4.5.2 TEST SETUP .....	44
4.5.3 TEST INSTRUMENTS .....	44
4.5.4 TEST PROCEDURE .....	44
4.5.5 DEVIATION FROM TEST STANDARD .....	44



4.5.6	EUT OPERATING CONDITION .....	44
4.5.7	TEST RESULTS .....	45
4.6	HOPPING CHANNEL SEPARATION .....	46
4.6.1	LIMIT OF HOPPING CHANNEL SEPARATION .....	46
4.6.2	TEST SETUP .....	46
4.6.3	TEST INSTRUMENTS .....	46
4.6.4	TEST PROCEDURES .....	46
4.6.5	DEVIATION FROM TEST STANDARD .....	46
4.6.6	TEST RESULTS .....	47
4.7	MAXIMUM OUTPUT POWER .....	49
4.7.1	LIMITS OF MAXIMUM OUTPUT POWER MEASUREMENT .....	49
4.7.2	TEST SETUP .....	49
4.7.3	TEST INSTRUMENTS .....	49
4.7.4	TEST PROCEDURES .....	49
4.7.5	DEVIATION FROM TEST STANDARD .....	49
4.7.6	EUT OPERATING CONDITION .....	49
4.7.7	TEST RESULTS .....	50
4.8	CONDUCTED OUT OF BAND EMISSION MEASUREMENT .....	52
4.8.1	LIMITS OF CONDUCTED OUT OF BAND EMISSION MEASUREMENT .....	52
4.8.2	TEST INSTRUMENTS .....	52
4.8.3	TEST PROCEDURE .....	52
4.8.4	DEVIATION FROM TEST STANDARD .....	52
4.8.5	EUT OPERATING CONDITION .....	52
4.8.6	TEST RESULTS .....	52
5.	TEST TYPES AND RESULTS (FOR BLUETOOTH LE 4.0) .....	56
5.1	RADIATED EMISSION AND BANDEDGE MEASUREMENT .....	56
5.1.1	LIMITS OF RADIATED EMISSION AND BANDEDGE MEASUREMENT .....	56
5.1.2	TEST INSTRUMENTS .....	56
5.1.3	TEST PROCEDURES .....	56
5.1.4	DEVIATION FROM TEST STANDARD .....	56
5.1.5	TEST SETUP .....	56
5.1.6	EUT OPERATING CONDITIONS .....	56
5.1.7	TEST RESULTS .....	57
5.2	CONDUCTED EMISSION MEASUREMENT .....	62
5.2.1	LIMITS OF CONDUCTED EMISSION MEASUREMENT .....	62
5.2.2	TEST INSTRUMENTS .....	62
5.2.3	TEST PROCEDURES .....	62
5.2.4	DEVIATION FROM TEST STANDARD .....	62
5.2.5	TEST SETUP .....	62
5.2.6	EUT OPERATING CONDITIONS .....	62
5.2.7	TEST RESULTS .....	63
5.3	6dB BANDWIDTH MEASUREMENT .....	65
5.3.1	LIMITS OF 6dB BANDWIDTH MEASUREMENT .....	65
5.3.2	TEST SETUP .....	65
5.3.3	TEST INSTRUMENTS .....	65
5.3.4	TEST PROCEDURE .....	65
5.3.5	DEVIATION FROM TEST STANDARD .....	65
5.3.6	EUT OPERATING CONDITIONS .....	65
5.3.7	TEST RESULTS .....	66
5.4	CONDUCTED OUTPUT POWER .....	67
5.4.1	LIMITS OF CONDUCTED OUTPUT POWER MEASUREMENT .....	67
5.4.2	TEST SETUP .....	67
5.4.3	TEST INSTRUMENTS .....	67



5.4.4	TEST PROCEDURES .....	67
5.4.5	DEVIATION FROM TEST STANDARD .....	67
5.4.6	EUT OPERATING CONDITIONS.....	67
5.4.7	TEST RESULTS .....	67
5.5	POWER SPECTRAL DENSITY MEASUREMENT .....	68
5.5.1	LIMITS OF POWER SPECTRAL DENSITY MEASUREMENT.....	68
5.5.2	TEST SETUP.....	68
5.5.3	TEST INSTRUMENTS.....	68
5.5.4	TEST PROCEDURE.....	68
5.5.5	DEVIATION FROM TEST STANDARD .....	68
5.5.6	EUT OPERATING CONDITION .....	68
5.5.7	TEST RESULTS .....	68
5.6	CONDUCTED OUT OF BAND EMISSION MEASUREMENT .....	69
5.6.1	LIMITS OF OUT OF BAND EMISSION MEASUREMENT .....	69
5.6.2	TEST SETUP.....	69
5.6.3	TEST INSTRUMENTS.....	69
5.6.4	TEST PROCEDURE.....	69
5.6.5	DEVIATION FROM TEST STANDARD .....	70
5.6.6	EUT OPERATING CONDITION .....	70
5.6.7	TEST RESULTS .....	70
5.6.8	TEST RESULTS .....	71
6.	PHOTOGRAPHS OF THE TEST CONFIGURATION .....	72
7.	INFORMATION ON THE TESTING LABORATORIES .....	73
8.	APPENDIX A - MODIFICATIONS RECORDERS FOR ENGINEERING CHANGES TO THE EUT BY THE LAB .....	74



A D T

## RELEASE CONTROL RECORD

ISSUE NO.	REASON FOR CHANGE	DATE ISSUED
RF120503C13B-2	Original release	Aug. 22, 2012



## 1. CERTIFICATION

**PRODUCT:** Convertible Tablet Computer

**MODEL:** TP00042A

**BRAND:** Lenovo

**APPLICANT:** COMPAL ELECTRONICS, INC.

**TESTED:** May 16 ~ Aug. 13, 2012

**TEST SAMPLE:** Production Unit

**STANDARDS:** **FCC Part 15, Subpart C (Section 15.247)**

ANSI C63.10-2009

The above equipment (Model: TP00042A) has been tested by **Bureau Veritas Consumer Products Services (H.K.) Ltd., Taoyuan Branch**, and found compliance with the requirement of the above standards. The test record, data evaluation & Equipment Under Test (EUT) configurations represented herein are true and accurate accounts of the measurements of the sample's EMC characteristics under the conditions specified in this report.

**PREPARED BY** : Ivonne Wu , **DATE** : Aug. 22, 2012  
Ivonne Wu / Senior Specialist

**APPROVED BY** : Gary Chang , **DATE** : Aug. 22, 2012  
Gary Chang / Technical Manager

## 2. SUMMARY OF TEST RESULTS

The EUT has been tested according to the following specifications:

APPLIED STANDARD: FCC Part 15, Subpart C (Bluetooth EDR)			
STANDARD SECTION	TEST TYPE AND LIMIT	RESULT	REMARK
15.207	AC Power Conducted Emission	PASS	Meet the requirement of limit. Minimum passing margin is -21.71dB at 0.38828MHz.
15.247(a)(1) (iii)	Number of Hopping Frequency Used	PASS	Meet the requirement of limit.
15.247(a)(1) (iii)	Dwell Time on Each Channel	PASS	Meet the requirement of limit.
15.247(a)(1)	1. Hopping Channel Separation 2. Spectrum Bandwidth of a Frequency Hopping Sequence Spread Spectrum System	PASS	Meet the requirement of limit.
15.247(b)	Maximum Peak Output Power	PASS	Meet the requirement of limit.
15.247(d)	Transmitter Radiated Emissions	PASS	Meet the requirement of limit. Minimum passing margin is -14.5dB at 189.08MHz.
15.247(d)	Band Edge Measurement	PASS	Meet the requirement of limit.
15.203	Antenna Requirement	PASS	No antenna connector is used.

**NOTE:** If The Frequency Hopping System operating in 2400-2483.5MHz band and the output power less than 125mW. The hopping channel carrier frequencies separated by a minimum of 25kHz or two-thirds of the 20dB bandwidth of hopping channel whichever is greater.

APPLIED STANDARD: FCC PART 15, SUBPART C (SECTION 15.247) (Bluetooth LE 4.0)			
STANDARD SECTION	TEST TYPE AND LIMIT	RESULT	REMARK
15.207	AC Power Conducted Emission	PASS	Meet the requirement of limit. Minimum passing margin is -22.26dB at 0.37368MHz.
15.247(d) 15.209	Radiated Emissions	PASS	Meet the requirement of limit. Minimum passing margin is -15.4dB at 2400.00MHz and 7320.00MHz.
15.247(d)	Band Edge Measurement	PASS	Meet the requirement of limit.
15.247(a)(2)	6dB bandwidth	PASS	Meet the requirement of limit.
15.247(b)	Conducted power	PASS	Meet the requirement of limit.
15.247(e)	Power Spectral Density	PASS	Meet the requirement of limit.
15.203	Antenna Requirement	PASS	No antenna connector is used.

## 2.1 MEASUREMENT UNCERTAINTY

Where relevant, the following measurement uncertainty levels have been estimated for tests performed on the EUT as specified in CISPR 16-4-2:

MEASUREMENT	FREQUENCY	UNCERTAINTY
Conducted emissions	9kHz~30MHz	2.44 dB
Radiated emissions	30MHz ~ 200MHz	2.93 dB
	200MHz ~1000MHz	2.95 dB
	1GHz ~ 18GHz	2.26 dB
	18GHz ~ 40GHz	1.94 dB

This uncertainty represents an expanded uncertainty expressed at approximately the 95% confidence level using a coverage factor of k=2.



### 3. GENERAL INFORMATION

#### 3.1 GENERAL DESCRIPTION OF EUT

<b>EUT</b>	Convertible Tablet Computer	
<b>MODEL NO.</b>	TP00042A	
<b>MODULE MODEL NO.</b>	BCM943228HMB	
<b>POWER SUPPLY</b>	20Vdc from adapter	
<b>MODULATION TYPE</b>	<b>Bluetooth EDR</b>	GFSK, $\pi/4$ -DQPSK, 8DPSK
	<b>Bluetooth LE 4.0</b>	GFSK
<b>TRANSFER RATE</b>	<b>Bluetooth EDR</b>	1/2/3Mbps
	<b>Bluetooth LE 4.0</b>	1Mbps
<b>OPERATING FREQUENCY</b>	2402 ~ 2480MHz	
<b>NUMBER OF CHANNEL</b>	<b>Bluetooth EDR</b>	79
	<b>Bluetooth LE 4.0</b>	40
<b>CHANNEL SPACING</b>	<b>Bluetooth EDR</b>	1MHz
	<b>Bluetooth LE 4.0</b>	2MHz
<b>OUTPUT POWER</b>	<b>Bluetooth EDR</b>	4.285mW
	<b>Bluetooth LE 4.0</b>	2.15mW
<b>ANTENNA TYPE</b>	Refer to NOTE as below	
<b>ANTENNA CONNECTOR</b>	NA	
<b>DATA CABLE</b>	NA	
<b>I/O PORTS</b>	Refer to user's manual	
<b>ACCESSORY DEVICES</b>	Adapter	

**NOTE:**

1. The EUT consumes power from the following adapter.

<b>ADAPTER</b>	
<b>BRAND:</b>	Lenovo
<b>MODEL:</b>	45N0185
<b>INPUT:</b>	100-240Vac, 50-60Hz, 1.5A
<b>OUTPUT:</b>	20Vdc, 3.25A
<b>POWER LINE:</b>	1.8m non-shielded cable with one core

2. The antenna information is listed as below.

	JPC Antenna (1st)		WNC Antenna (2nd)	
<b>Antenna Type</b>	PIFA		PIFA	
<b>Manufacturer</b>	Jess-Link Product Co., LTD		Wistron Neweb Corp.	
<b>Model Name</b>	<b>Antenna Type</b>	<b>Model name</b>	<b>Antenna Type</b>	<b>Model name</b>
	WLAN MAIN L	PANT11A00034-1	WLAN MAIN L	81.EG915.G34
	WLAN AUX R	PANT11A00035-1	WLAN AUX R	81.EG915.G35
<b>Antenna Gain</b>	<b>WLAN Main</b>		<b>WLAN Main</b>	
	2.4~2.4835 GHz	-2.03	2.4~2.4835 GHz	-0.54
	5.15~5.25 GHz	-0.59	5.15~5.25 GHz	0.12
	5.25~5.35 GHz	-1.56	5.25~5.35 GHz	-0.41
	5.47~5.725 GHz	0.21	5.47~5.725 GHz	0.86
	5.725~5.85 GHz	0.45	5.725~5.85 GHz	0.86
	<b>WLAN Aux.</b>		<b>WLAN Aux.</b>	
	2.4~2.4835 GHz	-3.47	2.4~2.4835 GHz	-1.09
	5.15~5.25 GHz	-0.13	5.15~5.25 GHz	0.91
	5.25~5.35 GHz	-0.07	5.25~5.35 GHz	0.91
	5.47~5.725 GHz	-0.08	5.47~5.725 GHz	1.23
	5.725~5.85 GHz	0.42	5.725~5.85 GHz	1.23

3. The above EUT information is declared by the manufacturer and for more detailed features description, please refer to the manufacturer's specifications or User's Manual.



### 3.2 DESCRIPTION OF TEST MODES

#### For Bluetooth EDR:

79 channels are provided to this EUT:

CHANNEL	FREQ. (MHz)	CHANNEL	FREQ. (MHz)	CHANNEL	FREQ. (MHz)	CHANNEL	FREQ. (MHz)
0	2402	20	2422	40	2442	60	2462
1	2403	21	2423	41	2443	61	2463
2	2404	22	2424	42	2444	62	2464
3	2405	23	2425	43	2445	63	2465
4	2406	24	2426	44	2446	64	2466
5	2407	25	2427	45	2447	65	2467
6	2408	26	2428	46	2448	66	2468
7	2409	27	2429	47	2449	67	2469
8	2410	28	2430	48	2450	68	2470
9	2411	29	2431	49	2451	69	2471
10	2412	30	2432	50	2452	70	2472
11	2413	31	2433	51	2453	71	2473
12	2414	32	2434	52	2454	72	2474
13	2415	33	2435	53	2455	73	2475
14	2416	34	2436	54	2456	74	2476
15	2417	35	2437	55	2457	75	2477
16	2418	36	2438	56	2458	76	2478
17	2419	37	2439	57	2459	77	2479
18	2420	38	2440	58	2460	78	2480
19	2421	39	2441	59	2461		

#### For Bluetooth LE 4.0:

40 channels are provided to this EUT:

CHANNEL	FREQ. (MHz)	CHANNEL	FREQ. (MHz)	CHANNEL	FREQ. (MHz)	CHANNEL	FREQ. (MHz)
0	2402	10	2422	20	2442	30	2462
1	2404	11	2424	21	2444	31	2464
2	2406	12	2426	22	2446	32	2466
3	2408	13	2428	23	2448	33	2468
4	2410	14	2430	24	2450	34	2470
5	2412	15	2432	25	2452	35	2472
6	2414	16	2434	26	2454	36	2474
7	2416	17	2436	27	2456	37	2476
8	2418	18	2438	28	2458	38	2478
9	2420	19	2440	29	2460	39	2480

### 3.2.1 TEST MODE APPLICABILITY AND TESTED CHANNEL DETAIL

#### For Bluetooth EDR:

EUT CONFIGURE MODE	APPLICABLE TO				DESCRIPTION
	RE≥1G	RE<1G	PLC	APCM	
-	√	√	√	√	-

Where **RE≥1G**: Radiated Emission above 1GHz      **RE<1G**: Radiated Emission below 1GHz  
**PLC**: Power Line Conducted Emission      **APCM**: Antenna Port Conducted Measurement

**NOTE:** 1. For Radiated emission test, pre-tested GFSK, π/4-DQPSK, 8DPSK modulation type and found 8DPSK was the worse, therefore chosen for the final test and presented in the test report.

#### RADIATED EMISSION TEST (ABOVE 1 GHz):

- Pre-Scan has been conducted to determine the worst-case mode from all possible combinations between available modulations, antenna ports (if EUT with antenna diversity architecture) and packet type.
- Following channel(s) was (were) selected for the final test as listed below.

EUT CONFIGURE MODE	AVAILABLE CHANNEL	TESTED CHANNEL	MODULATION TYPE	PACKET TYPE
-	0 to 78	0, 39, 78	8DPSK	DH5

#### RADIATED EMISSION TEST (BELOW 1 GHz):

- Pre-Scan has been conducted to determine the worst-case mode from all possible combinations between available modulations, antenna ports (if EUT with antenna diversity architecture) and packet type.
- Following channel(s) was (were) selected for the final test as listed below.

EUT CONFIGURE MODE	AVAILABLE CHANNEL	TESTED CHANNEL	MODULATION TYPE	PACKET TYPE
-	0 to 78	39	8DPSK	DH5

#### POWER LINE CONDUCTED EMISSION TEST:

- Pre-Scan has been conducted to determine the worst-case mode from all possible combinations between available modulations, antenna ports (if EUT with antenna diversity architecture), and packet types.
- Following channel(s) was (were) selected for the final test as listed below.

EUT CONFIGURE MODE	AVAILABLE CHANNEL	TESTED CHANNEL	MODULATION TYPE	PACKET TYPE
-	0 to 78	39	8DPSK	DH5

**ANTENNA PORT CONDUCTED MEASUREMENT:**

- This item includes all test value of each mode, but only includes spectrum plot of worst value of each mode.
- Pre-Scan has been conducted to determine the worst-case mode from all possible combinations between available modulations, antenna ports (if EUT with antenna diversity architecture), and packet types.
- Following channel(s) was (were) selected for the final test as listed below.

EUT CONFIGURE MODE	AVAILABLE CHANNEL	TESTED CHANNEL	MODULATION TYPE	PACKET TYPE
-	0 to 78	0, 39, 78	GFSK	DH5
-	0 to 78	0, 39, 78	$\pi/4$ -DQPSK	DH5
-	0 to 78	0, 39, 78	8DPSK	DH5

**TEST CONDITION:**

APPLICABLE TO	ENVIRONMENTAL CONDITIONS	INPUT POWER	TESTED BY
RE $\geq$ 1G	25deg. C, 65%RH	120Vac, 60Hz	Anderson Hong
RE $<$ 1G	25deg. C, 65%RH	120Vac, 60Hz	Anderson Hong
PLC	25deg. C, 65%RH	120Vac, 60Hz	Brad Wu
APCM	25deg. C, 65%RH	120Vac, 60Hz	Anderson Hong

**FOR Bluetooth LE 4.0:**

EUT CONFIGURE MODE	APPLICABLE TO				DESCRIPTION
	RE $\geq$ 1G	RE $<$ 1G	PLC	APCM	
-	√	√	√	√	-

Where **RE $\geq$ 1G**: Radiated Emission above 1GHz      **RE $<$ 1G**: Radiated Emission below 1GHz  
**PLC**: Power Line Conducted Emission      **APCM**: Antenna Port Conducted Measurement

**NOTE:** 1. The EUT had been pre-tested on the positioned of each 3 axis. The worst case was found when positioned on **X-plane**.

**RADIATED EMISSION TEST (ABOVE 1GHz):**

- Pre-Scan has been conducted to determine the worst-case mode from all possible combinations between available modulations and antenna ports (if EUT with antenna diversity architecture).
- Following channel(s) was (were) selected for the final test as listed below.

EUT CONFIGURE MODE	AVAILABLE CHANNEL	TESTED CHANNEL	MODULATION TYPE	DATA RATE (Mbps)
-	0 to 39	0, 19, 39	GFSK	1.0

**RADIATED EMISSION TEST (BELOW 1GHz):**

- Pre-Scan has been conducted to determine the worst-case mode from all possible combinations between available modulations and antenna ports (if EUT with antenna diversity architecture).
- Following channel(s) was (were) selected for the final test as listed below.

EUT CONFIGURE MODE	AVAILABLE CHANNEL	TESTED CHANNEL	MODULATION TYPE	DATA RATE (Mbps)
-	0 to 39	19	GFSK	1.0

**POWER LINE CONDUCTED EMISSION TEST:**

- Pre-Scan has been conducted to determine the worst-case mode from all possible combinations between available modulations and antenna ports (if EUT with antenna diversity architecture).
- Following channel(s) was (were) selected for the final test as listed below.

EUT CONFIGURE MODE	AVAILABLE CHANNEL	TESTED CHANNEL	MODULATION TYPE	DATA RATE (Mbps)
-	0 to 39	19	GFSK	1.0

**ANTENNA PORT CONDUCTED MEASUREMENT:**

- Pre-Scan has been conducted to determine the worst-case mode from all possible combinations between available modulations, data rates and antenna ports (if EUT with antenna diversity architecture).
- Following channel(s) was (were) selected for the final test as listed below.

EUT CONFIGURE MODE	AVAILABLE CHANNEL	TESTED CHANNEL	MODULATION TYPE	DATA RATE (Mbps)
-	0 to 39	0, 19, 39	GFSK	1.0

**TEST CONDITION:**

APPLICABLE TO	ENVIRONMENTAL CONDITIONS	INPUT POWER	TESTED BY
RE≥1G	25deg. C, 65%RH	120Vac, 60Hz	Anderson Hong
RE<1G	25deg. C, 65%RH	120Vac, 60Hz	Anderson Hong
PLC	25deg. C, 65%RH	120Vac, 60Hz	Brad Wu
APCM	25deg. C, 65%RH	120Vac, 60Hz	Anderson Hong

**3.3 GENERAL DESCRIPTION OF APPLIED STANDARDS**

The EUT is a RF Product. According to the specifications of the manufacturer, it must comply with the requirements of the following standards:

- FCC Part 15, Subpart C (15.247)**
- ANSI C63.10-2009**
- 558074 D01 DTS Meas Guidance v01**
- FCC Public Notice DA 00-705**

All test items have been performed and recorded as per the above standards.

### 3.4 DESCRIPTION OF SUPPORT UNITS

The EUT has been tested as an independent unit together with other necessary accessories or support units. The following support units or accessories were used to form a representative test configuration during the tests.

#### FOR EMISSION TEST

NO.	PRODUCT	BRAND	MODEL NO.	SERIAL NO.	FCC ID
1	EARPHONE	Cotron	HS S250	NA	NA

NO.	SIGNAL CABLE DESCRIPTION OF THE ABOVE SUPPORT UNITS
1	NA

**NOTE:**

1. All power cords of the above support units are non shielded (1.8m).
2. Item 1 was provided by client.

#### 3.4.1 CONFIGURATION OF SYSTEM UNDER TEST

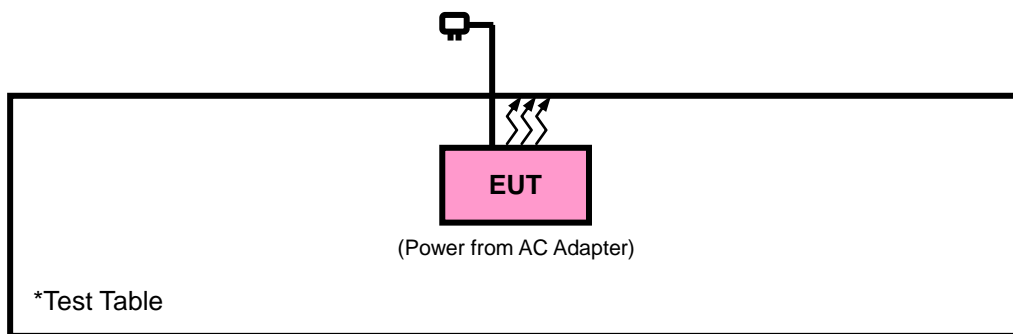



## 4. TEST TYPES AND RESULTS (FOR Bluetooth EDR)

### 4.1 RADIATED EMISSION AND BANDEGE MEASUREMENT

#### 4.1.1 LIMITS OF RADIATED EMISSION AND BANDEGE MEASUREMENT

Radiated emissions which fall in the restricted bands must comply with the radiated emission limits specified as below table. Other emissions shall be at least 20dB below the highest level of the desired power:

FREQUENCIES (MHz)	FIELD STRENGTH (microvolts/meter)	MEASUREMENT DISTANCE (meters)
0.009 ~ 0.490	2400/F(kHz)	300
0.490 ~ 1.705	24000/F(kHz)	30
1.705 ~ 30.0	30	30
30 ~ 88	100	3
88 ~ 216	150	3
216 ~ 960	200	3
Above 960	500	3

**NOTE:**

1. The lower limit shall apply at the transition frequencies.
2. Emission level (dBuV/m) = 20 log Emission level (uV/m).
3. For frequencies above 1000MHz, the field strength limits are based on average detector, however, the peak field strength of any emission shall not exceed the maximum permitted average limits, specified above by more than 20dB under any condition of modulation.



A D T

#### 4.1.2 TEST INSTRUMENTS

DESCRIPTION & MANUFACTURER	MODEL NO.	SERIAL NO.	DATE OF CALIBRATION	DUE DATE OF CALIBRATION
Test Receiver ROHDE & SCHWARZ	ESCI	100744	Apr. 19, 2012	Apr. 18, 2013
Spectrum Analyzer ROHDE & SCHWARZ	FSP40	100037	Nov. 02, 2011	Nov. 01, 2012
BILOG Antenna SCHWARZBECK	VULB9168	9168-156	Apr. 03, 2012	Apr. 02, 2013
HORN Antenna SCHWARZBECK	BBHA 9120 D	9120D-563	Sep. 06, 2011	Sep. 05, 2012
HORN Antenna SCHWARZBECK	BBHA 9170	148	Jul. 11, 2012	Jul. 10, 2013
Loop Antenna	HFH2-Z2	100070	Jan. 31, 2012	Jan. 30, 2014
Preamplifier Agilent	8449B	3008A01911	Oct. 29, 2011	Oct. 28, 2012
Preamplifier Agilent	8447D	2944A10638	Oct. 29, 2011	Oct. 28, 2012
RF signal cable HUBER+SUHNNER	SUCOFLEX 104	295013/4 283403/4	Aug. 19, 2011	Aug. 18, 2012
RF signal cable Worken	8D-FB	Cable-HYCH9-01	Aug. 13, 2011	Aug. 12, 2012
Software	ADT_Radiated_ V7.6.15.9.2	NA	NA	NA
Antenna Tower EMCO	2070/2080	512.835.4684	NA	NA
Turn Table EMCO	2087-2.03	NA	NA	NA
Antenna Tower & Turn Table Controller EMCO	2090	NA	NA	NA

- NOTE:** 1. The calibration interval of the above test instruments except loop antenna is 12 months and the calibrations are traceable to NML/ROC and NIST/USA.  
2. The calibration interval of loop antenna is 24 months and the calibrations are traceable to NML/ROC and NIST/USA.  
3. The test was performed in HwaYa Chamber 9.  
4. The horn antenna and HP preamplifier (model: 8449B) are used only for the measurement of emission frequency above 1GHz if tested.  
5. The FCC Site Registration No. is 460141.  
6. The IC Site Registration No. is IC 7450F-4.

#### 4.1.3 TEST PROCEDURES

- a. The EUT was placed on the top of a rotating table 0.8 meters above the ground at a 3 meter semi-anechoic chamber. The table was rotated 360 degrees to determine the position of the highest radiation.
- b. The EUT was set 3 meters away from the interference-receiving antenna, which was mounted on the top of a variable-height antenna tower.
- c. The antenna is a broadband antenna, and its height is varied from one meter to four meters above the ground to determine the maximum value of the field strength. Both horizontal and vertical polarizations of the antenna are set to make the measurement.
- d. For each suspected emission, the EUT was arranged to its worst case and then the antenna was tuned to heights from 1 meter to 4 meters and the rotatable table was turned from 0 degrees to 360 degrees to find the maximum reading.
- e. The test-receiver system was set to Peak Detect Function and Specified Bandwidth with Maximum Hold Mode.
- f. If the emission level of the EUT in peak mode was lower than the limit specified, then testing could be stopped and the peak values of the EUT would be reported. Otherwise the emissions would be re-tested one by one using peak, quasi-peak or average method as specified and then reported in a data sheet.

**NOTE:**

1. The resolution bandwidth and video bandwidth of test receiver/spectrum analyzer is 120kHz for Quasi-peak detection at frequency below 1GHz.
2. The resolution bandwidth of test receiver/spectrum analyzer is 1 MHz and video bandwidth is 3MHz for Peak detection at frequency above 1GHz.
3. All modes of operation were investigated and the worst-case emissions are reported.

#### 4.1.4 DEVIATION FROM TEST STANDARD

No deviation.

#### 4.1.5 TEST SETUP

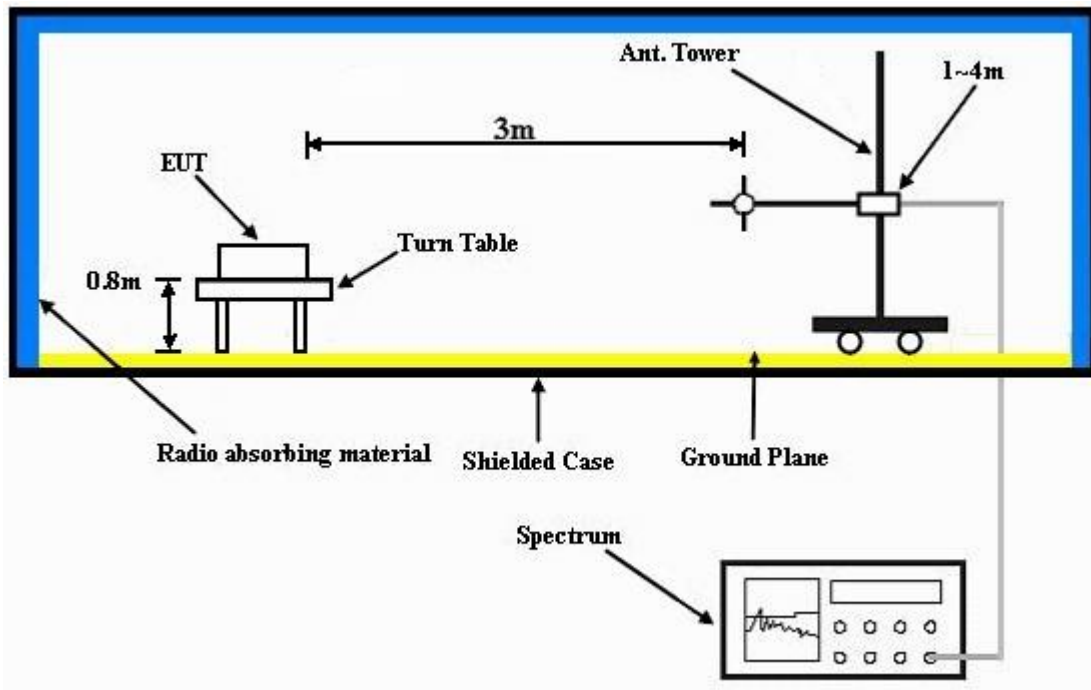

For the actual test configuration, please refer to the attached file (Test Setup Photo).

#### 4.1.6 EUT OPERATING CONDITIONS

- a. Placed the EUT on a testing table.
- b. Use the software to control the EUT under transmission condition continuously at specific channel frequency.



## 4.1.7 TEST RESULTS

## ABOVE 1GHZ WORST-CASE DATA : GFSK

EUT TEST CONDITION		MEASUREMENT DETAIL	
CHANNEL	Channel 0	FREQUENCY RANGE	1 ~ 25GHz
INPUT POWER (SYSTEM)	120Vac, 60 Hz	DETECTOR FUNCTION	Peak (PK) Average (AV)
ENVIRONMENTAL CONDITIONS	25deg. C, 65%RH	TESTED BY	Anderson Hong

ANTENNA POLARITY & TEST DISTANCE: HORIZONTAL AT 3 M								
NO.	FREQ. (MHz)	EMISSION LEVEL (dBuV/m)	LIMIT (dBuV/m)	MARGIN (dB)	ANTENNA HEIGHT (m)	TABLE ANGLE (Degree)	RAW VALUE (dBuV)	CORRECTION FACTOR (dB/m)
1	2382.00	39.7 PK	74.0	-34.3	1.29 H	88	8.32	31.34
2	2382.00	32.1 AV	54.0	-21.9	1.29 H	88	0.72	31.34
3	#2398.00	42.1 PK	75.5	-33.4	1.29 H	88	10.73	31.39
4	#2398.00	29.2 AV	45.4	-16.2	1.29 H	88	-2.17	31.39
5	#2400.00	37.2 PK	75.5	-38.3	1.29 H	88	5.81	31.40
6	#2400.00	7.1 AV	45.4	-38.3	1.29 H	88	-24.29	31.40
7	*2402.00	95.5 PK			1.29 H	88	64.10	31.41
8	*2402.00	65.4 AV			1.29 H	88	34.00	31.41
9	4804.00	45.1 PK	74.0	-28.9	1.13 H	118	7.66	37.42
10	4804.00	15.0 AV	54.0	-39.0	1.13 H	118	-22.44	37.42

## REMARKS:

1. Emission level (dBuV/m) = Raw Value (dBuV) + Correction Factor (dB/m).
2. Correction Factor (dB/m) = Antenna Factor (dB/m) + Cable Factor (dB).
3. The other emission levels were very low against the limit.
4. Margin value = Emission level – Limit value.
5. “ \* “: Fundamental frequency.
6. The DH5 packet was the worse case duty cycle for a transmit dwell time on a channel, based upon bluetooth theory the transmitter is on 0.625 \* 5 per 296.25 ms per channel. Therefore, the duty cycle correlation factor be equal to:  $20\log(3.125 / 100) = -30.1$  dB.
7. Average value = peak reading +  $20\log(\text{duty cycle})$ .



A D T

EUT TEST CONDITION		MEASUREMENT DETAIL	
CHANNEL	Channel 0	FREQUENCY RANGE	1 ~ 25GHz
INPUT POWER (SYSTEM)	120Vac, 60 Hz	DETECTOR FUNCTION	Peak (PK) Average (AV)
ENVIRONMENTAL CONDITIONS	25deg. C, 65%RH	TESTED BY	Anderson Hong

ANTENNA POLARITY & TEST DISTANCE: VERTICAL AT 3 M								
NO.	FREQ. (MHz)	EMISSION LEVEL (dBuV/m)	LIMIT (dBuV/m)	MARGIN (dB)	ANTENNA HEIGHT (m)	TABLE ANGLE (Degree)	RAW VALUE (dBuV)	CORRECTION FACTOR (dB/m)
1	2382.00	37.5 PK	74.0	-36.5	1.72 V	199	6.15	31.34
2	2382.00	26.4 AV	54.0	-27.6	1.72 V	199	-4.95	31.34
3	#2398.00	40.8 PK	73.2	-32.4	1.72 V	199	9.43	31.39
4	#2398.00	28.2 AV	43.1	-14.9	1.72 V	199	-3.17	31.39
5	#2400.00	36.1 PK	73.2	-37.1	1.72 V	199	4.70	31.40
6	#2400.00	6.0 AV	43.1	-37.1	1.72 V	199	-25.40	31.40
7	*2402.00	93.2 PK			1.72 V	199	61.80	31.41
8	*2402.00	63.1 AV			1.72 V	199	31.70	31.41
9	4804.00	45.9 PK	74.0	-28.1	1.00 V	80	8.46	37.42
10	4804.00	15.8 AV	54.0	-38.2	1.00 V	80	-21.64	37.42

**REMARKS:**

1. Emission level (dBuV/m) = Raw Value (dBuV) + Correction Factor (dB/m).
2. Correction Factor (dB/m) = Antenna Factor (dB/m) + Cable Factor (dB).
3. The other emission levels were very low against the limit.
4. Margin value = Emission level – Limit value.
5. “ \* “: Fundamental frequency.
6. The DH5 packet was the worse case duty cycle for a transmit dwell time on a channel, based upon bluetooth theory the transmitter is on 0.625 \* 5 per 296.25 ms per channel. Therefore, the duty cycle correlation factor be equal to:  $20\log(3.125 / 100) = -30.1$  dB.
7. Average value = peak reading +  $20\log(\text{duty cycle})$ .
8. "#":The radiated frequency is out the restricted band.



A D T

EUT TEST CONDITION		MEASUREMENT DETAIL	
CHANNEL	Channel 39	FREQUENCY RANGE	1 ~ 25GHz
INPUT POWER (SYSTEM)	120Vac, 60 Hz	DETECTOR FUNCTION	Peak (PK) Average (AV)
ENVIRONMENTAL CONDITIONS	25deg. C, 65%RH	TESTED BY	Anderson Hong

ANTENNA POLARITY & TEST DISTANCE: HORIZONTAL AT 3 M								
NO.	FREQ. (MHz)	EMISSION LEVEL (dBuV/m)	LIMIT (dBuV/m)	MARGIN (dB)	ANTENNA HEIGHT (m)	TABLE ANGLE (Degree)	RAW VALUE (dBuV)	CORRECTION FACTOR (dB/m)
1	*2441.00	95.7 PK			1.28 H	87	64.10	31.56
2	*2441.00	65.6 AV			1.28 H	87	34.00	31.56
3	4882.00	45.3 PK	74.0	-28.7	1.14 H	121	7.70	37.57
4	4882.00	15.2 AV	54.0	-38.8	1.14 H	121	-22.40	37.57
5	7323.00	51.5 PK	74.0	-22.5	1.28 H	60	7.75	43.77
6	7323.00	21.4 AV	54.0	-32.6	1.28 H	60	-22.35	43.77
ANTENNA POLARITY & TEST DISTANCE: VERTICAL AT 3 M								
NO.	FREQ. (MHz)	EMISSION LEVEL (dBuV/m)	LIMIT (dBuV/m)	MARGIN (dB)	ANTENNA HEIGHT (m)	TABLE ANGLE (Degree)	RAW VALUE (dBuV)	CORRECTION FACTOR (dB/m)
1	*2441.00	92.5 PK			1.71 V	201	60.90	31.56
2	*2441.00	62.4 AV			1.71 V	201	30.80	31.56
3	4844.00	45.2 PK	74.0	-28.8	1.00 V	83	7.69	37.49
4	4844.00	15.1 AV	54.0	-38.9	1.00 V	83	-22.41	37.49
5	7323.00	50.7 PK	74.0	-23.3	1.46 V	274	6.95	43.77
6	7323.00	20.6 AV	54.0	-33.4	1.46 V	274	-23.15	43.77

**REMARKS:**

1. Emission level (dBuV/m) = Raw Value (dBuV) + Correction Factor (dB/m).
2. Correction Factor (dB/m) = Antenna Factor (dB/m) + Cable Factor (dB).
3. The other emission levels were very low against the limit.
4. Margin value = Emission level – Limit value.
5. “ \* “: Fundamental frequency.
6. The DH5 packet was the worse case duty cycle for a transmit dwell time on a channel, based upon bluetooth theory the transmitter is on 0.625 \* 5 per 296.25 ms per channel. Therefore, the duty cycle correlation factor be equal to:  $20\log(3.125 / 100) = -30.1$  dB.
7. Average value = peak reading +  $20\log(\text{duty cycle})$ .



A D T

EUT TEST CONDITION		MEASUREMENT DETAIL	
CHANNEL	Channel 78	FREQUENCY RANGE	1 ~ 25GHz
INPUT POWER (SYSTEM)	120Vac, 60 Hz	DETECTOR FUNCTION	Peak (PK) Average (AV)
ENVIRONMENTAL CONDITIONS	25deg. C, 65%RH	TESTED BY	Anderson Hong

ANTENNA POLARITY & TEST DISTANCE: HORIZONTAL AT 3 M								
NO.	FREQ. (MHz)	EMISSION LEVEL (dBuV/m)	LIMIT (dBuV/m)	MARGIN (dB)	ANTENNA HEIGHT (m)	TABLE ANGLE (Degree)	RAW VALUE (dBuV)	CORRECTION FACTOR (dB/m)
1	*2480.00	96.3 PK			1.24 H	90	64.60	31.70
2	*2480.00	66.2 AV			1.24 H	90	34.50	31.70
3	2483.50	33.3 PK	74.0	-40.7	1.24 H	90	1.58	31.72
4	2483.50	3.2 AV	54.0	-50.8	1.24 H	90	-28.52	31.72
5	2500.00	42.2 PK	74.0	-31.8	1.23 H	91	10.42	31.78
6	2500.00	33.4 AV	54.0	-20.6	1.23 H	91	1.62	31.78
7	4960.00	45.0 PK	74.0	-29.0	1.17 H	125	7.21	37.77
8	4960.00	14.9 AV	54.0	-39.1	1.17 H	125	-22.89	37.77

ANTENNA POLARITY & TEST DISTANCE: VERTICAL AT 3 M								
NO.	FREQ. (MHz)	EMISSION LEVEL (dBuV/m)	LIMIT (dBuV/m)	MARGIN (dB)	ANTENNA HEIGHT (m)	TABLE ANGLE (Degree)	RAW VALUE (dBuV)	CORRECTION FACTOR (dB/m)
1	*2480.00	91.4 PK			1.66 V	202	59.70	31.70
2	*2480.00	61.3 AV			1.66 V	202	29.60	31.70
3	2483.50	31.8 PK	74.0	-42.2	1.66 V	202	0.08	31.72
4	2483.50	1.7 AV	54.0	-52.3	1.66 V	202	-30.02	31.72
5	2500.00	39.4 PK	74.0	-34.7	1.66 V	202	7.57	31.78
6	2500.00	26.6 AV	54.0	-27.5	1.66 V	202	-5.23	31.78
7	4960.00	45.4 PK	74.0	-28.6	1.00 V	81	7.61	37.77
8	4960.00	15.3 AV	54.0	-38.7	1.00 V	81	-22.49	37.77

**REMARKS:**

1. Emission level (dBuV/m) = Raw Value (dBuV) + Correction Factor (dB/m).
2. Correction Factor (dB/m) = Antenna Factor (dB/m) + Cable Factor (dB).
3. The other emission levels were very low against the limit.
4. Margin value = Emission level – Limit value.
5. “ \* “: Fundamental frequency.
6. The DH5 packet was the worse case duty cycle for a transmit dwell time on a channel, based upon bluetooth theory the transmitter is on 0.625 \* 5 per 296.25 ms per channel. Therefore, the duty cycle correlation factor be equal to:  $20\log(3.125 / 100) = -30.1$  dB.
7. Average value = peak reading +  $20\log(\text{duty cycle})$ .





A D T

### 8DPSK

EUT TEST CONDITION		MEASUREMENT DETAIL	
CHANNEL	Channel 0	FREQUENCY RANGE	1 ~ 25GHz
INPUT POWER (SYSTEM)	120Vac, 60 Hz	DETECTOR FUNCTION	Peak (PK) Average (AV)
ENVIRONMENTAL CONDITIONS	25deg. C, 65%RH	TESTED BY	Anderson Hong

ANTENNA POLARITY & TEST DISTANCE: HORIZONTAL AT 3 M								
NO.	FREQ. (MHz)	EMISSION LEVEL (dBuV/m)	LIMIT (dBuV/m)	MARGIN (dB)	ANTENNA HEIGHT (m)	TABLE ANGLE (Degree)	RAW VALUE (dBuV)	CORRECTION FACTOR (dB/m)
1	2382.00	40.9 PK	74.0	-33.1	1.30 H	89	9.52	31.34
2	2382.00	30.6 AV	54.0	-23.4	1.30 H	89	-0.78	31.34
3	#2398.00	40.5 PK	76.5	-36.0	1.29 H	87	9.13	31.39
4	#2398.00	28.6 AV	46.4	-17.8	1.29 H	87	-2.77	31.39
5	#2400.00	39.9 PK	76.5	-36.6	1.29 H	87	8.50	31.40
6	#2400.00	9.8 AV	46.4	-36.6	1.29 H	87	-21.60	31.40
7	*2402.00	96.5 PK			1.29 H	87	65.10	31.41
8	*2402.00	66.4 AV			1.29 H	87	35.00	31.41
9	4804.00	45.3 PK	74.0	-28.7	1.05 H	93	7.86	37.42
10	4804.00	15.2 AV	54.0	-38.8	1.05 H	93	-22.24	37.42

#### REMARKS:

1. Emission level (dBuV/m) = Raw Value (dBuV) + Correction Factor (dB/m).
2. Correction Factor (dB/m) = Antenna Factor (dB/m) + Cable Factor (dB).
3. The other emission levels were very low against the limit.
4. Margin value = Emission level – Limit value.
5. “ \* ”: Fundamental frequency.
6. The DH5 packet was the worse case duty cycle for a transmit dwell time on a channel, based upon bluetooth theory the transmitter is on 0.625 \* 5 per 296.25 ms per channel. Therefore, the duty cycle correlation factor be equal to:  $20\log(3.125 / 100) = -30.1$  dB.
7. Average value = peak reading +  $20\log(\text{duty cycle})$ .



A D T

EUT TEST CONDITION		MEASUREMENT DETAIL	
CHANNEL	Channel 0	FREQUENCY RANGE	1 ~ 25GHz
INPUT POWER (SYSTEM)	120Vac, 60 Hz	DETECTOR FUNCTION	Peak (PK) Average (AV)
ENVIRONMENTAL CONDITIONS	25deg. C, 65%RH	TESTED BY	Anderson Hong

ANTENNA POLARITY & TEST DISTANCE: VERTICAL AT 3 M								
NO.	FREQ. (MHz)	EMISSION LEVEL (dBuV/m)	LIMIT (dBuV/m)	MARGIN (dB)	ANTENNA HEIGHT (m)	TABLE ANGLE (Degree)	RAW VALUE (dBuV)	CORRECTION FACTOR (dB/m)
1	2382.00	39.9 PK	74.0	-34.1	1.70 V	200	8.52	31.34
2	2382.00	29.1 AV	54.0	-24.9	1.70 V	200	-2.28	31.34
3	#2398.00	38.7 PK	74.3	-35.6	1.74 V	201	7.33	31.39
4	#2398.00	28.2 AV	44.2	-16.0	1.74 V	201	-3.17	31.39
5	#2400.00	38.3 PK	74.3	-36.0	1.74 V	201	6.90	31.40
6	#2400.00	8.2 AV	44.2	-36.0	1.74 V	201	-23.20	31.40
7	*2402.00	94.3 PK			1.74 V	201	62.90	31.41
8	*2402.00	64.2 AV			1.74 V	201	32.80	31.41
9	4804.00	46.2 PK	74.0	-27.8	1.36 V	52	8.76	37.42
10	4804.00	16.1 AV	54.0	-37.9	1.36 V	52	-21.34	37.42

**REMARKS:**

1. Emission level (dBuV/m) = Raw Value (dBuV) + Correction Factor (dB/m).
2. Correction Factor (dB/m) = Antenna Factor (dB/m) + Cable Factor (dB).
3. The other emission levels were very low against the limit.
4. Margin value = Emission level – Limit value.
5. “ \* “: Fundamental frequency.
6. The DH5 packet was the worse case duty cycle for a transmit dwell time on a channel, based upon bluetooth theory the transmitter is on 0.625 \* 5 per 296.25 ms per channel. Therefore, the duty cycle correlation factor be equal to:  $20\log(3.125 / 100) = -30.1$  dB.
7. Average value = peak reading +  $20\log(\text{duty cycle})$ .
8. "#":The radiated frequency is out the restricted band.



A D T

EUT TEST CONDITION		MEASUREMENT DETAIL	
CHANNEL	Channel 39	FREQUENCY RANGE	1 ~ 25GHz
INPUT POWER (SYSTEM)	120Vac, 60 Hz	DETECTOR FUNCTION	Peak (PK) Average (AV)
ENVIRONMENTAL CONDITIONS	25deg. C, 65%RH	TESTED BY	Anderson Hong

ANTENNA POLARITY & TEST DISTANCE: HORIZONTAL AT 3 M								
NO.	FREQ. (MHz)	EMISSION LEVEL (dBuV/m)	LIMIT (dBuV/m)	MARGIN (dB)	ANTENNA HEIGHT (m)	TABLE ANGLE (Degree)	RAW VALUE (dBuV)	CORRECTION FACTOR (dB/m)
1	*2441.00	97.1 PK			1.27 H	87	65.50	31.56
2	*2441.00	67.0 AV			1.27 H	87	35.40	31.56
3	4882.00	45.2 PK	74.0	-28.8	1.32 H	248	7.60	37.57
4	4882.00	15.1 AV	54.0	-38.9	1.32 H	248	-22.50	37.57
5	7323.00	50.9 PK	74.0	-23.1	1.13 H	37	7.15	43.77
6	7323.00	20.8 AV	54.0	-33.2	1.13 H	37	-22.95	43.77
ANTENNA POLARITY & TEST DISTANCE: VERTICAL AT 3 M								
NO.	FREQ. (MHz)	EMISSION LEVEL (dBuV/m)	LIMIT (dBuV/m)	MARGIN (dB)	ANTENNA HEIGHT (m)	TABLE ANGLE (Degree)	RAW VALUE (dBuV)	CORRECTION FACTOR (dB/m)
1	*2441.00	93.7 PK			1.68 V	201	62.10	31.56
2	*2441.00	63.6 AV			1.68 V	201	32.00	31.56
3	4882.00	45.5 PK	74.0	-28.5	1.41 V	50	7.90	37.57
4	4882.00	15.4 AV	54.0	-38.6	1.41 V	50	-22.20	37.57
5	7323.00	51.6 PK	74.0	-22.4	1.08 V	152	7.85	43.77
6	7323.00	21.5 AV	54.0	-32.5	1.08 V	152	-22.25	43.77

**REMARKS:**

- Emission level (dBuV/m) = Raw Value (dBuV) + Correction Factor (dB/m).
- Correction Factor (dB/m) = Antenna Factor (dB/m) + Cable Factor (dB).
- The other emission levels were very low against the limit.
- Margin value = Emission level – Limit value.
- \* \* \*: Fundamental frequency.
- The DH5 packet was the worse case duty cycle for a transmit dwell time on a channel, based upon bluetooth theory the transmitter is on 0.625 \* 5 per 296.25 ms per channel. Therefore, the duty cycle correlation factor be equal to:  $20\log(3.125 / 100) = -30.1$  dB.
- Average value = peak reading +  $20\log(\text{duty cycle})$ .



A D T

EUT TEST CONDITION		MEASUREMENT DETAIL	
CHANNEL	Channel 78	FREQUENCY RANGE	1 ~ 25GHz
INPUT POWER (SYSTEM)	120Vac, 60 Hz	DETECTOR FUNCTION	Peak (PK) Average (AV)
ENVIRONMENTAL CONDITIONS	25deg. C, 65%RH	TESTED BY	Anderson Hong

ANTENNA POLARITY & TEST DISTANCE: HORIZONTAL AT 3 M								
NO.	FREQ. (MHz)	EMISSION LEVEL (dBuV/m)	LIMIT (dBuV/m)	MARGIN (dB)	ANTENNA HEIGHT (m)	TABLE ANGLE (Degree)	RAW VALUE (dBuV)	CORRECTION FACTOR (dB/m)
1	*2480.00	97.8 PK			1.24 H	88	66.10	31.70
2	*2480.00	67.7 AV			1.24 H	88	36.00	31.70
3	2483.50	35.7 PK	74.0	-38.3	1.24 H	88	3.98	31.72
4	2483.50	5.6 AV	54.0	-48.4	1.24 H	88	-26.12	31.72
5	2500.00	41.0 PK	74.0	-33.0	1.23 H	90	9.22	31.78
6	2500.00	31.0 AV	54.0	-23.0	1.23 H	90	-0.78	31.78
7	4960.00	45.1 PK	74.0	-28.9	1.35 H	241	7.31	37.77
8	4960.00	15.0 AV	54.0	-39.0	1.35 H	241	-22.79	37.77
ANTENNA POLARITY & TEST DISTANCE: VERTICAL AT 3 M								
NO.	FREQ. (MHz)	EMISSION LEVEL (dBuV/m)	LIMIT (dBuV/m)	MARGIN (dB)	ANTENNA HEIGHT (m)	TABLE ANGLE (Degree)	RAW VALUE (dBuV)	CORRECTION FACTOR (dB/m)
1	*2480.00	92.5 PK			1.68 V	204	60.80	31.70
2	*2480.00	62.4 AV			1.68 V	204	30.70	31.70
3	2483.50	31.6 PK	74.0	-42.4	1.68 V	204	-0.12	31.72
4	2483.50	1.5 AV	54.0	-52.5	1.68 V	204	-30.22	31.72
5	2485.50	40.0 PK	74.0	-34.1	1.65 V	208	8.23	31.72
6	2485.50	27.4 AV	54.0	-26.7	1.65 V	208	-4.37	31.72
7	4960.00	45.3 PK	74.0	-28.7	1.39 V	53	7.51	37.77
8	4960.00	15.2 AV	54.0	-38.8	1.39 V	53	-22.59	37.77

**REMARKS:**

- Emission level (dBuV/m) = Raw Value (dBuV) + Correction Factor (dB/m).
- Correction Factor (dB/m) = Antenna Factor (dB/m) + Cable Factor (dB).
- The other emission levels were very low against the limit.
- Margin value = Emission level – Limit value.
- \* \* \*: Fundamental frequency.
- The DH5 packet was the worse case duty cycle for a transmit dwell time on a channel, based upon bluetooth theory the transmitter is on 0.625 \* 5 per 296.25 ms per channel. Therefore, the duty cycle correlation factor be equal to:  $20\log(3.125 / 100) = -30.1$  dB.
- Average value = peak reading +  $20\log(\text{duty cycle})$ .



A D T

**BELOW 1GHz WORST-CASE DATA : 8DPSK**

EUT TEST CONDITION		MEASUREMENT DETAIL	
CHANNEL	Channel 0	FREQUENCY RANGE	Below 1000MHz
INPUT POWER (SYSTEM)	120Vac, 60 Hz	DETECTOR FUNCTION	Quasi-Peak
ENVIRONMENTAL CONDITIONS	25deg. C, 65%RH	TESTED BY	Anderson Hong

ANTENNA POLARITY & TEST DISTANCE: HORIZONTAL AT 3 M								
NO.	FREQ. (MHz)	EMISSION LEVEL (dBuV/m)	LIMIT (dBuV/m)	MARGIN (dB)	ANTENNA HEIGHT (m)	TABLE ANGLE (Degree)	RAW VALUE (dBuV)	CORRECTION FACTOR (dB/m)
1	189.08	21.3 QP	43.5	-22.2	1.50 H	296	9.30	12.04
2	297.72	23.7 QP	46.0	-22.3	1.00 H	119	8.90	14.82
3	390.84	29.9 QP	46.0	-16.1	1.00 H	347	12.69	17.24
4	515.00	24.4 QP	46.0	-21.6	1.25 H	301	3.90	20.46
5	544.10	26.8 QP	46.0	-19.2	1.00 H	98	5.63	21.15
6	582.90	24.9 QP	46.0	-21.1	1.00 H	228	2.88	22.01
ANTENNA POLARITY & TEST DISTANCE: VERTICAL AT 3 M								
NO.	FREQ. (MHz)	EMISSION LEVEL (dBuV/m)	LIMIT (dBuV/m)	MARGIN (dB)	ANTENNA HEIGHT (m)	TABLE ANGLE (Degree)	RAW VALUE (dBuV)	CORRECTION FACTOR (dB/m)
1	189.08	29.0 QP	43.5	-14.5	1.00 V	2	16.97	12.04
2	249.22	29.2 QP	46.0	-16.8	1.00 V	52	16.17	13.01
3	295.78	24.0 QP	46.0	-22.0	1.00 V	98	9.24	14.75
4	332.64	23.8 QP	46.0	-22.3	1.50 V	57	8.01	15.74
5	499.48	24.3 QP	46.0	-21.7	1.25 V	217	4.22	20.09
6	699.30	27.9 QP	46.0	-18.1	1.25 V	196	5.05	22.81

**REMARKS:**

1. Emission level (dBuV/m) = Raw Value (dBuV) + Correction Factor (dB/m).
2. Correction Factor (dB/m) = Antenna Factor (dB/m) + Cable Factor (dB).
3. The other emission levels were very low against the limit.
4. Margin value = Emission level – Limit value.

## 4.2 CONDUCTED EMISSION MEASUREMENT

### 4.2.1 LIMITS OF CONDUCTED EMISSION MEASUREMENT

FREQUENCY OF EMISSION (MHz)	CONDUCTED LIMIT (dB $\mu$ V)	
	Quasi-peak	Average
0.15 ~ 0.5	66 to 56	56 to 46
0.5 ~ 5	56	46
5 ~ 30	60	50

- NOTE:**
1. The lower limit shall apply at the transition frequencies.
  2. The limit decreases in line with the logarithm of the frequency in the range of 0.15 to 0.50 MHz.
  3. All emanations from a class A/B digital device or system, including any network of conductors and apparatus connected thereto, shall not exceed the level of field strengths specified above.

### 4.2.2 TEST INSTRUMENTS

DESCRIPTION & MANUFACTURER	MODEL NO.	SERIAL NO.	DATE OF CALIBRATION	DUE DATE OF CALIBRATION
Test Receiver ROHDE & SCHWARZ	ESCS30	100289	Nov. 19, 2011	Nov. 18, 2012
RF signal cable Woken	5D-FB	Cable-HYCO2-01	Dec. 22, 2011	Dec. 21, 2012
LISN ROHDE & SCHWARZ (EUT)	ESH2-Z5	100100	Dec. 30, 2011	Dec. 29, 2012
LISN ROHDE & SCHWARZ (Peripheral)	ESH3-Z5	100218	Dec. 08, 2011	Dec. 07, 2012
Software ADT	BV ADT_Cond_ V7.3.7.3	NA	NA	NA

- NOTE:**
1. The calibration interval of the above test instruments is 12 months and the calibrations are traceable to NML/ROC and NIST/USA.
  2. The test was performed in HwaYa Shielded Room 2.
  3. The VCCI Site Registration No. is C-2047.

#### 4.2.3 TEST PROCEDURES

- a. The EUT was placed 0.4 meters from the conducting wall of the shielded room with EUT being connected to the power mains through a line impedance stabilization network (LISN). Other support units were connected to the power mains through another LISN. The two LISNs provide 50 ohm/ 50uH of coupling impedance for the measuring instrument.
- b. Both lines of the power mains connected to the EUT were checked for maximum conducted interference.
- c. The frequency range from 150kHz to 30MHz was searched. Emission levels under (Limit - 20dB) was not recorded.

**NOTE:** All modes of operation were investigated and the worst-case emissions are reported.

#### 4.2.4 DEVIATION FROM TEST STANDARD

No deviation.

#### 4.2.5 TEST SETUP

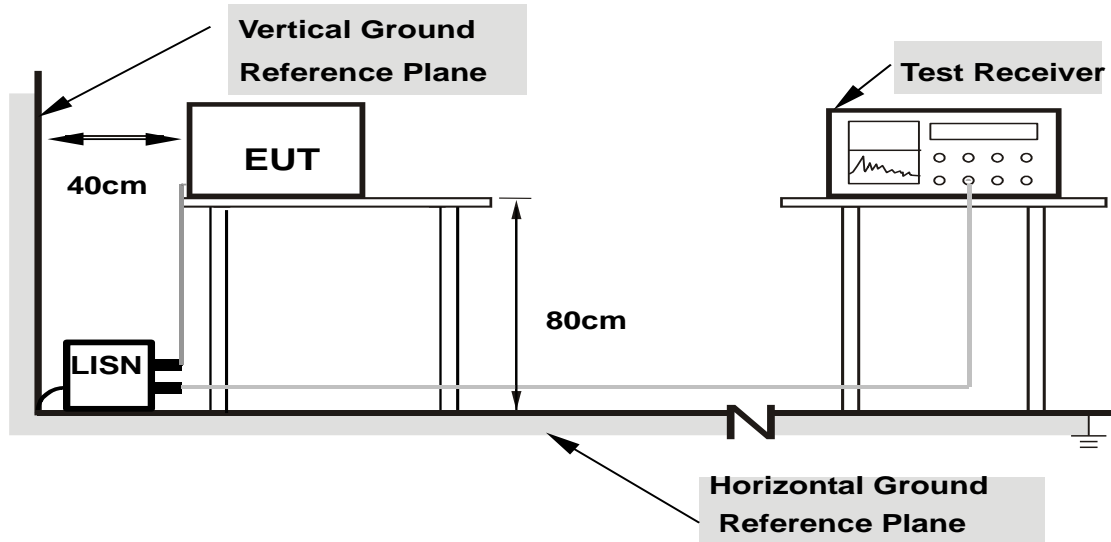

- Note: 1.Support units were connected to second LISN.  
2.Both of LISNs (AMN) are 80 cm from EUT and at least 80 from other units and other metal planes**

For the actual test configuration, please refer to the attached file (Test Setup Photo).

#### 4.2.6 EUT OPERATING CONDITIONS

Same as 4.1.6.



### 4.2.7 TEST RESULTS

#### CONDUCTED WORST CASE DATA: 8DPSK

PHASE	Line 1	6dB BANDWIDTH	9kHz
-------	--------	---------------	------

No	Freq. [MHz]	Corr. Factor (dB)	Reading Value [dB (uV)]		Emission Level [dB (uV)]		Limit [dB (uV)]		Margin (dB)	
			Q.P.	AV.	Q.P.	AV.	Q.P.	AV.	Q.P.	AV.
			1	0.15781	0.17	19.93	5.93	20.10	6.10	65.58
2	<b>0.38828</b>	<b>0.20</b>	<b>31.87</b>	<b>26.19</b>	<b>32.07</b>	<b>26.39</b>	<b>58.10</b>	<b>48.10</b>	<b>-26.03</b>	<b>-21.71</b>
3	1.99219	0.30	29.02	21.80	29.32	22.10	56.00	46.00	-26.68	-23.90
4	4.40625	0.40	21.42	12.35	21.82	12.75	56.00	46.00	-34.18	-33.25
5	6.79297	0.43	18.73	10.60	19.16	11.03	60.00	50.00	-40.84	-38.97
6	16.41797	0.64	27.59	21.40	28.23	22.04	60.00	50.00	-31.77	-27.96

#### REMARKS:

1. Q.P. and AV. are abbreviations of quasi-peak and average individually.
2. The emission levels of other frequencies were very low against the limit.
3. Margin value = Emission level - Limit value
4. Correction factor = Insertion loss + Cable loss
5. Emission Level = Correction Factor + Reading Value.

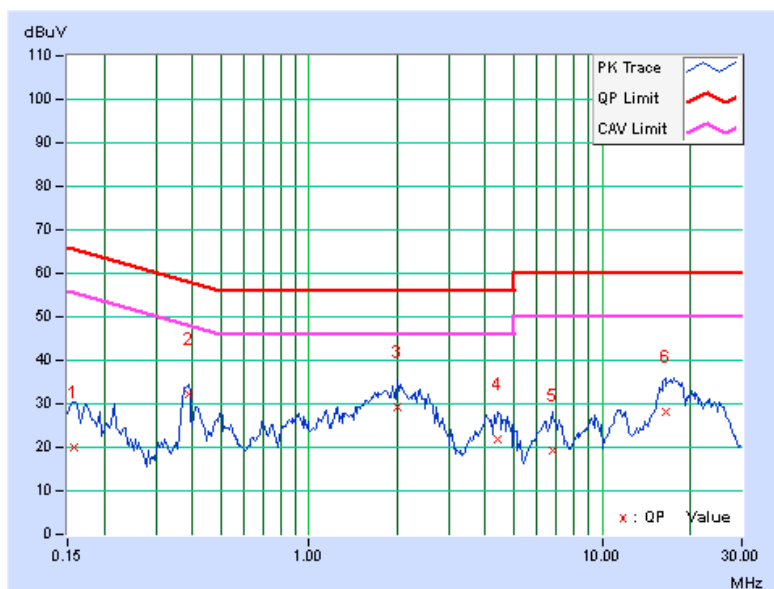

PHASE	Line 2	6dB BANDWIDTH	9kHz
-------	--------	---------------	------

No	Freq. [MHz]	Corr. Factor (dB)	Reading Value [dB (uV)]		Emission Level [dB (uV)]		Limit [dB (uV)]		Margin (dB)	
			Q.P.	AV.	Q.P.	AV.	Q.P.	AV.	Q.P.	AV.
			1	0.15000	0.17	26.58	22.25	26.75	22.42	66.00
2	0.38828	0.18	31.84	25.63	32.02	25.81	58.10	48.10	-26.08	-22.29
3	1.77344	0.25	28.54	23.26	28.79	23.51	56.00	46.00	-27.21	-22.49
4	4.23047	0.39	21.57	15.98	21.96	16.37	56.00	46.00	-34.04	-29.63
5	7.16406	0.48	21.06	11.36	21.54	11.84	60.00	50.00	-38.46	-38.16
6	16.22656	0.73	27.28	21.45	28.01	22.18	60.00	50.00	-31.99	-27.82

**REMARKS:**

1. Q.P. and AV. are abbreviations of quasi-peak and average individually.
2. The emission levels of other frequencies were very low against the limit.
3. Margin value = Emission level - Limit value
4. Correction factor = Insertion loss + Cable loss
5. Emission Level = Correction Factor + Reading Value.

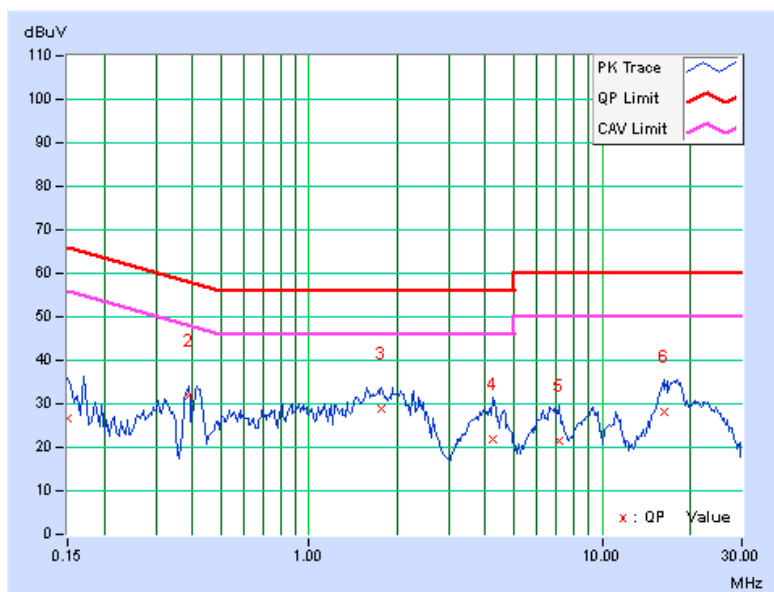

### 4.3 NUMBER OF HOPPING FREQUENCY USED

#### 4.3.1 LIMIT OF HOPPING FREQUENCY USED

At least 15 channels frequencies, and should be equally spaced.

#### 4.3.2 TEST SETUP

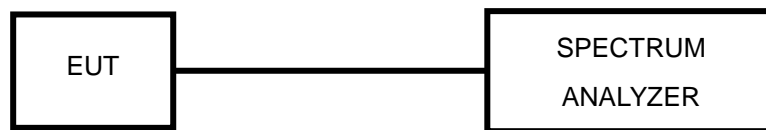

#### 4.3.3 TEST INSTRUMENTS

Refer to section 4.1.2 to get information of above instrument.

#### 4.3.4 TEST PROCEDURES

- a. Check the calibration of the measuring instrument (SA) using either an internal calibrator or a known signal from an external generator.
- b. Turn on the EUT and connect its antenna terminal to measurement via a low loss cable. Then set it to any one measured frequency within its operating range and make sure the instrument is operated in its linear range.
- c. Set the SA on MaxHold Mode, and then keep the EUT in hopping mode. Record all the signals from each channel until each one has been recorded.
- d. Set the SA on View mode and then plot the result on SA screen.
- e. Repeat above procedures until all frequencies measured were complete.

#### 4.3.5 DEVIATION FROM TEST STANDARD

No deviation.

#### 4.3.6 TEST RESULTS

There are 79 hopping frequencies in the hopping mode. Please refer to next two pages for the test result. On the plots, it shows that the hopping frequencies are equally spaced.



A D T

### GFSK

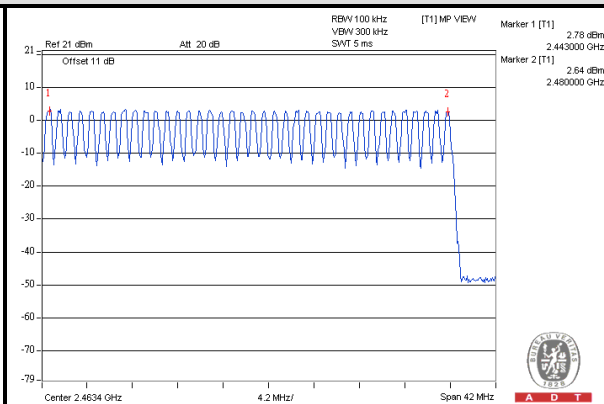
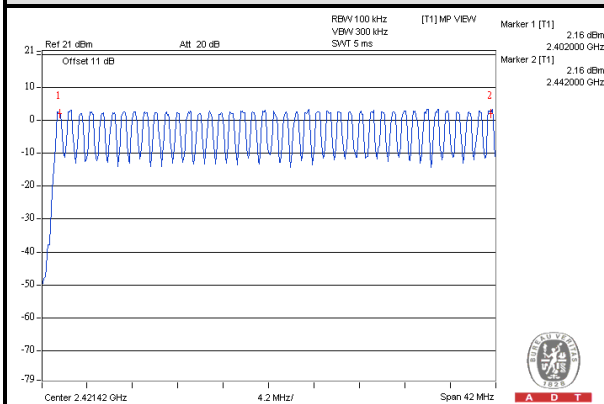

### $\pi/4$ -DQPSK

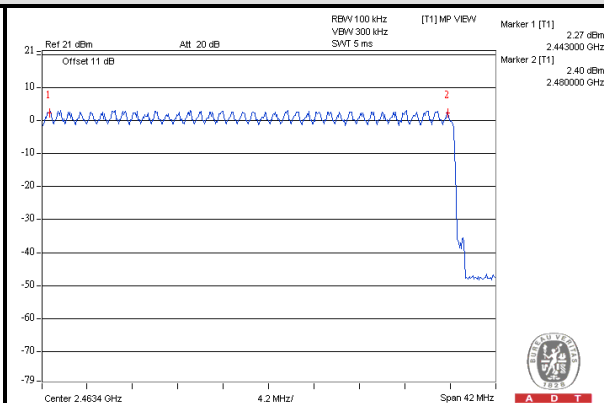
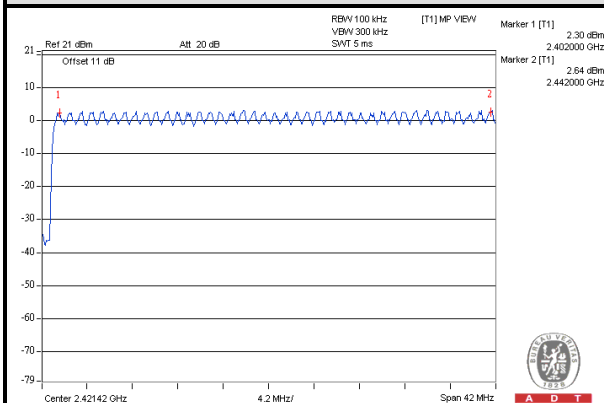

### 8DPSK

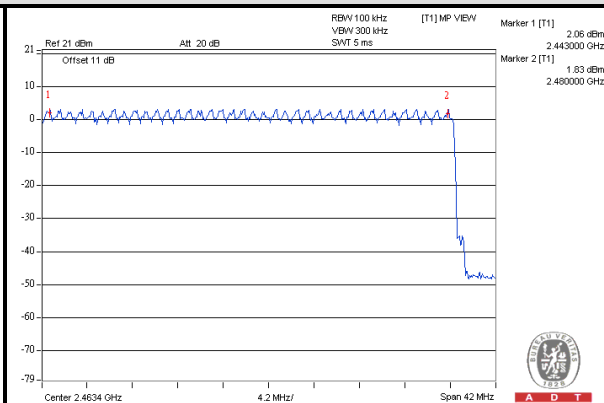
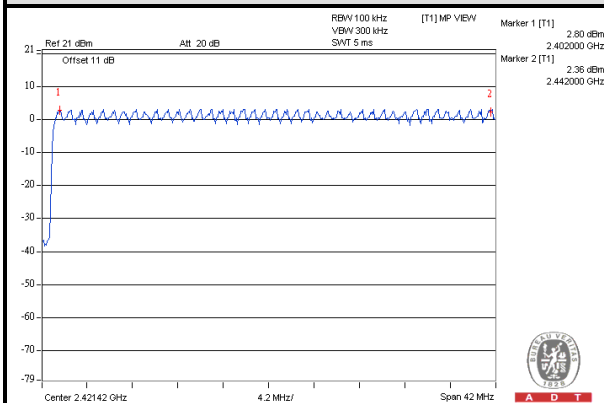

## 4.4 DWELL TIME ON EACH CHANNEL

### 4.4.1 LIMIT OF DWELL TIME USED

The average time of occupancy on any channel shall not be greater than 0.4 seconds within a period of 0.4 seconds multiplied by the number of hopping channels employed.

### 4.4.2 TEST SETUP

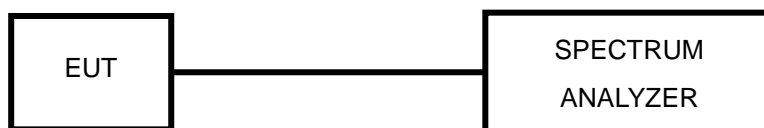

### 4.4.3 TEST INSTRUMENTS

Refer to section 4.1.2 to get information of above instrument.

### 4.4.4 TEST PROCEDURES

- a. Check the calibration of the measuring instrument (SA) using either an internal calibrator or a known signal from an external generator.
- b. Turn on the EUT and connect its antenna terminal to measurement via a low loss cable. Then set it to any one measured frequency within its operating range and make sure the instrument is operated in its linear range.
- c. Adjust the center frequency of SA on any frequency be measured and set SA to zero span mode. And then, set RBW and VBW of spectrum analyzer to proper value.
- d. Measure the time duration of one transmission on the measured frequency. And then plot the result with time difference of this time duration.
- e. Repeat above procedures until all different time-slot modes have been completed.

### 4.4.5 DEVIATION FROM TEST STANDARD

No deviation.

#### 4.4.6 TEST RESULTS

##### GFSK

Mode	Number of transmission in a 31.6 (79Hopping*0.4)	Length of transmission time (msec)	Result (msec)	Limit (msec)
DH1	52 (times / 5 sec) * 6.32 = 328.64 times	0.492	161.691	400
DH3	25 (times / 5 sec) * 6.32 = 158.00 times	1.74	274.920	400
DH5	16 (times / 5 sec) * 6.32 = 101.12 times	3.03	306.394	400

**NOTE:** Test plots of the transmitting time slot are shown on next 3 pages.



A D T

### DH1

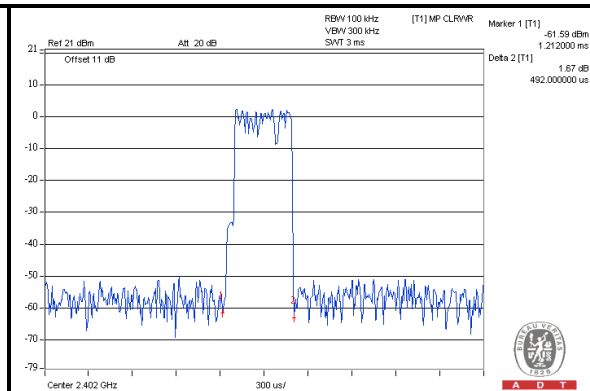
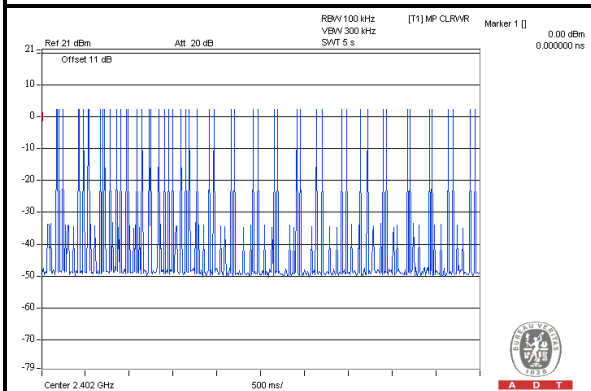

### DH3

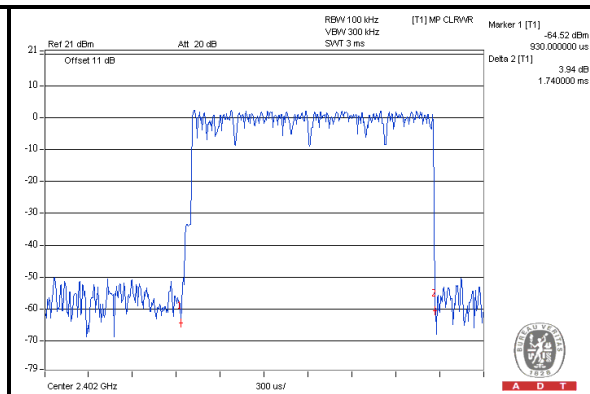
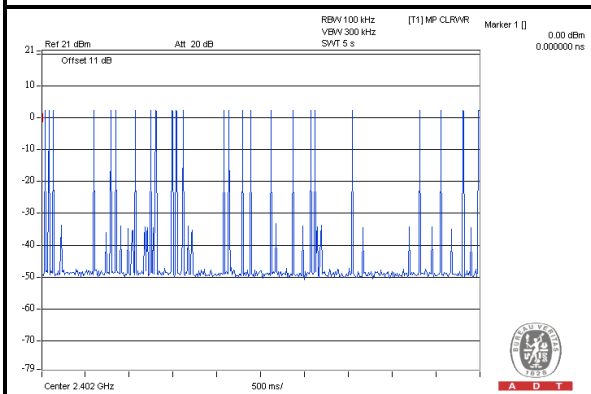

### DH5

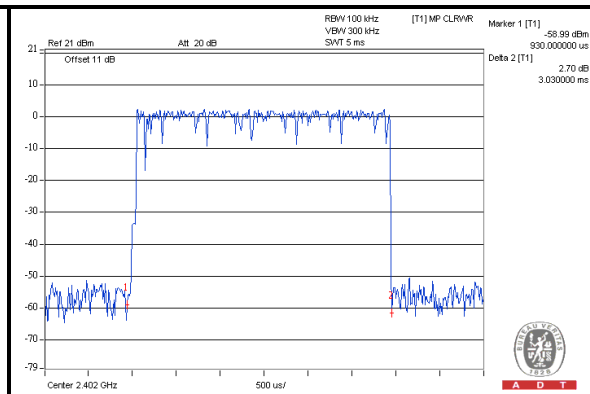
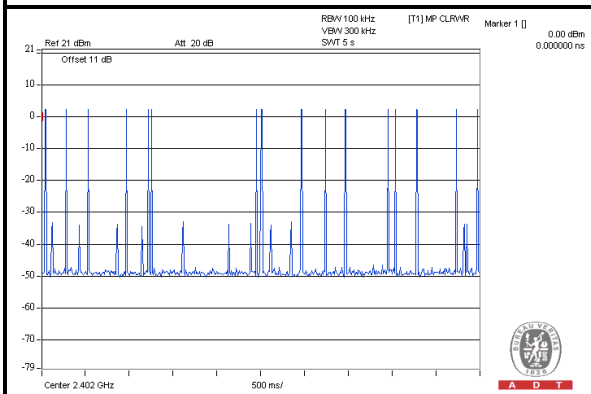



A D T

**$\pi/4$ -DQPSK**

Mode	Number of transmission in a 31.6 (79Hopping*0.4)	Length of transmission time (msec)	Result (msec)	Limit (msec)
DH1	51 (times / 5 sec) * 6.32 = 322.32 times	0.486	156.648	400
DH3	25 (times / 5 sec) * 6.32 = 158.00 times	1.758	277.764	400
DH5	18 (times / 5 sec) * 6.32 = 113.76 times	3.000	341.280	400

**NOTE:** Test plots of the transmitting time slot are shown on next 3 pages.





A D T

### DH1

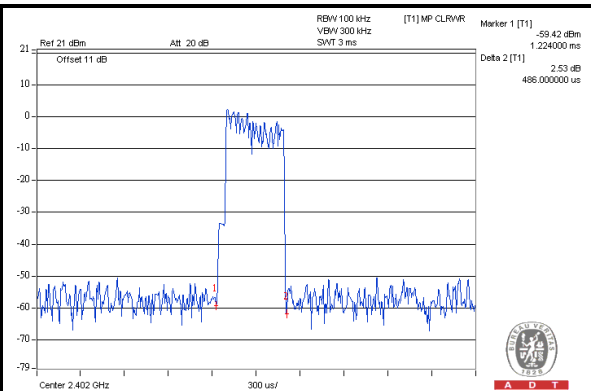
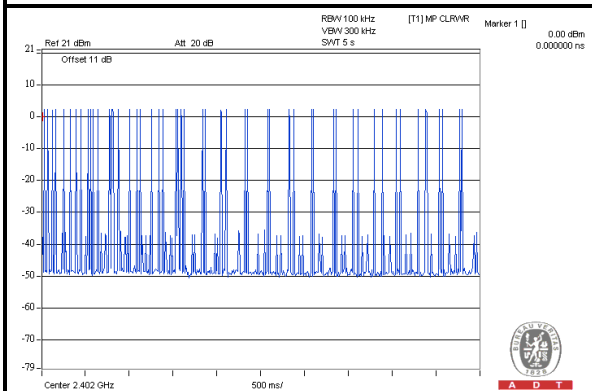

### DH3

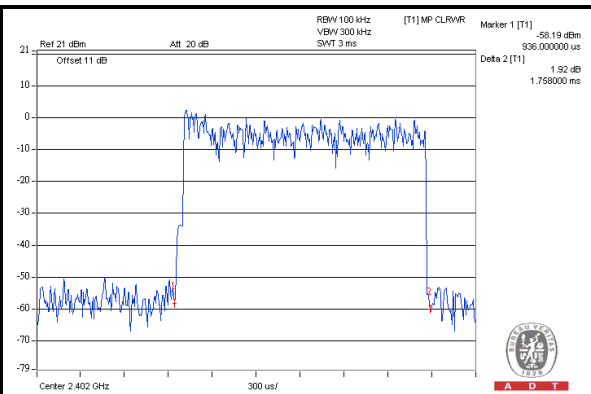
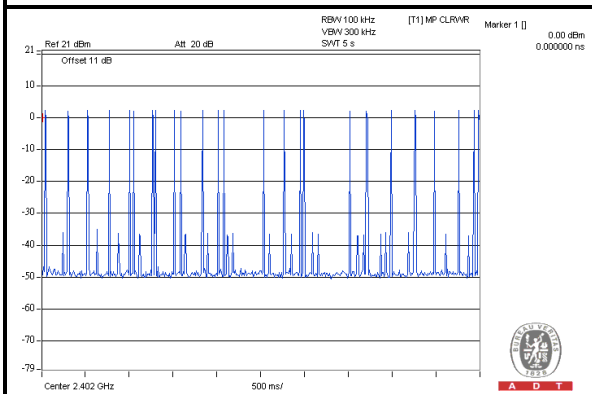

### DH5

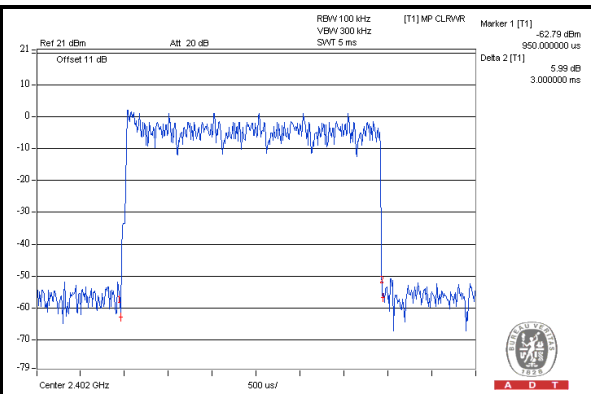
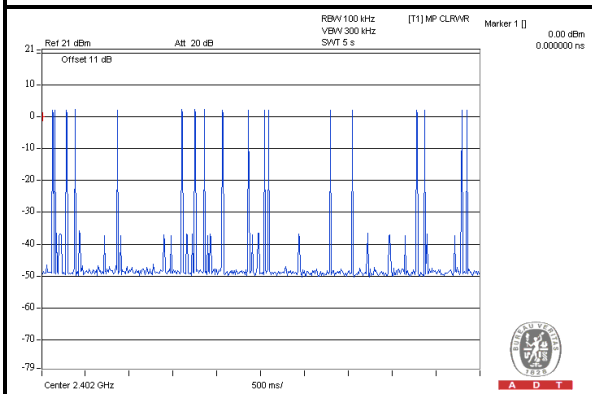



A D T

### 8DPSK

Mode	Number of transmission in a 31.6 (79Hopping*0.4)	Length of transmission time (msec)	Result (msec)	Limit (msec)
DH1	$52 \text{ (times / 5 sec)} * 6.32 = 328.64 \text{ times}$	0.468	153.804	400
DH3	$25 \text{ (times / 5 sec)} * 6.32 = 158.00 \text{ times}$	1.746	275.868	400
DH5	$17 \text{ (times / 5 sec)} * 6.32 = 107.44 \text{ times}$	3.03	325.543	400

**NOTE:** Test plots of the transmitting time slot are shown on next 3 pages.



A D T

### DH1

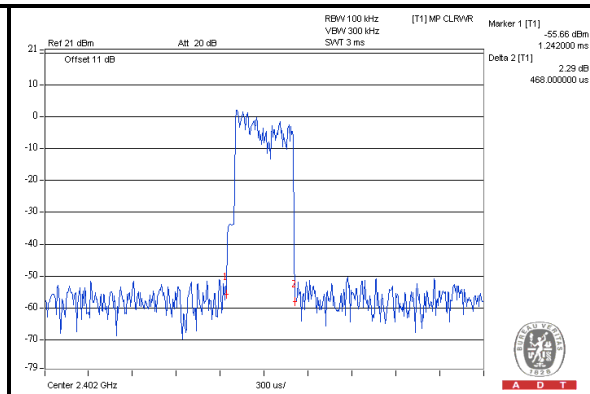
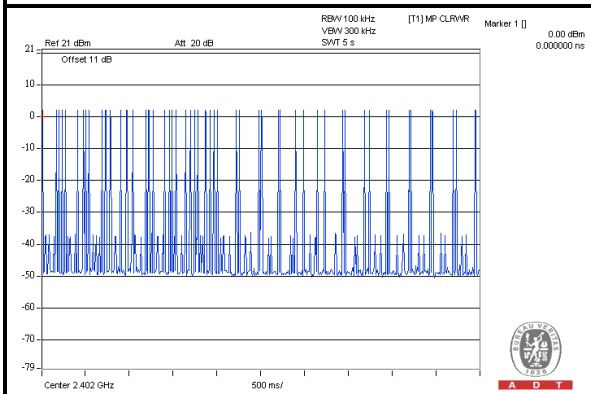

### DH3

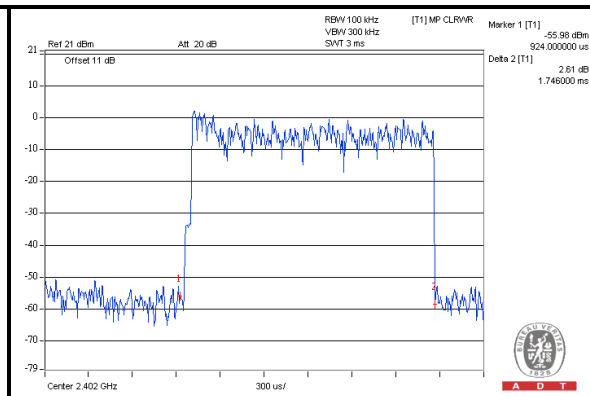
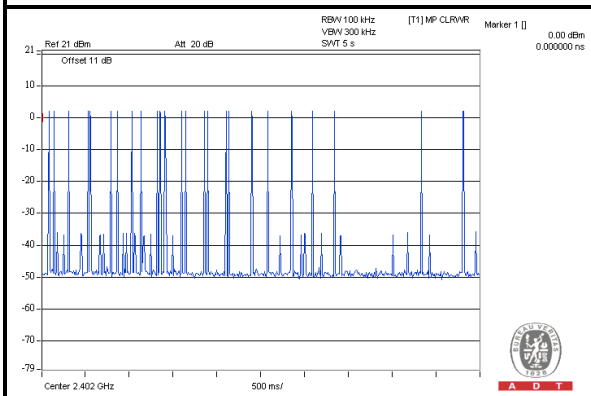

### DH5

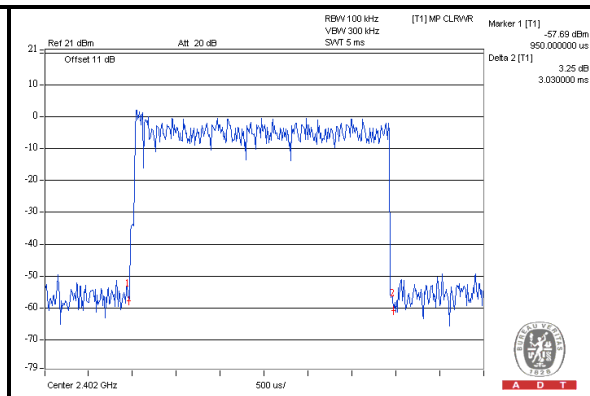
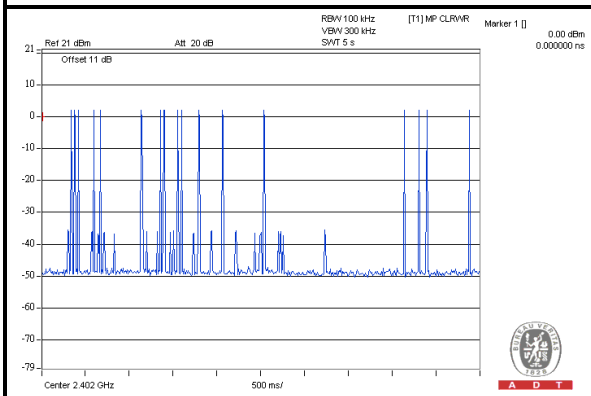

## 4.5 CHANNEL BANDWIDTH

### 4.5.1 LIMITS OF CHANNEL BANDWIDTH

For frequency hopping system operating in the 2400-2483.5MHz, If the 20dB bandwidth of hopping channel is greater than 25kHz, two-thirds 20dB bandwidth of hopping channel shall be a minimum limit for the hopping channel separation.

### 4.5.2 TEST SETUP

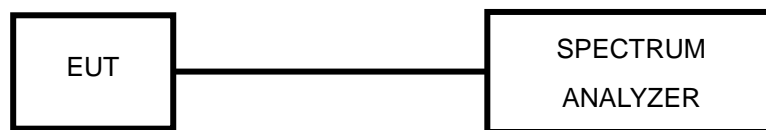

### 4.5.3 TEST INSTRUMENTS

Refer to section 4.1.2 to get information of above instrument.

### 4.5.4 TEST PROCEDURE

- a. Check the calibration of the measuring instrument using either an internal calibrator or a known signal from an external generator.
- b. Turn on the EUT and connect it to measurement instrument. Then set it to any one convenient frequency within its operating range. Set a reference level on the measuring instrument equal to the highest peak value.
- c. Measure the frequency difference of two frequencies that were attenuated 20dB from the reference level. Record the frequency difference as the emission bandwidth.
- d. Repeat above procedures until all frequencies measured were complete.

### 4.5.5 DEVIATION FROM TEST STANDARD

No deviation.

### 4.5.6 EUT OPERATING CONDITION

The software provided by client enabled the EUT to transmit and receive data at lowest, middle and highest channel frequencies individually.



A D T

### 4.5.7 TEST RESULTS

CHANNEL	FREQUENCY (MHz)	20dB BANDWIDTH (MHz)		
		GFSK	$\pi/4$ -DQPSK	8DPSK
0	2402	1.020	1.330	1.300
39	2441	1.020	1.340	1.300
78	2480	1.030	1.330	1.300

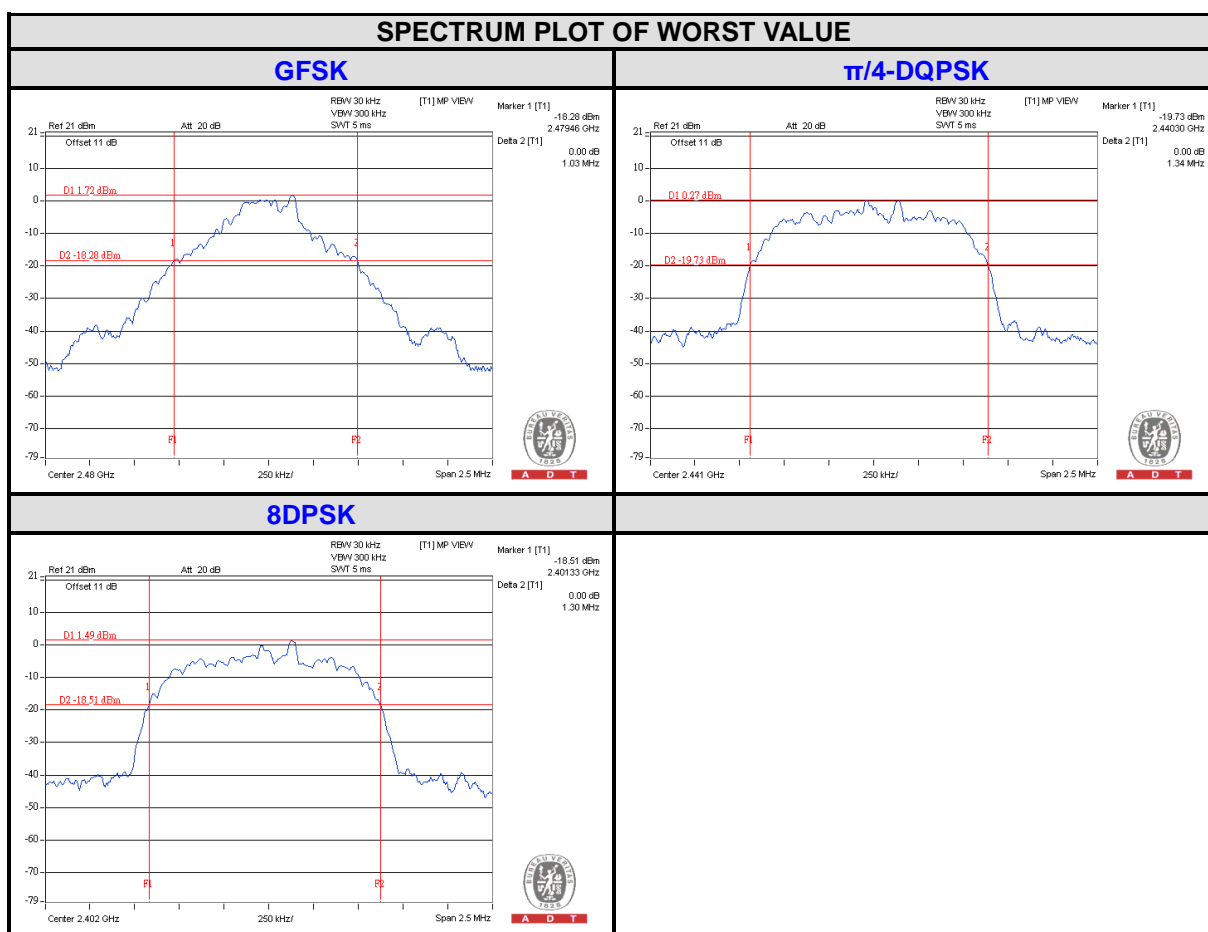

## 4.6 HOPPING CHANNEL SEPARATION

### 4.6.1 LIMIT OF HOPPING CHANNEL SEPARATION

At least 25kHz or two-third of 20dB hopping channel bandwidth (whichever is greater).

### 4.6.2 TEST SETUP

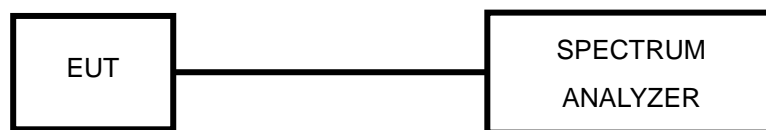

### 4.6.3 TEST INSTRUMENTS

Refer to section 4.1.2 to get information of above instrument.

### 4.6.4 TEST PROCEDURES

1. Check the calibration of the measuring instrument using either an internal calibrator or a known signal from an external generator.
2. Turn on the EUT and connect it to measurement instrument. Then set it to any one convenient frequency within its operating range.
3. By using the MaxHold function record the separation of two adjacent channels.
4. Measure the frequency difference of these two adjacent channels by SA MARK function. And then plot the result on SA screen.
5. Repeat above procedures until all frequencies measured were complete.

### 4.6.5 DEVIATION FROM TEST STANDARD

No deviation.

#### 4.6.6 TEST RESULTS

##### GFSK

CHANNEL	FREQUENCY (MHz)	ADJACENT CHANNEL SEPARATION (MHz)	20dB BANDWIDTH (MHz)	MINIMUM LIMIT (MHz)	PASS / FAIL
0	2402	1.010	1.020	0.680	PASS
39	2441	1.000	1.020	0.680	PASS
78	2480	1.000	1.030	0.687	PASS

##### $\pi/4$ -DQPSK

CHANNEL	FREQUENCY (MHz)	ADJACENT CHANNEL SEPARATION (MHz)	20dB BANDWIDTH (MHz)	MINIMUM LIMIT (MHz)	PASS / FAIL
0	2402	1.000	1.330	0.887	PASS
39	2441	1.000	1.340	0.893	PASS
78	2480	1.000	1.330	0.887	PASS

##### 8DPSK

CHANNEL	FREQUENCY (MHz)	ADJACENT CHANNEL SEPARATION (MHz)	20dB BANDWIDTH (MHz)	MINIMUM LIMIT (MHz)	PASS / FAIL
0	2402	1.010	1.300	0.867	PASS
39	2441	1.000	1.300	0.867	PASS
78	2480	1.010	1.300	0.867	PASS

**NOTE:** The minimum limit is two-third 20dB bandwidth.



A D T

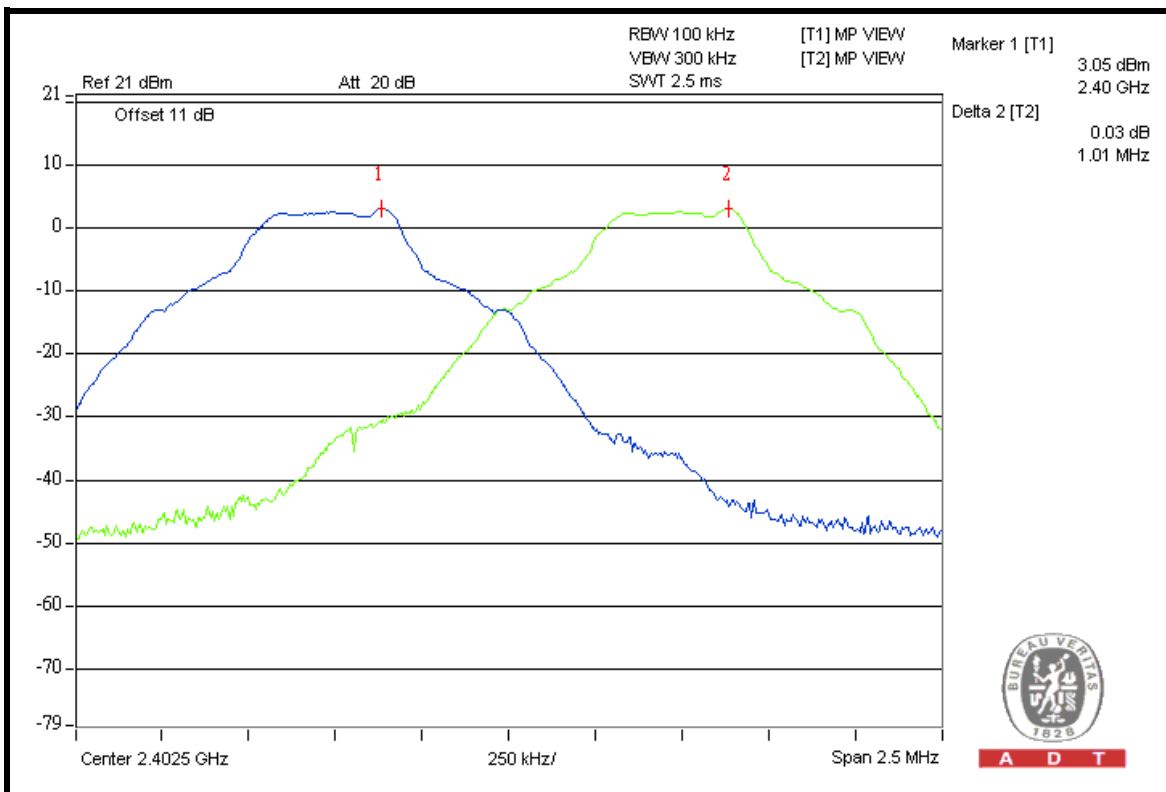



## 4.7 MAXIMUM OUTPUT POWER

### 4.7.1 LIMITS OF MAXIMUM OUTPUT POWER MEASUREMENT

The Maximum Output Power Measurement is 125mW.

### 4.7.2 TEST SETUP

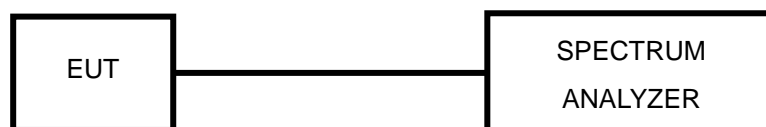

### 4.7.3 TEST INSTRUMENTS

Refer to section 4.1.2 to get information of above instrument.

### 4.7.4 TEST PROCEDURES

- a. Check the calibration of the measuring instrument using either an internal calibrator or a known signal from an external generator.
- b. Turn on the EUT and connect it to measurement instrument. Then set it to any one convenient frequency within its operating range. Set a reference level on the measuring instrument equal to the highest peak value.
- c. The center frequency of the spectrum analyzer is set to the fundamental frequency and using 3MHz RBW and 10 MHz VBW.
- d. Measure the captured power within the band and recording the plot.
- e. Repeat above procedures until all frequencies required were complete.

### 4.7.5 DEVIATION FROM TEST STANDARD

No deviation.

### 4.7.6 EUT OPERATING CONDITION

The software provided by client enabled the EUT to transmit and receive data at lowest, middle and highest channel frequencies individually.



### 4.7.7 TEST RESULTS

#### GFSK

CHANNEL	CHANNEL FREQUENCY (MHz)	OUTPUT POWER (mW)	OUTPUT POWER (dBm)	POWER LIMIT (mW)	PASS/FAIL
0	2402	2.065	3.15	125	PASS
39	2441	2.213	3.45	125	PASS
78	2480	2.153	3.33	125	PASS

#### $\pi/4$ -DQPSK

CHANNEL	CHANNEL FREQUENCY (MHz)	OUTPUT POWER (mW)	OUTPUT POWER (dBm)	POWER LIMIT (mW)	PASS/FAIL
0	2402	3.750	5.74	125	PASS
39	2441	4.027	6.05	125	PASS
78	2480	3.855	5.86	125	PASS

#### 8DPSK

CHANNEL	CHANNEL FREQUENCY (MHz)	OUTPUT POWER (mW)	OUTPUT POWER (dBm)	POWER LIMIT (mW)	PASS/FAIL
0	2402	4.140	6.17	125	PASS
39	2441	4.285	6.32	125	PASS
78	2480	4.169	6.20	125	PASS



A D T

8DPSK  
CH 39

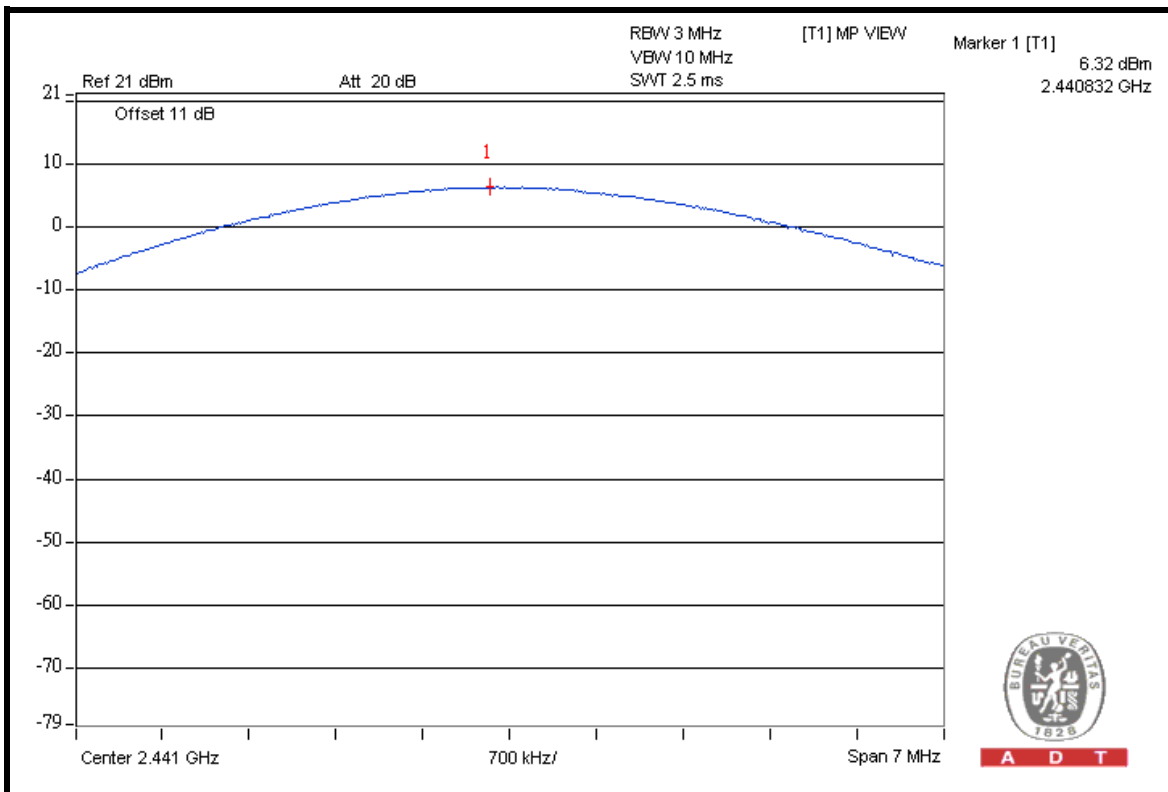

## 4.8 CONDUCTED OUT OF BAND EMISSION MEASUREMENT

### 4.8.1 LIMITS OF CONDUCTED OUT OF BAND EMISSION MEASUREMENT

Below  $-20\text{dB}$  of the highest emission level of operating band (in  $100\text{kHz}$  RBW).

### 4.8.2 TEST INSTRUMENTS

Refer to section 4.1.2 to get information of above instrument.

### 4.8.3 TEST PROCEDURE

1. Set RBW =  $100\text{ kHz}$ .
2. Set VBW =  $300\text{ kHz}$ .
3. Set span to encompass the spectrum to be examined
4. Detector = peak.
5. Trace Mode = max hold.
6. Sweep = auto couple.

### 4.8.4 DEVIATION FROM TEST STANDARD

No deviation.

### 4.8.5 EUT OPERATING CONDITION

The software provided by client enabled the EUT to transmit continuously.

### 4.8.6 TEST RESULTS

The spectrum plots are attached on the following images. D1 line indicates the highest level, D2 line indicates the  $20\text{dB}$  offset below D1. It shows compliance with the requirement.



A D T

### GFSK

#### Hopping disabled\_ Low Channel

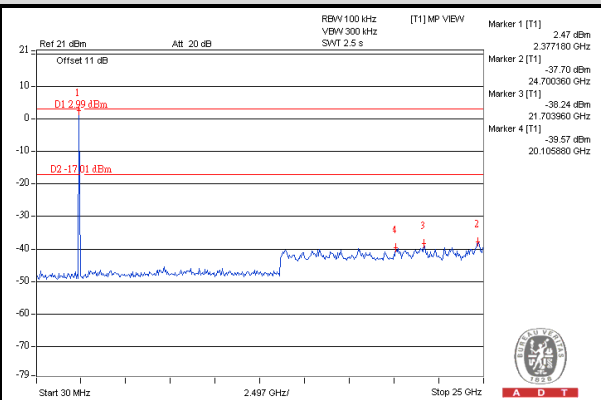
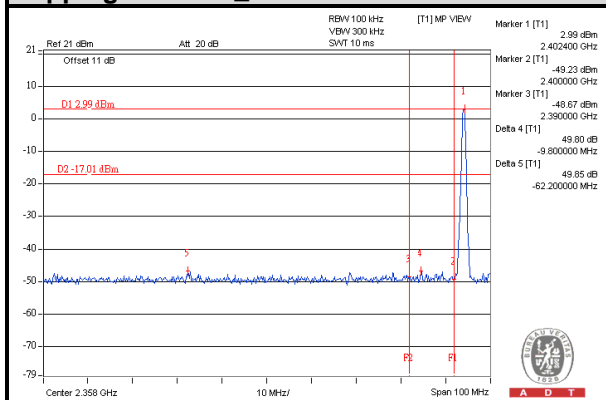

#### Hopping disabled\_ High Channel

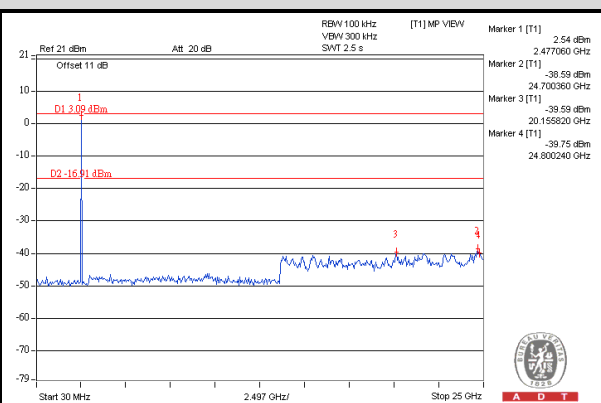
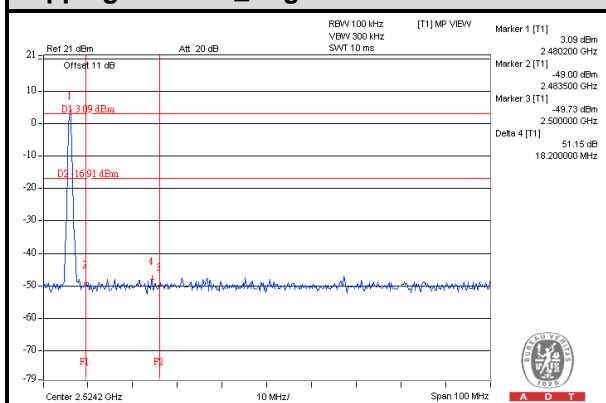

#### Hopping enabled\_ Low Channel

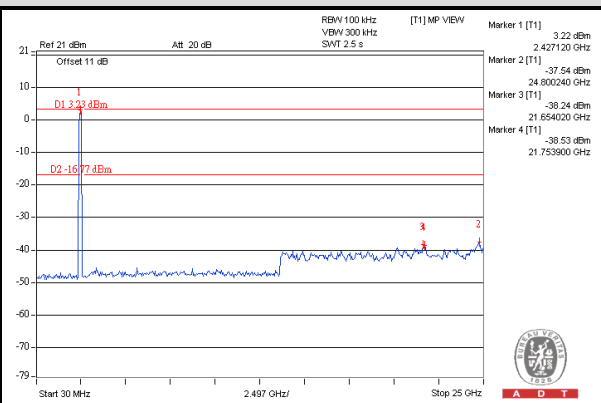
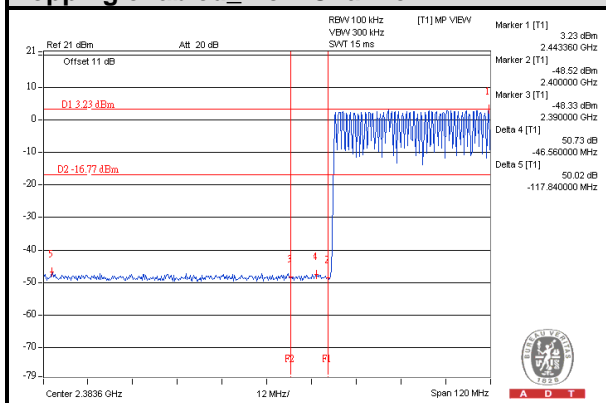

#### Hopping enabled\_ High Channel

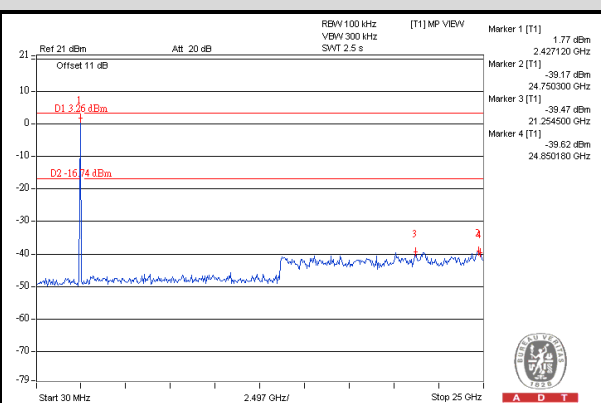
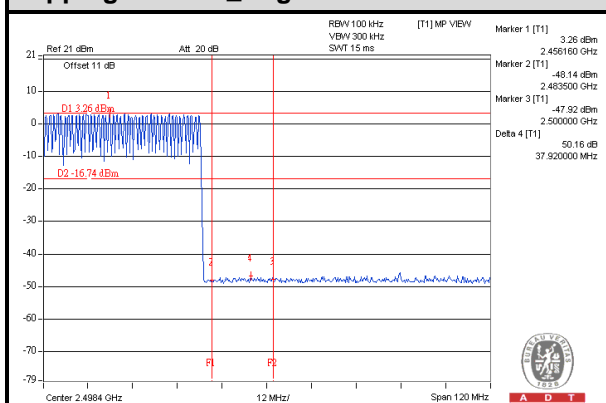



A D T

### $\pi/4$ -DQPSK

#### Hopping disabled\_Low Channel

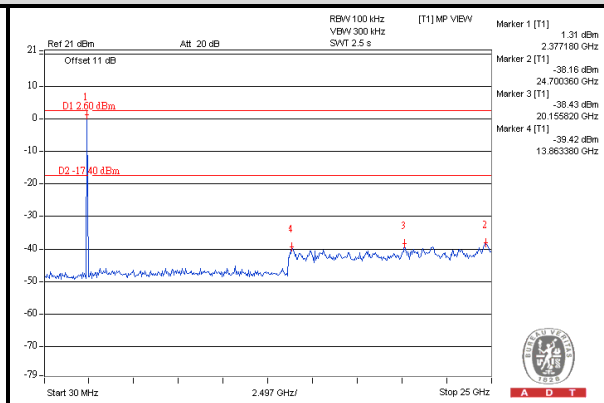
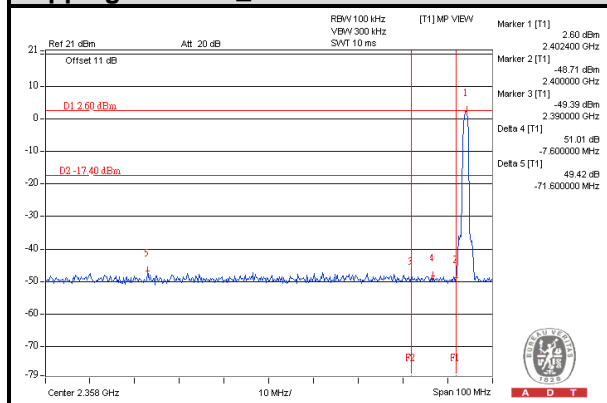

#### Hopping disabled\_High Channel

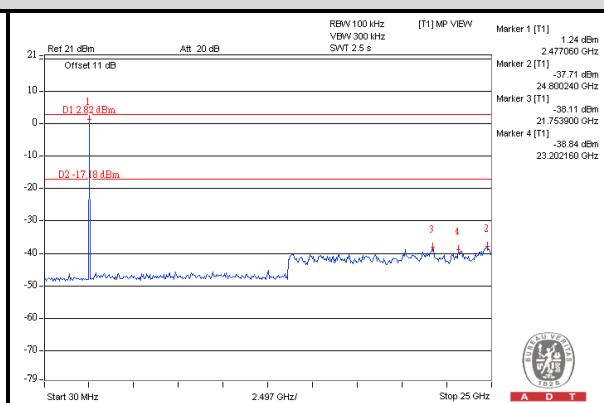
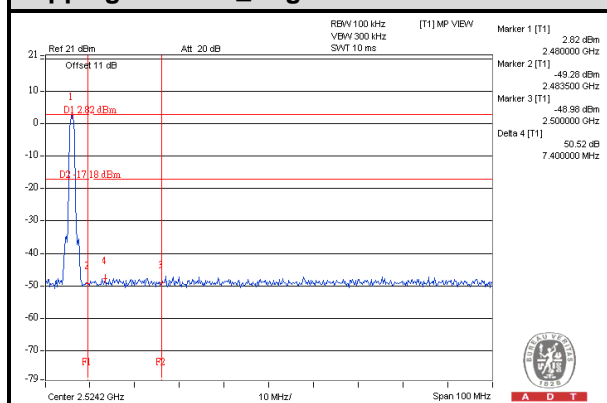

#### Hopping enabled\_Low Channel

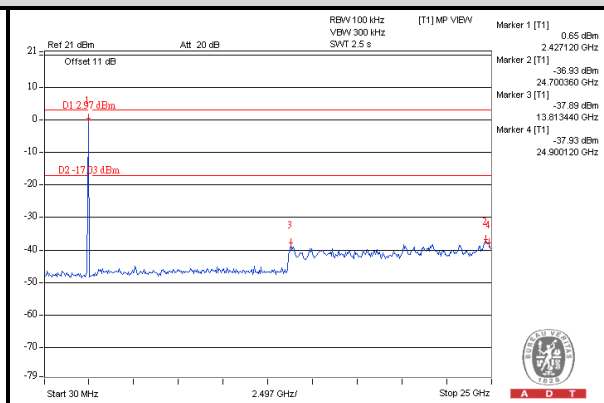
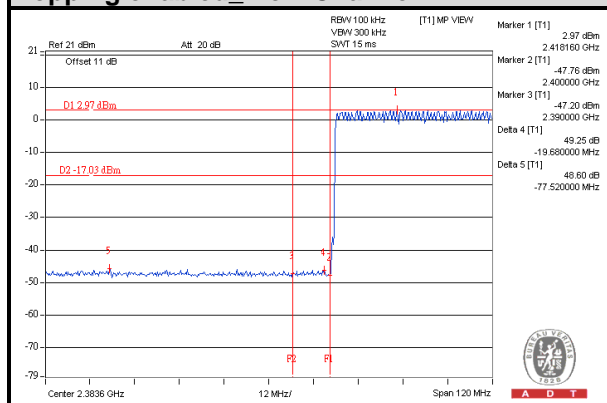

#### Hopping enabled\_High Channel

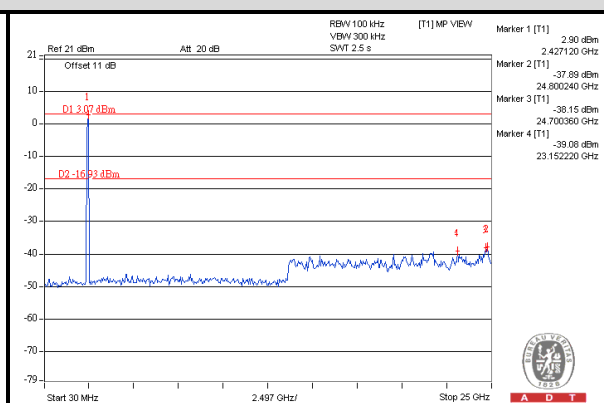
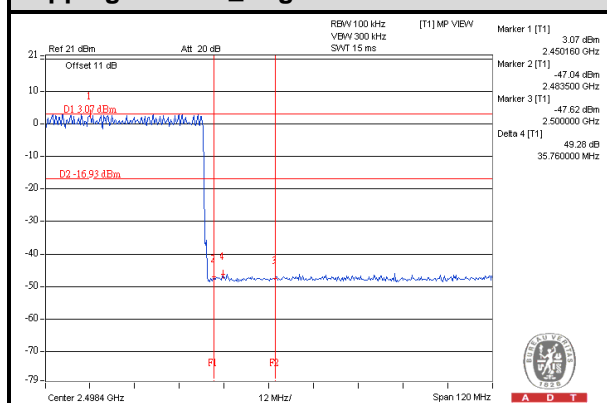



A D T

### 8DPSK

#### Hopping disabled\_Low Channel

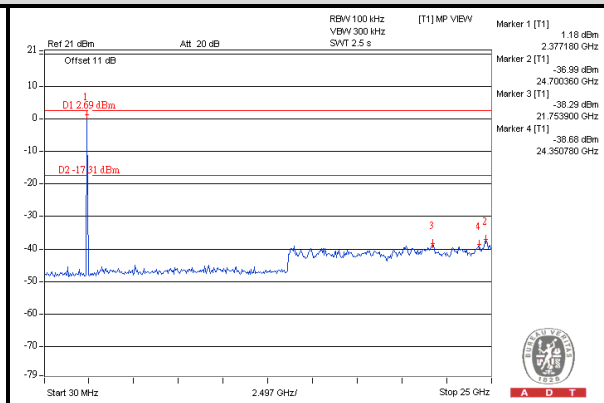
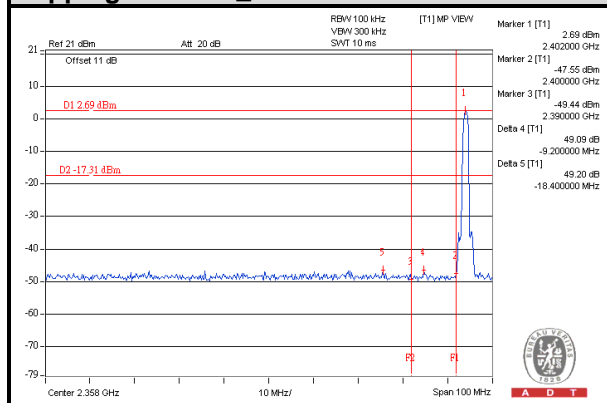

#### Hopping disabled\_High Channel

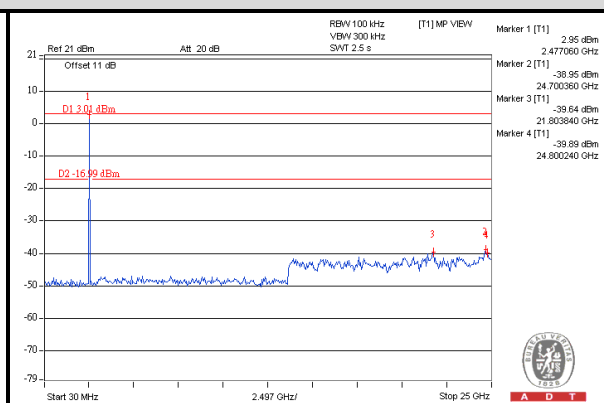
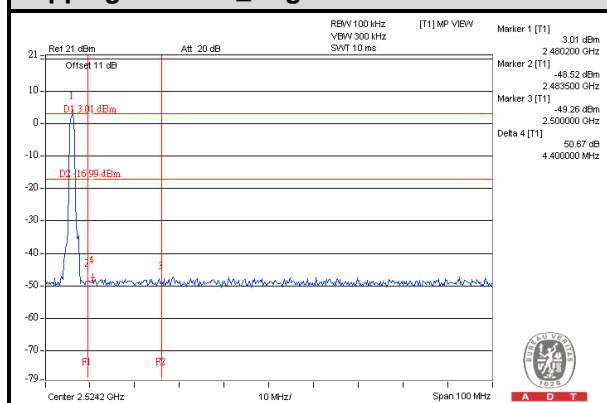

#### Hopping enabled\_Low Channel

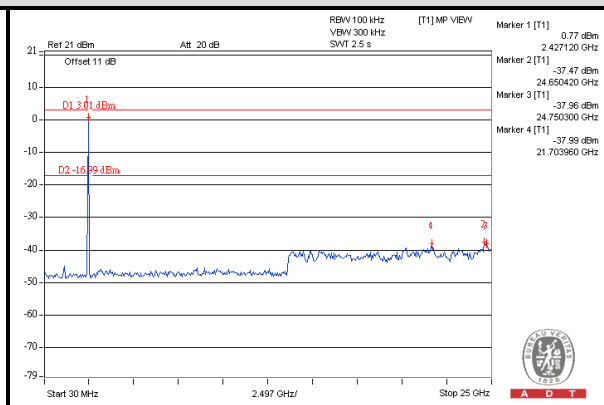
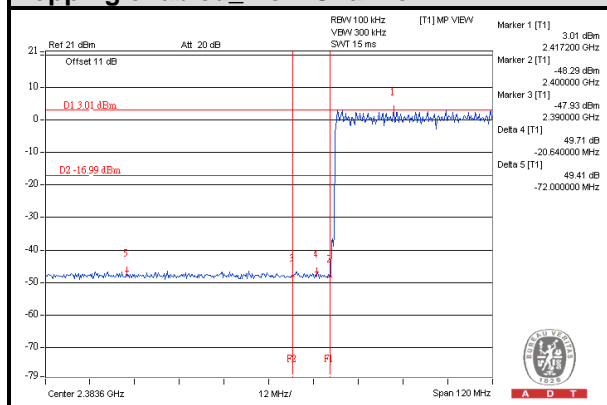

#### Hopping enabled\_High Channel

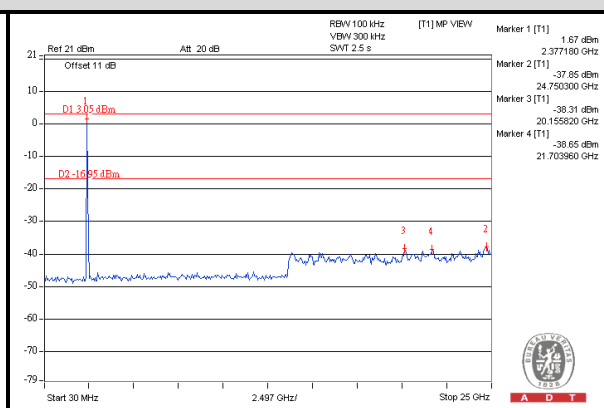
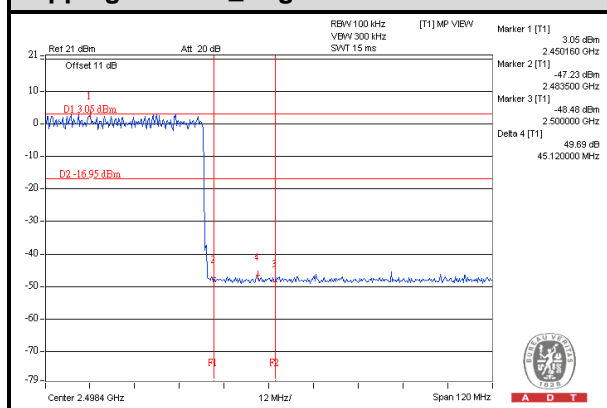

## **5. TEST TYPES AND RESULTS (FOR Bluetooth LE 4.0)**

### **5.1 RADIATED EMISSION AND BANDEDGE MEASUREMENT**

#### **5.1.1 LIMITS OF RADIATED EMISSION AND BANDEDGE MEASUREMENT**

Same as 4.1.1.

#### **5.1.2 TEST INSTRUMENTS**

Same as 4.1.2.

#### **5.1.3 TEST PROCEDURES**

Same as 4.1.3.

#### **5.1.4 DEVIATION FROM TEST STANDARD**

No deviation.

#### **5.1.5 TEST SETUP**

Same as 4.1.5.

#### **5.1.6 EUT OPERATING CONDITIONS**

Same as 4.1.6.



## 5.1.7 TEST RESULTS

### ABOVE 1GHz DATA

EUT TEST CONDITION		MEASUREMENT DETAIL	
CHANNEL	Channel 0	FREQUENCY RANGE	1 ~ 25GHz
INPUT POWER (SYSTEM)	120Vac, 60 Hz	DETECTOR FUNCTION	Peak (PK) Average (AV)
ENVIRONMENTAL CONDITIONS	25deg. C, 65%RH	TESTED BY	Anderson Hong

ANTENNA POLARITY & TEST DISTANCE: HORIZONTAL AT 3 M								
NO.	FREQ. (MHz)	EMISSION LEVEL (dBuV/m)	LIMIT (dBuV/m)	MARGIN (dB)	ANTENNA HEIGHT (m)	TABLE ANGLE (Degree)	RAW VALUE (dBuV)	CORRECTION FACTOR (dB/m)
1	2382.00	40.7 PK	74.0	-33.3	1.29 H	91	9.32	31.34
2	2382.00	30.5 AV	54.0	-23.5	1.29 H	91	-0.88	31.34
3	2398.00	38.6 PK	74.1	-35.5	1.27 H	96	7.23	31.39
4	2398.00	28.8 AV	72.8	-44.0	1.27 H	96	-2.57	31.39
5	<b>2400.00</b>	<b>58.7 PK</b>	<b>74.1</b>	<b>-15.4</b>	<b>1.27 H</b>	<b>96</b>	<b>27.33</b>	<b>31.40</b>
6	2400.00	53.7 AV	72.8	-19.1	1.27 H	96	22.33	31.40
7	*2402.00	94.1 PK			1.29 H	96	62.70	31.41
8	*2402.00	92.8 AV			1.29 H	96	61.40	31.41
9	4804.00	45.1 PK	74.0	-28.9	1.00 H	80	7.66	37.42
10	4804.00	32.6 AV	54.0	-21.4	1.00 H	80	-4.84	37.42

#### REMARKS:

1. Emission level (dBuV/m) = Raw Value (dBuV) + Correction Factor (dB/m).
2. Correction Factor (dB/m) = Antenna Factor (dB/m) + Cable Factor (dB).
3. The other emission levels were very low against the limit.
4. Margin value = Emission level – Limit value.
5. “ \* “: Fundamental frequency.



A D T

EUT TEST CONDITION		MEASUREMENT DETAIL	
CHANNEL	Channel 0	FREQUENCY RANGE	1 ~ 25GHz
INPUT POWER (SYSTEM)	120Vac, 60 Hz	DETECTOR FUNCTION	Peak (PK) Average (AV)
ENVIRONMENTAL CONDITIONS	25deg. C, 65%RH	TESTED BY	Anderson Hong

ANTENNA POLARITY & TEST DISTANCE: VERTICAL AT 3 M								
NO.	FREQ. (MHz)	EMISSION LEVEL (dBuV/m)	LIMIT (dBuV/m)	MARGIN (dB)	ANTENNA HEIGHT (m)	TABLE ANGLE (Degree)	RAW VALUE (dBuV)	CORRECTION FACTOR (dB/m)
1	2382.00	40.8 PK	74.0	-33.2	1.70 V	203	9.42	31.34
2	2382.00	30.7 AV	54.0	-23.3	1.70 V	203	-0.68	31.34
3	2398.00	39.6 PK	73.2	-33.6	1.72 V	199	8.23	31.39
4	2398.00	28.5 AV	71.8	-43.3	1.72 V	199	-2.87	31.39
5	2400.00	57.7 PK	73.2	-15.5	1.72 V	199	26.33	31.40
6	2400.00	52.9 AV	71.8	-18.9	1.72 V	199	21.53	31.40
7	*2402.00	93.2 PK			1.72 V	199	61.80	31.41
8	*2402.00	91.8 AV			1.72 V	199	60.40	31.41
9	4804.00	45.4 PK	74.0	-28.6	1.13 V	321	7.96	37.42
10	4804.00	32.9 AV	54.0	-21.1	1.13 V	321	-4.54	37.42

**REMARKS:**

1. Emission level (dBuV/m) = Raw Value (dBuV) + Correction Factor (dB/m).
2. Correction Factor (dB/m) = Antenna Factor (dB/m) + Cable Factor (dB).
3. The other emission levels were very low against the limit.
4. Margin value = Emission level – Limit value.
5. “ \* “: Fundamental frequency.



A D T

EUT TEST CONDITION		MEASUREMENT DETAIL	
CHANNEL	Channel 19	FREQUENCY RANGE	1 ~ 25GHz
INPUT POWER (SYSTEM)	120Vac, 60 Hz	DETECTOR FUNCTION	Peak (PK) Average (AV)
ENVIRONMENTAL CONDITIONS	25deg. C, 65%RH	TESTED BY	Anderson Hong

ANTENNA POLARITY & TEST DISTANCE: HORIZONTAL AT 3 M								
NO.	FREQ. (MHz)	EMISSION LEVEL (dBuV/m)	LIMIT (dBuV/m)	MARGIN (dB)	ANTENNA HEIGHT (m)	TABLE ANGLE (Degree)	RAW VALUE (dBuV)	CORRECTION FACTOR (dB/m)
1	*2440.00	96.3 PK			1.24 H	88	64.70	31.55
2	*2440.00	94.9 AV			1.24 H	88	63.30	31.55
3	4880.00	44.7 PK	74.0	-29.3	1.05 H	93	7.17	37.56
4	4880.00	32.1 AV	54.0	-21.9	1.05 H	93	-5.43	37.56
5	7320.00	51.0 PK	74.0	-23.0	1.32 H	251	7.25	43.76
6	7320.00	38.6 AV	54.0	-15.4	1.32 H	251	-5.15	43.76
ANTENNA POLARITY & TEST DISTANCE: VERTICAL AT 3 M								
NO.	FREQ. (MHz)	EMISSION LEVEL (dBuV/m)	LIMIT (dBuV/m)	MARGIN (dB)	ANTENNA HEIGHT (m)	TABLE ANGLE (Degree)	RAW VALUE (dBuV)	CORRECTION FACTOR (dB/m)
1	*2440.00	92.8 PK			1.75 V	195	61.20	31.55
2	*2440.00	91.4 AV			1.75 V	195	59.80	31.55
3	4880.00	45.1 PK	74.0	-29.0	1.15 V	325	7.49	37.56
4	4880.00	32.5 AV	54.0	-21.5	1.15 V	325	-5.05	37.56
5	7320.00	51.2 PK	74.0	-22.8	1.20 V	231	7.45	43.76
6	7320.00	38.5 AV	54.0	-15.5	1.20 V	231	-5.25	43.76

**REMARKS:**

1. Emission level (dBuV/m) = Raw Value (dBuV) + Correction Factor (dB/m).
2. Correction Factor (dB/m) = Antenna Factor (dB/m) + Cable Factor (dB).
3. The other emission levels were very low against the limit.
4. Margin value = Emission level – Limit value.
5. “ \* “: Fundamental frequency.



A D T

EUT TEST CONDITION		MEASUREMENT DETAIL	
CHANNEL	Channel 39	FREQUENCY RANGE	1 ~ 25GHz
INPUT POWER (SYSTEM)	120Vac, 60 Hz	DETECTOR FUNCTION	Peak (PK) Average (AV)
ENVIRONMENTAL CONDITIONS	25deg. C, 65%RH	TESTED BY	Anderson Hong

ANTENNA POLARITY & TEST DISTANCE: HORIZONTAL AT 3 M								
NO.	FREQ. (MHz)	EMISSION LEVEL (dBuV/m)	LIMIT (dBuV/m)	MARGIN (dB)	ANTENNA HEIGHT (m)	TABLE ANGLE (Degree)	RAW VALUE (dBuV)	CORRECTION FACTOR (dB/m)
1	*2480.00	97.3 PK			1.20 H	90	65.60	31.70
2	*2480.00	95.9 AV			1.20 H	90	64.20	31.70
3	2483.50	43.8 PK	74.0	-30.2	1.20 H	90	12.12	31.72
4	2483.50	37.6 AV	54.0	-16.4	1.20 H	90	5.92	31.72
5	2500.00	41.9 PK	74.0	-32.1	1.23 H	87	10.12	31.78
6	2500.00	32.9 AV	54.0	-21.1	1.23 H	87	1.12	31.78
7	4960.00	45.8 PK	74.0	-28.2	1.08 H	90	8.03	37.77
8	4960.00	33.3 AV	54.0	-20.7	1.08 H	90	-4.47	37.77
ANTENNA POLARITY & TEST DISTANCE: VERTICAL AT 3 M								
NO.	FREQ. (MHz)	EMISSION LEVEL (dBuV/m)	LIMIT (dBuV/m)	MARGIN (dB)	ANTENNA HEIGHT (m)	TABLE ANGLE (Degree)	RAW VALUE (dBuV)	CORRECTION FACTOR (dB/m)
1	*2480.00	91.3 PK			1.69 V	204	59.60	31.70
2	*2480.00	89.8 AV			1.69 V	204	58.10	31.70
3	2483.50	40.7 PK	74.0	-33.3	1.69 V	204	9.02	31.72
4	2483.50	32.4 AV	54.0	-21.6	1.69 V	204	0.72	31.72
5	2500.00	41.0 PK	74.0	-33.0	1.65 V	200	9.22	31.78
6	2500.00	27.9 AV	54.0	-26.1	1.65 V	200	-3.88	31.78
7	4960.00	46.1 PK	74.0	-27.9	1.18 V	321	8.33	37.77
8	4960.00	33.4 AV	54.0	-20.6	1.18 V	321	-4.37	37.77

**REMARKS:**

1. Emission level (dBuV/m) = Raw Value (dBuV) + Correction Factor (dB/m).
2. Correction Factor (dB/m) = Antenna Factor (dB/m) + Cable Factor (dB).
3. The other emission levels were very low against the limit.
4. Margin value = Emission level – Limit value.
5. “ \* “: Fundamental frequency.

**BELOW 1GHz WORST-CASE DATA**

EUT TEST CONDITION		MEASUREMENT DETAIL	
<b>CHANNEL</b>	Channel 19	<b>FREQUENCY RANGE</b>	Below 1000MHz
<b>INPUT POWER (SYSTEM)</b>	120Vac, 60 Hz	<b>DETECTOR FUNCTION</b>	Quasi-Peak
<b>ENVIRONMENTAL CONDITIONS</b>	25deg. C, 65%RH	<b>TESTED BY</b>	Anderson Hong

ANTENNA POLARITY & TEST DISTANCE: HORIZONTAL AT 3 M								
NO.	FREQ. (MHz)	EMISSION LEVEL (dBuV/m)	LIMIT (dBuV/m)	MARGIN (dB)	ANTENNA HEIGHT (m)	TABLE ANGLE (Degree)	RAW VALUE (dBuV)	CORRECTION FACTOR (dB/m)
1	189.08	20.9 QP	43.5	-22.6	1.50 H	343	8.89	12.04
2	262.80	22.1 QP	46.0	-23.9	1.50 H	13	8.63	13.50
3	332.64	23.4 QP	46.0	-22.6	1.25 H	93	7.67	15.74
4	390.84	27.1 QP	46.0	-19.0	1.00 H	168	9.81	17.24
5	515.00	24.5 QP	46.0	-21.5	2.00 H	15	4.07	20.46
6	544.10	26.9 QP	46.0	-19.1	2.00 H	17	5.72	21.15
ANTENNA POLARITY & TEST DISTANCE: VERTICAL AT 3 M								
NO.	FREQ. (MHz)	EMISSION LEVEL (dBuV/m)	LIMIT (dBuV/m)	MARGIN (dB)	ANTENNA HEIGHT (m)	TABLE ANGLE (Degree)	RAW VALUE (dBuV)	CORRECTION FACTOR (dB/m)
1	35.82	24.4 QP	40.0	-15.6	1.00 V	103	11.86	12.50
2	107.60	22.4 QP	43.5	-21.1	1.00 V	205	12.03	10.37
3	189.08	29.8 QP	43.5	-13.7	1.00 V	222	17.75	12.04
4	295.78	23.7 QP	46.0	-22.3	1.00 V	147	8.92	14.75
5	330.70	27.2 QP	46.0	-18.8	1.50 V	323	11.52	15.69
6	499.48	22.9 QP	46.0	-23.1	1.25 V	112	2.85	20.09

**REMARKS:**

1. Emission level (dBuV/m) = Raw Value (dBuV) + Correction Factor (dB/m).
2. Correction Factor (dB/m) = Antenna Factor (dB/m) + Cable Factor (dB).
3. The other emission levels were very low against the limit.
4. Margin value = Emission level – Limit value.

## **5.2 CONDUCTED EMISSION MEASUREMENT**

### **5.2.1 LIMITS OF CONDUCTED EMISSION MEASUREMENT**

Same as 4.2.1.

### **5.2.2 TEST INSTRUMENTS**

Same as 4.2.2.

### **5.2.3 TEST PROCEDURES**

Same as 4.2.3.

### **5.2.4 DEVIATION FROM TEST STANDARD**

No deviation.

### **5.2.5 TEST SETUP**

Same as 4.2.5.

### **5.2.6 EUT OPERATING CONDITIONS**

Same as 4.2.6.

## 5.2.7 TEST RESULTS

### CONDUCTED WORST CASE DATA:

PHASE	Line 1	6dB BANDWIDTH	9kHz
-------	--------	---------------	------

No	Freq. [MHz]	Corr. Factor (dB)	Reading Value [dB (uV)]		Emission Level [dB (uV)]		Limit [dB (uV)]		Margin (dB)	
			Q.P.	AV.	Q.P.	AV.	Q.P.	AV.	Q.P.	AV.
			1	0.15638	0.17	19.87	5.88	20.04	6.05	65.65
<b>2</b>	<b>0.37368</b>	<b>0.20</b>	<b>32.13</b>	<b>25.96</b>	<b>32.33</b>	<b>26.16</b>	<b>58.42</b>	<b>48.42</b>	<b>-26.09</b>	<b>-22.26</b>
3	1.98645	0.30	29.21	21.37	29.51	21.67	56.00	46.00	-26.49	-24.33
4	4.41342	0.40	22.17	12.16	22.57	12.56	56.00	46.00	-33.43	-33.44
5	6.78679	0.43	19.32	10.52	19.75	10.95	60.00	50.00	-40.25	-39.05
6	16.42437	0.64	26.98	21.28	27.62	21.92	60.00	50.00	-32.38	-28.08

### REMARKS:

1. Q.P. and AV. are abbreviations of quasi-peak and average individually.
2. The emission levels of other frequencies were very low against the limit.
3. Margin value = Emission level - Limit value
4. Correction factor = Insertion loss + Cable loss
5. Emission Level = Correction Factor + Reading Value.

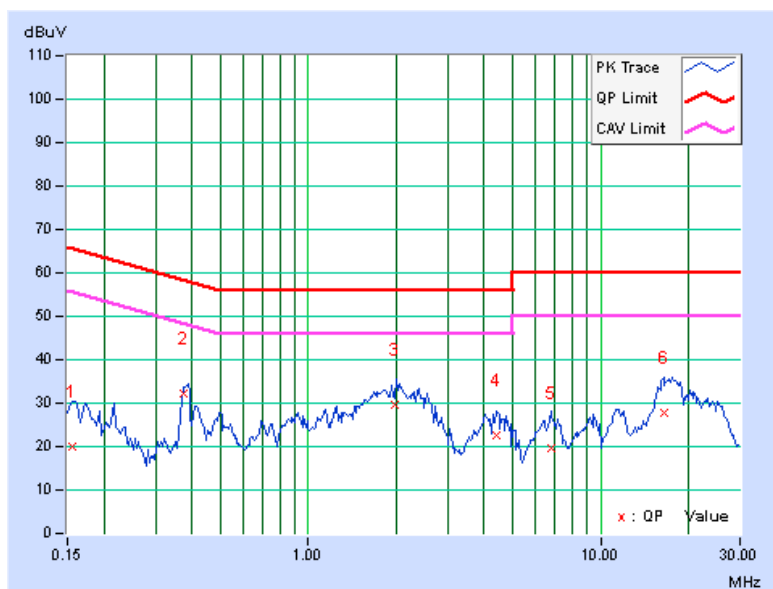



A D T

PHASE	Line 1	6dB BANDWIDTH	9kHz
-------	--------	---------------	------

No	Freq. [MHz]	Corr. Factor (dB)	Reading Value [dB (uV)]		Emission Level [dB (uV)]		Limit [dB (uV)]		Margin (dB)	
			Q.P.	AV.	Q.P.	AV.	Q.P.	AV.	Q.P.	AV.
			1	0.15314	0.17	26.41	22.14	26.58	22.31	65.83
2	0.37942	0.18	32.34	25.28	32.52	25.46	58.29	48.29	-25.78	-22.84
3	1.75394	0.25	27.93	22.98	28.18	23.23	56.00	46.00	-27.82	-22.77
4	4.31247	0.39	21.38	15.76	21.77	16.15	56.00	46.00	-34.23	-29.85
5	7.16336	0.48	21.95	11.18	22.43	11.66	60.00	50.00	-37.57	-38.34
6	16.25671	0.73	27.83	20.83	28.56	21.56	60.00	50.00	-31.44	-28.44

**REMARKS:**

1. Q.P. and AV. are abbreviations of quasi-peak and average individually.
2. The emission levels of other frequencies were very low against the limit.
3. Margin value = Emission level - Limit value
4. Correction factor = Insertion loss + Cable loss
5. Emission Level = Correction Factor + Reading Value.

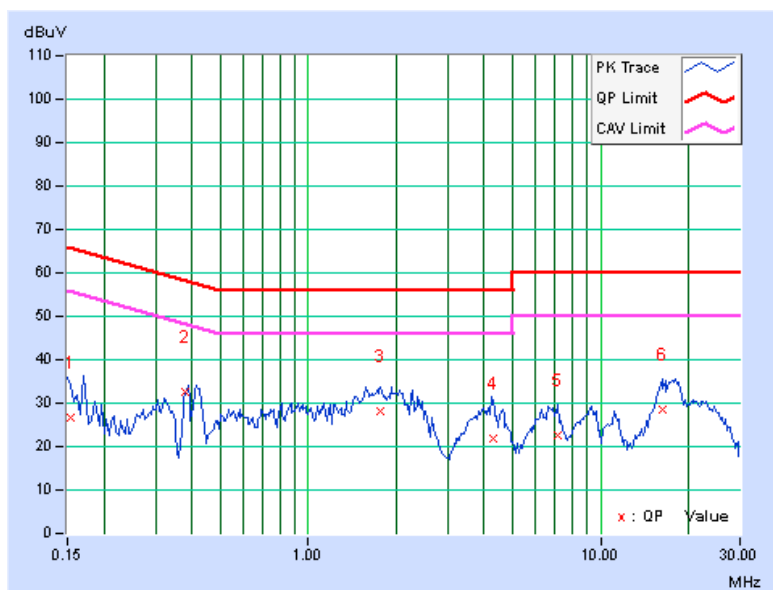



## 5.3 6dB BANDWIDTH MEASUREMENT

### 5.3.1 LIMITS OF 6dB BANDWIDTH MEASUREMENT

The minimum of 6dB Bandwidth Measurement is 0.5 MHz.

### 5.3.2 TEST SETUP

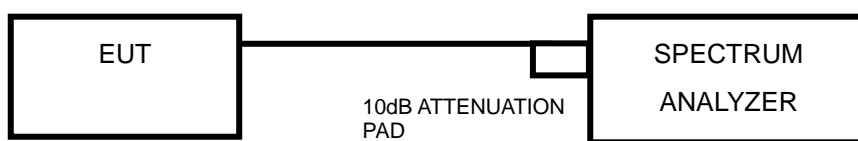

### 5.3.3 TEST INSTRUMENTS

Refer to section 4.1.2 to get information of above instrument.

### 5.3.4 TEST PROCEDURE

1. Set resolution bandwidth (RBW) = approximately 1% of the emission bandwidth
2. Set the video bandwidth (VBW)  $\geq 3 \times$  RBW, Detector = Peak.
3. Trace mode = max hold.
4. Sweep = auto couple.
5. Measure the maximum width of the emission that is constrained by the frequencies associated with the two amplitude points (upper and lower) that are attenuated by 6 dB relative to the maximum level measured in the fundamental emission.

### 5.3.5 DEVIATION FROM TEST STANDARD

No deviation.

### 5.3.6 EUT OPERATING CONDITIONS

The software provided by client to enable the EUT under transmission condition continuously at lowest, middle and highest channel frequencies individually.



A D T

### 5.3.7 TEST RESULTS

CHANNEL	FREQUENCY (MHz)	6dB BANDWIDTH (MHz)	MINIMUM LIMIT (MHz)	PASS / FAIL
0	2402	0.5786	0.5	PASS
19	2440	0.58036	0.5	PASS
39	2480	0.57997	0.5	PASS

## 5.4 CONDUCTED OUTPUT POWER

### 5.4.1 LIMITS OF CONDUCTED OUTPUT POWER MEASUREMENT

For systems using digital modulation in the 2400–2483.5 MHz: 1 Watt (30dBm)

### 5.4.2 TEST SETUP

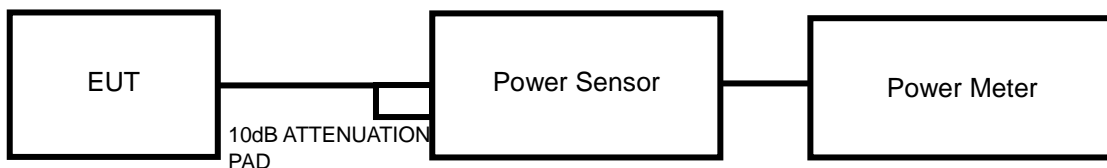

### 5.4.3 TEST INSTRUMENTS

Refer to section 4.1.2 to get information of above instrument.

### 5.4.4 TEST PROCEDURES

A peak power sensor was used on the output port of the EUT. A power meter was used to read the response of the peak power sensor. Record the peak power level.

### 5.4.5 DEVIATION FROM TEST STANDARD

No deviation.

### 5.4.6 EUT OPERATING CONDITIONS

Same as Item 4.3.6.

### 5.4.7 TEST RESULTS

CHANNEL	FREQUENCY (MHz)	PEAK POWER (mW)	PEAK POWER (dBm)	LIMIT (dBm)	PASS/FAIL
0	2402	2.02	3.05	30	PASS
19	2440	2.15	3.33	30	PASS
39	2480	2.07	3.15	30	PASS

## 5.5 POWER SPECTRAL DENSITY MEASUREMENT

### 5.5.1 LIMITS OF POWER SPECTRAL DENSITY MEASUREMENT

The Maximum of Power Spectral Density Measurement is 8dBm.

### 5.5.2 TEST SETUP

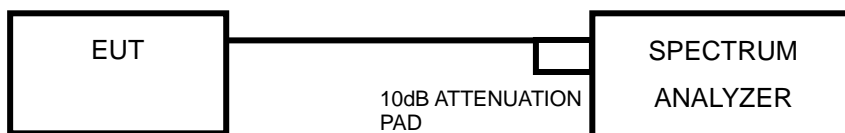

### 5.5.3 TEST INSTRUMENTS

Refer to section 4.1.2 to get information of above instrument.

### 5.5.4 TEST PROCEDURE

- Set the RBW = 100 kHz, VBW =300 kHz, Detector = peak.
- Sweep time = auto couple, Trace mode = max hold, allow trace to fully stabilize.
- Use the peak marker function to determine the maximum power level in any 100 kHz band segment within the fundamental EBW.
- Scale the observed power level to an equivalent value in 3 kHz by adjusting (reducing) the measured power by a bandwidth correction factor (BWCF) where  $BWCF = 10\log(3 \text{ kHz}/100\text{kHz})$

### 5.5.5 DEVIATION FROM TEST STANDARD

No deviation.

### 5.5.6 EUT OPERATING CONDITION

Same as Item 4.3.6

### 5.5.7 TEST RESULTS

Channel	FREQ. (MHz)	PSD (dBm/100kHz)	PSD (dBm/3kHz)	Limit (dBm/3kHz)	PASS /FAIL
0	2402	2.36	-12.87	8	PASS
19	2440	2.65	-12.58	8	PASS
39	2480	2.5	-12.73	8	PASS

## 5.6 CONDUCTED OUT OF BAND EMISSION MEASUREMENT

### 5.6.1 LIMITS OF OUT OF BAND EMISSION MEASUREMENT

Below  $-20\text{dB}$  of the highest emission level of operating band (in 100kHz Resolution Bandwidth).

### 5.6.2 TEST SETUP

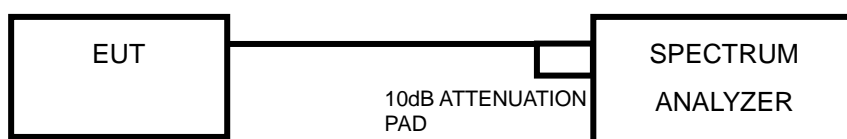

### 5.6.3 TEST INSTRUMENTS

Refer to section 4.1.2 to get information of above instrument.

### 5.6.4 TEST PROCEDURE

#### MEASUREMENT PROCEDURE REF

1. Set the RBW = 100 kHz.
2. Set the VBW  $\geq$  300 kHz.
3. Detector = peak.
4. Sweep time = auto couple.
5. Trace mode = max hold.
6. Allow trace to fully stabilize.
7. Use the peak marker function to determine the maximum power level in any 100 kHz band segment within the fundamental EBW.

## MEASUREMENT PROCEDURE OOB

1. Set RBW = 100 kHz.
2. Set VBW  $\geq$  300 kHz.
3. Set span to encompass the spectrum to be examined
4. Detector = peak.
5. Trace Mode = max hold.
6. Sweep = auto couple.

### 5.6.5 DEVIATION FROM TEST STANDARD

No deviation.

### 5.6.6 EUT OPERATING CONDITION

Same as Item 4.3.6

### 5.6.7 TEST RESULTS

The spectrum plots are attached on the following pages. D1 line indicates the highest level, and D2 line indicates the 20dB offset below D1. It shows compliance with the requirement.

### 5.6.8 TEST RESULTS

#### CH 0

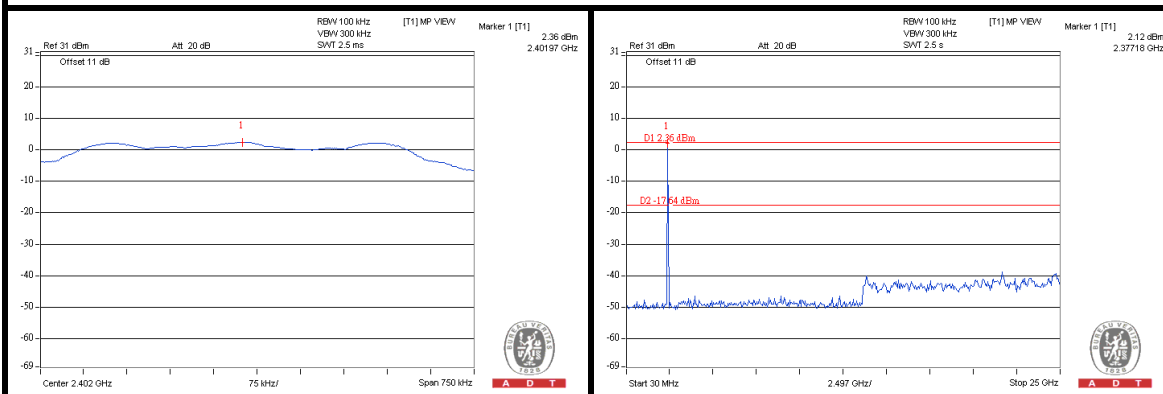

#### CH 19

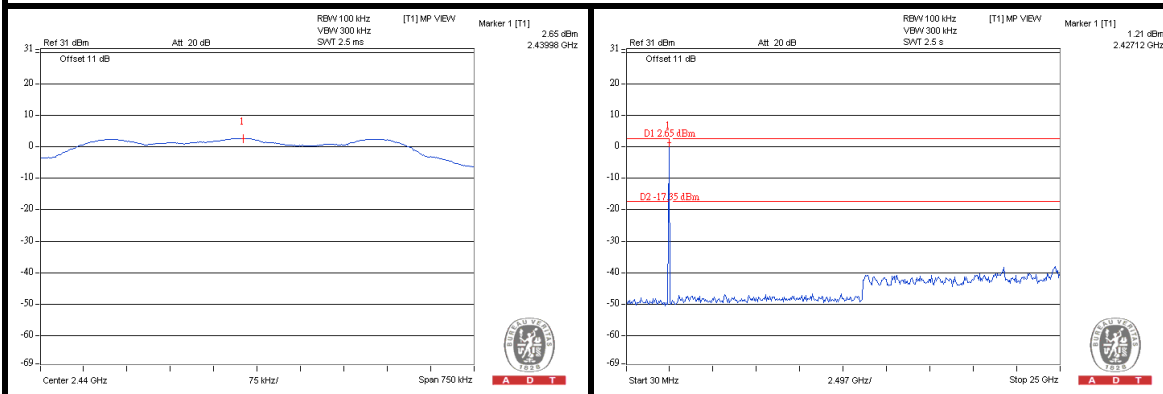

#### CH 39

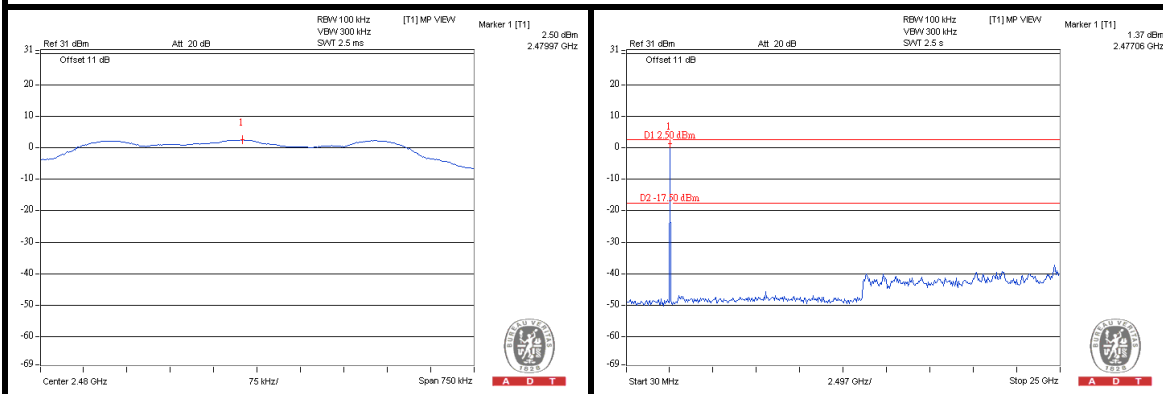

## 6. PHOTOGRAPHS OF THE TEST CONFIGURATION

Please refer to the attached file (Test Setup Photo).





## 7. INFORMATION ON THE TESTING LABORATORIES

We, Bureau Veritas Consumer Products Services (H.K.) Ltd., Taoyuan Branch, were founded in 1988 to provide our best service in EMC, Radio, Telecom and Safety consultation. Our laboratories are accredited and approved according to ISO/IEC 17025.

If you have any comments, please feel free to contact us at the following:

**Linko EMC/RF Lab:**

Tel: 886-2-26052180

Fax: 886-2-26051924

**Hsin Chu EMC/RF Lab:**

Tel: 886-3-5935343

Fax: 886-3-5935342

**Hwa Ya EMC/RF/Safety Telecom Lab:**

Tel: 886-3-3183232

Fax: 886-3-3270892

**Email:** [service.adt@tw.bureauveritas.com](mailto:service.adt@tw.bureauveritas.com)

**Web Site:** [www.adt.com.tw](http://www.adt.com.tw)

The address and road map of all our labs can be found in our web site also.

## **8. APPENDIX A - MODIFICATIONS RECORDERS FOR ENGINEERING CHANGES TO THE EUT BY THE LAB**

No modifications were made to the EUT by the lab during the test.

**--- END ---**