

FCC Test Report

(PART 22)

Report No.: RF180704C01

FCC ID: ZMOL850GLD

Test Model: L850-GL

Received Date: Jul. 04, 2018

Test Date: Jul. 09, 2018 ~ Jul. 17, 2018

Issued Date: Jul. 19, 2018

Applicant: Fibocom Wireless Inc.

Address: 5/F, Tower A, Technology Building II, 1057 Nanhai Blvd, Nanshan,
Shenzhen, China

Issued By: Bureau Veritas Consumer Products Services (H.K.) Ltd., Taoyuan Branch

Lab Address: No. 47-2, 14th Ling, Chia Pau Vil., Lin Kou Dist., New Taipei City, Taiwan
(R.O.C)

Test Location: No. 19, Hwa Ya 2nd Rd, Wen Hwa Vil, Kwei Shan Dist., Taoyuan City
33383, Taiwan (R.O.C)

**FCC Registration /
Designation Number:** 788550 / TW0003



This report is for your exclusive use. Any copying or replication of this report to or for any other person or entity, or use of our name or trademark, is permitted only with our prior written permission. This report sets forth our findings solely with respect to the test samples identified herein. The results set forth in this report are not indicative or representative of the quality or characteristics of the lot from which a test sample was taken or any similar or identical product unless specifically and expressly noted. Our report includes all of the tests requested by you and the results thereof based upon the information that you provided to us. You have 60 days from date of issuance of this report to notify us of any material error or omission caused by our negligence, provided, however, that such notice shall be in writing and shall specifically address the issue you wish to raise. A failure to raise such issue within the prescribed time shall constitute your unqualified acceptance of the completeness of this report, the tests conducted and the correctness of the report contents. Unless specific mention, the uncertainty of measurement has been explicitly taken into account to declare the compliance or non-compliance to the specification. The report must not be used by the client to claim product certification, approval, or endorsement by TAF or any government agencies

Table of Contents

Release Control Record	4
1 Certificate of Conformity	5
2 Summary of Test Results	6
2.1 Measurement Uncertainty	6
2.2 Test Site and Instruments	7
3 General Information	8
3.1 General Description of EUT	8
3.2 Configuration of System under Test	9
3.2.1 Description of Support Units	9
3.3 Test Mode Applicability and Tested Channel Detail	10
3.4 EUT Operating Conditions	13
3.5 General Description of Applied Standards	13
4 Test Types and Results	14
4.1 Output Power Measurement	14
4.1.1 Limits of Output Power Measurement	14
4.1.2 Test Procedures	14
4.1.3 Test Setup	14
4.1.4 Test Results	15
4.2 Modulation Characteristics Measurement	20
4.2.1 Limits of Modulation Characteristics	20
4.2.2 Test Setup	20
4.2.3 Test Procedure	20
4.2.4 Test Results	21
4.3 Frequency Stability Measurement	22
4.3.1 Limits of Frequency Stability Measurement	22
4.3.2 Test Procedure	22
4.3.3 Test Setup	22
4.3.4 Test Results	23
4.4 Occupied Bandwidth Measurement	33
4.4.1 Test Procedure	33
4.4.2 Test Setup	33
4.4.3 Test Result	34
4.5 Band Edge Measurement	40
4.5.1 Limits of Band Edge Measurement	40
4.5.2 Test Setup	40
4.5.3 Test Procedures	40
4.5.4 Test Results	41
4.6 Peak to Average Ratio	51
4.6.1 Limits of Peak to Average Ratio Measurement	51
4.6.2 Test Setup	51
4.6.3 Test Procedures	51
4.6.4 Test Results	52
4.7 Conducted Spurious Emissions	58
4.7.1 Limits of Conducted Spurious Emissions Measurement	58
4.7.2 Test Setup	58
4.7.3 Test Procedure	58
4.7.4 Test Results	59
4.8 Radiated Emission Measurement	69
4.8.1 Limits of Radiated Emission Measurement	69
4.8.2 Test Procedure	69
4.8.3 Deviation from Test Standard	69
4.8.4 Test Setup	70
4.8.5 Test Results	71

5 Pictures of Test Arrangements.....	89
Appendix – Information on the Testing Laboratories	90

Release Control Record

Issue No.	Description	Date Issued
RF180704C01	Original Release	Jul. 19, 2018

1 Certificate of Conformity

Product: LTE module

Brand: Fibocom

Test Model: L850-GL

Sample Status: Identical Prototype

Applicant: Fibocom Wireless Inc.

Test Date: Jul. 09, 2018 ~ Jul. 17, 2018

Standards: FCC Part 22, Subpart H

The above equipment has been tested by **Bureau Veritas Consumer Products Services (H.K.) Ltd., Taoyuan Branch**, and found compliance with the requirement of the above standards. The test record, data evaluation & Equipment Under Test (EUT) configurations represented herein are true and accurate accounts of the measurements of the sample's RF characteristics under the conditions specified in this report.

Prepared by :

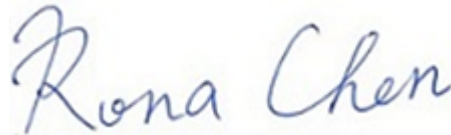

Date:

Jul. 19, 2018

Rona Chen / Specialist

Approved by :

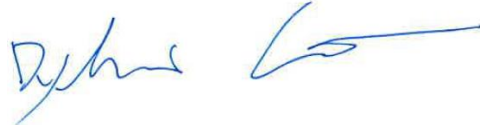

Date:

Jul. 19, 2018

Dylan Chiou / Project Engineer

2 Summary of Test Results

Applied Standard: FCC Part 22 & Part 2			
FCC Clause	Test Item	Result	Remarks
2.1046 22.913 (a)	Effective Radiated Power	Pass	Meet the requirement of limit.
2.1047	Modulation Characteristics	Pass	Meet the requirement.
---	Peak to Average Ratio	Pass	Meet the requirement of limit.
2.1055 22.355	Frequency Stability	Pass	Meet the requirement of limit.
2.1049	Occupied Bandwidth	Pass	Meet the requirement of limit.
22.917	Band Edge Measurements	Pass	Meet the requirement of limit.
2.1051 22.917	Conducted Spurious Emissions	Pass	Meet the requirement of limit.
2.1053 22.917	Radiated Spurious Emissions	Pass	Meet the requirement of limit. Minimum passing margin is -29.40 dB at 40.67 MHz.

2.1 Measurement Uncertainty

Where relevant, the following measurement uncertainty levels have been estimated for tests performed on the EUT as specified in CISPR 16-4-2:

Measurement	Frequency	Expanded Uncertainty (k=2) (±)
Radiated Emissions up to 1 GHz	30 MHz ~ 200 MHz	2.93 dB
	200 MHz ~ 1000 MHz	2.95 dB
Radiated Emissions above 1 GHz	1 GHz ~ 18 GHz	2.26 dB
	18 GHz ~ 40 GHz	1.94 dB

2.2 Test Site and Instruments

Description & Manufacturer	Model No.	Serial No.	Date of Calibration	Due Date of Calibration
Test Receiver Agilent	N9038A	MY51210203	Mar. 16, 2018	Mar. 15, 2019
Spectrum Analyzer Agilent	N9010A	MY52220314	Nov. 24, 2017	Nov. 23, 2018
Spectrum Analyzer ROHDE & SCHWARZ	FSU43	101261	Jan. 11, 2018	Jan. 10, 2019
Double Ridge Guide Horn Antenna EMCO	3115	5619	Nov. 30, 2017	Nov. 29, 2018
BILOG Antenna SCHWARZBECK	VULB 9168	9168-153	Dec. 06, 2017	Dec. 05, 2018
Fixed Attenuator Mini-Circuits	MDCS18N-10	MDCS18N-10-01	Apr. 16, 2018	Apr. 15, 2019
Preamplifier EMCI	EMC 012645	980115	Oct. 20, 2017	Oct. 19, 2018
Preamplifier EMCI	EMC 184045	980116	Oct. 20, 2017	Oct. 19, 2018
Preamplifier EMCI	EMC 330H	980112	Oct. 13, 2017	Oct. 12, 2018
Power Meter Anritsu	ML2495A	1012010	Aug. 15, 2017	Aug. 14, 2018
Power Sensor Anritsu	MA2411B	1315050	Aug. 15, 2017	Aug. 14, 2018
RF Coaxial Cable HUBER+SUHNNER	EMC104-SM-SM-800 0&3000	140811+170717	Oct. 20, 2017	Oct. 19, 2018
RF Coaxial Cable HUBER+SUHNNER	SUCOFLEX 104	EMC104-SM-SM- 1000(140807)	Oct. 20, 2017	Oct. 19, 2018
RF Coaxial Cable Worken	8D-FB	Cable-Ch10-01	Oct. 20, 2017	Oct. 19, 2018
Software BV ADT	E3 6.120103	NA	NA	NA
Antenna Tower MF	MFA-440H	NA	NA	NA
Turn Table MF	MFT-201SS	NA	NA	NA
Antenna Tower & Turn Table Controller MF	MF-7802	NA	NA	NA
Radio Communication Analyzer	MT8820C	6201300640	Aug. 16, 2017	Aug. 15, 2019
Temperature & Humidity Chamber	GTH-120-40-CP-AR	MAA1306-019	Sep. 08, 2017	Sep. 07, 2018
DC Power Supply Topward	33010D	807748	Oct. 25, 2016	Oct. 24, 2018
Digital Multimeter Fluke	87-III	70360742	Jun. 29, 2018	Jun. 28, 2019

- Note: 1. The calibration interval of the above test instruments is 12 / 24 months and the calibrations are traceable to NML/ROC and NIST/USA.
2. The test was performed in HwaYa Chamber 10.
3. The horn antenna and preamplifier (model: EMC 184045) are used only for the measurement of emission frequency above 1 GHz if tested.
4. The IC Site Registration No. is IC7450F-10.

3 General Information

3.1 General Description of EUT

Product	LTE module	
Brand	Fibocom	
Test Model	L850-GL	
Status of EUT	Identical Prototype	
Power Supply Rating	3.3 Vdc (Host equipment)	
Modulation Type	WCDMA	QPSK
	LTE	QPSK, 16QAM
Frequency Range	WCDMA	826.4 ~ 846.6 MHz
	LTE 5 (Channel Bandwidth: 1.4 MHz)	824.7 ~ 848.3 MHz
	LTE 5 (Channel Bandwidth: 3 MHz)	825.5 ~ 847.5 MHz
	LTE 5 (Channel Bandwidth: 5 MHz)	826.5 ~ 846.5 MHz
	LTE 5 (Channel Bandwidth: 10 MHz)	829 ~ 844 MHz
	LTE 26 (Channel Bandwidth: 1.4 MHz)	824.7 ~ 848.3 MHz
	LTE 26 (Channel Bandwidth: 3 MHz)	825.5 ~ 847.5 MHz
	LTE 26 (Channel Bandwidth: 5 MHz)	826.5 ~ 846.5 MHz
	LTE 26 (Channel Bandwidth: 10 MHz)	829 ~ 844 MHz
	LTE 26 (Channel Bandwidth: 15 MHz)	831.5 ~ 841.5 MHz
Max. ERP Power	WCDMA	319.15 mW
	LTE 5 (Channel Bandwidth: 1.4 MHz)	240.44 mW
	LTE 5 (Channel Bandwidth: 3 MHz)	244.34 mW
	LTE 5 (Channel Bandwidth: 5 MHz)	245.47 mW
	LTE 5 (Channel Bandwidth: 10 MHz)	250.03 mW
	LTE 26 (Channel Bandwidth: 1.4 MHz)	239.33 mW
	LTE 26 (Channel Bandwidth: 3 MHz)	240.99 mW
	LTE 26 (Channel Bandwidth: 5 MHz)	243.78 mW
	LTE 26 (Channel Bandwidth: 10 MHz)	249.46 mW
LTE 26 (Channel Bandwidth: 15 MHz)	251.19 mW	
Emission Designator	WCDMA	4M09F9W
	LTE 5 (Channel Bandwidth: 1.4 MHz)	1M09G7D
	LTE 5 (Channel Bandwidth: 3 MHz)	2M70G7D
	LTE 5 (Channel Bandwidth: 5 MHz)	4M50G7D
	LTE 5 (Channel Bandwidth: 10 MHz)	9M01G7D
	LTE 26 (Channel Bandwidth: 1.4 MHz)	1M09G7D
	LTE 26 (Channel Bandwidth: 3 MHz)	2M71G7D
	LTE 26 (Channel Bandwidth: 5 MHz)	4M50W7D
	LTE 26 (Channel Bandwidth: 10 MHz)	9M01G7D
	LTE 26 (Channel Bandwidth: 15 MHz)	13M52W7D
Antenna Type	External Antenna with 3.0 dBi gain	
Accessory Device	N/A	
Data Cable Supplied	N/A	

Note:

1. The above EUT information is declared by manufacturer and for more detailed features description, please refers to the manufacturer's specifications or user's manual.

3.2 Configuration of System under Test

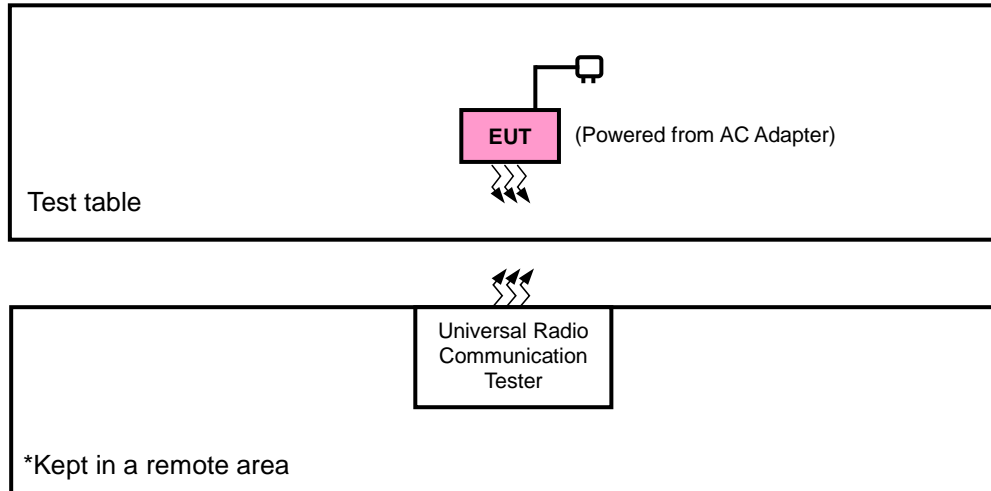

3.2.1 Description of Support Units

The EUT has been tested as an independent unit together with other necessary accessories or support units.

3.3 Test Mode Applicability and Tested Channel Detail

Pre-Scan has been conducted to determine the worst-case mode from all possible combinations between available modulations, data rates, XYZ axis, and antenna ports.

The worst case was found when positioned as the table below. Following channel(s) was (were) selected for the final test as listed below:

Band	Radiated Emission
WCDMA	Z-axis
LTE Band 5	Z-axis
LTE Band 26	Z-axis

WCDMA

EUT Configure Mode	Test Item	Available Channel	Tested Channel	Mode
-	ERP	4132 to 4233	4132, 4182, 4233	WCDMA
-	Modulation Characteristics	4132 to 4233	4182	WCDMA
-	Frequency Stability	4132 to 4233	4132, 4233	WCDMA
-	Occupied Bandwidth	4132 to 4233	4132, 4182, 4233	WCDMA
-	Band Edge	4132 to 4233	4132, 4233	WCDMA
-	Peak to Average Ratio	4132 to 4233	4132, 4182, 4233	WCDMA
-	Conducted Emission	4132 to 4233	4132, 4182, 4233	WCDMA
-	Radiated Emission	4132 to 4233	4132, 4182, 4233	WCDMA

LTE Band 5

EUT Configure Mode	Test Item	Available Channel	Tested Channel	Channel Bandwidth	Modulation	Mode		
-	ERP	20407 to 20643	20407, 20525, 20643	1.4 MHz	QPSK, 16QAM	1 RB / 0 RB Offset		
		20415 to 20635	20415, 20525, 20635	3 MHz	QPSK, 16QAM	1 RB / 0 RB Offset		
		20425 to 20625	20425, 20525, 20625	5 MHz	QPSK, 16QAM	1 RB / 0 RB Offset		
		20450 to 20600	20450, 20525, 20600	10 MHz	QPSK, 16QAM	1 RB / 0 RB Offset		
-	Modulation Characteristics	20450 to 20600	20525	5 MHz	QPSK, 16QAM	25 RB / 0 RB Offset		
-	Frequency Stability	20407 to 20643	20407, 20643	1.4 MHz	QPSK	1 RB / 2 RB Offset		
		20415 to 20635	20415, 20635	3 MHz	QPSK	1 RB / 7 RB Offset		
		20425 to 20625	20425, 20625	5 MHz	QPSK	1 RB / 12 RB Offset		
		20450 to 20600	20450, 20600	10 MHz	QPSK	1 RB / 24 RB Offset		
-	Occupied Bandwidth	20407 to 20643	20407, 20525, 20643	1.4 MHz	QPSK, 16QAM	6 RB / 0 RB Offset		
		20415 to 20635	20415, 20525, 20635	3 MHz	QPSK, 16QAM	15 RB / 0 RB Offset		
		20425 to 20625	20425, 20525, 20625	5 MHz	QPSK, 16QAM	25 RB / 0 RB Offset		
		20450 to 20600	20450, 20525, 20600	10 MHz	QPSK, 16QAM	50 RB / 0 RB Offset		
-	Band Edge	20407 to 20643	20407	1.4MHz	QPSK	1 RB / 0 RB Offset 6 RB / 0 RB Offset		
			20643	1.4MHz	QPSK	1 RB / 5 RB Offset 6 RB / 0 RB Offset		
		20415 to 20635	20415	3 MHz	QPSK	1 RB / 0 RB Offset 15 RB / 0 RB Offset		
			20635	3 MHz	QPSK	1 RB / 14 RB Offset 15 RB / 0 RB Offset		
		20425 to 20625	20425	5 MHz	QPSK	1 RB / 0 RB Offset 25 RB / 0 RB Offset		
			20625	5 MHz	QPSK	1 RB / 24 RB Offset 25 RB / 0 RB Offset		
		20450 to 20600	20450	10 MHz	QPSK	1 RB / 0 RB Offset 50 RB / 0 RB Offset		
			20600	10 MHz	QPSK	1 RB / 49 RB Offset 50 RB / 0 RB Offset		
		-	Peak to Average Ratio	20407 to 20643	20407, 20525, 20643	1.4 MHz	QPSK, 16QAM	6 RB / 0 RB Offset
				20415 to 20635	20415, 20525, 20635	3 MHz	QPSK, 16QAM	15 RB / 0 RB Offset
				20425 to 20625	20425, 20525, 20625	5 MHz	QPSK, 16QAM	25 RB / 0 RB Offset
				20450 to 20600	20450, 20525, 20600	10 MHz	QPSK, 16QAM	50 RB / 0 RB Offset
-	Conducted Emission	20407 to 20643	20407, 20525, 20643	1.4 MHz	QPSK	1 RB / 2 RB Offset		
		20415 to 20635	20415, 20525, 20635	3 MHz	QPSK	1 RB / 7 RB Offset		
		20425 to 20625	20425, 20525, 20625	5 MHz	QPSK	1 RB / 12 RB Offset		
		20450 to 20600	20450, 20525, 20600	10 MHz	QPSK	1 RB / 24 RB Offset		
-	Radiated Emission	20450 to 20600	20450, 20525, 20600	10 MHz	QPSK	1 RB / 24 RB Offset		

Note: This device was tested under all bandwidths, RB configurations and modulations. The worst case was found in QPSK modulation.

LTE Band 26

EUT Configure Mode	Test Item	Available Channel	Tested Channel	Channel Bandwidth	Modulation	Mode		
-	ERP	26797 to 27033	26797, 26915, 27033	1.4 MHz	QPSK, 16QAM	1 RB / 0 RB Offset		
		26805 to 27025	26805, 26915, 27025	3 MHz	QPSK, 16QAM	1 RB / 0 RB Offset		
		26815 to 27015	26815, 26915, 27015	5 MHz	QPSK, 16QAM	1 RB / 0 RB Offset		
		26840 to 26990	26840, 26915, 26990	10 MHz	QPSK, 16QAM	1 RB / 0 RB Offset		
		26865 to 26965	26865, 26915, 26965	15 MHz	QPSK, 16QAM	1 RB / 0 RB Offset		
-	Modulation Characteristics	26865 to 26965	26915	5 MHz	QPSK, 16QAM	25 RB / 0 RB Offset		
-	Frequency Stability	26797 to 27033	26797, 27033	1.4 MHz	QPSK	1 RB / 5 RB Offset		
		26805 to 27025	26805, 27025	3 MHz	QPSK	1 RB / 14 RB Offset		
		26815 to 27015	26815, 27015	5 MHz	QPSK	1 RB / 24 RB Offset		
		26840 to 26990	26840, 26990	10 MHz	QPSK	1 RB / 49 RB Offset		
		26865 to 26965	26865, 26965	15 MHz	QPSK	1 RB / 49 RB Offset		
-	Occupied Bandwidth	26797 to 27033	26797, 26915, 27033	1.4 MHz	QPSK, 16QAM	6 RB / 0 RB Offset		
		26805 to 27025	26805, 26915, 27025	3 MHz	QPSK, 16QAM	15 RB / 0 RB Offset		
		26815 to 27015	26815, 26915, 27015	5 MHz	QPSK, 16QAM	25 RB / 0 RB Offset		
		26840 to 26990	26840, 26915, 26990	10 MHz	QPSK, 16QAM	50 RB / 0 RB Offset		
		26865 to 26965	26865, 26915, 26965	15 MHz	QPSK, 16QAM	75 RB / 0 RB Offset		
-	Band Edge	26797 to 27033	26797	1.4 MHz	QPSK	1 RB / 0 RB Offset 6 RB / 0 RB Offset		
			27033	1.4 MHz	QPSK	1 RB / 5 RB Offset 6 RB / 0 RB Offset		
		26805 to 27025	26805	3 MHz	QPSK	1 RB / 0 RB Offset 15 RB / 0 RB Offset		
			27025	3 MHz	QPSK	1 RB / 14 RB Offset 15 RB / 0 RB Offset		
		26815 to 27015	26815	5 MHz	QPSK	1 RB / 0 RB Offset 25 RB / 0 RB Offset		
			27015	5 MHz	QPSK	1 RB / 24 RB Offset 25 RB / 0 RB Offset		
		26840 to 26990	26840	10 MHz	QPSK	1 RB / 0 RB Offset 50 RB / 0 RB Offset		
			26990	10 MHz	QPSK	1 RB / 49 RB Offset 50 RB / 0 RB Offset		
		26865 to 26965	26865	15 MHz	QPSK	1 RB / 0 RB Offset 75 RB / 0 RB Offset		
			26965	15 MHz	QPSK	1 RB / 74 RB Offset 75 RB / 0 RB Offset		
		-	Peak to Average Ratio	26797 to 27033	26797, 26915, 27033	1.4 MHz	QPSK, 16QAM	1 RB / 0 RB Offset
				26805 to 27025	26805, 26915, 27025	3 MHz	QPSK, 16QAM	15 RB / 0 RB Offset
				26815 to 27015	26815, 26915, 27015	5 MHz	QPSK, 16QAM	25 RB / 0 RB Offset
				26840 to 26990	26840, 26915, 26990	10 MHz	QPSK, 16QAM	50 RB / 0 RB Offset
				26865 to 26965	26865, 26915, 26965	15 MHz	QPSK, 16QAM	75 RB / 0 RB Offset
		-	Conducted Emission	26797 to 27033	26797, 26915, 27033	1.4 MHz	QPSK	1 RB / 0 RB Offset
26805 to 27025	26805, 26915, 27025			3 MHz	QPSK	15 RB / 0 RB Offset		
26815 to 27015	26815, 26915, 27015			5 MHz	QPSK	25 RB / 0 RB Offset		
26840 to 26990	26840, 26915, 26990			10 MHz	QPSK	1 RB / 0 RB Offset		
26865 to 26965	26865, 26915, 26965			15 MHz	QPSK	25 RB / 0 RB Offset		
-	Radiated Emission	26865 to 26965	26865, 26915, 26965	15 MHz	QPSK	25 RB / 0 RB Offset		

Note: This device was tested under all bandwidths, RB configurations and modulations. The worst case was found in QPSK modulation.

Test Condition:

Test Item	Environmental Conditions	Input Power	Tested By
ERP	25 deg. C, 65 % RH	3.3 Vdc	Getaz Yang
Modulation Characteristics	25 deg. C, 65 % RH	3.3 Vdc	Getaz Yang
Frequency Stability	25 deg. C, 65 % RH	3.3 Vdc	Getaz Yang
Occupied Bandwidth	25 deg. C, 65 % RH	3.3 Vdc	Getaz Yang
Band Edge	25 deg. C, 65 % RH	3.3 Vdc	Getaz Yang
Peak to Average Ratio	25 deg. C, 65 % RH	3.3 Vdc	Getaz Yang
Conducted Emission	25 deg. C, 65 % RH	3.3 Vdc	Getaz Yang
Radiated Emission	25 deg. C, 65 % RH	120 Vac, 60 Hz	Thomas Wei

3.4 EUT Operating Conditions

The EUT makes a call to the communication simulator. The communication simulator station system controlled a EUT to export maximum output power under transmission mode and specific channel frequency.

3.5 General Description of Applied Standards

The EUT is a RF Product. According to the specifications of the manufacturer, it must comply with the requirements of the following standards:

FCC 47 CFR Part 2

FCC 47 CFR Part 22

KDB 971168 D01 Power Meas License Digital Systems v03r01

ANSI/TIA/EIA-603-E 2016

ANSI 63.26-2015

Note: All test items have been performed and recorded as per the above standards.

4 Test Types and Results

4.1 Output Power Measurement

4.1.1 Limits of Output Power Measurement

Mobile / Portable station are limited to 7 watts e.r.p.

4.1.2 Test Procedures

Conducted Power Measurement:

The EUT was set up for the maximum power with GSM, GPRS, EDGE, WCDMA, CDMA, and LTE link data modulation and link up with simulator. Set the EUT to transmit under low, middle and high channel and record the power level shown on simulator.

EIRP / ERP Measurement:

- EIRP = Conducted Output power level + Antenna gain.
- ERP power can be calculated from EIRP power by subtracting the gain of dipole, ERP power = EIRP power - 2.15dBi.
- ERP = Conducted Output power level + Antenna gain (dBi) - Isotropically Factor (2.15dB)

4.1.3 Test Setup



4.1.4 Test Results

Conducted Output Power (dBm)

Band	WCDMA V		
	Channel	4132	4182
Frequency (MHz)	826.4	836.4	846.6
RMC 12.2K	24.09	24.19	23.84
HSDPA Subtest-1	21.99	22.15	21.77
HSDPA Subtest-2	21.94	22.06	21.84
HSDPA Subtest-3	21.95	22.09	21.91
HSDPA Subtest-4	21.99	22.10	21.94
HSUPA Subtest-1	19.21	19.35	19.15
HSUPA Subtest-2	19.19	19.23	19.20
HSUPA Subtest-3	19.03	19.10	19.17
HSUPA Subtest-4	19.02	19.05	19.11
HSUPA Subtest-5	19.07	19.12	19.08

Band / BW	RB Size	RB Offset	QPSK			3GPP MPR (dB)	16QAM			3GPP MPR (dB)
			Low Ch 20407	Mid Ch 20525	High Ch 20643		Low Ch 20407	Mid Ch 20525	High Ch 20643	
			824.7 MHz	836.5 MHz	848.3 MHz		824.7 MHz	836.5 MHz	848.3 MHz	
5 / 1.4M	1	0	22.78	22.92	22.96	0	21.77	21.79	21.91	1
	1	2	22.73	22.82	22.84	0	21.66	21.58	21.84	1
	1	5	22.48	22.68	22.67	0	21.44	21.45	21.73	1
	3	0	21.76	21.71	21.89	0	20.63	20.66	20.78	1
	3	1	21.57	21.55	21.67	0	20.35	20.54	20.64	1
	3	3	21.44	21.53	21.61	0	20.42	20.50	20.63	1
	6	0	21.59	21.73	21.88	1	20.54	20.65	20.79	2

Band / BW	RB Size	RB Offset	QPSK			3GPP MPR (dB)	16QAM			3GPP MPR (dB)
			Low Ch 20415	Mid Ch 20525	High Ch 20635		Low Ch 20415	Mid Ch 20525	High Ch 20635	
			825.5 MHz	836.5 MHz	847.5 MHz		825.5 MHz	836.5 MHz	847.5 MHz	
5 / 3M	1	0	22.83	22.91	23.03	0	21.48	21.70	21.92	1
	1	7	22.74	22.80	22.89	0	21.74	21.79	21.66	1
	1	14	22.66	22.73	22.79	0	21.49	21.47	21.80	1
	8	0	21.67	21.82	21.95	1	20.66	20.72	20.91	2
	8	3	21.54	21.64	21.70	1	20.50	20.59	20.72	2
	8	7	21.34	21.47	21.57	1	20.39	20.43	20.58	2
	15	0	21.65	21.76	21.81	1	20.68	20.78	20.82	2

Band / BW	RB Size	RB Offset	QPSK			3GPP MPR (dB)	16QAM			3GPP MPR (dB)
			Low Ch 20425	Mid Ch 20525	High Ch 20625		Low Ch 20425	Mid Ch 20525	High Ch 20625	
			826.5 MHz	836.5 MHz	846.5 MHz		826.5 MHz	836.5 MHz	846.5 MHz	
5 / 5M	1	0	22.92	22.96	23.05	0	21.68	21.72	21.98	1
	1	12	22.78	22.86	22.92	0	21.78	21.73	21.91	1
	1	24	22.71	22.67	22.67	0	21.56	21.68	21.77	1
	12	0	21.79	21.87	21.96	1	20.61	20.64	20.75	2
	12	6	21.65	21.69	21.80	1	20.58	20.57	20.71	2
	12	13	21.48	21.59	21.69	1	20.46	20.51	20.61	2
	25	0	21.83	21.86	21.88	1	20.76	20.83	20.81	2

Band / BW	RB Size	RB Offset	QPSK			3GPP MPR (dB)	16QAM			3GPP MPR (dB)
			Low Ch 20450	Mid Ch 20525	High Ch 20600		Low Ch 20450	Mid Ch 20525	High Ch 20600	
			829.0 MHz	836.5 MHz	844.0 MHz		829.0 MHz	836.5 MHz	844.0 MHz	
5 / 10M	1	0	22.99	23.04	23.13	0	21.82	21.90	21.94	1
	1	24	22.81	22.86	23.01	0	21.82	21.91	21.78	1
	1	49	22.77	22.69	22.81	0	21.66	21.66	21.75	1
	25	0	21.88	21.95	22.00	1	20.65	20.90	20.83	2
	25	12	21.72	21.77	21.81	1	20.52	20.74	20.73	2
	25	25	21.52	21.72	21.73	1	20.46	20.52	20.57	2
	50	0	21.83	21.97	21.94	1	20.73	20.87	20.87	2

Band / BW	RB Size	RB Offset	QPSK			3GPP MPR (dB)	16QAM			3GPP MPR (dB)
			Low Ch 26797	Mid Ch 26915	High Ch 27033		Low Ch 26797	Mid Ch 26915	High Ch 27033	
			824.7 MHz	836.5 MHz	848.3 MHz		824.7 MHz	836.5 MHz	848.3 MHz	
26 / 1.4M	1	0	22.06	22.12	22.94	0	21.03	21.04	21.90	1
	1	2	21.92	21.97	22.74	0	20.88	20.95	21.78	1
	1	5	21.73	21.86	22.55	0	20.67	20.84	21.58	1
	3	0	22.00	22.09	21.78	0	20.96	21.04	20.80	1
	3	1	21.80	21.89	21.57	0	20.79	20.87	20.66	1
	3	3	21.67	21.88	21.63	0	20.66	20.68	20.51	1
	6	0	21.02	21.02	21.69	1	19.85	19.94	20.71	2

Band / BW	RB Size	RB Offset	QPSK			3GPP MPR (dB)	16QAM			3GPP MPR (dB)
			Low Ch 26805	Mid Ch 26915	High Ch 27025		Low Ch 26805	Mid Ch 26915	High Ch 27025	
			825.5 MHz	836.5 MHz	847.5 MHz		825.5 MHz	836.5 MHz	847.5 MHz	
26 / 3M	1	0	22.19	22.26	22.97	0	21.16	21.25	21.73	1
	1	7	22.07	22.12	22.91	0	20.99	21.15	21.67	1
	1	14	21.87	21.90	22.65	0	20.90	20.95	21.67	1
	8	0	21.05	21.25	21.80	1	19.96	20.20	20.71	2
	8	3	20.96	21.13	21.57	1	19.78	20.04	20.56	2
	8	7	20.74	20.99	21.50	1	19.61	19.91	20.47	2
	15	0	21.02	21.21	21.81	1	19.94	20.18	20.80	2

Band / BW	RB Size	RB Offset	QPSK			3GPP MPR (dB)	16QAM			3GPP MPR (dB)
			Low Ch 26815	Mid Ch 26915	High Ch 27015		Low Ch 26815	Mid Ch 26915	High Ch 27015	
			826.5 MHz	836.5 MHz	846.5 MHz		826.5 MHz	836.5 MHz	846.5 MHz	
26 / 5M	1	0	22.30	22.31	23.02	0	21.22	21.23	21.80	1
	1	12	22.20	22.21	22.85	0	21.13	21.12	21.76	1
	1	24	21.96	21.98	22.76	0	20.98	21.01	21.63	1
	12	0	21.24	21.28	21.88	1	20.12	20.12	20.75	2
	12	6	21.13	21.13	21.64	1	19.99	20.10	20.64	2
	12	13	20.89	20.95	21.58	1	19.86	19.88	20.62	2
	25	0	21.29	21.30	21.93	1	20.10	20.11	20.68	2

Band / BW	RB Size	RB Offset	QPSK			3GPP MPR (dB)	16QAM			3GPP MPR (dB)
			Low Ch 26840	Mid Ch 26915	High Ch 26990		Low Ch 26840	Mid Ch 26915	High Ch 26990	
			829.0 MHz	836.5 MHz	844.0 MHz		829.0 MHz	836.5 MHz	844.0 MHz	
26 / 10M	1	0	22.56	22.43	23.12	0	21.48	21.35	21.92	1
	1	24	22.44	22.28	22.97	0	21.46	21.24	21.80	1
	1	49	22.25	22.22	22.72	0	21.15	21.01	21.77	1
	25	0	21.53	21.40	21.89	1	20.40	20.27	20.90	2
	25	12	21.40	21.25	21.69	1	20.36	20.25	20.73	2
	25	25	21.28	21.03	21.65	1	20.07	19.93	20.61	2
	50	0	21.45	21.26	21.98	1	20.40	20.38	20.93	2

Band / BW	RB Size	RB Offset	QPSK			3GPP MPR (dB)	16QAM			3GPP MPR (dB)
			Low Ch 26865	Mid Ch 26915	High Ch 26965		Low Ch 26865	Mid Ch 26915	High Ch 26965	
			831.5 MHz	836.5 MHz	841.5 MHz		831.5 MHz	836.5 MHz	841.5 MHz	
26 / 15M	1	0	22.96	22.56	23.15	0	21.86	21.55	22.01	1
	1	37	22.87	22.42	22.98	0	21.83	21.37	21.98	1
	1	74	22.76	22.32	22.87	0	21.50	21.30	21.74	1
	36	0	21.84	21.54	21.98	1	20.72	20.50	20.94	2
	36	19	21.68	21.41	21.81	1	20.57	20.37	20.74	2
	36	39	21.56	21.18	21.67	1	20.46	20.16	20.67	2
	75	0	21.77	21.46	21.95	1	20.79	20.46	20.94	2

ERP Power (dBm)

Note: ERP (dBm) = Max. Conducted Power (dBm) + Gain (dBi) – 2.15

Band	WCDMA V		
	RMC 12.2K		
Channel	4132	4182	4233
Frequency (MHz)	826.4	836.4	846.6
Max. Cond. Power (dBm)	24.09	24.19	23.84
Max. ERP Power (dBm)	24.94	25.04	24.69
Max. ERP Power (mW)	311.89	319.15	294.44

Band 5 / 1.4M, 1RB#0						
Test Mode	QPSK			16QAM		
	Low Ch 20407	Mid Ch 20525	High Ch 20643	Low Ch 20407	Mid Ch 20525	High Ch 20643
		824.7 MHz	836.5 MHz	848.3 MHz	824.7 MHz	836.5 MHz
Max. Cond. Power (dBm)	22.78	22.92	22.96	21.77	21.79	21.91
Max. ERP Power (dBm)	23.63	23.77	23.81	22.62	22.64	22.76
Max. ERP Power (mW)	230.67	238.23	240.44	182.81	183.65	188.80

Band 5 / 3M, 1RB#0						
Test Mode	QPSK			16QAM		
	Low Ch 20415	Mid Ch 20525	High Ch 20635	Low Ch 20415	Mid Ch 20525	High Ch 20635
		825.5 MHz	836.5 MHz	847.5 MHz	825.5 MHz	836.5 MHz
Max. Cond. Power (dBm)	22.83	22.91	23.03	21.48	21.70	21.92
Max. ERP Power (dBm)	23.68	23.76	23.88	22.33	22.55	22.77
Max. ERP Power (mW)	233.35	237.68	244.34	171.00	179.89	189.23

Band 5 / 5M, 1RB#0						
Test Mode	QPSK			16QAM		
	Low Ch 20425	Mid Ch 20525	High Ch 20625	Low Ch 20425	Mid Ch 20525	High Ch 20625
		826.5 MHz	836.5 MHz	846.5 MHz	826.5 MHz	836.5 MHz
Max. Cond. Power (dBm)	22.92	22.96	23.05	21.68	21.72	21.98
Max. ERP Power (dBm)	23.77	23.81	23.90	22.53	22.57	22.83
Max. ERP Power (mW)	238.23	240.44	245.47	179.06	180.72	191.87

Band 5 / 10M, 1RB#0						
Test Mode	QPSK			16QAM		
	Low Ch 20450	Mid Ch 20525	High Ch 20600	Low Ch 20450	Mid Ch 20525	High Ch 20600
		829.0 MHz	836.5 MHz	844.0 MHz	829.0 MHz	836.5 MHz
Max. Cond. Power (dBm)	22.99	23.04	23.13	21.82	21.90	21.94
Max. ERP Power (dBm)	23.84	23.89	23.98	22.67	22.75	22.79
Max. ERP Power (mW)	242.10	244.91	250.03	184.93	188.36	190.11

Band 26 / 1.4M, 1RB#0

Test Mode	QPSK			16QAM		
	Low Ch 26797	Mid Ch 26915	High Ch 27033	Low Ch 26797	Mid Ch 26915	High Ch 27033
	824.7 MHz	836.5 MHz	848.3 MHz	824.7 MHz	836.5 MHz	848.3 MHz
Max. Cond. Power (dBm)	22.06	22.12	22.94	21.03	21.04	21.90
Max. ERP Power (dBm)	22.91	22.97	23.79	21.88	21.89	22.75
Max. ERP Power (mW)	195.43	198.15	239.33	154.17	154.53	188.36

Band 26 / 3M, 1RB#0

Test Mode	QPSK			16QAM		
	Low Ch 26805	Mid Ch 26915	High Ch 27025	Low Ch 26805	Mid Ch 26915	High Ch 27025
	825.5 MHz	836.5 MHz	847.5 MHz	825.5 MHz	836.5 MHz	847.5 MHz
Max. Cond. Power (dBm)	22.19	22.26	22.97	21.16	21.25	21.73
Max. ERP Power (dBm)	23.04	23.11	23.82	22.01	22.10	22.58
Max. ERP Power (mW)	201.37	204.64	240.99	158.85	162.18	181.13

Band 26 / 5M, 1RB#0

Test Mode	QPSK			16QAM		
	Low Ch 26815	Mid Ch 26915	High Ch 27015	Low Ch 26815	Mid Ch 26915	High Ch 27015
	826.5 MHz	836.5 MHz	846.5 MHz	826.5 MHz	836.5 MHz	846.5 MHz
Max. Cond. Power (dBm)	22.30	22.31	23.02	21.22	21.23	21.80
Max. ERP Power (dBm)	23.15	23.16	23.87	22.07	22.08	22.65
Max. ERP Power (mW)	206.54	207.01	243.78	161.06	161.44	184.08

Band 26 / 10M, 1RB#0

Test Mode	QPSK			16QAM		
	Low Ch 26840	Mid Ch 26915	High Ch 26990	Low Ch 26840	Mid Ch 26915	High Ch 26990
	829.0 MHz	836.5 MHz	844.0 MHz	829.0 MHz	836.5 MHz	844.0 MHz
Max. Cond. Power (dBm)	22.56	22.43	23.12	21.48	21.35	21.92
Max. ERP Power (dBm)	23.41	23.28	23.97	22.33	22.20	22.77
Max. ERP Power (mW)	219.28	212.81	249.46	171.00	165.96	189.23

Band 26 / 15M, 1RB#0

Test Mode	QPSK			16QAM		
	Low Ch 26865	Mid Ch 26915	High Ch 26965	Low Ch 26865	Mid Ch 26915	High Ch 26965
	831.5 MHz	836.5 MHz	841.5 MHz	831.5 MHz	836.5 MHz	841.5 MHz
Max. Cond. Power (dBm)	22.96	22.56	23.15	21.86	21.55	22.01
Max. ERP Power (dBm)	23.81	23.41	24.00	22.71	22.40	22.86
Max. ERP Power (mW)	240.44	219.28	251.19	186.64	173.78	193.20

4.2 Modulation Characteristics Measurement

4.2.1 Limits of Modulation Characteristics

N/A

4.2.2 Test Setup

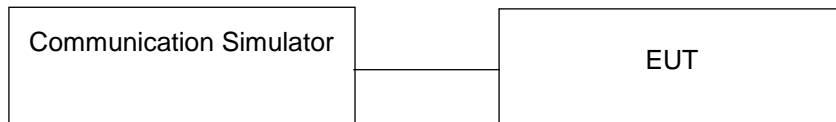

4.2.3 Test Procedure

Connect the EUT to Communication Simulator via the antenna connector. The frequency band is set as EUT supported Modulation and Channels, the EUT output is matched with 50 ohm load, the waveform quality and constellation of the EUT was tested.

4.2.4 Test Results

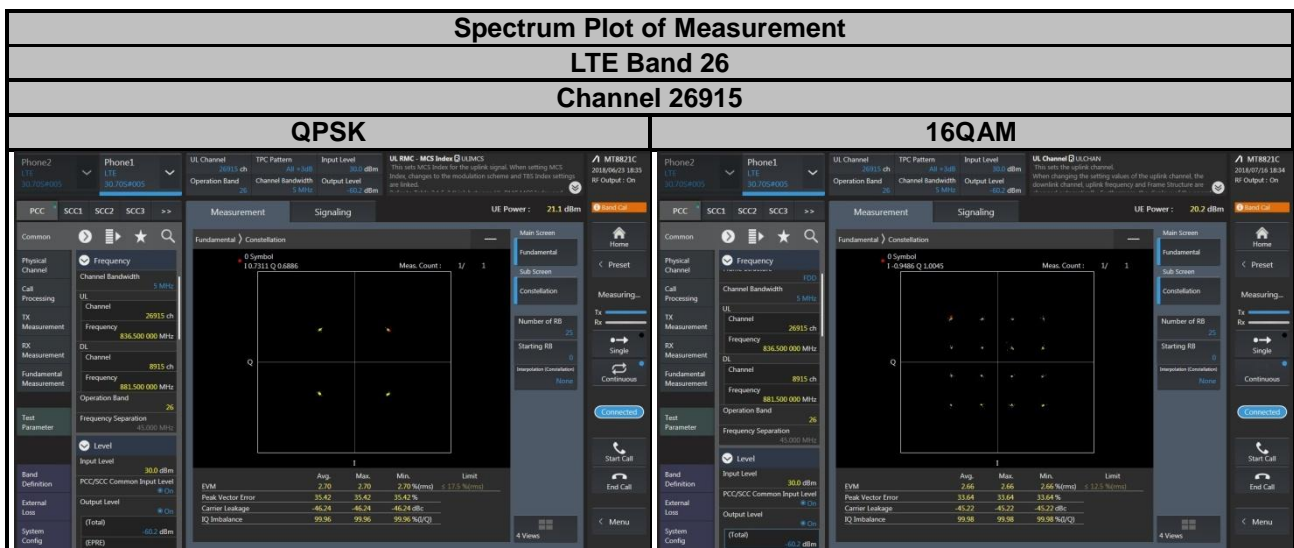
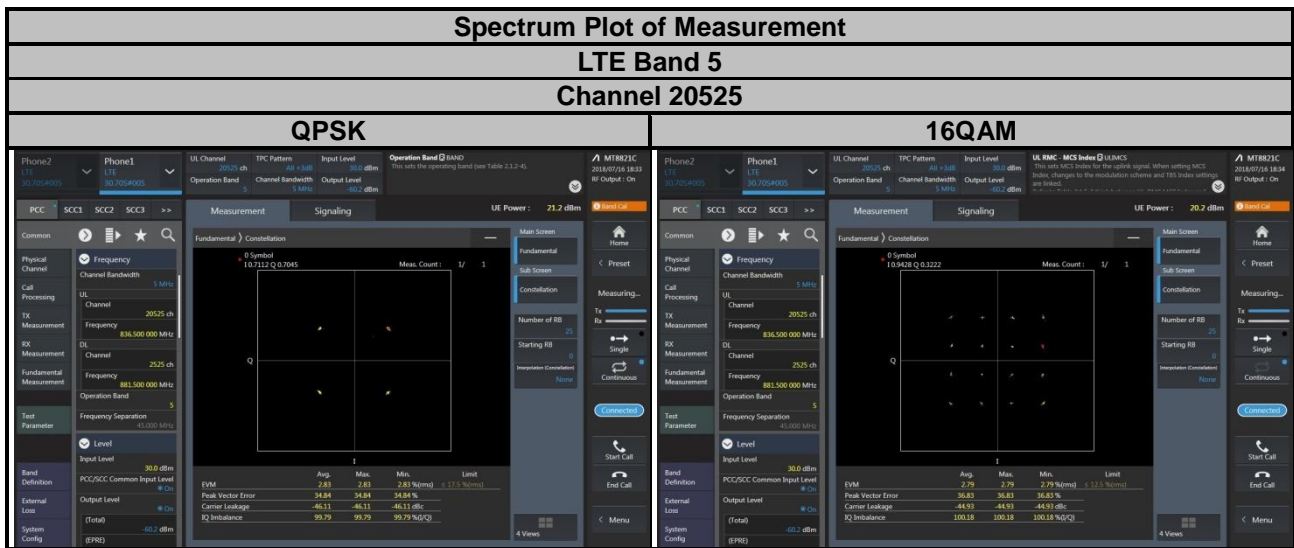
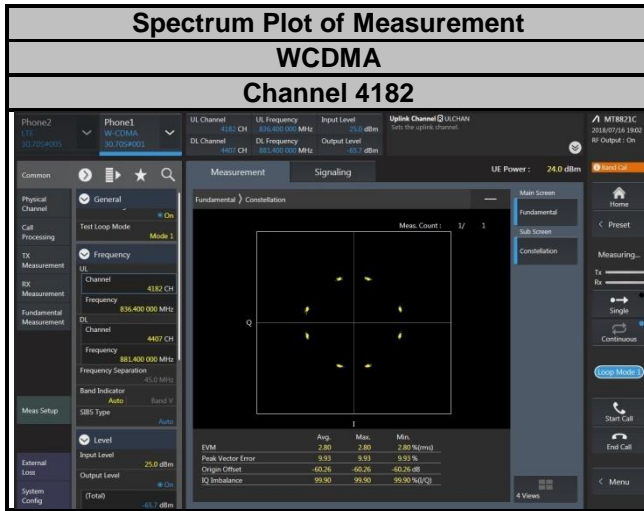

4.3 Frequency Stability Measurement

4.3.1 Limits of Frequency Stability Measurement

1.5 ppm is for base and fixed station. 2.5 ppm is for mobile station.

4.3.2 Test Procedure

- a. Device is placed at the oven room. The oven room could control the temperatures and humidity. Power warm up is at least 15 min and power applied should perform before recording frequency error.
- b. EUT is connected the external power supply to control the DC input power. The test voltage range is from minimum to maximum working voltage. Each step shall be record the frequency error rate.
- c. The temperature range step is 10 degrees in this test items. All temperature levels shall be hold the ± 0.5 °C during the measurement testing. The each temperature step shall be at least 0.5 hours, consider the EUT could be test under the stability condition.

NOTE: The frequency error was recorded frequency error from the communication simulator.

4.3.3 Test Setup

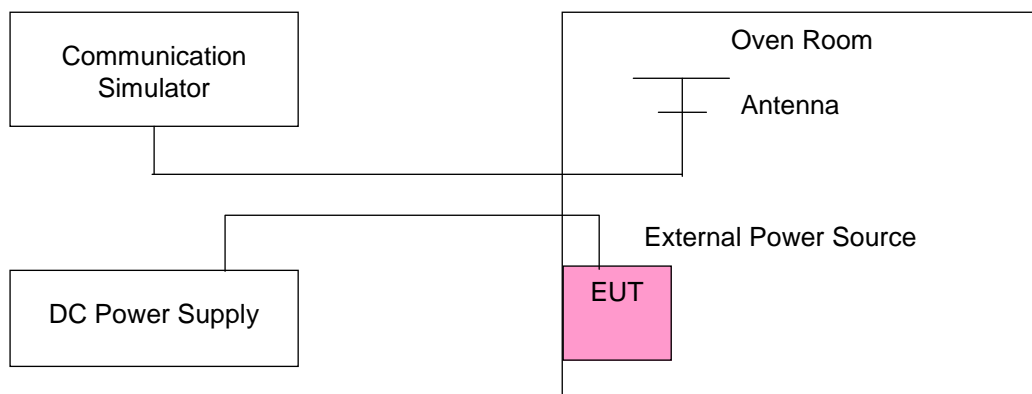

4.3.4 Test Results

Frequency Error vs. Voltage

Voltage (Volts)	WCDMA				Limit (ppm)
	Low Channel		High Channel		
	Frequency (MHz)	Frequency Error (ppm)	Frequency (MHz)	Frequency Error (ppm)	
3.3	826.400004	0.004	846.600002	0.002	2.5
3.135	826.400002	0.003	846.600001	0.002	2.5
4.4	826.400001	0.001	846.600004	0.004	2.5

Note: The applicant defined the normal working voltage of the battery is from 3.135 Vdc to 4.4 Vdc.

Frequency Error vs. Temperature

Temp. (°C)	WCDMA				Limit (ppm)
	Low Channel		High Channel		
	Frequency (MHz)	Frequency Error (ppm)	Frequency (MHz)	Frequency Error (ppm)	
-30	826.400001	0.002	846.600003	0.003	2.5
-20	826.400003	0.004	846.600002	0.002	2.5
-10	826.400002	0.003	846.600004	0.004	2.5
0	826.400004	0.005	846.600002	0.002	2.5
10	826.400003	0.004	846.600002	0.003	2.5
20	826.399996	-0.004	846.599997	-0.004	2.5
30	826.399998	-0.003	846.599997	-0.004	2.5
40	826.399998	-0.002	846.599996	-0.004	2.5
50	826.399997	-0.004	846.599999	-0.001	2.5
55	826.399998	-0.002	846.599999	-0.001	2.5

Frequency Error vs. Voltage

Voltage (Volts)	LTE Band 5				Limit (ppm)
	Channel Bandwidth: 1.4 MHz				
	Low Channel		High Channel		
	Frequency (MHz)	Frequency Error (ppm)	Frequency (MHz)	Frequency Error (ppm)	
3.3	824.700002	0.002	848.300002	0.002	2.5
3.135	824.700001	0.001	848.300003	0.003	2.5
4.4	824.700001	0.001	848.300002	0.003	2.5

Note: The applicant defined the normal working voltage of the battery is from 3.135 Vdc to 4.4 Vdc.

Frequency Error vs. Temperature

Temp. (°C)	LTE Band 5				Limit (ppm)
	Channel Bandwidth: 1.4 MHz				
	Low Channel		High Channel		
	Frequency (MHz)	Frequency Error (ppm)	Frequency (MHz)	Frequency Error (ppm)	
-30	824.700001	0.001	848.300004	0.004	2.5
-20	824.700001	0.002	848.300002	0.002	2.5
-10	824.700002	0.002	848.300003	0.003	2.5
0	824.700001	0.002	848.300002	0.002	2.5
10	824.700001	0.002	848.300003	0.003	2.5
20	824.699996	-0.005	848.299996	-0.005	2.5
30	824.699997	-0.004	848.299999	-0.001	2.5
40	824.699998	-0.003	848.299997	-0.004	2.5
50	824.699997	-0.004	848.299996	-0.004	2.5
55	824.699999	-0.001	848.299996	-0.005	2.5

Frequency Error vs. Voltage

Voltage (Volts)	LTE Band 5				Limit (ppm)
	Channel Bandwidth: 3 MHz				
	Low Channel		High Channel		
	Frequency (MHz)	Frequency Error (ppm)	Frequency (MHz)	Frequency Error (ppm)	
3.3	825.500003	0.004	847.500003	0.004	2.5
3.135	825.500003	0.004	847.500003	0.004	2.5
4.4	825.500003	0.004	847.500003	0.003	2.5

Note: The applicant defined the normal working voltage of the battery is from 3.135 Vdc to 4.4 Vdc.

Frequency Error vs. Temperature

Temp. (°C)	LTE Band 5				Limit (ppm)
	Channel Bandwidth: 3 MHz				
	Low Channel		High Channel		
	Frequency (MHz)	Frequency Error (ppm)	Frequency (MHz)	Frequency Error (ppm)	
-30	825.500001	0.002	847.500004	0.004	2.5
-20	825.500004	0.004	847.500003	0.004	2.5
-10	825.500004	0.005	847.500002	0.003	2.5
0	825.500003	0.004	847.500003	0.003	2.5
10	825.500003	0.003	847.500002	0.002	2.5
20	825.499997	-0.004	847.499999	-0.001	2.5
30	825.499998	-0.002	847.499998	-0.002	2.5
40	825.499998	-0.002	847.499998	-0.002	2.5
50	825.499997	-0.004	847.499998	-0.002	2.5
55	825.499997	-0.004	847.499999	-0.002	2.5

Frequency Error vs. Voltage

Voltage (Volts)	LTE Band 5				Limit (ppm)
	Channel Bandwidth: 5 MHz				
	Low Channel		High Channel		
	Frequency (MHz)	Frequency Error (ppm)	Frequency (MHz)	Frequency Error (ppm)	
3.3	826.500003	0.004	846.500001	0.002	2.5
3.135	826.500001	0.002	846.500003	0.003	2.5
4.4	826.500002	0.003	846.500002	0.002	2.5

Note: The applicant defined the normal working voltage of the battery is from 3.135 Vdc to 4.4 Vdc.

Frequency Error vs. Temperature

Temp. (°C)	LTE Band 5				Limit (ppm)
	Channel Bandwidth: 5 MHz				
	Low Channel		High Channel		
	Frequency (MHz)	Frequency Error (ppm)	Frequency (MHz)	Frequency Error (ppm)	
-30	826.500002	0.002	846.500003	0.004	2.5
-20	826.500003	0.004	846.500004	0.004	2.5
-10	826.500003	0.004	846.500003	0.003	2.5
0	826.500004	0.005	846.500002	0.002	2.5
10	826.500004	0.004	846.500002	0.003	2.5
20	826.499997	-0.003	846.499996	-0.004	2.5
30	826.499999	-0.001	846.499997	-0.004	2.5
40	826.499998	-0.003	846.499999	-0.001	2.5
50	826.499996	-0.005	846.499997	-0.003	2.5
55	826.499997	-0.004	846.499997	-0.004	2.5

Frequency Error vs. Voltage

Voltage (Volts)	LTE Band 5				Limit (ppm)
	Channel Bandwidth: 10 MHz				
	Low Channel		High Channel		
	Frequency (MHz)	Frequency Error (ppm)	Frequency (MHz)	Frequency Error (ppm)	
3.3	829.000002	0.002	844.000003	0.004	2.5
3.135	829.000002	0.002	844.000002	0.002	2.5
4.4	829.000004	0.004	844.000002	0.002	2.5

Note: The applicant defined the normal working voltage of the battery is from 3.135 Vdc to 4.4 Vdc.

Frequency Error vs. Temperature

Temp. (°C)	LTE Band 5				Limit (ppm)
	Channel Bandwidth: 10 MHz				
	Low Channel		High Channel		
	Frequency (MHz)	Frequency Error (ppm)	Frequency (MHz)	Frequency Error (ppm)	
-30	829.000002	0.002	844.000002	0.002	2.5
-20	829.000001	0.001	844.000003	0.004	2.5
-10	829.000003	0.003	844.000003	0.003	2.5
0	829.000001	0.001	844.000001	0.002	2.5
10	829.000001	0.002	844.000002	0.003	2.5
20	828.999999	-0.001	843.999998	-0.002	2.5
30	828.999998	-0.003	843.999997	-0.003	2.5
40	828.999999	-0.001	843.999996	-0.004	2.5
50	828.999997	-0.004	843.999998	-0.003	2.5
55	828.999999	-0.001	843.999997	-0.003	2.5

Frequency Error vs. Voltage

Voltage (Volts)	LTE Band 26				Limit (ppm)
	Channel Bandwidth: 1.4 MHz				
	Low Channel		High Channel		
	Frequency (MHz)	Frequency Error (ppm)	Frequency (MHz)	Frequency Error (ppm)	
3.3	824.700002	0.003	848.300002	0.002	2.5
3.135	824.700003	0.004	848.300003	0.004	2.5
4.4	824.700004	0.005	848.300004	0.005	2.5

Note: The applicant defined the normal working voltage of the battery is from 3.135 Vdc to 4.4 Vdc.

Frequency Error vs. Temperature

Temp. (°C)	LTE Band 26				Limit (ppm)
	Channel Bandwidth: 1.4 MHz				
	Low Channel		High Channel		
	Frequency (MHz)	Frequency Error (ppm)	Frequency (MHz)	Frequency Error (ppm)	
-30	824.700004	0.005	848.300004	0.004	2.5
-20	824.700002	0.002	848.300002	0.003	2.5
-10	824.700002	0.002	848.300003	0.004	2.5
0	824.700003	0.003	848.300001	0.002	2.5
10	824.700002	0.003	848.300004	0.004	2.5
20	824.699999	-0.002	848.299997	-0.004	2.5
30	824.699998	-0.003	848.299998	-0.003	2.5
40	824.699997	-0.003	848.299997	-0.004	2.5
50	824.699996	-0.005	848.299997	-0.004	2.5
55	824.699997	-0.004	848.299998	-0.003	2.5

Frequency Error vs. Voltage

Voltage (Volts)	LTE Band 26				Limit (ppm)
	Channel Bandwidth: 3 MHz				
	Low Channel		High Channel		
	Frequency (MHz)	Frequency Error (ppm)	Frequency (MHz)	Frequency Error (ppm)	
3.3	825.500001	0.001	847.500003	0.004	2.5
3.135	825.500001	0.001	847.500001	0.001	2.5
4.4	825.500001	0.001	847.500004	0.004	2.5

Note: The applicant defined the normal working voltage of the battery is from 3.135 Vdc to 4.4 Vdc.

Frequency Error vs. Temperature

Temp. (°C)	LTE Band 26				Limit (ppm)
	Channel Bandwidth: 3 MHz				
	Low Channel		High Channel		
	Frequency (MHz)	Frequency Error (ppm)	Frequency (MHz)	Frequency Error (ppm)	
-30	825.500001	0.002	847.500003	0.004	2.5
-20	825.500002	0.002	847.500001	0.001	2.5
-10	825.500001	0.001	847.500003	0.004	2.5
0	825.500002	0.002	847.500004	0.004	2.5
10	825.500001	0.001	847.500003	0.004	2.5
20	825.499997	-0.004	847.499997	-0.004	2.5
30	825.499998	-0.003	847.499999	-0.001	2.5
40	825.499998	-0.002	847.499997	-0.004	2.5
50	825.499999	-0.001	847.499998	-0.002	2.5
55	825.499998	-0.002	847.499996	-0.004	2.5

Frequency Error vs. Voltage

Voltage (Volts)	LTE Band 26				Limit (ppm)
	Channel Bandwidth: 5 MHz				
	Low Channel		High Channel		
	Frequency (MHz)	Frequency Error (ppm)	Frequency (MHz)	Frequency Error (ppm)	
3.3	826.500001	0.002	846.500002	0.002	2.5
3.135	826.500002	0.002	846.500002	0.003	2.5
4.4	826.500003	0.004	846.500004	0.004	2.5

Note: The applicant defined the normal working voltage of the battery is from 3.135 Vdc to 4.4 Vdc.

Frequency Error vs. Temperature

Temp. (°C)	LTE Band 26				Limit (ppm)
	Channel Bandwidth: 5 MHz				
	Low Channel		High Channel		
	Frequency (MHz)	Frequency Error (ppm)	Frequency (MHz)	Frequency Error (ppm)	
-30	826.500003	0.003	846.500002	0.002	2.5
-20	826.500004	0.005	846.500002	0.002	2.5
-10	826.500001	0.001	846.500001	0.001	2.5
0	826.500003	0.004	846.500003	0.004	2.5
10	826.500002	0.002	846.500002	0.002	2.5
20	826.499997	-0.003	846.499998	-0.002	2.5
30	826.499996	-0.005	846.499998	-0.003	2.5
40	826.499999	-0.001	846.499998	-0.003	2.5
50	826.499997	-0.004	846.499997	-0.003	2.5
55	826.499997	-0.003	846.499998	-0.003	2.5

Frequency Error vs. Voltage

Voltage (Volts)	LTE Band 26				Limit (ppm)
	Channel Bandwidth: 10 MHz				
	Low Channel		High Channel		
	Frequency (MHz)	Frequency Error (ppm)	Frequency (MHz)	Frequency Error (ppm)	
3.3	829.000004	0.005	844.000002	0.003	2.5
3.135	829.000003	0.003	844.000001	0.002	2.5
4.4	829.000002	0.002	844.000001	0.001	2.5

Note: The applicant defined the normal working voltage of the battery is from 3.135 Vdc to 4.4 Vdc.

Frequency Error vs. Temperature

Temp. (°C)	LTE Band 26				Limit (ppm)
	Channel Bandwidth: 10 MHz				
	Low Channel		High Channel		
	Frequency (MHz)	Frequency Error (ppm)	Frequency (MHz)	Frequency Error (ppm)	
-30	829.000001	0.002	844.000003	0.003	2.5
-20	829.000003	0.004	844.000003	0.003	2.5
-10	829.000003	0.004	844.000002	0.002	2.5
0	829.000003	0.004	844.000003	0.004	2.5
10	829.000003	0.004	844.000002	0.002	2.5
20	828.999998	-0.002	843.999997	-0.003	2.5
30	828.999998	-0.003	843.999996	-0.005	2.5
40	828.999998	-0.003	843.999997	-0.004	2.5
50	828.999997	-0.004	843.999997	-0.004	2.5
55	828.999998	-0.003	843.999999	-0.001	2.5

Frequency Error vs. Voltage

Voltage (Volts)	LTE Band 26				Limit (ppm)
	Channel Bandwidth: 15 MHz				
	Low Channel		High Channel		
	Frequency (MHz)	Frequency Error (ppm)	Frequency (MHz)	Frequency Error (ppm)	
3.3	831.500003	0.004	841.500003	0.004	2.5
3.135	831.500002	0.002	841.500004	0.004	2.5
4.4	831.500001	0.001	841.500002	0.002	2.5

Note: The applicant defined the normal working voltage of the battery is from 3.135 Vdc to 4.4 Vdc.

Frequency Error vs. Temperature

Temp. (°C)	LTE Band 26				Limit (ppm)
	Channel Bandwidth: 15 MHz				
	Low Channel		High Channel		
	Frequency (MHz)	Frequency Error (ppm)	Frequency (MHz)	Frequency Error (ppm)	
-30	831.500002	0.002	841.500003	0.003	2.5
-20	831.500003	0.003	841.500004	0.004	2.5
-10	831.500003	0.004	841.500003	0.003	2.5
0	831.500004	0.004	841.500002	0.002	2.5
10	831.500002	0.003	841.500003	0.003	2.5
20	831.499996	-0.004	841.499999	-0.001	2.5
30	831.499998	-0.003	841.499996	-0.005	2.5
40	831.499999	-0.001	841.499997	-0.004	2.5
50	831.499997	-0.003	841.499997	-0.004	2.5
55	831.499999	-0.002	841.499998	-0.002	2.5

4.4 Occupied Bandwidth Measurement

4.4.1 Test Procedure

The EUT makes a call to the communication simulator. All measurements were done at low, middle and high operational frequency range. The communication simulator station system controlled a EUT to export maximum output power under transmission mode and specific channel frequency. Use OBW measurement function of Spectrum analyzer to measure 99 % occupied bandwidth.

4.4.2 Test Setup

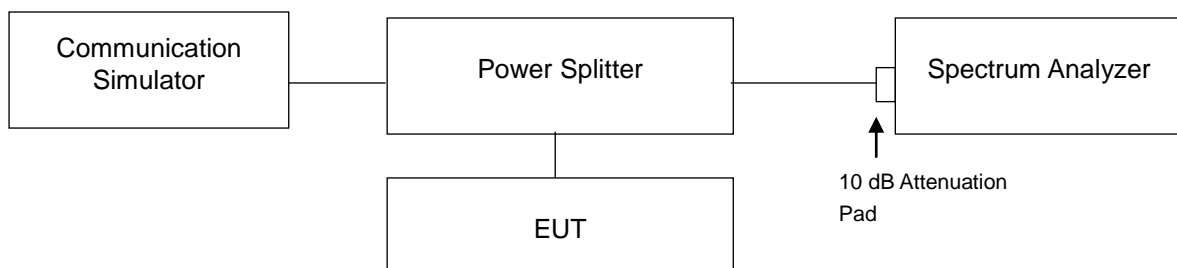

4.4.3 Test Result

Channel	Frequency (MHz)	99 % Occupied Bandwidth (MHz)
		WCDMA
4132	826.4	4.07
4182	836.4	4.09
4233	846.6	4.08

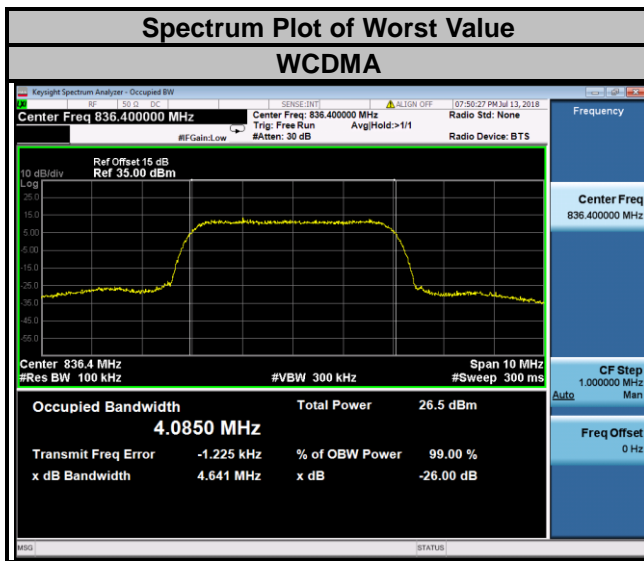

LTE Band 5							
Channel Bandwidth: 1.4 MHz				Channel Bandwidth: 3 MHz			
Channel	Frequency (MHz)	99 % Occupied Bandwidth (MHz)		Channel	Frequency (MHz)	99 % Occupied Bandwidth (MHz)	
		QPSK	16QAM			QPSK	16QAM
20407	824.7	1.09	1.09	20415	825.5	2.70	2.70
20525	836.5	1.09	1.09	20525	836.5	2.70	2.70
20643	848.3	1.09	1.09	20635	847.5	2.70	2.70

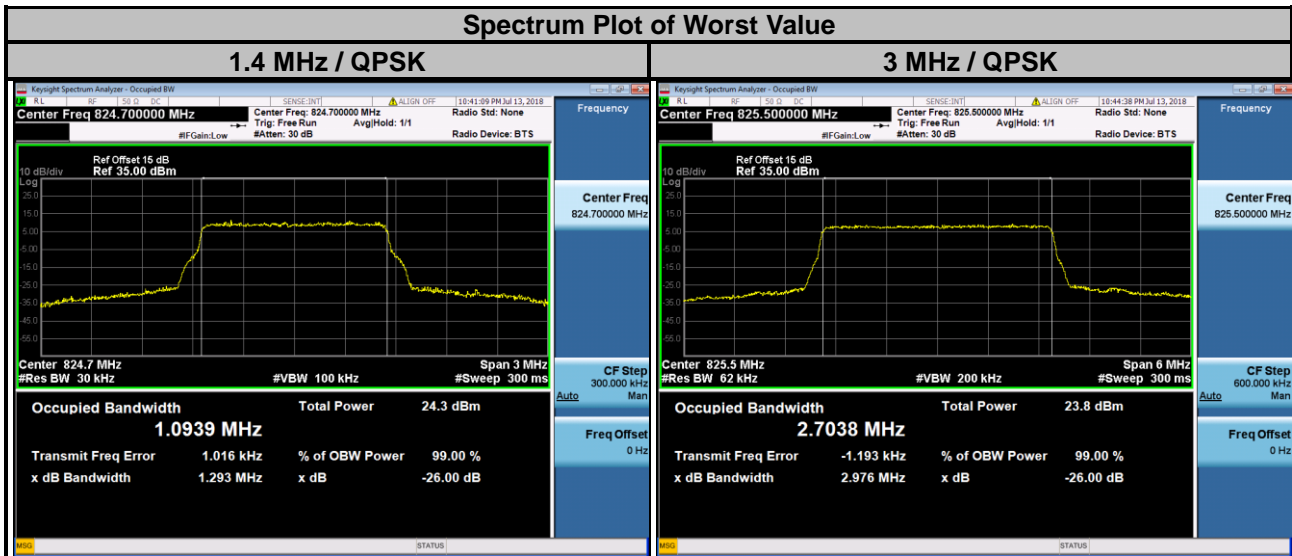

LTE Band 5							
Channel Bandwidth: 5 MHz				Channel Bandwidth: 10 MHz			
Channel	Frequency (MHz)	99 % Occupied Bandwidth (MHz)		Channel	Frequency (MHz)	99 % Occupied Bandwidth (MHz)	
		QPSK	16QAM			QPSK	16QAM
20425	826.5	4.49	4.50	20450	829.0	8.97	8.98
20525	836.5	4.50	4.50	20525	836.5	9.01	9.00
20625	846.5	4.49	4.49	20600	844.0	8.95	8.94

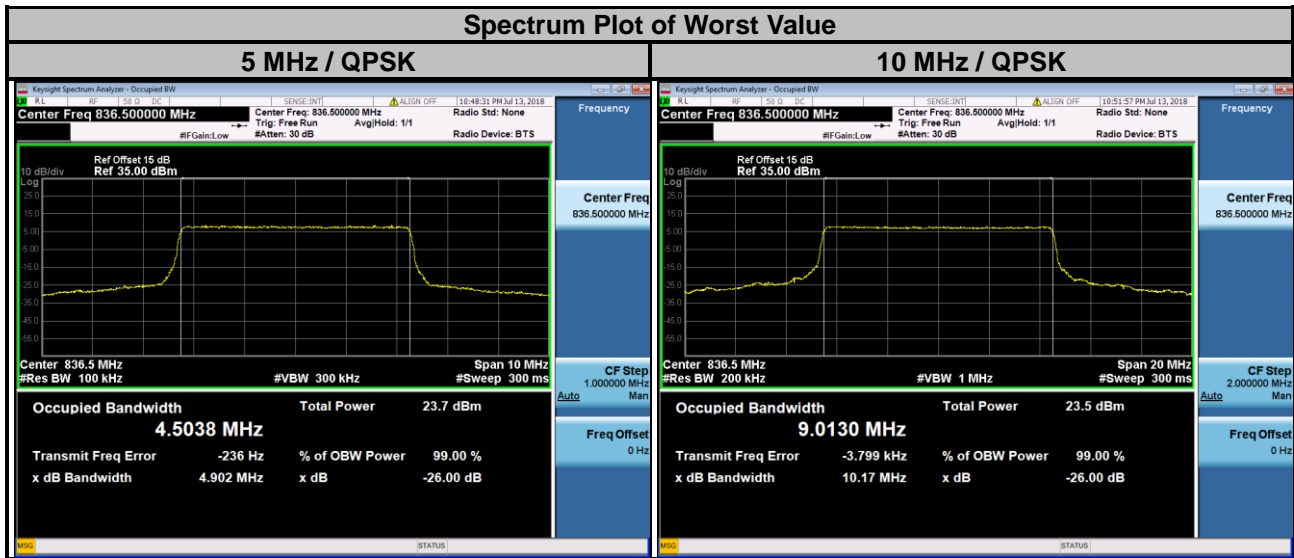

LTE Band 26							
Channel Bandwidth: 1.4 MHz				Channel Bandwidth: 3 MHz			
Channel	Frequency (MHz)	99 % Occupied Bandwidth (MHz)		Channel	Frequency (MHz)	99 % Occupied Bandwidth (MHz)	
		QPSK	16QAM			QPSK	16QAM
26797	824.7	1.09	1.09	26805	825.5	2.71	2.70
26915	836.5	1.09	1.09	26915	836.5	2.70	2.70
27033	848.3	1.09	1.09	27025	847.5	2.70	2.70

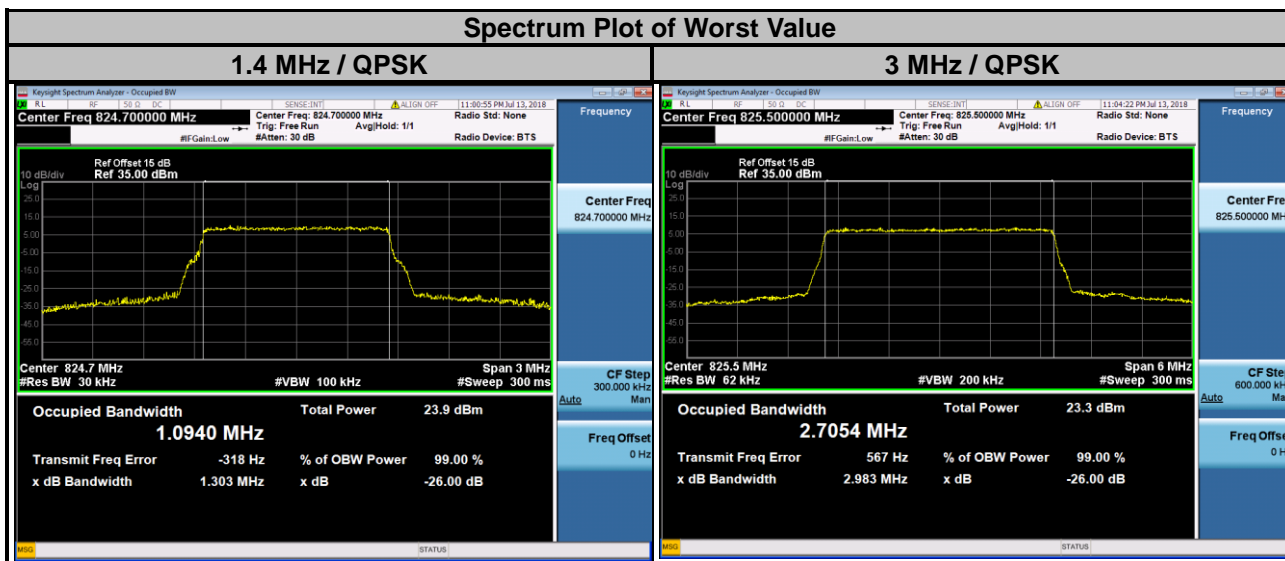

LTE Band 26

Channel Bandwidth: 5 MHz				Channel Bandwidth: 10 MHz			
Channel	Frequency (MHz)	99 % Occupied Bandwidth (MHz)		Channel	Frequency (MHz)	99 % Occupied Bandwidth (MHz)	
		QPSK	16QAM			QPSK	16QAM
26815	826.5	4.49	4.49	26840	829.0	8.97	8.97
26915	836.5	4.50	4.50	26915	836.5	9.01	9.00
27015	846.5	4.49	4.49	26990	844.0	8.95	8.94

Spectrum Plot of Worst Value

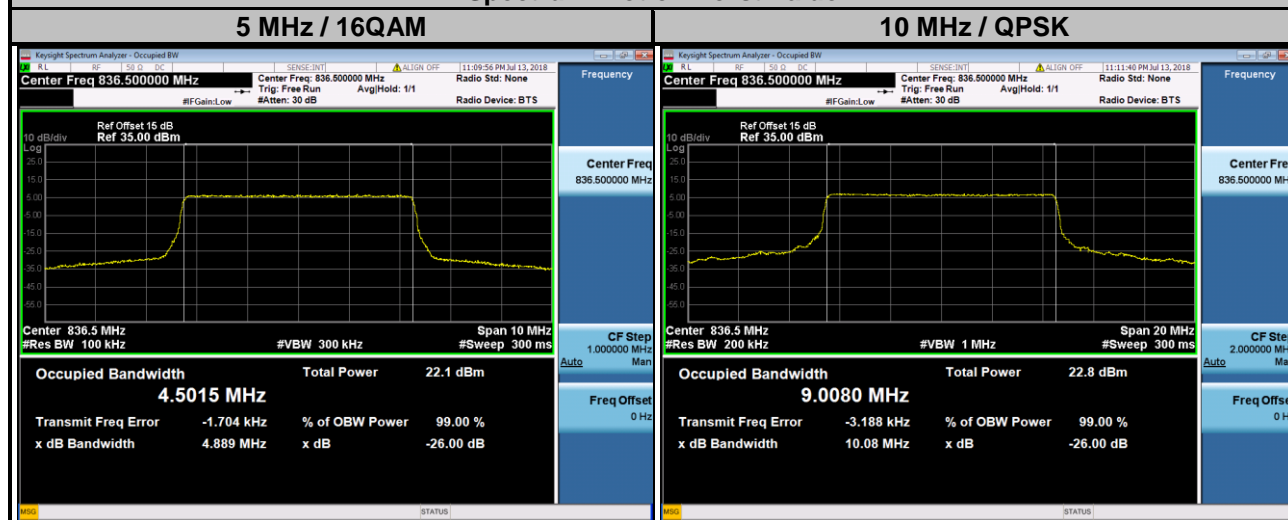

LTE Band 26			
Channel Bandwidth: 15 MHz			
Channel	Frequency (MHz)	99 % Occupied Bandwidth (MHz)	
		QPSK	16QAM
26865	831.5	13.46	13.46
26915	836.5	13.51	13.52
26965	841.5	13.43	13.44

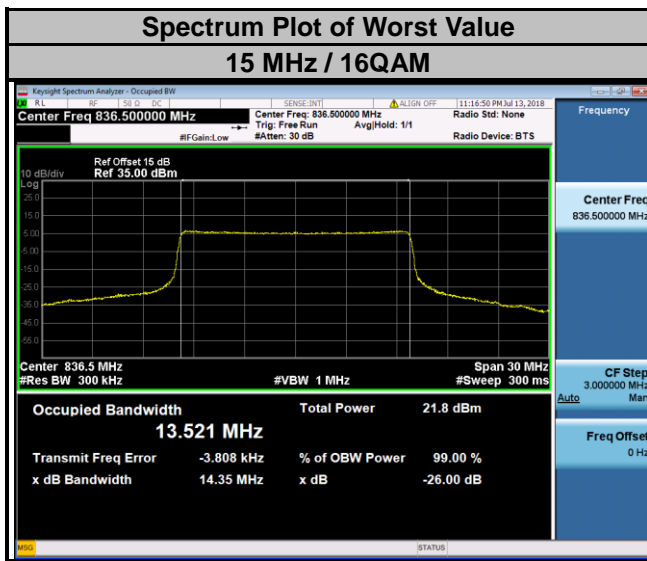

4.5 Band Edge Measurement

4.5.1 Limits of Band Edge Measurement

Power of any emission outside of the authorized operating frequency ranges must be attenuated below the transmitting power (P) by a factor of at least $43 + 10 \log(P)$ dB. In the 1 MHz bands immediately outside and adjacent to the frequency block a resolution bandwidth of at least one percent of the emission bandwidth of the fundamental emission of the transmitter may be employed.

4.5.2 Test Setup

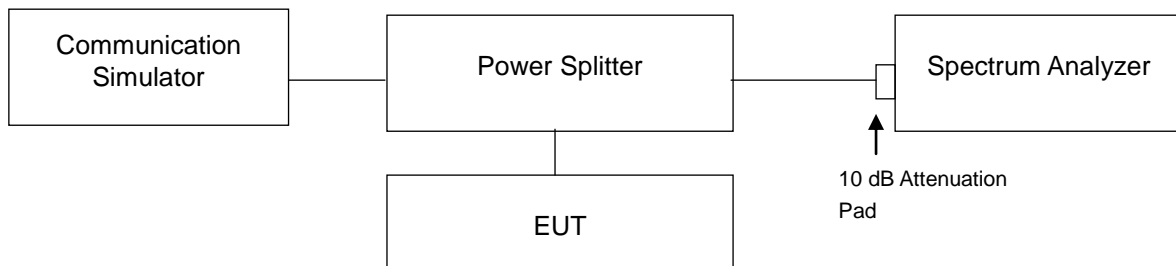

4.5.3 Test Procedures

- All measurements were done at low and high operational frequency range.
- The center frequency of spectrum is the band edge frequency and span is 5 MHz. RB of the spectrum is 100 kHz and VB of the spectrum is 300 kHz (WCDMA).
- The center frequency of spectrum is the band edge frequency and span is 1 MHz. RB of the spectrum is 30 kHz and VB of the spectrum is 100 kHz (LTE Bandwidth 1.4 MHz).
- The center frequency of spectrum is the band edge frequency and span is 1 MHz. RB of the spectrum is 62 kHz and VB of the spectrum is 200 kHz (LTE Bandwidth 3 MHz).
- The center frequency of spectrum is the band edge frequency and span is 1 MHz. RB of the spectrum is 100 kHz and VB of the spectrum is 300 kHz (LTE Bandwidth 5 MHz).
- The center frequency of spectrum is the band edge frequency and span is 1 MHz. RB of the spectrum is 200 kHz and VB of the spectrum is 1 MHz (LTE Bandwidth 10 MHz).
- The center frequency of spectrum is the band edge frequency and span is 1 MHz. RB of the spectrum is 300 kHz and VB of the spectrum is 1 MHz (LTE Bandwidth 15 MHz).
- Record the max trace plot into the test report.

4.5.4 Test Results

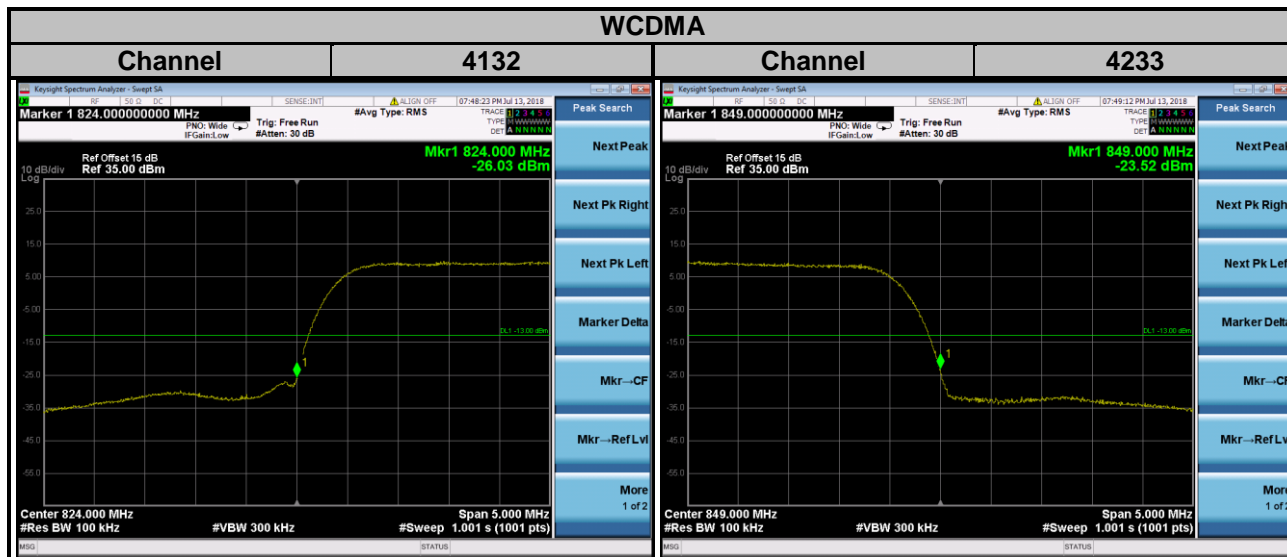

LTE Band 5
Channel Bandwidth: 1.4 MHz

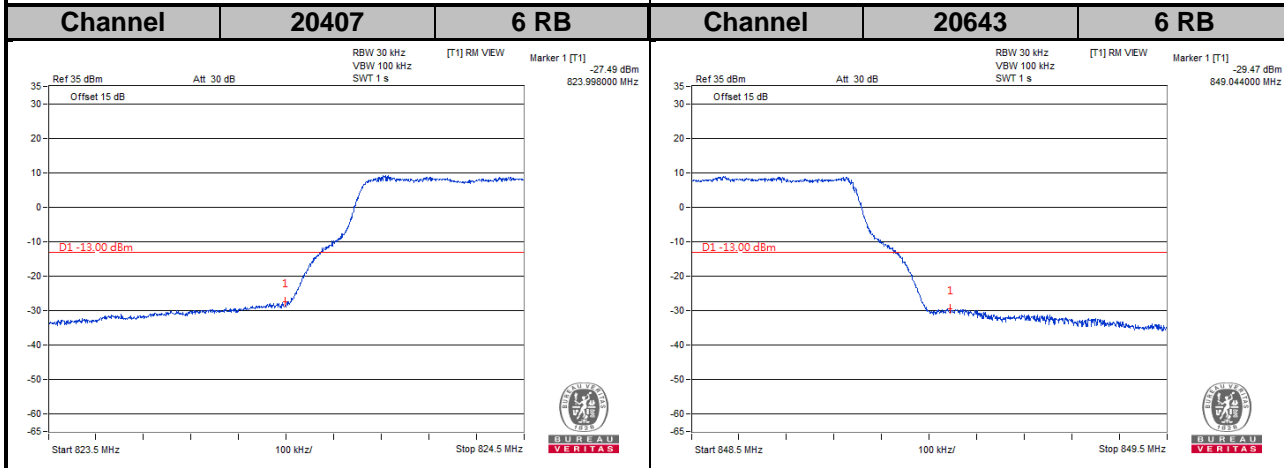
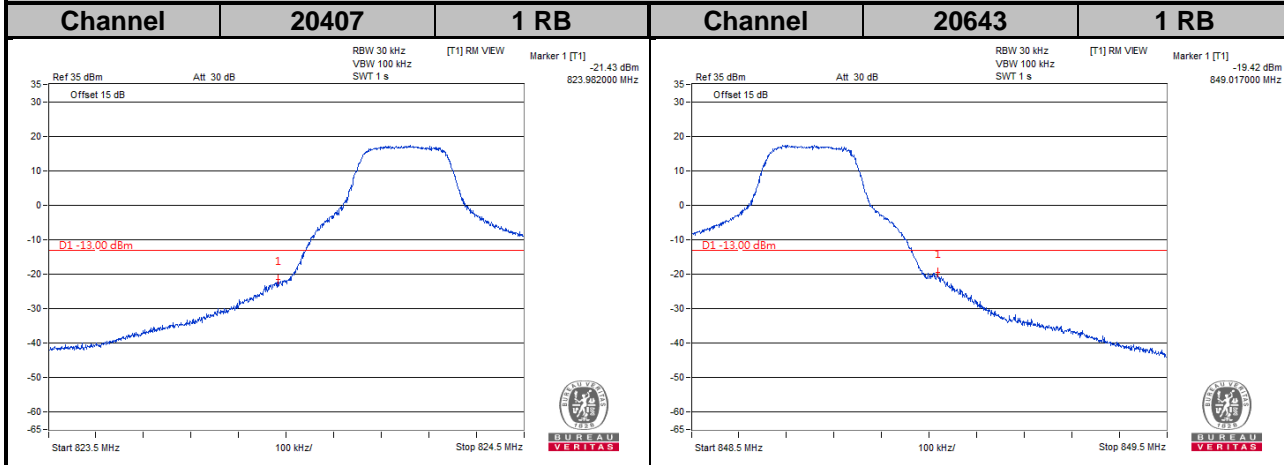

LTE Band 5

Channel Bandwidth: 3 MHz

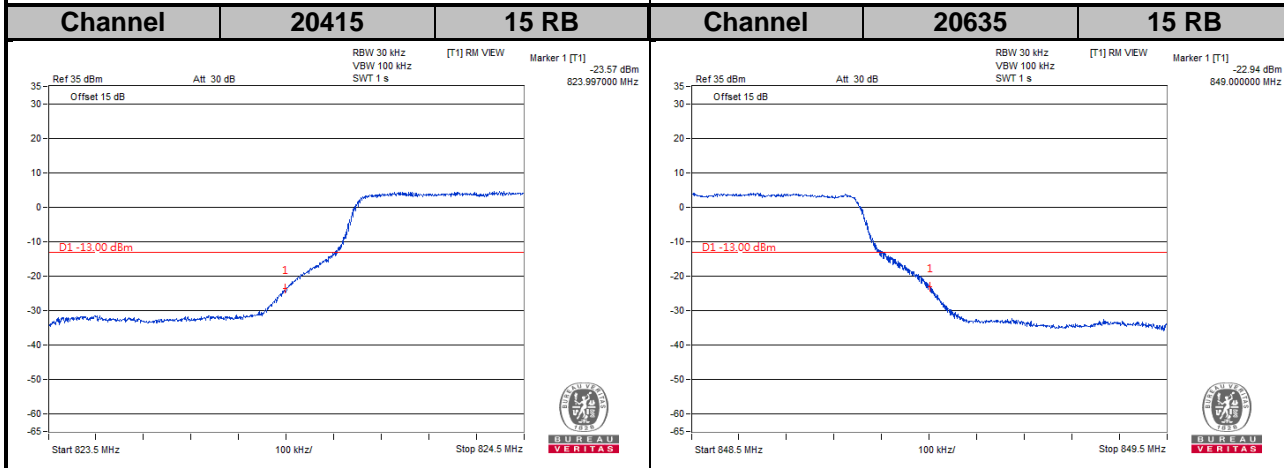
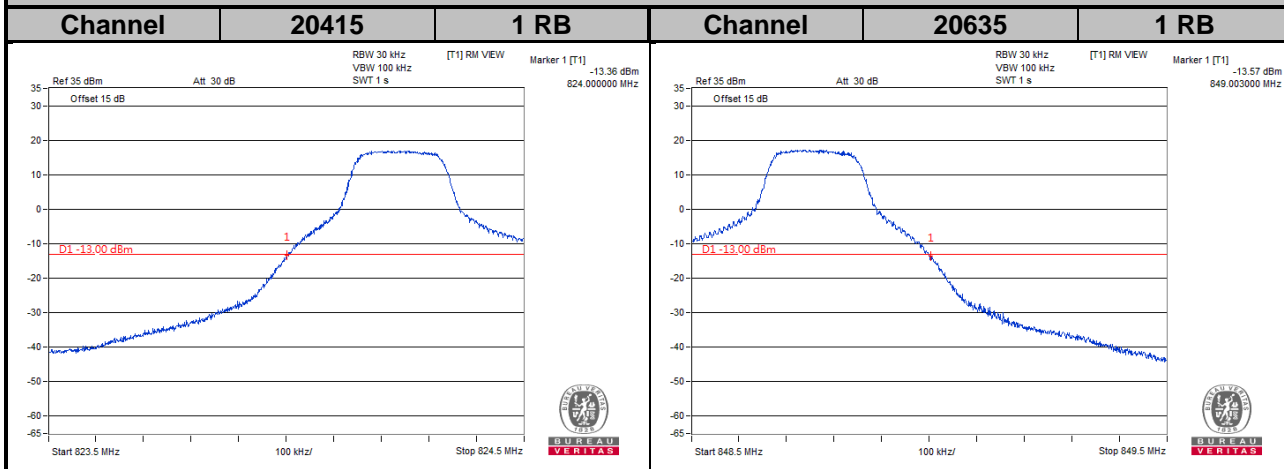

LTE Band 5
Channel Bandwidth: 5 MHz

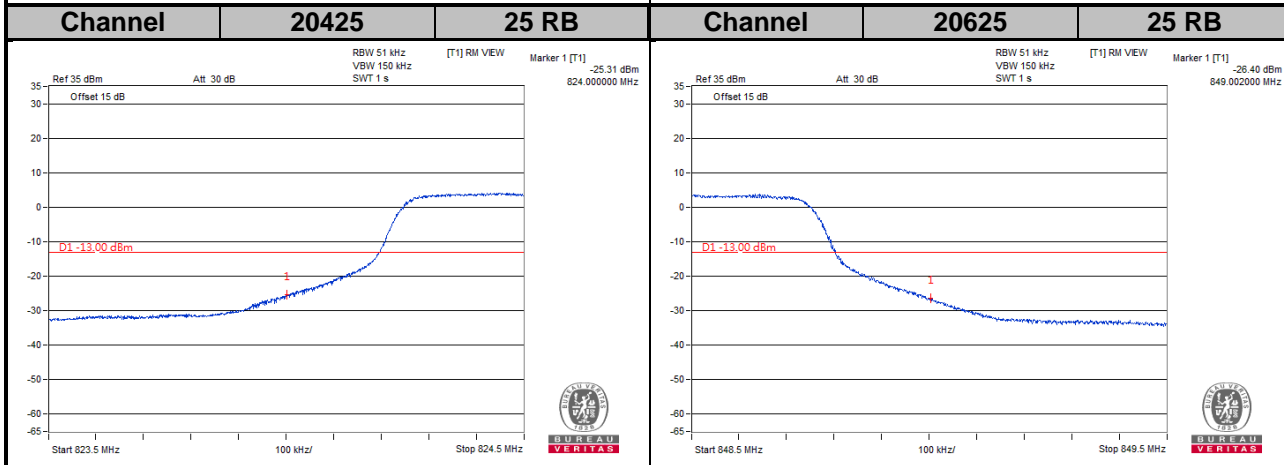
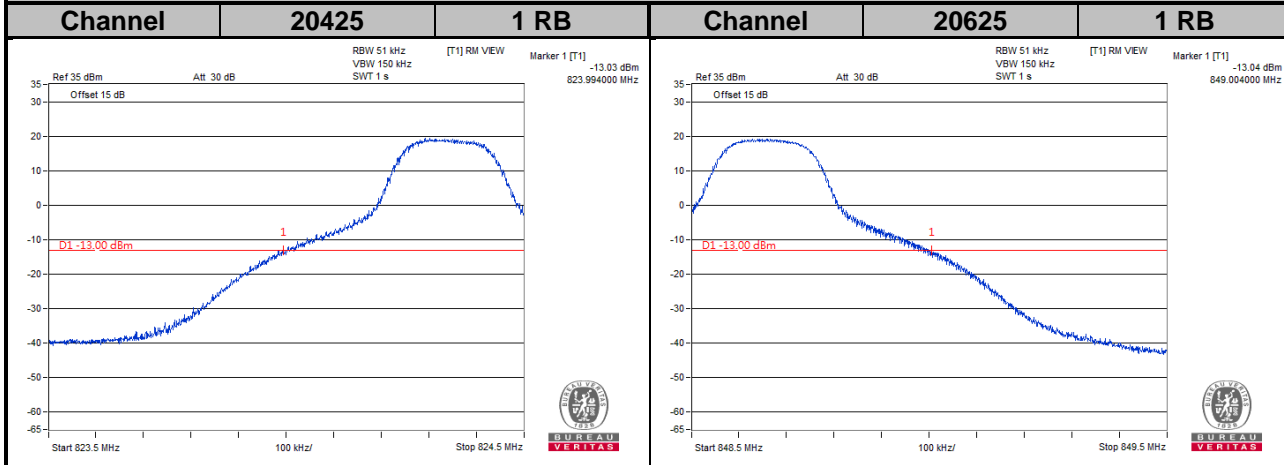

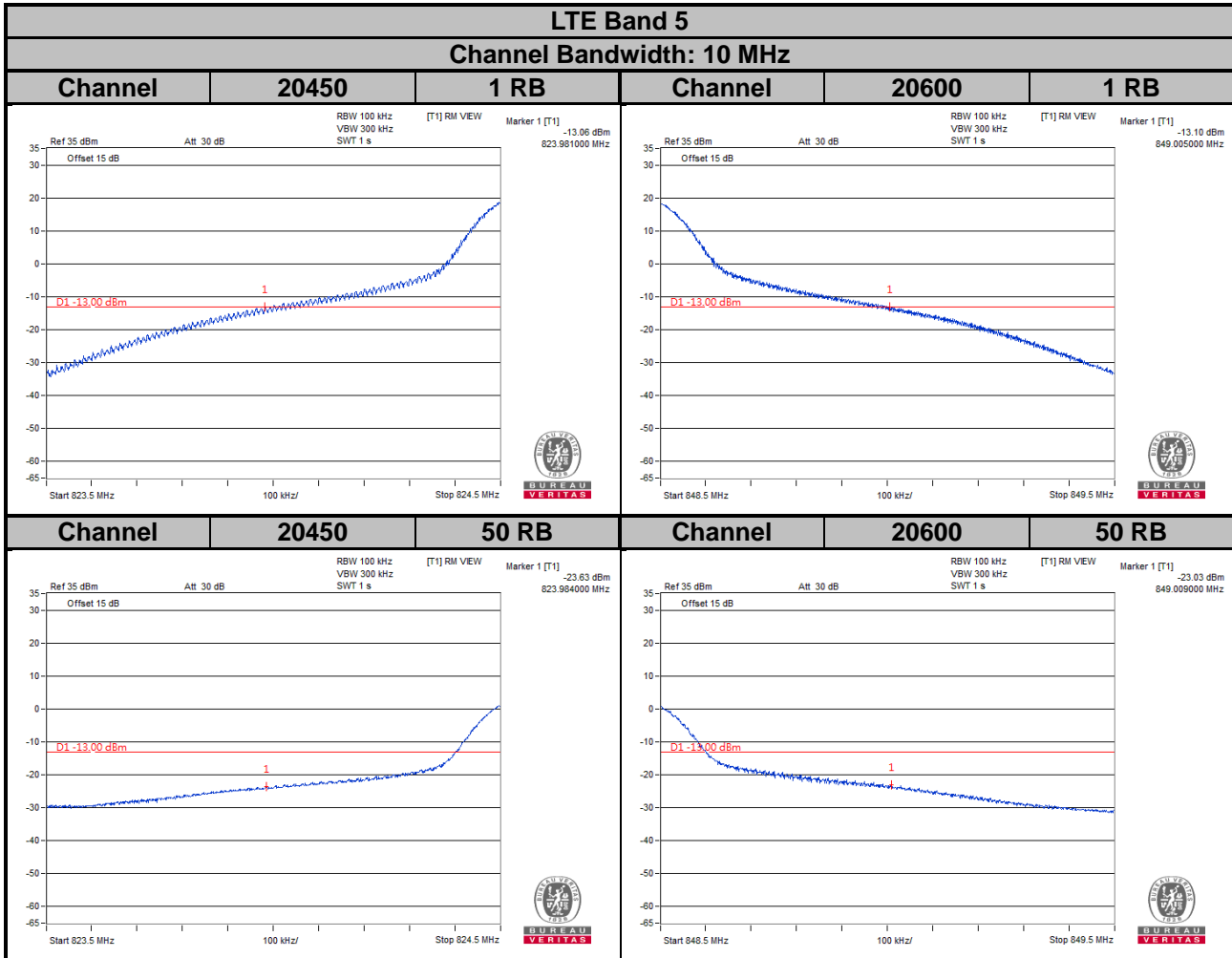

LTE Band 26
Channel Bandwidth: 1.4 MHz

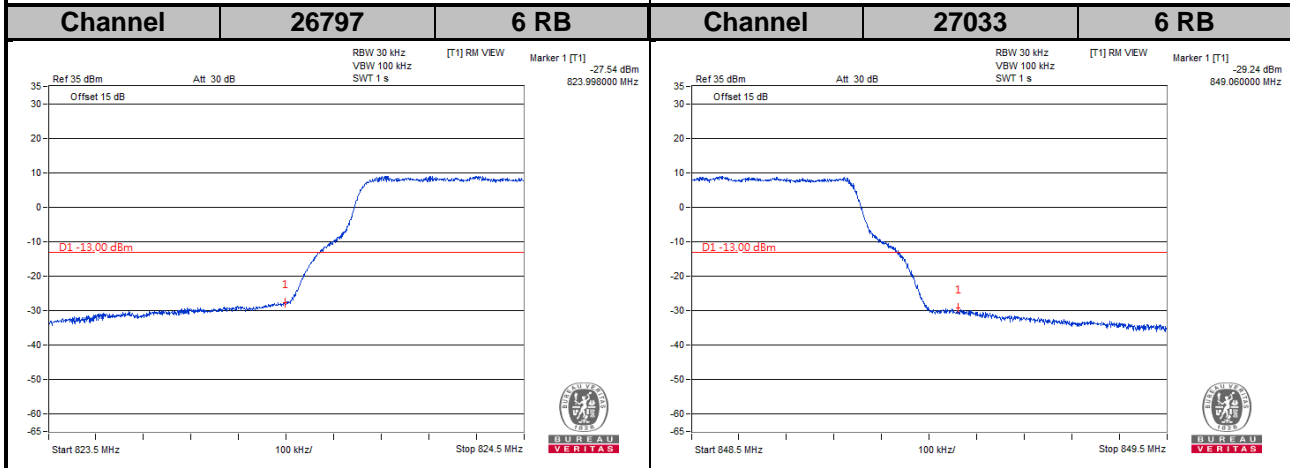
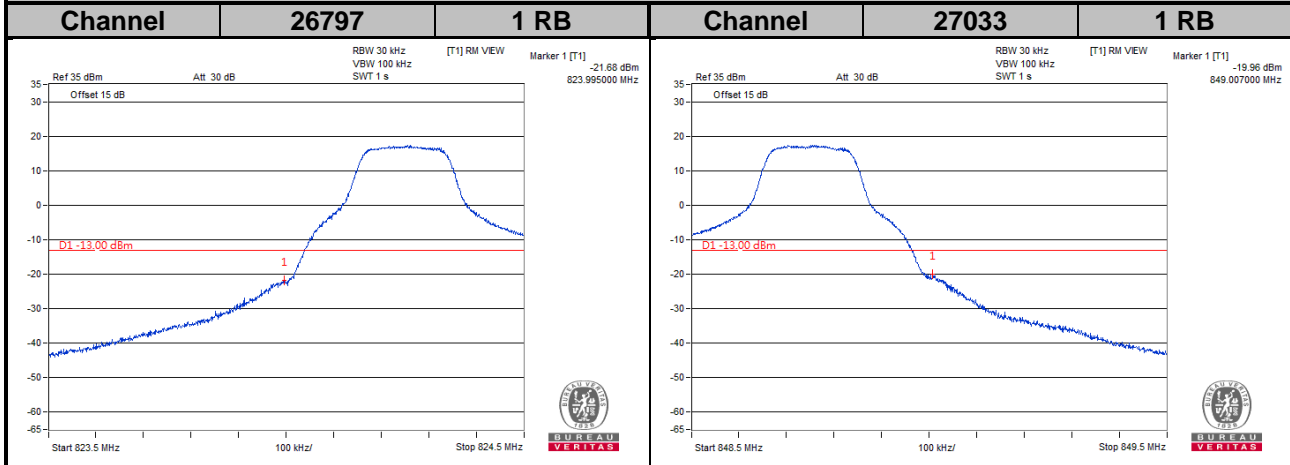

LTE Band 26
Channel Bandwidth: 3 MHz

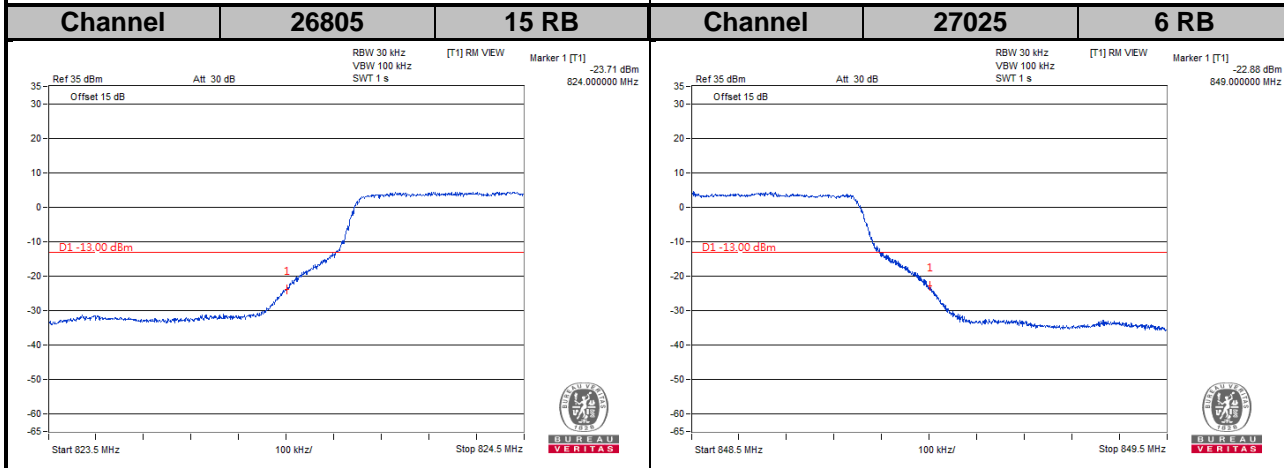
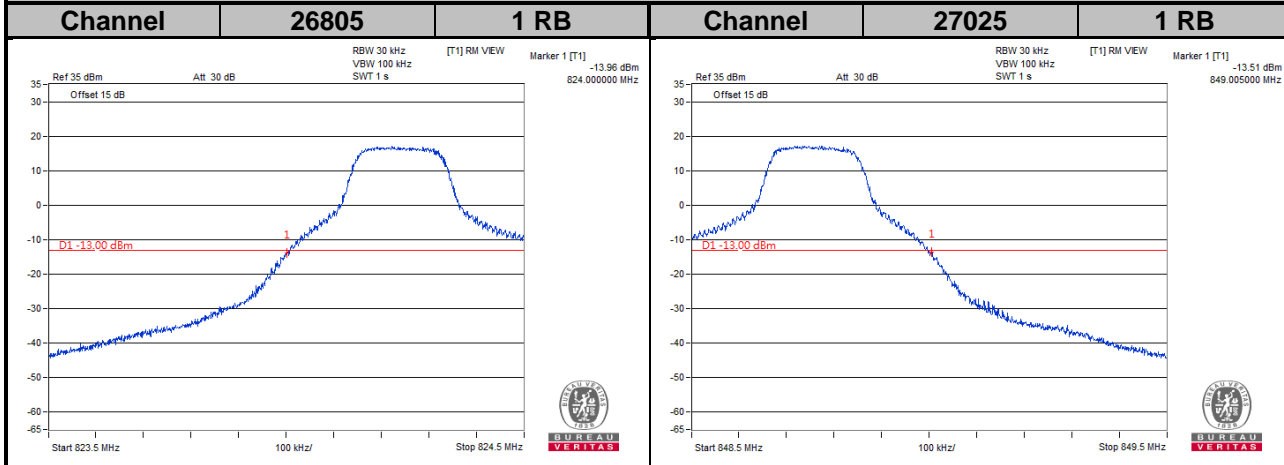

LTE Band 26
Channel Bandwidth: 5 MHz

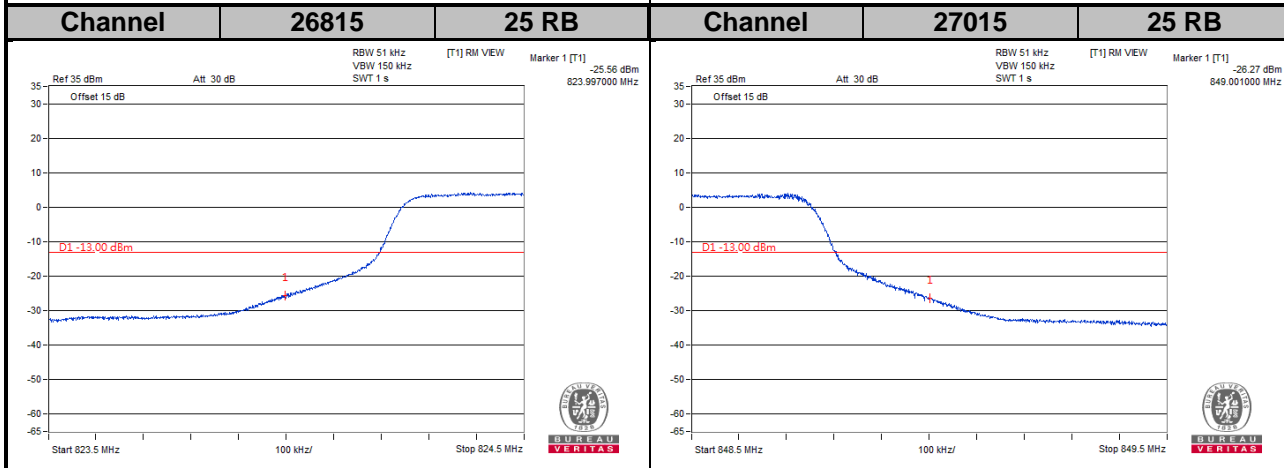
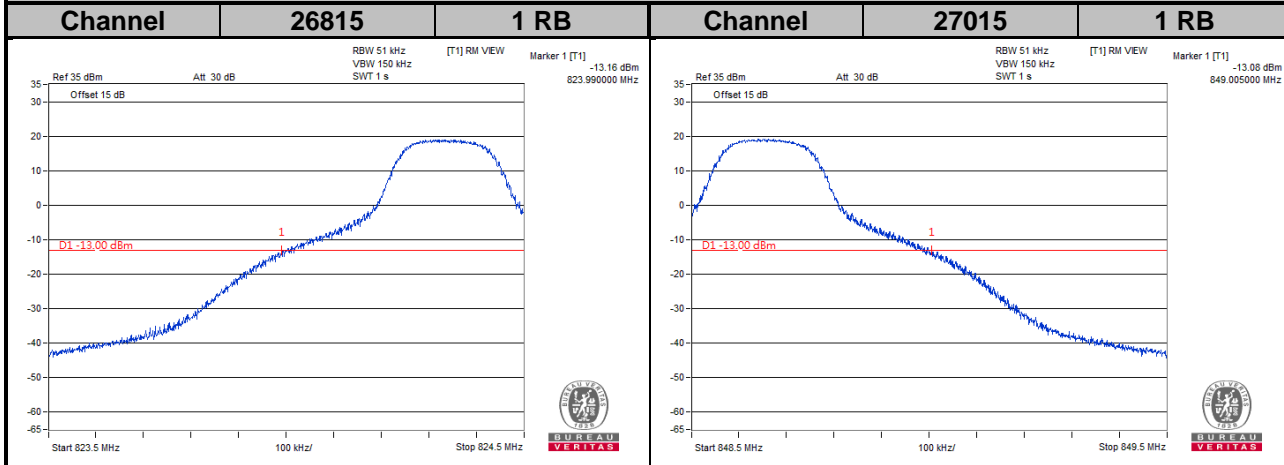

LTE Band 26
Channel Bandwidth: 10 MHz

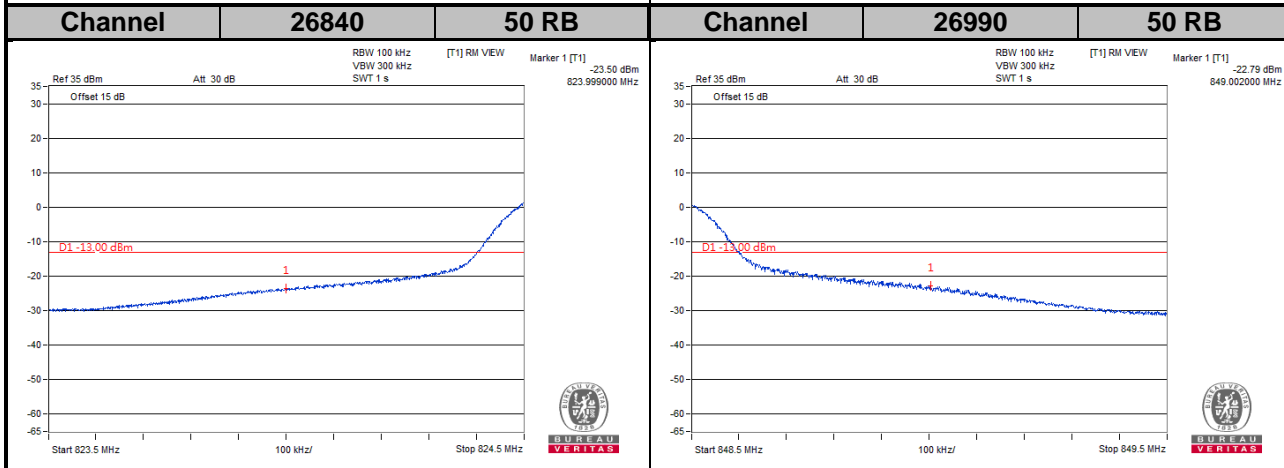
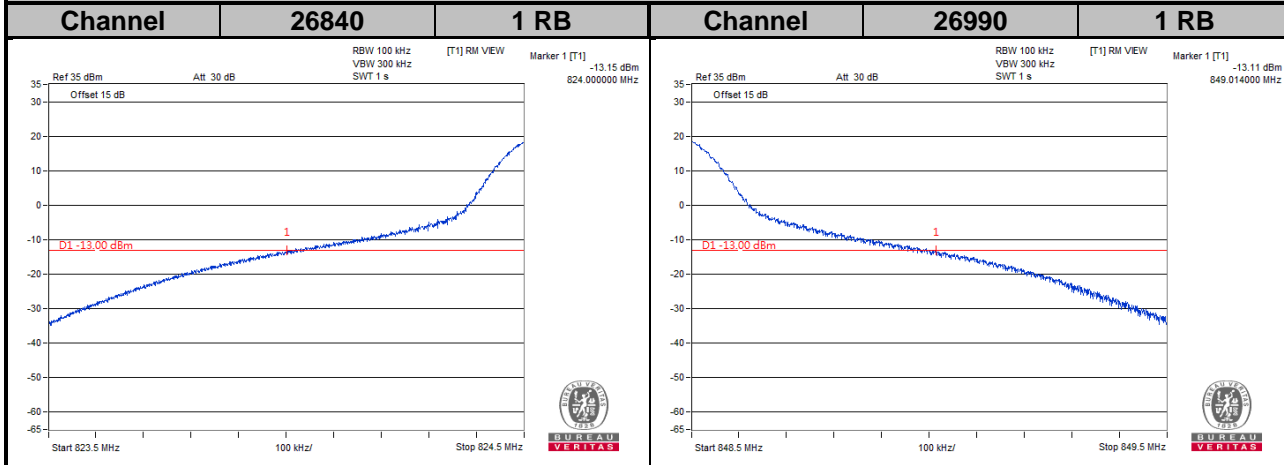

LTE Band 26
Channel Bandwidth: 15 MHz

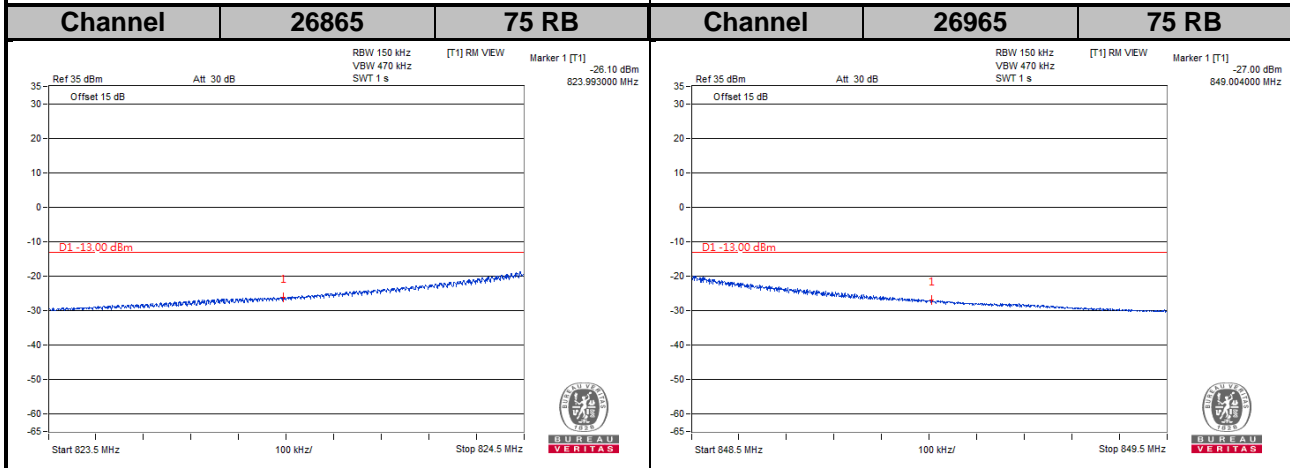
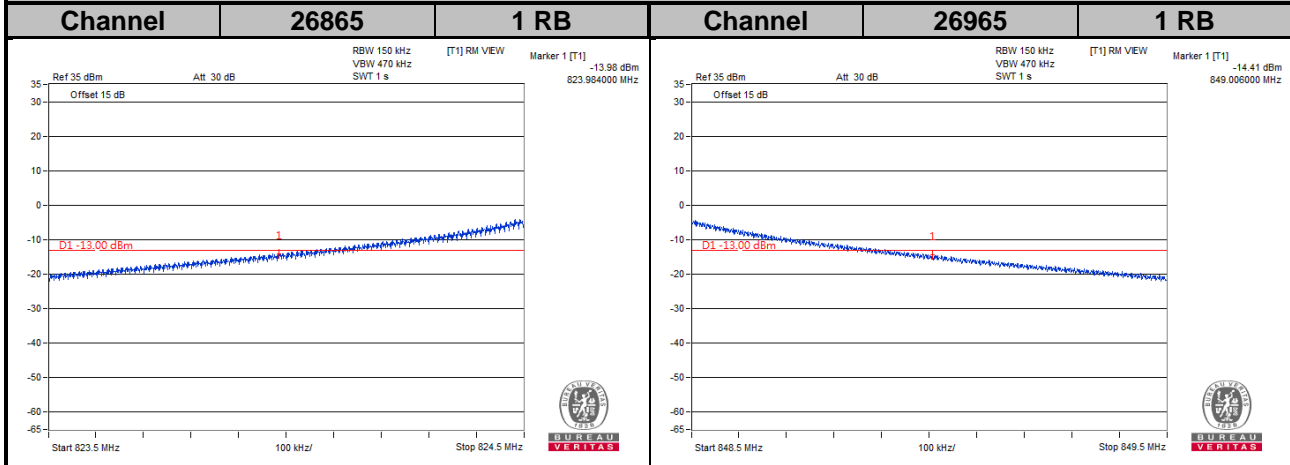

4.6 Peak to Average Ratio

4.6.1 Limits of Peak to Average Ratio Measurement

In measuring transmissions in this band using an average power technique, the peak to-average ratio (PAR) of the transmission may not exceed 13 dB.

4.6.2 Test Setup

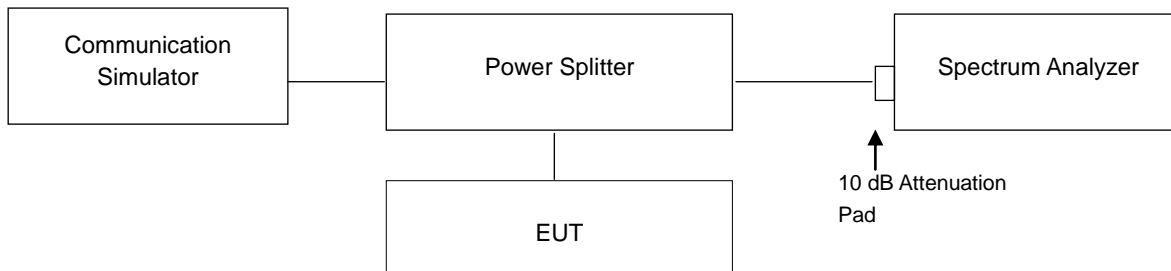

4.6.3 Test Procedures

1. Set resolution/measurement bandwidth \geq signal's occupied bandwidth;
2. Set the number of counts to a value that stabilizes the measured CCDF curve;
3. Record the maximum PAPR level associated with a probability of 0.1 %.

4.6.4 Test Results

Channel	Frequency (MHz)	Peak to Average Ratio (dB)
		WCDMA
4132	826.4	3.22
4182	836.4	3.32
4233	846.6	4.24

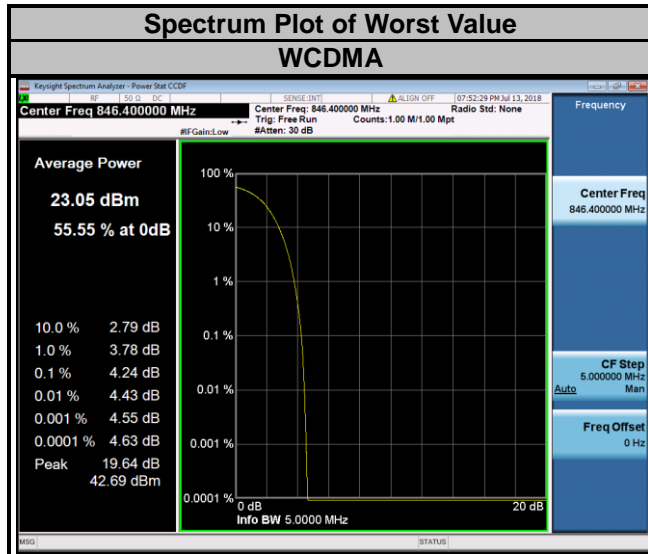

LTE Band 5							
Channel Bandwidth: 1.4 MHz				Channel Bandwidth: 3 MHz			
Channel	Frequency (MHz)	Peak to Average Ratio (dB)		Channel	Frequency (MHz)	Peak to Average Ratio (dB)	
		QPSK	16QAM			QPSK	16QAM
20407	824.7	4.75	5.52	20415	825.5	4.81	5.56
20525	836.5	4.92	5.69	20525	836.5	5.00	5.89
20643	848.3	4.55	5.31	20635	847.5	4.41	5.23

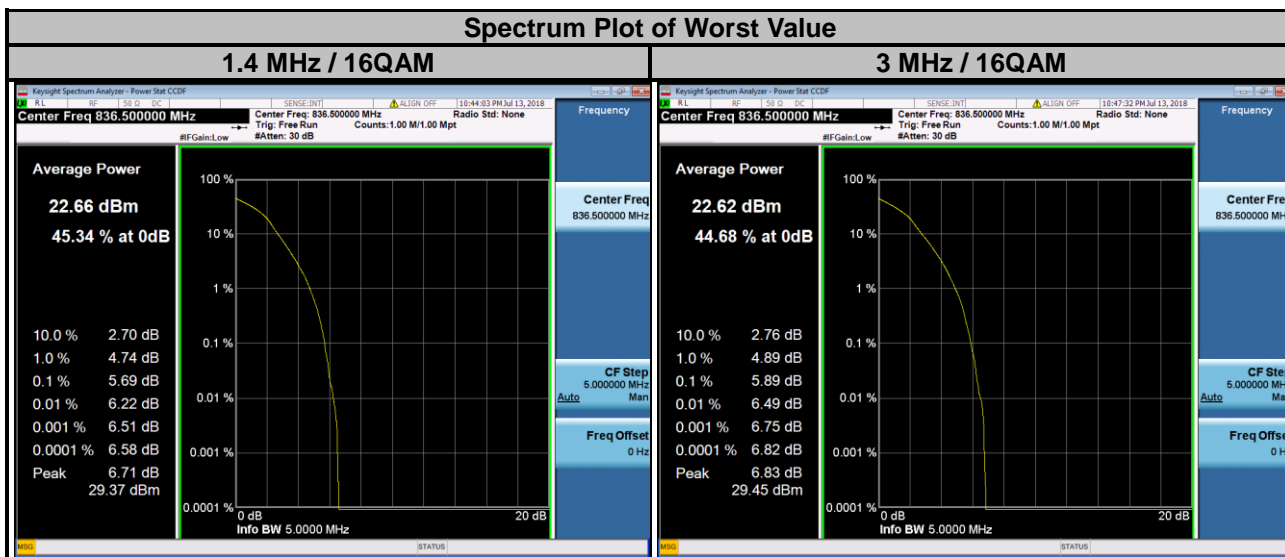

LTE Band 5							
Channel Bandwidth: 5 MHz				Channel Bandwidth: 10 MHz			
Channel	Frequency (MHz)	Peak to Average Ratio (dB)		Channel	Frequency (MHz)	Peak to Average Ratio (dB)	
		QPSK	16QAM			QPSK	16QAM
20425	826.5	4.76	5.48	20450	829.0	4.78	5.43
20525	836.5	4.89	5.60	20525	836.5	4.77	5.51
20625	846.5	4.26	4.93	20600	844.0	4.89	5.53

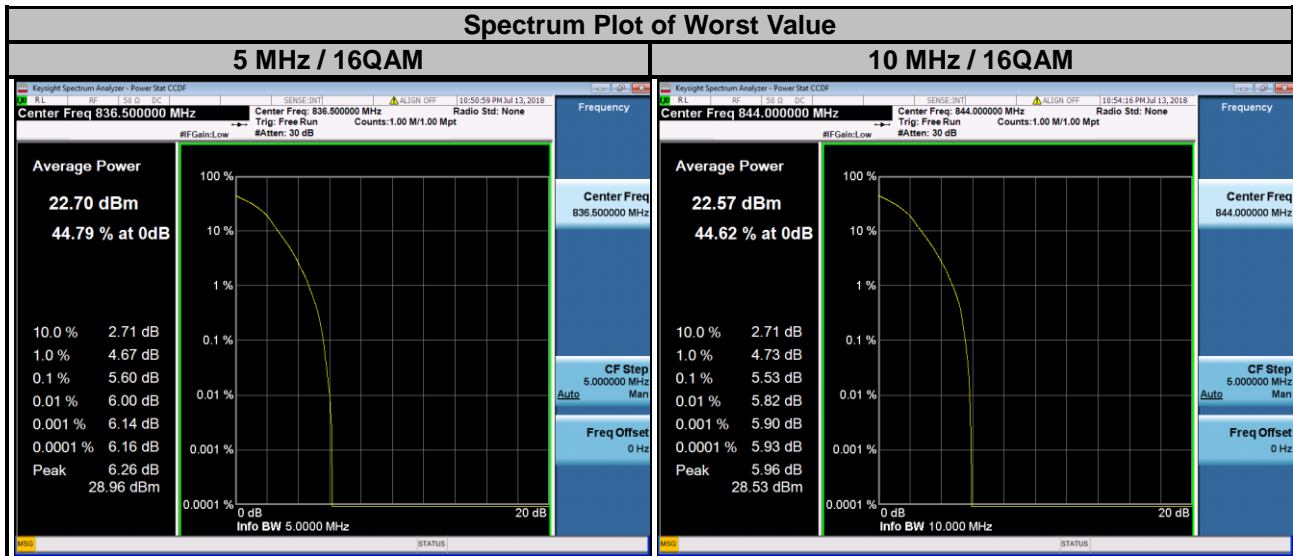

LTE Band 26							
Channel Bandwidth: 1.4 MHz				Channel Bandwidth: 3 MHz			
Channel	Frequency (MHz)	Peak to Average Ratio (dB)		Channel	Frequency (MHz)	Peak to Average Ratio (dB)	
		QPSK	16QAM			QPSK	16QAM
26797	824.7	5.01	5.62	26805	825.5	5.10	5.77
26915	836.5	5.05	5.88	26915	836.5	5.12	5.85
27033	848.3	4.83	5.61	27025	847.5	4.71	5.32

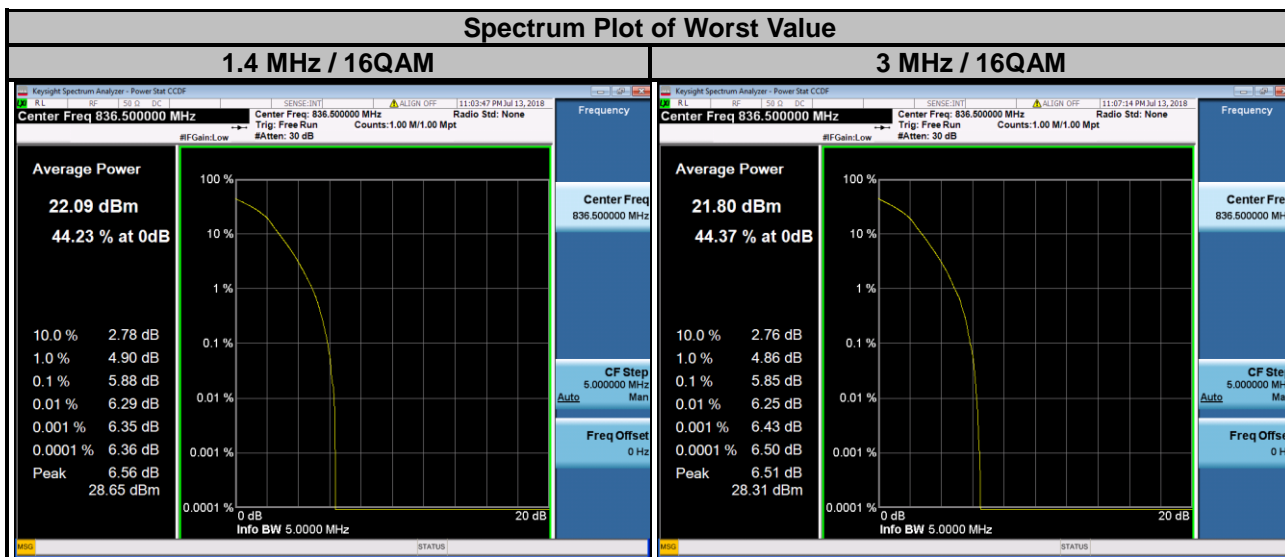

LTE Band 26

Channel Bandwidth: 5 MHz				Channel Bandwidth: 10 MHz			
Channel	Frequency (MHz)	Peak to Average Ratio (dB)		Channel	Frequency (MHz)	Peak to Average Ratio (dB)	
		QPSK	16QAM			QPSK	16QAM
26815	826.5	5.02	5.59	26840	829.0	4.95	5.57
26915	836.5	5.04	5.73	26915	836.5	5.02	5.65
27015	846.5	4.53	5.04	26990	844.0	5.04	5.75

Spectrum Plot of Worst Value

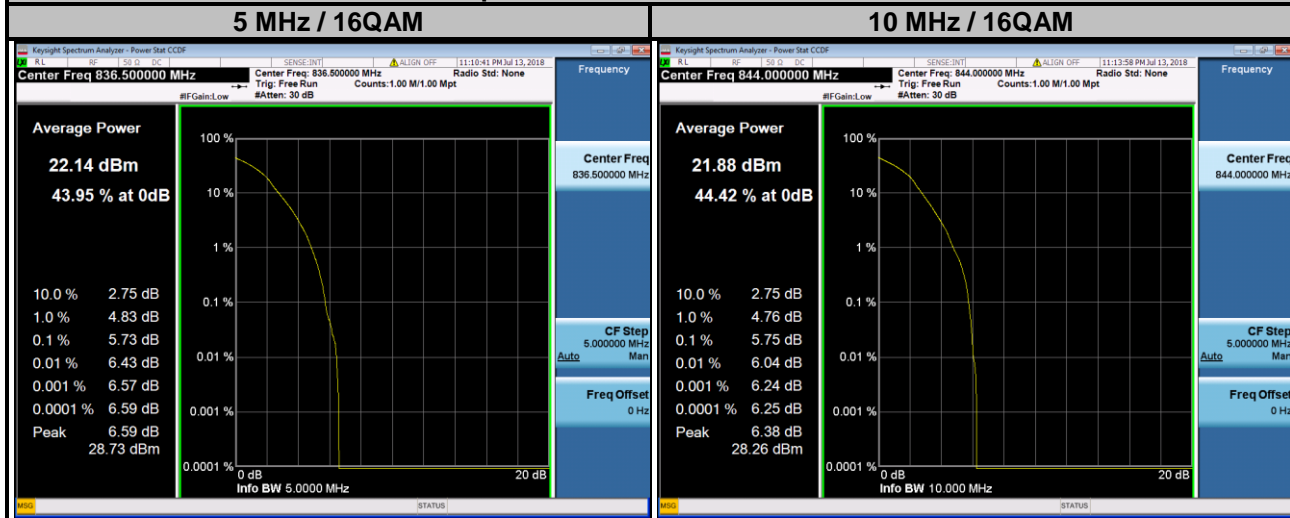

LTE Band 26			
Channel Bandwidth: 15 MHz			
Channel	Frequency (MHz)	Peak to Average Ratio (dB)	
		QPSK	16QAM
26865	831.5	4.89	5.55
26915	836.5	4.99	5.53
26965	841.5	5.22	5.76

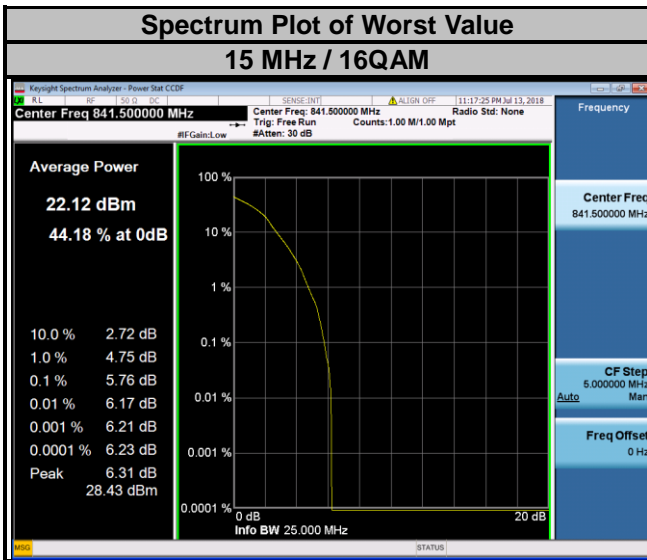

4.7 Conducted Spurious Emissions

4.7.1 Limits of Conducted Spurious Emissions Measurement

The power of any emission outside of the authorized operating frequency ranges must be attenuated below the transmitting power (P) by a factor of at least $43 + 10 \log(P)$ dB. The emission limit equal to -13 dBm.

4.7.2 Test Setup

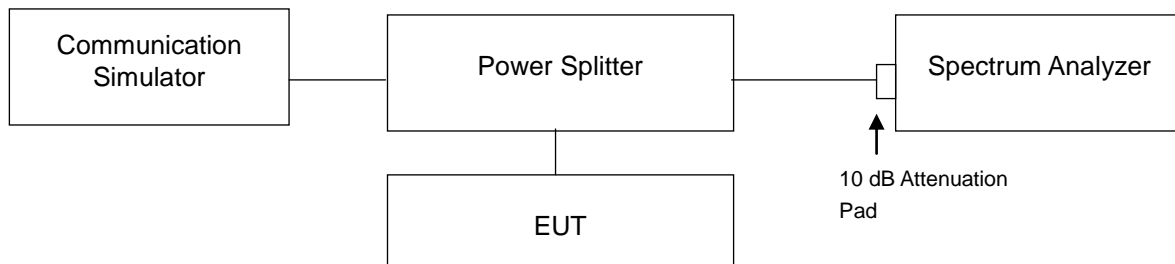

4.7.3 Test Procedure

- The EUT makes a phone call to the communication simulator. All measurements were done at low, middle and high operational frequency range.
- Measuring frequency range is from 9 kHz to 10 GHz. 10 dB attenuation pad is connected with spectrum. RBW = 100 kHz and VBW = 300 kHz for 9 kHz to 1 GHz and RBW = 1 MHz and VBW = 3 MHz for 1 GHz to 10 GHz is used for conducted emission measurement.

4.7.4 Test Results

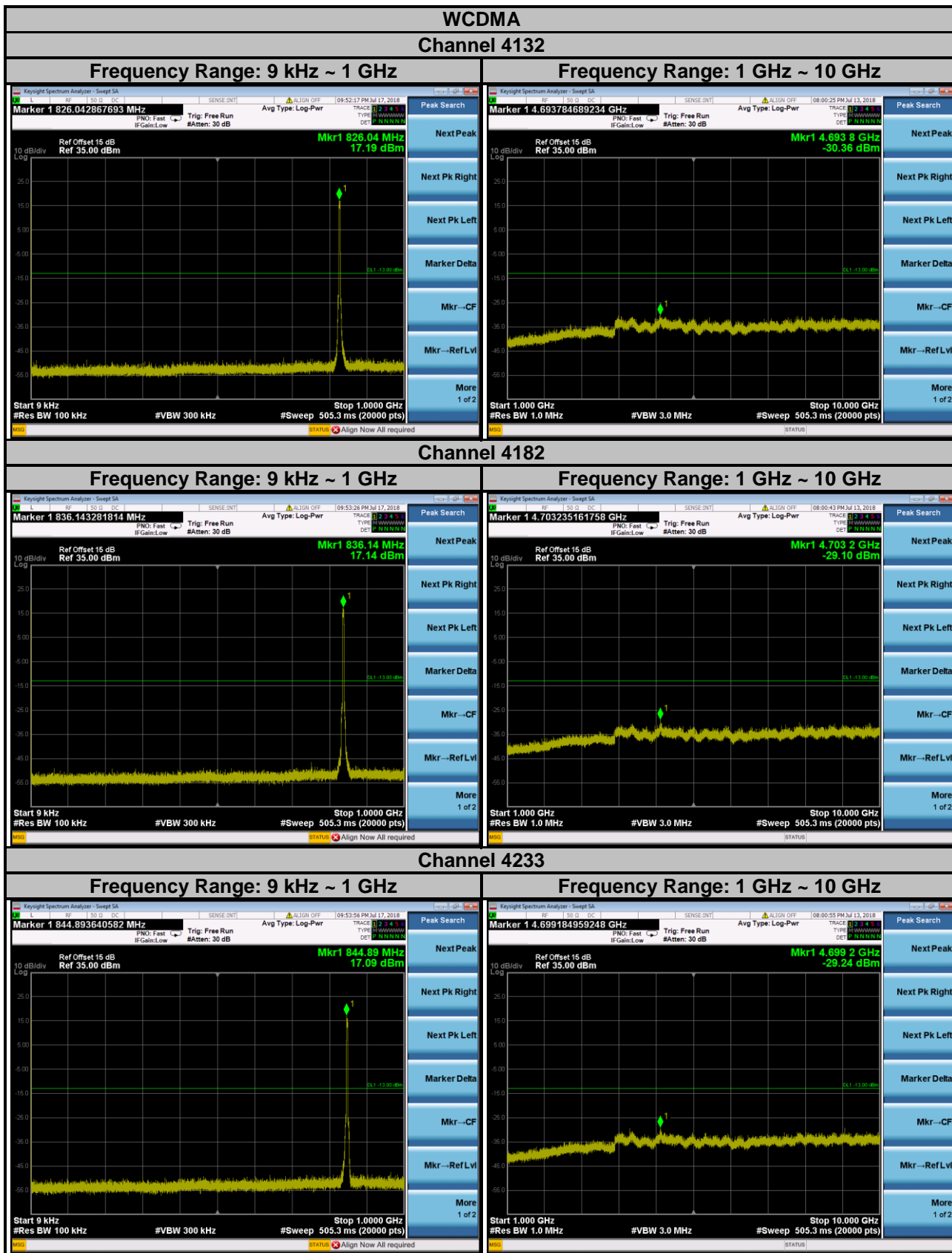

LTE Band 5
Channel Bandwidth: 1.4 MHz
Channel 20407

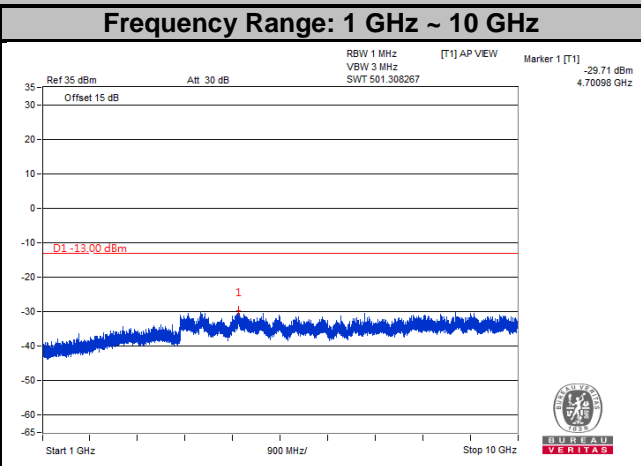
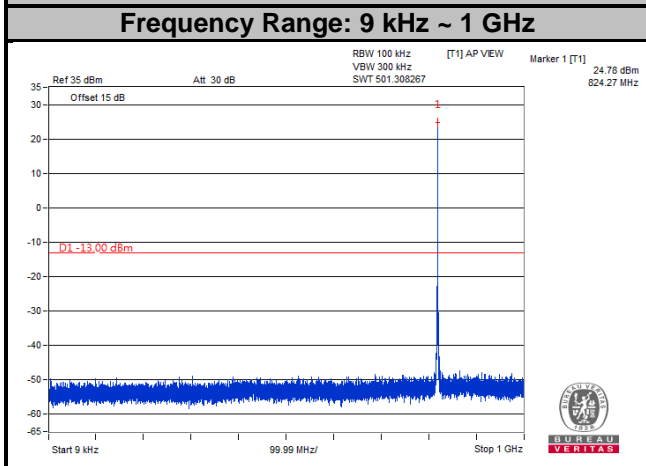

Channel 20525

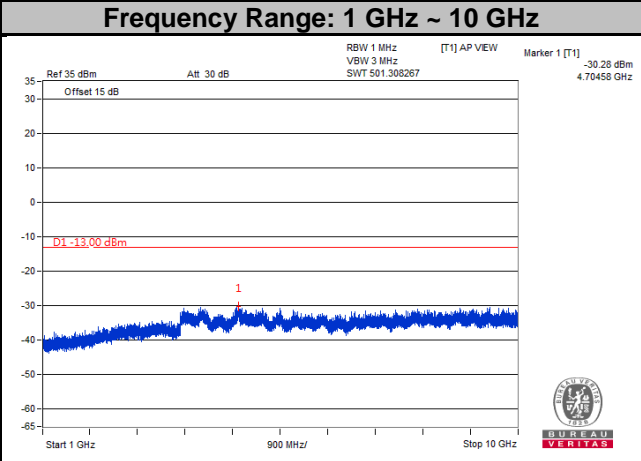
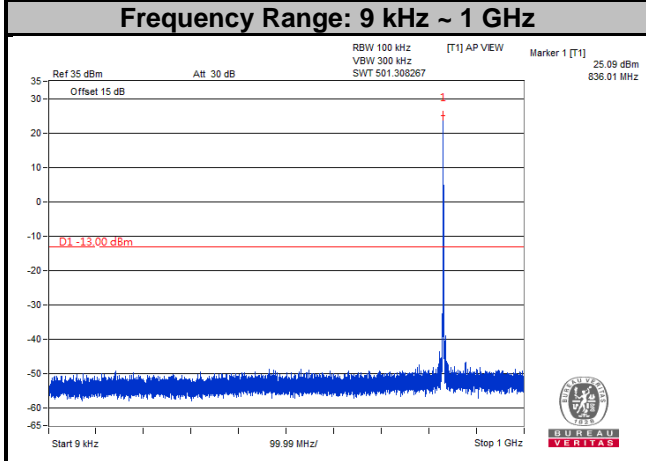

Channel 20643

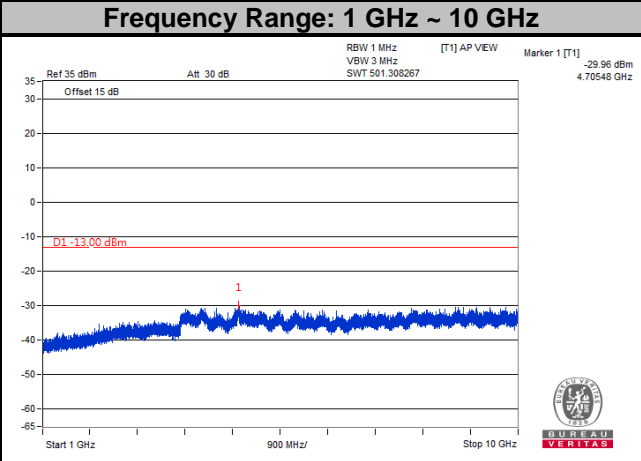
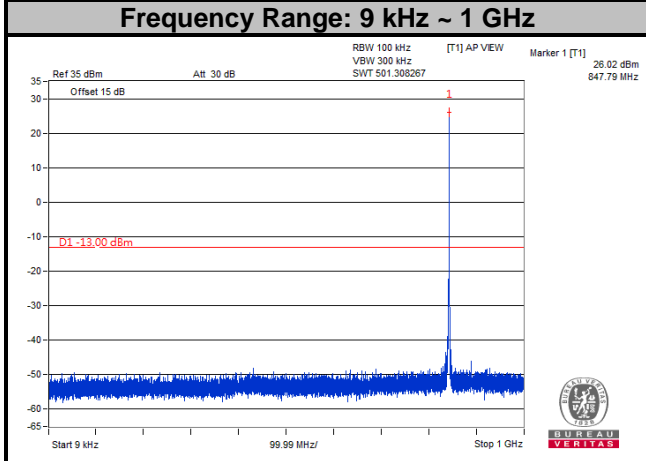

LTE Band 5
Channel Bandwidth: 3 MHz
Channel 20415

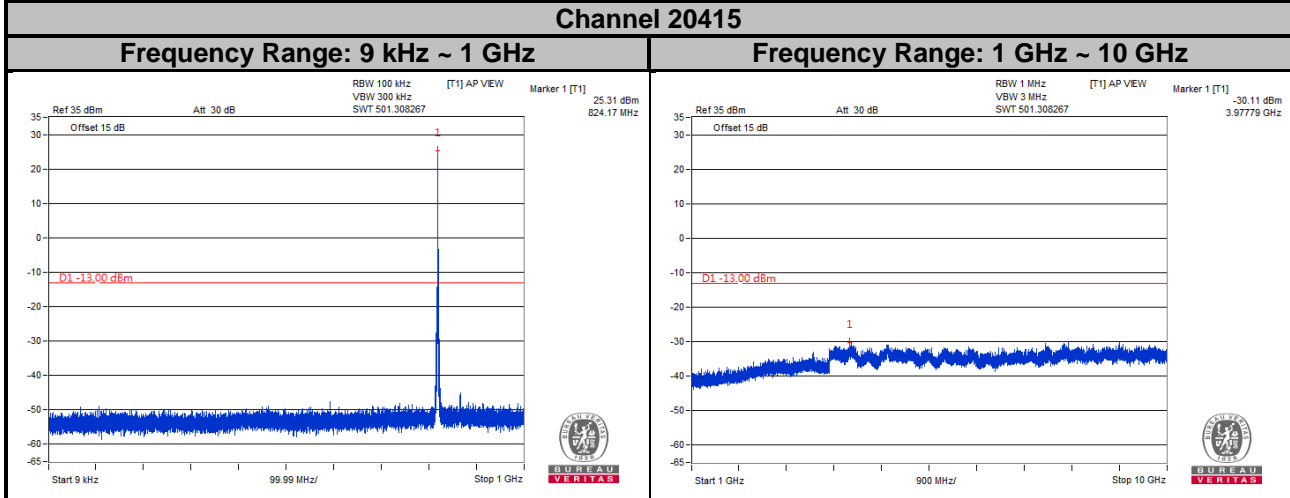

Channel 20525

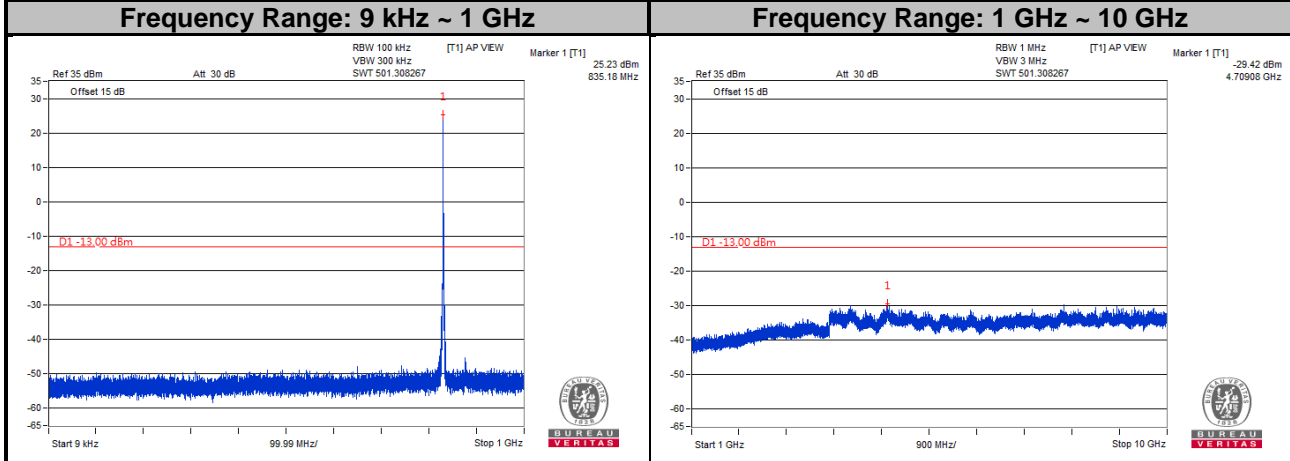

Channel 20635

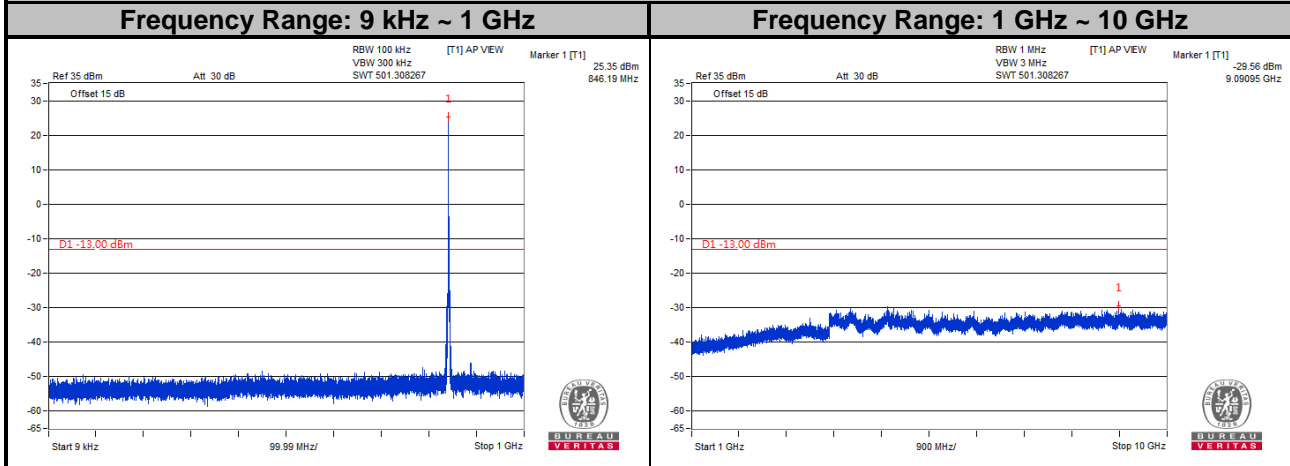

LTE Band 5
Channel Bandwidth: 5 MHz
Channel 20425

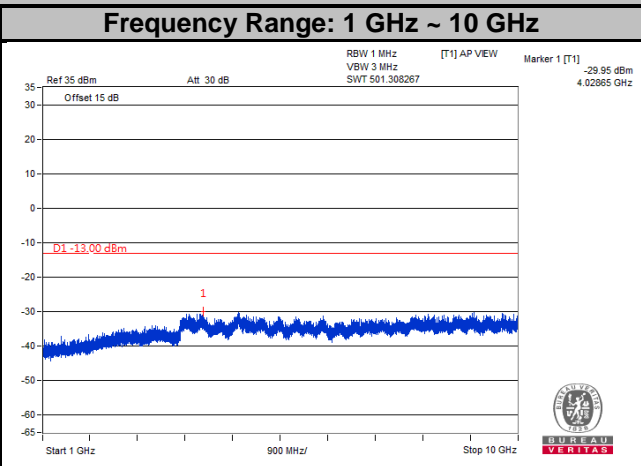
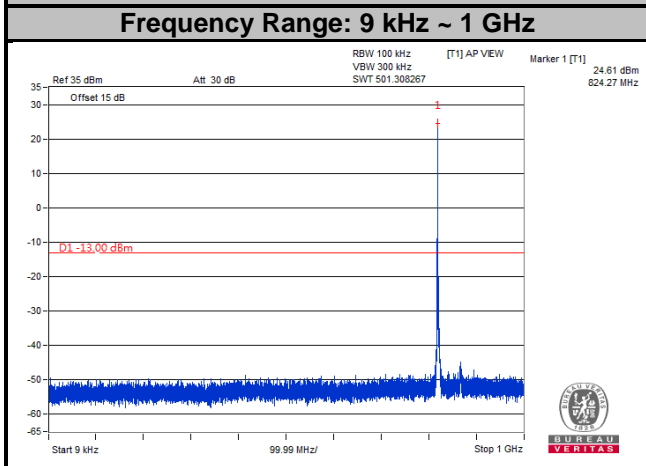

Channel 20525

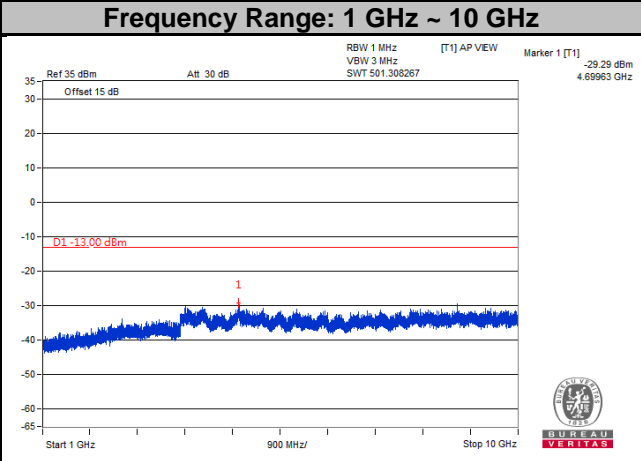
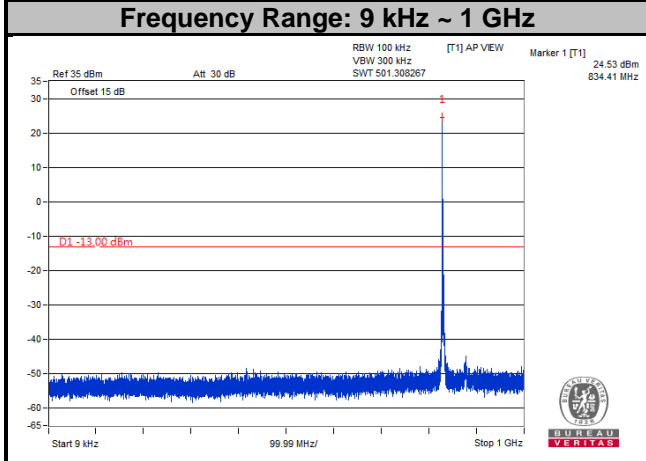

Channel 20625

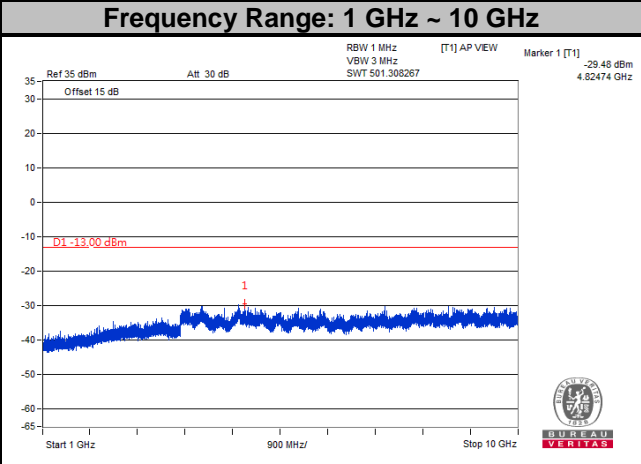
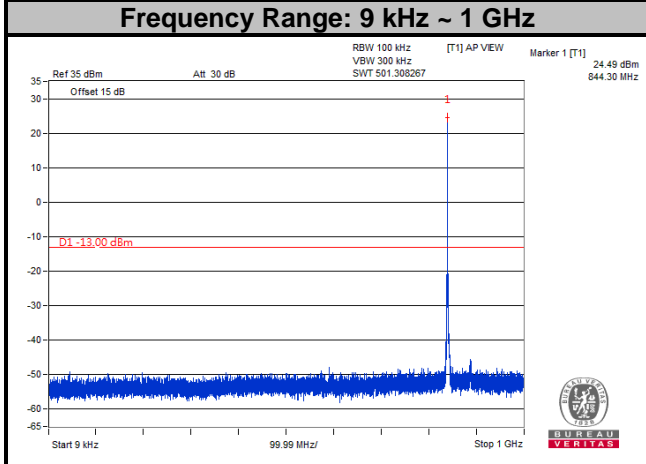

LTE Band 5
Channel Bandwidth: 10 MHz

Channel 20450

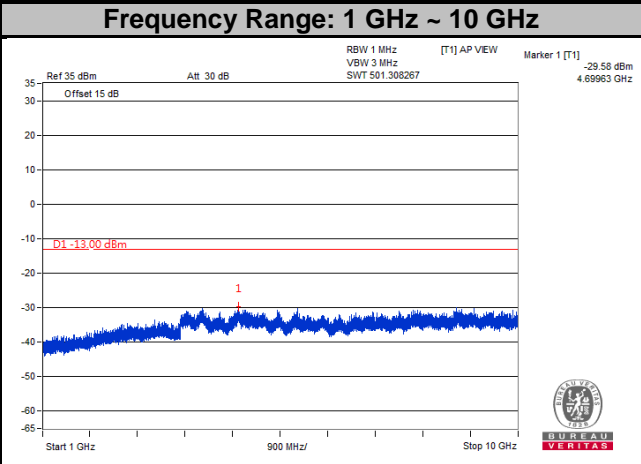
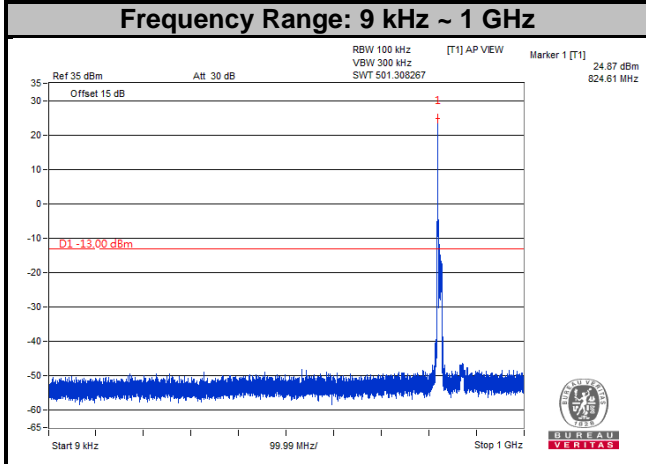

Channel 20525

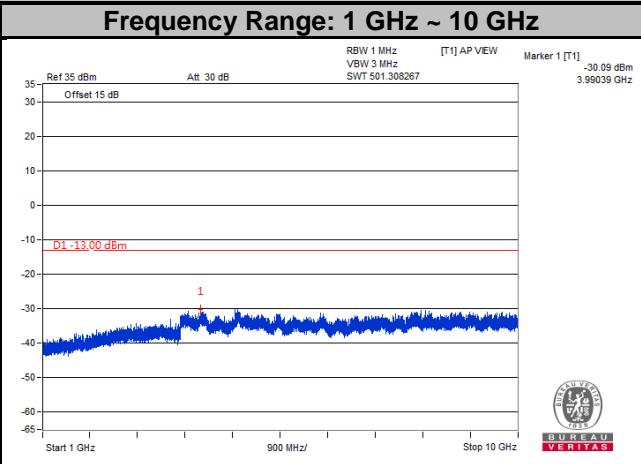
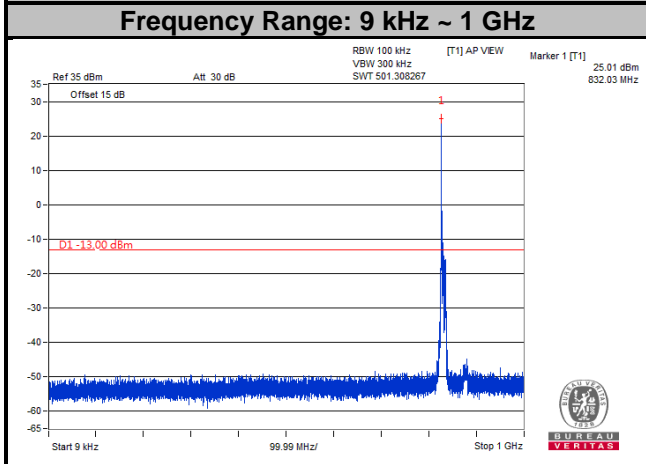

Channel 20600

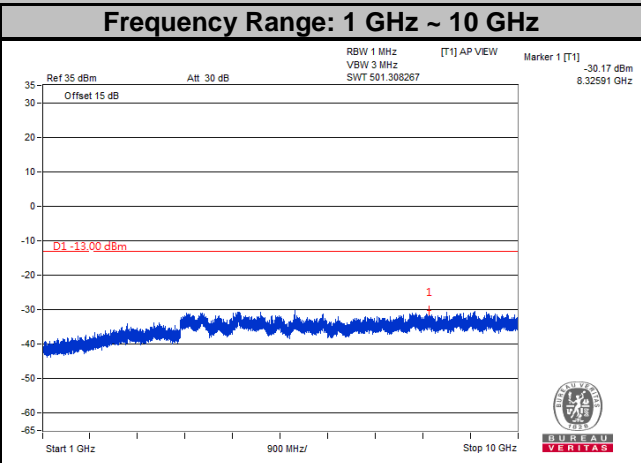
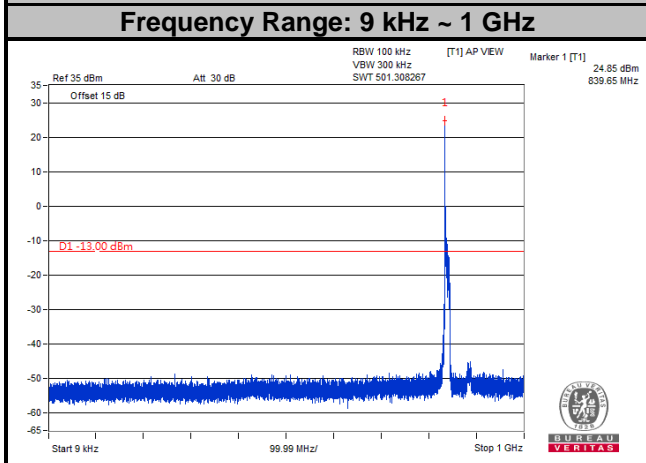

LTE Band 26
Channel Bandwidth: 1.4 MHz
Channel 26797

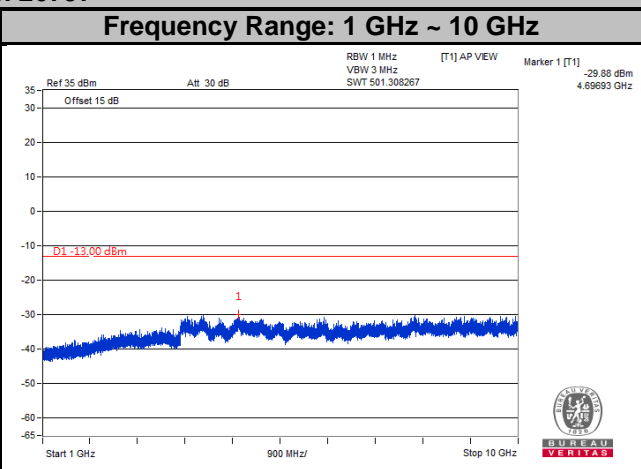
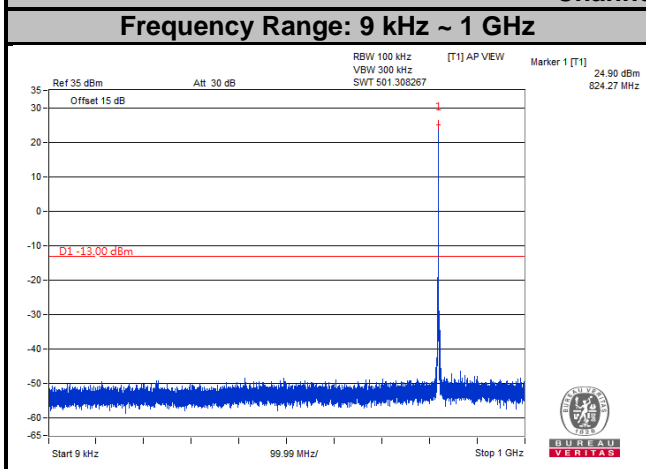

Channel 26915

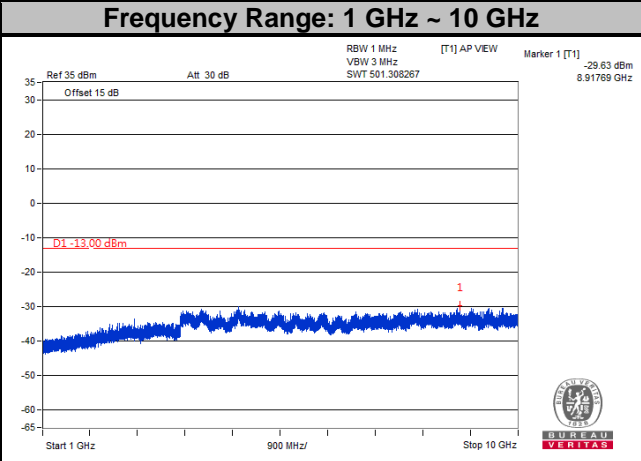
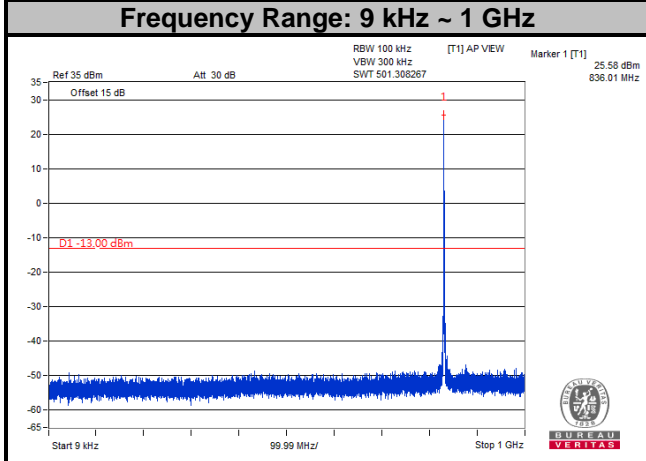

Channel 27033

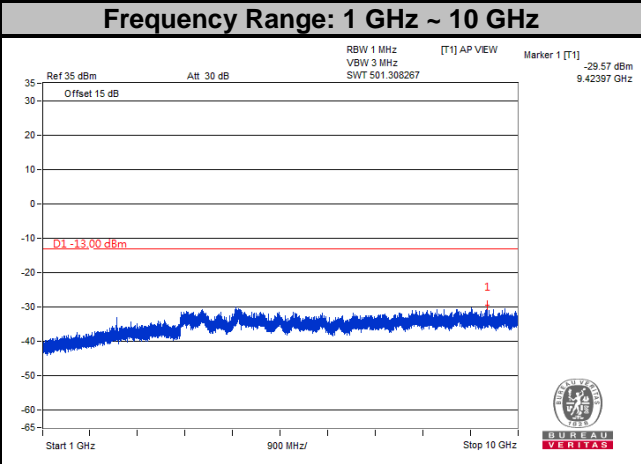
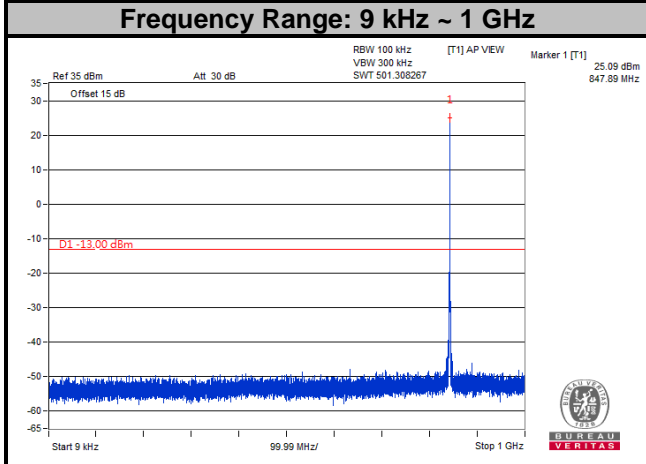

LTE Band 26
Channel Bandwidth: 3 MHz
Channel 26805

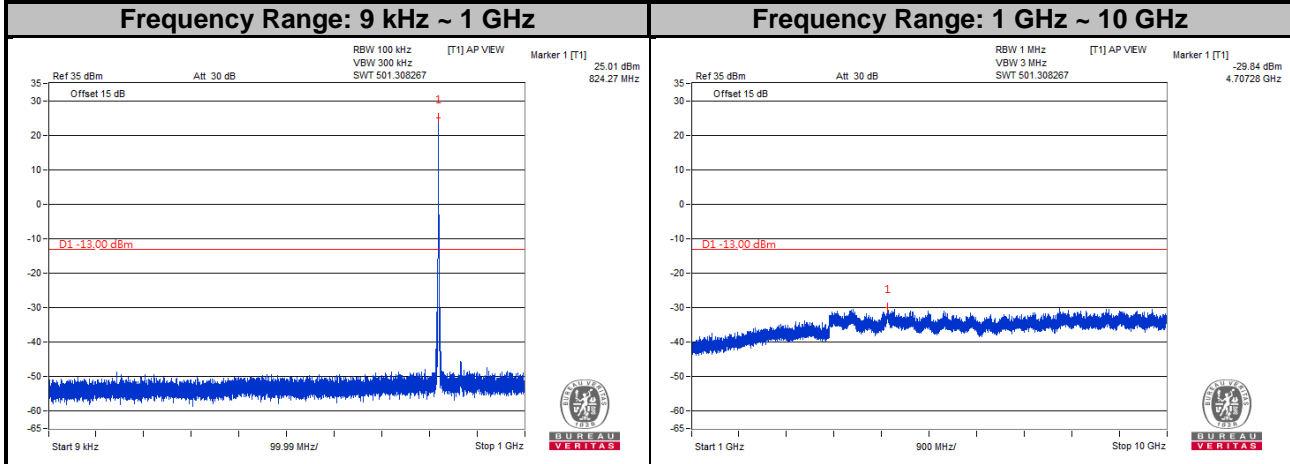

Channel 26915

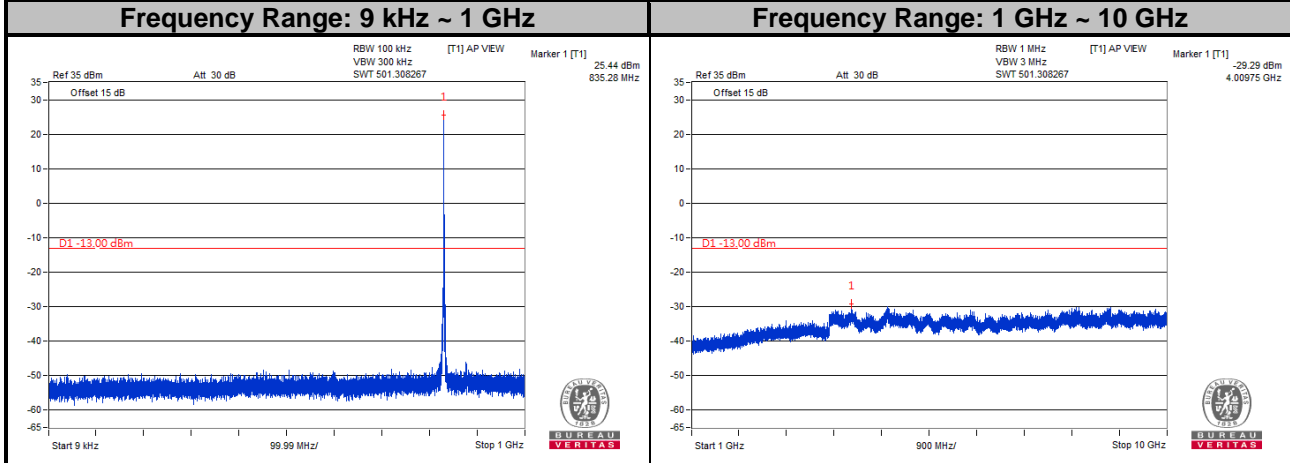

Channel 27025

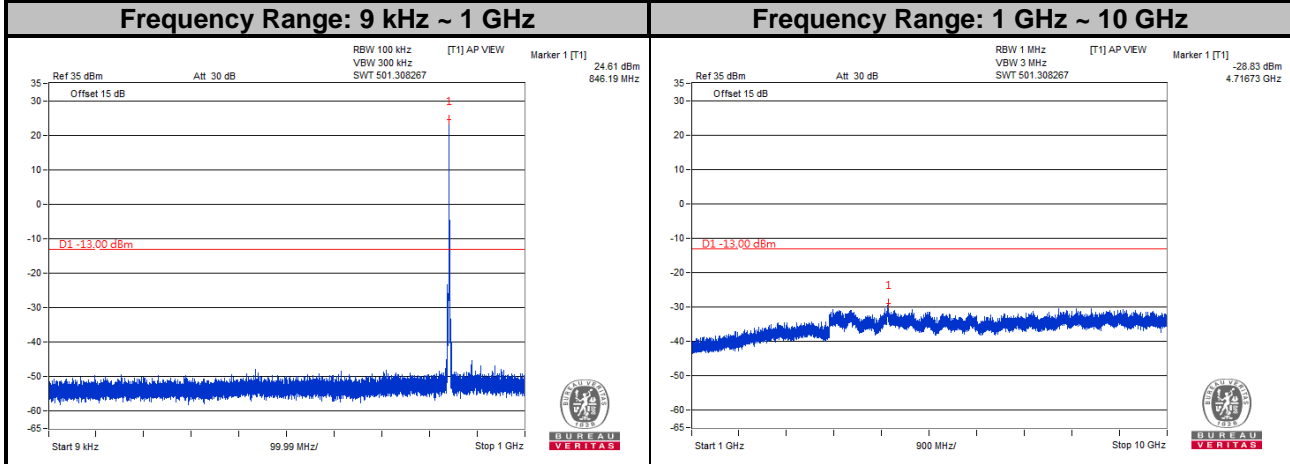

LTE Band 26
Channel Bandwidth: 5 MHz
Channel 26815

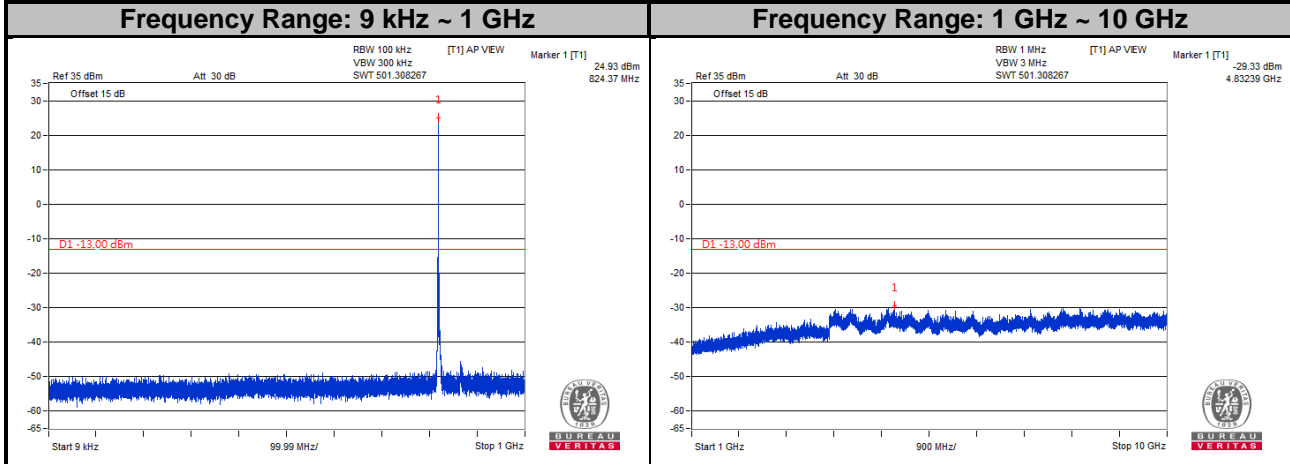

Channel 26915

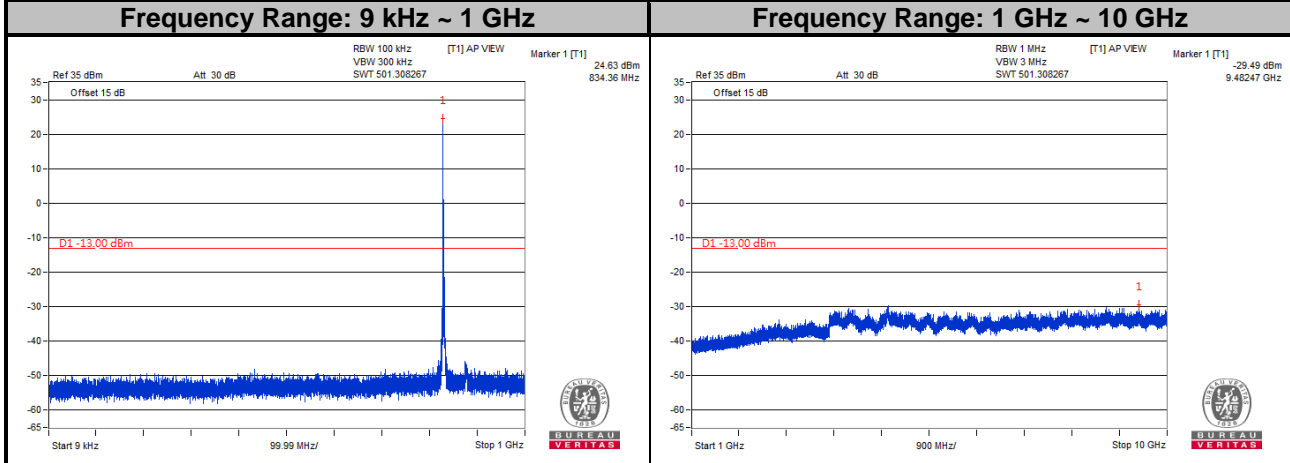

Channel 27015

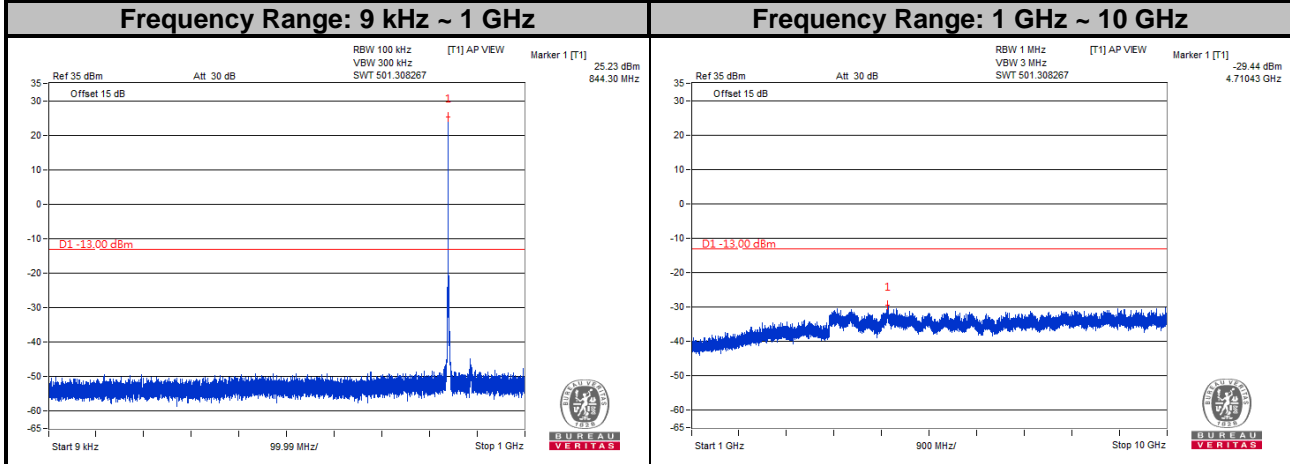

LTE Band 26
Channel Bandwidth: 10 MHz

Channel 26840

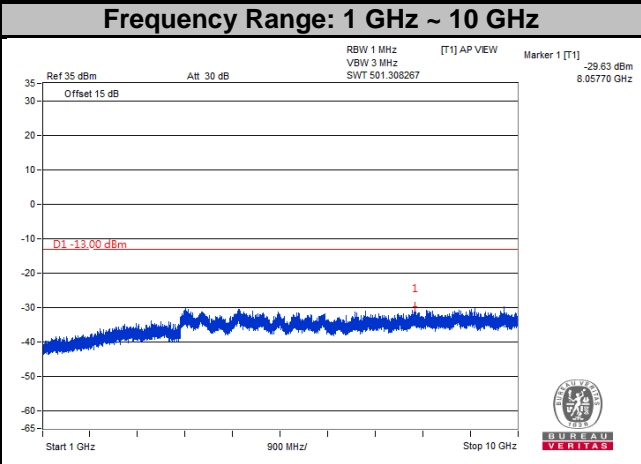
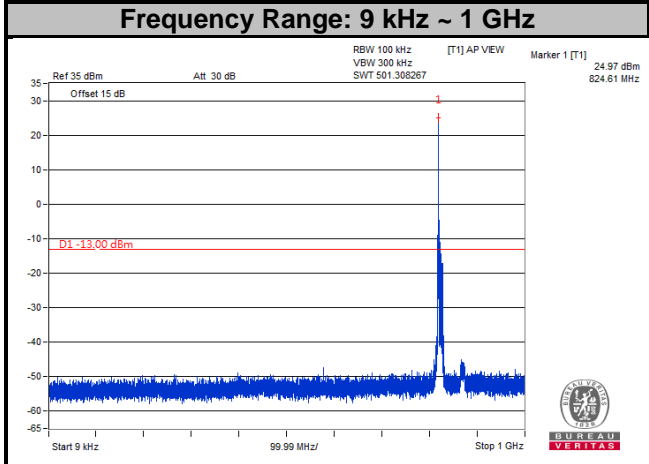

Channel 26915

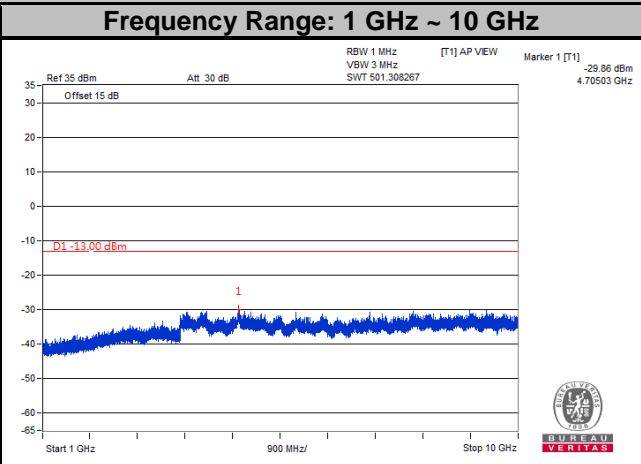
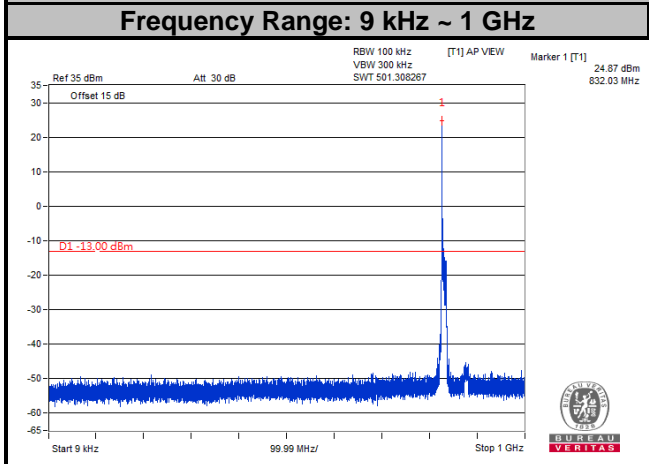

Channel 26990

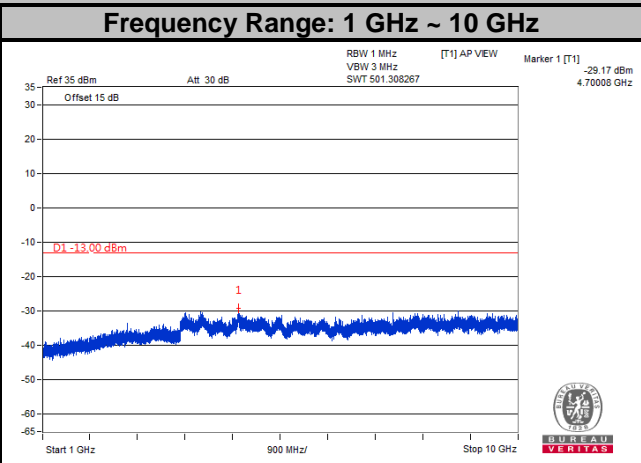
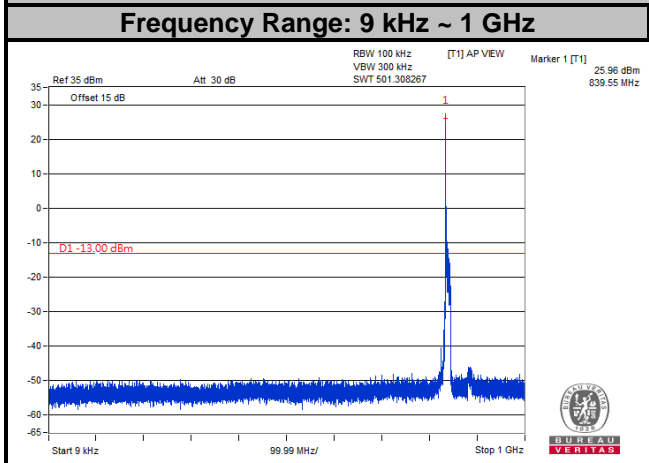

LTE Band 26
Channel Bandwidth: 15 MHz
Channel 26865

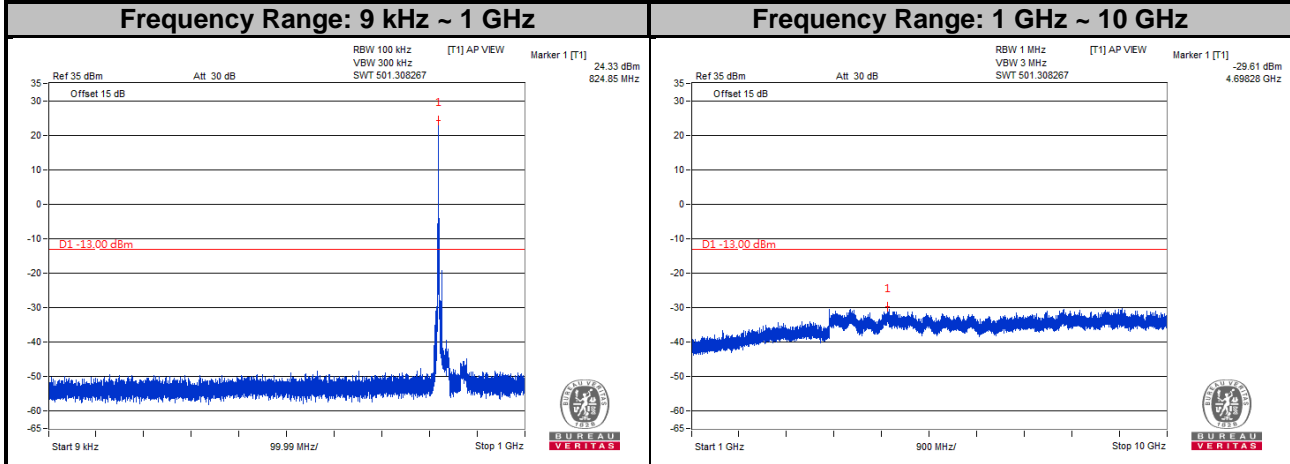

Channel 26915

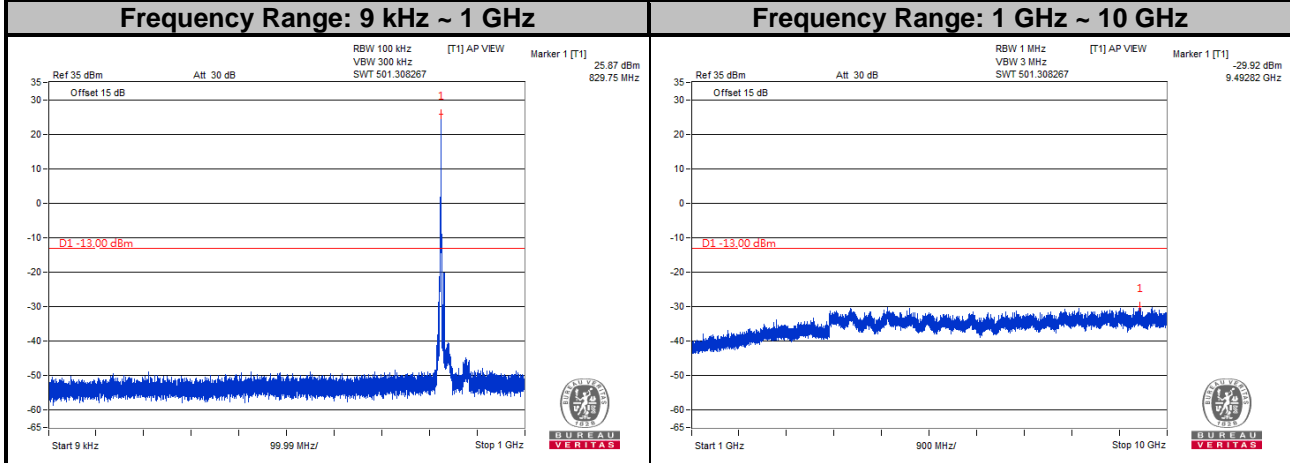

Channel 26965

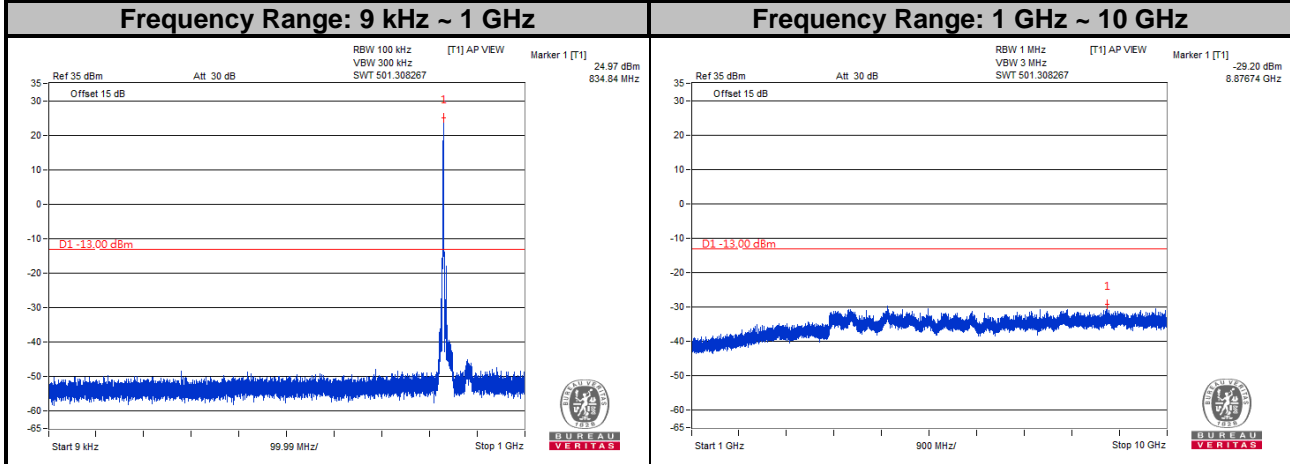

4.8 Radiated Emission Measurement

4.8.1 Limits of Radiated Emission Measurement

The power of any emission outside of the authorized operating frequency ranges must be attenuated below the transmitting power (P) by a factor of at least $43 + 10 \log(P)$ dB. The emission limit is equal to -13 dBm.

4.8.2 Test Procedure

- a. Substitution method is used for E.I.R.P measurement. In the semi-anechoic chamber, EUT placed on the 0.8 m (below or equal 1 GHz) and/or 1.5 m (above 1 GHz) height of Turn Table, rotated the table around 360 degrees to search the maximum radiation power and receiver antenna shall be rotated vertical and horizontal polarization and moved height from 1 m to 4 m to find the maximum polar radiated power. The "Read Value" is the spectrum reading the maximum power value.
- b. The substitution horn antenna is substituted for EUT at the same position and signals generator export the CW signal to the substitution antenna via a TX cable. Rotated the Turn Table and moved receiving antenna to find the maximum radiation power. Adjust output power level of S.G to get a Value of spectrum reading equal to "Read Value" of step a. Record the power level of S.G
- c. EIRP = Output power level of S.G – TX cable loss + Antenna gain of substitution horn.
- d. E.R.P power can be calculated form E.I.R.P power by subtracting the gain of dipole, E.R.P power = E.I.R.P power - 2.15 dB.

NOTE: The resolution bandwidth and video bandwidth of test receiver/spectrum analyzer is 1 MHz/3 MHz.

4.8.3 Deviation from Test Standard

No deviation.

4.8.4 Test Setup

<Radiated Emission below or equal 1 GHz>

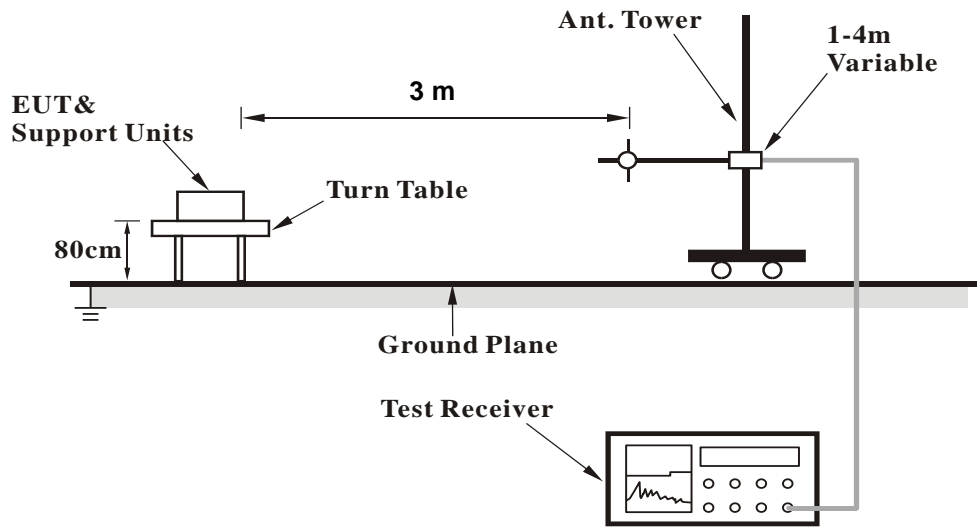

<Radiated Emission above 1 GHz>

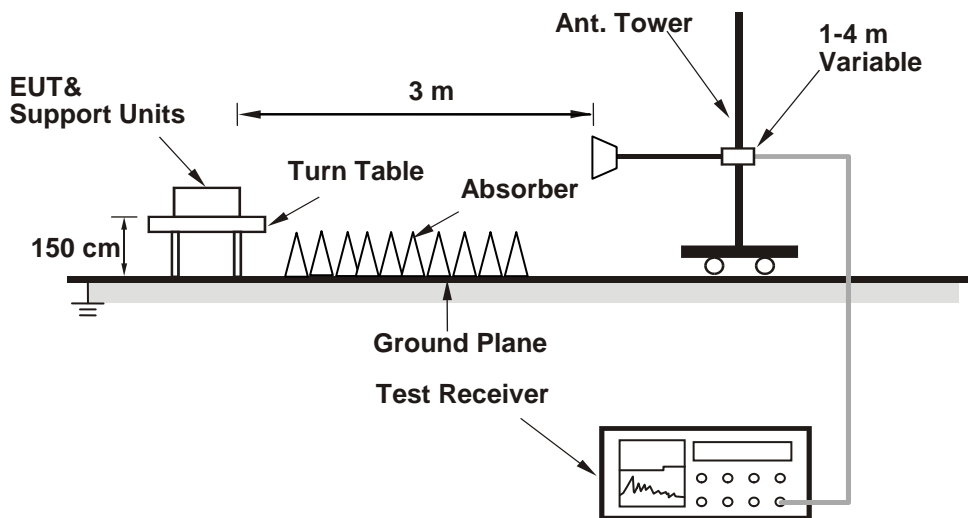

For the actual test configuration, please refer to the attached file (Test Setup Photo).

4.8.5 Test Results

WCDMA:
Low Channel



Bureau Veritas Consumer Products Services Ltd., Taoyuan Branch

A D T

Data: 5

Date: 2018-07-10

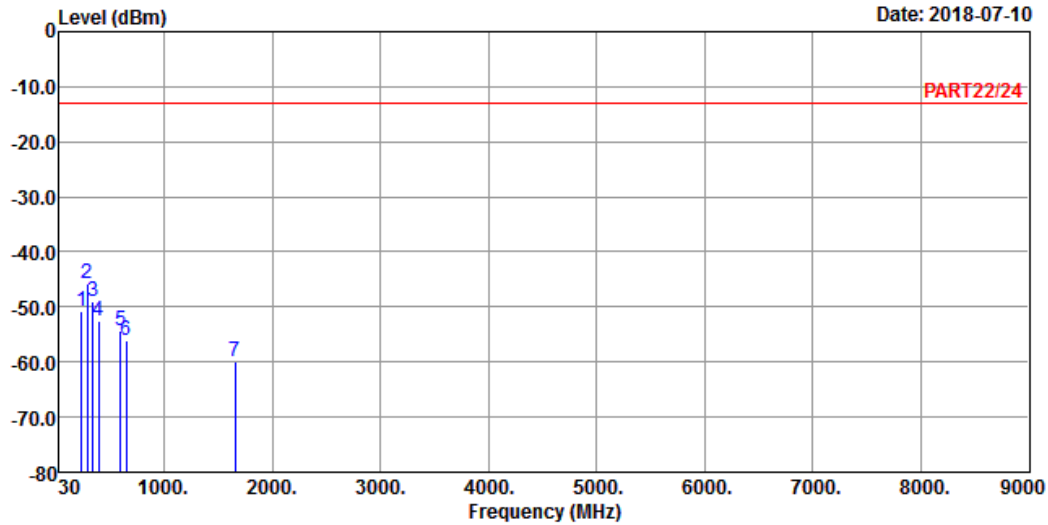

Site : 966 Chamber 5
Condition: PART22/24 HORIZONTAL
Remak : WCDMA Band V_L-CH Link
Tested by: Jisyong Wang

	Freq	Level	Read Level	Limit Line	Over Limit	Factor	Remark
	MHz	dBm	dBm	dBm	dB	dB	
1	234.67	-50.79	-44.17	-13.00	-37.79	-6.62	Peak
2 pp	286.08	-45.72	-38.99	-13.00	-32.72	-6.73	Peak
3	338.46	-49.07	-42.65	-13.00	-36.07	-6.42	Peak
4	389.87	-52.56	-46.56	-13.00	-39.56	-6.00	Peak
5	598.42	-54.41	-53.58	-13.00	-41.41	-0.83	Peak
6	650.80	-56.12	-55.25	-13.00	-43.12	-0.87	Peak
7	1652.80	-59.81	-46.04	-13.00	-46.81	-13.77	Peak



Bureau Veritas Consumer Products Services Ltd., Taoyuan Branch

A D T

Data: 6

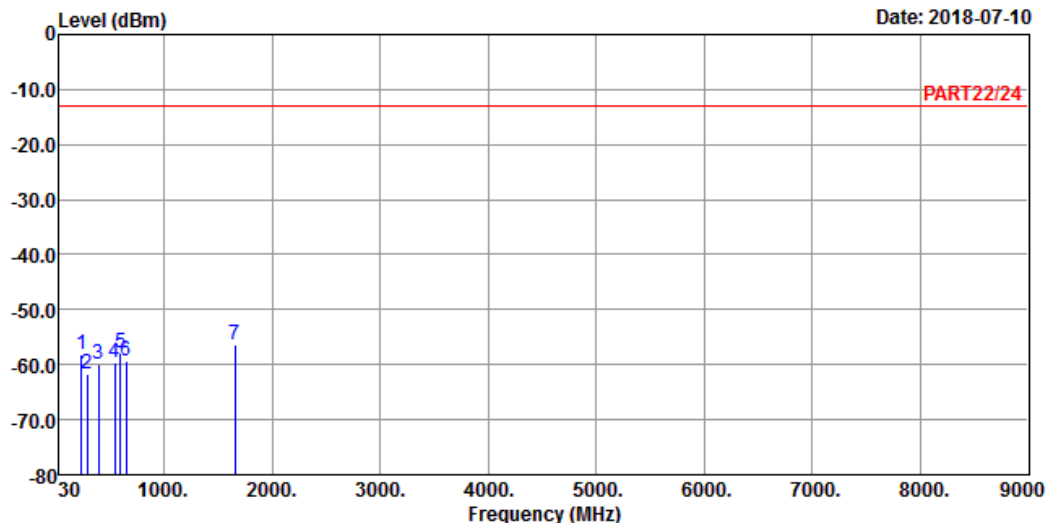

Site : 966 Chamber 5
 Condition: PART22/24 VERTICAL
 Remak : WCDMA Band V_L-CH Link
 Tested by: Jisyong Wang

	Freq	Level	Read Level	Limit Line	Over Limit	Factor	Remark
	MHz	dBm	dBm	dBm	dB	dB	
1	234.67	-58.02	-51.40	-13.00	-45.02	-6.62	Peak
2	286.08	-61.56	-54.83	-13.00	-48.56	-6.73	Peak
3	389.87	-59.98	-53.98	-13.00	-46.98	-6.00	Peak
4	546.04	-59.56	-56.57	-13.00	-46.56	-2.99	Peak
5	598.42	-57.84	-57.01	-13.00	-44.84	-0.83	Peak
6	650.80	-59.36	-58.49	-13.00	-46.36	-0.87	Peak
7 pp	1652.80	-56.39	-42.62	-13.00	-43.39	-13.77	Peak

Middle Channel



Bureau Veritas Consumer Products Services Ltd., Taoyuan Branch

A D T

Data: 3

Date: 2018-07-10

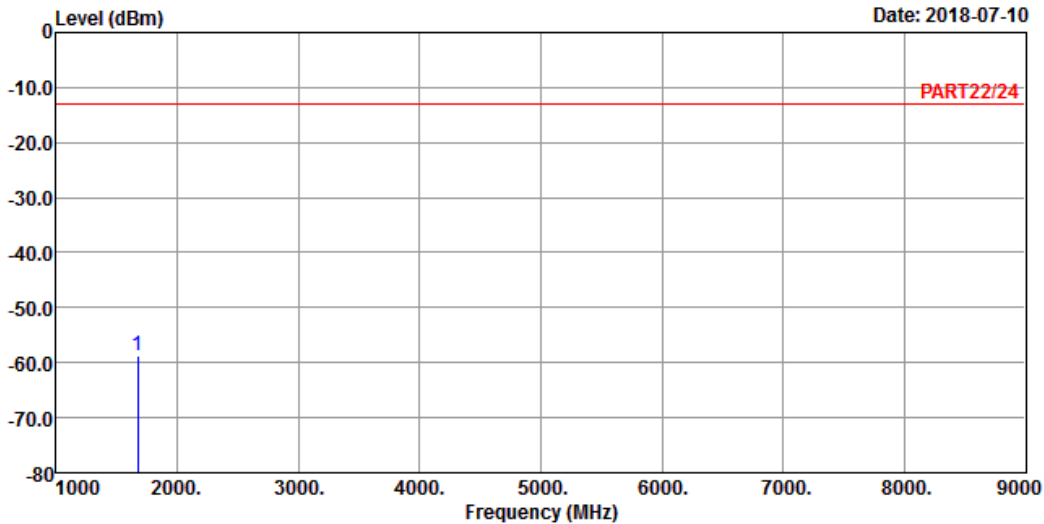

Site : 966 Chamber 5
 Condition: PART22/24 HORIZONTAL
 Remak : WCDMA Band V_M-CH Link
 Tested by: Jisyong Wang

	Read	Limit	Over			
Freq	Level	Level	Line	Limit	Factor	Remark
MHz	dBm	dBm	dBm	dB	dB	
1 pp 1672.80	-58.85	-44.95	-13.00	-45.85	-13.90	Peak



Bureau Veritas Consumer Products Services Ltd., Taoyuan Branch

A D T

Data: 4

Date: 2018-07-10

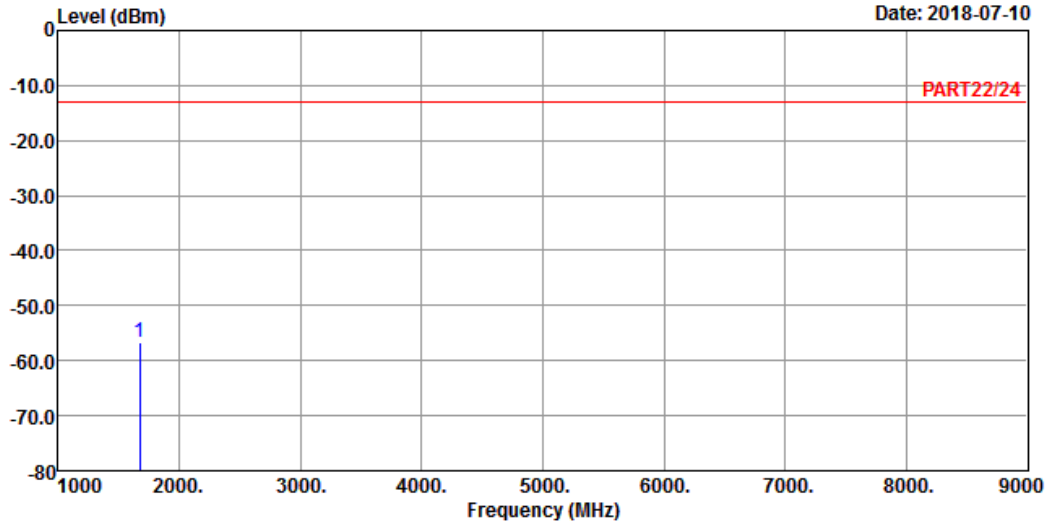

Site : 966 Chamber 5
 Condition: PART22/24 VERTICAL
 Remak : WCDMA Band V_M-CH Link
 Tested by: Jisyong Wang

Freq	Level	Read Level	Limit Line	Over Limit	Factor	Remark
MHz	dBm	dBm	dBm	dB	dB	
1 pp 1672.80	-56.68	-42.78	-13.00	-43.68	-13.90	Peak

High Channel



Bureau Veritas Consumer Products Services Ltd., Taoyuan Branch

A D T

Data: 3

Date: 2018-07-10

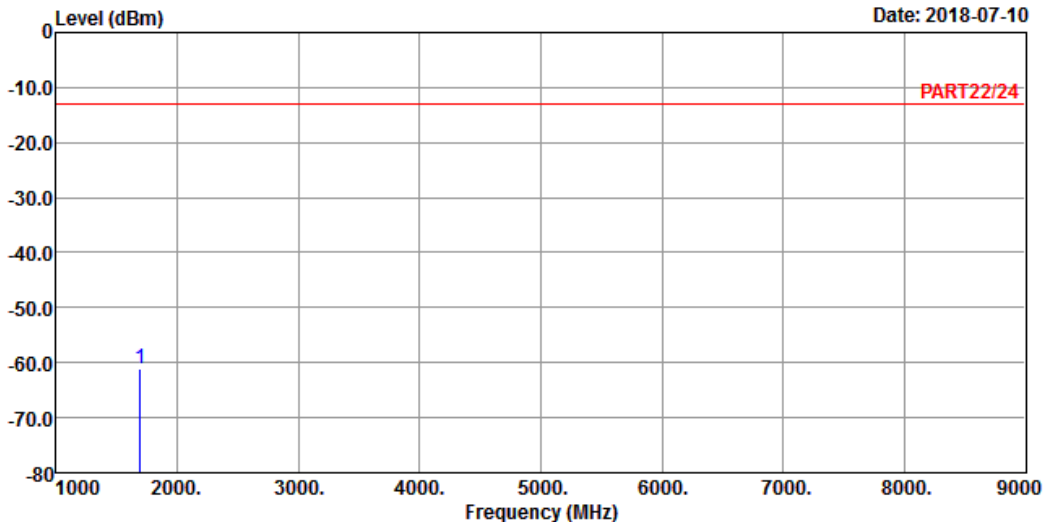

Site : 966 Chamber 5
 Condition: PART22/24 HORIZONTAL
 Remak : WCDMA Band V_H-CH Link
 Tested by: Jisyong Wang

	Read	Limit	Over			
Freq	Level	Level	Line	Limit	Factor	Remark
MHz	dBm	dBm	dBm	dB	dB	
1 pp 1693.20	-61.14	-47.12	-13.00	-48.14	-14.02	Peak



A D T

Data: 4

Date: 2018-07-10

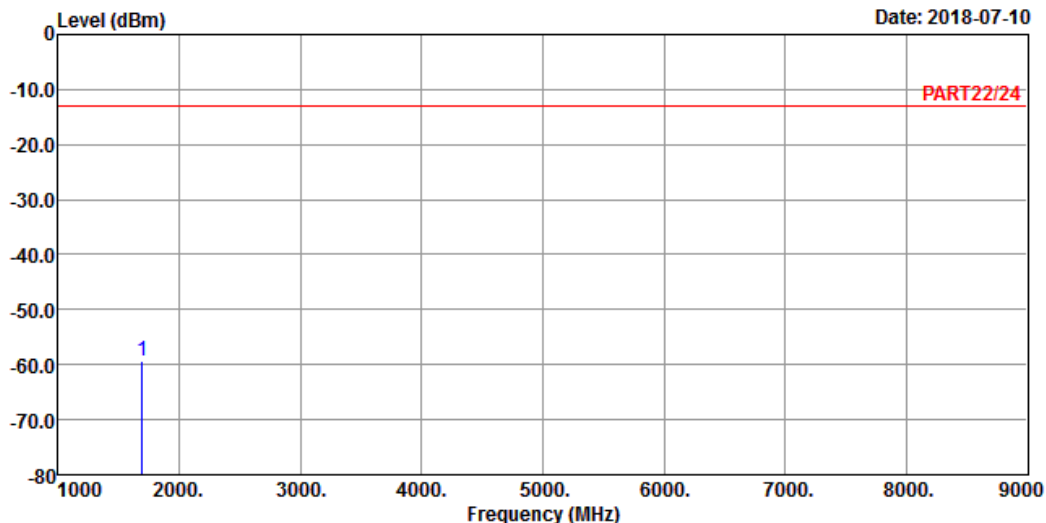

Site : 966 Chamber 5
 Condition: PART22/24 VERTICAL
 Remak : WCDMA Band V_H-CH Link
 Tested by: Jisyong Wang

Freq	Level	Read Level	Limit Line	Over Limit	Factor	Remark
MHz	dBm	dBm	dBm	dB	dB	
1 pp 1693.20	-59.30	-45.28	-13.00	-46.30	-14.02	Peak

LTE Band 5
 Channel Bandwidth: 10 MHz / QPSK
 Low Channel



Bureau Veritas Consumer Products Services Ltd., Taoyuan Branch

A D T

Data: 1

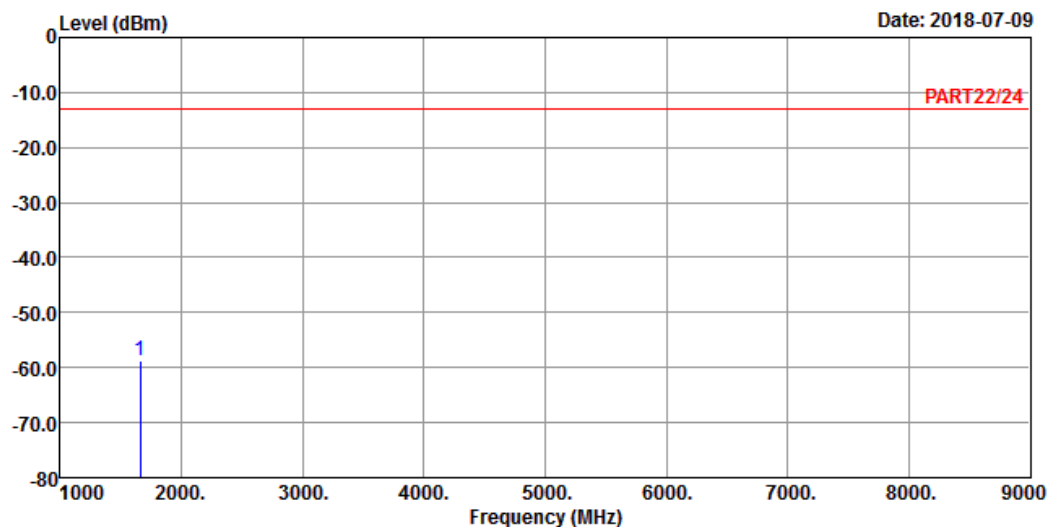

Site : 966 Chamber 5
 Condition: PART22/24 HORIZONTAL
 Remak : LTE Band 5 QPSK_10M Link_L-CH
 Tested by: Thomas Wei

Freq	Level	Read Level	Limit Line	Over Limit	Factor	Remark
MHz	dBm	dBm	dBm	dB	dB	
1 pp 1658.00	-58.62	-44.82	-13.00	-45.62	-13.80	Peak



Bureau Veritas Consumer Products Services Ltd., Taoyuan Branch

A D T

Data: 2

Date: 2018-07-09

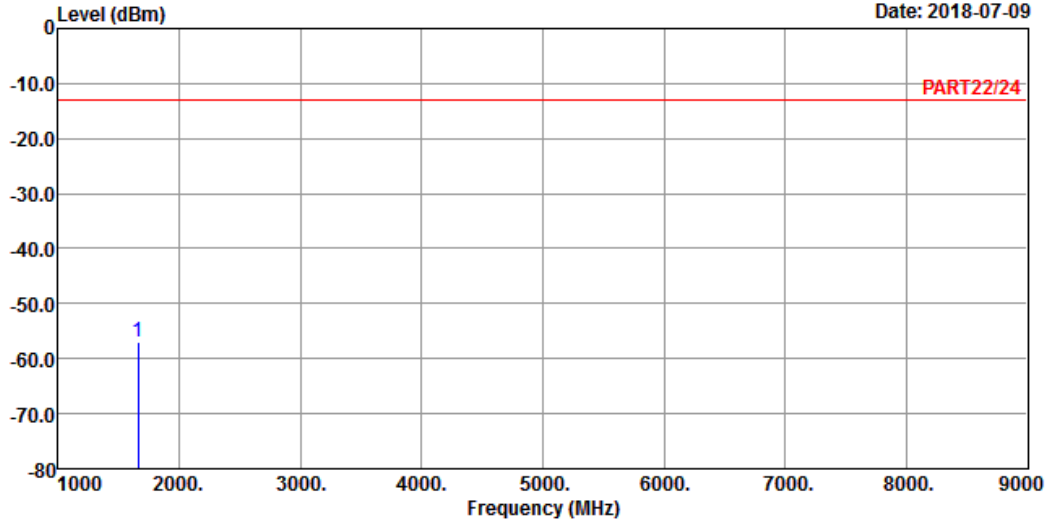

Site : 966 Chamber 5
 Condition: PART22/24 VERTICAL
 Remak : LTE Band 5 QPSK_10M Link_L-CH
 Tested by: Thomas Wei

Freq	Level	Read Level	Limit Line	Over Limit	Factor	Remark
MHz	dBm	dBm	dBm	dB	dB	
1 pp 1658.00	-57.01	-43.21	-13.00	-44.01	-13.80	Peak

Middle Channel



Bureau Veritas Consumer Products Services Ltd., Taoyuan Branch

A D T

Data: 5

Date: 2018-07-09

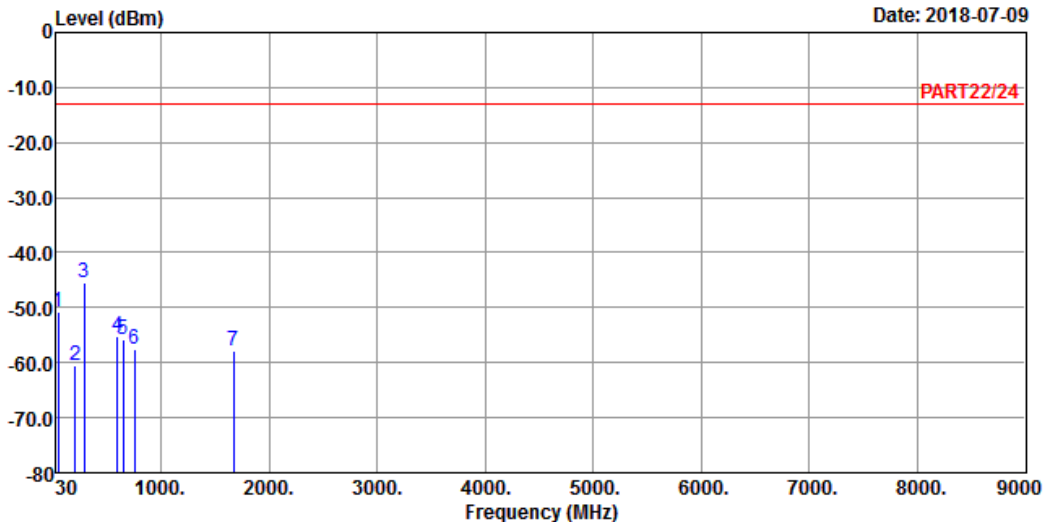

Site : 966 Chamber 5
 Condition: PART22/24 HORIZONTAL
 Remak : LTE Band 5 QPSK_10M Link_M-CH
 Tested by: Thomas Wei

	Freq	Level	Read Level	Limit Line	Over Limit	Factor	Remark
	MHz	dBm	dBm	dBm	dB	dB	
1	44.55	-50.83	-48.84	-13.00	-37.83	-1.99	Peak
2	208.48	-60.43	-52.76	-13.00	-47.43	-7.67	Peak
3 pp	286.08	-45.59	-38.86	-13.00	-32.59	-6.73	Peak
4	598.42	-55.14	-54.31	-13.00	-42.14	-0.83	Peak
5	650.80	-55.74	-54.87	-13.00	-42.74	-0.87	Peak
6	754.59	-57.55	-58.42	-13.00	-44.55	0.87	Peak
7	1673.00	-57.92	-44.02	-13.00	-44.92	-13.90	Peak



Bureau Veritas Consumer Products Services Ltd., Taoyuan Branch

A D T

Data: 6

Date: 2018-07-09

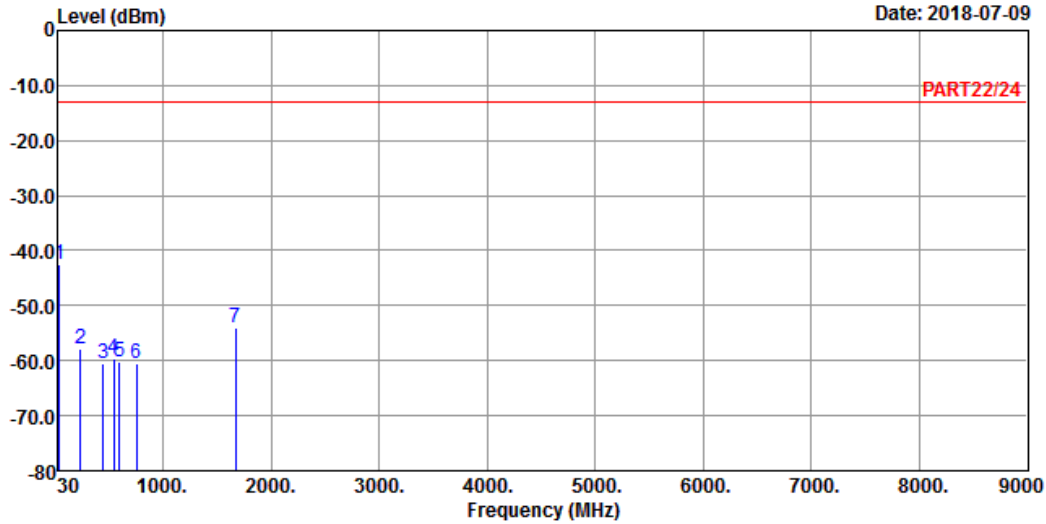

Site : 966 Chamber 5
 Condition: PART22/24 VERTICAL
 Remak : LTE Band 5 QPSK_10M Link_M-CH
 Tested by: Thomas Wei

	Freq	Level	Read Level	Limit Line	Over Limit	Factor	Remark
	MHz	dBm	dBm	dBm	dB	dB	
1 pp	40.67	-42.40	-42.52	-13.00	-29.40	0.12	Peak
2	234.67	-57.75	-51.13	-13.00	-44.75	-6.62	Peak
3	442.25	-60.40	-54.79	-13.00	-47.40	-5.61	Peak
4	546.04	-59.56	-56.57	-13.00	-46.56	-2.99	Peak
5	599.39	-60.18	-59.39	-13.00	-47.18	-0.79	Peak
6	754.59	-60.63	-61.50	-13.00	-47.63	0.87	Peak
7	1673.00	-53.99	-40.09	-13.00	-40.99	-13.90	Peak

High Channel



Bureau Veritas Consumer Products Services Ltd., Taoyuan Branch

A D T

Data: 1

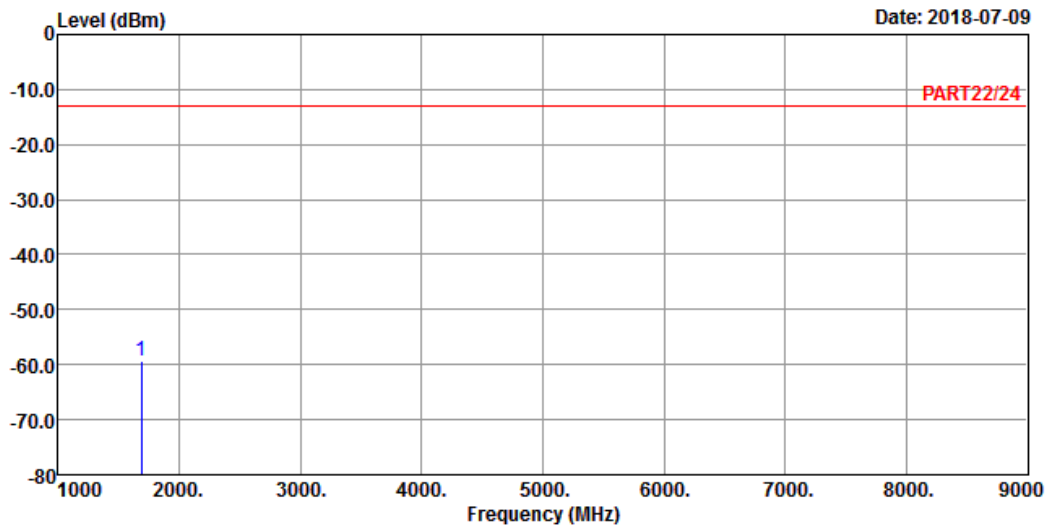

Site : 966 Chamber 5
 Condition: PART22/24 HORIZONTAL
 Remak : LTE Band 5 QPSK_10M Link_H-CH
 Tested by: Thomas Wei

Freq	Level	Read Level	Limit Line	Over Limit	Factor	Remark
MHz	dBm	dBm	dBm	dB	dB	

1 pp 1688.00 -59.47 -45.48 -13.00 -46.47 -13.99 Peak



A D T

Data: 2

Date: 2018-07-09

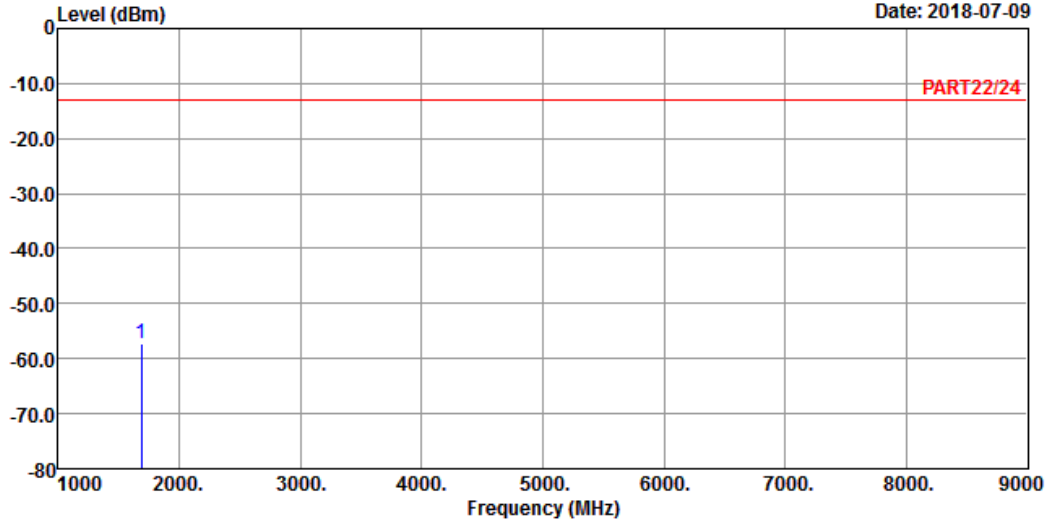

Site : 966 Chamber 5
 Condition: PART22/24 VERTICAL
 Remak : LTE Band 5 QPSK_10M Link_H-CH
 Tested by: Thomas Wei

Freq	Level	Read Level	Limit Line	Over Limit	Factor	Remark
MHz	dBm	dBm	dBm	dB	dB	
1 pp 1688.00	-57.30	-43.31	-13.00	-44.30	-13.99	Peak

LTE Band 26
 Channel Bandwidth: 15 MHz / QPSK
 Low Channel



Bureau Veritas Consumer Products Services Ltd., Taoyuan Branch

A D T

Data: 1

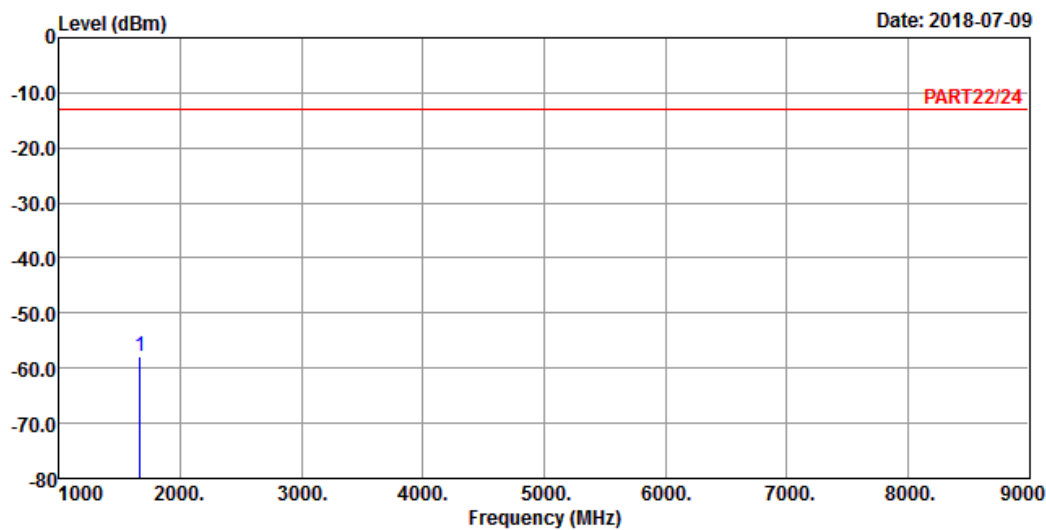

Site : 966 Chamber 5
 Condition: PART22/24 HORIZONTAL
 Remak : LTE Band 26 QPSK_15M Link_L-CH
 Tested by: Thomas Wei

Freq	Level	Read Level	Limit Line	Over Limit	Factor	Remark
MHz	dBm	dBm	dBm	dB	dB	
1 pp 1663.00	-57.74	-43.91	-13.00	-44.74	-13.83	Peak



A D T

Data: 2

Date: 2018-07-09

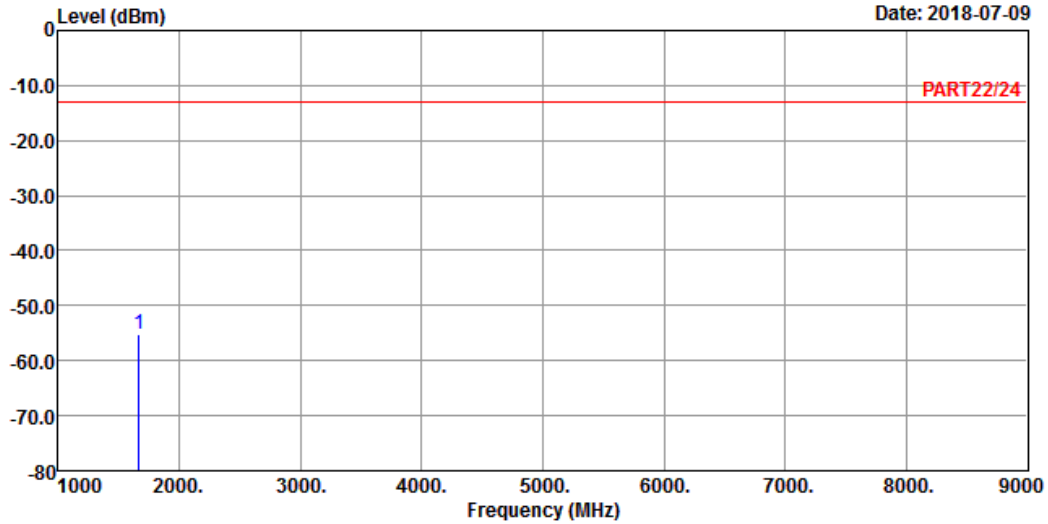

Site : 966 Chamber 5
 Condition: PART22/24 VERTICAL
 Remak : LTE Band 26 QPSK_15M Link_L-CH
 Tested by: Thomas Wei

Freq	Level	Read Level	Limit Line	Over Limit	Factor	Remark
MHz	dBm	dBm	dBm	dB	dB	
1 pp 1663.00	-55.09	-41.26	-13.00	-42.09	-13.83	Peak

Middle Channel



Bureau Veritas Consumer Products Services Ltd., Taoyuan Branch

A D T

Data: 5

Date: 2018-07-09

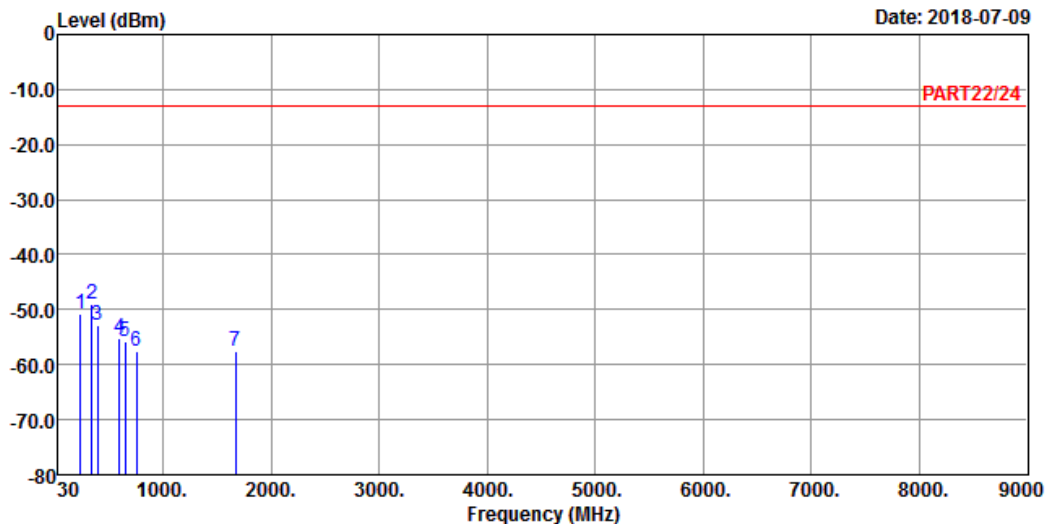

Site : 966 Chamber 5
 Condition: PART22/24 HORIZONTAL
 Remak : LTE Band 26 QPSK_15M Link_M-CH
 Tested by: Thomas Wei

	Freq	Level	Read Level	Limit Line	Over Limit	Factor	Remark
	MHz	dBm	dBm	dBm	dB	dB	
1	234.67	-50.87	-44.25	-13.00	-37.87	-6.62	Peak
2 pp	338.46	-49.12	-42.70	-13.00	-36.12	-6.42	Peak
3	389.87	-52.72	-46.72	-13.00	-39.72	-6.00	Peak
4	598.42	-55.14	-54.31	-13.00	-42.14	-0.83	Peak
5	650.80	-55.74	-54.87	-13.00	-42.74	-0.87	Peak
6	754.59	-57.55	-58.42	-13.00	-44.55	0.87	Peak
7	1673.00	-57.64	-43.74	-13.00	-44.64	-13.90	Peak



Bureau Veritas Consumer Products Services Ltd., Taoyuan Branch

A D T

Data: 6

Date: 2018-07-09

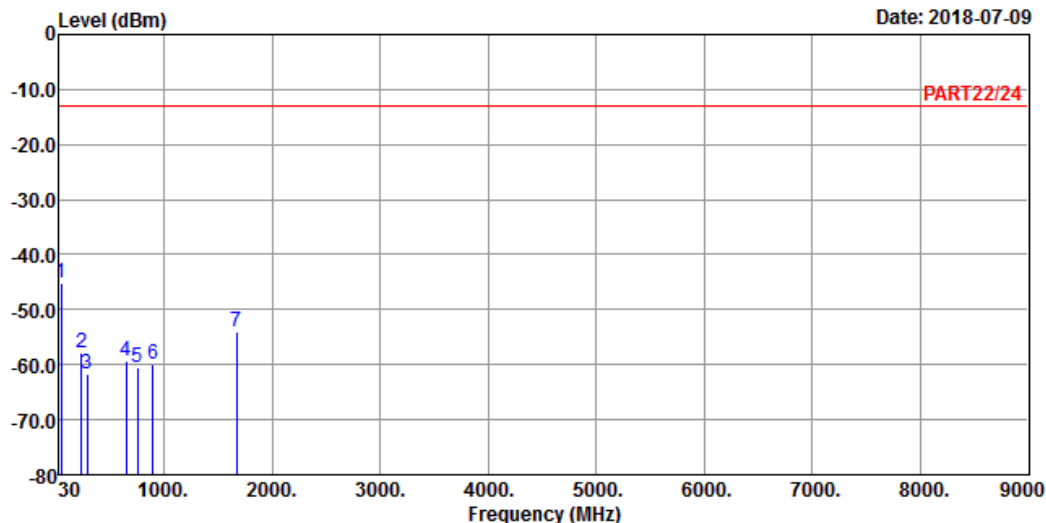

Site : 966 Chamber 5
 Condition: PART22/24 VERTICAL
 Remak : LTE Band 26 QPSK_15M Link_M-CH
 Tested by: Thomas Wei

	Freq	Level	Read Level	Limit Line	Over Limit	Factor	Remark
	MHz	dBm	dBm	dBm	dB	dB	
1 pp	43.58	-45.12	-43.65	-13.00	-32.12	-1.47	Peak
2	234.67	-57.75	-51.13	-13.00	-44.75	-6.62	Peak
3	286.08	-61.68	-54.95	-13.00	-48.68	-6.73	Peak
4	650.80	-59.19	-58.32	-13.00	-46.19	-0.87	Peak
5	754.59	-60.63	-61.50	-13.00	-47.63	0.87	Peak
6	895.24	-60.04	-60.58	-13.00	-47.04	0.54	Peak
7	1673.00	-54.06	-40.16	-13.00	-41.06	-13.90	Peak

High Channel



Bureau Veritas Consumer Products Services Ltd., Taoyuan Branch

A D T

Data: 1

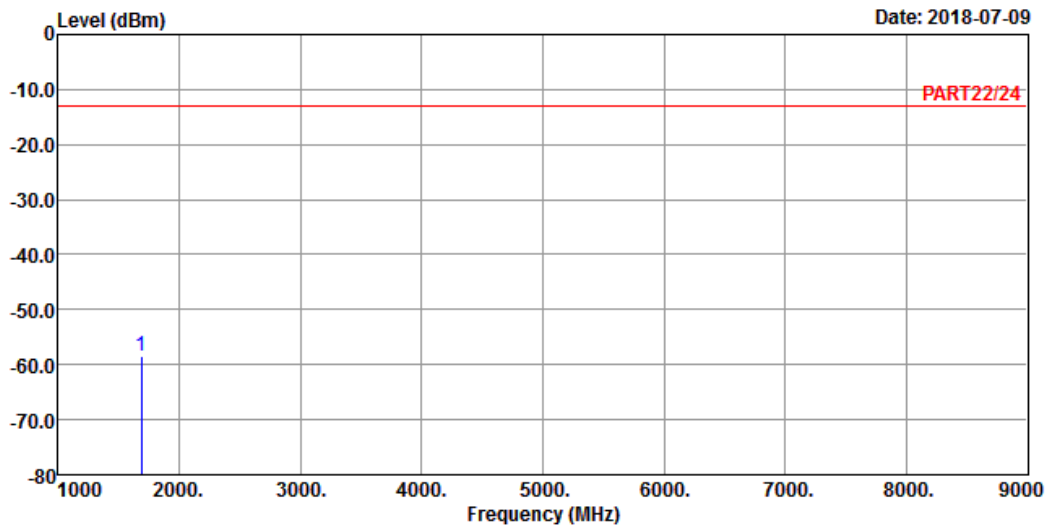

Date: 2018-07-09

Site : 966 Chamber 5
 Condition: PART22/24 HORIZONTAL
 Remak : LTE Band 26 QPSK_15M Link_H-CH
 Tested by: Thomas Wei

Freq	Level	Read Level	Limit Line	Over Limit	Factor	Remark
MHz	dBm	dBm	dBm	dB	dB	

1 pp 1683.00 -58.31 -44.35 -13.00 -45.31 -13.96 Peak



A D T

Data: 2

Date: 2018-07-09

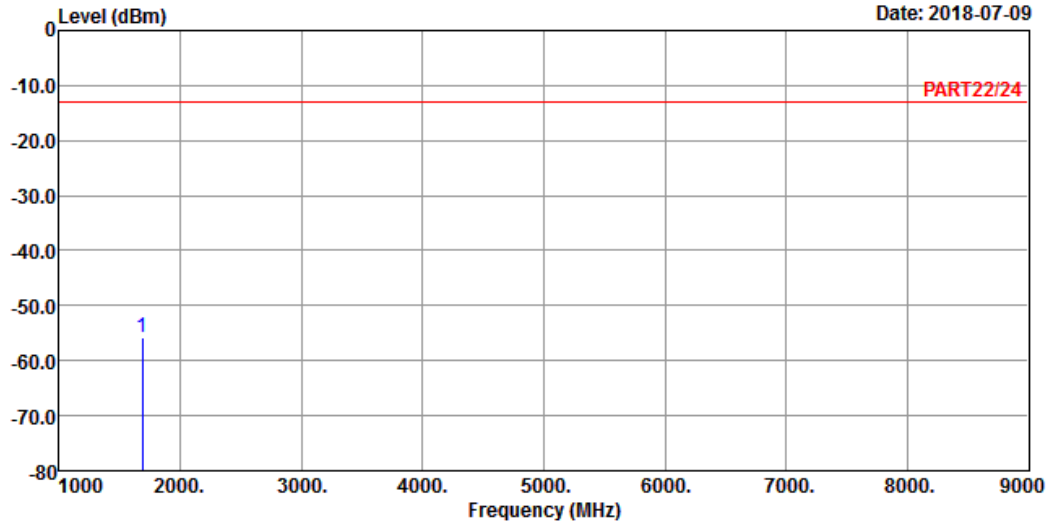

Site : 966 Chamber 5
 Condition: PART22/24 VERTICAL
 Remak : LTE Band 26 QPSK_15M Link_H-CH
 Tested by: Thomas Wei

Freq	Level	Read Level	Limit Line	Over Limit	Factor	Remark
MHz	dBm	dBm	dBm	dB	dB	
1 pp 1683.00	-55.73	-41.77	-13.00	-42.73	-13.96	Peak

5 Pictures of Test Arrangements

Please refer to the attached file (Test Setup Photo).

Appendix – Information on the Testing Laboratories

We, Bureau Veritas Consumer Products Services (H.K.) Ltd., Taoyuan Branch, were founded in 1988 to provide our best service in EMC, Radio, Telecom and Safety consultation. Our laboratories are FCC recognized accredited test firms and accredited according to ISO/IEC 17025.

If you have any comments, please feel free to contact us at the following:

Linko EMC/RF Lab

Tel: 886-2-26052180

Fax: 886-2-26051924

Hsin Chu EMC/RF/Telecom Lab

Tel: 886-3-6668565

Fax: 886-3-6668323

Hwa Ya EMC/RF/Safety

Tel: 886-3-3183232

Fax: 886-3-3270892

Email: service.adt@tw.bureauveritas.com

Web Site: www.bureauveritas-adt.com

The address and road map of all our labs can be found in our web site also.

--- END ---