



FCC 47 CFR PART 15 SUBPART C ANSI C63.10: 2013

TEST REPORT

For

Cherry Wireless Dongle

Model: JR-90

Brand: CHERRY

Issued to

CHERRY GmbH

Cherrystraße, 91275 Auerbach, Deutschland/Germany

Issued by

Compliance Certification Services Inc.

Tainan Lab.

No.8,Jiucengling, Xinhua Dist., Tainan City 712, Taiwan (R.O.C.)

TEL: (06) 580-2201

FAX: (06) 580-2202

Issued Date: June 07, 2018



Note: This report shall not be reproduced except in full, without the written approval of Compliance Certification Services Inc. This document may be altered or revised by Compliance Certification Services Inc. personnel only, and shall be noted in the revision section of the document.

Attention is drawn to the limitation of liability, indemnification and jurisdiction issues defined therein. Any holder of this document is advised that information contained hereon reflects the Company's findings at the time of its intervention only and within the limits of Client's instructions, if any. The Company's sole responsibility is to its Client and this document does not exonerate parties to a transaction from exercising all their rights and obligations under the transaction documents. This document cannot be reproduced except in full, without prior written approval of the Company. Any unauthorized alteration, forgery or falsification of the content or appearance of this document is unlawful and offenders may be prosecuted to the fullest extent of the law.



REVISION HISTORY

Rev.	Issue Date	Revisions	Effect Page	Revised By
00	June 07, 2018	Initial Issue	ALL	Sunny Chang



TABLE OF CONTENTS

1. TEST RESULT CERTIFICATION	4
2. EUT DESCRIPTION	5
3. TEST METHODOLOGY	6
3.1 EUT CONFIGURATION	6
3.2 EUT EXERCISE	6
3.3 GENERAL TEST PROCEDURES	6
3.4 FCC PART 15.205 RESTRICTED BANDS OF OPERATIONS	7
3.5 DESCRIPTION OF TEST MODES	7
4. INSTRUMENT CALIBRATION	8
4.1 MEASURING INSTRUMENT CALIBRATION.....	8
4.2 MEASUREMENT EQUIPMENT USED.....	8
4.3 MEASUREMENT UNCERTAINTY	9
5. FACILITIES AND ACCREDITATIONS	10
5.1 FACILITIES.....	10
5.2 EQUIPMENT	10
5.3 LABORATORY ACCREDITATIONS LISTING.....	10
5.4 TABLE OF ACCREDITATIONS AND LISTINGS	11
6. SETUP OF EQUIPMENT UNDER TEST.....	12
6.1 SETUP CONFIGURATION OF EUT.....	12
6.2 SUPPORT EQUIPMENT	12
6.3 CONFIGURATION OF SYSTEM UNDER TEST	13
6.4 EUT OPERATING CONDITION	14
7. FCC PART 15.249 REQUIREMENTS.....	15
7.1 20 DB BANDWIDTH	15
7.2 BAND EDGES MEASUREMENT	20
7.3 DUTY CYCLE	26
7.4 SPURIOUS EMISSION	30
7.5 POWERLINE CONDUCTED EMISSIONS	47
APPENDIX I - PHOTOGRAPHS OF TEST SETUP	48
APPENDIX II - PHOTOGRAPHS OF EUT	A1

1. TEST RESULT CERTIFICATION

Product: Cherry Wireless Dongle
Model: JR-90
Brand Name: CHERRY
Applicant: CHERRY GmbH
 Cherrystraße, 91275 Auerbach, Deutschland/Germany
Manufacturer: Jing Mold Electronic Tech. (Shen Zhen) Co., Ltd.
 Xin Qiao 3rd Industrial Estate, Sha Jing, Bao An, Shenzhen,
 Guangdong, P.R. China
Tested: June 01, 2018

APPLICABLE STANDARDS	
STANDARD	TEST RESULT
FCC 47 CFR Part 15 Subpart C ANSI C63.10: 2013	No non-compliance noted

We hereby certify that:

The above equipment was tested by Compliance Certification Services Inc. The test data, data evaluation, test procedures, and equipment configurations shown in this report were made in accordance with the procedures given in ANSI C63.10: 2013 and the energy emitted by the sample EUT tested as described in this report is in compliance with the requirements emission limits of FCC Rules Part 15.107, 15.109, 15.207, 15.209 and 15.249.

The test results of this report relate only to the tested sample identified in this report.

Approved by:

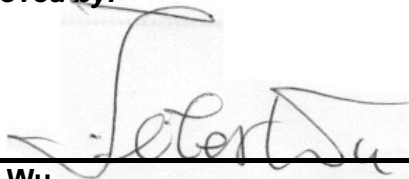

Jeter Wu
 Assistant Manager

Reviewed by:

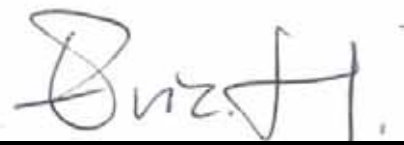

Eric Huang
 Section Manager



2. EUT DESCRIPTION

Product	Cherry Wireless Dongle
Model Number	JR-90
Brand Name	CHERRY
Received Date	May 23, 2018
Operation Frequency	2408 MHz ~ 2474 MHz
Transmit Peak Power	89.91dBuV/m
Transmit Data Rate	1Mbps
Type of Modulation	FSK
Number of Channels	34 Channels
Power Supply	DC 5V(Powered by PC)
Antenna Type	Type: Printed Antenna Model: N/A Manufacturer: N/A Gain: 0 dBi
RF Module Model	IC Chip model: MA60H416
Hardware Version	N/A
Software Version	N/A
Firmware Version	MA641BS-8_AES_V01test6_DDD7
Temperature Range	0°C ~ +40°C

Remark:

1. Client consigns only one model sample to test (Model Number: **JR-90**). Therefore, the testing Lab. just guarantees the unit, which has been tested.
2. This submittal(s) (test report) is intended for FCC ID: **GDDJR-90** filing to comply with Section 15.107 & 15.109 (FCC Part 15, Subpart B) and Section 15.207, 15.209, 15.249.
3. For more details, please refer to the User's manual of the EUT.
4. According to customer declaration Wireless Mouse for sale.

3. TEST METHODOLOGY

The tests documented in this report were performed in accordance with ANSI C63.10 and FCC CFR 47 2.1046, 2.1047, 2.1049, 2.1051, 2.1053, 2.1055, 2.1057, 15.207, 15.209 and 15.249.

3.1 EUT CONFIGURATION

The EUT configuration for testing is installed on RF field strength measurement to meet the Commissions requirement and operating in a manner that intends to maximize its emission characteristics in a continuous normal application.

3.2 EUT EXERCISE

The EUT was operated in the engineering mode to fix the TX frequency that was for the purpose of the measurements.

According to its specifications, the EUT must comply with the requirements of the Section 15.107 and 15.109 under the FCC Rules Part 15 Subpart B and Section 15.207, 15.209, 15.249 under the FCC Rules Part 15 Subpart C.

3.3 GENERAL TEST PROCEDURES

Conducted Emissions

The EUT is placed on the turntable, which is 0.8 m above ground plane. According to the requirements in Section 13.1.4.1 of ANSI C63.10 Conducted emissions from the EUT measured in the frequency range between 0.15 MHz and 30MHz using CISPR Quasi-peak and average detector modes.

Radiated Emissions

The EUT is placed on a turn table, which is 1.5 m above ground plane. The turntable shall rotate 360 degrees to determine the position of maximum emission level. EUT is set 3m away from the receiving antenna, which varied from 1m to 4m to find out the highest emission. And also, each emission was to be maximized by changing the polarization of receiving antenna both horizontal and vertical. In order to find out the maximum emissions, exploratory radiated emission measurements were made according to the requirements in Section 13.1.4.1 of ANSI C63.10.

3.4 FCC PART 15.205 RESTRICTED BANDS OF OPERATIONS

1. Except as shown in paragraph (d) of this section, only spurious emissions are permitted in any of the frequency bands listed below:

MHz	MHz	MHz	GHz
0.090 - 0.110	16.42 - 16.423	399.9 - 410	4.5 - 5.15
¹ 0.495 - 0.505	16.69475 - 16.69525	608 - 614	5.35 - 5.46
2.1735 - 2.1905	16.80425 - 16.80475	960 - 1240	7.25 - 7.75
4.125 - 4.128	25.5 - 25.67	1300 - 1427	8.025 - 8.5
4.17725 - 4.17775	37.5 - 38.25	1435 - 1626.5	9.0 - 9.2
4.20725 - 4.20775	73 - 74.6	1645.5 - 1646.5	9.3 - 9.5
6.215 - 6.218	74.8 - 75.2	1660 - 1710	10.6 - 12.7
6.26775 - 6.26825	108 - 121.94	1718.8 - 1722.2	13.25 - 13.4
6.31175 - 6.31225	123 - 138	2200 - 2300	14.47 - 14.5
8.291 - 8.294	149.9 - 150.05	2310 - 2390	15.35 - 16.2
8.362 - 8.366	156.52475 -	2483.5 - 2500	17.7 - 21.4
8.37625 - 8.38675	156.52525	2655 - 2900	22.01 - 23.12
8.41425 - 8.41475	156.7 - 156.9	3260 - 3267	23.6 - 24.0
12.29 - 12.293	162.0125 - 167.17	3332 - 3339	31.2 - 31.8
12.51975 - 12.52025	167.72 - 173.2	3345.8 - 3358	36.43 - 36.5
12.57675 - 12.57725	240 - 285	3600 - 4400	(²)
13.36 - 13.41	322 - 335.4		

¹ Until February 1, 1999, this restricted band shall be 0.490-0.510 MHz.

² Above 38.6

2. Except as provided in paragraphs (d) and (e), the field strength of emissions appearing within these frequency bands shall not exceed the limits shown in Section 15.209. At frequencies equal to or less than 1000 MHz, compliance with the limits in Section 15.209 shall be demonstrated using measurement instrumentation employing a CISPR quasi-peak detector. Above 1000 MHz, compliance with the emission limits in Section 15.209 shall be demonstrated based on the average value of the measured emissions. The provisions in Section 15.35 apply to these measurements.

3.5 DESCRIPTION OF TEST MODES

The EUT (**Model: JR-90**) had been tested under engineering test mode condition and the EUT staying in continuous transmitting mode.

Note :

The field strength of spurious emission was measured in the following position:

- 1) The field strength of spurious emission was measured in the following position: EUT stand-up position (Y axis), lie-down position (X, Z axis). The worst emission was found in lie-down position (X axis) and the worst case was recorded.

4. INSTRUMENT CALIBRATION

4.1 MEASURING INSTRUMENT CALIBRATION

The measuring equipment, which was utilized in performing the tests documented herein, has been calibrated in accordance with the manufacturer's recommendations for utilizing calibration equipment, which is traceable to recognized national standards.

4.2 MEASUREMENT EQUIPMENT USED

Equipment Used for Emissions Measurement

Open Area Test Site # 6				
Name of Equipment	Manufacturer	Model	Serial Number	Calibration Due
Active Loop Antenna	ETS-LINDREN	6502	8905-2356	07/19/2019
Amplifier	HP	8447F	2443A01671	01/21/2019
Bi-Log Antenna	Sunol	JB1	A070506-2	02/08/2019
Cable	RosnoI+Suhner	SUCOFLEX 104PEA	SN25737 /4PEA	01/26/2019
Double Ridged Guide Horn Antenna	ETS-LINDGREN	3116	00078900	03/19/2019
EMI Test Receiver	R&S	ESCI	100782	06/11/2018
Horn Antenna	Com-Power	AH-118	071032	04/18/2019
Pre-Amplifier	EMCI	EMC012645	980098	01/21/2019
PSA Series Spectrum Analyzer	Agilent	E4446A	MY43360132	06/06/2019
Software	Excel			

Remark: Each piece of equipment is scheduled for calibration once a year.

4.3 MEASUREMENT UNCERTAINTY

Parameter	Uncertainty
Radiated Emission, 30 to 200 MHz Test Site : OATS-6	±3.21dB
Radiated Emission, 200 to 1000 MHz Test Site : OATS-6	±3.09dB
Radiated Emission, 1 to 8 GHz	± 2.65dB
Radiated Emission, 8 to 18 GHz	± 2.69dB
Radiated Emission, 18 to 26.5 GHz	± 2.65dB
Radiated Emission, 26 to 40 GHz	± 3.03dB
Power Line Conducted Emission	± 1.91dB

Uncertainty figures are valid to a confidence level of 95%, k=2

5. FACILITIES AND ACCREDITATIONS

5.1 FACILITIES

All measurement facilities used to collect the measurement data are located at

No.8, Jiucengling, Xinhua Dist., Tainan City 712, Taiwan (R.O.C.)

The sites are constructed in conformance with the requirements of ANSI C63.7:1992, ANSI C63.10: 2013 and CISPR Publication 22.

5.2 EQUIPMENT

Radiated emissions are measured with one or more of the following types of linearly polarized antennas: tuned dipole, biconical, log periodic, bi-log, and/or ridged waveguide, horn. Spectrum analyzers with pre-selectors and quasi-peak detectors are used to perform radiated measurements.

Conducted emissions are measured with Line Impedance Stabilization Networks and EMI Test Receivers.

Calibrated wideband preamplifiers, coaxial cables, and coaxial attenuators are also used for making measurements.

All receiving equipment conforms to CISPR Publication 16-1, "Radio Interference Measuring Apparatus and Measurement Methods."

5.3 LABORATORY ACCREDITATIONS LISTING

The test facilities used to perform radiated and conducted emissions tests are accredited by Taiwan Accreditation Foundation for the specific scope of accreditation under Lab Code: 1109 to perform Electromagnetic Interference tests according to FCC PART 15 AND CISPR 22 requirements. No part of this report may be used to claim or imply product endorsement by TAF or any agency of the Government. In addition, the test facilities are listed with Federal Communications Commission (registration no: TW1109).

5.4 TABLE OF ACCREDITATIONS AND LISTINGS

Our laboratories are accredited and approved by the following accreditation body according to ISO/IEC 17025.

Taiwan	TAF
---------------	-----

The measuring facility of laboratories has been authorized or registered by the following approval agencies.

Canada	Industry Canada
Germany	TUV NORD
Taiwan	BSMI
USA	FCC

Copies of granted accreditation certificates are available for downloading from our web site, <http://www.ccsrf.com>

6. SETUP OF EQUIPMENT UNDER TEST

6.1 SETUP CONFIGURATION OF EUT

See test photographs attached in Appendix I for the actual connections between EUT and support equipment.

6.2 SUPPORT EQUIPMENT

【RF】

No.	Product	Manufacturer	Model No.	Certify No.	Signal cable
1	Note book	Acer	AS 3830TG	DOC	---

No.	Signal cable description				
A	N/A				---

【EMC】

No.	Product	Manufacturer	Model No.	Certify No.	Signal cable
1	Note book	Acer	AS 3830TG	DOC	---

No.	Signal cable description				
A	N/A				---

Remark:

1. All the equipment/cables were placed in the worst-case configuration to maximize the emission during the test.
2. Grounding was established in accordance with the manufacturer's requirements and conditions for the intended use.

6.3 CONFIGURATION OF SYSTEM UNDER TEST

【RF】

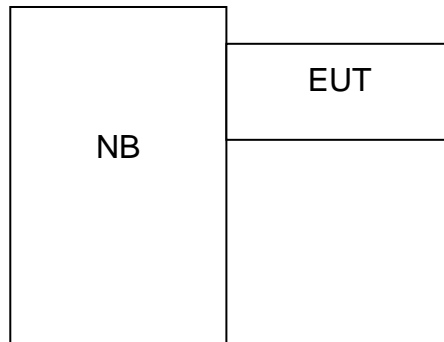

【EMC】

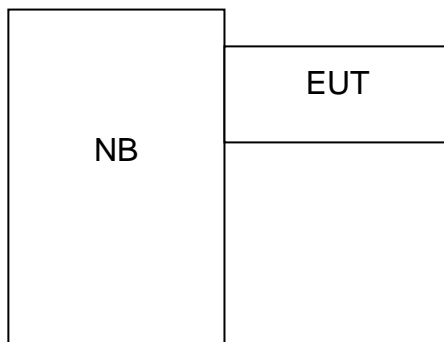

6.4 EUT OPERATING CONDITION

RF Setup

1. Set up all computers like the setup diagram.
2. The “RF TEST & EMI MODE V1.0.0.3” software was used for testing

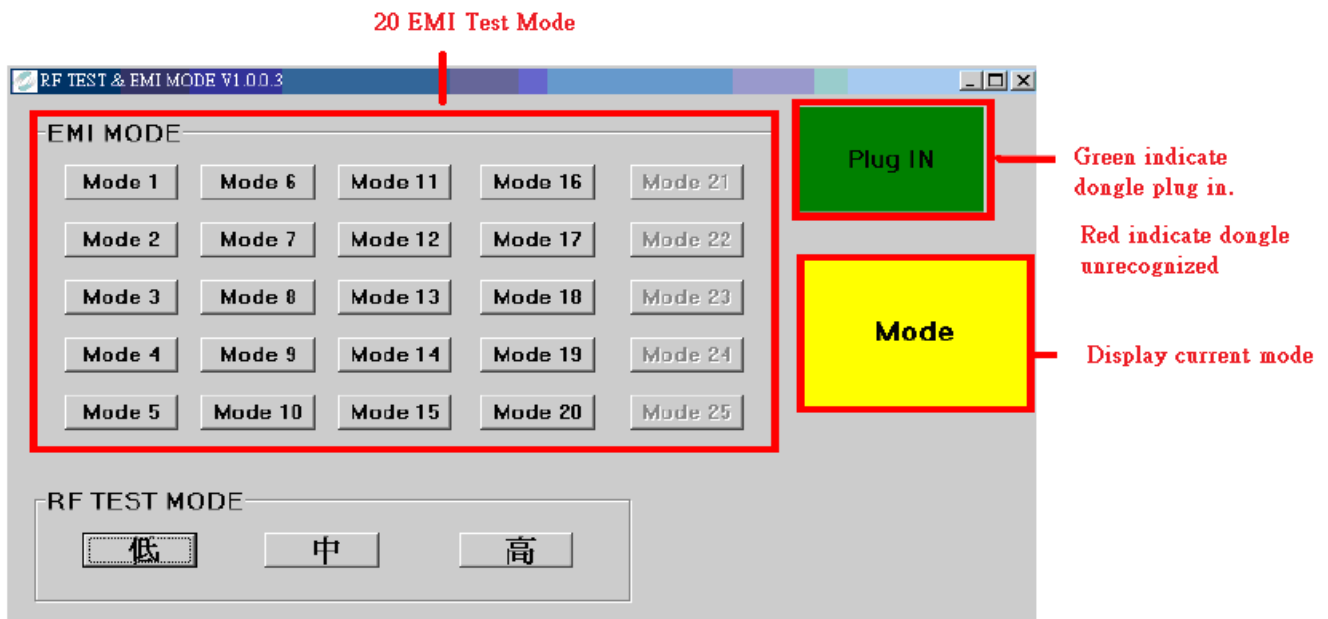

Mode1. is into Scan Mode in range 2408~2474MHz (34ch)transmission frequency.,
 Mode2 is into Modulation frequency 2408MHz ($\pm 500K$), continuous emission.
 Mode3 is into Modulation frequency 2440MHz ($\pm 500K$), continuous emission.
 Mode4 is into Modulation frequency 2474MHz ($\pm 500K$), continuous emission.
 Mode5 is into Modulation frequency 2408MHz ($\pm 500K$), continuous receive.
 Mode6 is into Modulation frequency 2440MHz ($\pm 500K$), continuous receive.
 Mode7 is into Modulation frequency 2474MHz ($\pm 500K$), continuous receive.
 Mode8 is into Non-Modulation frequency 2408MHz ($\pm 500K$), continuous emission.
 Mode9 is into Non-Modulation frequency 2440MHz ($\pm 500K$), continuous emission.
 Mode10 is into Non-Modulation frequency 2474MHz ($\pm 500K$), continuous emission.
 Mode11 is into Non-Modulation frequency 2408MHz ($\pm 500K$), continuous receive.
 Mode12 is into Non-Modulation frequency 2440MHz ($\pm 500K$), continuous receive.,
 Mode13 is into Non-Modulation frequency 2474MHz ($\pm 500K$), continuous receive.
 Mode14 is into Non-Modulation frequency 2408MHz, continuous emission.
 Mode15 is into Non-Modulation frequency 2440MHz, continuous emission.
 Mode16 is into Non-Modulation frequency 2474MHz, continuous emission.
 Mode17 is into Non-Modulation frequency 2408MHz, continuous receive.
 Mode18 is into Non-Modulation frequency 2440MHz, continuous receive.
 Mode19 is into Non-Modulation frequency 2474MHz, continuous receive.
 Mode20 is single channel frequency hopping, frequency hopping time is 250ms to transmit 4ms data

7. FCC PART 15.249 REQUIREMENTS

7.1 20 DB BANDWIDTH

LIMIT

None; for reporting purposes only.

MEASUREMENT EQUIPMENT USED

Chamber Room #966				
Name of Equipment	Manufacturer	Model	Serial Number	Calibration Due
Active Loop Antenna	ETS-LINDREN	6502	8905-2356	07/19/2019
Amplifier	HP	8447F	2443A01671	01/21/2019
Bi-Log Antenna	Sunol	JB1	A070506-2	02/08/2019
Cable	Rosnol+Suhner	SUCOFLEX 104PEA	SN25737 /4PEA	01/26/2019
Double Ridged Guide Horn Antenna	ETS-LINDGREN	3116	00078900	03/19/2019
EMI Test Receiver	R&S	ESCI	100782	06/11/2018
Horn Antenna	Com-Power	AH-118	071032	04/18/2019
Pre-Amplifier	EMCI	EMC012645	980098	01/21/2019
PSA Series Spectrum Analyzer	Agilent	E4446A	MY43360132	06/06/2019
Software	Excel			

Remark: Each piece of equipment is scheduled for calibration once a year.

TEST CONFIGURATION

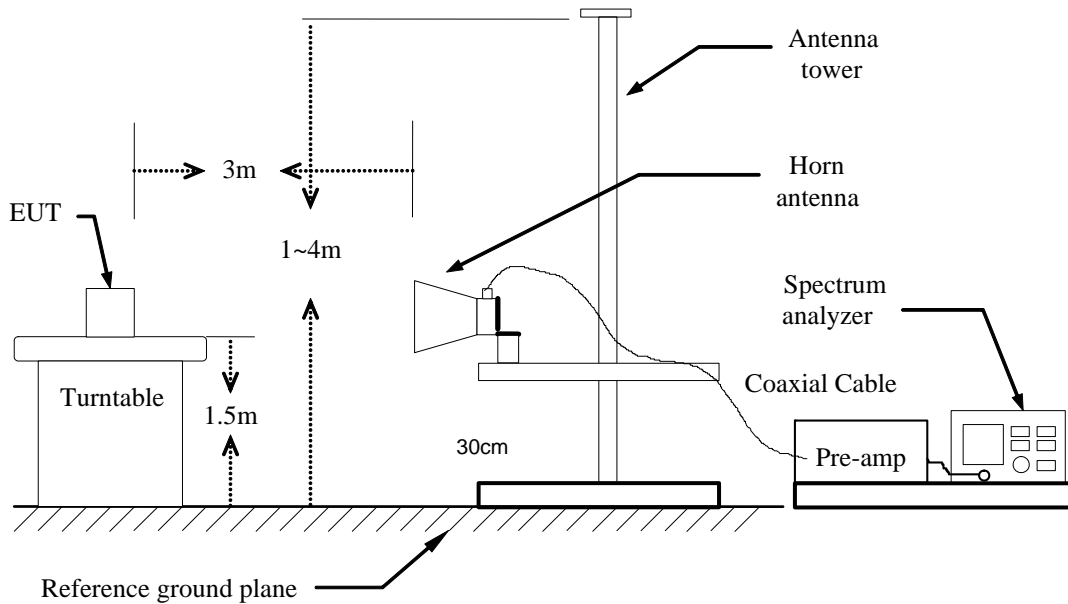

TEST PROCEDURE

1. The EUT is placed on a turntable, which is 1.5m above ground plane.
2. The turntable shall be rotated for 360 degrees to determine the position of maximum emission level.
3. EUT is set 3m away from the receiving antenna, which is varied from 1m to 4m to find out the highest emissions.
4. Maximum procedure was performed on the six highest emissions to ensure EUT compliance.
5. And also, each emission was to be maximized by changing the polarization of receiving antenna both horizontal and vertical.
6. Set the spectrum analyzer in the following setting as:
 RBW is set to 10 kHz and VBW is set 300kHz.

TEST RESULTS

No non-compliance noted.

TEST DATA

Operation Mode: Normal Operation

Test Date: 2018/06/01

Temperature: 26.5°C

Tested by: Ted Huang

Humidity: 44% RH

Polarity: Ver. / Hor.

Channel	Frequency (MHz)	20 dB Bandwidth (MHz)	Limit (MHz)
LOW	2408	2.13	12.04
MIDDLE	2440	2.12	12.20
HIGH	2474	2.12	12.37



TEST PLOT

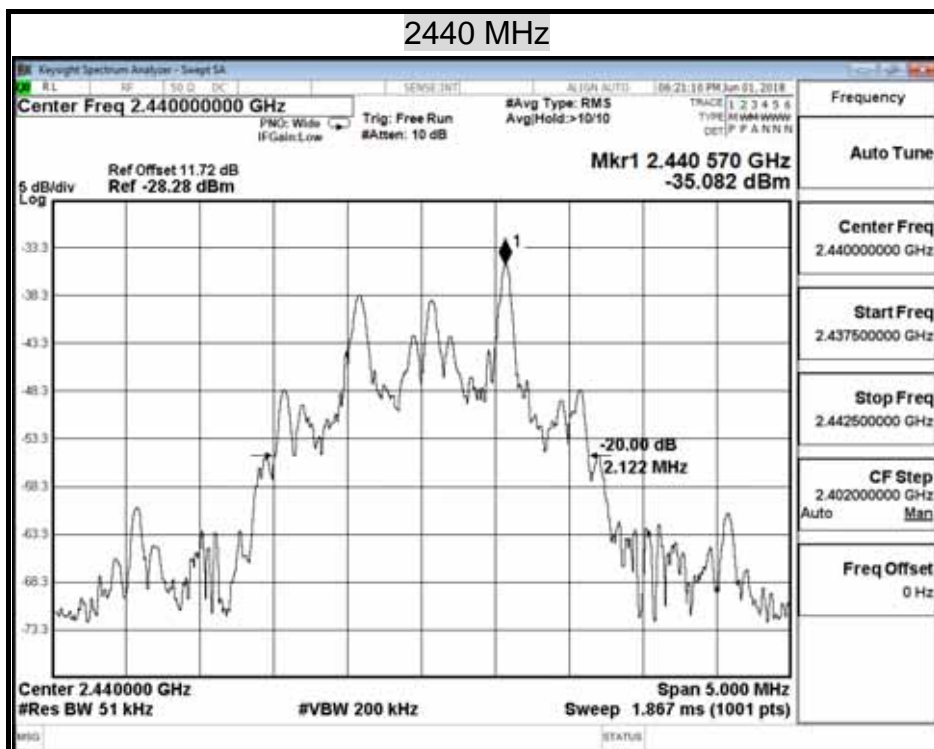
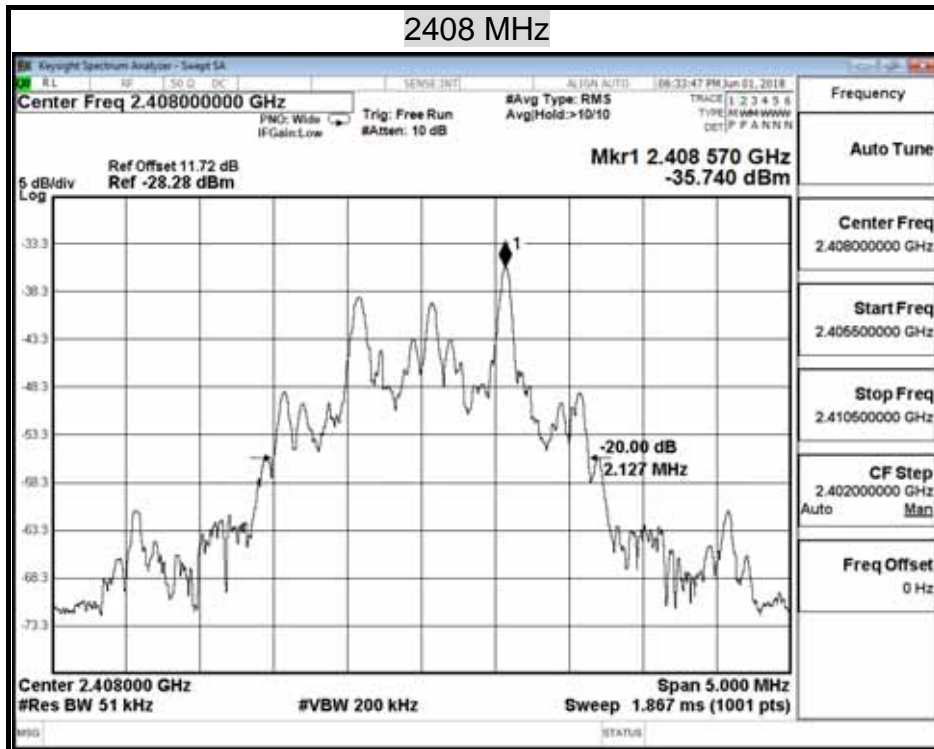

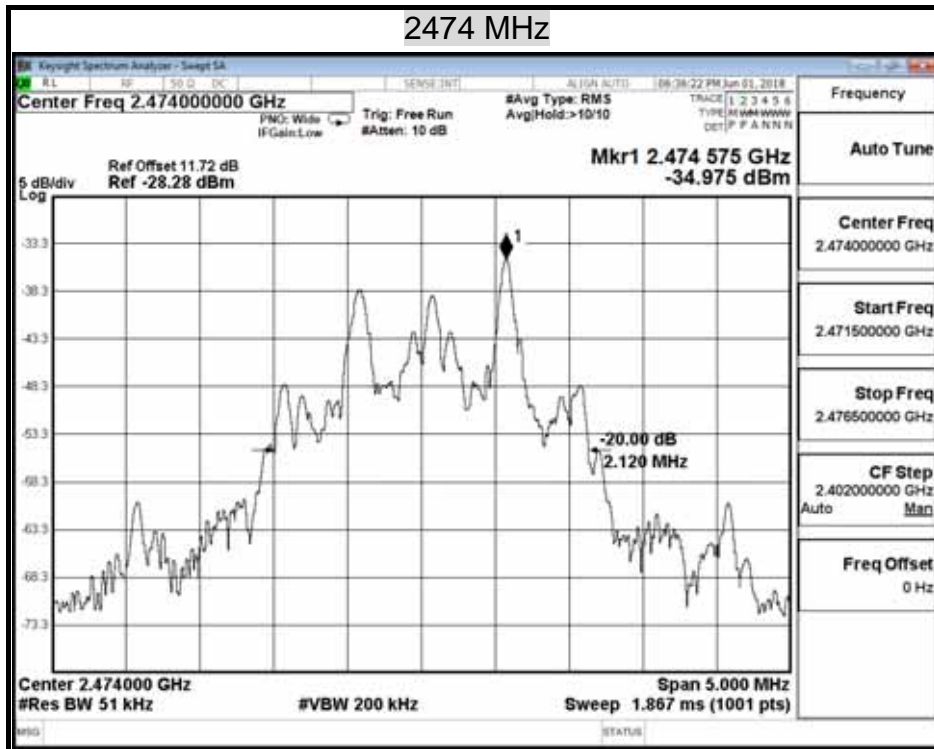

7.2 BAND EDGES MEASUREMENT

LIMIT

1. In the above emission table, the tighter limit applies at the band edges.

Frequency (MHz)	Field Strength ($\mu\text{V}/\text{m}$ at 3-meter)	Field Strength ($\text{dB}\mu\text{V}/\text{m}$ at 3-meter)
30-88	100	40
88-216	150	43.5
216-960	200	46
Above 960	500	54

2. As shown in Section 15.35(b), for frequencies above 1000 MHz, the above field strength limits in paragraphs (a) and (b) of this section are based on average limits. However, the peak field strength of any emission shall not exceed the maximum permitted average limits specified above by more than 20 dB under any condition of modulation. For point-to-point operation under paragraph (b) of this section, the peak field strength shall not exceed 2500 millivolts/meter at 3 meters along the antenna azimuth.

TEST CONFIGURATION

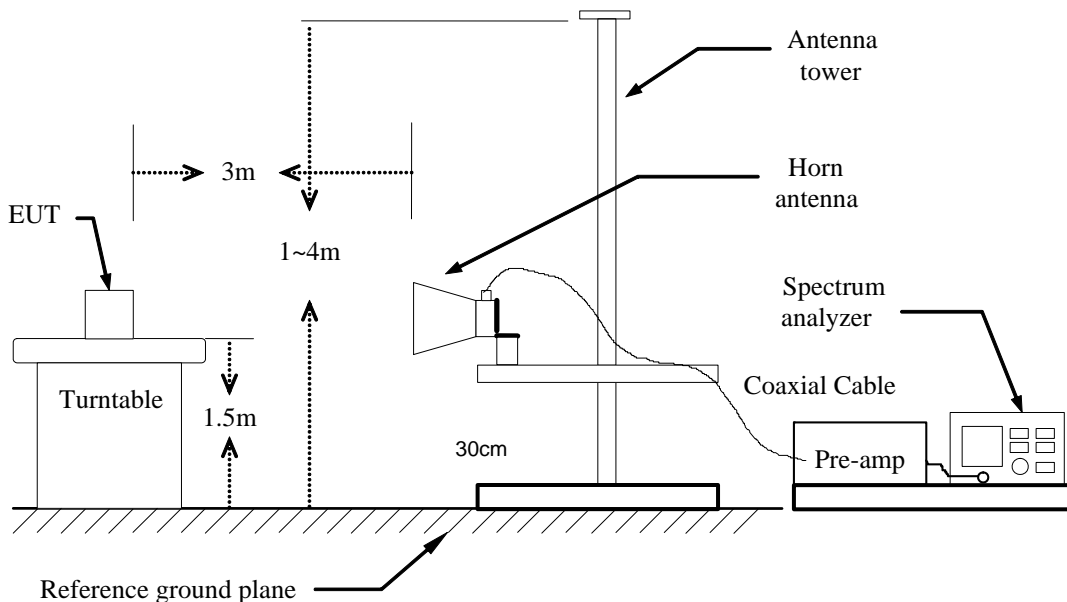



TEST PROCEDURE

1. The EUT is placed on a turntable, which is 1.5m above the ground plane.
2. The turntable shall be rotated for 360 degrees to determine the position of maximum emission level.
3. EUT is set 3m away from the receiving antenna, which is varied from 1m to 4m to find out the highest emission.
4. Set the spectrum analyzer in the following setting in order to capture the lower and upper band-edges of the emission:
 - (a) PEAK: RBW=1MHz , VBW=3MHz / Sweep=AUTO
 - (b) AVERAGE: Peak Level + Duty Factor
5. Repeat the procedures until all the PEAK and AVERAGE versus polarization are measured.

TEST RESULTS

Operation Mode: Normal Operation

Temperature: 26.5°C

Humidity: 44% RH

Test Date: 2018/06/01

Tested by: Ted Huang

Polarity: Ver. / Hor.



TEST PLOT

Detector mode : Peak

Polarity : Horizontal

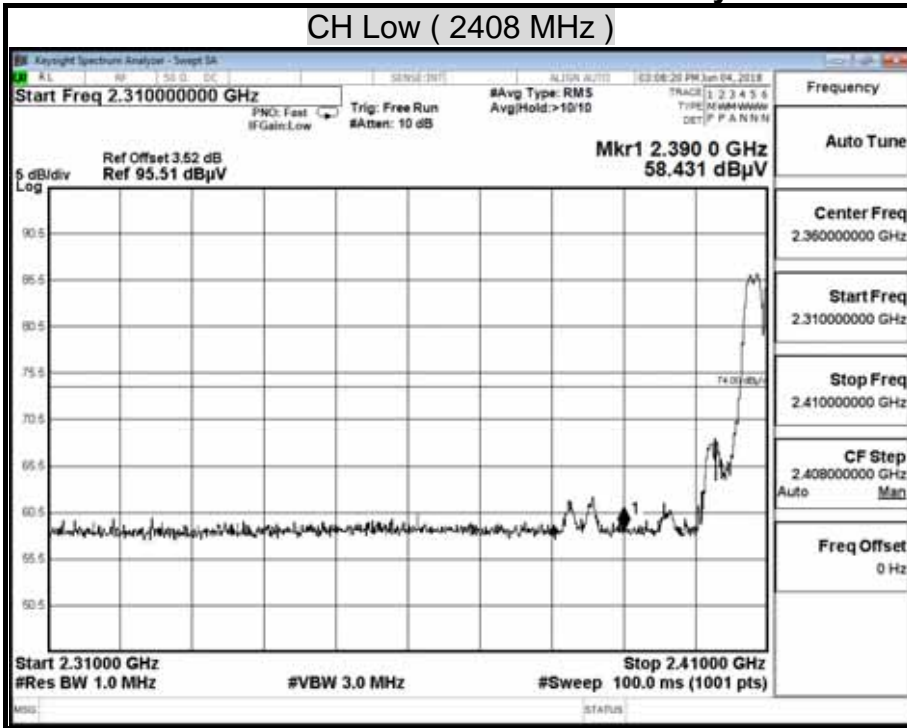

Detector mode : Average

Polarity : Horizontal

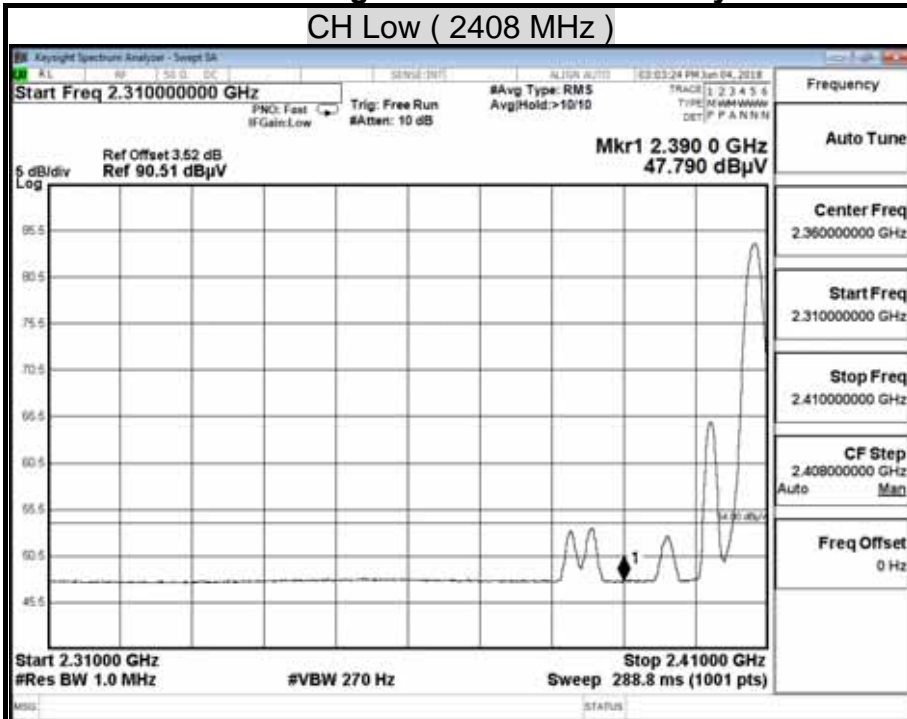

Detector mode : Peak

Polarity : Vertical

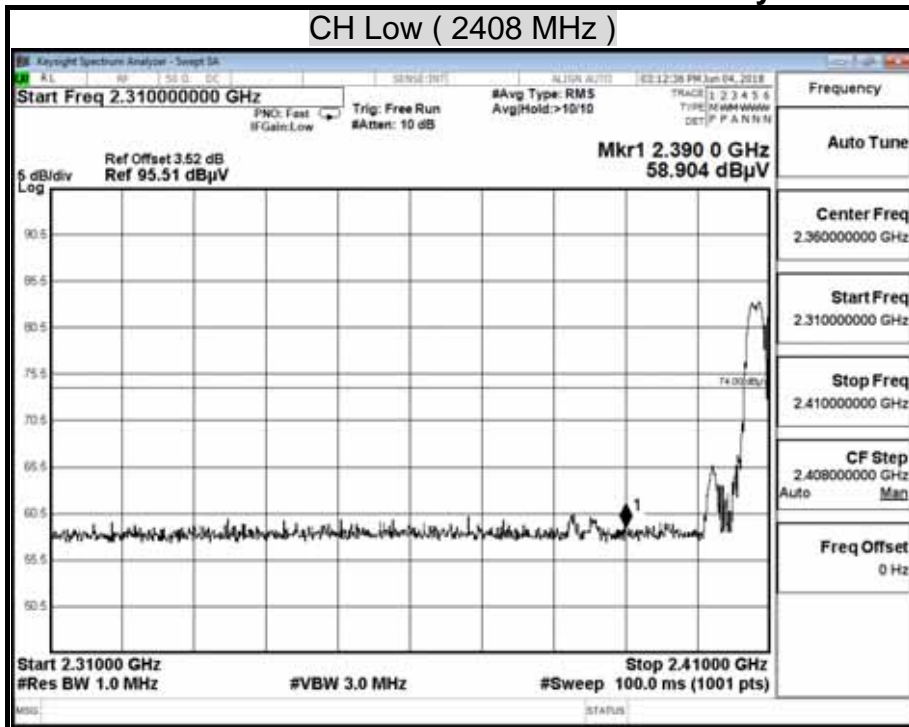

Detector mode : Average

Polarity : Vertical

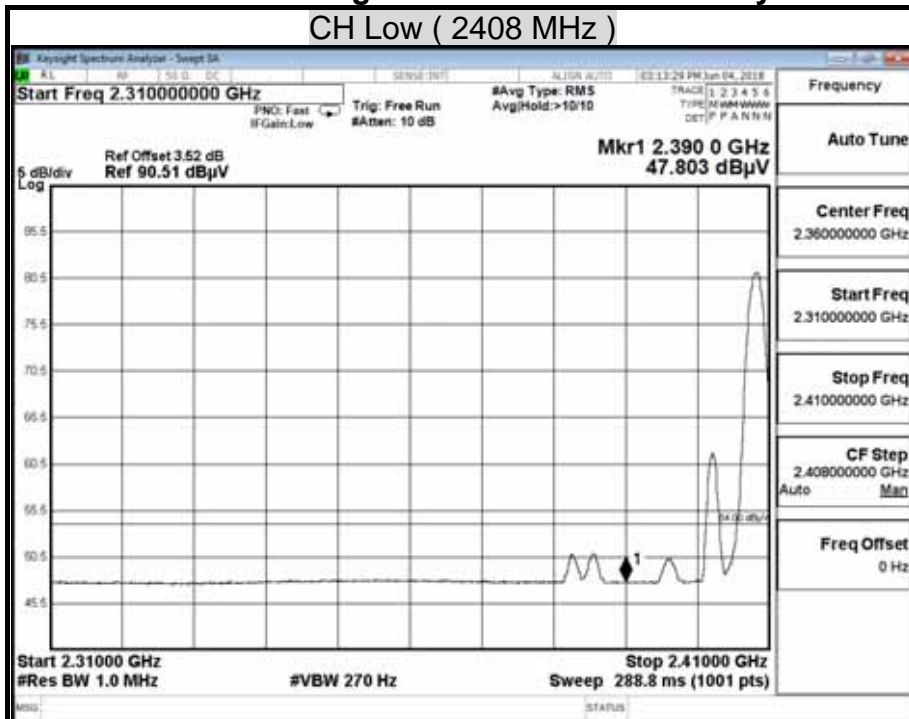

Detector mode : Peak

Polarity : Horizontal

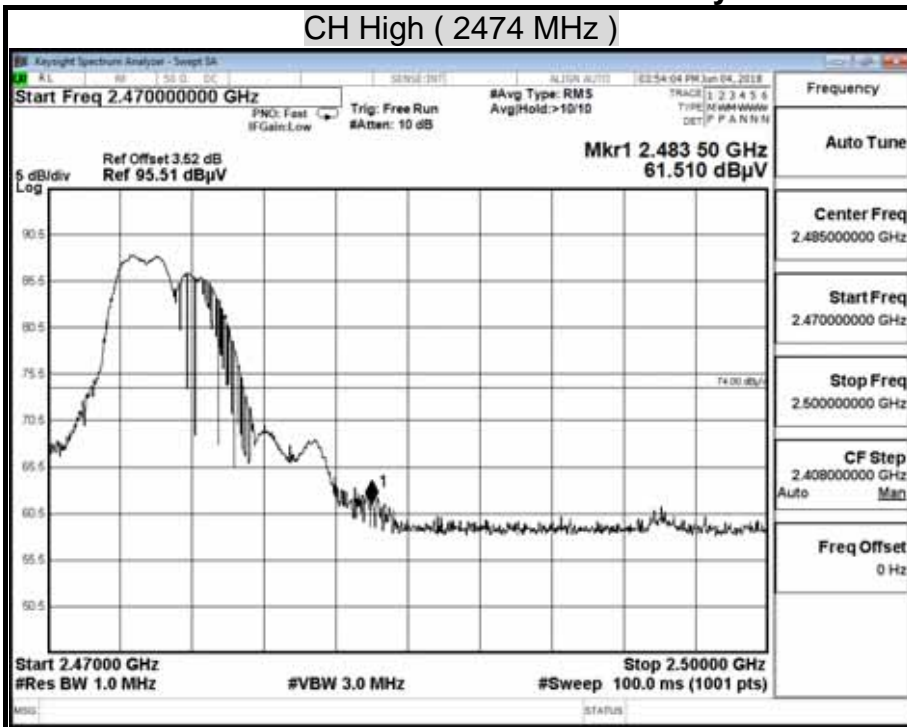

Detector mode : Average

Polarity : Horizontal

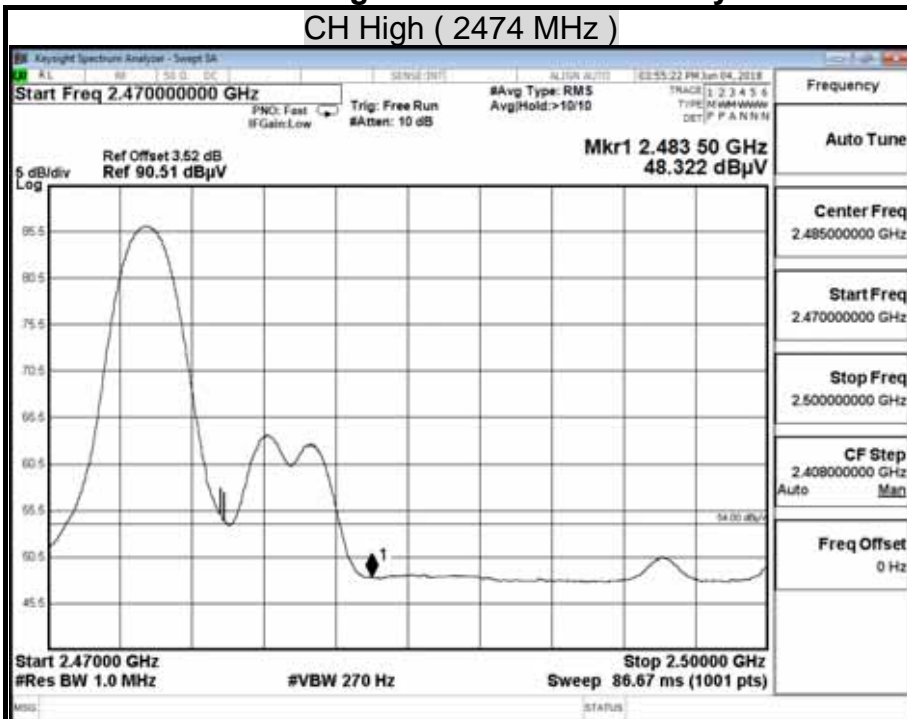

Detector mode : Peak

Polarity : Vertical

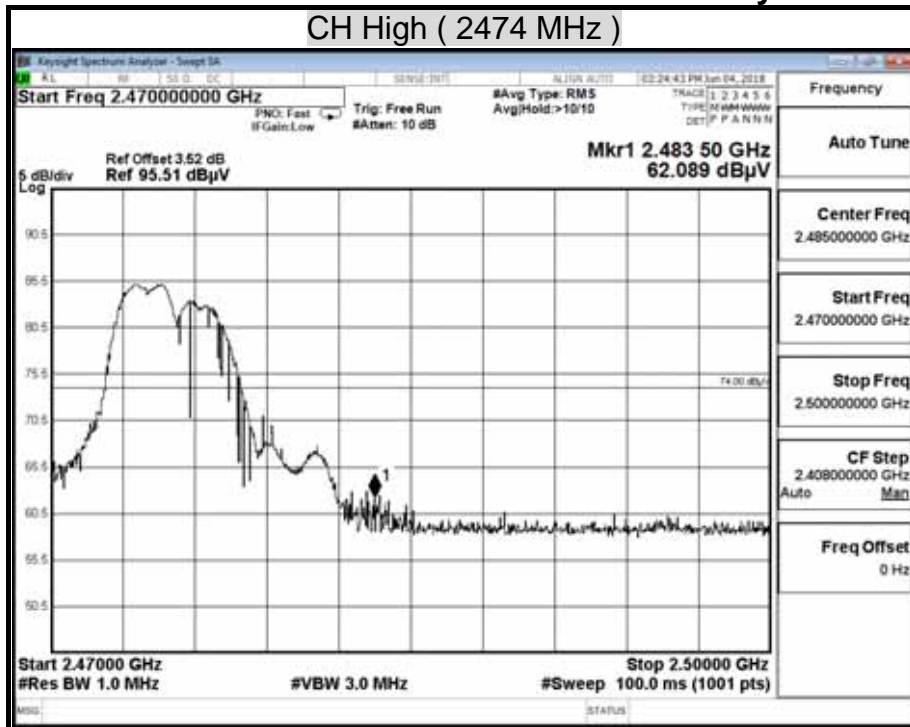

Detector mode : Average

Polarity : Vertical

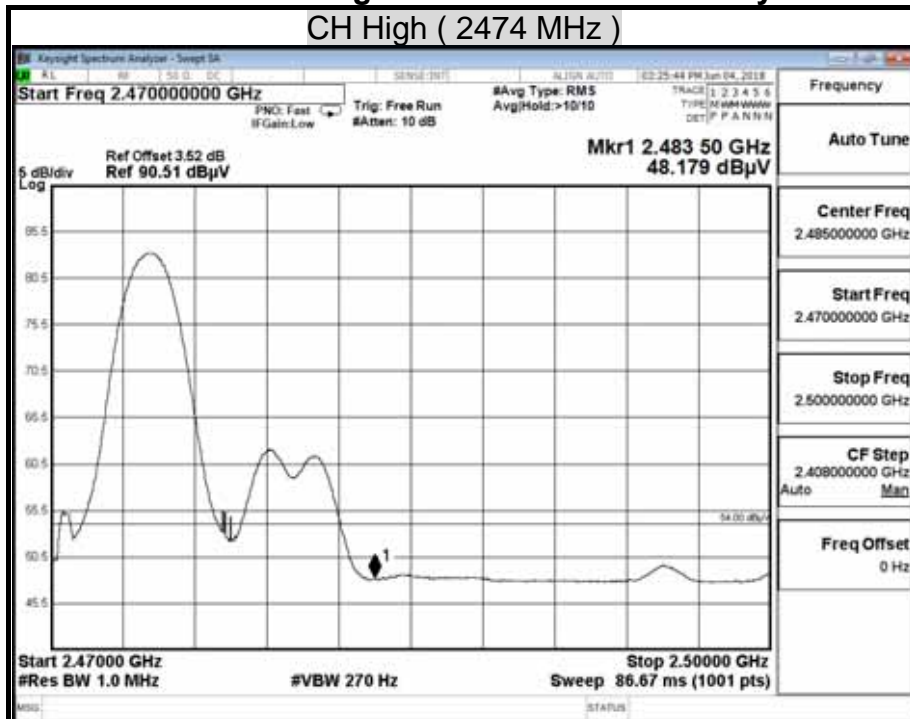

7.3 DUTY CYCLE

LIMIT

Nil (No dedicated limit specified in the Rules)

MEASUREMENT EQUIPMENT USED

Name of Equipment	Manufacturer	Model	Serial Number	Calibration Due
PSA Series Spectrum Analyzer	Agilent	E4446A	MY43360132	06/06/2019

Remark: Each piece of equipment is scheduled for calibration once a year.

TEST CONFIGURATIONS

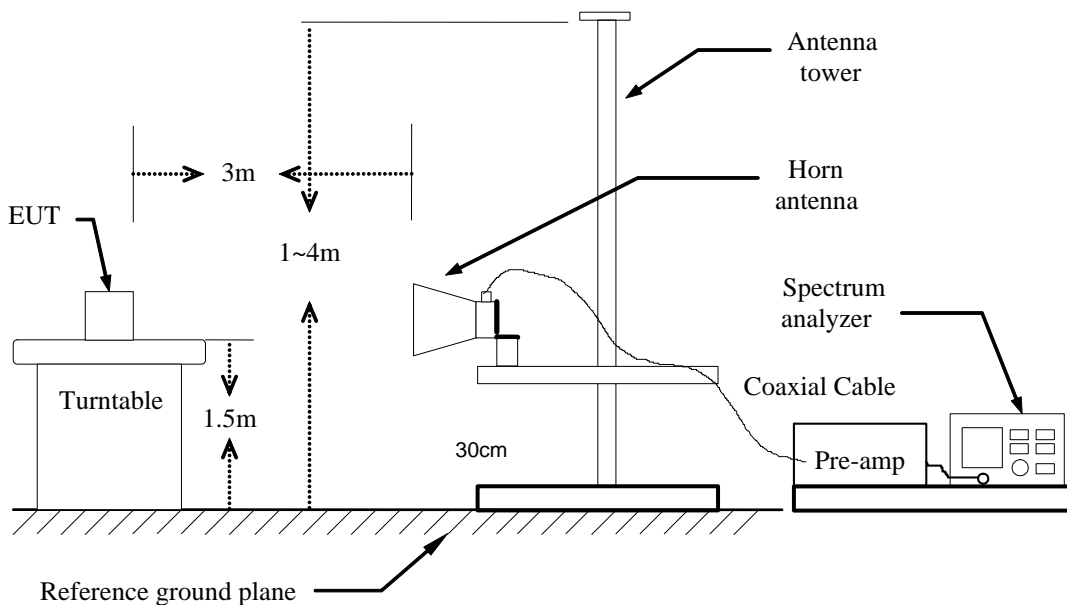

TEST PROCEDURE

1. Place the EUT on the table and set it in transmitting mode.
2. Set center frequency of spectrum analyzer = operating frequency.
3. Set the spectrum analyzer as RBW, VBW=100KHz, Span = 0Hz, a suitable Sweep Time.
4. Repeat above procedures until all frequency measured were complete.

TEST RESULTS

No non-compliance noted.



TEST DATA

Operation Mode: Normal Operation

Test Date: 2018/06/01

Temperature: 26.5°C

Tested by: Ted Huang

Humidity: 44% RH

Polarity: Ver. / Hor.

	us	Times	Ton	Total Ton time(ms)
Ton1	3800.000	1	3800.000	3.800
Ton2		0	0.000	
Ton3		0	0.000	
Tp				100.000

Ton	3.800
Tp(Ton+Toff)	100.000
Duty Cycle	0.038
Duty Factor	-20.000

3.8 %



TEST PLOT

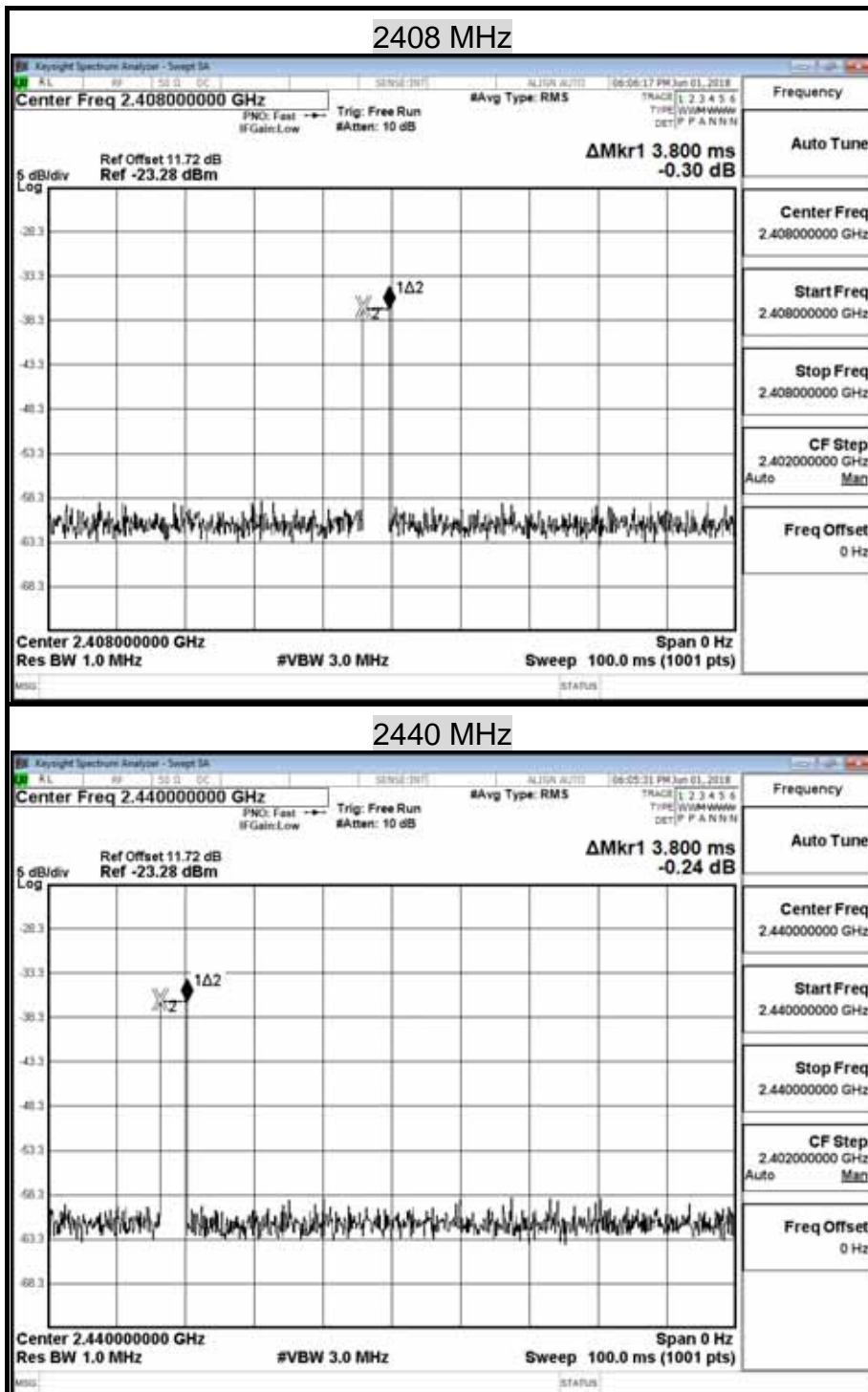

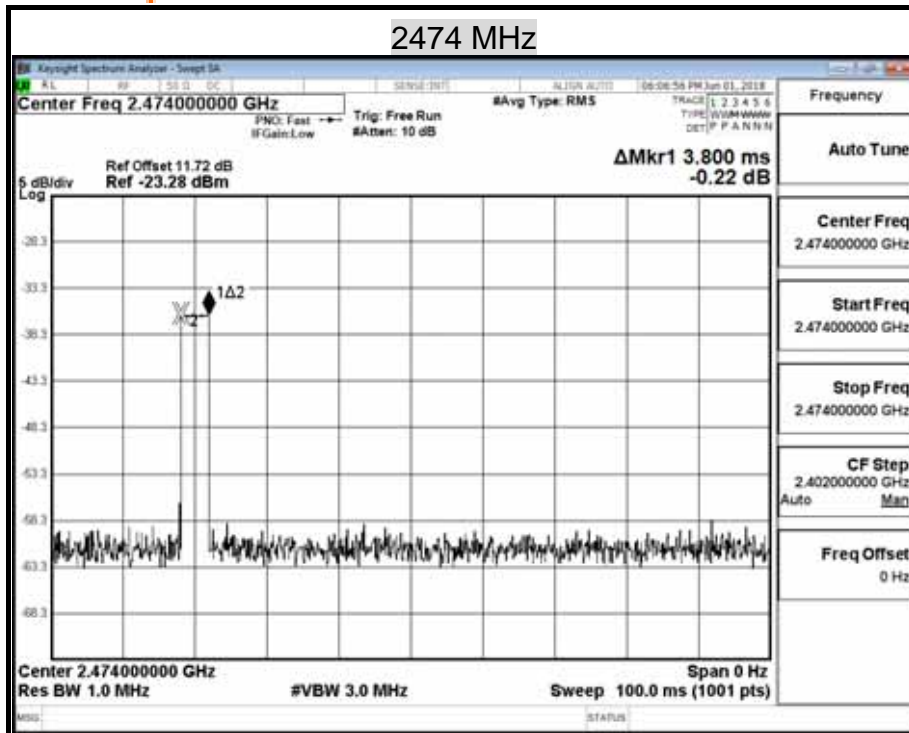

7.4 SPURIOUS EMISSION

LIMIT

1. In the section 15.249(a):

Except as provided in paragraph (b) of this section, the field strength of emissions from intentional radiators operated within these frequency bands shall comply with the following:

Fundamental Frequency (MHz)	Field Strength of Fundamental Field Strength (mV/m)	Field Strength of Harmonics (μ V/m)
902-928 MHz	50	500
2400 - 2483.5 MHz	50	500
5725 - 5875 MHz	50	500
24.0 - 24.25 GHz	250	2500

2. Except as provided elsewhere in this Subpart, the emissions from an intentional radiator shall not exceed the field strength levels specified in the following table:

Frequency (MHz)	Field Strength (μ V/m)	Measurement Distance (m)
30-88	100*	3
88-216	150*	3
216-960	200*	3
Above 960	500	3

Remark: Except as provided in paragraph (g), fundamental emissions from intentional radiators operating under this Section shall not be located in the frequency bands 54-72 MHz, 76-88 MHz, 174-216 MHz or 470-806 MHz. However, operation within these frequency bands is permitted under other sections of this Part, e.g., Sections 15.231 and 15.241.

3. In the above emission table, the tighter limit applies at the band edges.

Frequency (MHz)	Field Strength (μ V/m at 3-meter)	Field Strength (dB μ V/m at 3-meter)
30-88	100	40
88-216	150	43.5
216-960	200	46
Above 960	500	54

MEASUREMENT EQUIPMENT USED

Chamber Room #966				
Name of Equipment	Manufacturer	Model	Serial Number	Calibration Due
Active Loop Antenna	ETS-LINDREN	6502	8905-2356	07/19/2019
Amplifier	HP	8447F	2443A01671	01/21/2019
Bi-Log Antenna	Sunol	JB1	A070506-2	02/08/2019
Cable	Rosnol+Suhner	SUCOFLEX 104PEA	SN25737 /4PEA	01/26/2019
Double Ridged Guide Horn Antenna	ETS-LINDGREN	3116	00078900	03/19/2019
EMI Test Receiver	R&S	ESCI	100782	06/11/2018
Horn Antenna	Com-Power	AH-118	071032	04/18/2019
Pre-Amplifier	EMCI	EMC012645	980098	01/21/2019
PSA Series Spectrum Analyzer	Agilent	E4446A	MY43360132	06/06/2019
Software	Excel			

Remark: Each piece of equipment is scheduled for calibration once a year.

TEST CONFIGURATION

9kHz ~ 30MHz

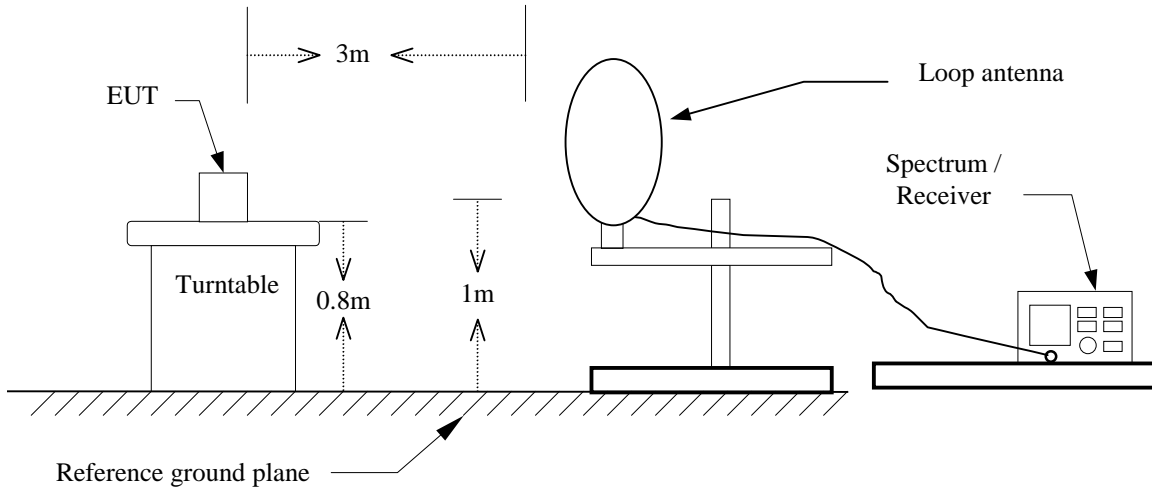

30MHz ~ 1GHz

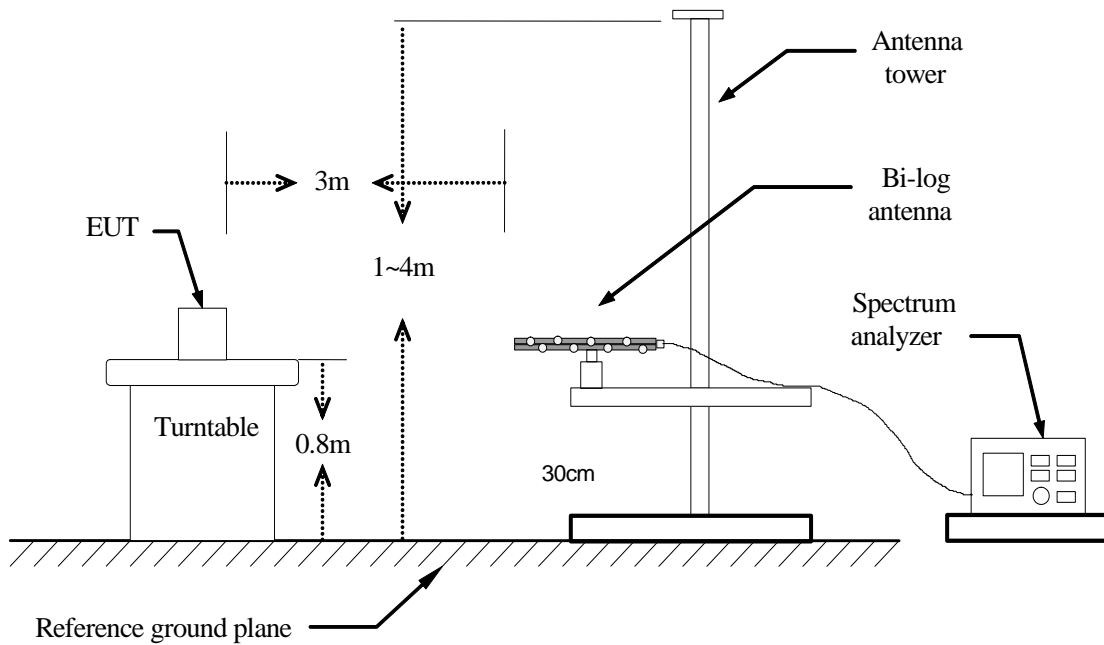

Above 1 GHz

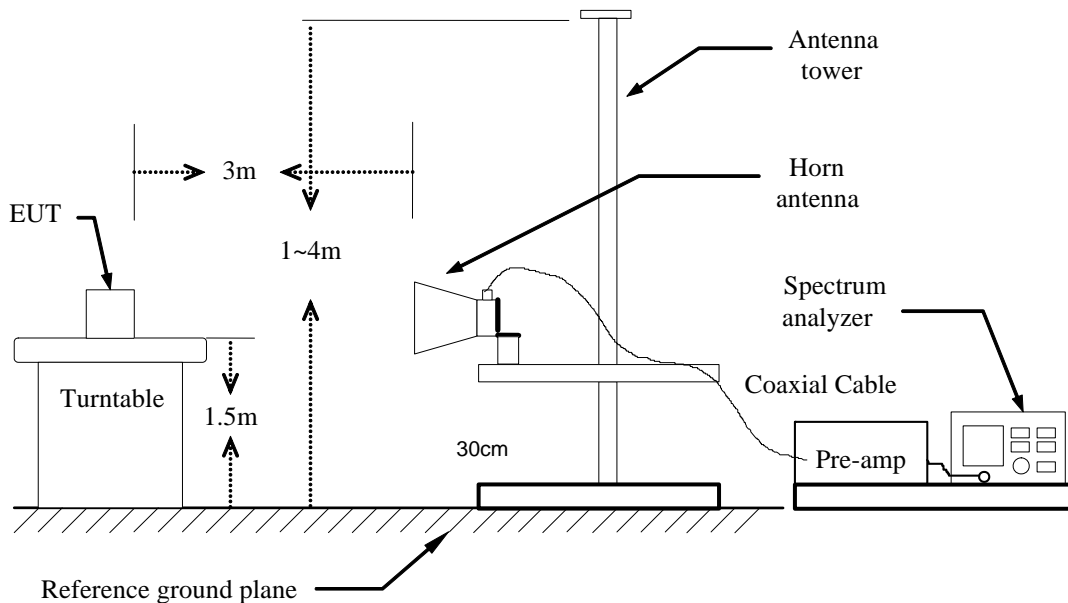

TEST PROCEDURE

1. The EUT is placed on a turntable, which is 0.8/1.5m above ground plane.
2. The turntable shall be rotated for 360 degrees to determine the position of maximum emission level.
3. EUT is set 3m away from the receiving antenna, which is varied from 1m to 4m to find out the highest emissions.
4. Maximum procedure was performed on the six highest emissions to ensure EUT compliance.
5. And also, each emission was to be maximized by changing the polarization of receiving antenna both horizontal and vertical.
6. Set the spectrum analyzer in the following setting as:
 - Below 1GHz:
 - RBW=100kHz / VBW=300kHz / Sweep=AUTO
 - Above 1GHz:
 - (a) PEAK: RBW=VBW=1MHz / Sweep=AUTO
 - (b) AVERAGE: Peak Level + Duty Factor
7. Repeat above procedures until the measurements for all frequencies are complete.

Below 1 GHz

Operation Mode: Normal Operation

Test Date: 2018/06/01

Temperature: 26.5°C

Tested by: Ted Huang

Humidity: 44% RH

Polarity: Ver. / Hor.

Vertical

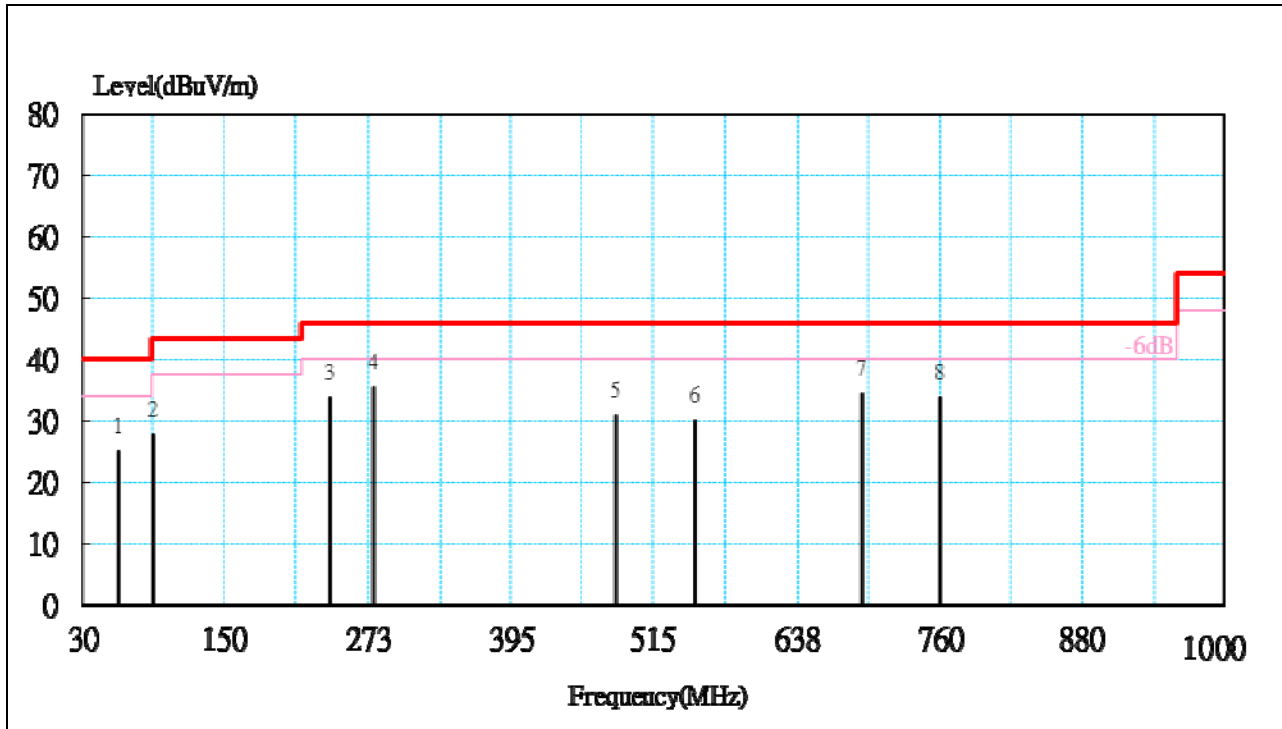

No.	Freq- Uency (MHz)	Meter Reading at 3 m Level (dBμV)	Antenna Factor (dB/m)	Cable Loss (dB)	Emission at 3 m Level (dBμV/m)	Limits (dBμV/m)	Margin (dB)	Detector Mode PK/QP
1	61.52	15.86	8.02	1.11	24.99	40.00	-15.01	QP
2	90.62	18.52	7.87	1.38	27.77	43.50	-15.73	QP
3	240.98	18.62	12.64	2.58	33.84	46.00	-12.16	QP
4	277.35	19.28	13.32	2.86	35.46	46.00	-10.54	QP
5	483.48	8.65	17.69	4.62	30.96	46.00	-15.04	QP
6	551.38	6.48	18.67	4.96	30.11	46.00	-15.89	QP
7	692.02	8.43	20.40	5.54	34.38	46.00	-11.62	QP
8	759.92	7.26	20.74	5.78	33.78	46.00	-12.22	QP

Remark:

- No emission found between lowest internal used/generated frequency to 30MHz (9kHz~30MHz).
- Radiated emissions measured in frequency range from 30 MHz to 1000MHz were made with an instrument using peak/quasi-peak detector mode.
- Quasi-peak test would be performed if the peak result were greater than the quasi-peak limit or as required by the applicant.
- Measurements above show only up to 6 maximum emissions noted, or would be lesser, with " N/A " remark, if no specific emissions from the EUT are recorded (ie: margin>20dB from the applicable limit) and considered that's already beyond the background noise floor.
- Margin (dB) = Remark result (dBuV/m) – Quasi-peak limit (dBuV/m).



6. That the limit for signals below 1GHz is a QP limit and peak readings are below the QP limit.
7. The fundamental signal is not shown in the test data because measurements at fundamental frequency are shown separately and were ignored during the 30 – 1000 MHz scan.

Operation Mode: Normal Operation
Temperature: 26.5°C
Humidity: 44% RH

Test Date: 2018/06/01
Tested by: Ted Huang
Polarity: Ver. / Hor.

Horizontal

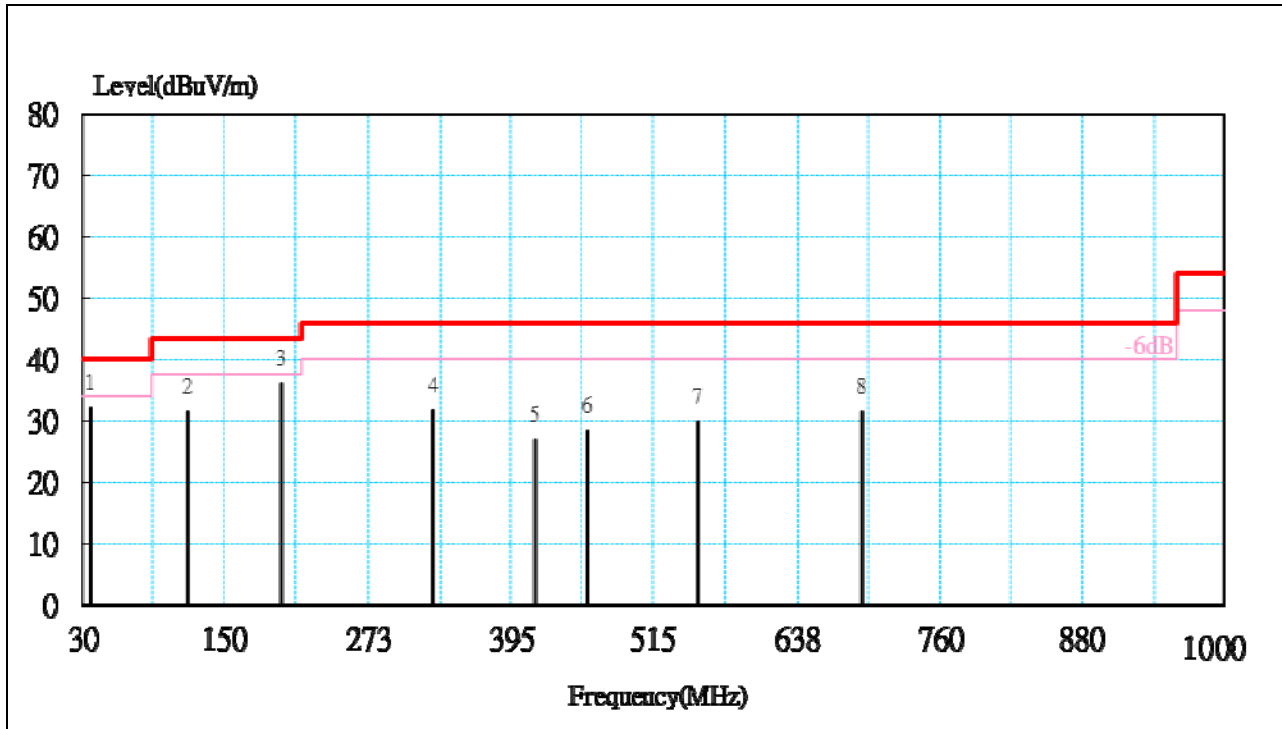

No.	Freq- Uency (MHz)	Meter Reading at 3 m Level (dBμV)	Antenna Factor (dB/m)	Cable Loss (dB)	Emission at 3 m Level (dBμV/m)	Limits (dBμV/m)	Margin (dB)	Detector Mode PK/QP
1	37.27	14.52	16.68	0.86	32.06	40.00	-7.94	QP
2	119.72	15.74	14.26	1.61	31.61	43.50	-11.89	QP
3	199.75	20.68	13.27	2.25	36.20	43.50	-7.30	QP
4	328.28	13.76	14.59	3.29	31.65	46.00	-14.35	QP
5	415.58	6.58	16.40	4.06	27.04	46.00	-18.96	QP
6	459.23	6.78	17.23	4.42	28.43	46.00	-17.57	QP
7	553.80	6.22	18.70	4.96	29.88	46.00	-16.12	QP
8	692.02	5.67	20.40	5.54	31.62	46.00	-14.38	QP

Remark:

- No emission found between lowest internal used/generated frequency to 30MHz (9kHz~30MHz).
- Radiated emissions measured in frequency range from 30 MHz to 1000MHz were made with an instrument using peak/quasi-peak detector mode.
- Quasi-peak test would be performed if the peak result were greater than the quasi-peak limit or as required by the applicant.
- Measurements above show only up to 6 maximum emissions noted, or would be lesser, with " N/A " remark, if no specific emissions from the EUT are recorded (ie: margin>20dB from the applicable limit) and considered that's already beyond the background noise floor.
- Margin (dB) = Remark result (dBuV/m) – Quasi-peak limit (dBuV/m).
- That the limit for signals below 1GHz is a QP limit and peak readings are below the QP limit.



7. The fundamental signal is not shown in the test data because measurements at fundamental frequency are shown separately and were ignored during the 30 – 1000 MHz scan.



The fundamental signal

Operation Mode: TX CH Low
Temperature: 26.5°C
Humidity: 44% RH

Test Date: 2018/06/01
Tested by: Ted Huang
Polarity: Ver. / Hor.

Horizontal

Freq.	Reading	AF	Cable Loss	Pre-amp	Filter	Level	Limit	Margin	Mark
(MHz)	(dBμV)	(dB/m)	(dB)	(dB)	(dB)	(dBμV/m)	(dBμV/m)	(dB)	(P/Q/A)
2408.00	101.54	30.07	2.91	44.54	0.00	89.99	114.00	-24.01	P
2408.00	99.93	30.07	2.91	44.54	0.00	88.38	94.00	-5.62	A

Vertical

Freq.	Reading	AF	Cable Loss	Pre-amp	Filter	Level	Limit	Margin	Mark
(MHz)	(dBμV)	(dB/m)	(dB)	(dB)	(dB)	(dBμV/m)	(dBμV/m)	(dB)	(P/Q/A)
2408.00	95.07	30.07	2.91	44.54	0.00	83.51	114.00	-30.49	P
2408.00	93.24	30.07	2.91	44.54	0.00	81.68	94.00	-12.32	A

Remark:

Margin (dB) = Remark result (dBuV/m) – Quasi-peak limit (dBuV/m).



Operation Mode: TX CH Middle

Test Date: 2018/06/01

Temperature: 26.5°C

Tested by: Ted Huang

Humidity: 44% RH

Polarity: Ver. / Hor.

Horizontal

Freq.	Reading	AF	Cable Loss	Pre-amp	Filter	Level	Limit	Margin	Mark
(MHz)	(dBμV)	(dB/m)	(dB)	(dB)	(dB)	(dBμV/m)	(dBμV/m)	(dB)	(P/Q/A)
2440.00	102.84	30.05	2.93	44.53	0.00	91.29	114.00	-22.71	P
2440.00	101.16	30.05	2.93	44.53	0.00	89.61	94.00	-4.39	A

Vertical

Freq.	Reading	AF	Cable Loss	Pre-amp	Filter	Level	Limit	Margin	Mark
(MHz)	(dBμV)	(dB/m)	(dB)	(dB)	(dB)	(dBμV/m)	(dBμV/m)	(dB)	(P/Q/A)
2440.00	95.76	30.05	2.93	44.53	0.00	84.21	114.00	-29.79	P
2440.00	94.18	30.05	2.93	44.53	0.00	82.63	94.00	-11.37	A

Remark:

Margin (dB) = Remark result (dBuV/m) – Quasi-peak limit (dBuV/m).



Operation Mode: TX CH High
Temperature: 26.5°C
Humidity: 44% RH

Test Date: 2018/06/01
Tested by: Ted Huang
Polarity: Ver. / Hor.

Horizontal

Freq.	Reading	AF	Cable Loss	Pre-amp	Filter	Level	Limit	Margin	Mark
(MHz)	(dBμV)	(dB/m)	(dB)	(dB)	(dB)	(dBμV/m)	(dBμV/m)	(dB)	(P/Q/A)
2474.00	103.04	30.02	2.95	44.51	0.00	91.49	114.00	-22.51	P
2474.00	101.46	30.02	2.95	44.51	0.00	89.91	94.00	-4.09	A

Vertical

Freq.	Reading	AF	Cable Loss	Pre-amp	Filter	Level	Limit	Margin	Mark
(MHz)	(dBμV)	(dB/m)	(dB)	(dB)	(dB)	(dBμV/m)	(dBμV/m)	(dB)	(P/Q/A)
2474.00	96.31	30.02	2.95	44.51	0.00	84.77	114.00	-29.23	P
2474.00	94.67	30.02	2.95	44.51	0.00	83.12	94.00	-10.88	A

Remark:

Margin (dB) = Remark result (dBuV/m) – Quasi-peak limit (dBuV/m).



Above 1 GHz

Operation Mode: TX CH Low
Temperature: 26.5°C
Humidity: 44% RH

Test Date: 2018/06/01
Tested by: Ted Huang
Polarity: Ver. / Hor.

Horizontal

Freq.	Reading	AF	Cable Loss	Pre-amp	Filter	Level	Limit	Margin	Mark
(MHz)	(dBμV)	(dB/m)	(dB)	(dB)	(dB)	(dBμV/m)	(dBμV/m)	(dB)	(P/Q/A)
* 1593.24	58.37	27.23	2.39	44.96	0.75	43.77	74.00	-30.23	P
* 1593.24	47.64	27.23	2.39	44.96	0.75	33.04	54.00	-20.96	A
* 4815.51	57.21	32.95	4.38	44.32	0.36	50.59	74.00	-23.41	P
* 4815.51	46.81	32.95	4.38	44.32	0.36	40.19	54.00	-13.81	A
7222.77	57.01	38.76	5.51	44.02	0.33	57.58	74.00	-16.42	P
7222.77	48.67	38.76	5.51	44.02	0.33	49.24	54.00	-4.76	A

Remark:

1. Measuring frequencies from 1 GHz to the 10th harmonic of highest fundamental frequency.
2. Radiated emissions measured in frequency above 1000MHz were made with an instrument using peak/average detector mode.
3. Average test would be performed if the peak result were greater than the average limit or as required by the applicant.
4. Data of measurement within this frequency range shown " --- " in the table above means the reading of emissions are attenuated more than 20dB below the permissible limits or the field strength is too small to be measured.
5. Measurements above show only up to 6 maximum emissions noted, or would be lesser, with " N/A " remark, if no specific emissions from the EUT are recorded (ie: margin>20dB from the applicable limit) and considered that's already beyond the background noise floor.
6. Margin (dB) = Remark result (dBuV/m) – Average limit (dBuV/m). Peak detector mode and average detector mode of the emission shown in Result column.
7. Average level=Peak level + Duty factor.

Operation Mode: TX CH Low
Temperature: 26.5°C
Humidity: 44% RH

Test Date: 2018/06/01
Tested by: Ted Huang
Polarity: Ver. / Hor.

Vertical

Freq.	Reading	AF	Cable Loss	Pre-amp	Filter	Level	Limit	Margin	Mark
(MHz)	(dBμV)	(dB/m)	(dB)	(dB)	(dB)	(dBμV/m)	(dBμV/m)	(dB)	(P/Q/A)
* 1329.52	59.26	25.78	2.16	45.16	1.08	43.13	74.00	-30.87	P
* 1329.52	49.32	25.78	2.16	45.16	1.08	33.19	54.00	-20.81	A
* 4815.40	56.13	32.95	4.38	44.32	0.36	49.50	74.00	-24.50	P
* 4815.40	46.16	32.95	4.38	44.32	0.36	39.54	54.00	-14.46	A
7222.49	55.79	38.76	5.51	44.02	0.33	56.36	74.00	-17.64	P
7222.49	45.82	38.76	5.51	44.02	0.33	46.39	54.00	-7.61	A

Remark:

1. Measuring frequencies from 1 GHz to the 10th harmonic of highest fundamental frequency.
2. Radiated emissions measured in frequency above 1000MHz were made with an instrument using peak/average detector mode.
3. Average test would be performed if the peak result were greater than the average limit or as required by the applicant.
4. Data of measurement within this frequency range shown “ --- ” in the table above means the reading of emissions are attenuated more than 20dB below the permissible limits or the field strength is too small to be measured.
5. Measurements above show only up to 6 maximum emissions noted, or would be lesser, with “ N/A ” remark, if no specific emissions from the EUT are recorded (ie: margin>20dB from the applicable limit) and considered that's already beyond the background noise floor.
6. Margin (dB) = Remark result (dBuV/m) – Average limit (dBuV/m). Peak detector mode and average detector mode of the emission shown in Result column.
7. Average level=Peak level + Duty factor.



Operation Mode: TX CH Middle
Temperature: 26.5°C
Humidity: 44% RH

Test Date: 2018/06/01
Tested by: Ted Huang
Polarity: Ver. / Hor.

Horizontal

Freq.	Reading	AF	Cable Loss	Pre-amp	Filter	Level	Limit	Margin	Mark
(MHz)	(dBμV)	(dB/m)	(dB)	(dB)	(dB)	(dBμV/m)	(dBμV/m)	(dB)	(P/Q/A)
* 1593.40	58.52	27.23	2.39	44.96	0.75	43.92	74.00	-30.08	P
* 1593.40	47.78	27.23	2.39	44.96	0.75	33.18	54.00	-20.82	A
* 4879.86	56.39	33.14	4.42	44.34	0.38	49.99	74.00	-24.01	P
* 4879.86	46.66	33.14	4.42	44.34	0.38	40.25	54.00	-13.75	A
* 7321.59	56.52	39.09	5.53	43.94	0.32	57.53	74.00	-16.47	P
* 7321.59	47.03	39.09	5.53	43.94	0.32	48.04	54.00	-5.96	A

Remark:

1. Measuring frequencies from 1 GHz to the 10th harmonic of highest fundamental frequency.
2. Radiated emissions measured in frequency above 1000MHz were made with an instrument using peak/average detector mode.
3. Average test would be performed if the peak result were greater than the average limit or as required by the applicant.
4. Data of measurement within this frequency range shown " --- " in the table above means the reading of emissions are attenuated more than 20dB below the permissible limits or the field strength is too small to be measured.
5. Measurements above show only up to 6 maximum emissions noted, or would be lesser, with " N/A " remark, if no specific emissions from the EUT are recorded (ie: margin>20dB from the applicable limit) and considered that's already beyond the background noise floor.
6. Margin (dB) = Remark result (dBuV/m) – Average limit (dBuV/m). Peak detector mode and average detector mode of the emission shown in Result column.
7. Average level=Peak level + Duty factor.

Operation Mode: TX CH Middle
Temperature: 26.5°C
Humidity: 44% RH

Test Date: 2018/06/01
Tested by: Ted Huang
Polarity: Ver. / Hor.

Vertical

Freq.	Reading	AF	Cable Loss	Pre-amp	Filter	Level	Limit	Margin	Mark
(MHz)	(dBμV)	(dB/m)	(dB)	(dB)	(dB)	(dBμV/m)	(dBμV/m)	(dB)	(P/Q/A)
* 1329.45	59.38	25.78	2.16	45.16	1.08	43.25	74.00	-30.75	P
* 1329.45	49.46	25.78	2.16	45.16	1.08	33.33	54.00	-20.67	A
* 4879.01	56.52	33.14	4.41	44.34	0.38	50.12	74.00	-23.88	P
* 4879.01	46.86	33.14	4.41	44.34	0.38	40.45	54.00	-13.55	A
* 7321.30	55.19	39.09	5.53	43.94	0.32	56.20	74.00	-17.80	P
* 7321.30	44.97	39.09	5.53	43.94	0.32	45.98	54.00	-8.02	A

Remark:

1. Measuring frequencies from 1 GHz to the 10th harmonic of highest fundamental frequency.
2. Radiated emissions measured in frequency above 1000MHz were made with an instrument using peak/average detector mode.
3. Average test would be performed if the peak result were greater than the average limit or as required by the applicant.
4. Data of measurement within this frequency range shown " --- " in the table above means the reading of emissions are attenuated more than 20dB below the permissible limits or the field strength is too small to be measured.
5. Measurements above show only up to 6 maximum emissions noted, or would be lesser, with " N/A " remark, if no specific emissions from the EUT are recorded (ie: margin>20dB from the applicable limit) and considered that's already beyond the background noise floor.
6. Margin (dB) = Remark result (dBuV/m) – Average limit (dBuV/m). Peak detector mode and average detector mode of the emission shown in Result column.
7. Average level=Peak level + Duty factor.



Operation Mode: TX CH High

Test Date: 2018/06/01

Temperature: 26.5°C

Tested by: Ted Huang

Humidity: 44% RH

Polarity: Ver. / Hor.

Horizontal

Freq.	Reading	AF	Cable Loss	Pre-amp	Filter	Level	Limit	Margin	Mark
(MHz)	(dBμV)	(dB/m)	(dB)	(dB)	(dB)	(dBμV/m)	(dBμV/m)	(dB)	(P/Q/A)
* 1593.16	58.25	27.23	2.39	44.96	0.75	43.65	74.00	-30.35	P
* 1593.16	47.76	27.23	2.39	44.96	0.75	33.16	54.00	-20.84	A
* 4947.37	56.52	33.34	4.45	44.36	0.40	50.35	74.00	-23.65	P
* 4947.37	45.65	33.34	4.45	44.36	0.40	39.49	54.00	-14.51	A
* 7423.55	55.38	39.44	5.56	43.85	0.32	56.85	74.00	-17.15	P
* 7423.55	45.99	39.44	5.56	43.85	0.32	47.46	54.00	-6.54	A

Remark:

1. Measuring frequencies from 1 GHz to the 10th harmonic of highest fundamental frequency.
2. Radiated emissions measured in frequency above 1000MHz were made with an instrument using peak/average detector mode.
3. Average test would be performed if the peak result were greater than the average limit or as required by the applicant.
4. Data of measurement within this frequency range shown " --- " in the table above means the reading of emissions are attenuated more than 20dB below the permissible limits or the field strength is too small to be measured.
5. Measurements above show only up to 6 maximum emissions noted, or would be lesser, with " N/A " remark, if no specific emissions from the EUT are recorded (ie: margin>20dB from the applicable limit) and considered that's already beyond the background noise floor.
6. Margin (dB) = Remark result (dBuV/m) – Average limit (dBuV/m). Peak detector mode and average detector mode of the emission shown in Result column.
7. Average level=Peak level + Duty factor.

Operation Mode: TX CH High

Temperature: 26.5°C

Humidity: 44% RH

Test Date: 2018/06/01

Tested by: Ted Huang

Polarity: Ver. / Hor.

Vertical

Freq.	Reading	AF	Cable Loss	Pre-amp	Filter	Level	Limit	Margin	Mark
(MHz)	(dBμV)	(dB/m)	(dB)	(dB)	(dB)	(dBμV/m)	(dBμV/m)	(dB)	(P/Q/A)
* 1329.66	59.54	25.78	2.16	45.16	1.08	43.41	74.00	-30.59	P
* 1329.66	49.68	25.78	2.16	45.16	1.08	33.55	54.00	-20.45	A
* 4948.48	56.44	33.35	4.45	44.36	0.40	50.28	74.00	-23.72	P
* 4948.48	46.44	33.35	4.45	44.36	0.40	40.28	54.00	-13.72	A
* 7423.51	55.20	39.44	5.56	43.85	0.32	56.67	74.00	-17.33	P
* 7423.51	44.30	39.44	5.56	43.85	0.32	45.77	54.00	-8.23	A

Remark:

1. Measuring frequencies from 1 GHz to the 10th harmonic of highest fundamental frequency.
2. Radiated emissions measured in frequency above 1000MHz were made with an instrument using peak/average detector mode.
3. Average test would be performed if the peak result were greater than the average limit or as required by the applicant.
4. Data of measurement within this frequency range shown " --- " in the table above means the reading of emissions are attenuated more than 20dB below the permissible limits or the field strength is too small to be measured.
5. Measurements above show only up to 6 maximum emissions noted, or would be lesser, with " N/A " remark, if no specific emissions from the EUT are recorded (ie: margin>20dB from the applicable limit) and considered that's already beyond the background noise floor.
6. Margin (dB) = Remark result (dBuV/m) – Average limit (dBuV/m). Peak detector mode and average detector mode of the emission shown in Result column.
7. Average level=Peak level + Duty factor.

7.5 POWERLINE CONDUCTED EMISSIONS

LIMIT

According to §15.207(a), except as shown in paragraphs (b) and (c) of this section, for an intentional radiator that is designed to be connected to the public utility (AC) power line, the radio frequency voltage that is conducted back onto the AC power line on any frequency or frequencies within the band 150 kHz to 30 MHz shall not exceed the limits in the following table, as measured using a 50 μ H/50 ohms line impedance stabilization network (LISN). Compliance with the provisions of this paragraph shall be based on the measurement of the radio frequency voltage between each power line and ground at the power terminal. The lower limit applies at the boundary between the frequency ranges.

Frequency Range (MHz)	Limits (dB μ V)	
	Quasi-peak	Average
0.15 to 0.50	66 to 56	56 to 46
0.50 to 5	56	46
5 to 30	60	50

Compliance with this provision shall be based on the measurement of the radio frequency voltage between each power line (LINE and NEUTRAL) and ground at the power terminals.

MEASUREMENT EQUIPMENT USED

Conducted Emission room #1				
Name of Equipment	Manufacturer	Model	Serial Number	Calibration Due
BNC Coaxial Cable	CCS	BNC50	11	01/23/2019
EMI Test Receiver	R&S	ESCS 30	100348	01/30/2019
LISN	SCHWARZBECK	NNLK8130	8130124	11/30/2018
LISN	FCC	FCC-LISN-50-32-2	08009	05/23/2019
Pulse Limiter	R&S	ESH3-Z2	100116	01/23/2019
Software	e-3 (5.04211j)			

Remark: Each piece of equipment is scheduled for calibration once a year.

TEST RESULTS

This EUT is not connected to AC Source directly. No applicability for this test.