

FCC 47 CFR PART 15 SUBPART C AND ANSI C63.10: 2013

TEST REPORT

For

Cherry Wireless Keyboard

Model: JG-925

Brand: CHERRY

Issued for

Cherry Europe GmbH

Cherrystraße, 91275 Auerbach, Deutschland/Germany

Issued by

Compliance Certification Services Inc.

Tainan Lab.

No.8, Jiucengling, Xinhua Dist.,

Tainan City, Taiwan

Issued Date: October 14, 2022

Note: This report shall not be reproduced except in full, without the written approval of Compliance Certification Services Inc. Ltd. This document may be altered or revised by Compliance Certification Services Inc. personnel only, and shall be noted in the revision section of the document

Unless otherwise stated the results shown in this test report refer only to the sample(s) tested and such sample(s) are retained for 90 days only.

除非另有說明，此報告結果僅對測試之樣品負責，同時此樣品僅保留 90 天。本報告未經本公司書面許可，不可部份複製。

This document is issued by the Company subject to its General Conditions of Service printed overleaf, available on request or accessible at <http://www.sgs.com.tw/Terms-and-Conditions> and, for electronic format documents, subject to Terms and Conditions for Electronic Documents at <http://www.sgs.com.tw/Terms-and-Conditions>. Attention is drawn to the limitation of liability, indemnification and jurisdiction issues defined therein. Any holder of this document is advised that information contained hereon reflects the Company's findings at the time of its intervention only and within the limits of client's instruction, if any. The Company's sole responsibility is to its Client and this document does not exonerate parties to a transaction from exercising all their rights and obligations under the transaction documents. This document cannot be reproduced, except in full, without prior written approval of the Company. Any unauthorized alteration, forgery or falsification of the content or appearance of this document is unlawful and offenders may be prosecuted to the fullest extent of the law.

REVISION HISTORY

Rev.	Issue Date	Revisions	Effect Page	Revised By
00	October 14, 2022	Initial Issue	ALL	Polly Wang

TABLE OF CONTENTS

1. TEST REPORT CERTIFICATION	4
2. TEST RESULT SUMMARY	5
3. EUT DESCRIPTION	6
3.1 DESCRIPTION OF EUT & POWER	6
4. DESCRIPTION OF TEST MODES	7
5. TEST METHODOLOGY	8
6. FACILITIES AND ACCREDITATIONS.....	8
6.1 FACILITIES	8
6.2 EQUIPMENT	8
6.3 LABORATORY ACCREDITATIONS LISTINGS	8
6.4 TABLE OF ACCREDITATIONS AND LISTINGS	9
6.5 MEASUREMENT EQUIPMENT USED	10
7. CALIBRATION AND UNCERTAINTY	11
7.1 MEASURING INSTRUMENT CALIBRATION	11
7.2 MEASUREMENT UNCERTAINTY	11
8. SETUP OF EQUIPMENT UNDER TEST	12
8.1 SETUP CONFIGURATION OF EUT	12
8.2 SUPPORT EQUIPMENT	14
8.3 EUT OPERATING CONDITION	15
9. APPLICABLE LIMITS AND TEST RESULTS.....	16
9.1 6DB BANDWIDTH	16
9.2 MAXIMUM PEAK OUTPUT POWER	20
9.3 DUTY CYCLE	26
9.4 POWER SPECTRAL DENSITY	30
9.5 CONDUCTED SPURIOUS EMISSION	34
9.6 RADIATED EMISSIONS	40
9.7 POWERLINE CONDUCTED EMISSIONS	55
10. ANTENNA REQUIREMENT	57
10.1 STANDARD APPLICABLE	57
10.2 ANTENNA CONNECTED CONSTRUCTION	57
APPENDIX I SETUP PHOTOS	58
APPENDIX II EUT PHOTOS	62

1. TEST REPORT CERTIFICATION

Applicant Cherry Europe GmbH
Cherrystraße, 91275 Auerbach, Deutschland/Germany

Manufacturer Jing Mold Electronic Tech. (Shen Zhen) Co., Ltd
Xin Qiao 3rd Industrial Estate, Sha Jing, Bao An, Shenzhen,
Guangdong, P.R. China

Equipment Under Test Cherry Wireless Keyboard

Model Number JG-925

Brand Name CHERRY

Date of Test August 25, 2022 ~ August 29, 2022

APPLICABLE STANDARD	
STANDARD	TEST RESULT
FCC Part 15 Subpart C AND ANSI C63.10: 2013	No non-compliance noted

Statements of Conformity
Determining compliance shall be based on the results of the compliance measurement, not taking into account measurement instrumentation uncertainty.

Approved by:



John Chen
Supervisor

2. TEST RESULT SUMMARY

FCC Standard Section	Report Section	Test Item	Result
15.247(a)	9.1	6dB BANDWIDTH	Pass
15.247(b)	9.2	MAXIMUM PEAK OUTPUT POWER	Pass
-	9.3	DUTY CYCLE	-
15.247(e)	9.4	POWER SPECTRAL DENSITY	Pass
15.247(d)	9.5	CONDUCTED SPURIOUS EMISSION	Pass
15.205(a)	9.6	RADIATED EMISSIONS	Pass
15.207(a)	9.7	POWERLINE CONDUCTED EMISSIONS	N/A
15.203	10	ANTENNA REQUIREMENT	Pass

3. EUT DESCRIPTION

3.1 DESCRIPTION OF EUT & POWER

Product Name	Cherry Wireless Keyboard
Model Number	JG-925
Brand Name	CHERRY
Received Date	July 21, 2022
Reported Date	September 08, 2022
Operating Frequency Range	GFSK(5.1) Mode: 2402MHz~2480MHz
Transmit Power	GFSK(5.1) Mode: -2.62dBm (0.547mW)
Channel Spacing	GFSK(5.1) Mode: 2 MHz
Channel Number	GFSK(5.1) Mode: 40 Channels
Transmit Data Rate	GFSK(5.1) Mode: 1 Mbps
Type of Modulation	GFSK
Antenna Type	Type: Chip Antenna Model: WAN5020D245W36 Gain: 3.49dBi Manufacturer: ONEWAVE
Power Source	DC 3.7V (Powered by battery)
Firmware Version	003
Software Version	N/A

REMARK:

1. The sample selected for test was engineering sample that approximated to production product and was provided by manufacturer.
2. This submittal(s) (test report) is intended for FCC ID: **GDDJG-925** filing to comply with Section 15.207, 15.209 and 15.247 of the FCC Part 15, Subpart C Rules.
3. For more details, please refer to the user manual.

4. DESCRIPTION OF TEST MODES

The EUT is a Cherry Wireless Keyboard.

The RF Chip is manufactured by ONEWAVE

The antenna peak gain 3.49dBi (highest gain) were chosen for full testing.

GFSK(5.1) mode

The EUT had been tested under operating condition.

There are three channels have been tested as following:

Channel	Frequency (MHz)
Low	2402
Middle	2440
High	2480

GFSK(5.1) mode: 1Mbps long data rates (worst case) were chosen for full testing.

Report No.: TMTN2207001019NR

5. TEST METHODOLOGY

The tests documented in this report were performed in accordance with ANSI C63.10 and FCC CFR 47 15.207, 15.209 and 15.247 and KdB 558074.

6. FACILITIES AND ACCREDITATIONS

6.1 FACILITIES

All measurement facilities used to collect the measurement data are located at

□ No.8, Jiucengling, Xinhua Dist., Tainan City 712, Taiwan (R.O.C.)

Tel: 886-6-580-2201 / Fax: 886-6-580-2202

■ No. 168, Ln. 523, Sec. 3, Zhongzheng Rd., Rende Dist., Tainan City 717, Taiwan (R.O.C.)

Tel: 886-6-580-2201 / Fax: 886-6-580-2202

The sites are constructed in conformance with the requirements of ANSI C63.7:1992, ANSI C63.10: 2013 and CISPR Publication 22.

6.2 EQUIPMENT

Radiated emissions are measured with one or more of the following types of linearly polarized antennas: tuned dipole, biconical, log periodic, bi-log, and/or ridged waveguide, horn. Spectrum analyzers with preselectors and quasi-peak detectors are used to perform radiated measurements.

Conducted emissions are measured with Line Impedance Stabilization Networks and EMI Test Receivers.

Calibrated wideband preamplifiers, coaxial cables, and coaxial attenuators are also used for making measurements.

All receiving equipment conforms to CISPR Publication 16-1, "Radio Interference Measuring Apparatus and Measurement Methods."

6.3 LABORATORY ACCREDITATIONS LISTINGS

The test facilities used to perform radiated and conducted emissions tests are accredited by Taiwan Accreditation Foundation for the specific scope of accreditation under Lab Code: 1109 to perform Electromagnetic Interference tests according to FCC PART 15 AND CISPR 22 requirements. No part of this report may be used to claim or imply product endorsement by TAF or any agency of the Government. In addition, the test facilities are listed with Federal Communications Commission (registration no: TW1109).

6.4 TABLE OF ACCREDITATIONS AND LISTINGS

Our laboratories are accredited and approved by the following accreditation body according to ISO/IEC 17025.

Taiwan	TAF
---------------	-----

The measuring facility of laboratories has been authorized or registered by the following approval agencies.

Canada	Industry Canada (ISED#: 2324H)
Germany	TUV NORD
Taiwan	BSMI
USA	FCC

6.5 MEASUREMENT EQUIPMENT USED

For §9.6

Chamber 1166 Room (Radiation Test)					
Name of Equipment	Manufacturer	Model	Serial Number	Calibration Date	Calibration Due
Active Loop Antenna	ETS-LINDREN	6502	8905-2356	09/06/2021	09/05/2022
Attenuator	MCL	BW-S15W5	0535	01/28/2022	01/27/2023
Band Reject Filter	MICRO-TRONICS	HPM13525	006	01/28/2022	01/27/2023
Band Reject Filter	MICRO-TRONICS	HP50107-01	001	01/28/2022	01/27/2023
Bilog Antenna With 6dB Attenuator	SUNOL SCIENCES & EMCI	JB1 & N-6-06	A021306 & AT-N0682	10/07/2021	10/06/2022
Cable	EMCI	EM102-KMKM	CB1166-01	06/20/2022	06/19/2023
Double Ridged Guide Horn Antenna	ETS-LINDGREN	3116	00078900	03/18/2022	03/17/2023
EMI Test Receiver	R&S	ESCI 7	100856	06/21/2022	06/20/2023
EXA Spectrum Analyzer	KEYSIGHT	N9010A	MY54430216	08/11/2022	08/10/2023
Double Ridged Guide Horn Antenna	SCHWARZBECK	BBHA 9120D	9120D-788(98006)	04/19/2022	04/18/2023
Notch Filter	MICRO-TRONICS	BRM50702-01	018	01/28/2022	01/27/2023
Pre-Amplifier	EMCI	EMC012645	980098	01/28/2022	01/27/2023
Pre-Amplifier	Com-Power	PAM-840A	461378	06/28/2022	06/27/2023
Software	Excel(ccs-o6-2020 v1.1) , e3(v6.101222)				

For §9.1~9.5

Chamber 1166 Room (Conducted Test)					
Name of Equipment	Manufacturer	Model	Serial Number	Calibration Date	Calibration Due
EXA Spectrum Analyzer	KEYSIGHT	N9010A	MY54430216	08/11/2022	08/10/2023
SMA Cable+10dB Attenuator	CCS	SMA+10dB ATT	SMA/10dB	01/28/2022	01/27/2023
Software	Excel(ccs-o6-2020 v1.1)				

For §9.7

Conducted Emission room #1					
Name of Equipment	Manufacturer	Model	Serial Number	Calibration Date	Calibration Due
-	-	-	-	-	-
-	-	-	-	-	-
-	-	-	-	-	-
-	-	-	-	-	-
-	-	-	-	-	-
Test S/W	-				

7. CALIBRATION AND UNCERTAINTY

7.1 MEASURING INSTRUMENT CALIBRATION

The measuring equipment utilized to perform the tests documented in this report has been calibrated in accordance with the manufacturer's recommendations, and is traceable to recognized national standards.

7.2 MEASUREMENT UNCERTAINTY

Where relevant, the following measurement uncertainty levels have been estimated for tests performed on the apparatus:

PARAMETER	UNCERTAINTY
Radiated Emission, 9kHz~30MHz Test Site : CB1166	±2.7dB
Radiated Emission, 30 MHz ~1GHz Test Site : CB1166	±3.76dB
Radiated Emission, 1GHz ~18GHz Test Site : CB1166	±4.43dB
Radiated Emission, 18GH~26.5GHz Test Site : CB1166	±4.79dB
Radiated Emission, 26.5GH~40GHz Test Site : CB1166	±4.72dB
Power Line Conducted Emission, 9kHz~30MHz	±1.83dB
Band Width	0.025%
Peak Output Power MU	±1.9dB
Band Edge MU	±0.264dBuV
Channel Separation MU	±361.69Hz
Duty Cycle MU	±0.2%
Frequency Stability MU	±0.493Hz
Temperature	±0.5
Humidity	±3%

This measurement uncertainty is confidence of approximately 95%, k=2

8. SETUP OF EQUIPMENT UNDER TEST

8.1 SETUP CONFIGURATION OF EUT

EMI

【Line PC】

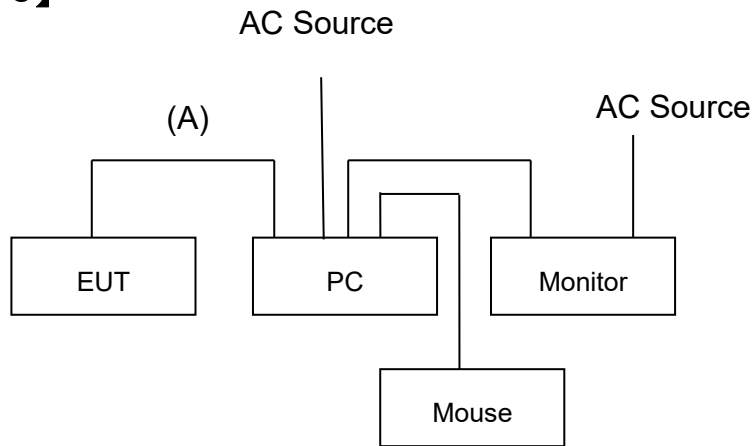

【Bluetooth】

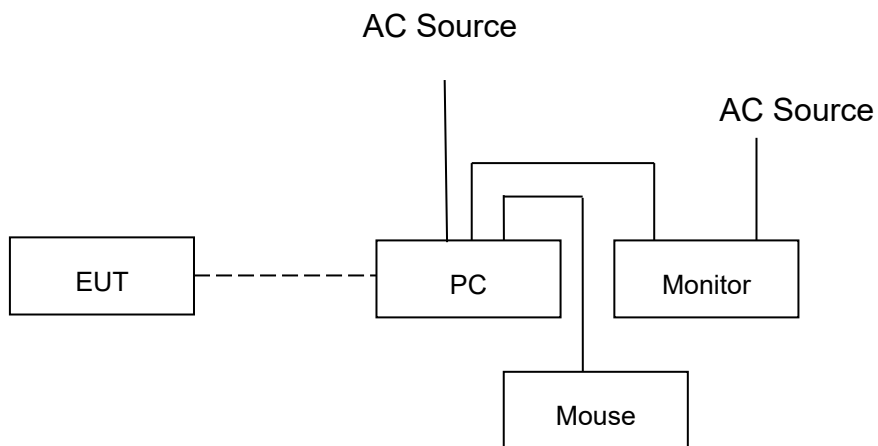

【RF】

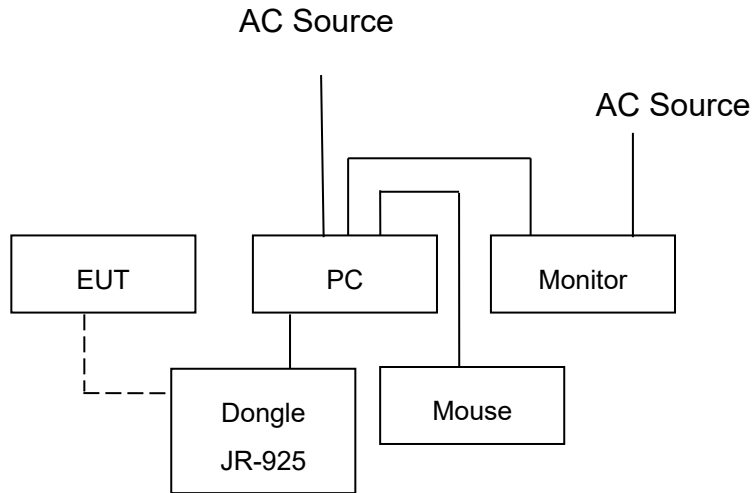

RF

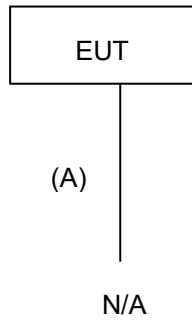

8.2 SUPPORT EQUIPMENT

For EMI test

No.	Product	Manufacturer	Model No.	Certify No.	Signal cable
1	LCD Monitor	ViewSonic	VS15449	R31374	N/A
2	Mouse(USB)	Lenovo	SM-8823	T3A002	N/A
3	PC	N/A	N/A	N/A	N/A
4	Dongle	N/A	JR-925	N/A	N/A

No.	Signal cable description	
A	USB	Unshielded, 1.6m 1 pcs.

For RF test

No.	Product	Manufacturer	Model No.	Certify No.	Signal cable
1	N/A				

No.	Signal cable description	
A	USB Type C	Unshielded, 1.5m 1 pcs.

Note:

- 1) All the equipment/cables were placed in the worst-case configuration to maximize the emission during the test.
- 2) Grounding was established in accordance with the manufacturer's requirements and conditions for the intended use.
- 3) shd. = shielded; unshd. = unshielded

8.3 EUT OPERATING CONDITION

RF Setup

1. Make sure Keyboard power off
2. Press 'F5', 'F6', and 'F7' buttons with power on, continue for 3 seconds and release. (F1~F4 LED light keep on)
3. Press 'F6' button into as below function. (F4 LED on)
 - (1). Press 'F5' button into Carrier Mode 2402MHz emission, one more time into Carrier Mode 2440MHz emission, one more time into Carrier Mode 2480MHz emission, going cycle.
 - (2). Press 'F6' button into Modulation Mode 2402MHz emission, one more time into Modulation Mode 2440MHz emission, one more time into Modulation Mode 2480MHz emission, going cycle.

9. APPLICABLE LIMITS AND TEST RESULTS

9.1 6dB BANDWIDTH

LIMIT

§ 15.207(a) (2) For direct sequence systems, the minimum 6dB bandwidth shall be at least 500kHz

TEST SETUP

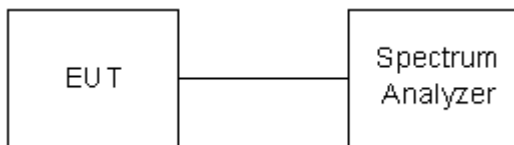

TEST PROCEDURE

- a) Set RBW = 100 kHz.
- b) Set the video bandwidth (VBW) ≥ 3 RBW.
- c) Detector = Peak.
- d) Trace mode = max hold.
- e) Sweep = auto couple.
- f) Allow the trace to stabilize.
- g) Measure the maximum width of the emission that is constrained by the frequencies associated with the two outermost amplitude points (upper and lower frequencies) that are attenuated by 6 dB relative to the maximum level measured in the fundamental emission.

TEST RESULTS

No non-compliance noted.

Model Name	JG-925	Test By	Peter Chu
Temp & Humidity	25.5°C, 47%	Test Date	2022/08/26

GFSK(5.1) mode

Channel	Channel Frequency (MHz)	6dB Bandwidth (kHz)	Minimum Limit (kHz)	Pass / Fail
Low	2402	647.00	500	PASS
Middle	2440	651.00	500	PASS
High	2480	655.00	500	PASS

- NOTE :**
1. At final test to get the worst-case emission at 1Mbps long.
 2. The cable assembly insertion loss of 11.1dB (including 10 dB pad and 1.1 dB cable) was entered as an offset in the spectrum analyzer to allow for direct reading of power.

6dB BANDWIDTH (GFSK(5.1) MODE)

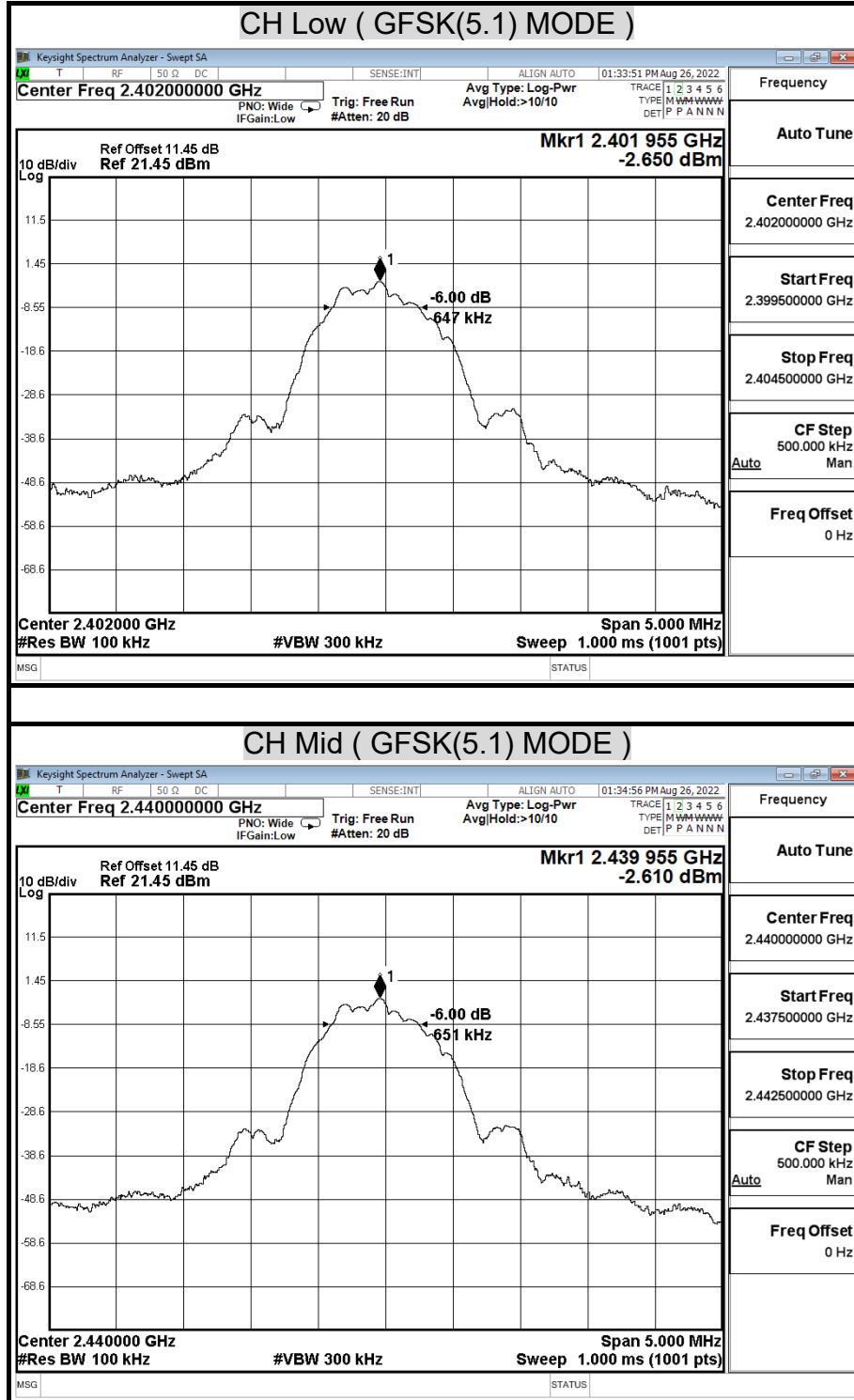

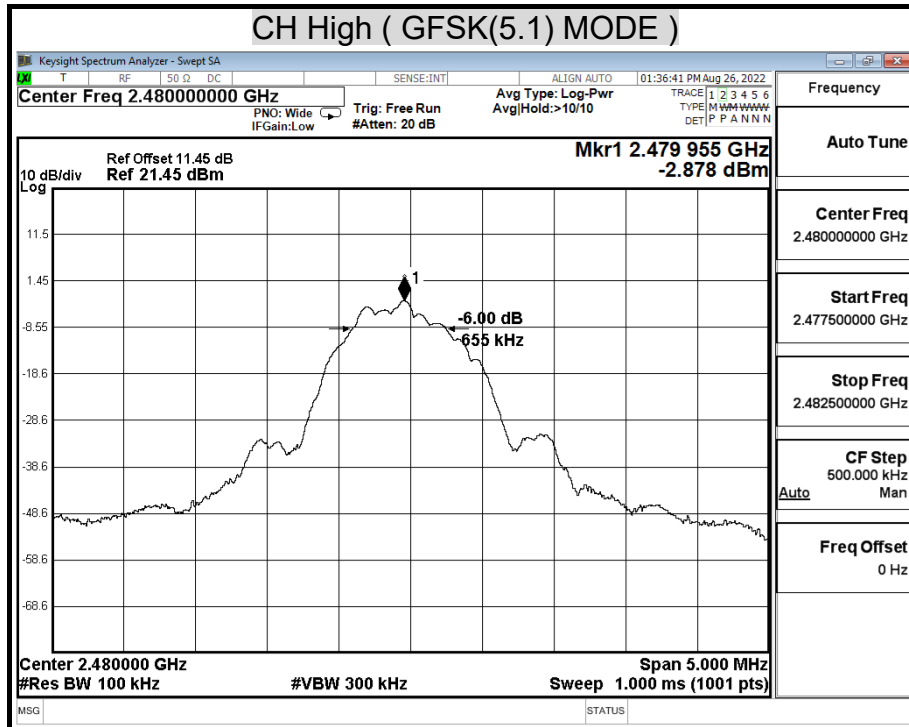

9.2 MAXIMUM PEAK OUTPUT POWER

LIMIT

§ 15.247(b) The maximum peak output power of the intentional radiator shall not exceed the following :

§ 15.247(b) (3) For systems using digital modulation in the 902-928 MHz, 2400-2483.5 MHz, and 5725-5850 MHz bands : 1 watt.

§ 15.247(b) (4) Except as shown in paragraphs (c) of this section , if transmitting antennas of directional gain greater than 6 dBi are used the peak output power from the intentional radiator shall be reduced below the stated values in paragraphs (b)(1) or (b)(2), and (b)(3) of this section , as appropriate, by the amount in dB that the directional gain of the antenna exceeds 6 dBi.

TEST SETUP

For Peak Power

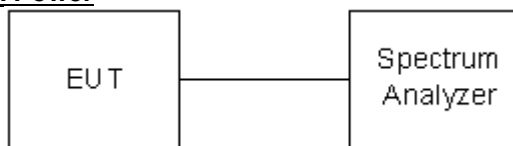

For Average Power

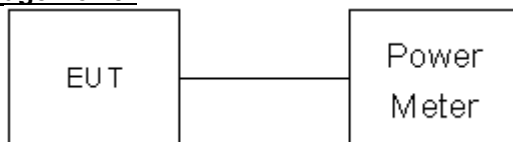

TEST PROCEDURE

The tests were performed in accordance with KDB 558074 D01 v05r02 and ANSI C63.10-2013, 11.9.1.1.

9.2.1 Measurement Procedure :

- a) Set the RBW \geq DTS bandwidth.
- b) Set VBW \geq 3 RBW.
- c) Set span \geq 3 x RBW
- d) Sweep time = auto couple.
- e) Detector = peak.
- f) Trace mode = max hold.
- g) Allow trace to fully stabilize.
- h) Use peak marker function to determine the peak amplitude level.

Average Power

The tests were performed in accordance with ANSI C63.11 9.2.3.1.

Connect the EUT to power meter, set the center frequency of the power meter to the channel center frequency.

TEST RESULTS

No non-compliance noted.

Model Name	JG-925	Test By	Peter Chu
Temp & Humidity	25.5°C, 47%	Test Date	2022/08/26

GFSK(5.1) mode

Channel	Channel Frequency (MHz)	Peak Power (dBm)	Peak Power Limit (dBm)	Pass / Fail
Low	2402	-3.15	30.00	PASS
Middle	2440	-2.62	30.00	PASS
High	2480	-3.21	30.00	PASS

NOTE : 1. At final test to get the worst-case emission at 1Mbps long.
2. The cable assembly insertion loss of 11.45dB (including 10 dB pad and 1.45 dB cable) was entered as an offset in the power meter to allow for direct reading of power.

Average Power Data

Model Name	JG-925	Test By	Peter Chu
Temp & Humidity	25.5°C, 47%	Test Date	2022/08/26

GFSK(5.1) mode

Channel	Channel Frequency (MHz)	Measure Power (dBm)	10 log (1 / D)	Average Power (dBm)
Low	2402	-9.63	6.198	-3.43
Middle	2440	-9.59	6.198	-3.39
High	2480	-9.78	6.198	-3.58

Note: *D is duty cycle.

MAXIMUM PEAK OUTPUT POWER (GFSK(5.1) MODE)

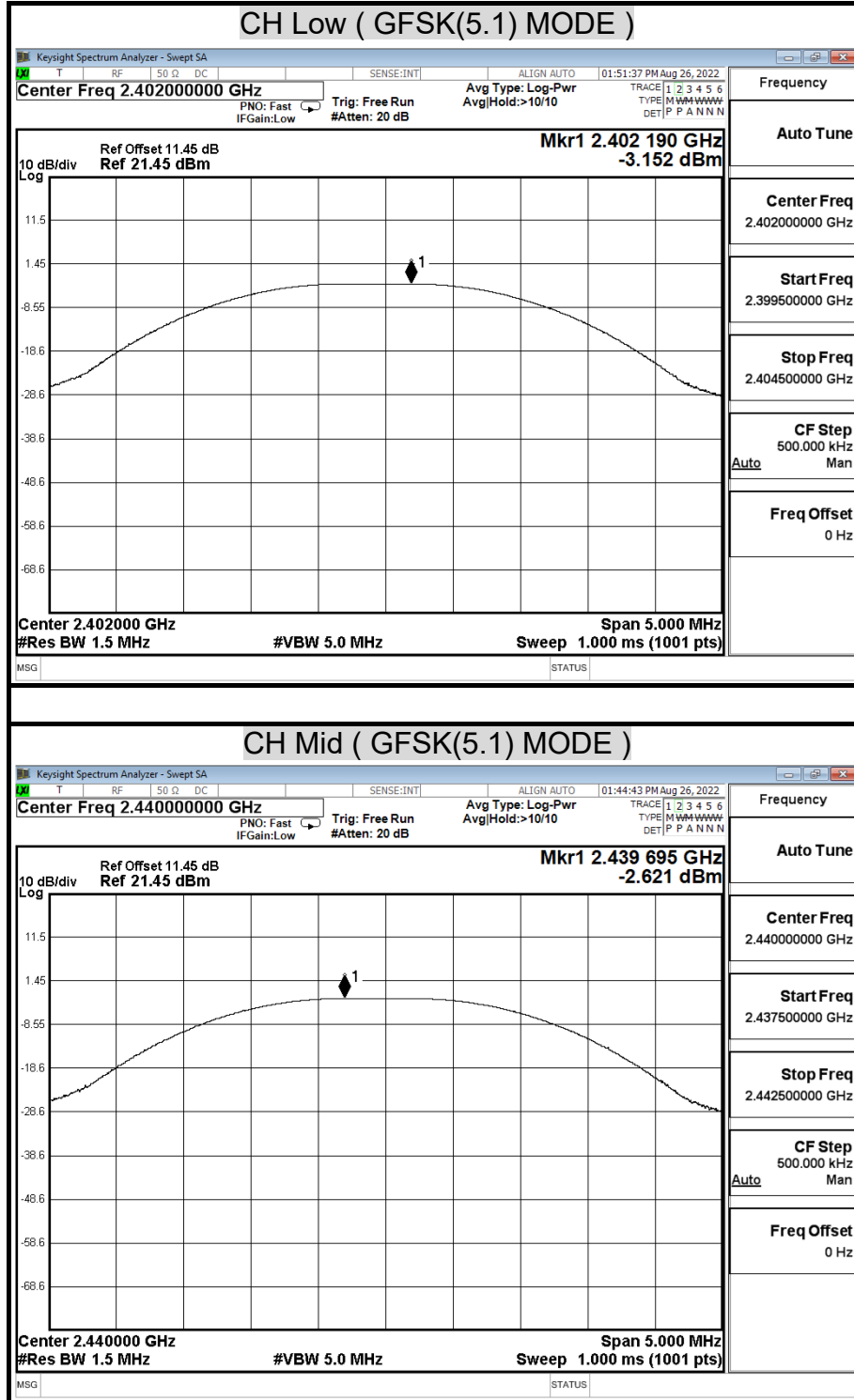

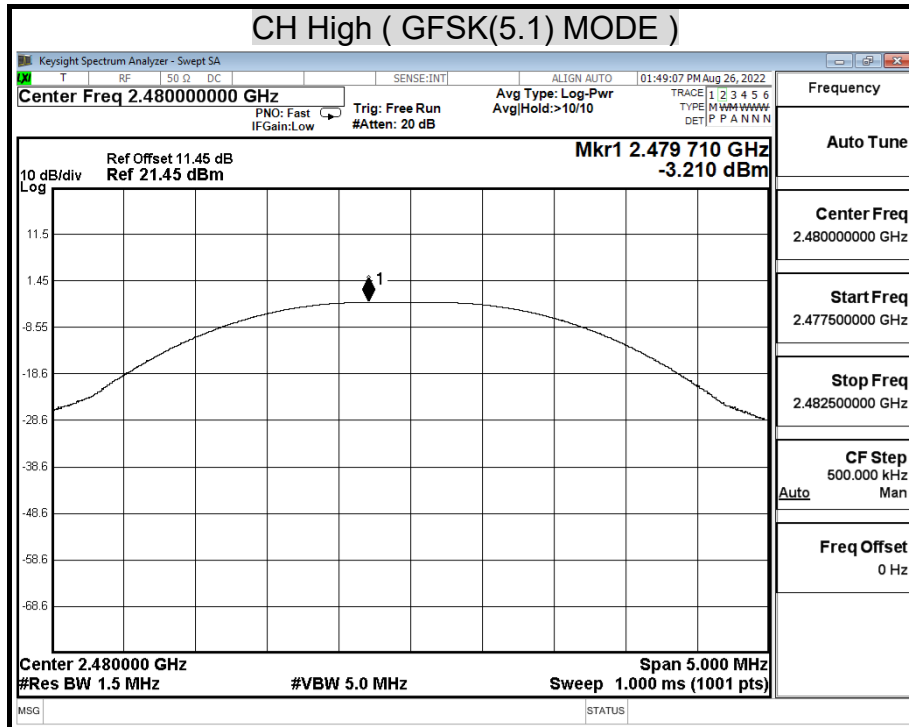

9.3 DUTY CYCLE

LIMIT

Nil (No dedicated limit specified in the Rules)

TEST SETUP

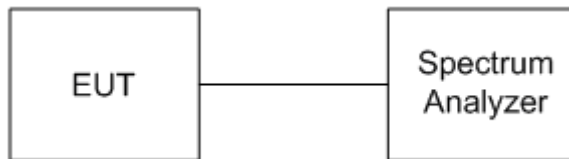

TEST PROCEDURE

1. Place the EUT on the table and set it in transmitting mode.
2. Remove the antenna from the EUT and then connect a low loss RF cable from the antenna port to the spectrum analyzer.
3. The zero-span mode on a spectrum analyzer or EMI receiver if the response time and spacing between bins on the sweep are sufficient to permit accurate measurements of the on and off times of the transmitted signal. Set the center frequency of the instrument to the center frequency of the transmission. Set $RBW \geq OBW$ if possible; otherwise, set RBW to the largest available value. Set $VBW \geq RBW$. Set detector = peak or average. The zero-span measurement method shall not be used unless both RBW and VBW are $> 50/T$ and the number of sweep points across duration T exceeds 100. (For example, if VBW and/or RBW are limited to 3 MHz, then the zero-span method of measuring duty cycle shall not be used if $T \leq 16.7$ microseconds.)

TEST RESULTS

No non-compliance noted.

Model Name	JG-925	Test By	Peter Chu
Temp & Humidity	25.5°C, 47%	Test Date	2022/08/26

GFSK(5.1) Mode

	us	Times	Ton	Total Ton time(ms)
Ton1	150.000	1	150	
Ton2		0	0	
Ton3			0	0.15
Tp				0.625

Ton	0.15
Tp(Ton+Toff)	0.625
Duty Cycle	0.24
Duty Factor	6.198

TEST PLOT

Duty Cycle

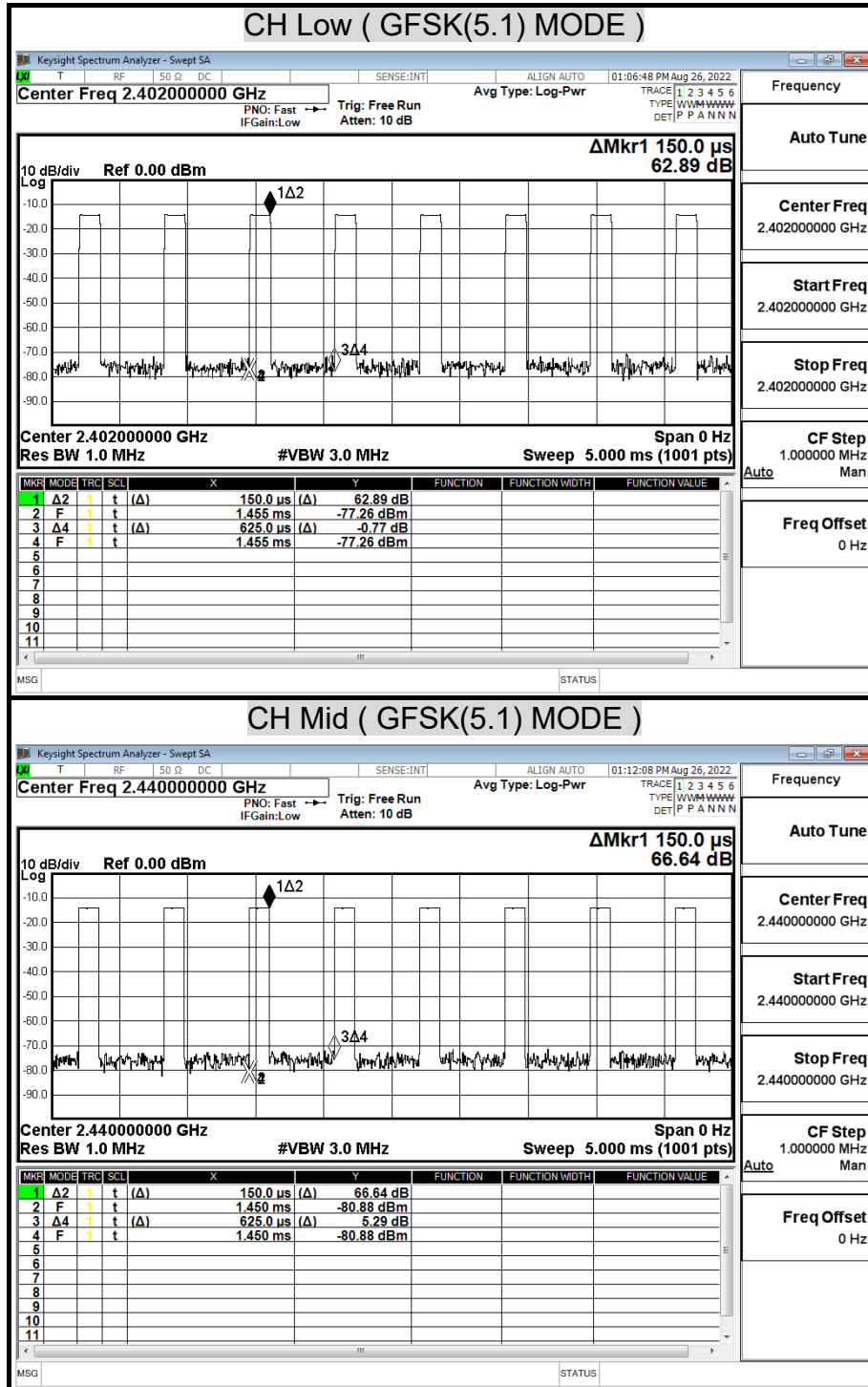

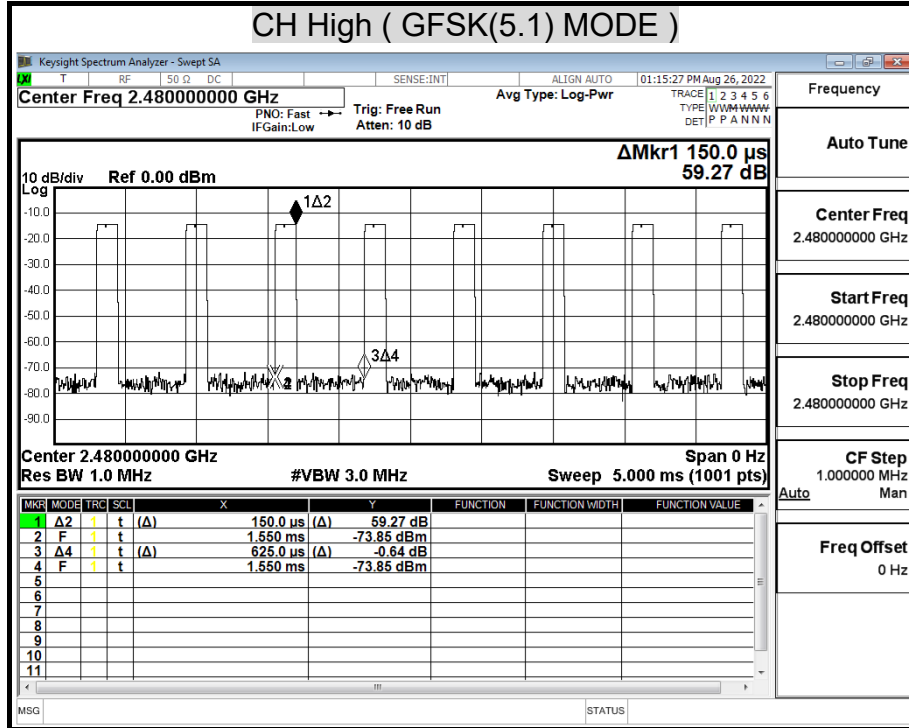

9.4 POWER SPECTRAL DENSITY

LIMIT

§ 15.247(e) For digitally modulated systems, the power spectral density conducted from the intentional radiator to the antenna shall not greater than 8 dBm in any 3 kHz band during any time interval of continuous transmission.

TEST SETUP

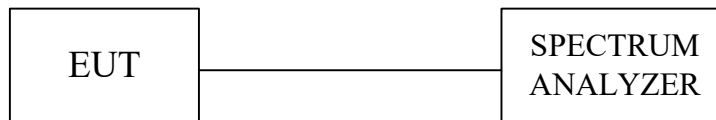

TEST PROCEDURE

The tests were performed in accordance with KDB 8.4 (ANSI C63.10, 11.10.2)

10.2 Method PKPSD (peak PSD):

1. Set analyzer center frequency to DTS channel center frequency.
2. Set the span to 1.5 times the DTS bandwidth.
3. Set the RBW to: $3 \text{ kHz} \leq \text{RBW} \leq 100 \text{ kHz}$.
4. Set the VBW $\geq 3 \text{ RBW}$.
5. Detector = peak.
6. Sweep time = auto couple.
7. Trace mode = max hold.
8. Allow trace to fully stabilize.
9. Use the peak marker function to determine the maximum amplitude level within the RBW.
10. If measured value exceeds limit, reduce RBW (no less than 3 kHz) and repeat.

Report No.: TMTN2207001019NR

TEST RESULTS

No non-compliance noted.

Model Name	JG-925	Test By	Peter Chu
Temp & Humidity	25.5°C, 47%	Test Date	2022/08/26

GFSK(5.1) mode

Channel	Frequency (MHz)	PPSD/3kHz (dBm)	Limit (dBm)	Margin (dB)	Result
Low	2402	-18.56	8.00	-26.56	PASS
Middle	2440	-18.56	8.00	-26.56	PASS
High	2480	-18.75	8.00	-26.75	PASS

- NOTE :**
1. At final test to get the worst-case emission at 1Mbps long.
 2. The cable assembly insertion loss of 11.45dB (including 10 dB pad and 1.45 dB cable) was entered as an offset in the power meter to allow for direct reading of power.

Report No.: TMTN2207001019NR

POWER SPECTRAL DENSITY (GFSK(5.1) MODE)

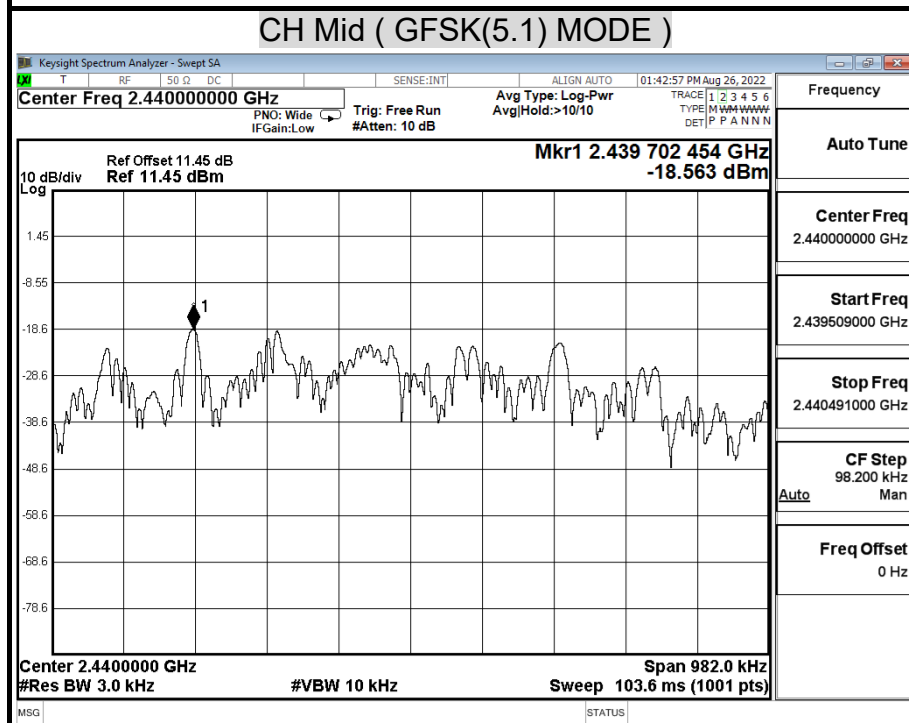
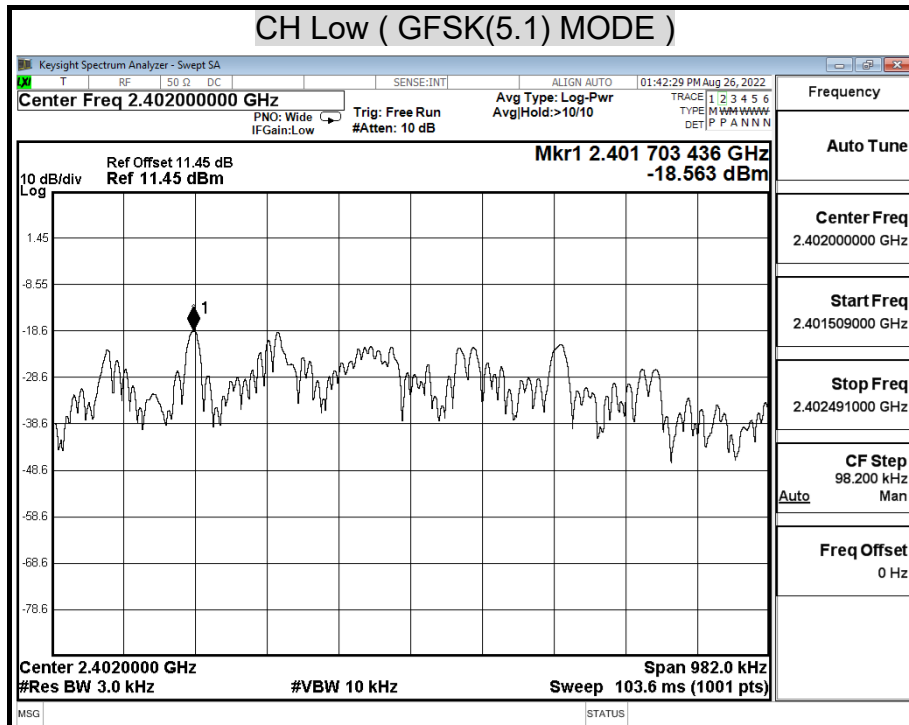

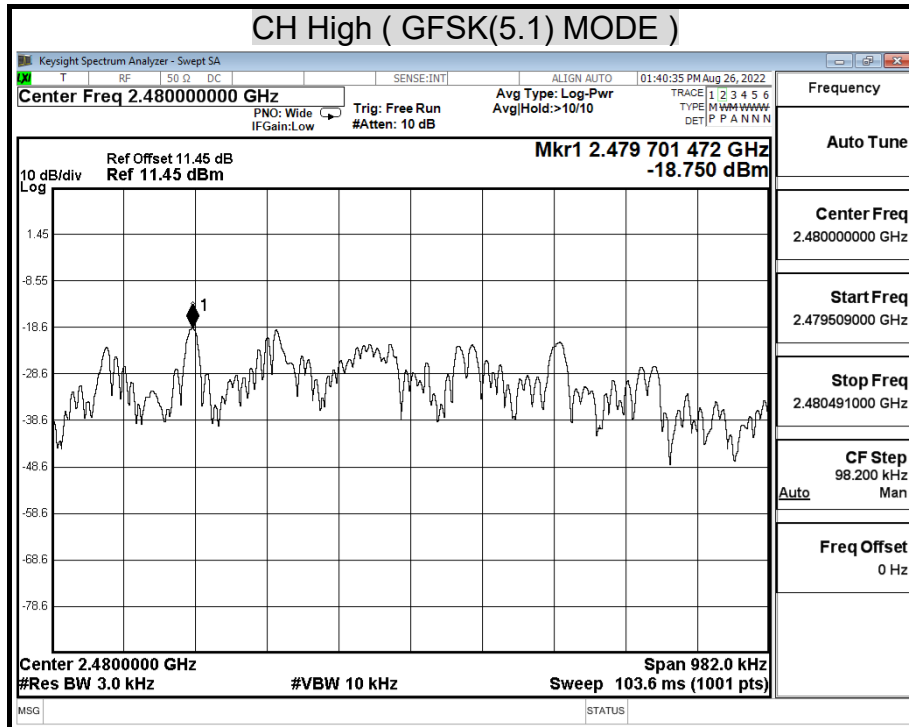

9.5 CONDUCTED SPURIOUS EMISSION

LIMITS

§ 15.247(d) In any 100 kHz bandwidth outside the frequency band in which the spread spectrum intentional radiator is operating, the radio frequency power that is produced by the intentional radiator shall be at least 20 dB below that in the 100 kHz bandwidth within the and that contains the highest level of the desired power, based on either an RF conducted or a radiated measurement. Attenuation below the general limits specified in § 15.209(a) is not required. In addition, radiated emissions which fall in the restricted bands, as defined in § 15.205(a), must also comply with the radiated emission limits specified in § 15.209(a) (see § 15.205(c)).

TEST SETUP



TEST PROCEDURE

The transmitter output is connected to a spectrum analyzer. The resolution bandwidth is set to 100kHz. The video bandwidth is set to 300kHz.

The spectrum from 30 MHz to 26.5 GHz is investigated with the transmitter set to the lowest, middle, and highest channels in the 2.4 GHz band.

TEST RESULTS

No non-compliance noted.

TEST DATA

Model Name	JG-925	Test By	Peter Chu
Temp & Humidity	25.5°C, 47%	Test Date	2022/08/26

OUT-OF-BAND SPURIOUS EMISSIONS-CONDUCTED MEASUREMENT

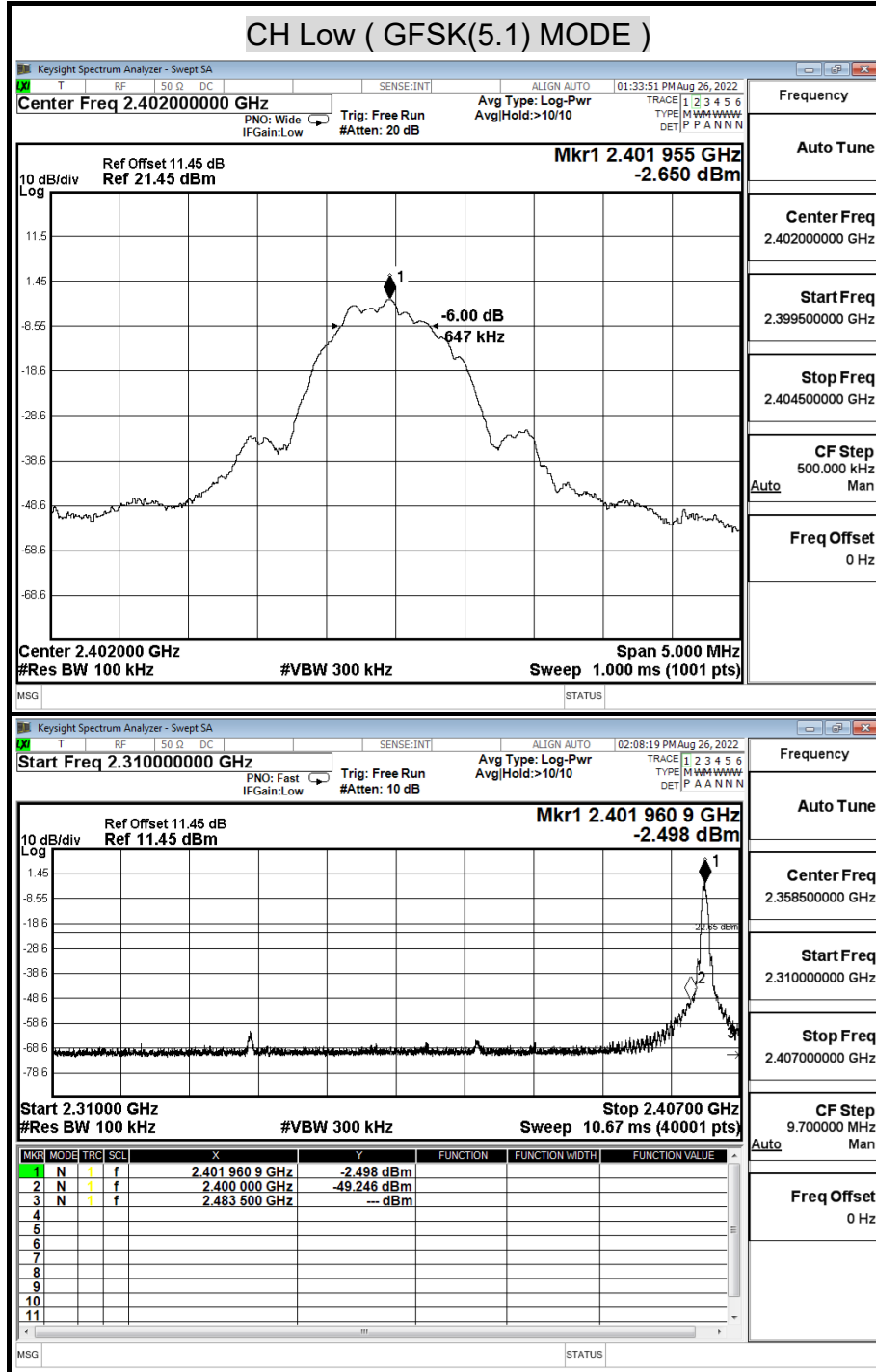

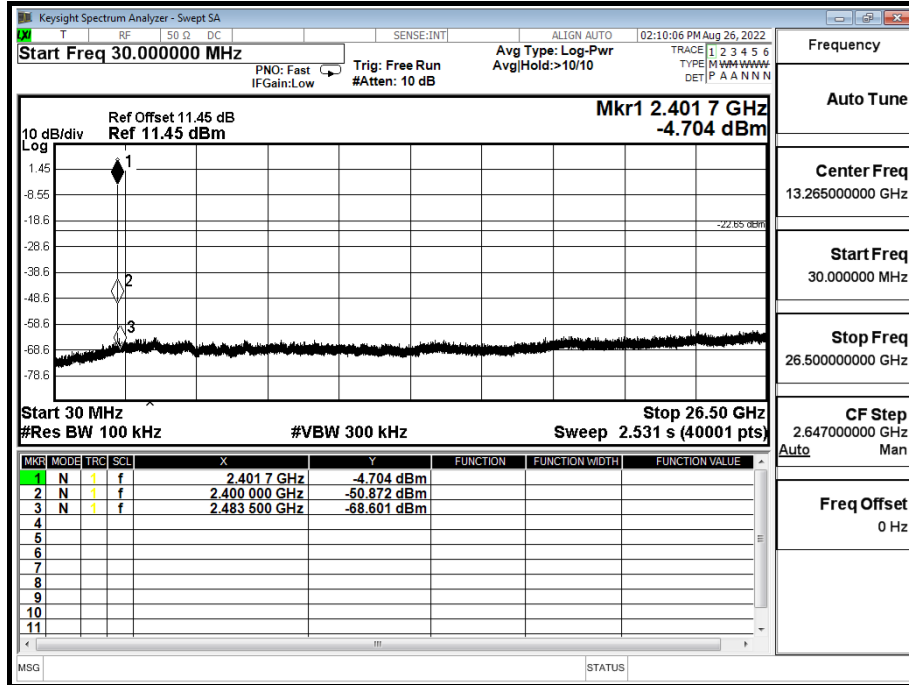

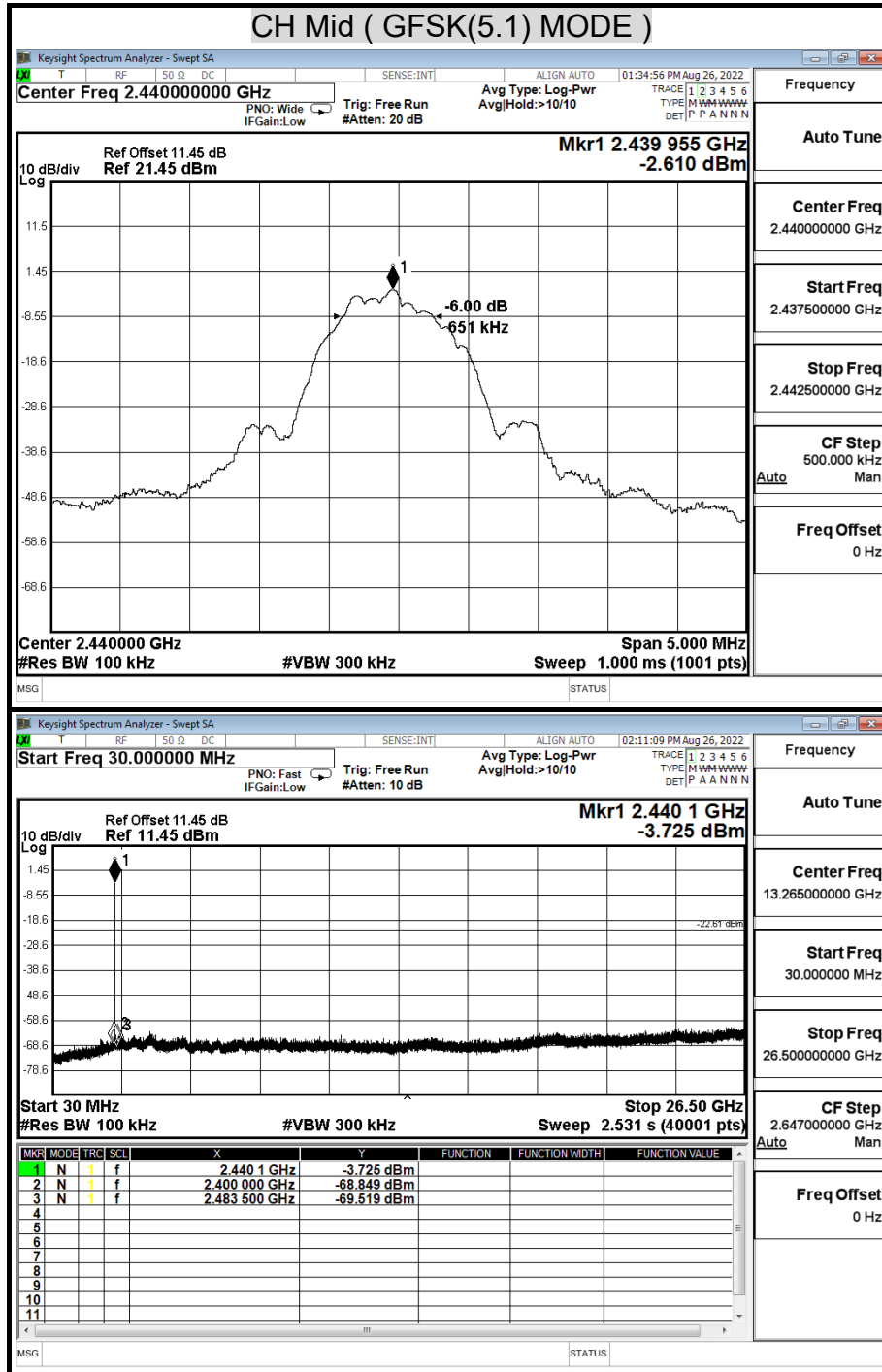

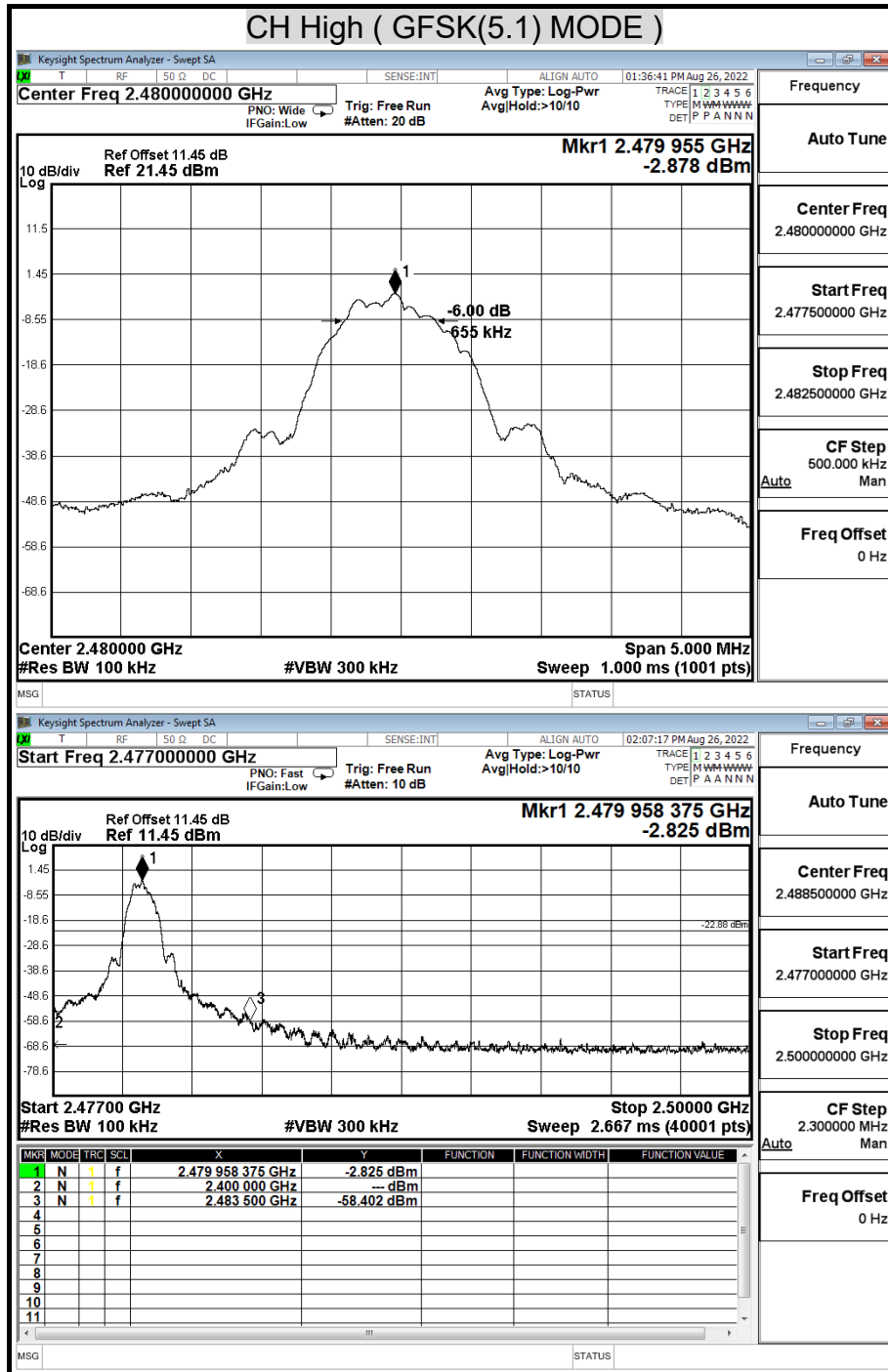

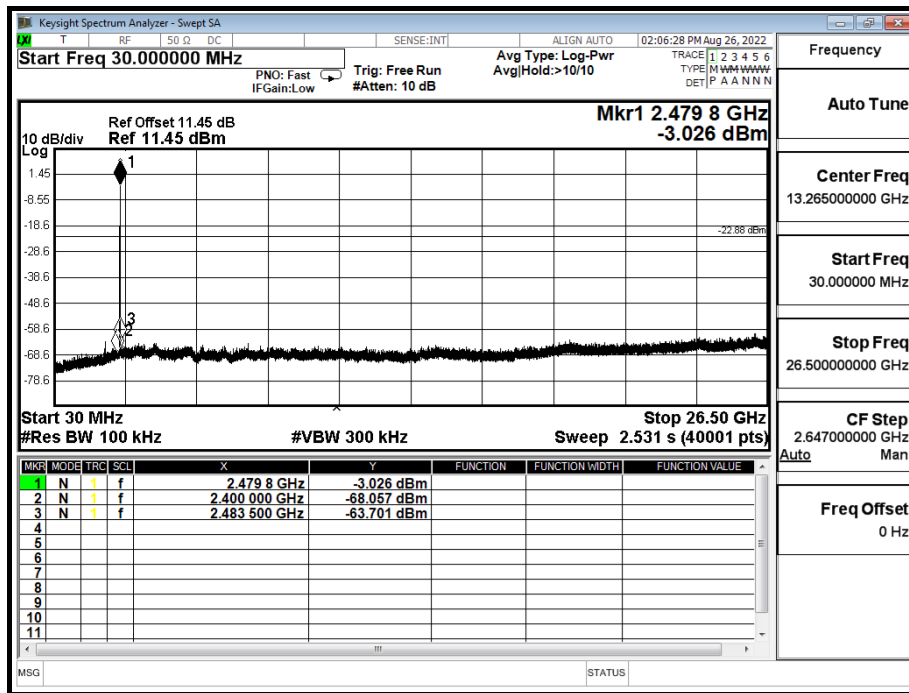

9.6 RADIATED EMISSIONS

9.6.1 TRANSMITTER RADIATED SUPURIOUS EMSSIONS

LIMITS

§ 15.205 (a) Except as shown in paragraph (d) of this section, only spurious emissions are permitted in any of the frequency bands listed below:

MHz	MHz	MHz	GHz
0.090 - 0.110	16.42 - 16.423	399.9 - 410	4.5 - 5.15
¹ 0.495 - 0.505	16.69475 - 16.69525	608 - 614	5.35 - 5.46
2.1735 - 2.1905	16.80425 - 16.80475	960 - 1240	7.25 - 7.75
4.125 - 4.128	25.5 - 25.67	1300 - 1427	8.025 - 8.5
4.17725 - 4.17775	37.5 - 38.25	1435 - 1626.5	9.0 - 9.2
4.20725 - 4.20775	73 - 74.6	1645.5 - 1646.5	9.3 - 9.5
6.215 - 6.218	74.8 - 75.2	1660 - 1710	10.6 - 12.7
6.26775 - 6.26825	108 - 121.94	1718.8 - 1722.2	13.25 - 13.4
6.31175 - 6.31225	123 - 138	2200 - 2300	14.47 - 14.5
8.291 - 8.294	149.9 - 150.05	2310 - 2390	15.35 - 16.2
8.362 - 8.366	156.52475 - 156.52525	2483.5 - 2500	17.7 - 21.4
8.37625 - 8.38675	156.7 - 156.9	2655 - 2900	22.01 - 23.12
8.41425 - 8.41475	162.0125 - 167.17	3260 - 3267	23.6 - 24.0
12.29 - 12.293	167.72 - 173.2	3332 - 3339	31.2 - 31.8
12.51975 - 12.52025	240 - 285	3345.8 - 3338	36.43 - 36.5
12.57675 - 12.57725	322 - 335.4	3600 - 4400	(²)
13.36 - 13.41			

¹ Until February 1, 1999, this restricted band shall be 0.490-0.510 MHz.

² Above 38.6

§ 15.205 (b) Except as provided in paragraphs (d) and (e), the field strength of emissions appearing within these frequency bands shall not exceed the limits shown in Section 15.209. At frequencies equal to or less than 1000 MHz, compliance with the limits in Section 15.209 shall be demonstrated using measurement instrumentation employing a CISPR quasi-peak detector. Above 1000 MHz, compliance with the emission limits in Section 15.209 shall be demonstrated based on the average value of the measured emissions. The provisions in Section 15.35 apply to these measurements.

Report No.: TMTN2207001019NR

§ 15.209 (a) Except as provided elsewhere in this Subpart, the emissions from an intentional radiator shall not exceed the field strength levels specified in the following table :

Frequency (MHz)	Field Strength (microvolts/meter)	Measurement Distance (meters)
30 - 88	100 **	3
88 - 216	150 **	3
216 - 960	200 **	3
Above 960	500	3

** Except as provided in paragraph (g), fundamental emissions from intentional radiators operating under this Section shall not be located in the frequency bands 54-72 MHz, 76-88 MHz, 174-216 MHz or 470-806 MHz, However, operation within these frequency bands is permitted under other sections of this Part, e-g, Sections 15.231 and 15.241.

§ 15.209 (b) In the emission table above, the tighter limit applies at the band edges.

TEST SETUP

The diagram below shows the test setup that is utilized to make the measurements for emission from below 1GHz.

9kHz ~ 30MHz

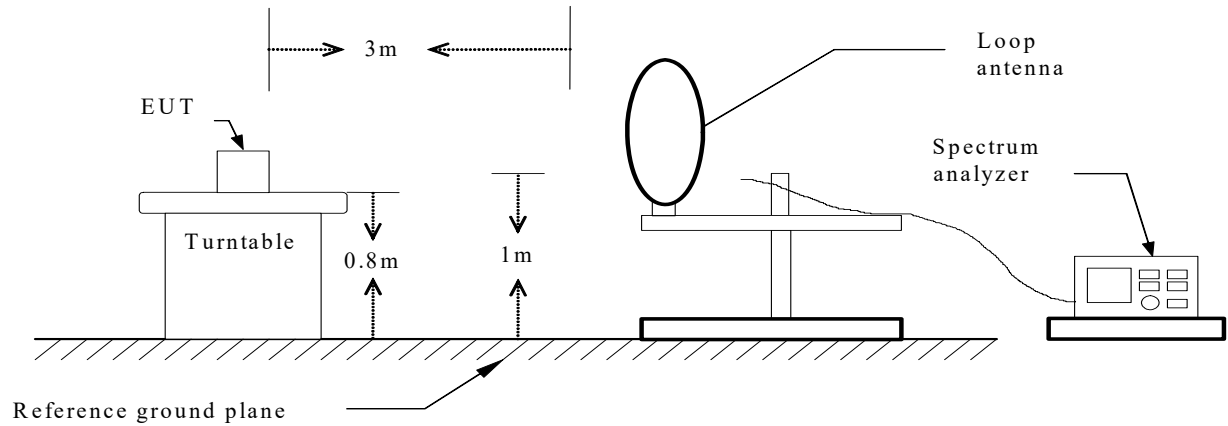

30MHz ~ 1GHz

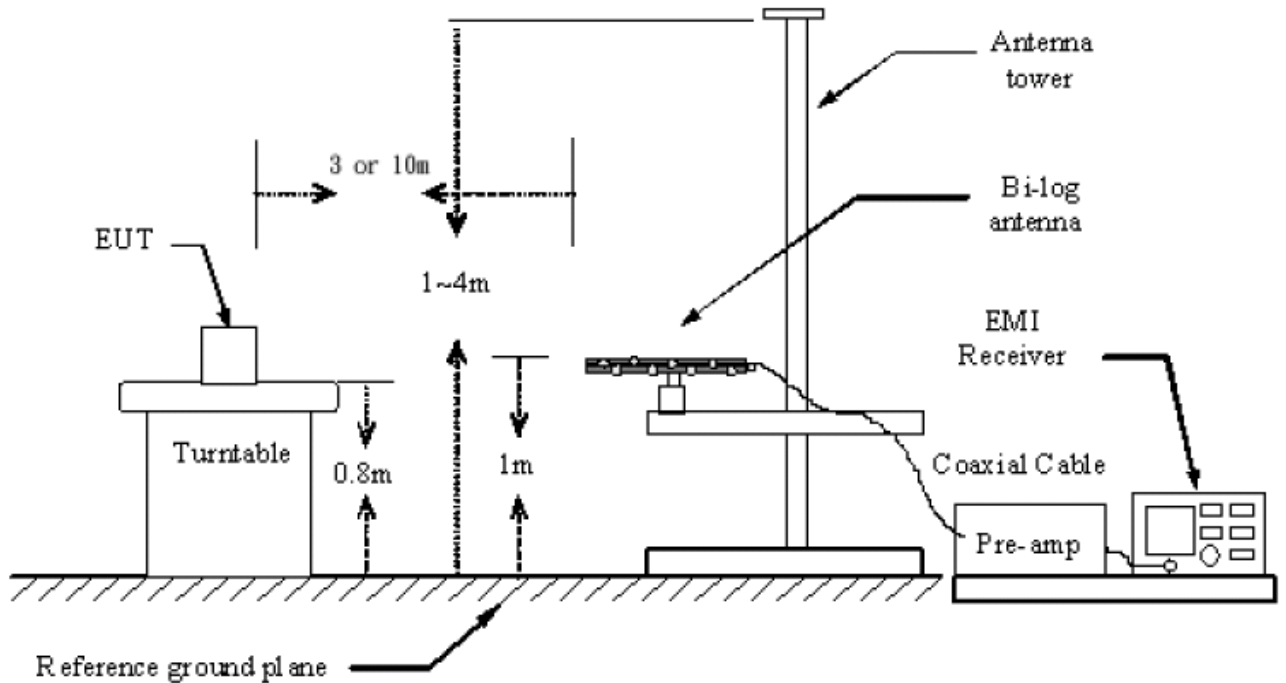

Report No.: TMTN2207001019NR

The diagram below shows the test setup that is utilized to make the measurements for emission above 1GHz.

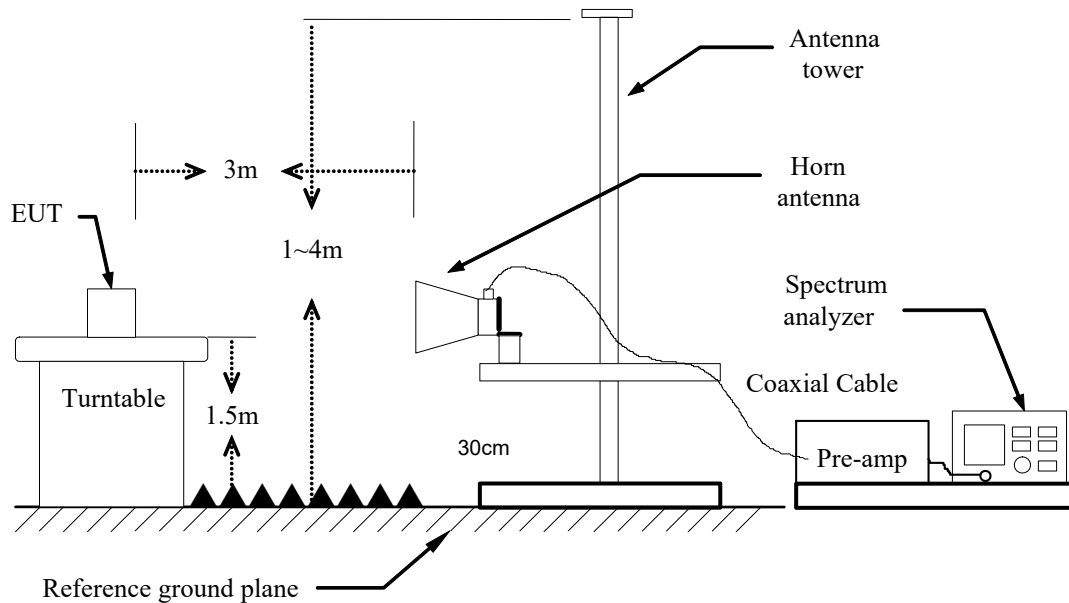

TEST PROCEDURE

- a. The EUT was placed on the top of a rotating table 0.8/1.5 meters above the ground at a 10 meter open area test site. The table was rotated 360 degrees to determine the position of the highest radiation.
- b. While measuring the radiated emission below 1GHz, the EUT was set 3 meters away from the interference-receiving antenna, which was mounted on the top of a variable-height antenna tower. While measuring the radiated emission above 1GHz, the EUT was set 3 meters away from the interference-receiving antenna.
- c. The antenna is a broadband antenna, and its height is varied from one meter to four meters above the ground to determine the maximum value of the field strength. Both horizontal and vertical polarization of the antenna are set to make the measurement.
- d. For each suspected emission, the EUT was arranged to its worst case and then the antenna was tuned to heights from 1 meter to 4 meters and the table was turned from 0 degrees to 360 degrees to find the maximum reading.
- e. The test-receiver system was set to Peak Detect Function and Specified Bandwidth with Maximum Hold Mode.
- f. If the emission level of the EUT in peak mode was 10 dB lower than the limit specified, then testing could be stopped and the peak values of the EUT would be reported. Otherwise the emissions that did not have 10 dB margin would be re-tested one by one using peak, quasi-peak or average method as specified and then reported in a data sheet.
- g. The tests were performed in accordance with 558074 D01 15.247 Meas Guidance v05

NOTE:

1. The resolution bandwidth and video bandwidth of test receiver/spectrum analyzer is 120 KHz for Peak detection (PK) and Quasi-peak detection (QP) at frequency below 1GHz.
2. The resolution bandwidth and video bandwidth of test receiver/spectrum analyzer is 1 MHz for Peak detection and frequency above 1GHz.
3. The resolution bandwidth of test receiver/spectrum analyzer is 1 MHz and the video bandwidth is 10 Hz for Average detection (AV) at frequency above 1GHz.
4. No emission is found between lowest internal used/generated frequency to 30MHz (9kHz~30MHz)

TEST RESULTS

No non-compliance noted.

Report No.: TMTN2207001019NR

9.6.2 WORST-CASE RADIATED EMISSION BELOW 1 GHz

Product Name	Cherry Wireless Keyboard	Test Date	2022/08/29
Model Name	JG-925	Test By	Peter Chu
Test Mode	TX	Temp & Humidity	25°C, 61%

Vertical

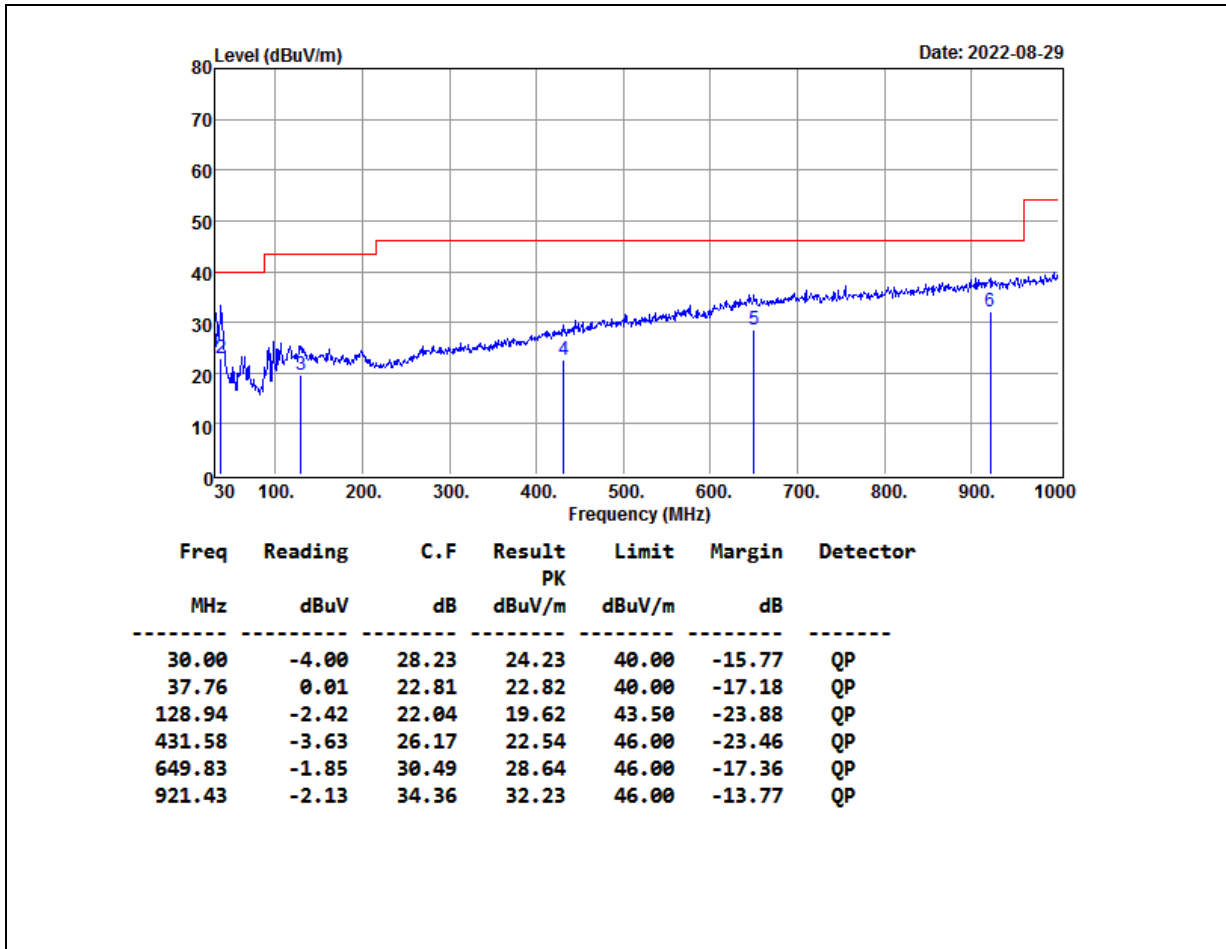

Remark:

1. No emission found between lowest internal used/generated frequency to 30MHz (9kHz~30MHz).
2. Radiated emissions measured were made with an instrument using peak/quasi-peak detector mode.
3. Quasi-peak test would be performed if the peak result were greater than the quasi-peak limit or as required by the applicant.
4. Margin (dB) = Remark result (dBUV/m) – Quasi-peak limit (dBUV/m).

Product Name	Cherry Wireless Keyboard	Test Date	2022/08/29
Model Name	JG-925	Test By	Peter Chu
Test Mode	TX	Temp & Humidity	25°C, 61%

Horizontal

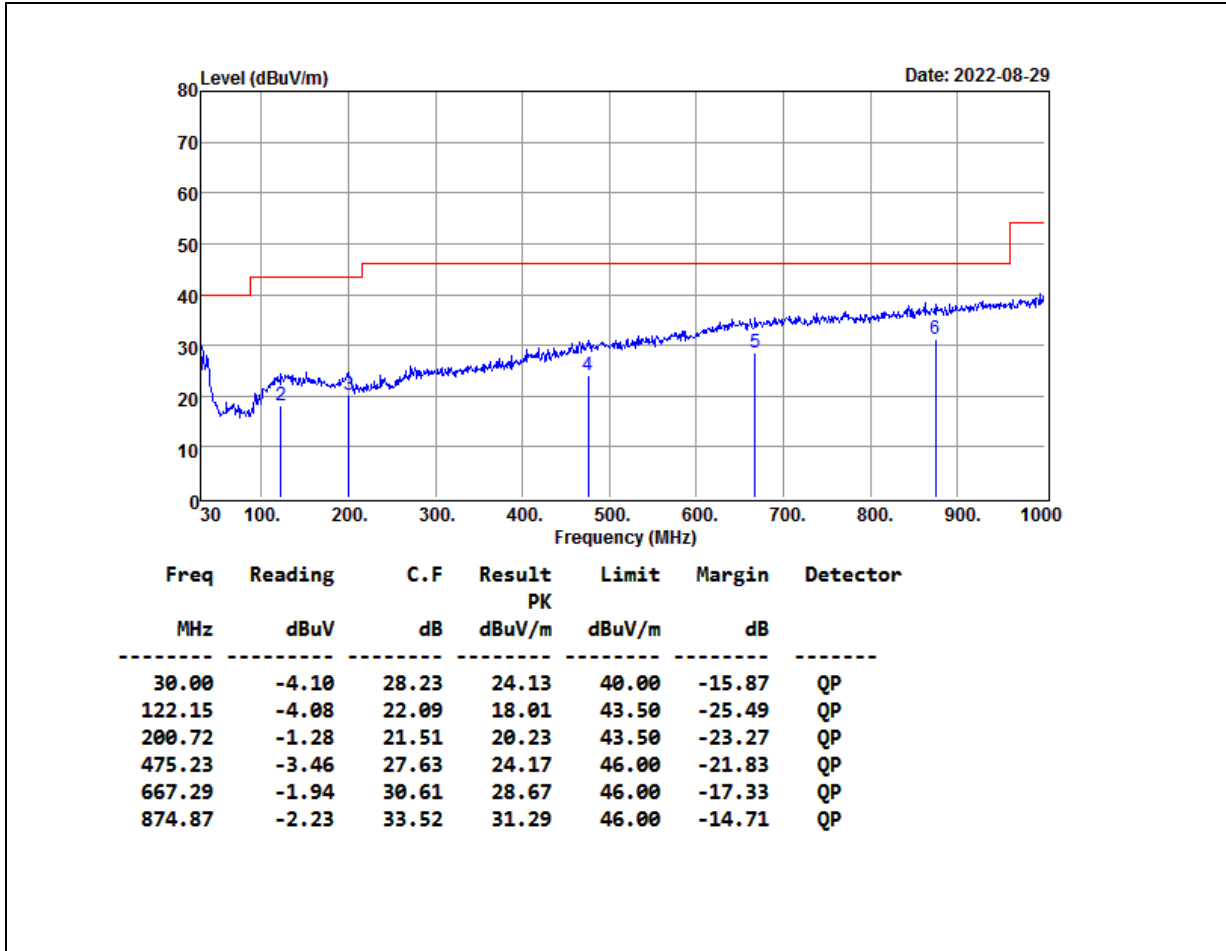

Remark:

1. No emission found between lowest internal used/generated frequency to 30MHz (9kHz~30MHz).
2. Radiated emissions measured were made with an instrument using peak/quasi-peak detector mode.
3. Quasi-peak test would be performed if the peak result were greater than the quasi-peak limit or as required by the applicant.
4. Margin (dB) = Remark result (dBuV/m) – Quasi-peak limit (dBuV/m).

9.6.3 TRANSMITTER RADIATED EMISSION ABOVE 1 GHz

Product Name	Cherry Wireless Keyboard	Test Date	2022/08/29
Model	JG-925	Test By	Peter Chu
Test Mode	GFSK(5.1) TX (CH Low)	TEMP& Humidity	25°C, 61%

Vertical

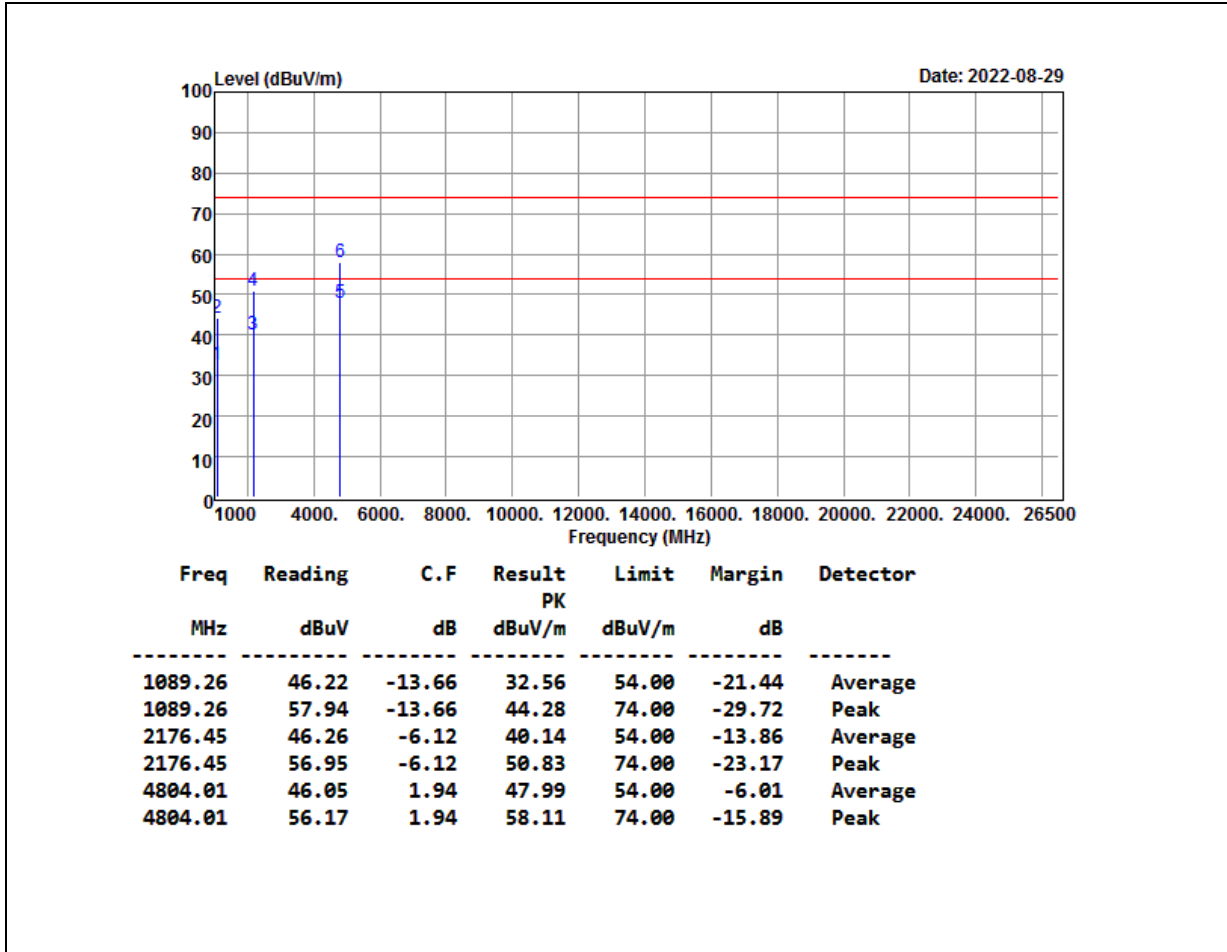

REMARK:

1. AF: Antenna Factor, Cable: Cable Loss, Pre-Amp: Preamplifier gain, Filter: 2.4GHz~2.5GHz Filter Insertion Loss
2. Spectrum analyzer setting P(Peak): RBW=1MHz, VBW=3MHz,A(Average): RBW=1MHz, VBW ≥ 1/T
3. The result basic equation calculation is as follow:
Level = Reading + AF + Cable – Preamp + Filter, Margin = Level-Limit
4. The other emission levels were 20dB below the limit
5. The test distance is 3m.
6. *=Restricted bands of operation

Product Name	Cherry Wireless Keyboard	Test Date	2022/08/29
Model	JG-925	Test By	Peter Chu
Test Mode	GFSK(5.1) TX (CH Low)	TEMP& Humidity	25°C, 61%

Horizontal

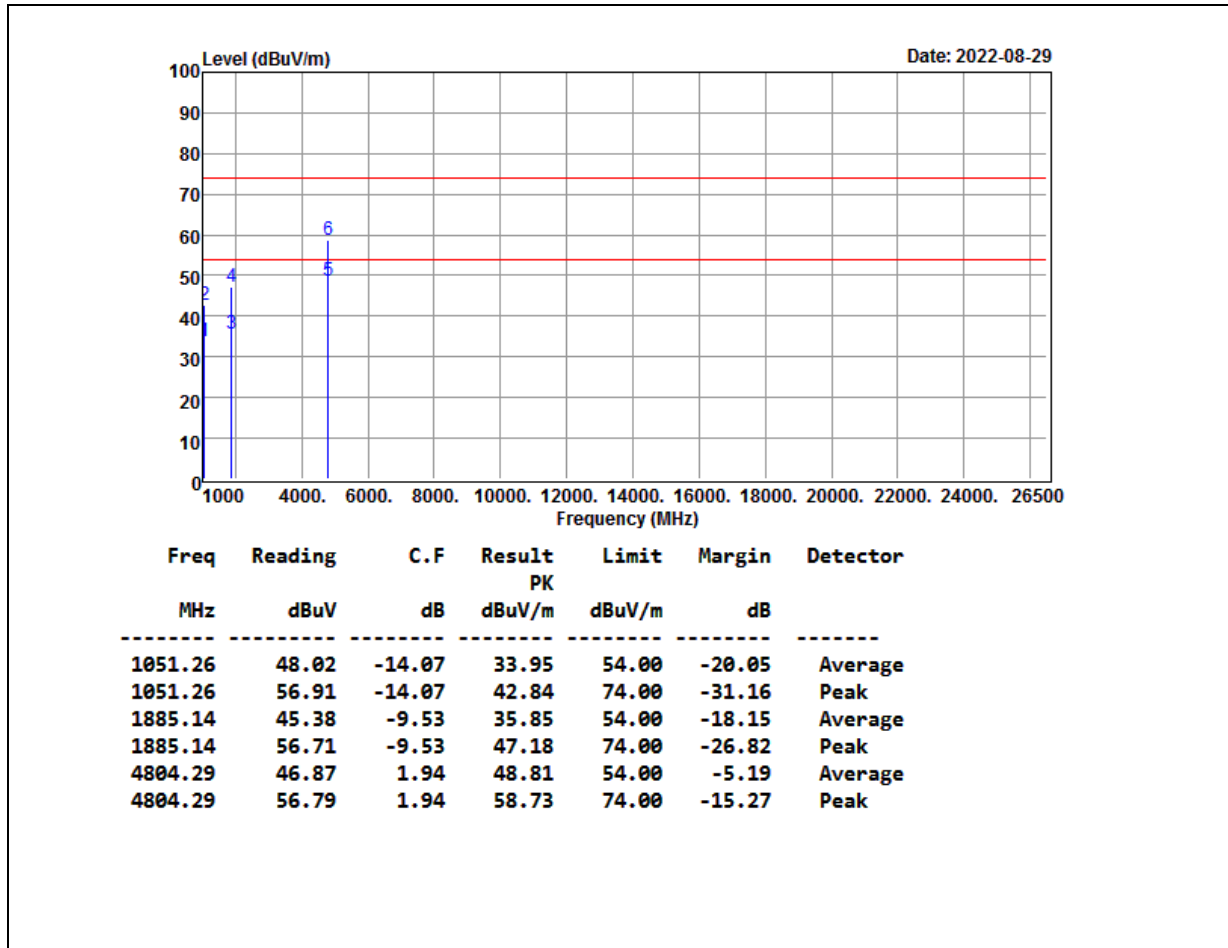

REMARK:

1. AF: Antenna Factor, Cable: Cable Loss, Pre-Amp: Preamplifier gain, Filter: 2.4GHz~2.5GHz Filter Insertion Loss
2. Spectrum analyzer setting P(Peak): RBW=1MHz, VBW=3MHz,A(Average): RBW=1MHz, VBW ≥ 1/T
3. The result basic equation calculation is as follow:
Level = Reading + AF + Cable – Preamp + Filter, Margin = Level-Limit
4. The other emission levels were 20dB below the limit
5. The test distance is 3m.
6. *=Restricted bands of operation

Product Name	Cherry Wireless Keyboard	Test Date	2022/08/29
Model	JG-925	Test By	Peter Chu
Test Mode	GFSK(5.1) TX (CH Middle)	TEMP& Humidity	25°C, 61%

Vertical

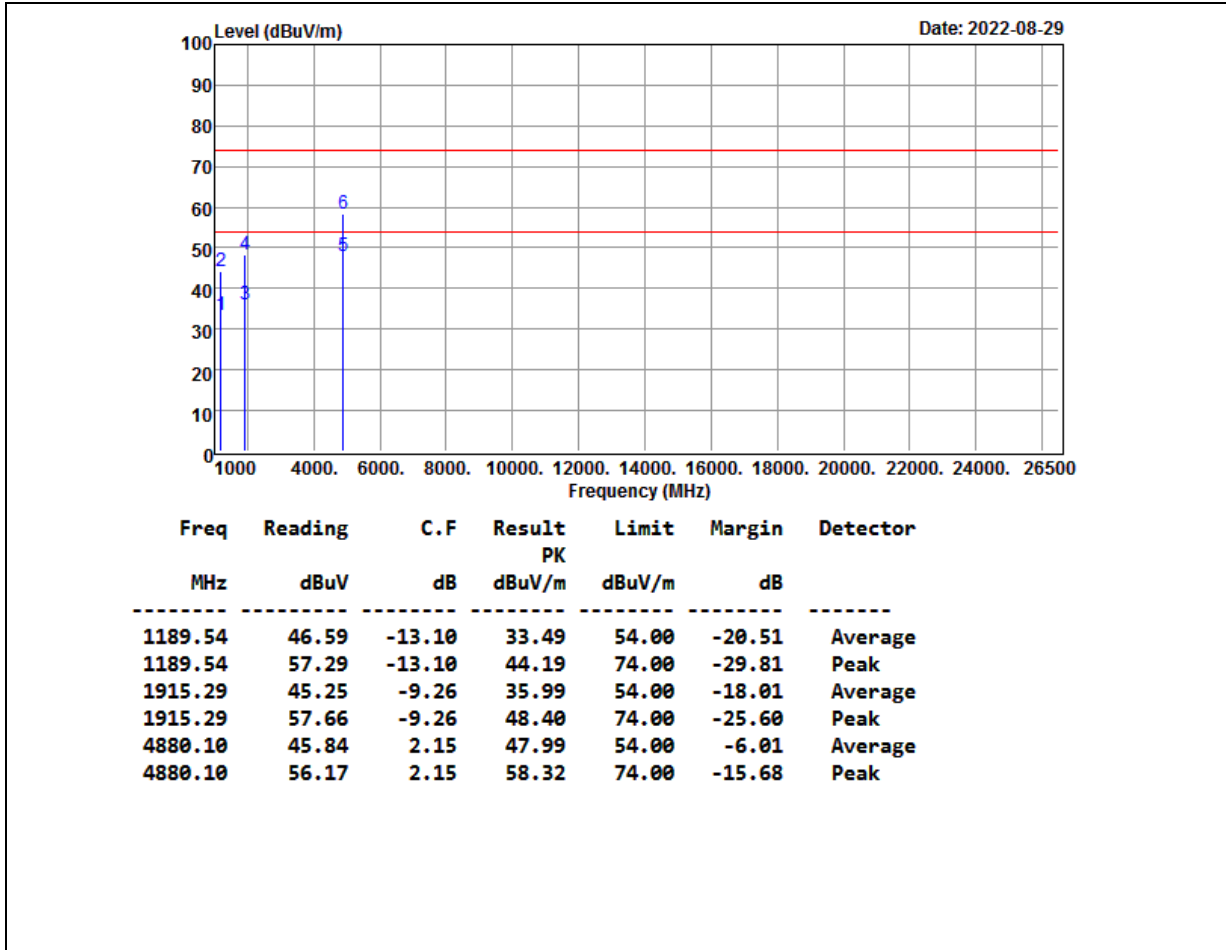

REMARK:

1. AF: Antenna Factor, Cable: Cable Loss, Pre-Amp: Preamplifier gain, Filter: 2.4GHz~2.5GHz Filter Insertion Loss
2. Spectrum analyzer setting P(Peak): RBW=1MHz, VBW=3MHz,A(Average): RBW=1MHz, VBW ≥ 1/T
3. The result basic equation calculation is as follow:
Level = Reading + AF + Cable – Preamp + Filter, Margin = Level-Limit
4. The other emission levels were 20dB below the limit
5. The test distance is 3m.
6. *=Restricted bands of operation

Product Name	Cherry Wireless Keyboard	Test Date	2022/08/29
Model	JG-925	Test By	Peter Chu
Test Mode	GFSK(5.1) TX (CH Middle)	TEMP& Humidity	25°C, 61%

Horizontal

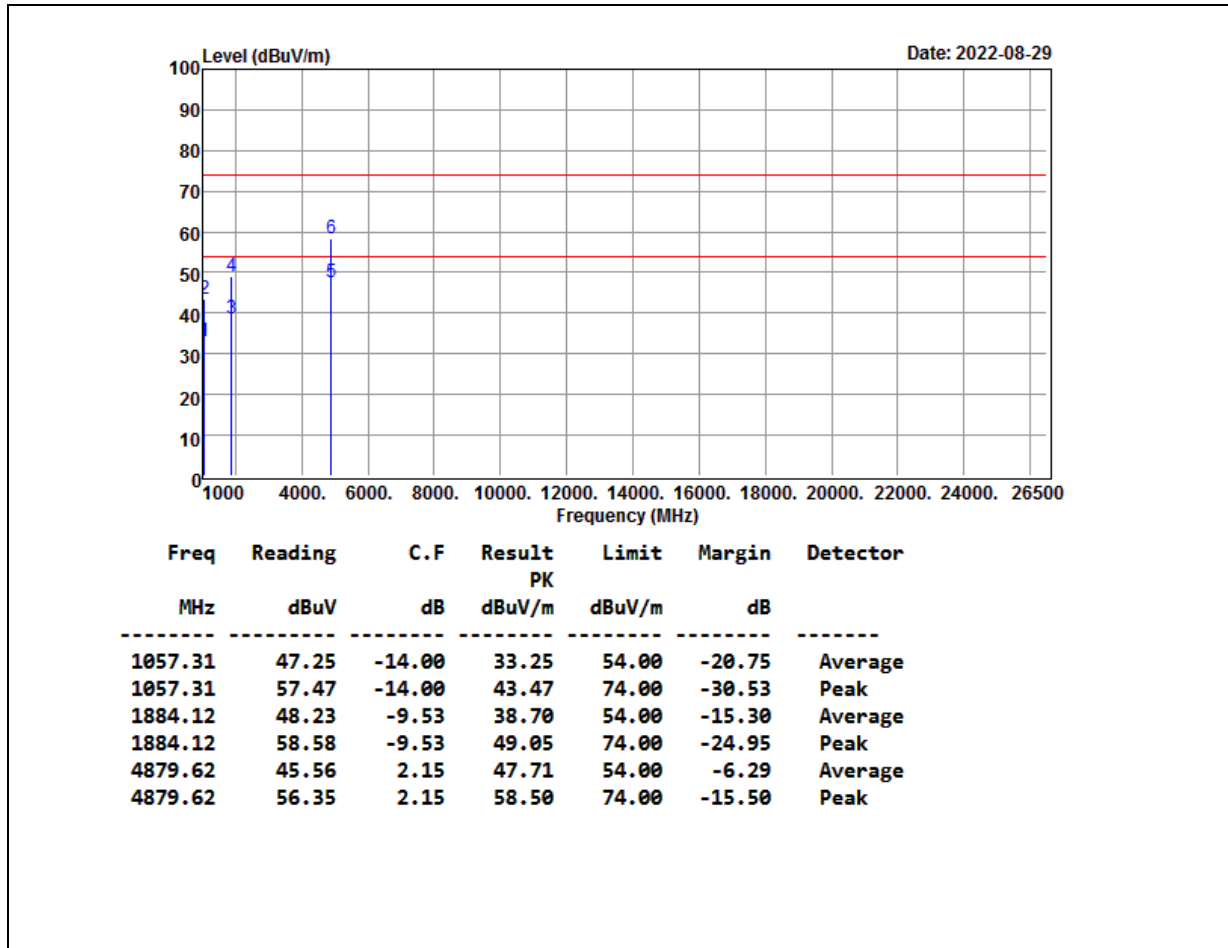

REMARK:

1. AF: Antenna Factor, Cable: Cable Loss, Pre-Amp: Preamplifier gain, Filter: 2.4GHz~2.5GHz Filter Insertion Loss
2. Spectrum analyzer setting P(Peak): RBW=1MHz, VBW=3MHz,A(Average): RBW=1MHz, VBW ≥ 1/T
3. The result basic equation calculation is as follow:
Level = Reading + AF + Cable – Preamp + Filter, Margin = Level-Limit
4. The other emission levels were 20dB below the limit
5. The test distance is 3m.
6. *=Restricted bands of operation

Product Name	Cherry Wireless Keyboard	Test Date	2022/08/29
Model	JG-925	Test By	Peter Chu
Test Mode	GFSK(5.1) TX (CH High)	TEMP& Humidity	25°C, 61%

Vertical

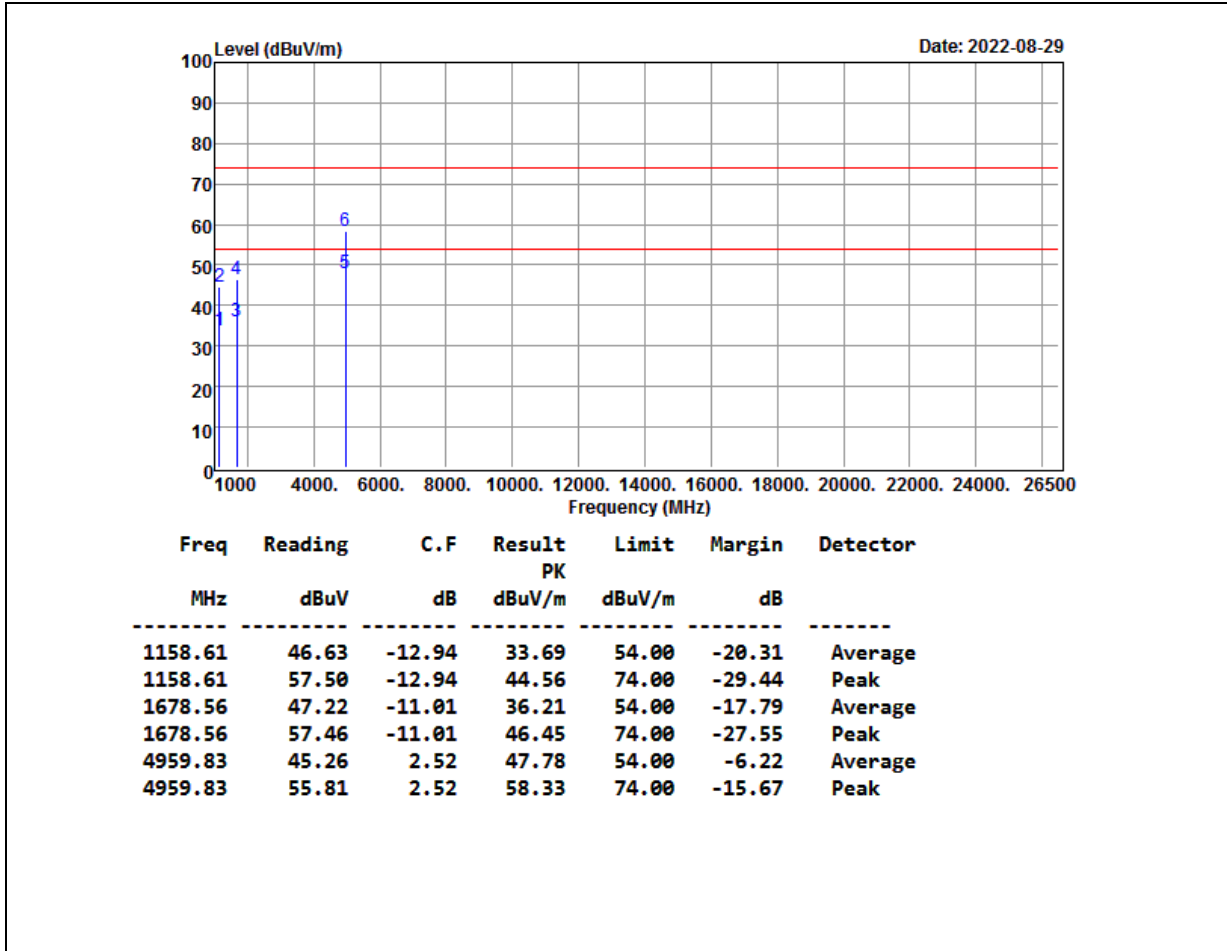

REMARK:

1. AF: Antenna Factor, Cable: Cable Loss, Pre-Amp: Preamplifier gain, Filter: 2.4GHz~2.5GHz Filter Insertion Loss
2. Spectrum analyzer setting P(Peak): RBW=1MHz, VBW=3MHz,A(Average): RBW=1MHz, VBW ≥ 1/T
3. The result basic equation calculation is as follow:
Level = Reading + AF + Cable – Preamp + Filter, Margin = Level-Limit
4. The other emission levels were 20dB below the limit
5. The test distance is 3m.
6. *=Restricted bands of operation

Product Name	Cherry Wireless Keyboard	Test Date	2022/08/29
Model	JG-925	Test By	Peter Chu
Test Mode	GFSK(5.1) TX (CH High)	TEMP& Humidity	25°C, 61%

Horizontal

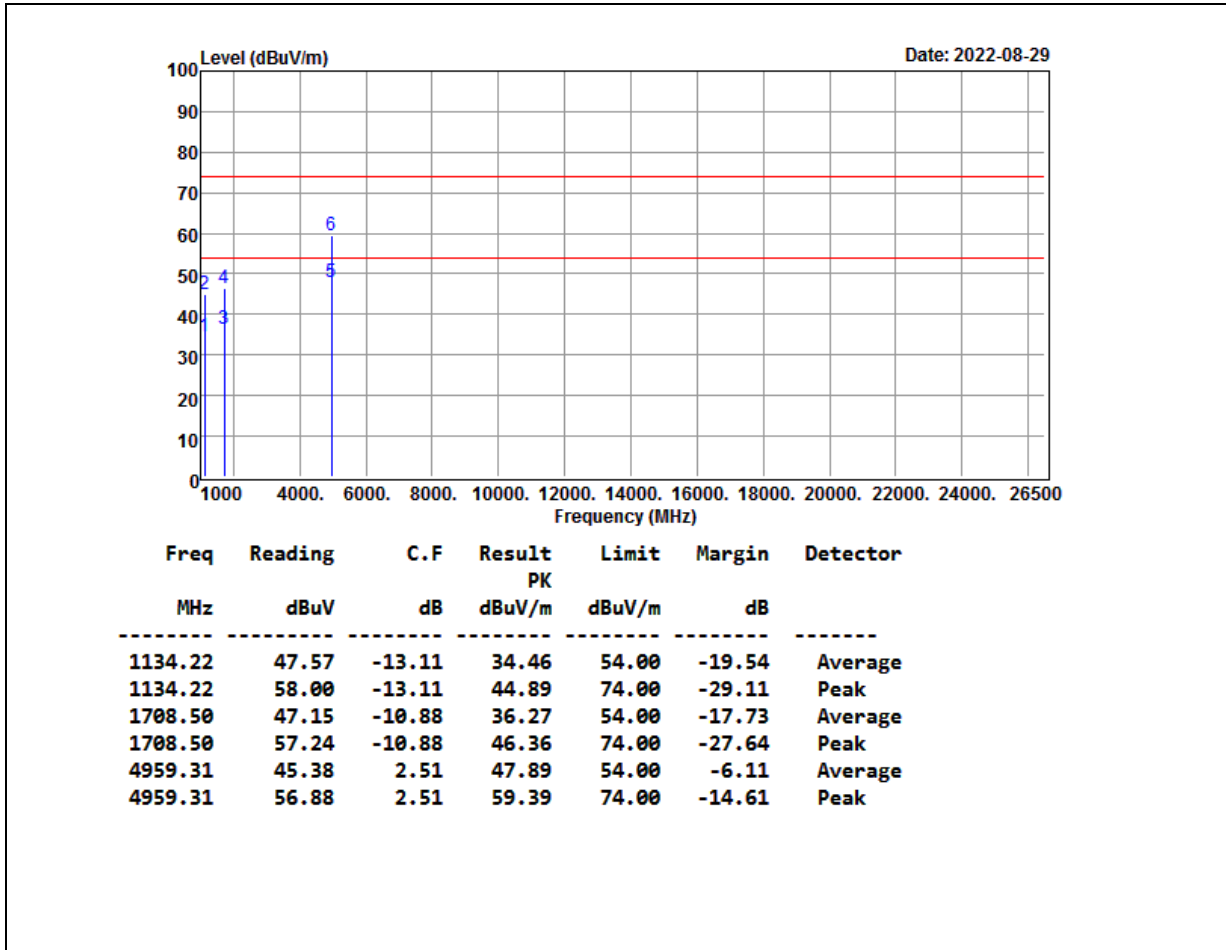

REMARK:

1. AF: Antenna Factor, Cable: Cable Loss, Pre-Amp: Preamplifier gain, Filter: 2.4GHz~2.5GHz Filter Insertion Loss
2. Spectrum analyzer setting P(Peak): RBW=1MHz, VBW=3MHz,A(Average): RBW=1MHz, VBW ≥ 1/T
3. The result basic equation calculation is as follow:
Level = Reading + AF + Cable – Preamp + Filter, Margin = Level-Limit
4. The other emission levels were 20dB below the limit
5. The test distance is 3m.
6. *=Restricted bands of operation

Report No.: TMTN2207001019NR

9.6.4 RESTRICTED BAND EDGES

Product Name	Cherry Wireless Keyboard	Test Date	2022/08/25
Model Name	JG-925	Test By	Peter Chu
Test Mode	GFSK(5.1) TX (CH Low)	Temp & Humidity	25°C, 61%

Horizontal

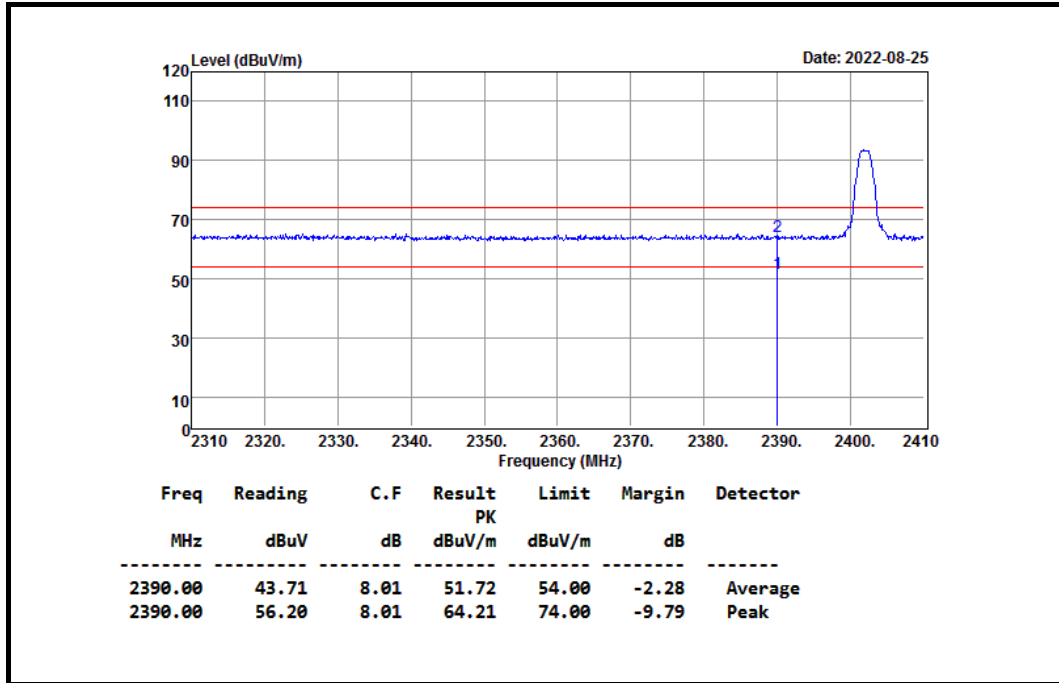

Vertical

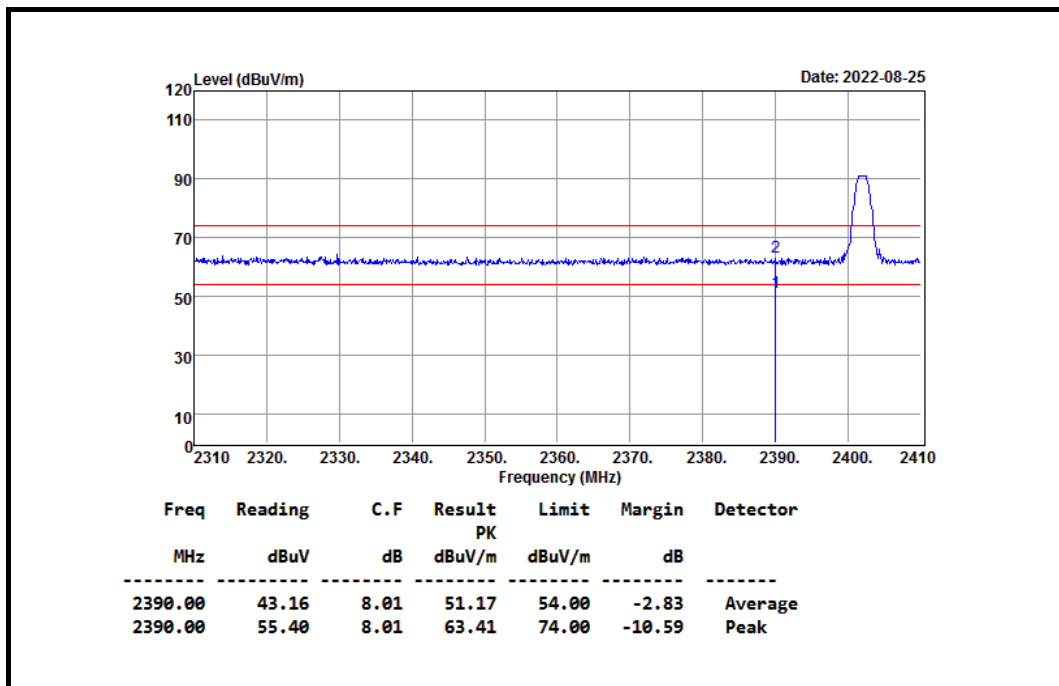

Product Name	Cherry Wireless Keyboard	Test Date	2022/08/25
Model Name	JG-925	Test By	Peter Chu
Test Mode	GFSK(5.1) TX (CH High)	Temp & Humidity	25°C, 61%

Horizontal

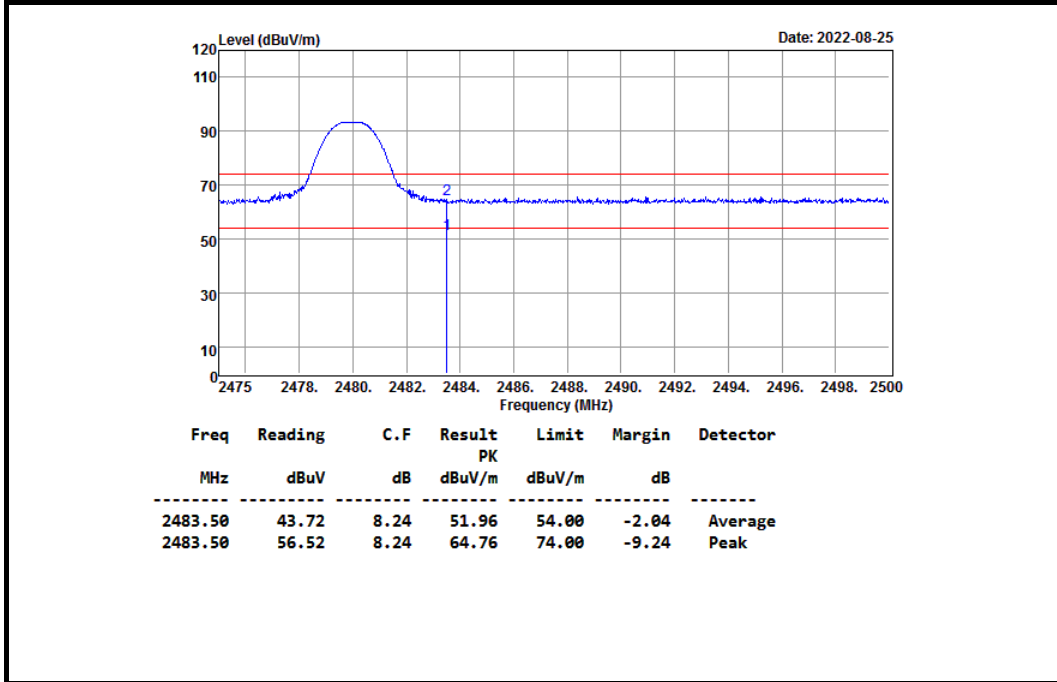

Vertical

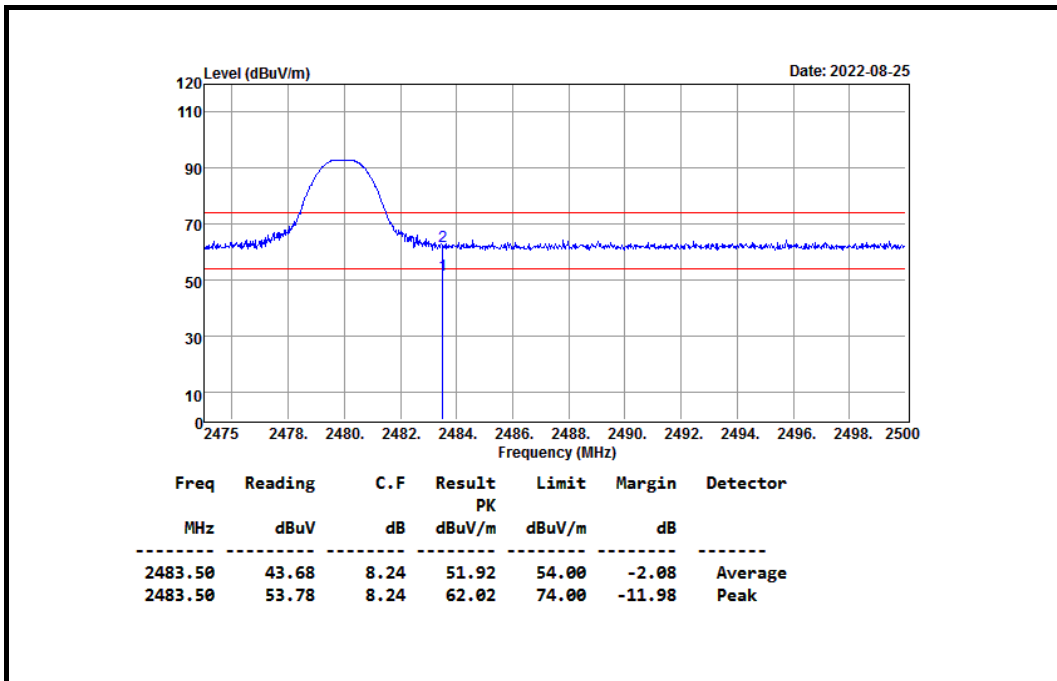

Report No.: TMTN2207001019NR

9.7 POWERLINE CONDUCTED EMISSIONS

LIMITS

§ 15.207 (a) Except as shown in paragraph (b) and (c) this section, for an intentional radiator that is designed to be connected to the public utility (AC) power line, the radio frequency voltage that is conducted back onto the AC power line on any frequency or frequencies within the band 150 kHz to 30 MHz shall not exceed the limits in the following table, as measured using a 50 μ H/50 ohms line impedance stabilization network (LISN). Compliance with the provisions of this paragraph shall be based on the measurement of the radio frequency voltage between each power line and ground at the power terminal.

The lower limit applies at the boundary between the frequency ranges.

Frequency of Emission (MHz)	Conducted limit (dB μ v)	
	Quasi-peak	Average
0.15 - 0.5	66 to 56	56 to 46
0.5 - 5	56	46
5 - 30	60	50

Report No.: TMTN2207001019NR

TEST SETUP

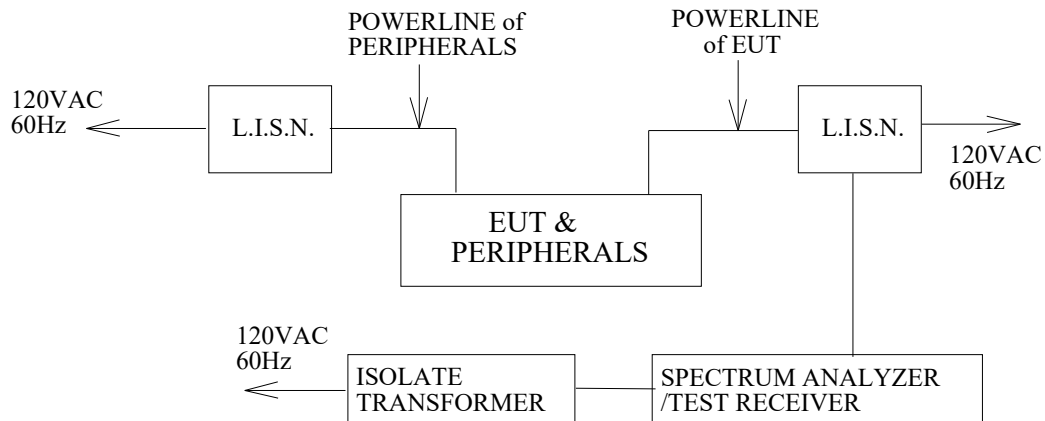

TEST PROCEDURE

The EUT is placed on a non-conducting table 40 cm from the vertical ground plane and 80cm above the horizontal ground plane. The EUT IS CONFIGURED IN ACCORDANCE WITH ANSI C63.10.

The resolution bandwidth is set to 9 kHz for both quasi-peak detection and average detection measurements.

Line conducted data is recorded for both NEUTRAL and LINE.

TEST RESULTS

No non-compliance noted.

※ This EUT is not connected to AC Source directly. Not applicable for this test.

10. ANTENNA REQUIREMENT

10.1 STANDARD APPLICABLE

For intentional device, according to FCC 47 CFR Section 15.203, an intentional radiator shall be designed to ensure that no antenna other than that furnished by the responsible party shall be used with the device.

And according to FCC 47 CFR Section 15.247 (b), if transmitting antennas of directional gain greater than 6dBi are used, the power shall be reduced by the amount in dB that the directional gain of the antenna exceeds 6dBi.

10.2 ANTENNA CONNECTED CONSTRUCTION

Manufacturer: ONEWAVE
Type: Chip Antenna
Model: WAN5020D245W36
Gain: 3.49dBi

=== END of Report ===