

# TEST REPORT

**Product Name** : CHERRY GENTIX BT  
**Model Number** : JF-75  
**FCC ID** : GDDJF-75

Prepared for : Cherry Europe GmbH  
Address : Cherrystraße 2, 91275 Auerbach /Opf

Prepared by : EMTEK (SHENZHEN) CO., LTD.  
Address : Building 69, Majialong Industry Zone, Nanshan District,  
Shenzhen, Guangdong, China

Tel: (0755) 26954280  
Fax: (0755) 26954282

Report Number : ENS2204290148W00101R  
Date(s) of Tests : April 29, 2022 to August 10, 2022  
Date of issue : August 11, 2022

## Table of Contents

<b>1</b>	<b>TEST RESULT CERTIFICATION .....</b>	<b>3</b>
<b>2</b>	<b>EUT TECHNICAL DESCRIPTION .....</b>	<b>5</b>
<b>3</b>	<b>SUMMARY OF TEST RESULT .....</b>	<b>6</b>
<b>4</b>	<b>TEST METHODOLOGY .....</b>	<b>7</b>
4.1	General Description Of Applied Standards .....	7
4.2	Measurement Equipment Used .....	7
4.3	Description Of Test Modes .....	8
<b>5</b>	<b>FACILITIES AND ACCREDITATIONS .....</b>	<b>9</b>
5.1	Facilities .....	9
5.2	Equipment .....	9
5.3	Laboratory Accreditations And Listings .....	9
<b>6</b>	<b>TEST SYSTEM UNCERTAINTY .....</b>	<b>10</b>
<b>7</b>	<b>SETUP OF EQUIPMENT UNDER TEST .....</b>	<b>11</b>
7.1	Radio Frequency Test Setup 1 .....	11
7.2	Radio Frequency Test Setup 2 .....	11
7.3	Conducted Emission Test Setup .....	14
7.4	Block Diagram Configuration Of Test System .....	15
7.5	Support Equipment .....	15
<b>8</b>	<b>TEST REQUIREMENTS .....</b>	<b>16</b>
8.1	On Time And Duty Cycle .....	16
8.2	Dts 6db Bandwidth .....	18
8.3	Dts 99% Bandwidth .....	20
8.4	Maximum Peak Conducted Output Power .....	22
8.5	Maximum Power Spectral Density .....	25
8.6	Unwanted Emissions In Non-Restricted Frequency Bands .....	27
8.7	Radiated Spurious Emission .....	33
8.8	Conducted Emissions Test .....	47
8.9	Antenna Application .....	48

# 1 TEST RESULT CERTIFICATION

Applicant : Cherry Europe GmbH  
 Address : Cherrystraße 2, 91275 Auerbach /Opf  
 Manufacturer : Cherry Europe GmbH  
 Address : Cherrystraße 2, 91275 Auerbach /Opf  
 EUT : CHERRY GENTIX BT  
 Model Name : JF-75  
 Trademark : 

Measurement Procedure Used:

APPLICABLE STANDARDS	
STANDARD	TEST RESULT
FCC 47 CFR Part 2 , Subpart J FCC 47 CFR Part 15, Subpart C	PASS
IC RSS-GEN, Issue 5(04-2018)+A1(03-2019)+A2(02-2021) IC RSS-247 Issue 2(02-2017)	PASS

The above equipment was tested by EMTEK(SHENZHEN) CO., LTD. The test data, data evaluation, test procedures, and equipment configurations shown in this report were made in accordance with the procedures given in ANSI C63.10 (2013) and the energy emitted by the sample EUT tested as described in this report is in compliance with the requirements of FCC Rules Part 2, Part 15.247, IC RSS-247 Issue 2 and IC RSS-GEN, Issue 5.

The test results of this report relate only to the tested sample identified in this report.

Date of Test : April 29, 2022 to August 10, 2022

Prepared by :   
 Una Yu /Editor

Reviewer :   
 Joe Xia/Supervisor

Approve & Authorized Signer :   
 Lisa Wang/Manager



## Modified History

Version	Report No.	Revision Date	Summary
V1.0	ENS2204290148W00101R	/	Original Report



## 2 EUT TECHNICAL DESCRIPTION

<b>Product:</b>	CHERRY GENTIX BT
<b>Model Number:</b>	JF-75
<b>Sample number:</b>	2#
<b>Device Type:</b>	Bluetooth V5.0
<b>Data Rate :</b>	1Mbps
<b>Modulation:</b>	GFSK
<b>Operating Frequency Range:</b>	2402-2480MHz
<b>Number of Channels:</b>	40 Channels
<b>Transmit Power Max:</b>	2.82 dBm
<b>Antenna Type:</b>	PCB Antenna
<b>Antenna Gain:</b>	-3.1 dBi
<b>Power Supply:</b>	DC 3V from Battery
<b>Date of Received:</b>	April 29, 2022
<b>Temperature Range:</b>	0°C ~ +40°C

*Note: for more details, please refer to the User's manual of the EUT.*

### 3 SUMMARY OF TEST RESULT

FCC Part Clause	IC Part Clause	Test Parameter	Verdict	Remark
15.247(a)(2)	RSS-247 5.2(a) RSS-Gen 6.7	Emission Bandwidth	PASS	
15.247(b)(3)	RSS-247 5.4(d) RSS-Gen 6.12	Maximum Peak Conducted Output Power	PASS	
15.247(e)	RSS-247 5.2(b) RSS-Gen 6.12	Maximum Power Spectral Density Level	PASS	
15.247(d)	RSS-247 5.5	Unwanted Emission Into Non-Restricted Frequency Bands	PASS	
15.247(d)	RSS-247 5.5	Unwanted Emission Into Restricted Frequency Bands (conducted)	PASS	
15.247(d) 15.209 15.205	RSS-Gen 8.9 RSS-Gen 8.10 RSS-Gen 6.13 RSS-247 3.3 RSS-247 5.5	Radiated Spurious Emission	PASS	
15.207	RSS-Gen 8.8	Conducted Emission Test	PASS	
15.203 15.247(b)	RSS-Gen 6.8 RSS-247 5.4	Antenna Application	PASS	
NOTE1: N/A (Not Applicable)				
NOTE2: According to FCC OET KDB 558074, the report use radiated measurements in the restricted frequency bands. In addition, the radiated test is also performed to ensure the emissions emanating from the device cabinet also comply with the applicable limits.				

#### RELATED SUBMITTAL(S)/GRANT(S):

This submittal(s) (test report) is intended for **FCC ID: GDDJF-75** filing to comply with Section 15.247 of the FCC Part 15, Subpart C Rules.

## 4 TEST METHODOLOGY

### 4.1 GENERAL DESCRIPTION OF APPLIED STANDARDS

According to its specifications, the EUT must comply with the requirements of the following standards:

FCC 47 CFR Part 2, Subpart J

FCC 47 CFR Part 15, Subpart C

IC RSS-GEN, Issue 5(04-2018)+A1(03-2019)+A2(02-2021)

IC RSS-247 Issue 2(02-2017)

FCC KDB 558074 D01 15.247 Meas Guidance v05r02

### 4.2 MEASUREMENT EQUIPMENT USED

#### Conducted Emission Test Equipment

Equipment	Manufacturer	Model No.	Serial No.	Last Cal.	Cal. Interval
Test Receiver	Rohde & Schwarz	ESCI	101384	May 14, 2022	1 Year
AMN.	Rohde & Schwarz	ENV216	101161	May 14, 2022	1 Year
L.I.S.N.	Kyoritsu	KNW-407	8-1492-9	May 15, 2022	1 Year

#### For Spurious Emissions Test

Equipment	Manufacturer	Model No.	Serial No.	Last Cal.	Cal. Interval
EMI Test Receiver	Rohde & Schwarz	ESU 26	100154	May 14, 2022	1 Year
Pre-Amplifie	Lunar EM	LNA30M3G-25	J10100000070	May 14, 2022	1 Year
Bilog Antenna	Schwarzbeck	VULB9163	661	Aug. 22, 2021	2 Year
Horn antenna	Schwarzbeck	BBHA9120D	9120D-1177	June 12, 2021	2 Year
Pre-Amplifie	SKET	LNPA_0118G-45	SK2019051801	May 14, 2022	1 Year
Loop Antenna	Schwarzbeck	FMZB1519	1519-012	Jun. 12, 2021	2 Year
Spectrum Analyzer	Rohde & Schwarz	FSV40	100967	May 14, 2022	1 Year
Horn antenna	Schwarzbeck	BBHA9120D	9120D-1178	Aug. 22, 2021	2 Year
Band reject Filter(50dB)	WI/DE	WRCGV-2400(2400-2485MHz)	2	May 14, 2022	1 Year

#### For other test items:

Equipment	Manufacturer	Model No.	Serial No.	Last Cal.	Cal. Interval
Wireless Connectivity Tester	R&S	CMW270	102543	Aug. 27, 2021	1Year
Automatic Control Unit	Tonscend	JS0806-2	2118060480	Nov. 18, 2021	1Year
Signal Analyzer	KEYSIGHT	N9010B	MY60242456	Jan. 21, 2022	1Year
Analog Signal Generator	KEYSIGHT	N5173B	MY61252625	Oct. 29, 2021	1Year
UP/DOWN-Converter	R&S	CMW-Z800A	100274	Sep. 14, 2021	1Year
Vector Signal Generator	KEYSIGHT	N5182B	MY61252674	Oct. 28, 2021	1Year
Frequency Extender	KEYSIGHT	N5182BX07	MY59362541	Nov. 23, 2021	1Year
Temperature&Humidity test chamber	ESPEC	EL-02KA	12107166	Jul. 02, 2022	1 Year

### 4.3 DESCRIPTION OF TEST MODES

The EUT has been tested under its typical operating condition.

The EUT configuration for testing is installed on RF field strength measurement to meet the Commissions requirement and operating in a manner which intends to maximize its emission characteristics in a continuous normal application.

The Transmitter was operated in the normal operating mode. The TX frequency was fixed which was for the purpose of the measurements.

Test of channel included the lowest and middle and highest frequency to perform the test, then record on this report.

Those data rates (Bluetooth DTS :1Mbps) were used for all test.

Pre-defined engineering program for regulatory testing used to control the EUT for staying in continuous transmitting and receiving mode is programmed.

Frequency and Channel list for Bluetooth DTS:

Channel	Frequency (MHz)	Channel	Frequency (MHz)	Channel	Frequency (MHz)
0	2402	19	2440	...	...
1	2404	20	2442	37	2476
2	2406	21	2444	38	2478
...	...	...	...	39	2480

Note:  $f_c=2402\text{MHz}+k \times 1\text{MHz}$   $k=1$  to 39

Test Frequency and channel for Bluetooth DTS:

Lowest Frequency		Middle Frequency		Highest Frequency	
Channel	Frequency (MHz)	Channel	Frequency (MHz)	Channel	Frequency (MHz)
0	2402	19	2440	39	2480



## 5 FACILITIES AND ACCREDITATIONS

### 5.1 FACILITIES

All measurement facilities used to collect the measurement data are located at:

EMTEK (Shenzhen) Co., Ltd.

Building 69, Majialong Industry Zone District, Nanshan District, Shenzhen, China

The sites are constructed in conformance with the requirements of ANSI C63.7, ANSI C63.4 and CISPR Publication 22.

### 5.2 EQUIPMENT

Radiated emissions are measured with one or more of the following types of linearly polarized antennas: tuned dipole, biconical, log periodic, bi-log, and/or ridged waveguide, horn. Spectrum analyzers with preselectors and quasi-peak detectors are used to perform radiated measurements.

Conducted emissions are measured with Line Impedance Stabilization Networks and EMI Test Receivers.

Calibrated wideband preamplifiers, coaxial cables, and coaxial attenuators are also used for making measurements.

All receiving equipment conforms to CISPR Publication 16-1, "Radio Interference Measuring Apparatus and Measurement Methods."

### 5.3 LABORATORY ACCREDITATIONS AND LISTINGS

Site Description	
EMC Lab.	<p><b>Accredited by CNAS</b> The Certificate Registration Number is L2291. The Laboratory has been assessed and proved to be in compliance with CNAS-CL01 (identical to ISO/IEC 17025:2017)</p> <p><b>Accredited by FCC</b> Designation Number: CN1204 Test Firm Registration Number: 882943</p> <p><b>Accredited by A2LA</b> The Certificate Number is 4321.01.</p> <p>Accredited by Industry Canada The Conformity Assessment Body Identifier is CN0008</p>
Name of Firm	: EMTEK (SHENZHEN) CO., LTD.
Site Location	: Building 69, Majialong Industry Zone, Nanshan District, Shenzhen, Guangdong, China

## 6 TEST SYSTEM UNCERTAINTY

The following measurement uncertainty levels have been estimated for tests performed on the apparatus:

Test Parameter	Measurement Uncertainty
Radio Frequency	$\pm 1 \times 10^{-5}$
Maximum Peak Output Power Test	$\pm 1.0\text{dB}$
Conducted Emissions Test	$\pm 2.0\text{dB}$
Radiated Emission Test	$\pm 2.0\text{dB}$
Power Density	$\pm 2.0\text{dB}$
Occupied Bandwidth Test	$\pm 1.0\text{dB}$
Band Edge Test	$\pm 3\text{dB}$
All emission, radiated	$\pm 3\text{dB}$
Antenna Port Emission	$\pm 3\text{dB}$
Temperature	$\pm 0.5^\circ\text{C}$
Humidity	$\pm 3\%$

Measurement Uncertainty for a level of Confidence of 95%

## 7 SETUP OF EQUIPMENT UNDER TEST

### 7.1 RADIO FREQUENCY TEST SETUP 1

The Bluetooth component's antenna ports(s) of the EUT are connected to the measurement instrument per an appropriate attenuator. The EUT is controlled by PC/software to emit the specified signals for the purpose of measurements.

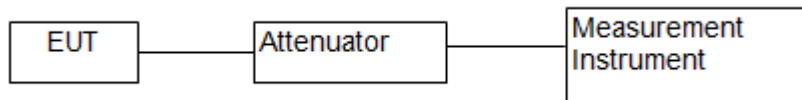

### 7.2 RADIO FREQUENCY TEST SETUP 2

The test site semi-anechoic chamber has met the requirement of NSA tolerance 4 dB according to the standards: ANSI C63.10. The test distance is 3m. The setup is according to the requirements in Section 13.1.4.1 of ANSI C63.10-2013 and CAN/CSA-CEI/IEC CISPR 22.

The maximal emission value is acquired by adjusting the antenna height, polarisation and turntable azimuth. Normally, the height range of antenna is 1 m to 4 m, the azimuth range of turntable is 0° to 360°, and the receive antenna has two polarizations Vertical (V) and Horizontal (H).

Below 30MHz:

The EUT is placed on a turntable 0.8 meters above the ground in the chamber, 3 meter away from the antenna (loop antenna). The Antenna should be positioned with its plane vertical at the specified distance from the EUT and rotated about its vertical axis for maximum response at each azimuth about the EUT. The center of the loop shall be 1 m above the ground. For certain applications, the loop antenna plane may also need to be positioned horizontally at the specified distance from the EUT.

Above 30MHz:

The EUT is placed on a turntable 0.8 meters above the ground in the chamber, 3 meter away from the antenna. The maximal emission value is acquired by adjusting the antenna height, polarisation and turntable azimuth. Normally, the height range of antenna is 1 m to 4 m, the azimuth range of turntable is 0° to 360°, and the receive antenna has two polarizations Vertical (V) and Horizontal (H).

Above 1GHz:

The EUT is placed on a turntable 1.5 meters above the ground in the chamber, 3 meter away from the antenna. The maximal emission value is acquired by adjusting the antenna height, polarisation and turntable azimuth. Normally, the height range of antenna is 1 m to 4 m, the azimuth range of turntable is 0° to 360°, and the receive antenna has two polarizations Vertical (V) and Horizontal (H).

Measurements shall be taken, using the following steps, at a test site that has been validated using the procedures of ANSI C63.4 or the latest CISPR 16-1-4 for measurements above 1 GHz, so as to simulate a near free-space environment (see RSS-Gen for applicable versions of ANSI and CISPR standards).

(1) Line the ground plane with absorbers between the transmitter and the receive antenna to minimize reflections. The absorbers used should have a minimum-rated attenuation of 20 dB through the measurement frequency range of interest. The absorbers shall be positioned to replicate the layout used when compliance with the applicable acceptability criterion was achieved, as set forth in the aforementioned standards on site validation.

(2) Set the height of the receive antenna to 1.5 m. The receive antenna must be one that was designed and fabricated to operate over the entire frequency range of interest, for example, an appropriate standard gain horn.

(3) The distance between the receive antenna and the radiating source shall be sufficient in order to ensure far-field conditions.

(4) Mount the transmitter at a height of 1.5 m.

(5) Configure the device under test (DUT) to produce the maximum power spectral density as measured while assessing compliance with Section 6.2.2 (i.e. channel frequency, modulation type and data rate). If the DUT is equipped with a detachable antenna and the antenna is intended for remote installation (i.e.

tower-mounted), the DUT may be substituted with a suitable signal generator. The level and frequency settings on the generator shall be set so as to reproduce the maximum power spectral density, measured within a 1 MHz bandwidth, obtained while assessing compliance to Section 6.2.2.

(6) Position the transmitter or the radiating antenna so that elevation pattern measurements can be taken.

(7) Find the 0° reference point in the horizontal plane.

(8) Care should be taken when positioning the receive antenna to avoid cross-polarization. Antennas of known mounting polarization should be assessed with the receive antenna oriented in the same polarity. If the polarization of the transmit antenna is unknown or the transmit antenna can be mounted in either polarization, e.i.r.p. measurements should be performed to find which mounting polarity provides the highest e.i.r.p. value. Testing shall be carried out with the receive antenna and the DUT mounted in each polarity.

(9) The emission shall be centred on the display of the spectrum analyzer with the following settings:

i. If the power spectral density of the DUT was assessed with a peak detector and the antenna cannot be detached from the DUT, the spectrum analyzer shall be set to a peak detector with a resolution bandwidth and video bandwidth of 1 MHz.

ii. If the power spectral density of the DUT was assessed using a sample detector with power averaging and the antenna cannot be detached from the DUT, the spectrum analyzer shall be set to a sample detector, configured to produce 100 power averages and set with a resolution bandwidth, as well as a video bandwidth of 1 MHz.

iii. If the antenna can be detached from the DUT, a continuous wave (CW) signal equal to that of the power spectral density measurement may be used, the spectrum analyzer shall be set to peak detector with a resolution bandwidth and video bandwidth of 1 MHz.

(10) Rotate the turntable 360° recording the field strength at each step. Throughout the main beam of the antenna, the step size shall be kept to a maximum of 1°.

Once outside the main beam of the antenna, the maximum step size shall be as follows, when compared to the requirements of Section 6.2.2:

i. Between 0° and 8°, maximum step size of 2°;

ii. Between 8° and 40°, maximum step size of 4°;

iii. Between 40° and 45°, maximum step size of 1°;

iv. Between 45° and 90°, maximum step size of 5°.

Once the mask reaches 90°, the mask will be inverted and the step size will follow in the same manner as above.

For the purpose of this procedure, the main beam of the antenna is defined as the 3 dB beamwidth.

(11) Convert the measured field strength values in terms of e.i.r.p. density (dBW/1 MHz) using the following equation:

$$\text{e.i.r.p. density (dBW/MHz)} = 10 \log((E \cdot r)^2 / 30)$$

E = field strength in V/m

r = measurement distance in metres

(12) Plot the results against the emission mask with reference to the horizontal plane.

(13) Using the plot, the 0° can be rotated to determine the worst-case installation tilt angle.

(14) Testing shall be performed using the highest gain antenna for every antenna type, if applicable.

(15) Antenna type(s), antenna model number(s), and worst-case tilt angle(s) necessary to remain compliant with the elevation mask requirement set forth in Section 6.2.2(3) of RSS-247 shall be clearly indicated in the user manual.

The following figure is an example of a polar elevation mask measured using the Method 1 reference to dBμV/m at 3 m.

(a) Radiated Emission Test Set-Up, Frequency Below 30MHz

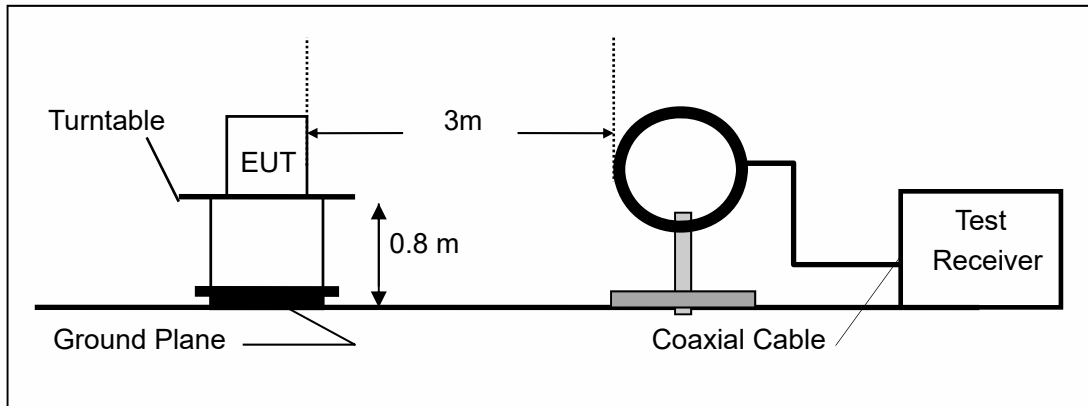

(b) Radiated Emission Test Set-Up, Frequency Below 1000MHz

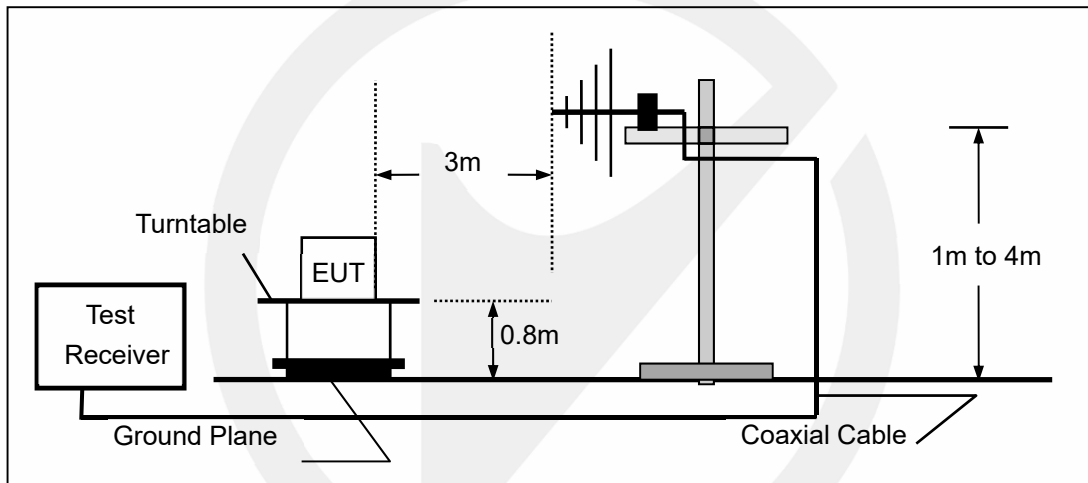

(c) Radiated Emission Test Set-Up, Frequency above 1000MHz

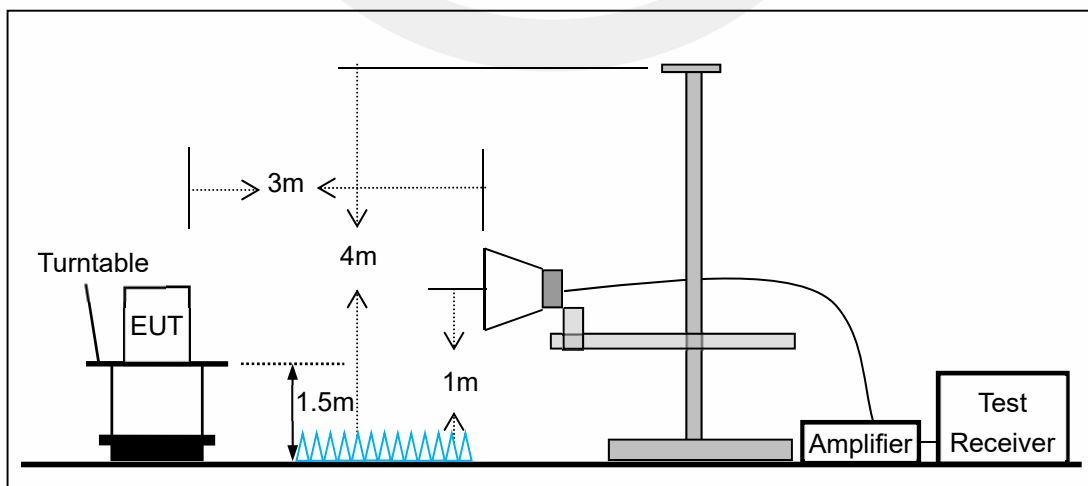

### 7.3 CONDUCTED EMISSION TEST SETUP

The mains cable of the EUT (maybe per AC/DC Adapter) must be connected to LISN. The LISN shall be placed 0.8 m from the boundary of EUT and bonded to a ground reference plane for LISN mounted on top of the ground reference plane. This distance is between the closest points of the LISN and the EUT. All other units of the EUT and associated equipment shall be at least 0.8m from the LISN.

Ground connections, where required for safety purposes, shall be connected to the reference ground point of the LISN and, where not otherwise provided or specified by the manufacturer, shall be of same length as the mains cable and run parallel to the mains connection at a separation distance of not more than 0.8 m.

According to the requirements in Section 13.1.4.1 of ANSI C63.10-2013 Conducted emissions from the EUT measured in the frequency range between 0.15 MHz and 30 MHz using CISPR Quasi-Peak and average detector mode.

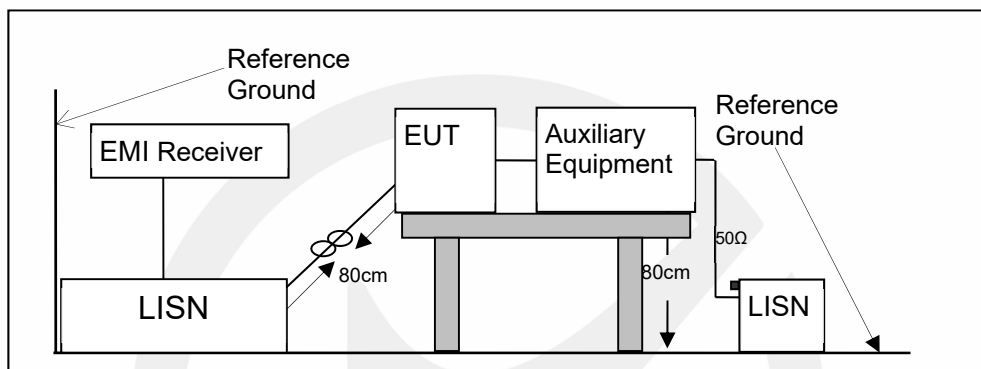

**7.4 BLOCK DIAGRAM CONFIGURATION OF TEST SYSTEM**

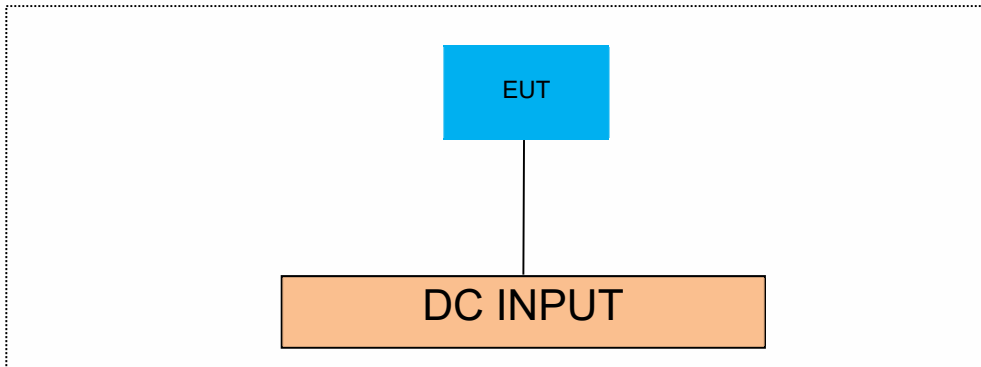

**7.5 SUPPORT EQUIPMENT**

EUT Cable List and Details			
Cable Description	Length (m)	Shielded/Unshielded	With / Without Ferrite
/	/	/	/

Auxiliary Cable List and Details			
Cable Description	Length (m)	Shielded/Unshielded	With / Without Ferrite
/	/	/	/

Auxiliary Equipment List and Details			
Description	Manufacturer	Model	Serial Number
/	/	/	/

**Notes:**

1. All the equipment/cables were placed in the worst-case configuration to maximize the emission during the test.
2. Grounding was established in accordance with the manufacturer's requirements and conditions for the intended use.

## 8 TEST REQUIREMENTS

### 8.1 ON TIME AND DUTY CYCLE

#### 8.1.1 Applicable Standard

According to 558074 D01 Section 6

#### 8.1.2 Conformance Limit

N/A; for reporting purposes only.

#### 8.1.3 Test Configuration

Test according to clause 7.1 radio frequency test setup.

#### 8.1.4 Test Procedure

The zero-span mode on a spectrum analyzer or EMI receiver, if the response time and spacing between bins on the sweep are sufficient to permit accurate measurements of the on and off times of the transmitted signal. Set the center frequency of the instrument to the center frequency of the transmission. Set RBW  $\geq$  EBW if possible; otherwise, set RBW to the largest available value. Set VBW  $\geq$  RBW. Set detector = peak or average. The zero-span measurement method shall not be used unless both RBW and VBW are  $> 50/T$ , where T is the minimum transmission duration over which the transmitter is on and is transmitting at its maximum power control level for the tested mode of operation), and the number of sweep points across duration T exceeds 100. (For example, if VBW and/or RBW are limited to 3 MHz, then the zero-span method of measuring duty cycle shall not be used if  $T \leq 16.7$  microseconds.)

#### 8.1.5 Test Results

Temperature:	25°C
Relative Humidity:	45%
ATM Pressure:	1011 mbar
Test Engineer:	XXH

Note: N/A

TestMode	Antenna	Frequency[MHz]	ON Time [ms]	Period [ms]	Duty Cycle [%]	Duty Cycle Factor[dB]
BLE_1M	Ant1	2402	0.43	0.64	67.19	1.73
		2440	0.43	0.64	67.19	1.73
		2480	0.43	0.64	67.19	1.73



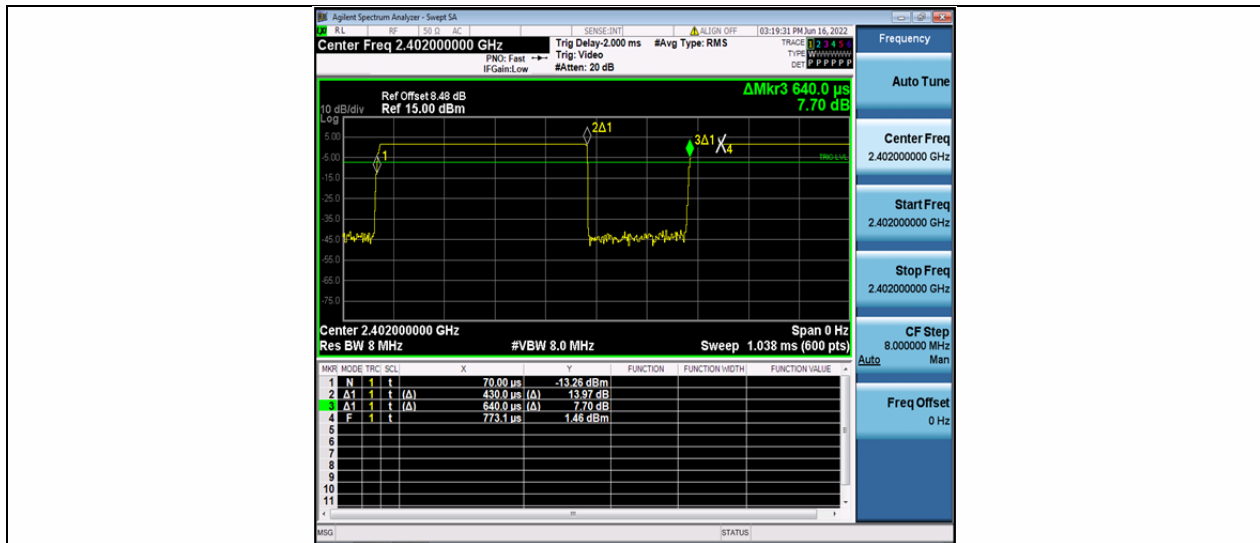

BLE\_1M\_Ant1\_2402

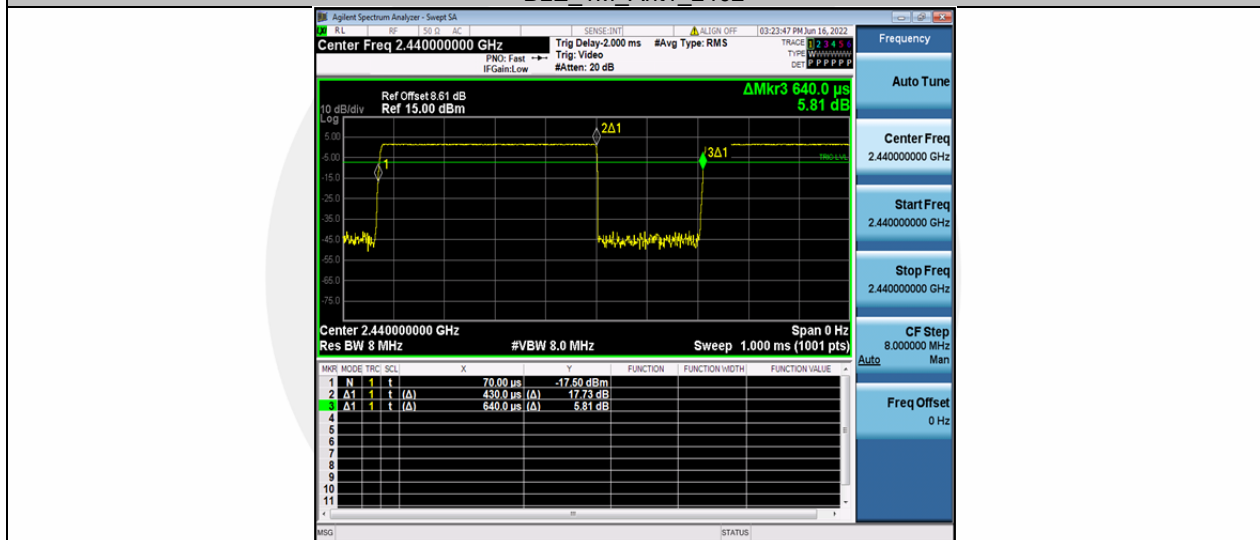

BLE\_1M\_Ant1\_2440

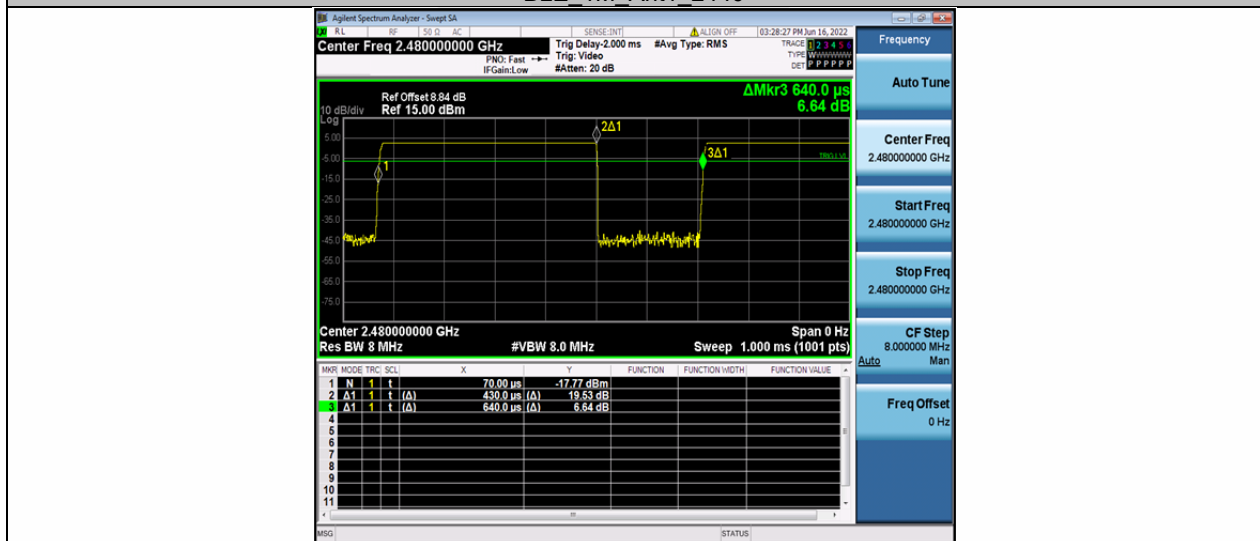

BLE\_1M\_Ant1\_2480

## 8.2 DTS 6DB BANDWIDTH

### 8.2.1 Applicable Standard

According to FCC Part15.247 (a)(2)

According to RSS-247 5.2(a)

According to 558074 D01 15.247 Meas Guidance v05r02 Section 8.2

According to ANSI C63.10 Section 11.8

### 8.2.2 Conformance Limit

The minimum -6 dB bandwidth shall be at least 500 kHz.

### 8.2.3 Test Configuration

Test according to clause 7.1 radio frequency test setup 1

### 8.2.4 Test Procedure

The EUT was operating in Bluetooth mode and controlled its channel. Printed out the test result from the spectrum by hard copy function.

The RF output of EUT was connected to the spectrum analyzer by RF cable and attenuator. The path loss was compensated to the results for each measurement.

Set to the maximum power setting and enable the EUT transmit continuously

Set RBW = 100 kHz.

Set the video bandwidth (VBW) =300 kHz.

Set Span=2 times OBW

Set Detector = Peak.

Set Trace mode = max hold.

Set Sweep = auto couple.

Allow the trace to stabilize.

Measure the maximum width of the emission that is constrained by the frequencies associated with the two outermost amplitude points (upper and lower frequencies) that are attenuated by 6 dB relative to the maximum level measured in the fundamental emission.

Measure and record the results in the test report.

### Test Results

Temperature:	25°C
Relative Humidity:	45%
ATM Pressure:	1011 mbar
Test Engineer:	XXH

Note: N/A

TestMode	Antenna	Frequency[MHz]	DTS BW [MHz]	FL[MHz]	FH[MHz]	Limit[MHz]	Verdict
BLE_1M	Ant1	2402	0.936	2401.588	2402.524	0.5	PASS
		2440	0.928	2439.588	2440.516	0.5	PASS
		2480	0.912	2479.596	2480.508	0.5	PASS

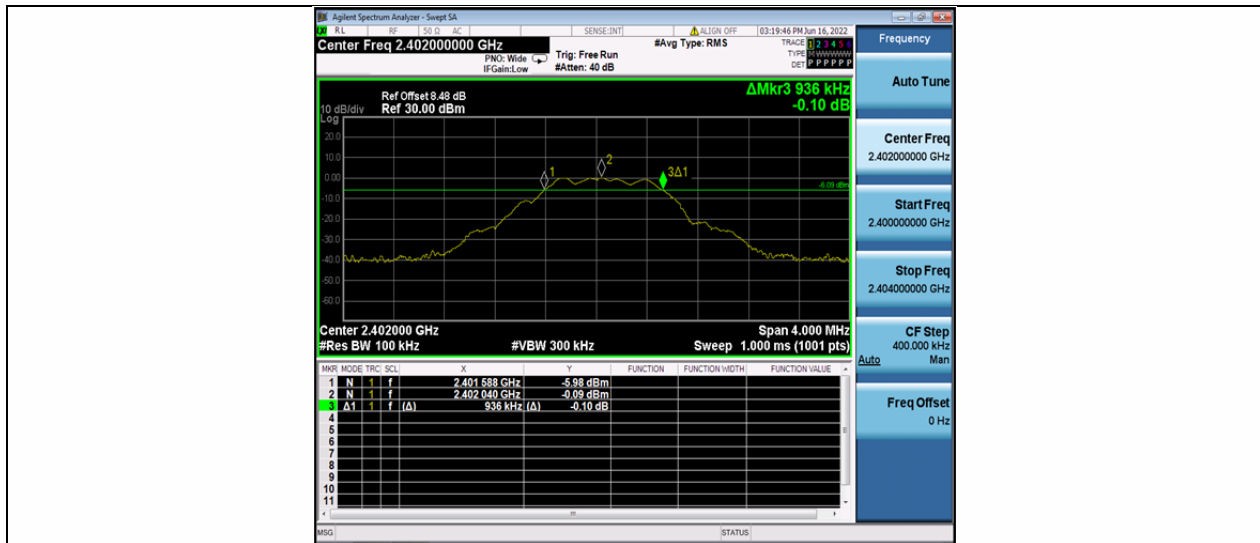

BLE\_1M\_Ant1\_2402

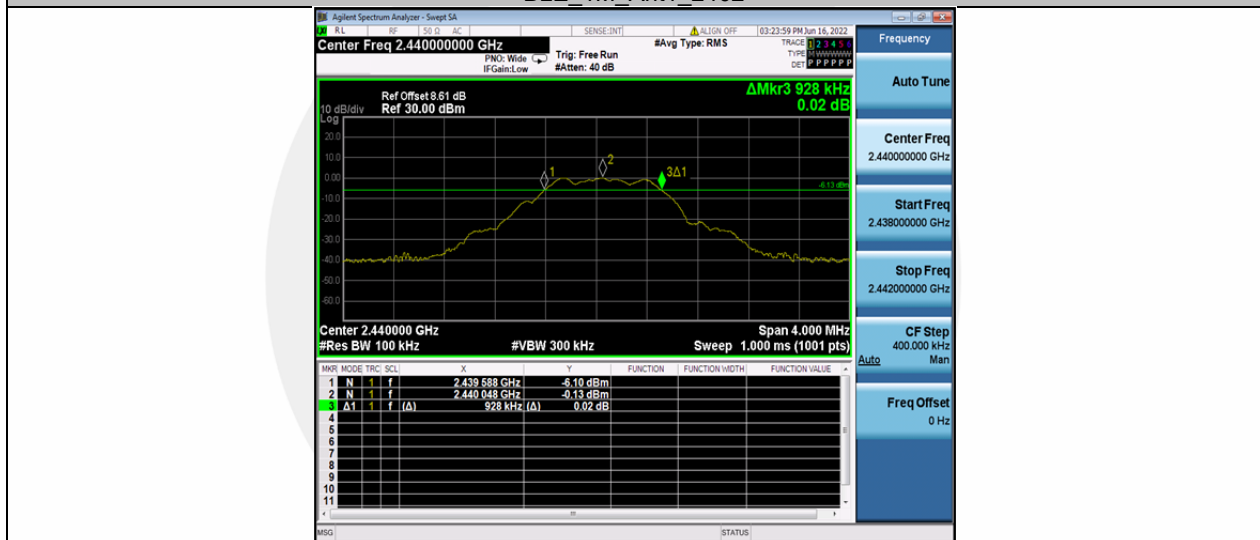

BLE\_1M\_Ant1\_2440

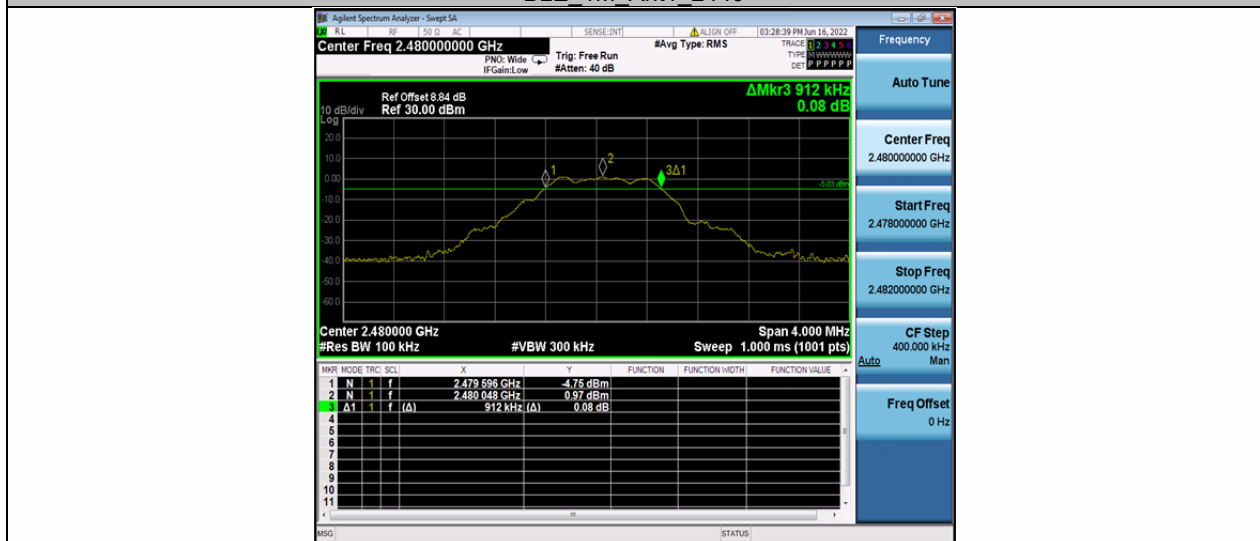

BLE\_1M\_Ant1\_2480

### 8.3 DTS 99% BANDWIDTH

#### 8.3.1 Applicable Standard

According to RSS-Gen 6.7

#### 8.3.2 Test Configuration

Test according to clause 7.1 radio frequency test setup 1

#### 8.3.3 Test Procedure

The EUT was operating in Bluetooth mode and controlled its channel. Printed out the test result from the spectrum by hard copy function.

The RF output of EUT was connected to the spectrum analyzer by RF cable and attenuator. The path loss was compensated to the results for each measurement.

Set to the maximum power setting and enable the EUT transmit continuously

Set RBW = 1%-5% OBW(43KHz).

Set the video bandwidth (VBW) =130 kHz.

Set Span=4MHz

Set Detector = Peak.

Set Trace mode = max hold.

Set Sweep = auto couple.

Allow the trace to stabilize.

Use the 99 % power bandwidth function of the instrument

Measure the maximum width of the emission.

Measure and record the results in the test report.

#### 8.3.4 Test Results

Temperature:	25°C
Relative Humidity:	45%
ATM Pressure:	1011 mbar
Test Engineer:	XXH

Note: N/A

TestMode	Antenna	Frequency[MHz]	OCB [MHz]	FL[MHz]	FH[MHz]	Limit[MHz]	Verdict
BLE_1M	Ant1	2402	1.2069	2401.414	2402.621	---	---
		2440	1.1879	2439.426	2440.614	---	---
		2480	1.1896	2479.428	2480.617	---	---



BLE\_1M\_Ant1\_2402



BLE\_1M\_Ant1\_2440



BLE\_1M\_Ant1\_2480

## 8.4 MAXIMUM PEAK CONDUCTED OUTPUT POWER

### 8.4.1 Applicable Standard

According to FCC Part15.247 (b)(3)

According to RSS-247 5.4(d)

According to RSS-Gen 6.12

According to 558074 D01 15.247 Meas Guidance v05r02 Section 8.3.2.2

According to ANSI C63.10 Section 11.9.2.2.4

### 8.4.2 Conformance Limit

The maximum peak conducted output power of the intentional radiator for systems using digital modulation in the 2400 - 2483.5 MHz bands shall not exceed: 1 Watt (30dBm).

### 8.4.3 Test Configuration

Test according to clause 7.1 radio frequency test setup 1

### 8.4.4 Test Procedure

- a) Measure the duty cycle D of the transmitter output signal.
- b) Set span to at least 1.5 times the OBW.
- c) Set RBW = 1% to 5% of the OBW, not to exceed 1 MHz.
- d) Set VBW  $\geq [3 \times \text{RBW}]$ .
- e) Number of points in sweep  $\geq [2 \times \text{span} / \text{RBW}]$ . (This gives bin-to-bin spacing  $\leq \text{RBW} / 2$ , so that narrowband signals are not lost between frequency bins.)
- f) Sweep time = auto.
- g) Detector = RMS (i.e., power averaging), if available. Otherwise, use the sample detector mode.
- h) Do not use sweep triggering. Allow the sweep to “free run.”
- i) Trace average at least 100 traces in power averaging (rms) mode; however, the number of traces to be averaged shall be increased above 100 as needed such that the average accurately represents the true average over the ON and OFF periods of the transmitter.
- j) Compute power by integrating the spectrum across the OBW of the signal using the instrument’s band power measurement function with band limits set equal to the OBW band edges. If the instrument does not have a band power function, then sum the spectrum levels (in power units) at intervals equal to the RBW extending across the entire OBW of the spectrum.
- k) Add  $[10 \log (1 / D)]$ , where D is the duty cycle, to the measured power to compute the average power during the actual transmission times (because the measurement represents an average over both the ON and OFF times of the transmission). For example, add  $[10 \log (1/0.25)] = 6 \text{ dB}$  if the duty cycle is 25%.

■ According to FCC Part 15.247(b)(4):

Conducted output power limit specified in paragraph (b) of this section is based on the use of antennas with directional gains that do not exceed 6 dBi. If transmitting antennas of directional gain greater than 6 dBi are used, the conducted output power from the intentional radiator shall be reduced below the stated values in paragraphs (b)(3) of this section, as appropriate, by the amount in dB that the directional gain of the antenna exceeds 6 dBi.

Note: If antenna Gain exceeds 6 dBi, then Output power Limit=30-(Gain- 6)

### 8.4.5 Test Results

Temperature:	25 °C
Relative Humidity:	45%
ATM Pressure:	1011 mbar
Test Engineer:	XXH

Note: N/A

TestMode	Antenna	Frequency[MHz]	Conducted Peak Power[dBm]	Conducted Limit[dBm]	EIRP[dBm]	EIRP Limit[dBm]	Verdict
BLE_1M	Ant1	2402	1.79	≤30	-1.31	≤36	PASS
		2440	1.75	≤30	-1.35	≤36	PASS
		2480	2.82	≤30	-0.28	≤36	PASS



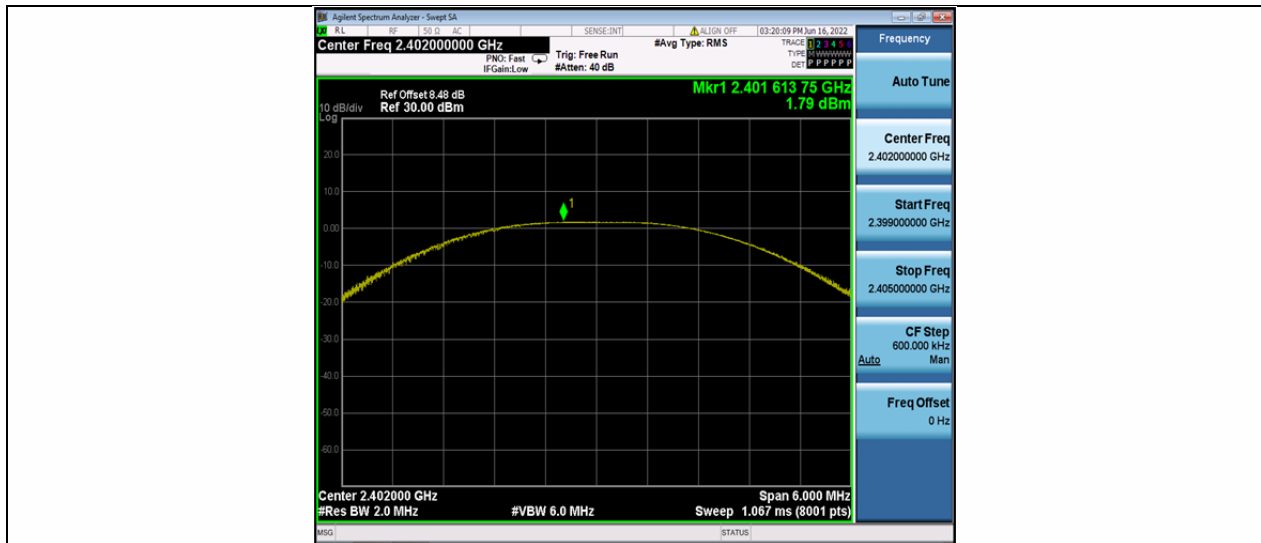

BLE\_1M\_Ant1\_2402

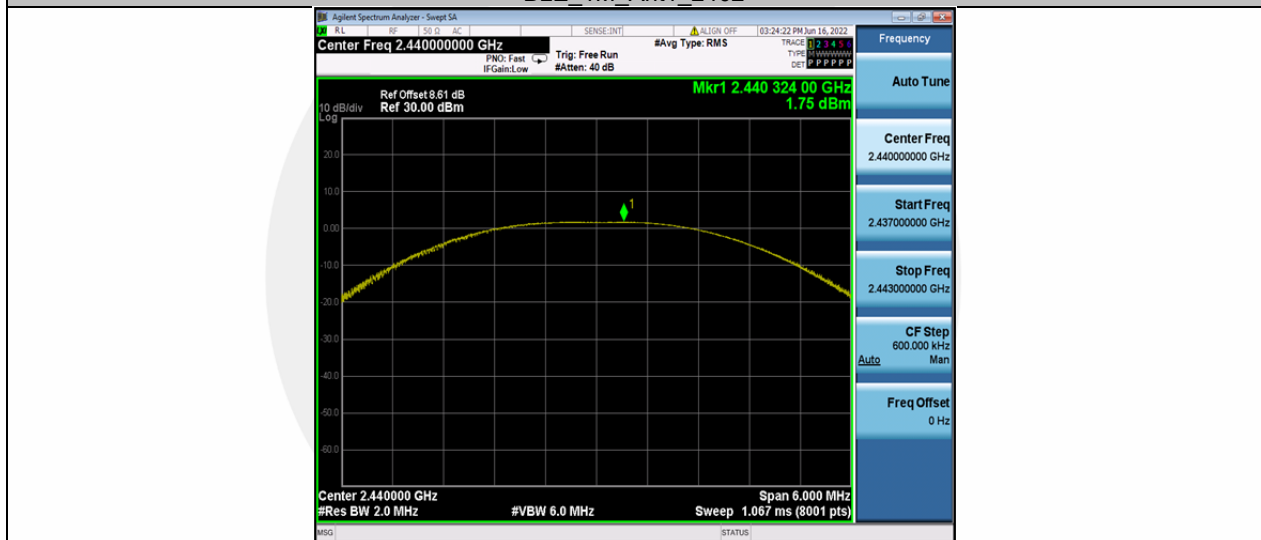

BLE\_1M\_Ant1\_2440

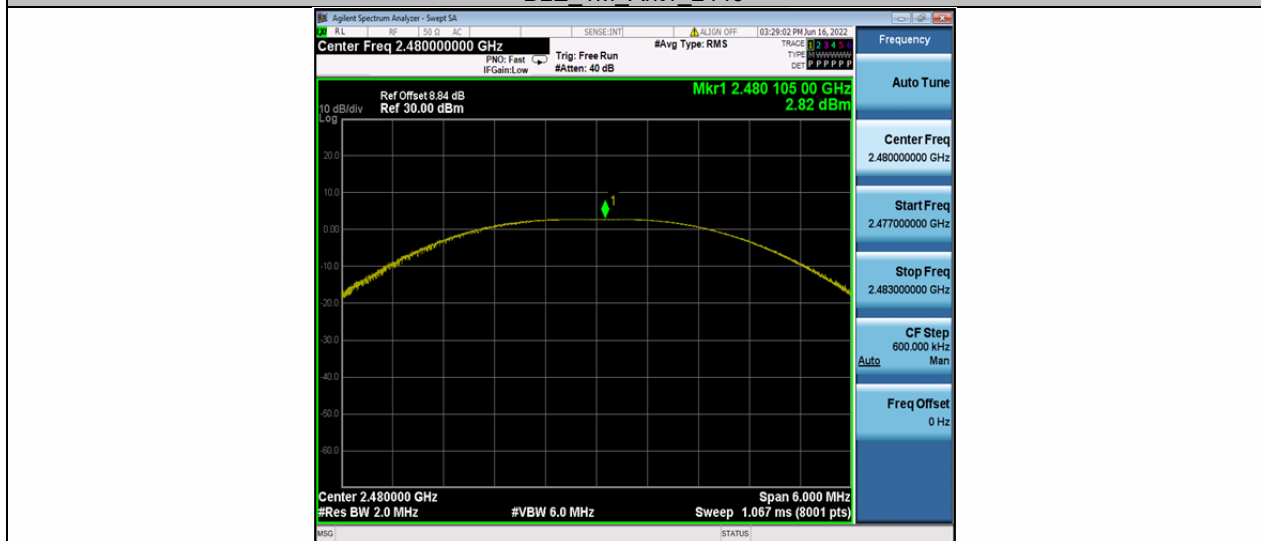

BLE\_1M\_Ant1\_2480



## 8.5 MAXIMUM POWER SPECTRAL DENSITY

### 8.5.1 Applicable Standard

According to FCC Part15.247(e)

According to RSS-247 5.2(b)

According to RSS-Gen 6.12

According to 558074 D01 15.247 Meas Guidance v05r02 Section 8.4

According to ANSI C63.10 Section 11.10.5

### 8.5.2 Conformance Limit

The transmitter power spectral density conducted from the transmitter to the antenna shall not be greater than 8 dBm in any 3 kHz band during any time interval of continuous transmission.

### 8.5.3 Test Configuration

Test according to clause 7.1 radio frequency test setup 1

### 8.5.4 Test Procedure

- a) Measure the duty cycle (D) of the transmitter output signal
- b) Set instrument center frequency to DTS channel center frequency.
- c) Set span to at least 1.5 times the OBW.
- d) Set RBW to:  $3 \text{ kHz} \leq \text{RBW} \leq 100 \text{ kHz}$ .
- e) Set VBW  $\geq [3 \times \text{RBW}]$ .
- f) Detector = power averaging (rms) or sample detector (when rms not available).
- g) Ensure that the number of measurement points in the sweep  $\geq [2 \times \text{span} / \text{RBW}]$ .
- h) Sweep time = auto couple.
- i) Do not use sweep triggering; allow sweep to “free run.”
- j) Employ trace averaging (rms) mode over a minimum of 100 traces.
- k) Use the peak marker function to determine the maximum amplitude level.
- l) Add  $[10 \log (1 / D)]$ , where D is the duty cycle measured in step a), to the measured PSD to compute the average PSD during the actual transmission time.
- m) If measured value exceeds requirement specified by regulatory agency, then reduce RBW (but no less than 3 kHz) and repeat (note that this may require zooming in on the emission of interest and reducing the span to meet the minimum measurement point requirement as the RBW is reduced).

### 8.5.5 Test Results

Temperature:	25 °C
Relative Humidity:	45%
ATM Pressure:	1011 mbar
Test Engineer:	XXH

Note: N/A

TestMode	Antenna	Frequency[MHz]	Result[dBm/3kHz]	Limit[dBm/3kHz]	Verdict
BLE_1M	Ant1	2402	-13.23	$\leq 8.00$	PASS
		2440	-13.16	$\leq 8.00$	PASS
		2480	-12.24	$\leq 8.00$	PASS

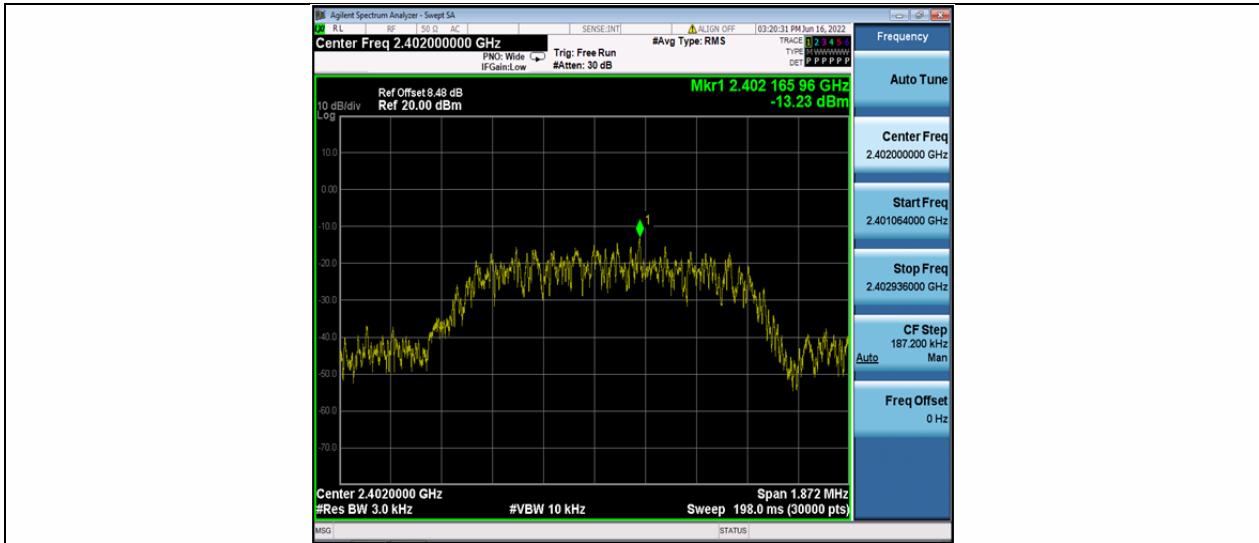

BLE\_1M\_Ant1\_2402

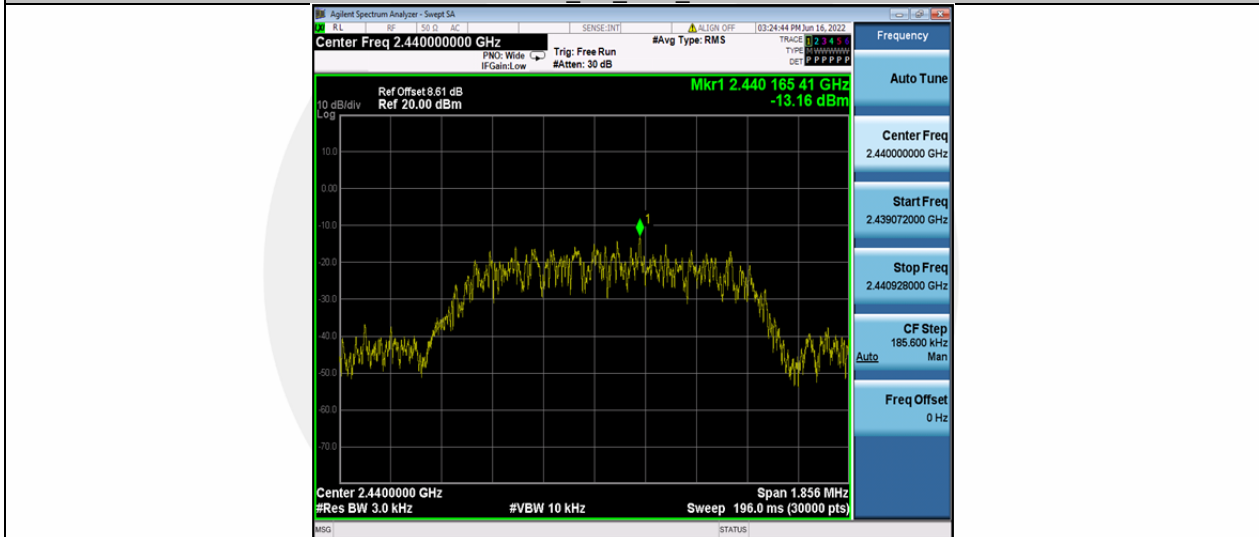

BLE\_1M\_Ant1\_2440

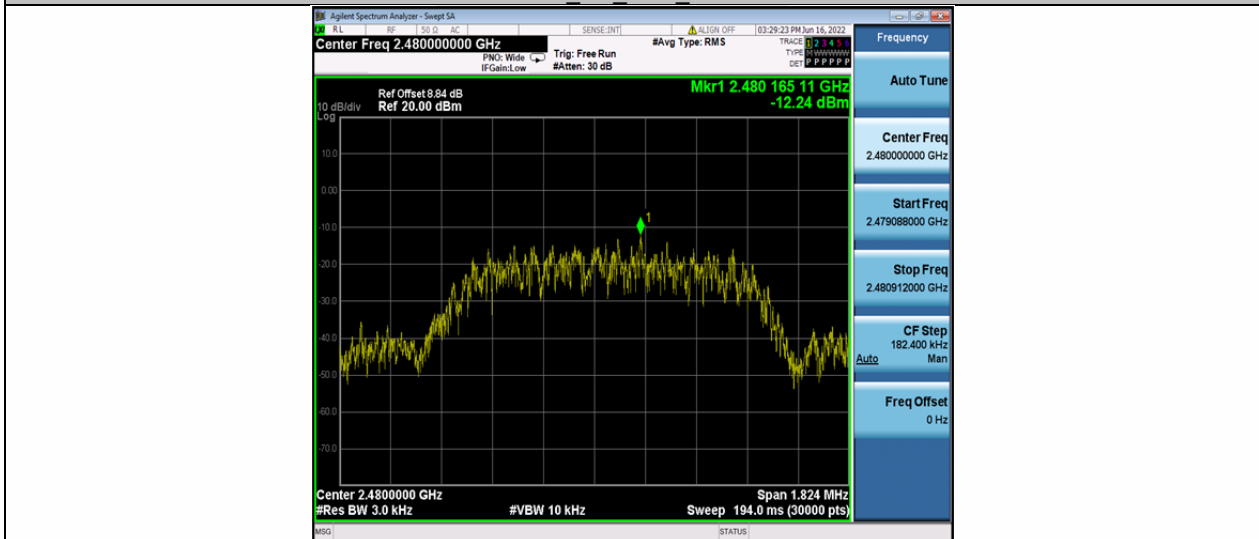

BLE\_1M\_Ant1\_2480

## 8.6 UNWANTED EMISSIONS IN NON-RESTRICTED FREQUENCY BANDS

### 8.6.1 Applicable Standard

According to FCC Part15.247(d)

According to RSS-247 5.5

According to 558074 D01 15.247 Meas Guidance v05r02 Section 8.5

According to ANSI C63.10 Section 11.11

### 8.6.2 Conformance Limit

In any 100 kHz bandwidth outside the frequency band in which the spread spectrum or digitally modulated intentional radiator is operating, the radio frequency power that is produced by the intentional radiator shall be at least 20 dB below that in the 100 kHz bandwidth within the band that contains the highest level of the desired power, based on either an RF conducted or a radiated measurement, provided the transmitter demonstrates compliance with the peak conducted power limits. If the transmitter complies with the conducted power limits based on the use of RMS averaging over a time interval, as permitted under paragraph (b)(3) of this section, the attenuation required under this paragraph shall be 30 dB instead of 20 dB.

### 8.6.3 Test Configuration

Test according to clause 7.1 radio frequency test setup 1

### 8.6.4 Test Procedure

The transmitter output (antenna port) was connected to the spectrum analyzer

#### ■ Reference level measurement

Establish a reference level by using the following procedure:

Set instrument center frequency to DTS channel center frequency.

Set the span to = 1.5 times the DTS bandwidth.

Set the RBW = 100 kHz.

Set the VBW  $\geq 3 \times$  RBW.

Set Detector = peak.

Set Sweep time = auto couple.

Set Trace mode = max hold.

Allow trace to fully stabilize.

Use the peak marker function to determine the maximum PSD level.

Note that the channel found to contain the maximum PSD level can be used to establish the reference level.

#### ■ Band-edge measurement

Use the following spectrum analyzer settings:

Span = wide enough to capture the peak level of the emission operating on the channel closest to the band-edge, as well as any modulation products which fall outside of the authorized band of operation

Set RBW  $\geq 1\%$  of the span=100kHz Set VBW  $\geq 3 \times$  RBW

Set Sweep = auto Set Detector function = peak Set Trace = max hold

Allow the trace to stabilize. Set the marker on the emission at the bandedge, or on the highest modulation product outside of the band, if this level is greater than that at the bandedge. Enable the marker-delta function, then use the marker-to-peak function to move the marker to the peak of the in-band emission. The marker-delta value now displayed must comply with the limit specified in this Section.

#### ■ Emission level measurement

Set the center frequency and span to encompass frequency range to be measured.

Set the RBW = 100 kHz.

Set the VBW =300 kHz.

Set Detector = peak

Sweep time = auto couple.

Trace mode = max hold.

Allow trace to fully stabilize.

Use the peak marker function to determine the maximum amplitude level.

Ensure that the amplitude of all unwanted emissions outside of the authorized frequency band (excluding restricted frequency bands) are attenuated by at least the minimum requirements. Report the three highest emissions relative to the limit.

### 8.6.5 Test Results

Temperature:	25 °C
Relative Humidity:	45%
ATM Pressure:	1011 mbar
Test Engineer:	XXH

Note: N/A

#### Band edge measurements

TestMode	Antenna	ChName	Frequency [MHz]	RefLevel[dBm]	Result[dBm]	Limit[dBm]	Verdict
BLE_1M	Ant1	Low	2402	0.24	-40.34	≤-19.76	PASS
		High	2480	1.17	-43.88	≤-18.84	PASS

#### Conducted Spurious Emission

TestMode	Antenna	Frequency [MHz]	FreqRange [MHz]	RefLevel [dBm]	Result[dBm]	Limit[dBm]	Verdict
BLE_1M	Ant1	2402	Reference	-0.08	-0.08	---	PASS
			30~1000	-0.08	-56.26	≤-20.08	PASS
			1000~26500	-0.08	-40.77	≤-20.08	PASS
		2440	Reference	-0.10	-0.10	---	PASS
			30~1000	-0.10	-49.93	≤-20.1	PASS
			1000~26500	-0.10	-40.01	≤-20.1	PASS
		2480	Reference	0.98	0.98	---	PASS
			30~1000	0.98	-55.43	≤-19.02	PASS
			1000~26500	0.98	-40.39	≤-19.02	PASS

### Band edge measurements

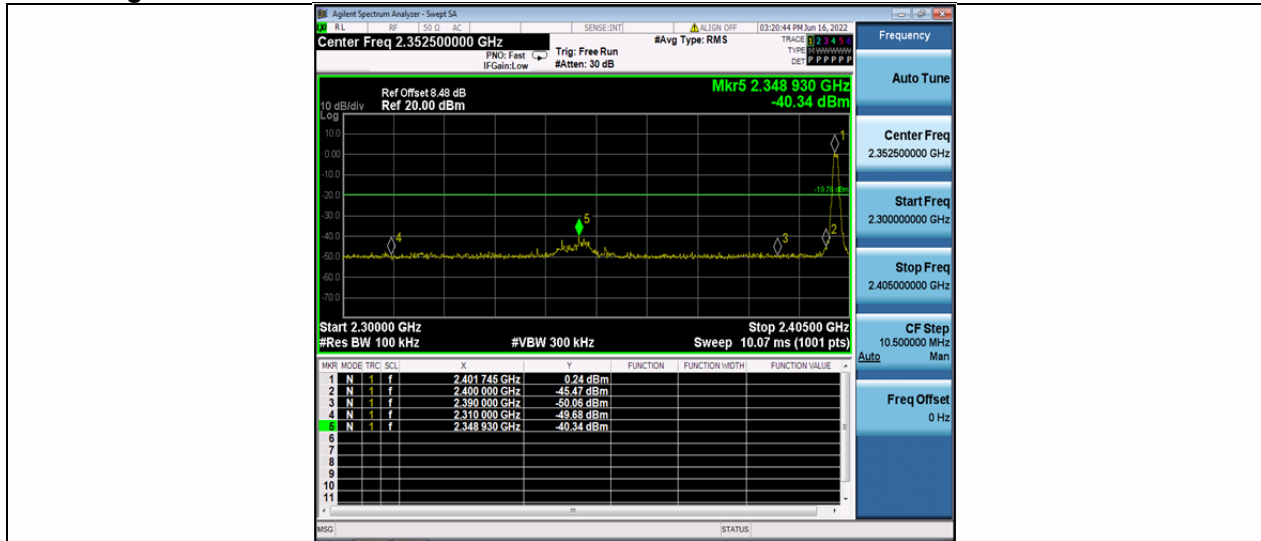

BLE 1M Ant1 Low 2402

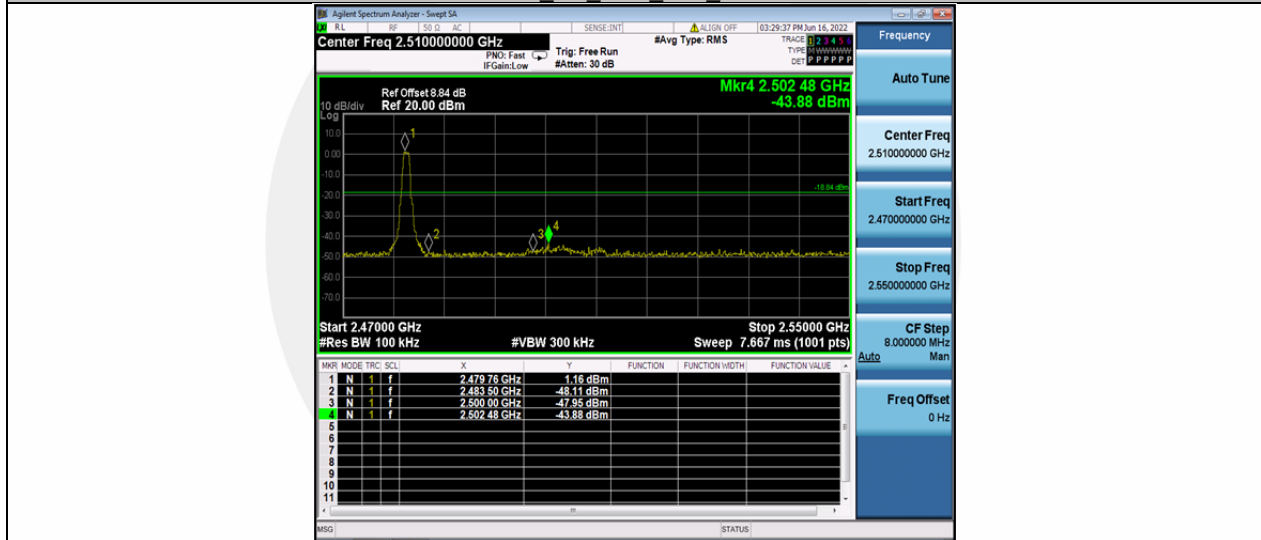

BLE 1M Ant1 High 2480

### Conducted Spurious Emission

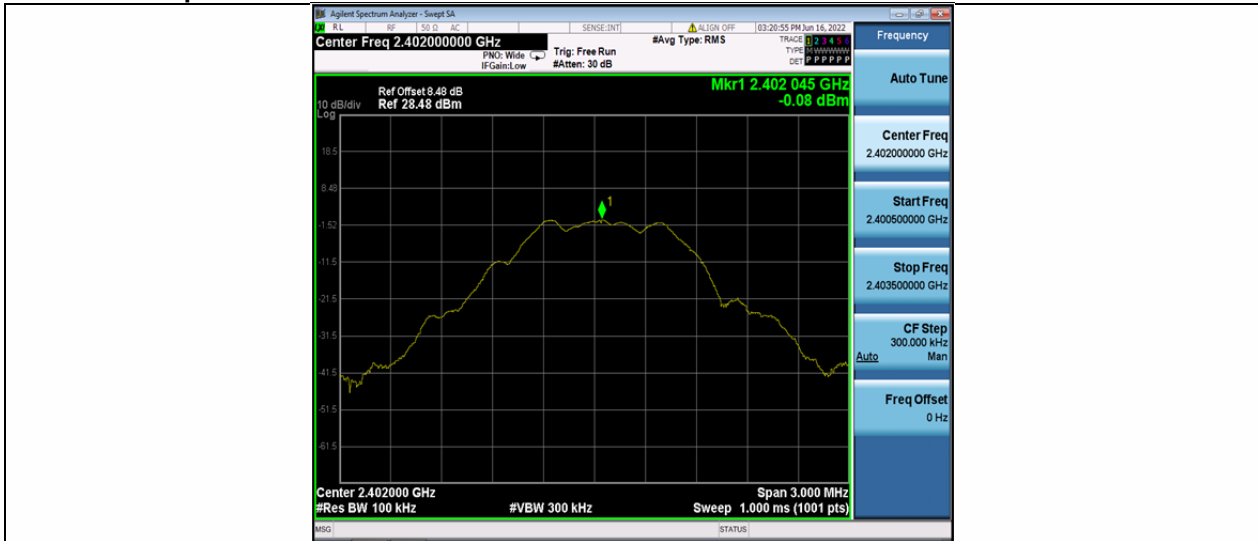

BLE 1M Ant1 2402 0~Reference

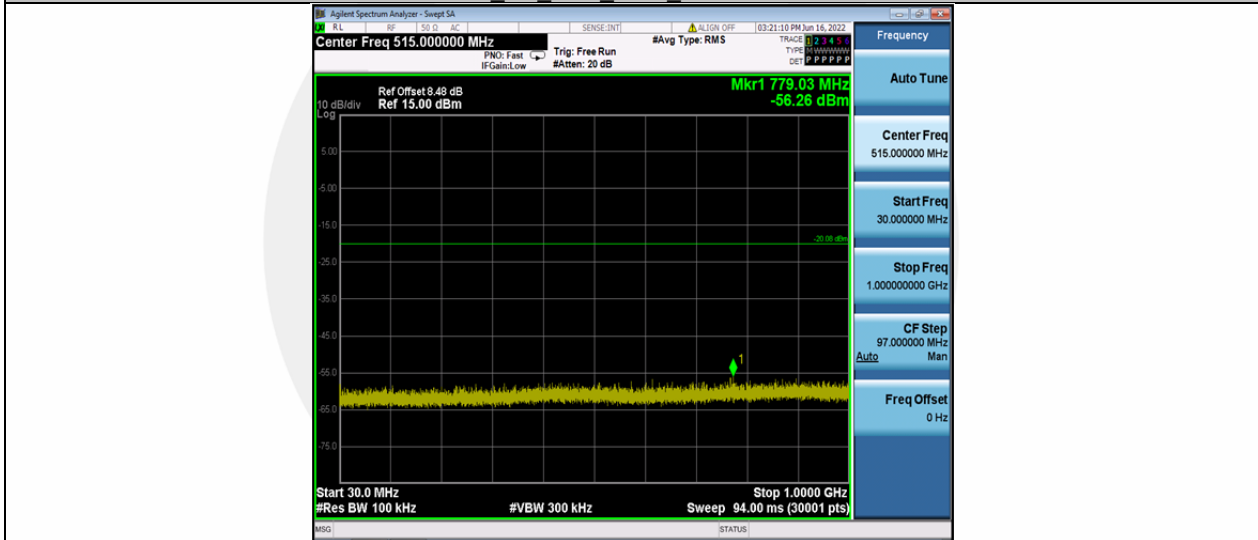

BLE 1M Ant1 2402 30~1000

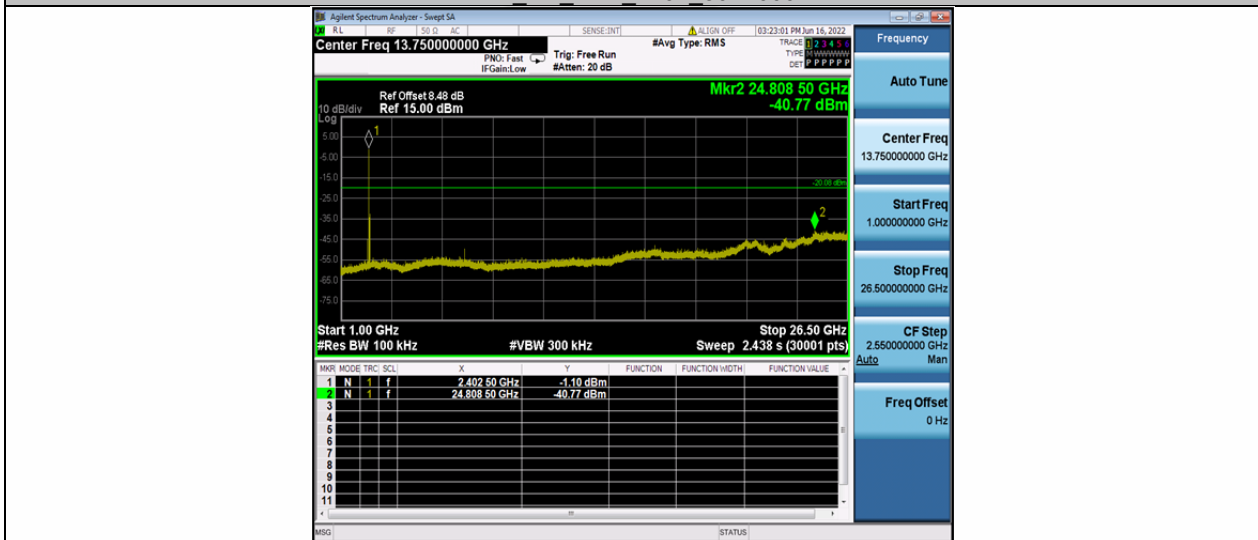

BLE 1M Ant1 2402 1000~26500



BLE\_1M\_Ant1\_2440\_0~Reference

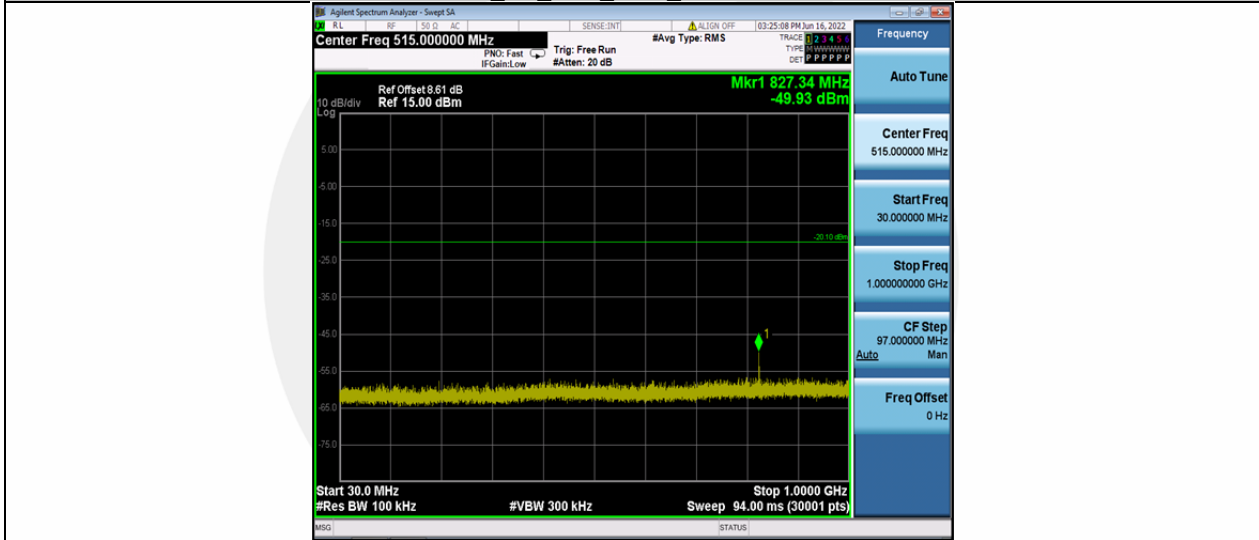

BLE\_1M\_Ant1\_2440\_30~1000

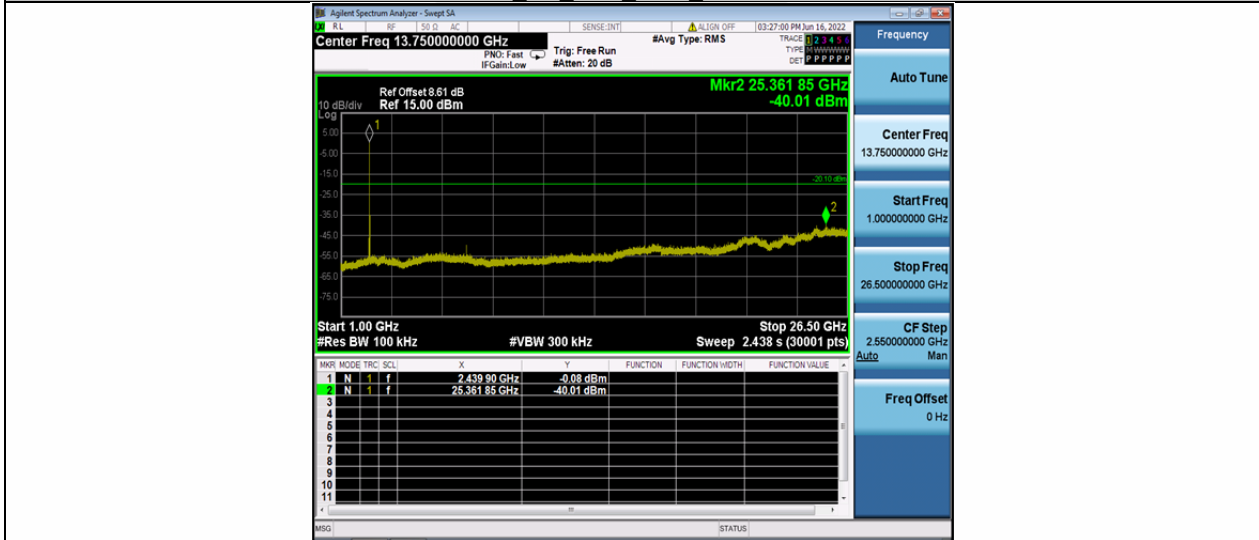

BLE\_1M\_Ant1\_2440\_1000~26500



BLE\_1M\_Ant1\_2480\_0~Reference

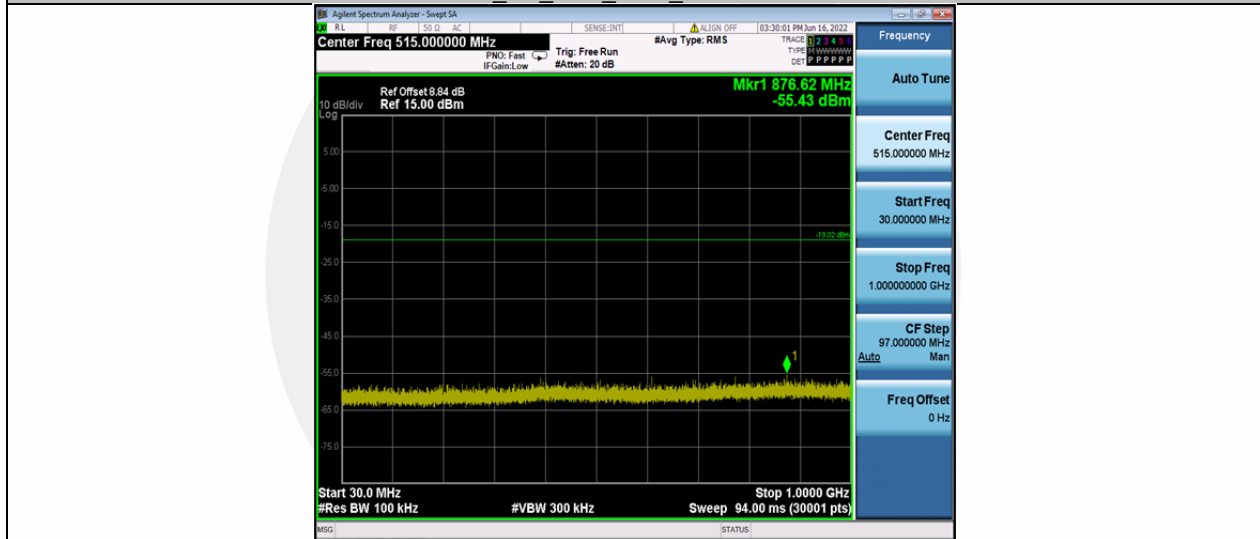

BLE\_1M\_Ant1\_2480\_30~1000

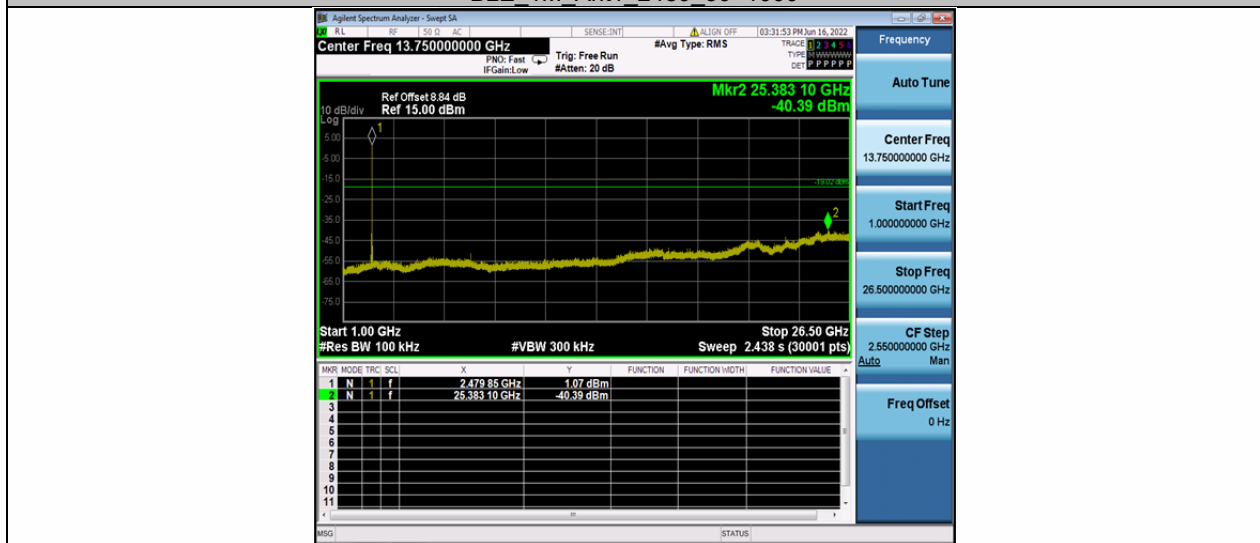

BLE\_1M\_Ant1\_2480\_1000~26500



## 8.7 RADIATED SPURIOUS EMISSION

### 8.7.1 Applicable Standard

According to FCC Part 15.247(d), 15.205, 15.209

According to RSS-Gen and RSS-247

According to 558074 D01 15.247 Meas Guidance v05r02 Section 8.6

According to ANSI C63.10 Section 11.12

### 8.7.2 Conformance Limit

According to FCC Part 15.247(d): radiated emissions which fall in the restricted bands, as defined in §15.205(a), must also comply with the radiated emission limits specified in §15.209(a) (see §15.205(c)).

According to FCC Part 15.205, Restricted bands

MHz	MHz	MHz	GHz
0.090-0.110	16.42-16.423	399.9-410	4.5-5.15
0.495-0.505	16.69475-16.69525	608-614	5.35-5.46
2.1735-2.1905	16.80425-16.80475	960-1240	7.25-7.75
4.125-4.128	25.5-25.67	1300-1427	8.025-8.5
4.17725-4.17775	37.5-38.25	1435-1626.5	9.0-9.2
4.20725-4.20775	73-74.6	1645.5-1646.5	9.3-9.5
6.215-6.218	74.8-75.2	1660-1710	10.6-12.7
6.26775-6.26825	123-138	2200-2300	14.47-14.5
8.291-8.294	149.9-150.05	2310-2390	15.35-16.2
8.362-8.366	156.52475-156.52525	2483.5-2500	17.7-21.4
8.37625-8.38675	156.7-156.9	2690-2900	22.01-23.12
8.41425-8.41475	162.0125-167.17	3260-3267	23.6-24.0
12.29-12.293	167.72-173.2	3332-3339	31.2-31.8
12.51975-12.52025	240-285	3345.8-3358	36.43-36.5
12.57675-12.57725	322-335.4	3600-4400	Above 38.6
13.36-13.41			

According to FCC Part 15.205, the level of any transmitter spurious emission in Restricted bands shall not exceed the level of the emission specified in the following table

Restricted Frequency(MHz)	Field Strength ( $\mu\text{V}/\text{m}$ )	Field Strength ( $\text{dB}\mu\text{V}/\text{m}$ )	Measurement Distance
0.009-0.490	2400/F(KHz)	20 log ( $\mu\text{V}/\text{m}$ )	300
0.490-1.705	24000/F(KHz)	20 log ( $\mu\text{V}/\text{m}$ )	30
1.705-30	30	29.5	30
30-88	100	40	3
88-216	150	43.5	3
216-960	200	46	3
Above 960	500	54	3

### 8.7.3 Test Configuration

Test according to clause 7.2 radio frequency test setup 2

### 8.7.4 Test Procedure

This test is required for any spurious emission that falls in a Restricted Band, as defined in Section 15.205. It must be performed with the highest gain of each type of antenna proposed for use with the EUT. Use the following spectrum analyzer settings:

For Above 1GHz:

The EUT was placed on a turn table which is 1.5m above ground plane.

Maximum procedure was performed on the highest emissions to ensure EUT compliance.

Span = wide enough to fully capture the emission being measured

RBW = 1 MHz

VBW  $\geq$  RBW

Sweep = auto

Detector function = peak

Trace = max hold

For average measurements the resolution bandwidth of spectrum analyzer is 1 MHz with the video bandwidth is  $\geq 1/T$  with peak detector.

For Below 1GHz:

The EUT was placed on a turn table which is 0.8m above ground plane.

Maximum procedure was performed on the highest emissions to ensure EUT compliance.

Span = wide enough to fully capture the emission being measured

RBW = 100 kHz for

VBW  $\geq$  RBW

Sweep = auto

Detector function = peak

Trace = max hold

For Below 30MHz:

The EUT was placed on a turn table which is 0.8m above ground plane.

Maximum procedure was performed on the highest emissions to ensure EUT compliance.

Span = wide enough to fully capture the emission being measured

RBW = 9kHz

VBW  $\geq$  RBW

Sweep = auto

Detector function = peak

Trace = max hold

For Below 150KHz:

The EUT was placed on a turn table which is 0.8m above ground plane.

Maximum procedure was performed on the highest emissions to ensure EUT compliance.

Span = wide enough to fully capture the emission being measured

RBW = 200Hz

VBW  $\geq$  RBW

Sweep = auto

Detector function = peak

Trace = max hold

Follow the guidelines in ANSI C63.10 with respect to maximizing the emission by rotating the EUT, measuring the emission while the EUT is situated in three orthogonal planes (if appropriate), adjusting the measurement antenna height and polarization, etc. A pre-amp and a high pass filter are required for this test, in order to provide the measuring system with sufficient sensitivity. Allow the trace to stabilize. The peak reading of the emission, after being corrected by the antenna factor, cable loss, pre-amp gain, etc., is the peak field strength, which must comply with the limit. Submit this data.

### 8.7.5 Test Results

Temperature:	25 °C
Relative Humidity:	54%
ATM Pressure:	1011 mbar
Test Engineer:	XXH

#### ■ Spurious Emission below 30MHz (9KHz to 30MHz)

For Spurious Emission below 30MHz (9KHz to 30MHz), was pre-scanned and the result which was 20dB lower than the limit line per 15.31(o) was not reported.

■ Spurious Emission Above 1GHz (1GHz to 25GHz)

Bluetooth (BLE\_1M) mode have been tested, and the worst result was report as below:

Test mode: BLE\_1M Frequency: Channel 0: 2402MHz

Freq. (MHz)	Ant.Pol.	Reading Level (dBuV/m)	Correct Factor (dB/m)	Corrected Reading (dBuV/m)	Limit 3m (dBuV/m)	Margin (dB)	Remark
6564.209	V	51.09	-3.56	47.53	74.00	-26.47	Peak
6564.209	V	33.71	-3.56	30.15	54.00	-23.85	Avg
11769.21	V	52.66	3.81	56.47	74.00	-17.53	Peak
11769.21	V	34.46	3.81	38.27	54.00	-15.73	Avg
18000.00	V	50.97	15.66	66.63	74.00	-7.37	Peak
18000	V	32.67	15.66	48.33	54.00	-5.67	Avg
6036.421	H	51.34	-5.57	45.77	74.00	-28.23	Avg
6036.421	H	34.20	-5.57	28.63	54.00	-25.37	Peak
11633.92	H	53.16	3.57	56.73	74.00	-17.27	Avg
11633.92	H	34.95	3.57	38.52	54.00	-15.48	Peak
18000.00	H	50.57	15.66	66.23	74.00	-7.77	Avg
18000	H	33.05	15.66	48.71	54.00	-5.29	Peak

Note: (1) PeaK RBW = 1 MHz, VBW ≥ 3 × RBW, Detector = Peak;  
 (2) Avg RBW = 1 MHz, VBW = 1/T<sub>on</sub>, Detector = Peak, where: T<sub>on</sub> is transmit duration;  
 (3) Corrected Reading = Reading Level + Correct Factor;  
 (4) Correct Factor = Ant\_F + Cab\_L - Preamp;  
 (5) Margin = Limit - Corrected Reading;

Test mode: BLE\_1M Frequency: Channel 19: 2440MHz

Freq. (MHz)	Ant.Pol.	Reading Level (dBuV/m)	Correct Factor (dB/m)	Corrected Reading (dBuV/m)	Limit 3m (dBuV/m)	Margin (dB)	Remark
6395.654	V	50.91	-4.16	46.75	74.00	-27.25	Peak
6395.654	V	32.40	-4.16	28.24	54.00	-25.76	Avg
11600.35	V	52.80	3.50	56.30	74.00	-17.70	Peak
11600.35	V	34.65	3.50	38.15	54.00	-15.85	Avg
18000.00	V	50.00	15.66	65.66	74.00	-8.34	Peak
18000	V	32.65	15.66	48.31	54.00	-5.69	Avg
5664.525	H	52.15	-6.29	45.86	74.00	-28.14	Peak
5664.525	H	34.61	-6.29	28.32	54.00	-25.68	Avg
10885.66	H	53.02	3.33	56.35	74.00	-17.65	Peak
10885.66	H	34.99	3.33	38.32	54.00	-15.68	Avg
18000.00	H	50.98	15.66	66.64	74.00	-7.36	Peak
18000	H	32.56	15.66	48.22	54.00	-5.78	Avg

Note: (1) Peak RBW = 1 MHz, VBW  $\geq 3 \times$  RBW, Detector = Peak;  
 (2) Avg RBW = 1 MHz, VBW =  $1/T_{on}$ , Detector = Peak, where:  $T_{on}$  is transmit duration;  
 (3) Corrected Reading = Reading Level + Correct Factor;  
 (4) Correct Factor = Ant\_F + Cab\_L - Preamp;  
 (5) Margin = Limit - Corrected Reading;

Test mode: BLE\_1M Frequency: Channel 39: 2480MHz

Freq. (MHz)	Ant.Pol.	Reading Level (dBUV/m)	Correct Factor (dB/m)	Corrected Reading (dBUV/m)	Limit 3m (dBUV/m)	Margin (dB)	Remark
6377.195	V	51.88	-4.22	47.66	74.00	-26.34	Peak
6377.195	V	34.99	-4.22	30.77	54.00	-23.23	Avg
11633.92	V	53.20	3.57	56.77	74.00	-17.23	Peak
11633.92	V	34.69	3.57	38.26	54.00	-15.74	Avg
18000.00	V	49.91	15.66	65.57	74.00	-8.43	Peak
18000	V	32.78	15.66	48.44	54.00	-5.56	Avg
5830.640	H	51.38	-6.01	45.37	74.00	-28.63	Peak
5830.640	H	34.46	-6.01	28.45	54.00	-25.55	Avg
11500.19	H	53.03	3.32	56.35	74.00	-17.65	Peak
11500.19	H	34.99	3.32	38.31	54.00	-15.69	Avg
18000.00	H	50.04	15.66	65.70	74.00	-8.30	Peak
18000	H	32.56	15.66	48.22	54.00	-5.78	Avg

Note: (1) Peak RBW = 1 MHz, VBW  $\geq 3 \times$  RBW, Detector = Peak;  
 (2) Avg RBW = 1 MHz, VBW =  $1/T_{on}$ , Detector = Peak, where:  $T_{on}$  is transmit duration;  
 (3) Corrected Reading = Reading Level + Correct Factor;  
 (4) Correct Factor = Ant\_F + Cab\_L - Preamp;  
 (5) Margin = Limit - Corrected Reading;

■ Spurious Emission in Restricted Band 2310-2390MHz and 2483.5-2500MHz Bluetooth (BLE\_1M) mode have been tested, and the worst result was report as below:

Test mode: BLE\_1M Frequency: Channel 0: 2402MHz

Freq. (MHz)	Ant.Pol.	Reading Level (dBuV/m)	Correct Factor (dB/m)	Corrected Reading (dBuV/m)	Limit 3m (dBuV/m)	Margin (dB)	Remark
2387.920	V	41.22	5.30	46.52	74.00	-27.48	Peak
2387.92	V	23.33	5.30	28.63	54.00	-25.37	Avg
2387.040	H	40.98	5.30	46.28	74.00	-27.72	Peak
2387.04	H	22.94	5.30	28.24	54.00	-25.76	Avg
Note: (1) Peak RBW = 1 MHz, VBW $\geq 3 \times$ RBW, Detector = Peak; (2) Avg RBW = 1 MHz, VBW = $1/T_{on}$ , Detector = Peak, where: $T_{on}$ is transmit duration; (3) Corrected Reading = Reading Level + Correct Factor; (4) Correct Factor = Ant_F + Cab_L - Preamp; (5) Margin = Limit - Corrected Reading;							

Test mode: BLE\_1M Frequency: Channel 39: 2480MHz

Freq. (MHz)	Ant.Pol.	Reading Level (dBuV/m)	Correct Factor (dB/m)	Corrected Reading (dBuV/m)	Limit 3m (dBuV/m)	Margin (dB)	Remark
2483.797	V	41.03	5.53	46.56	74.00	-27.44	Peak
2483.797	V	23.11	5.53	28.64	54.00	-25.36	Avg
2484.242	H	41.29	5.53	46.82	74.00	-27.18	Peak
2484.242	H	23.24	5.53	28.77	54.00	-25.23	Avg
Note: (1) Peak RBW = 1 MHz, VBW $\geq 3 \times$ RBW, Detector = Peak; (2) Avg RBW = 1 MHz, VBW = $1/T_{on}$ , Detector = Peak, where: $T_{on}$ is transmit duration; (3) Corrected Reading = Reading Level + Correct Factor; (4) Correct Factor = Ant_F + Cab_L - Preamp; (5) Margin = Limit - Corrected Reading;							

Test Model Spurious Emission in Restricted Band 2310-2390MHz  
 Channel 0: 2402MHz BLE\_1M H

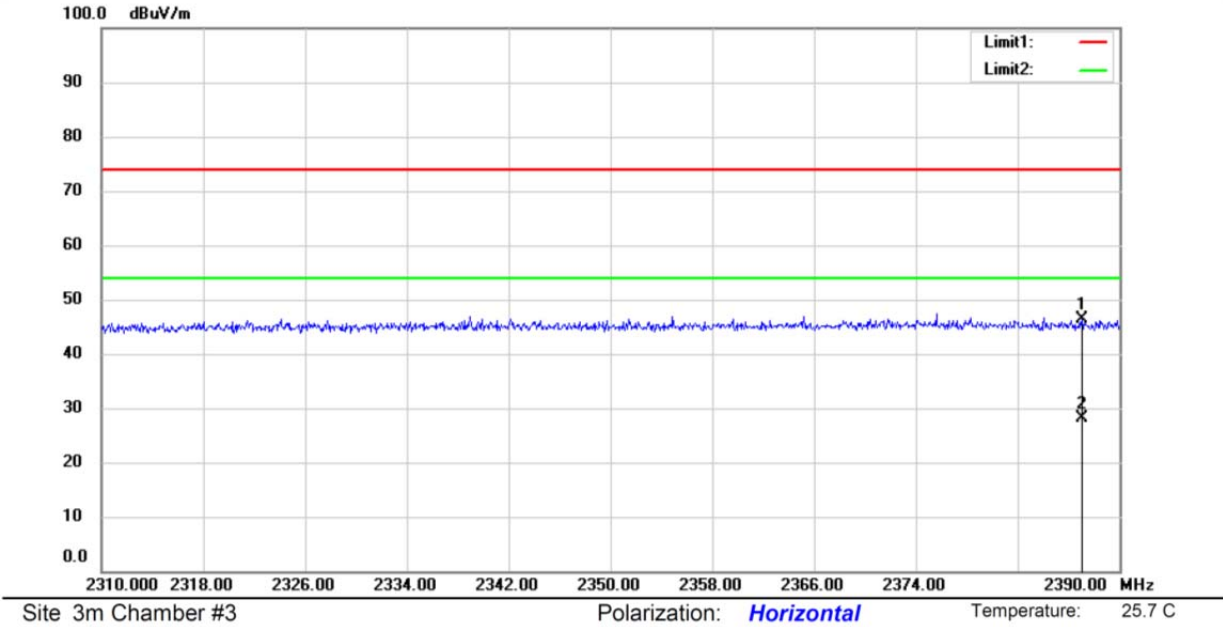

Test Model Spurious Emission in Restricted Band 2310-2390MHz  
 Channel 0: 2402MHz BLE\_1M V

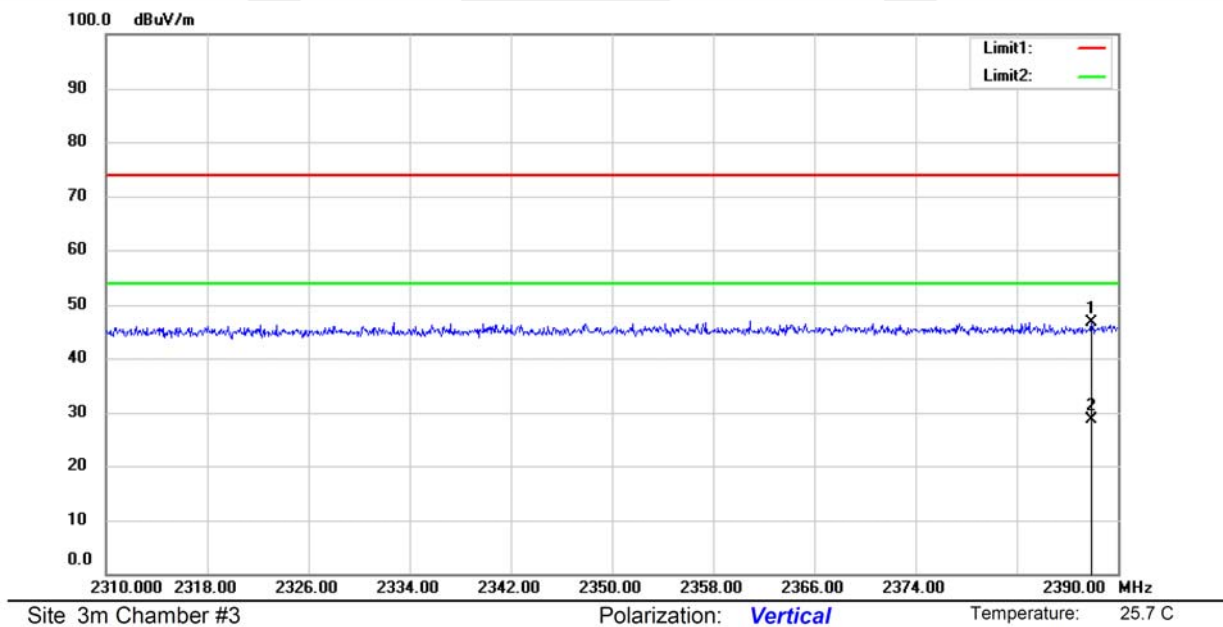

Test Model Spurious Emission in Restricted Band 2483.5-2500MHz  
 Channel 39: 2480MHz BLE\_1M H

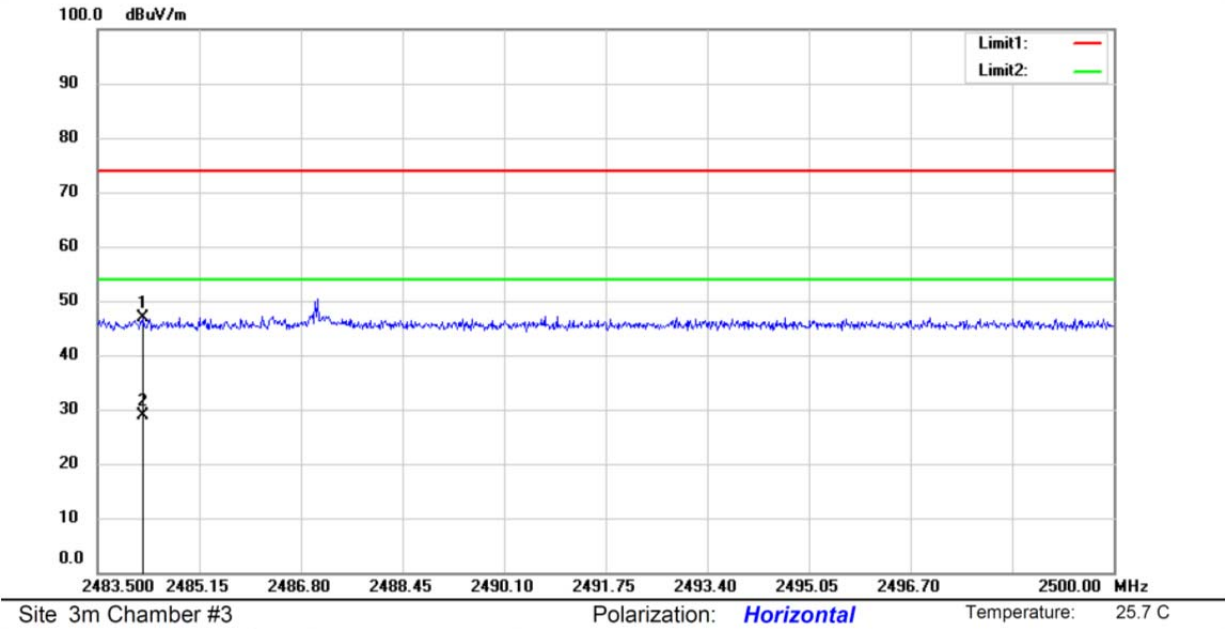

Test Model Spurious Emission in Restricted Band 2483.5-2500MHz  
 Channel 39: 2480MHz BLE\_1M V

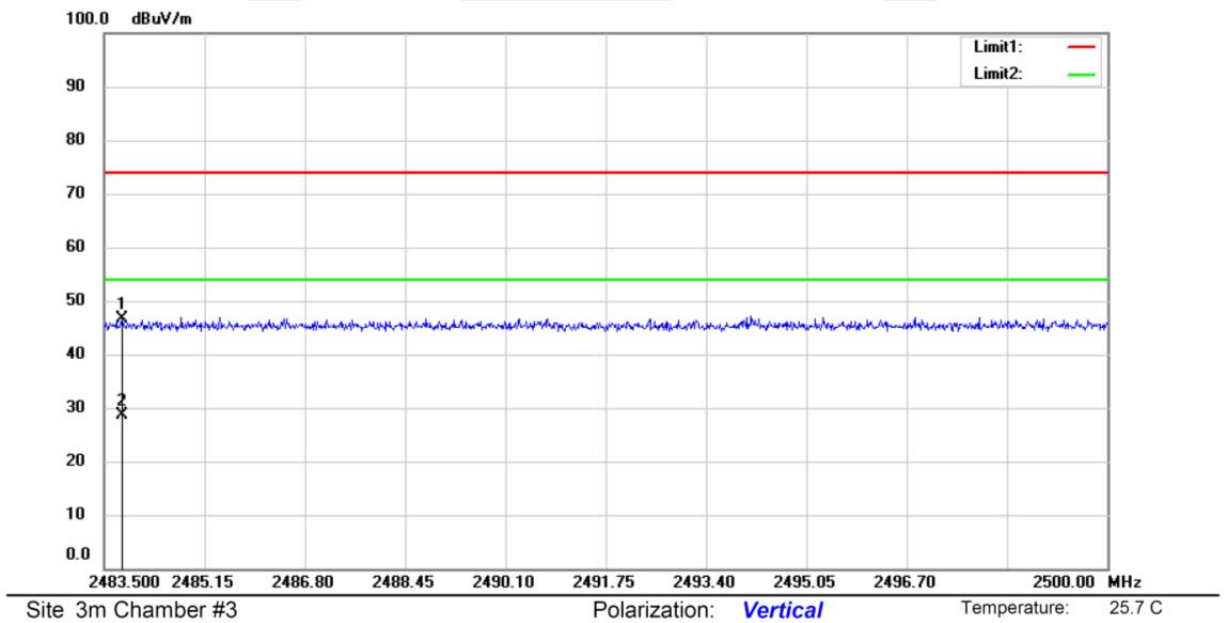



■ Spurious Emission below 1GHz (30MHz to 1GHz)

Bluetooth (BLE\_1M) mode have been tested, and the worst result was report as below:

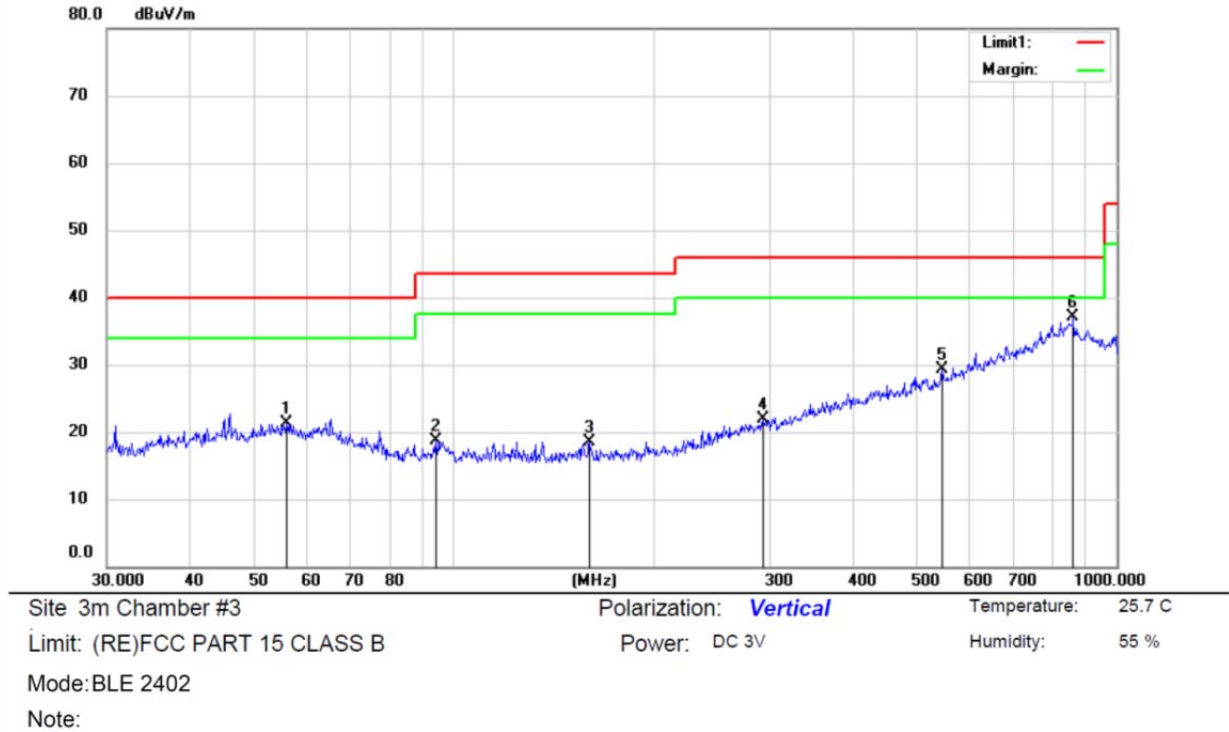

No.	Mk.	Freq.	Reading Level	Correct Factor	Measurement	Limit	Over	Antenna Height	Table Degree
		MHz	dBuV	dB	dBuV/m	dBuV/m	dB	cm	degree
1		56.0007	29.80	-8.59	21.21	40.00	-18.79	QP	
2		94.0980	30.30	-11.67	18.63	43.50	-24.87	QP	
3		160.3456	29.87	-11.35	18.52	43.50	-24.98	QP	
4		293.0842	29.21	-7.31	21.90	46.00	-24.10	QP	
5		545.1826	29.93	-0.66	29.27	46.00	-16.73	QP	
6	*	860.0352	30.25	6.90	37.15	46.00	-8.85	QP	

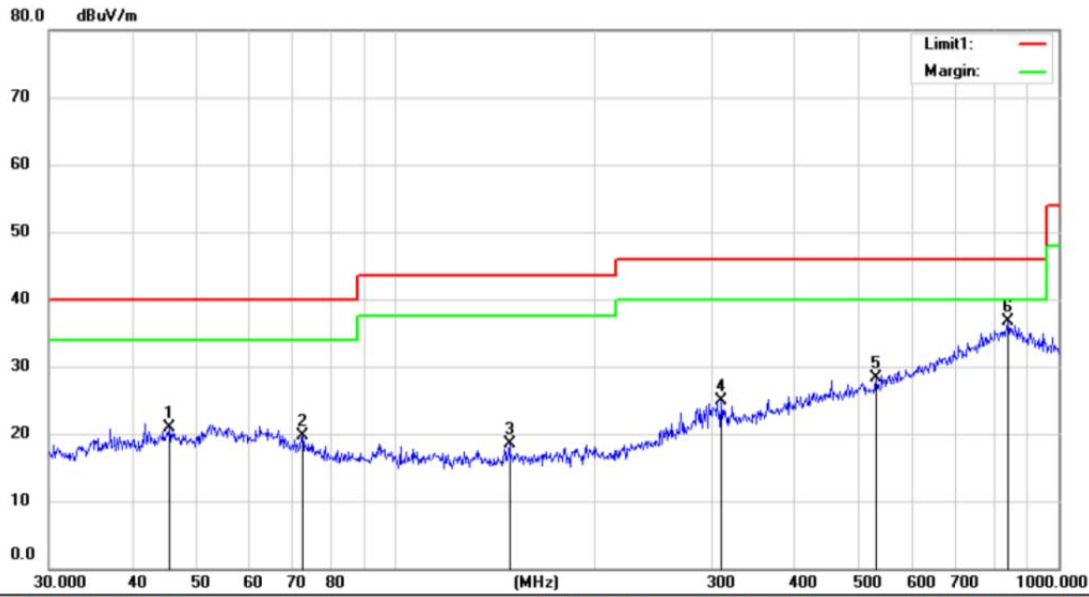

Site 3m Chamber #3 Polarization: **Horizontal** Temperature: 25.7 C  
 Limit: (RE)FCC PART 15 CLASS B Power: DC 3V Humidity: 55 %  
 Mode: BLE 2402  
 Note:

No.	Mk.	Freq.	Reading Level	Correct Factor	Measurement	Limit	Over	Antenna Height	Table Degree	
		MHz	dBuV	dB	dBuV/m	dBuV/m	dB	cm	degree	Comment
1		45.5348	30.02	-9.16	20.86	40.00	-19.14	QP		
2		72.3376	30.03	-10.35	19.68	40.00	-20.32	QP		
3		148.4410	29.80	-11.30	18.50	43.50	-25.00	QP		
4		309.9977	32.08	-7.15	24.93	46.00	-21.07	QP		
5		530.1014	29.52	-1.22	28.30	46.00	-17.70	QP		
6	*	839.1818	29.05	7.61	36.66	46.00	-9.34	QP		

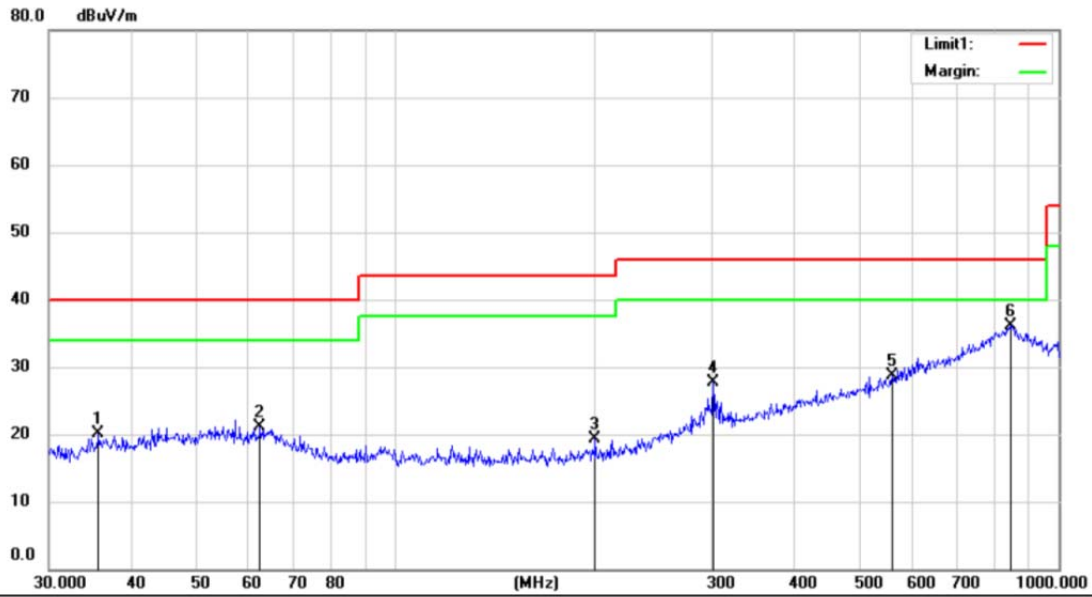

Site 3m Chamber #3 Polarization: **Horizontal** Temperature: 25.7 C  
 Limit: (RE)FCC PART 15 CLASS B Power: DC 3V Humidity: 55 %  
 Mode: BLE 2440  
 Note:

No.	Mk.	Freq.	Reading Level	Correct Factor	Measurement	Limit	Over	Antenna Height	Table Degree	
		MHz	dBuV	dB	dBuV/m	dBuV/m	dB	cm	degree	Comment
1		35.6240	30.33	-10.23	20.10	40.00	-19.90	QP		
2		62.4314	29.77	-8.68	21.09	40.00	-18.91	QP		
3		199.9856	30.54	-11.14	19.40	43.50	-24.10	QP		
4		301.4224	34.59	-6.97	27.62	46.00	-18.38	QP		
5		560.6928	28.87	-0.18	28.69	46.00	-17.31	QP		
6	*	845.0878	28.47	7.66	36.13	46.00	-9.87	QP		

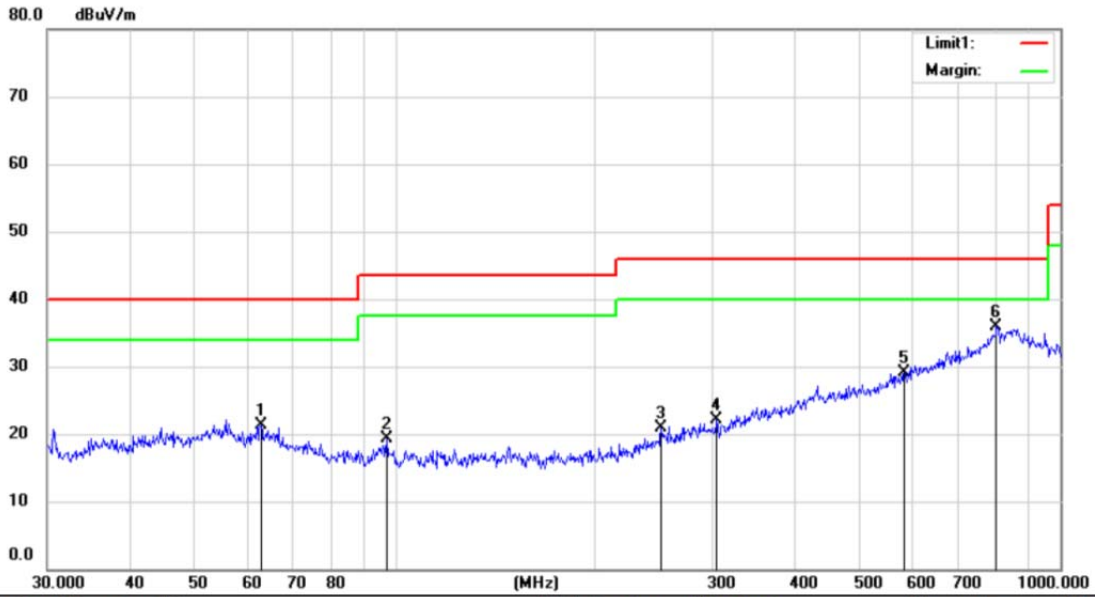

Site 3m Chamber #3      Polarization: **Vertical**      Temperature: 25.7 C  
 Limit: (RE)FCC PART 15 CLASS B      Power: DC 3V      Humidity: 55 %  
 Mode: BLE 2440  
 Note:

No.	Mk.	Freq.	Reading Level	Correct Factor	Measurement	Limit	Over	Antenna Height	Table Degree	
		MHz	dBuV	dB	dBuV/m	dBuV/m	dB	cm	degree	Comment
1		62.8708	29.91	-8.67	21.24	40.00	-18.76	QP		
2		97.1148	30.81	-11.57	19.24	43.50	-24.26	QP		
3		251.1804	29.75	-8.89	20.86	46.00	-25.14	QP		
4		304.6100	29.18	-7.03	22.15	46.00	-23.85	QP		
5		582.7425	28.68	0.37	29.05	46.00	-16.95	QP		
6	*	801.7863	29.02	6.91	35.93	46.00	-10.07	QP		

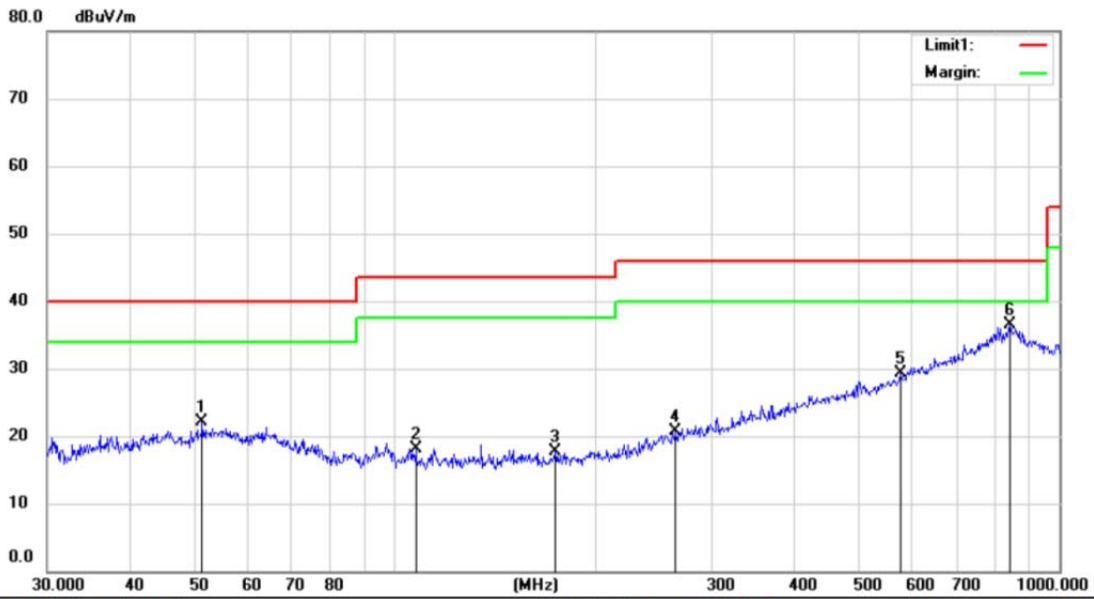

Site 3m Chamber #3      Polarization: *Vertical*      Temperature: 25.7 C  
 Limit: (RE)FCC PART 15 CLASS B      Power: DC 3V      Humidity: 55 %  
 Mode: BLE 2480  
 Note:

No.	Mk.	Freq. MHz	Reading Level dBuV	Correct Factor dB	Measure- ment dBuV/m	Limit dBuV/m	Over dB	Antenna Height cm	Table Degree degree	Comment
1		51.3005	30.72	-8.58	22.14	40.00	-17.86			QP
2		107.5101	29.59	-11.41	18.18	43.50	-25.32			QP
3		174.4241	29.03	-11.33	17.70	43.50	-25.80			QP
4		264.7457	29.20	-8.46	20.74	46.00	-25.26			QP
5		576.6443	29.04	0.24	29.28	46.00	-16.72			QP
6	*	842.1296	28.85	7.65	36.50	46.00	-9.50			QP

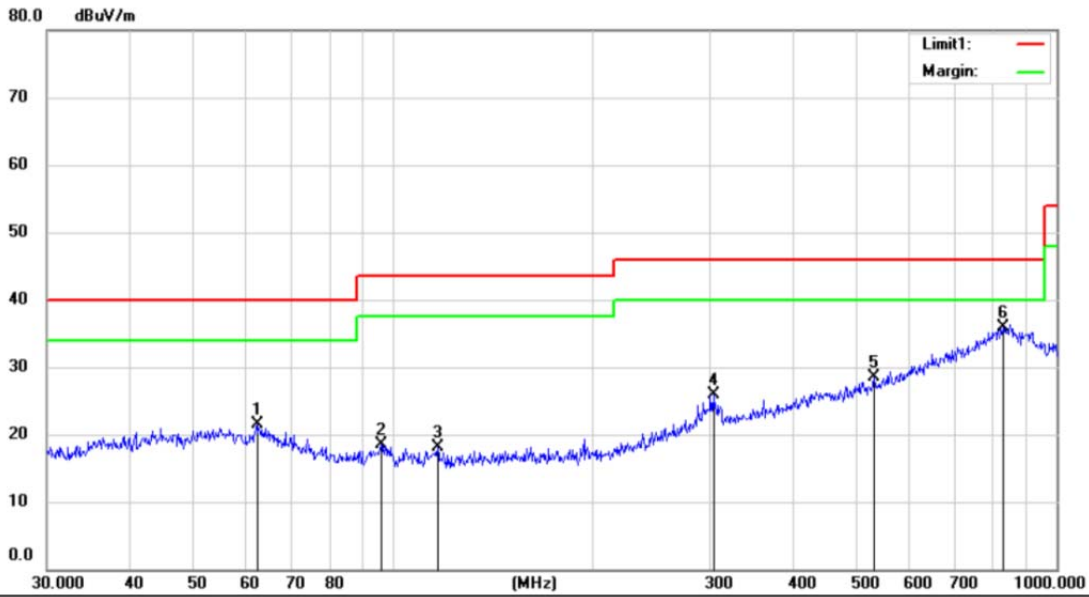

Site 3m Chamber #3 Polarization: *Horizontal* Temperature: 25.7 C  
 Limit: (RE)FCC PART 15 CLASS B Power: DC 3V Humidity: 55 %  
 Mode: BLE 2480  
 Note:

No.	Mk.	Freq.	Reading Level	Correct Factor	Measurement	Limit	Over	Antenna Height	Table Degree
		MHz	dBuV	dB	dBuV/m	dBuV/m	dB	cm	degree
1		62.2128	30.20	-8.67	21.53	40.00	-18.47	QP	
2		95.7622	30.02	-11.53	18.49	43.50	-25.01	QP	
3		116.5401	29.46	-11.40	18.06	43.50	-25.44	QP	
4		303.5437	32.93	-7.02	25.91	46.00	-20.09	QP	
5		530.1014	29.70	-1.22	28.48	46.00	-17.52	QP	
6	*	830.4002	28.72	7.26	35.98	46.00	-10.02	QP	

## 8.8 CONDUCTED EMISSIONS TEST

### 8.8.1 Applicable Standard

According to FCC Part 15.207(a)  
According to IC RSS-Gen 8.8

### 8.8.2 Conformance Limit

Frequency(MHz)	Conducted Emission Limit	
	Quasi-peak	Average
0.15-0.5	66-56	56-46
0.5-5.0	56	46
5.0-30.0	60	50

Note: 1. The lower limit shall apply at the transition frequencies  
2. The limit decreases in line with the logarithm of the frequency in the range of 0.15 to 0.50MHz.

### 8.8.3 Test Configuration

Test according to clause 7.3 conducted emission test setup

### 8.8.4 Test Procedure

The EUT was placed on a table which is 0.8m above ground plane.  
Maximum procedure was performed on the highest emissions to ensure EUT compliance.  
Repeat above procedures until all frequency measured were complete.

### 8.8.5 Test Results

N/A

## 8.9 ANTENNA APPLICATION

### 8.9.1 Antenna Requirement

Standard	Requirement
FCC CRF Part 15.203	An intentional radiator shall be designed to ensure that no antenna other than that furnished by the responsible party shall be used with the device. The use of a permanently attached antenna or of an antenna that uses a unique coupling to the intentional radiator shall be considered sufficient to comply with the provisions of this section. The manufacturer may design the unit so that a broken antenna can be replaced by the user, but the use of a standard antenna jack or electrical connector is prohibited.
FCC 47 CFR Part 15.247 (b)	If transmitting antennas of directional gain greater than 6dBi are used, the power shall be reduced by the amount in dB that the directional gain of the antenna exceeds 6dBi.
RSS-Gen Section 6.8	The applicant for equipment certification shall provide a list of all antenna types that may be used with the transmitter, where applicable (i.e. for transmitters with detachable antenna), indicating the maximum permissible antenna gain (in dBi) and the required impedance for each antenna. The test report shall demonstrate the compliance of the transmitter with the limit for maximum equivalent isotropically radiated power (e.i.r.p.) specified in the applicable RSS, when the transmitter is equipped with any antenna type, selected from this list.
RSS-247 Section 5.4	If the transmitter employs an antenna system that emits multiple directional beams, but does not emit multiple directional beams simultaneously, the total output power conducted to the array or arrays that comprise the device (i.e. the sum of the power supplied to all antennas, antenna elements, staves, etc., and summed across all carriers or frequency channels) shall not exceed the applicable output power limit. However, the total conducted output power shall be reduced by 1 dB below the specified limits for each 3 dB that the directional gain of the antenna/antenna array exceeds 6 dBi. The directional antenna gain shall be computed as the sum of 10 log (number of array elements or staves) plus the directional gain of the element or stave having the highest gain.

### 8.9.2 Result

PASS.

- Note:
- Antenna use a permanently attached antenna which is not replaceable.
  - Not using a standard antenna jack or electrical connector for antenna replacement
  - The antenna has to be professionally installed (please provide method of installation)

Please refer to the attached document Internal Photos to show the antenna connector.

----- END OF REPORT -----