



## FCC 47 CFR PART 15 SUBPART C AND ANSI C63.4: 2003

### TEST REPORT

For

**Wireless Mouse**

**Model : JF-04**

**Brand Name : CHERRY**

Test Report Number:

T111115401-RP1

**Issued for**

**ZF Friedrichshafen AG**

Cherrystrabe, 91275 Auerbach, Deutschland/Germany

**Issued by**

**Compliance Certification Services Inc.**

**Tainan Lab.**

**No.8, Jiucengling, Xinhua Dist., Tainan City 712, Taiwan (R.O.C.)**

**TEL: 886-6-580-2201**

**FAX: 886-6-580-2202**

**Issued Date: January 03, 2012**



---

*Note: This report shall not be reproduced except in full, without the written approval of Compliance Certification Services Inc. This document may be altered or revised by Compliance Certification Services Inc. personnel only, and shall be noted in the revision section of the document.*



## **REVISION HISTORY**

<b>Rev.</b>	<b>Issue Date</b>	<b>Revisions</b>	<b>Effect Page</b>	<b>Revised By</b>
00	December 13, 2011	Initial Issue	ALL	Sunny Chang
01	December 29, 2011	Update applicant address	Page 4	Sunny Chang
02	January 03, 2012	Update typo and test procedure	Page 13; 16	Sunny Chang



## TABLE OF CONTENTS

<b>1. TEST RESULT CERTIFICATION .....</b>	<b>4</b>
<b>2. EUT DESCRIPTION .....</b>	<b>5</b>
<b>3. TEST METHODOLOGY .....</b>	<b>6</b>
3.1 EUT CONFIGURATION .....	6
3.2 EUT EXERCISE .....	6
3.3 GENERAL TEST PROCEDURES .....	6
3.4 FCC PART 15.205 RESTRICTED BANDS OF OPERATIONS.....	7
3.5 DESCRIPTION OF TEST MODES .....	8
<b>4. INSTRUMENT CALIBRATION .....</b>	<b>9</b>
4.1 MEASURING INSTRUMENT CALIBRATION .....	9
4.2 MEASUREMENT EQUIPMENT USED.....	9
<b>5. FACILITIES AND ACCREDITATIONS .....</b>	<b>10</b>
5.1 FACILITIES .....	10
5.2 EQUIPMENT .....	10
5.3 LABORATORY ACCREDITATIONS LISTINGS.....	10
5.4 TABLE OF ACCREDITATIONS AND LISTINGS .....	11
<b>6. SETUP OF EQUIPMENT UNDER TEST.....</b>	<b>12</b>
6.1 SETUP CONFIGURATION OF EUT .....	12
6.2 SUPPORT EQUIPMENT .....	12
<b>7. FCC PART 15.249 REQUIREMENTS.....</b>	<b>13</b>
7.1 20 DB BANDWIDTH .....	13
7.2 BAND EDGES MEASUREMENT .....	16
7.3 SPURIOUS EMISSION .....	19
7.4 DUTY CYCLE CORRECTION FACTOR.....	29
7.5 POWERLINE CONDUCTED EMISSIONS .....	32
<b>8. APPENDIX I PHOTOGRAPHS OF TEST SETUP .....</b>	<b>36</b>
<b>APPENDIX II PHOTOGRAPHS OF EUT.....</b>	<b>A1</b>



### 1. TEST RESULT CERTIFICATION

**Product:** Wireless Mouse

**Model:** JF-04

**Brand Name:** CHERRY

**Applicant:** ZF Friedrichshafen AG

Cherrystrabe, 91275 Auerbach, Deutschland/Germany

**Manufacturer:** Sunrex Technology (Jiangsu) Co., Ltd.

Fenhu Economic Development Zone, Wujiang, China

**Tested:** November 16, 2011 ~ December 05, 2011

APPLICABLE STANDARDS	
STANDARD	TEST RESULT
FCC Part 15 Subpart C AND ANSI C63.4 : 2003	No non-compliance noted

Approved by:

**Jeter Wu**  
Assistant Manager

Reviewed by:

**Eric Huang**  
Assistant Section Manager



## 2. EUT DESCRIPTION

<b>Product</b>	Wireless Mouse
<b>Model Number</b>	JF-04
<b>Brand Name</b>	CHERRY
<b>Serial Number</b>	T111115401
<b>Received Date</b>	November 15, 2011
<b>Power Supply</b>	DC 3V (Powered from Battery)
<b>Frequency Range</b>	2406 ~ 2468MHz
<b>Transmit Peak Power</b>	90.85dBuV/m
<b>Transmit Data Rate</b>	2Mbps
<b>Modulation Technique</b>	GFSK
<b>Number of Channels</b>	63 Channels
<b>Antenna Specification</b>	Gain : -3.02 dBi
<b>Antenna Designation</b>	PCB Antenna
<b>Temperature Range</b>	0 ~ +55°C

**Remark:**

1. The sample selected for test was production product and was provided by manufacturer.
2. This submittal(s) (test report) is intended for FCC ID: **GDDJF-04** filing to comply with Section 15.107, 15.109, 15.207, 15.209, 15.249 (FCC Part 15, Subpart C Rules.)
3. For more details, please refer to the User's manual of the EUT.



### **3. TEST METHODOLOGY**

The tests documented in this report were performed in accordance with ANSI C63.4: 2003 and FCC CFR 47 Part 15.207, 15.209 and 15.249.

#### **3.1 EUT CONFIGURATION**

The EUT configuration for testing is installed on RF field strength measurement to meet the Commissions requirement and operating in a manner that intends to maximize its emission characteristics in a continuous normal application.

#### **3.2 EUT EXERCISE**

The EUT was operated in the engineering mode to fix the TX frequency that was for the purpose of the measurements.

According to its specifications, the EUT must comply with the requirements of the Section 15.207, 15.209, 15.249 under the FCC Rules Part 15 Subpart C.

#### **3.3 GENERAL TEST PROCEDURES**

##### **Conducted Emissions**

The EUT is placed on the turntable, which is 0.8 m above ground plane. According to the requirements in Section 13.1.4.1 of ANSI C63.4: 2003 Conducted emissions from the EUT measured in the frequency range between 0.15 MHz and 30MHz using CISPR Quasi-peak and average detector modes.

##### **Radiated Emissions**

The EUT is placed on a turn table, which is 0.8 m above ground plane. The turntable shall rotate 360 degrees to determine the position of maximum emission level. EUT is set 3m away from the receiving antenna, which varied from 1m to 4m to find out the highest emission. And also, each emission was to be maximized by changing the polarization of receiving antenna both horizontal and vertical. In order to find out the maximum emissions, exploratory radiated emission measurements were made according to the requirements in Section 13.1.4.1 of ANSI C63.4: 2003.



### 3.4 FCC PART 15.205 RESTRICTED BANDS OF OPERATIONS

- (a) Except as shown in paragraph (d) of this section, only spurious emissions are permitted in any of the frequency bands listed below:

MHz	MHz	MHz	GHz
0.090 - 0.110	16.42 - 16.423	399.9 - 410	4.5 - 5.15
<sup>1</sup> 0.495 - 0.505	16.69475 - 16.69525	608 - 614	5.35 - 5.46
2.1735 - 2.1905	16.80425 - 16.80475	960 - 1240	7.25 - 7.75
4.125 - 4.128	25.5 - 25.67	1300 - 1427	8.025 - 8.5
4.17725 - 4.17775	37.5 - 38.25	1435 - 1626.5	9.0 - 9.2
4.20725 - 4.20775	73 - 74.6	1645.5 - 1646.5	9.3 - 9.5
6.215 - 6.218	74.8 - 75.2	1660 - 1710	10.6 - 12.7
6.26775 - 6.26825	108 - 121.94	1718.8 - 1722.2	13.25 - 13.4
6.31175 - 6.31225	123 - 138	2200 - 2300	14.47 - 14.5
8.291 - 8.294	149.9 - 150.05	2310 - 2390	15.35 - 16.2
8.362 - 8.366	156.52475 -	2483.5 - 2500	17.7 - 21.4
8.37625 - 8.38675	156.52525	2655 - 2900	22.01 - 23.12
8.41425 - 8.41475	156.7 - 156.9	3260 - 3267	23.6 - 24.0
12.29 - 12.293	162.0125 - 167.17	3332 - 3339	31.2 - 31.8
12.51975 - 12.52025	167.72 - 173.2	3345.8 - 3358	36.43 - 36.5
12.57675 - 12.57725	240 - 285	3600 - 4400	( <sup>2</sup> )
13.36 - 13.41	322 - 335.4		

<sup>1</sup> Until February 1, 1999, this restricted band shall be 0.490-0.510 MHz.

<sup>2</sup> Above 38.6

- (b) Except as provided in paragraphs (d) and (e), the field strength of emissions appearing within these frequency bands shall not exceed the limits shown in Section 15.209. At frequencies equal to or less than 1000 MHz, compliance with the limits in Section 15.209 shall be demonstrated using measurement instrumentation employing a CISPR quasi-peak detector. Above 1000 MHz, compliance with the emission limits in Section 15.209 shall be demonstrated based on the average value of the measured emissions. The provisions in Section 15.35 apply to these measurements.



### 3.5 DESCRIPTION OF TEST MODES

The EUT (model: JF-04) had been tested under operating condition.

After verification, all tests were carried out with the worst case test modes as shown below except radiated spurious emission below 1GHz, which worst case was in normal link mode only, and powerline conducted emission below 30MHz, which worst case was in normal link mode .

All tests were carried out with the worst case test modes as shown below except radiated spurious emission below 1GHz, which worst case was in normal link mode .

Channel Low (2406MHz), Channel Mid (2437MHz) and Channel High (2468MHz) were chosen for the RF final testing.





## 4. INSTRUMENT CALIBRATION

### 4.1 MEASURING INSTRUMENT CALIBRATION

The measuring equipment, which was utilized in performing the tests documented herein, has been calibrated in accordance with the manufacturer's recommendations for utilizing calibration equipment, which is traceable to recognized national standards.

### 4.2 MEASUREMENT EQUIPMENT USED

#### Equipment Used for Emissions Measurement

Open Area Test Site # 6				
Name of Equipment	Manufacturer	Model	Serial Number	Calibration Due
TYPE N COAXIAL CABLE	SUHNER	CHA9513	6	NOV. 17, 2012
BI-LOG Antenna	Sunol	JB1	A070506-2	OCT. 03, 2012
LOOP ANTENNA	EMCO	6502	8905-2356	JUN. 10, 2012
Pre-Amplifier	HP	8447F	2944A03817	NOV. 23, 2012
EMI Receiver	R&S	ESVS10	833206/012	MAY 10, 2012
RF Cable	SUHNER	SUCOFLEX104PEA	20520/4PEA	NOV. 10, 2012
Horn Antenna	Com-Power	AH-118	071032	DEC. 27, 2011
Spectrum Analyzer	R&S	FSEK 30	835253/002	SEP. 29, 2012
Pre-Amplifier	MITEQ	AFS44-00108650-42 -10P-44	1205908	NOV. 23, 2012
3116 Double Ridge Antenna (40G)	ETS-LINDGRE N	EMCO-003	00078	NOV. 14, 2012
Turn Table	Yo Chen	001	-----	N.C.R.
Antenna Tower	AR	TP1000A	309874	N.C.R.
Controller	CT	SC101	-----	N.C.R.
RF Swith	E-INSTRUMEN T TELH LTD	ERS-180A	EC1204141	N.C.R
Power Meter	Anritsu	ML2487A	6K00003888	MAY 30, 2012
Power Sensor	Anritsu	MA2491A	33265	MAY 30.2012
Temp./Humidity Chamber	K.SON	THS-M1	242	AUG. 09, 2012
Signal Generator	HP	8673C	2938A00663	SEP. 12, 2012
DC Power Source	LOKO	DSP-5050	L1507009282	N.C.R

**Remark:** Each piece of equipment is scheduled for calibration once a year.



## **5. FACILITIES AND ACCREDITATIONS**

### **5.1 FACILITIES**

All measurement facilities used to collect the measurement data are located at

☒ No.8, Jiucengling, Xinhua Dist., Tainan City 712, Taiwan (R.O.C.)

The sites are constructed in conformance with the requirements of ANSI C63.7:1992, ANSI C63.4 : 2003 and CISPR Publication 22.

### **5.2 EQUIPMENT**

Radiated emissions are measured with one or more of the following types of linearly polarized antennas: tuned dipole, biconical, log periodic, bi-log, and/or ridged waveguide, horn. Spectrum analyzers with preselectors and quasi-peak detectors are used to perform radiated measurements.

Conducted emissions are measured with Line Impedance Stabilization Networks and EMI Test Receivers.

Calibrated wideband preamplifiers, coaxial cables, and coaxial attenuators are also used for making measurements.

All receiving equipment conforms to CISPR Publication 16-1, "Radio Interference Measuring Apparatus and Measurement Methods."

### **5.3 LABORATORY ACCREDITATIONS LISTINGS**

The test facilities used to perform radiated and conducted emissions tests are accredited by Taiwan Accreditation Foundation for the specific scope of accreditation under Lab Code: 1109 to perform Electromagnetic Interference tests according to FCC PART 15 AND CISPR 22 requirements. No part of this report may be used to claim or imply product endorsement by TAF or any agency of the Government. In addition, the test facilities are listed with Federal Communications Commission (registration no: TW-1037)



## 5.4 TABLE OF ACCREDITATIONS AND LISTINGS

Our laboratories are accredited and approved by the following accreditation body according to ISO/IEC 17025.

<b>Taiwan</b>	TAF
---------------	-----

The measuring facility of laboratories has been authorized or registered by the following approval agencies.

<b>Canada</b>	Industry Canada
<b>Germany</b>	TUV NORD
<b>Taiwan</b>	BSMI
<b>USA</b>	FCC

Copies of granted accreditation certificates are available for downloading from our web site, <http://www.ccsrf.com>



## 6. SETUP OF EQUIPMENT UNDER TEST

### 6.1 SETUP CONFIGURATION OF EUT

See test photographs attached in Appendix I for the actual connections between EUT and support equipment.

### 6.2 SUPPORT EQUIPMENT

#### [EMC test]

No.	Product	Manufacturer	Model No.	Certify No.	Signal cable
1	PC	Acer	M3630	R33142	Power cable, unshd, 1.6m
2	LCD Monitor	BenQ	FP731	R43002	VGA cable, shd, 1.8m
3	Wireless Dongle	Sunrex	R040	DoC	N/A
4.	Wireless Keyboard	Sunrex	JG-04	DoC	N/A

No.	Signal cable description	
A	USB Cable	Shielded, 1.8m, 1pcs

#### [RF test]

No.	Product	Manufacturer	Model No.	Certify No.	Signal cable
1	N/A	---	---	---	---

No.	Signal cable description	
A	N/A	-----

#### Remark:

1. All the equipment/cables were placed in the worst-case configuration to maximize the emission during the test.
2. Grounding was established in accordance with the manufacturer's requirements and conditions for the intended use.



## 7. FCC PART 15.249 REQUIREMENTS

### 7.1 20 DB BANDWIDTH

#### LIMIT

None; for reporting purposes only.

#### Test Configuration

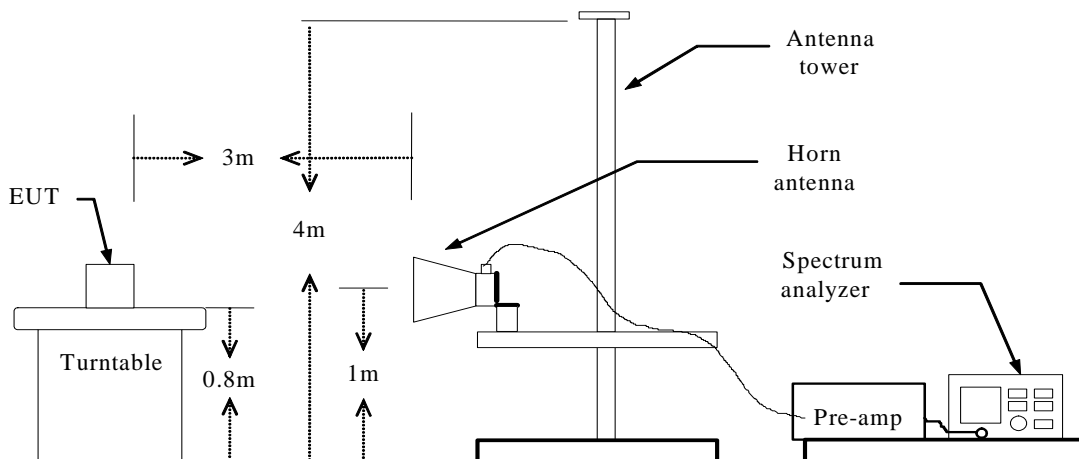

#### TEST PROCEDURE

1. The EUT is placed on a turntable, which is 0.8m above the ground plane.
2. The turntable shall be rotated for 360 degrees to determine the position of maximum emission level.
3. EUT is set 3m away from the receiving antenna, which is varied from 1m to 4m to find out the highest emission.
4. Set the spectrum analyzer as RBW=10 kHz, VBW = 10 kHz, Span = 2MHz, Sweep = auto.
5. Mark the peak frequency and 20dB (upper and lower) frequency.
6. Repeat until all the rest channels are investigated.

#### TEST RESULTS

No non-compliance noted

#### Test Data

Channel	Frequency (MHz)	20 dB Bandwidth (kHz)
CH1	2406	913.83
CH32	2437	917.84
CH63	2468	921.84



Test Plot

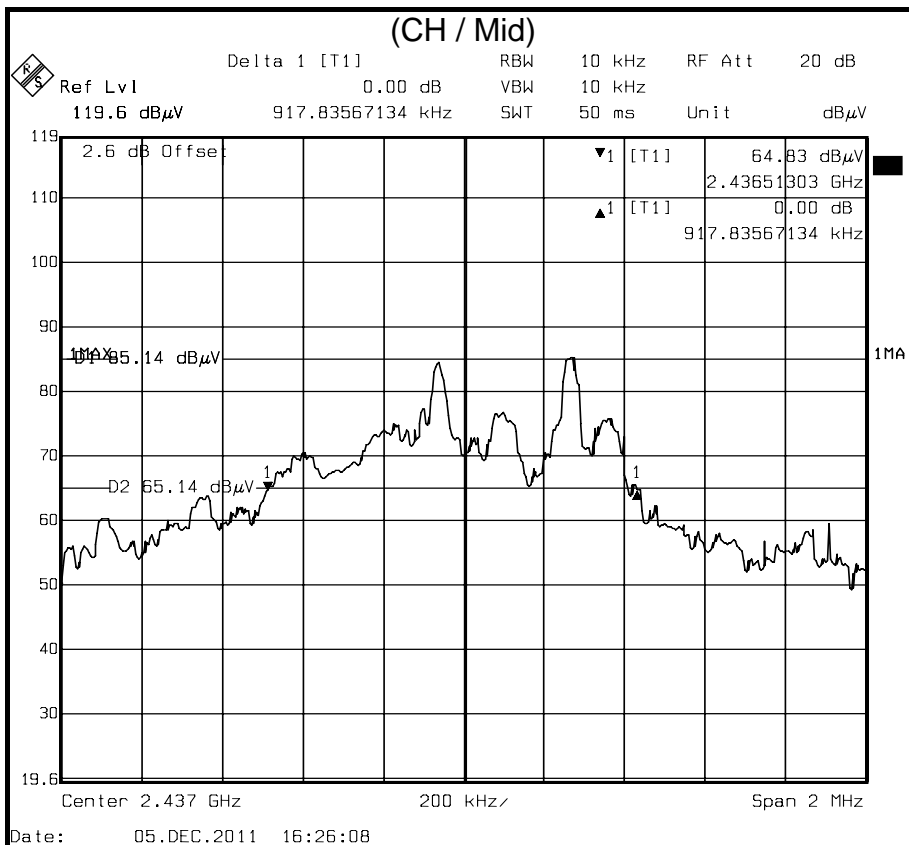
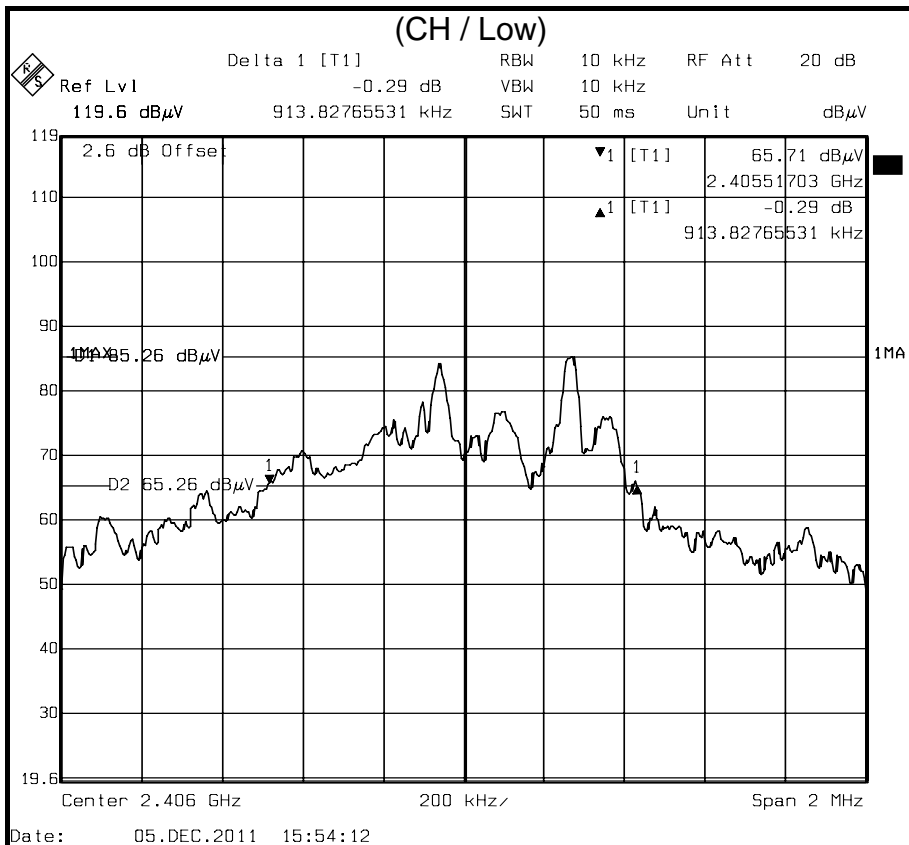

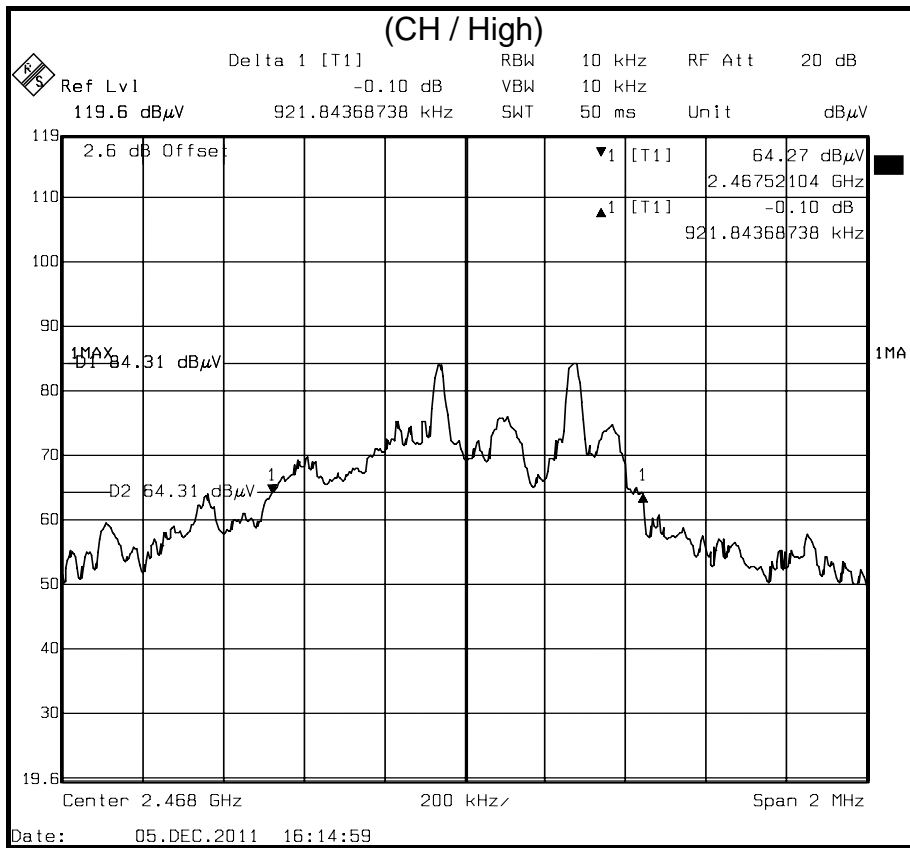



## 7.2 BAND EDGES MEASUREMENT

### LIMIT

1. In the above emission table, the tighter limit applies at the band edges.

Frequency (MHz)	Field Strength ( $\mu\text{V/m}$ at 3-meter)	Field Strength ( $\text{dB}\mu\text{V/m}$ at 3-meter)
30-88	100	40
88-216	150	43.5
216-960	200	46
Above 960	500	54

2. As shown in Section 15.35(b), for frequencies above 1000 MHz, the above field strength limits in paragraphs (a) and (b) of this section are based on average limits. However, the peak field strength of any emission shall not exceed the maximum permitted average limits specified above by more than 20 dB under any condition of modulation. For point-to-point operation under paragraph (b) of this section, the peak field strength shall not exceed 2500 millivolts/meter at 3 meters along the antenna azimuth.

### Test Configuration

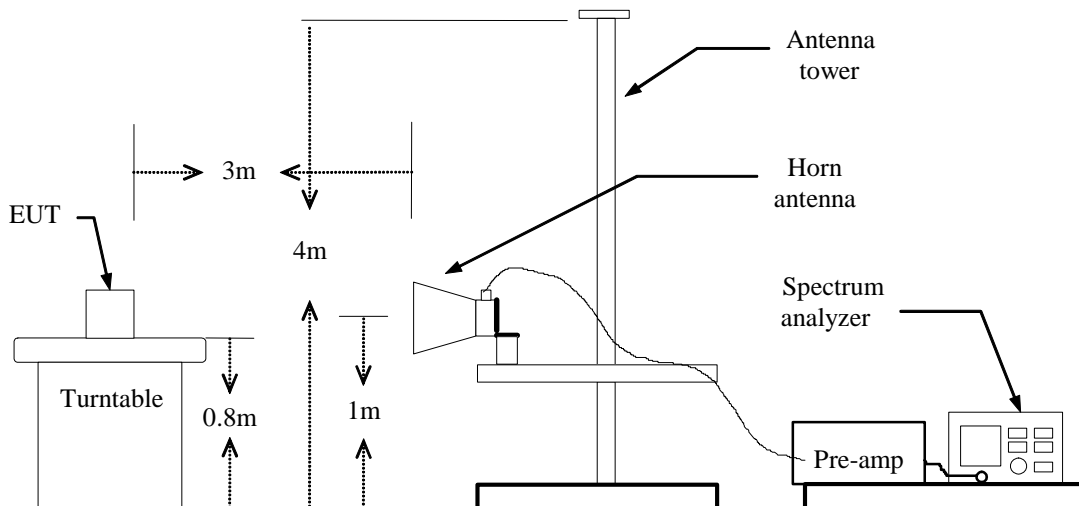

### TEST PROCEDURE

1. The EUT is placed on a turntable, which is 0.8m above the ground plane.
2. The turntable shall be rotated for 360 degrees to determine the position of maximum emission level.
3. EUT is set 3m away from the receiving antenna, which is varied from 1m to 4m to find out the highest emission.
4. Set the spectrum analyzer in the following setting in order to capture the lower and upper band-edges of the emission:  
PEAK: RBW=VBW=1MHz / Sweep=100 ms
5. Repeat the procedures until all the PEAK versus POLARIZATION are measured.

### TEST RESULTS

Refer to attach spectrum analyzer data chart.





**Band Edges (CH Low)**

**Detector mode: Peak**

**Polarity: Vertical**

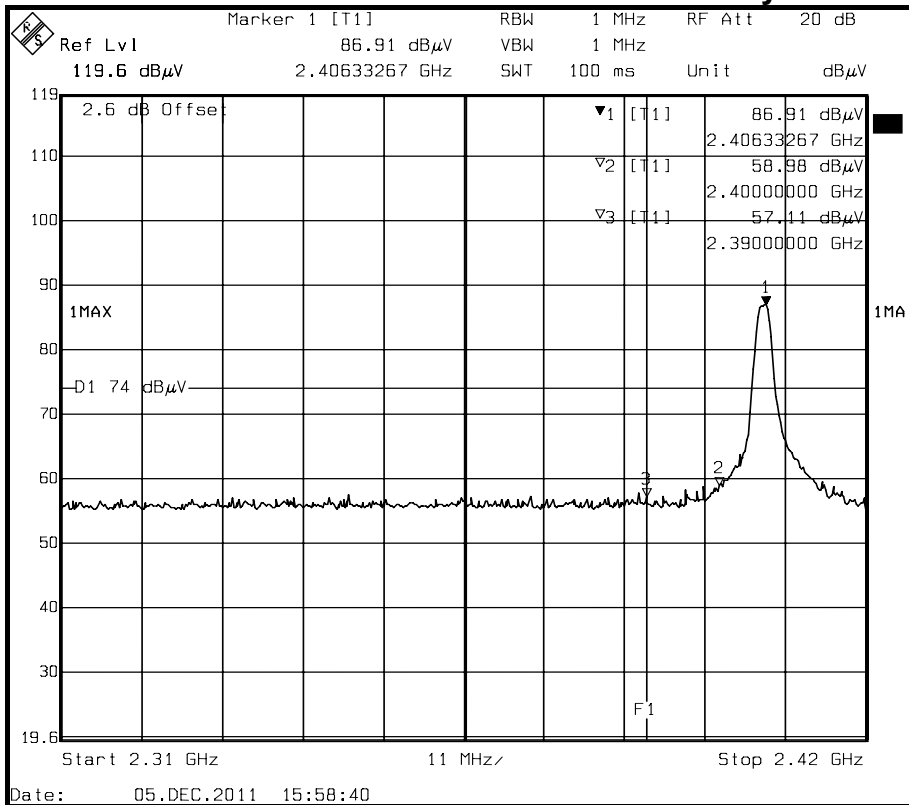

**Detector mode: Peak**

**Polarity: Horizontal**

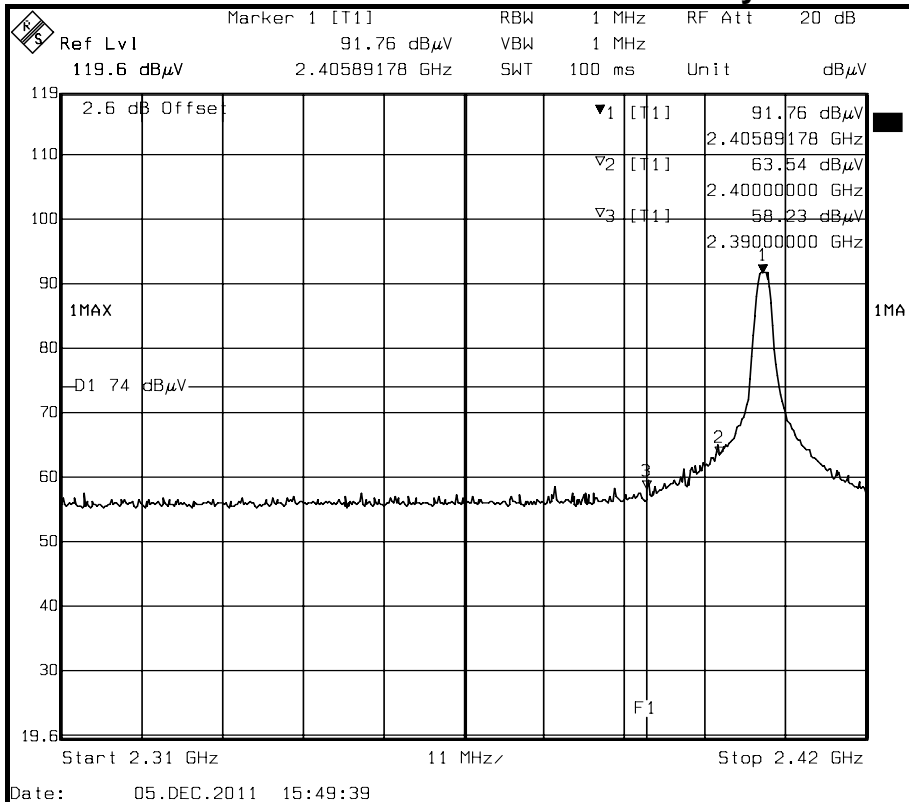



**Band Edges (CH High)**

**Detector mode: Peak**

**Polarity: Vertical**

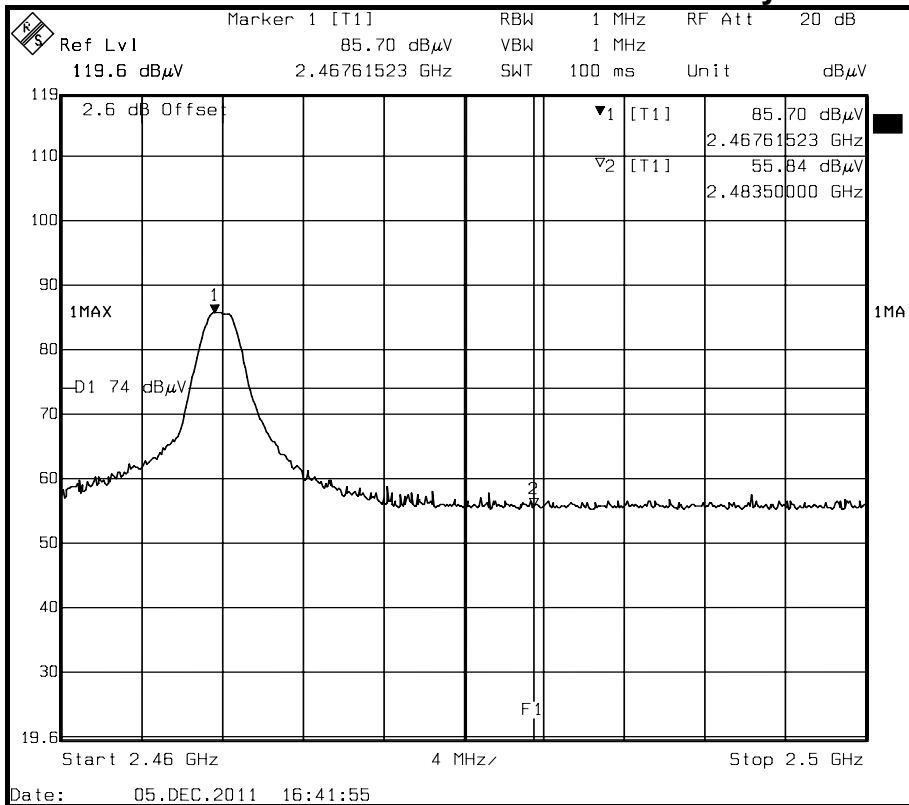

**Detector mode: Peak**

**Polarity: Horizontal**

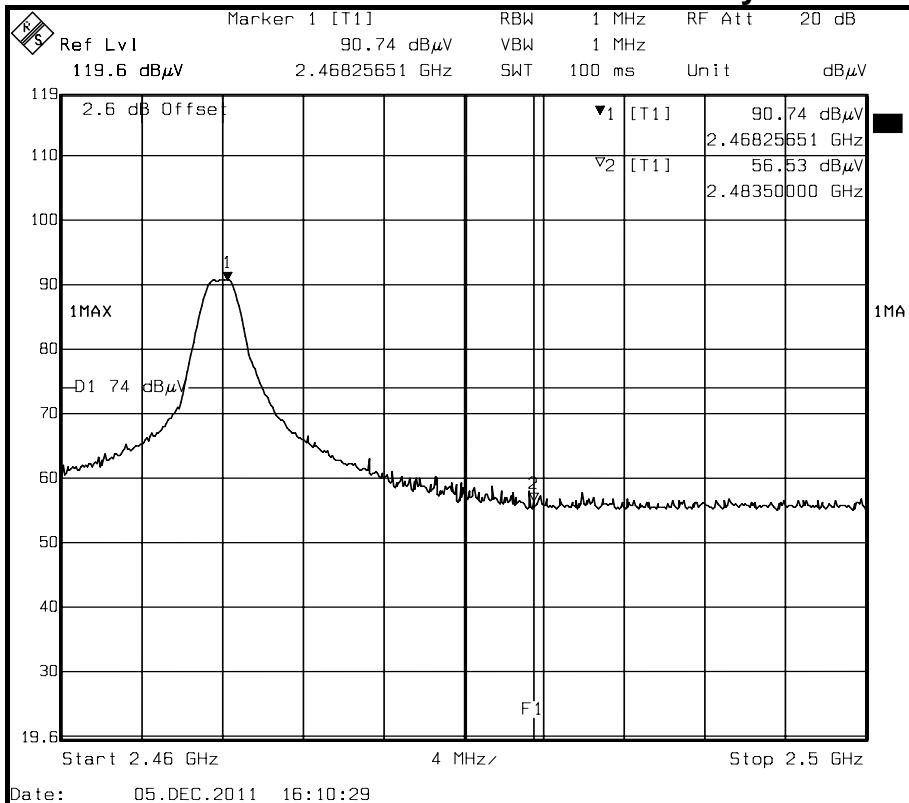



## 7.3 SPURIOUS EMISSION

### LIMIT

1. In the section 15.249(a):

Except as provided in paragraph (b) of this section, the field strength of emissions from intentional radiators operated within these frequency bands shall comply with the following:

Fundamental Frequency (MHz)	Field Strength of Fundamental Field Strength (mV/m)	Field Strength of Harmonics ( $\mu\text{V/m}$ )
902-928 MHz	50	500
2400 - 2483.5 MHz	50	500
5725 - 5875 MHz	50	500
24.0 - 24.25 GHz	250	2500

2. Except as provided elsewhere in this Subpart, the emissions from an intentional radiator shall not exceed the field strength levels specified in the following table:

Frequency (MHz)	Field Strength ( $\mu\text{V/m}$ )	Measurement Distance (m)
30-88	100*	3
88-216	150*	3
216-960	200*	3
Above 960	500	3

**Remark:** Except as provided in paragraph (g), fundamental emissions from intentional radiators operating under this Section shall not be located in the frequency bands 54-72 MHz, 76-88 MHz, 174-216 MHz or 470-806 MHz. However, operation within these frequency bands is permitted under other sections of this Part, e.g., Sections 15.231 and 15.241.

3. In the above emission table, the tighter limit applies at the band edges.

Frequency (MHz)	Field Strength ( $\mu\text{V/m}$ at 3-meter)	Field Strength (dB $\mu\text{V/m}$ at 3-meter)
30-88	100	40
88-216	150	43.5
216-960	200	46
Above 960	500	54



### Test Configuration

The diagram below shows the test setup that is utilized to make the measurements for emission from below 1GHz.

#### **9kHz ~ 30MHz**

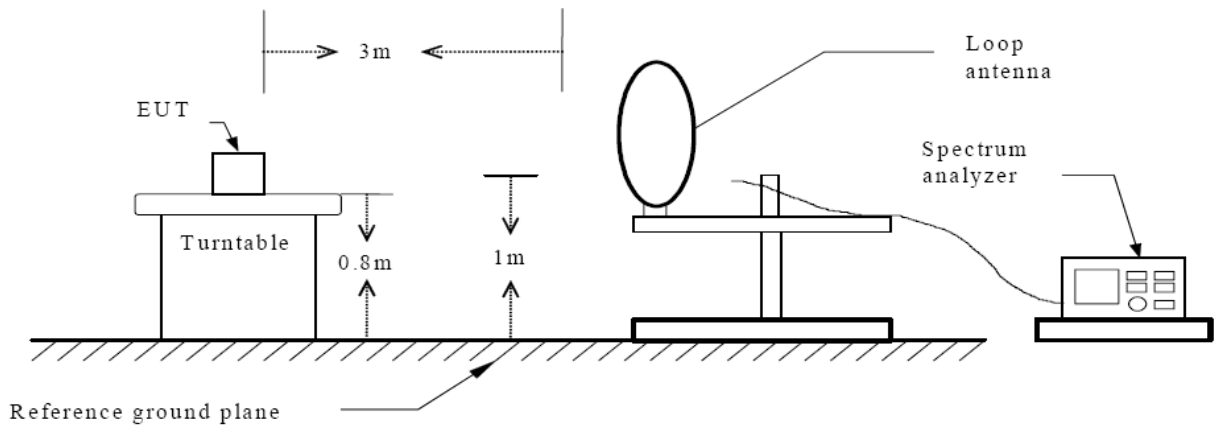

#### **30MHz ~ 1GHz**

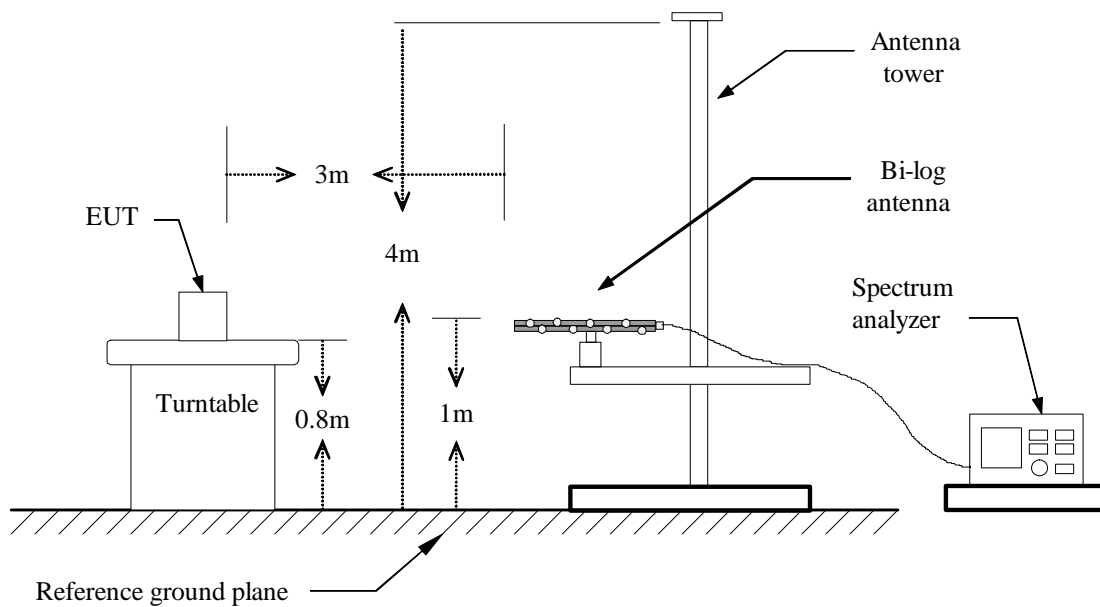



The diagram below shows the test setup that is utilized to make the measurements for emission above 1GHz.

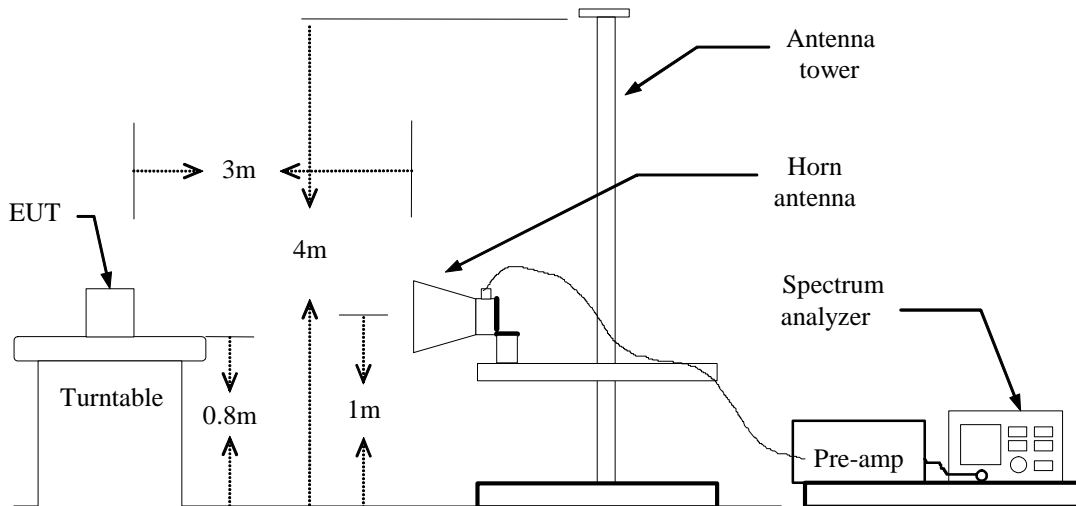

### TEST PROCEDURE

- The EUT was placed on the top of a rotating table 0.8 meters above the ground at a 10 meter open area test site. The table was rotated 360 degrees to determine the position of the highest radiation.
- While measuring the radiated emission below 1GHz, the EUT was set 3 meters away from the interference-receiving antenna, which was mounted on the top of a variable-height antenna tower. While measuring the radiated emission above 1GHz, the EUT was set 3 meters away from the interference-receiving antenna.
- The antenna is a broadband antenna, and its height is varied from one meter to four meters above the ground to determine the maximum value of the field strength. Both horizontal and vertical polarization of the antenna are set to make the measurement.
- For each suspected emission, the EUT was arranged to its worst case and then the antenna was tuned to heights from 1 meter to 4 meters and the table was turned from 0 degrees to 360 degrees to find the maximum reading.
- The test-receiver system was set to Peak Detect Function and Specified Bandwidth with Maximum Hold Mode.
- If the emission level of the EUT in peak mode was 10 dB lower than the limit specified, then testing could be stopped and the peak values of the EUT would be reported. Otherwise the emissions that did not have 10 dB margin would be re-tested one by one using peak, quasi-peak or average method as specified and then reported in a data sheet.

Note :

- The resolution bandwidth and video bandwidth of test receiver/spectrum analyzer is 120 KHz for Peak detection (PK) and Quasi-peak detection (QP) at frequency below 1GHz.
- The resolution bandwidth and video bandwidth of test receiver/spectrum analyzer is 1 MHz for Peak detection and frequency above 1GHz.
- The resolution bandwidth of test receiver/spectrum analyzer is 1 MHz and the video bandwidth is 10 Hz for Average detection (AV) at frequency above 1GHz.



**Below 1 GHz**

**Operation Mode:** Normal Operation      **Test Date:** Nov. 16, 2011  
**Temperature:** 26 °C                      **Tested by:** Taiyu Cyu  
**Humidity:** 57 % RH                      **Polarity:** Vertical

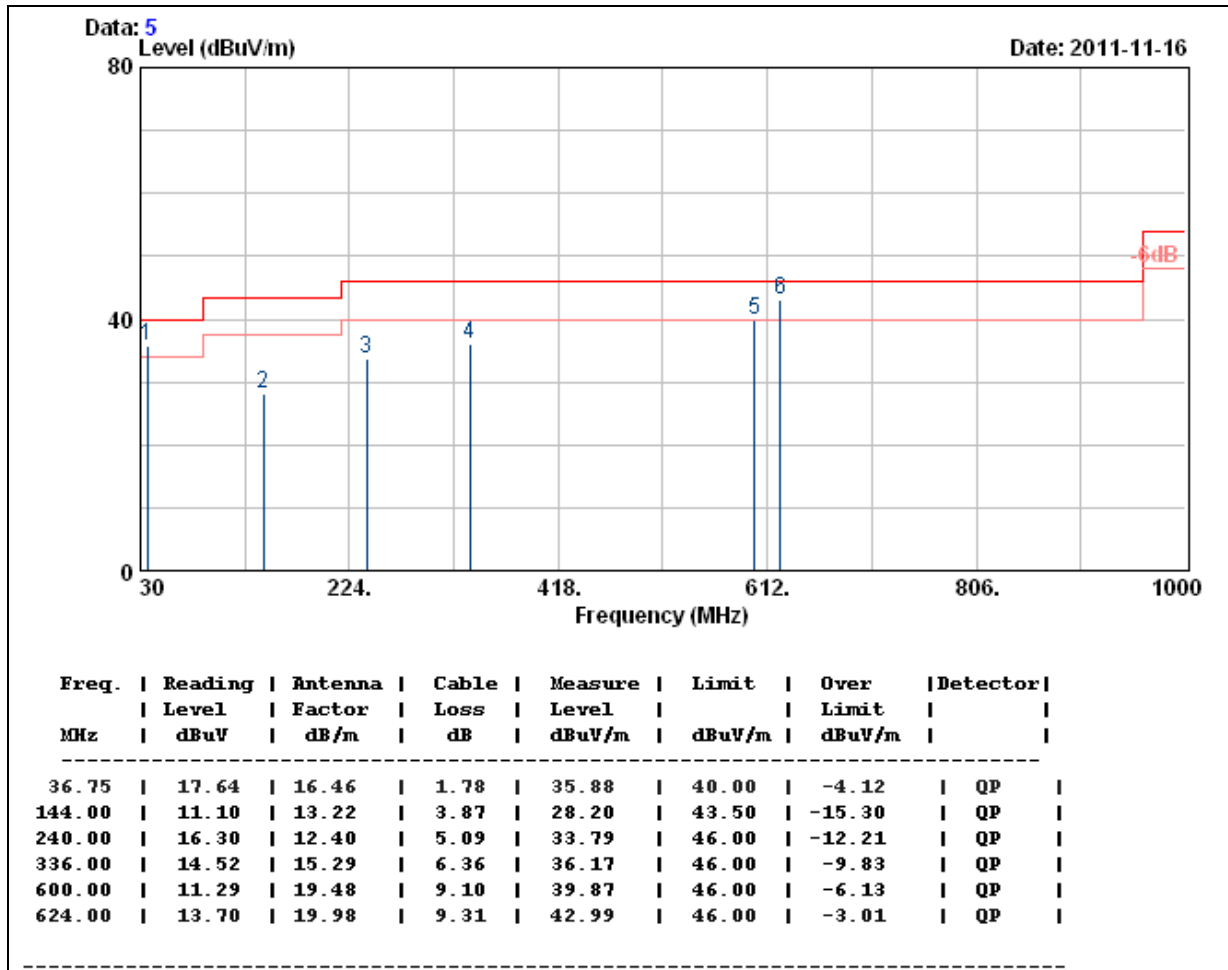

**Remark:**

1. No emission found between lowest internal used/generated frequency to 30MHz (9kHz~30MHz).
2. Radiated emissions measured were made with an instrument using peak/quasi-peak detector mode.
3. Quasi-peak test would be performed if the peak result were greater than the quasi-peak limit or as required by the applicant.
4. Measurements above show only up to 6 maximum emissions noted, or would be lesser, with " N/A " remark, if no specific emissions from the EUT are recorded (ie: margin>20dB from the applicable limit) and considered that's already beyond the background noise floor.
5. Margin (dB) = Remark result (dBuV/m) – Quasi-peak limit (dBuV/m).



**Operation Mode:** Normal Operation      **Test Date:** Nov. 16, 2011  
**Temperature:** 26 °C                      **Tested by:** Taiyu Cyu  
**Humidity:** 57 % RH                      **Polarity:** Horizontal

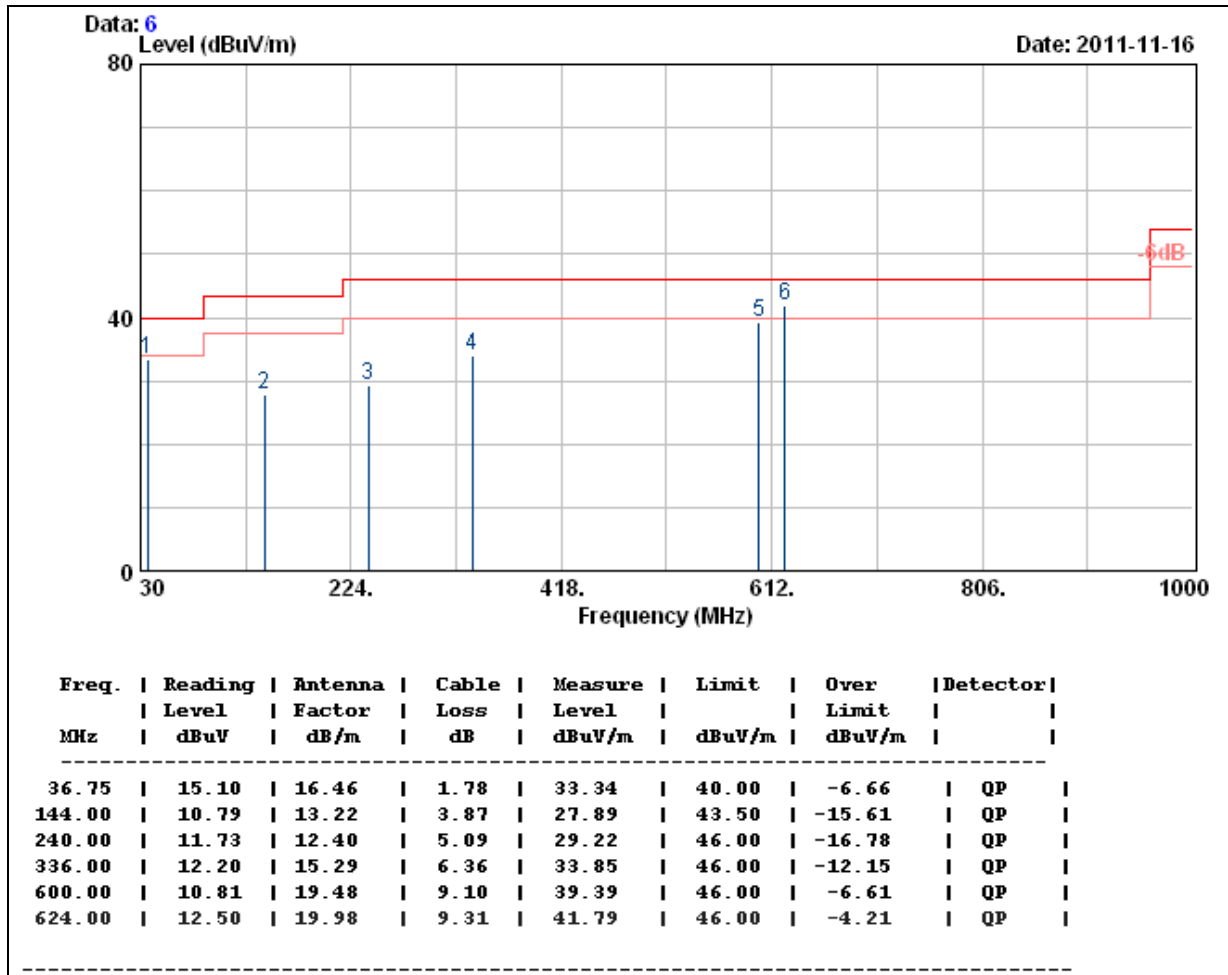

**Remark:**

1. No emission found between lowest internal used/generated frequency to 30MHz (9kHz~30MHz).
2. Radiated emissions measured were made with an instrument using peak/quasi-peak detector mode.
3. Quasi-peak test would be performed if the peak result were greater than the quasi-peak limit or as required by the applicant.
4. Measurements above show only up to 6 maximum emissions noted, or would be lesser, with " N/A " remark, if no specific emissions from the EUT are recorded (ie: margin>20dB from the applicable limit) and considered that's already beyond the background noise floor.
5. Margin (dB) = Remark result (dBuV/m) – Quasi-peak limit (dBuV/m).



**Operation Mode:** Charge Mode      **Test Date:** Nov. 16, 2011  
**Temperature:** 26 °C      **Tested by:** Taiyu Cyu  
**Humidity:** 57 % RH      **Polarity:** Vertical

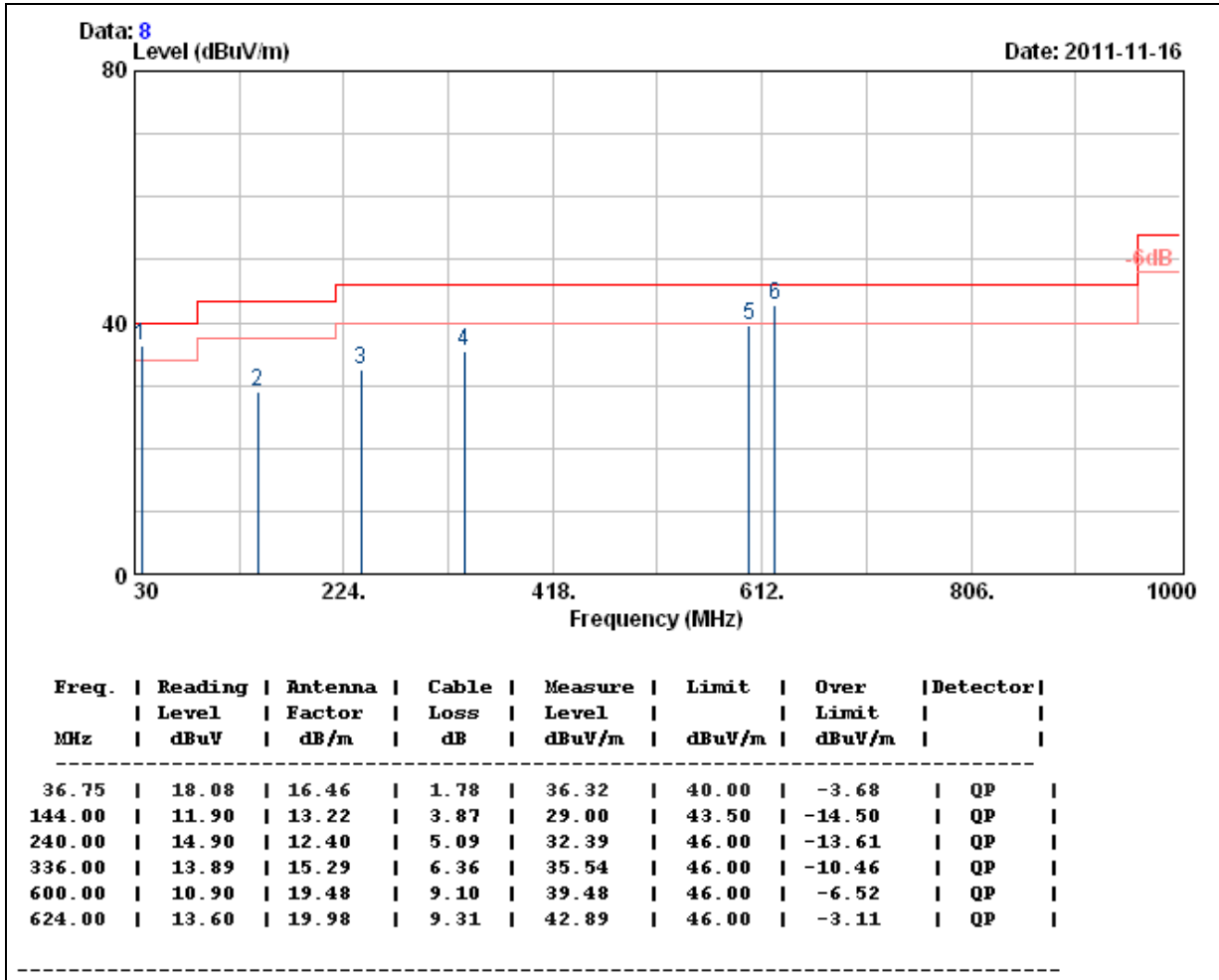

**Remark:**

1. No emission found between lowest internal used/generated frequency to 30MHz (9kHz~30MHz).
2. Radiated emissions measured were made with an instrument using peak/quasi-peak detector mode.
3. Quasi-peak test would be performed if the peak result were greater than the quasi-peak limit or as required by the applicant.
4. Measurements above show only up to 6 maximum emissions noted, or would be lesser, with " N/A " remark, if no specific emissions from the EUT are recorded (ie: margin>20dB from the applicable limit) and considered that's already beyond the background noise floor.
5. Margin (dB) = Remark result (dBuV/m) – Quasi-peak limit (dBuV/m).





Operation Mode: Charge Mode  
Temperature: 26 °C  
Humidity: 57 % RH

Test Date: Nov. 16, 2011  
Tested by: Taiyu Cyu  
Polarity: Horizontal

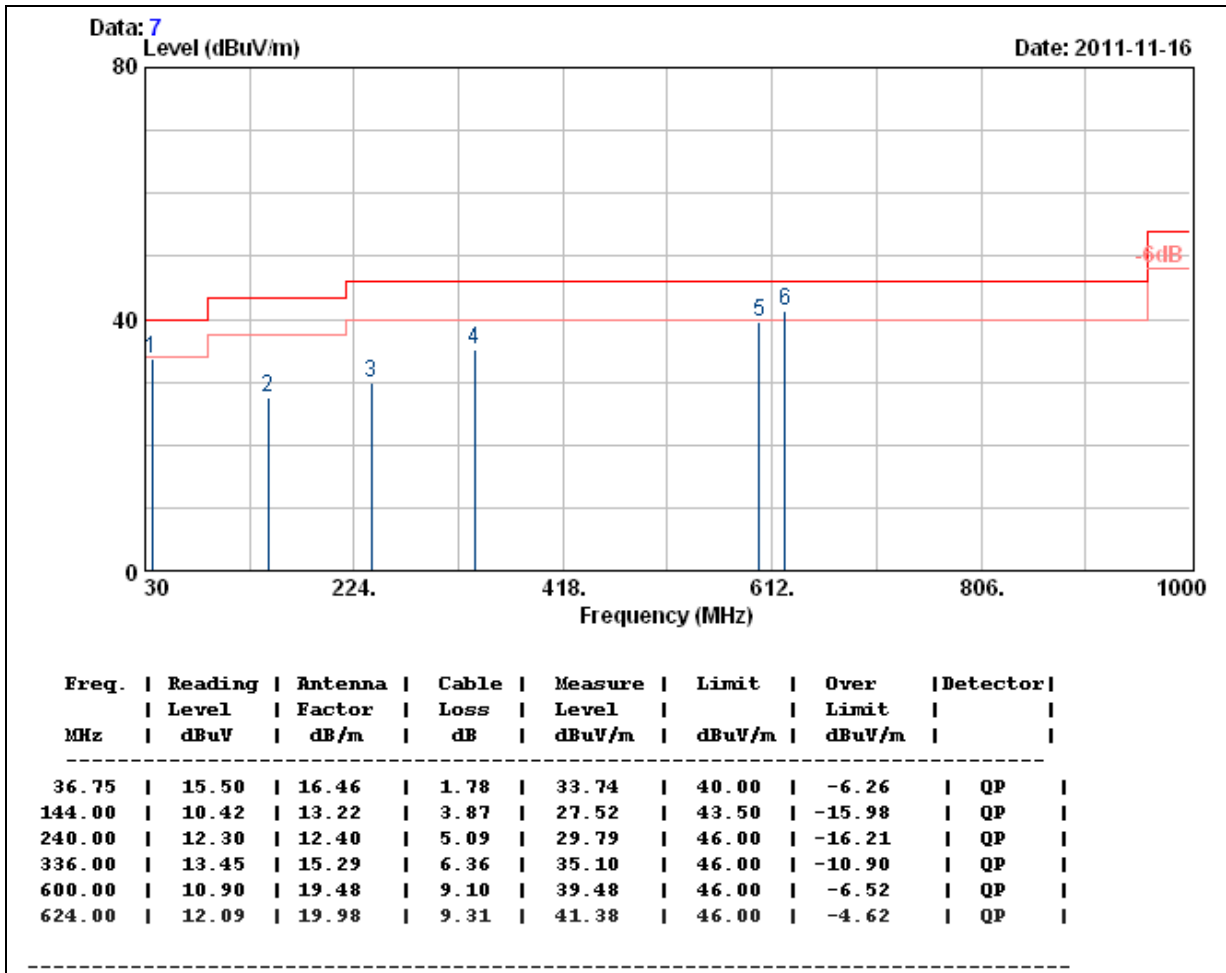

**Remark:**

1. No emission found between lowest internal used/generated frequency to 30MHz (9kHz~30MHz).
2. Radiated emissions measured were made with an instrument using peak/quasi-peak detector mode.
3. Quasi-peak test would be performed if the peak result were greater than the quasi-peak limit or as required by the applicant.
4. Measurements above show only up to 6 maximum emissions noted, or would be lesser, with " N/A " remark, if no specific emissions from the EUT are recorded (ie: margin>20dB from the applicable limit) and considered that's already beyond the background noise floor.
5. Margin (dB) = Remark result (dBuV/m) – Quasi-peak limit (dBuV/m).

**Above 1 GHz**

<b>Product Name</b>	Wireless Mouse	<b>Test Date</b>	Dec. 04, 2011
<b>Model</b>	JF-04	<b>Test By</b>	John Chen
<b>Test Mode</b>	TX (CH Low)	<b>Temp&amp; Humidity</b>	25.1 , 52%

**Horizontal**

TX mode / CH Low				Measurement Distance at 3m				Horizontal polarity	
Freq.	Reading	AF	Cable Loss	Pre-amp	Filter	Level	Limit	Margin	Mark
(MHz)	(dBμV)	(dB/m)	(dB)	(dB)	(dB)	(dBμV/m)	(dBμV/m)	(dB)	(P/Q/A)
2406.00	99.50	29.83	2.62	41.10	0.00	90.85	114.00	-23.15	P
2406.00	79.50	29.83	2.62	41.10	0.00	70.85	94.00	-23.15	A
2400.00	71.52	29.84	2.61	41.10	1.24	64.12	74.00	-9.88	P
2400.00	51.52	29.84	2.61	41.10	1.24	44.12	54.00	-9.88	A
* 4812.43	72.40	33.14	3.73	42.37	0.69	67.58	74.00	-6.42	P
* 4812.43	52.40	33.14	3.73	42.37	0.69	47.58	54.00	-6.42	A
7218.02	55.16	38.55	4.66	41.87	1.40	57.91	74.00	-16.09	P
7218.02	35.16	38.55	4.66	41.87	1.40	37.91	54.00	-16.09	A

<b>Product Name</b>	Wireless Mouse	<b>Test Date</b>	Dec. 04, 2011
<b>Model</b>	JF-04	<b>Test By</b>	John Chen
<b>Test Mode</b>	TX (CH Low)	<b>Temp&amp; Humidity</b>	25.1 , 52%

**Vertical**

TX mode / CH Low				Measurement Distance at 3m				Horizontal polarity	
Freq.	Reading	AF	Cable Loss	Pre-amp	Filter	Level	Limit	Margin	Mark
(MHz)	(dBμV)	(dB/m)	(dB)	(dB)	(dB)	(dBμV/m)	(dBμV/m)	(dB)	(P/Q/A)
2406.00	94.59	29.83	2.62	41.10	0.00	85.94	114.00	-28.06	P
2406.00	74.59	29.83	2.62	41.10	0.00	65.94	94.00	-28.06	A
2400.00	67.11	29.84	2.61	41.10	1.24	59.71	74.00	-14.29	P
2400.00	47.11	29.84	2.61	41.10	1.24	39.71	54.00	-14.29	A
* 4812.22	71.68	33.14	3.73	42.37	0.69	66.86	74.00	-7.14	P
* 4812.22	51.68	33.14	3.73	42.37	0.69	46.86	54.00	-7.14	A
7218.88	54.64	38.56	4.67	41.87	1.40	57.39	74.00	-16.61	P
7218.88	34.64	38.56	4.67	41.87	1.40	37.39	54.00	-16.61	A

**Remark:**

1. AF: Antenna Factor, Cable: Cable Loss, Pre-Amp: Preamplifier gain, Filter: 2.4GHz ~ 2.5GHz Filter Insertion Loss
2. Spectrum analyzer setting P(Peak): RBW=1MHz, VBW=1MHz, A(Average): P(Peak)+Duty Factor
3. The result basic equation calculation is as follow:  
Level = Reading + AF + Cable – Preamp + Filter, Margin = Level-Limit
4. The other emission levels were 20dB below the limit
5. The test limit distance is 3M limit.



<b>Product Name</b>	Wireless Mouse	<b>Test Date</b>	Dec. 04, 2011
<b>Model</b>	JF-04	<b>Test By</b>	John Chen
<b>Test Mode</b>	TX (CH Mid)	<b>Temp&amp; Humidity</b>	25.1 , 52%

## Horizontal

TX mode / CH Mid				Measurement Distance at 3m				Horizontal polarity	
Freq.	Reading	AF	Cable Loss	Pre-amp	Filter	Level	Limit	Margin	Mark
(MHz)	(dB $\mu$ V)	(dB/m)	(dB)	(dB)	(dB)	(dB $\mu$ V/m)	(dB $\mu$ V/m)	(dB)	(P/Q/A)
2437.00	99.49	29.79	2.63	41.10	0.00	90.81	114.00	-23.19	P
2437.00	79.49	29.79	2.63	41.10	0.00	70.81	94.00	-23.19	A
* 4874.31	72.42	33.32	3.74	42.43	0.71	67.77	74.00	-6.23	P
* 4874.31	52.42	33.32	3.74	42.43	0.71	47.77	54.00	-6.23	A
* 7311.46	56.29	38.83	4.71	41.72	1.60	59.71	74.00	-14.29	P
* 7311.46	36.29	38.83	4.71	41.72	1.60	39.71	54.00	-14.29	A

<b>Product Name</b>	Wireless Mouse	<b>Test Date</b>	Dec. 04, 2011
<b>Model</b>	JF-04	<b>Test By</b>	John Chen
<b>Test Mode</b>	TX (CH Mid)	<b>Temp&amp; Humidity</b>	25.1 , 52%

## Vertical

TX mode / CH Mid				Measurement Distance at 3m				Horizontal polarity	
Freq.	Reading	AF	Cable Loss	Pre-amp	Filter	Level	Limit	Margin	Mark
(MHz)	(dB $\mu$ V)	(dB/m)	(dB)	(dB)	(dB)	(dB $\mu$ V/m)	(dB $\mu$ V/m)	(dB)	(P/Q/A)
2437.00	93.40	29.79	2.63	41.10	0.00	84.72	114.00	-29.28	P
2437.00	73.40	29.79	2.63	41.10	0.00	64.72	94.00	-29.28	A
* 4873.82	72.15	33.32	3.74	42.43	0.71	67.49	74.00	-6.51	P
* 4873.82	52.15	33.32	3.74	42.43	0.71	47.49	54.00	-6.51	A
* 7311.12	55.51	38.83	4.71	41.72	1.60	58.92	74.00	-15.08	P
* 7311.12	35.51	38.83	4.71	41.72	1.60	38.92	54.00	-15.08	A

**Remark:**

1. AF: Antenna Factor, Cable: Cable Loss, Pre-Amp: Preamplifier gain, Filter: 2.4GHz ~ 2.5GHz Filter Insertion Loss
2. Spectrum analyzer setting P(Peak): RBW=1MHz, VBW=1MHz, A(Average): P(Peak)+Duty Factor
3. The result basic equation calculation is as follow:  
Level = Reading + AF + Cable – Preamp + Filter, Margin = Level-Limit
4. The other emission levels were 20dB below the limit
5. The test limit distance is 3M limit.



<b>Product Name</b>	Wireless Mouse	<b>Test Date</b>	Dec. 04, 2011
<b>Model</b>	JF-04	<b>Test By</b>	John Chen
<b>Test Mode</b>	TX (CH High)	<b>Temp&amp; Humidity</b>	25.1 , 52%

## Horizontal

TX mode / CH High				Measurement Distance at 3m				Horizontal polarity	
Freq.	Reading	AF	Cable Loss	Pre-amp	Filter	Level	Limit	Margin	Mark
(MHz)	(dBμV)	(dB/m)	(dB)	(dB)	(dB)	(dBμV/m)	(dBμV/m)	(dB)	(P/Q/A)
2468.00	98.24	29.74	2.65	41.11	0.00	89.52	114.00	-24.48	P
2468.00	78.24	29.74	2.65	41.11	0.00	69.52	94.00	-24.48	A
* 4936.42	73.72	33.51	3.76	42.50	0.74	69.23	74.00	-4.77	P
* 4936.42	53.72	33.51	3.76	42.50	0.74	49.23	54.00	-4.77	A
* 7404.18	55.43	39.11	4.75	41.58	1.79	59.51	74.00	-14.49	P
* 7404.18	35.43	39.11	4.75	41.58	1.79	39.51	54.00	-14.49	A

<b>Product Name</b>	Wireless Mouse	<b>Test Date</b>	Dec. 04, 2011
<b>Model</b>	JF-04	<b>Test By</b>	John Chen
<b>Test Mode</b>	TX (CH High)	<b>Temp&amp; Humidity</b>	25.1 , 52%

## Vertical

TX mode / CH High				Measurement Distance at 3m				Horizontal polarity	
Freq.	Reading	AF	Cable Loss	Pre-amp	Filter	Level	Limit	Margin	Mark
(MHz)	(dBμV)	(dB/m)	(dB)	(dB)	(dB)	(dBμV/m)	(dBμV/m)	(dB)	(P/Q/A)
2468.00	93.34	29.74	2.65	41.11	0.00	84.62	114.00	-29.38	P
2468.00	73.34	29.74	2.65	41.11	0.00	64.62	94.00	-29.38	A
* 4936.57	73.62	33.51	3.76	42.50	0.74	69.13	74.00	-4.87	P
* 4936.57	53.62	33.51	3.76	42.50	0.74	49.13	54.00	-4.87	A
* 7403.90	53.99	39.11	4.75	41.58	1.79	58.07	74.00	-15.93	P
* 7403.90	33.99	39.11	4.75	41.58	1.79	38.07	54.00	-15.93	A

**Remark:**

1. AF: Antenna Factor, Cable: Cable Loss, Pre-Amp: Preamplifier gain, Filter: 2.4GHz ~ 2.5GHz Filter Insertion Loss
2. Spectrum analyzer setting P(Peak): RBW=1MHz, VBW=1MHz, A(Average): P(Peak)+Duty Factor
3. The result basic equation calculation is as follow:  
Level = Reading + AF + Cable – Preamp + Filter, Margin = Level-Limit
4. The other emission levels were 20dB below the limit
5. The test limit distance is 3M limit.



## 7.4 DUTY CYCLE CORRECTION FACTOR

### LIMIT

Nil (No dedicated limit specified in the Rules)

### Test Configuration

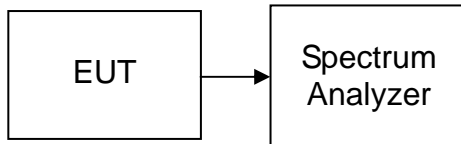

### TEST PROCEDURE

1. Set EUT in transmitting mode.
2. Set center frequency of spectrum analyzer = operating frequency.
3. Set the spectrum analyzer as RBW, VBW=1MHz, Span = 0Hz, Adjust suitable Sweep Time to test.
4. Repeat above procedures until all frequency measured were complete.

### TEST RESULTS

No non-compliance noted

### Test Data

	us	Times	Ton	Total Ton time(ms)
Ton1	126.253	16	2020.040	2.020
Ton2		0	0.000	
Ton3		0	0.000	
TP				65.731

Ton	2.020
TP(Ton+Toff)	65.731
Duty Cycle	0.031
Duty Factor	-20.000



**Test Plot**

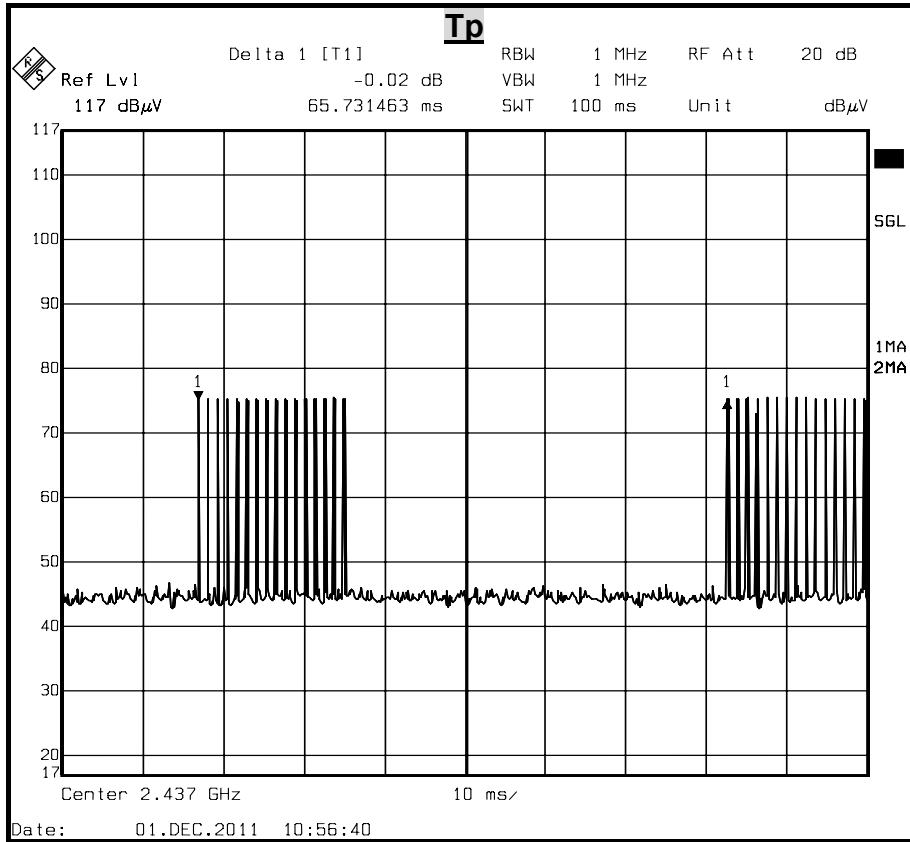

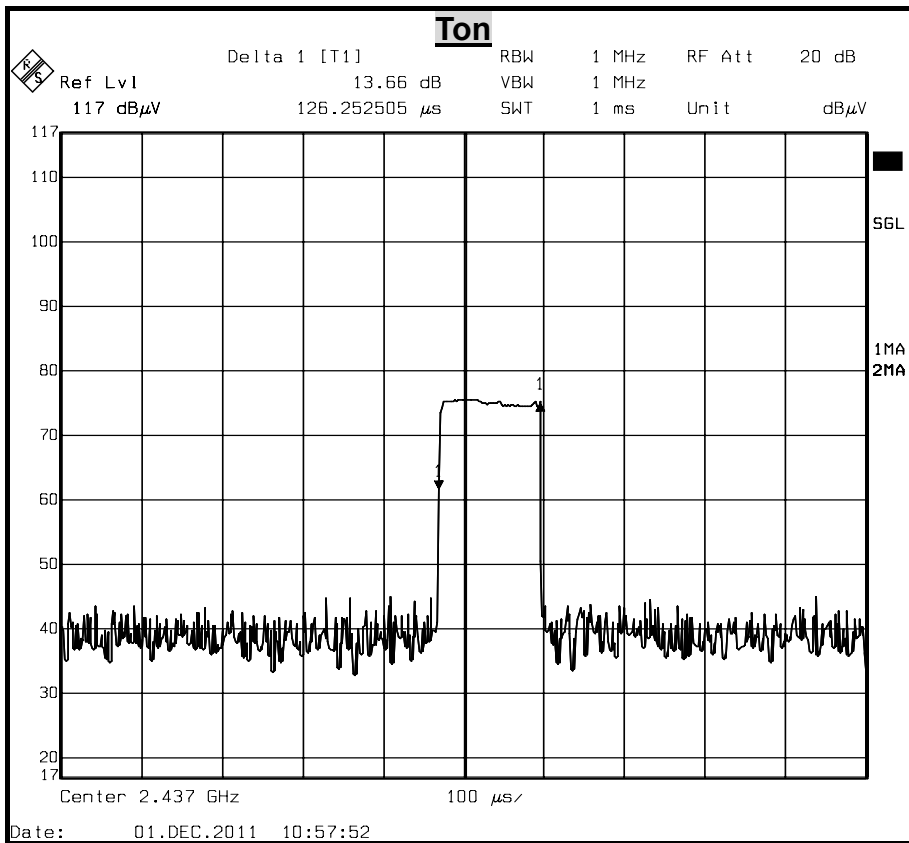
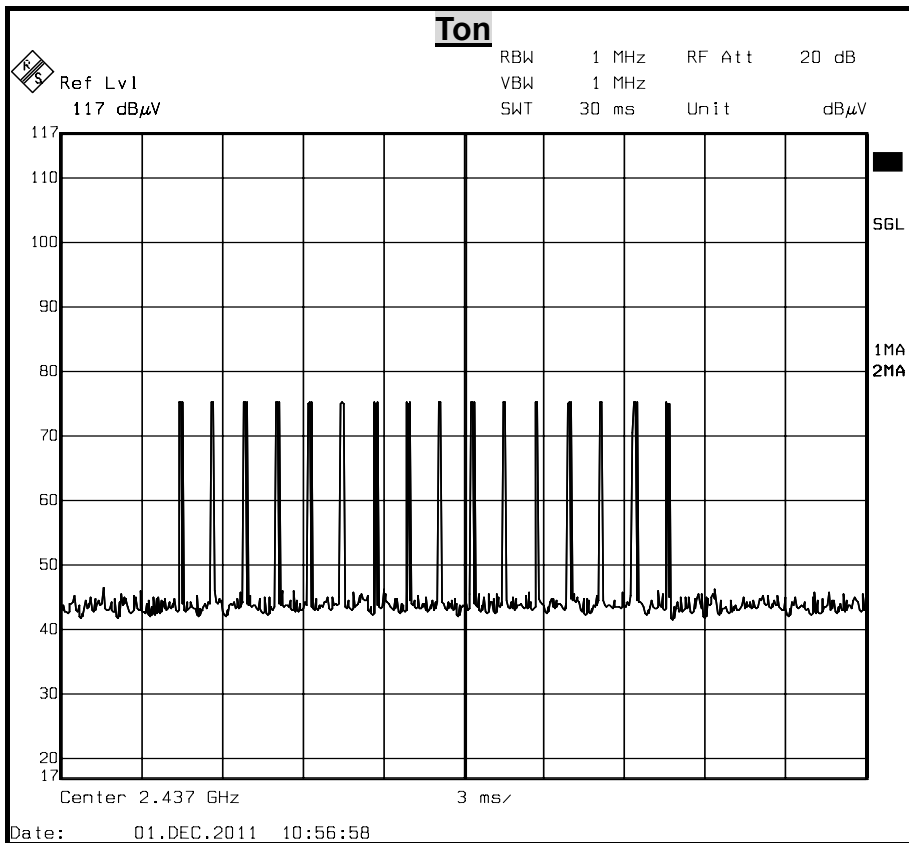



## 7.5 POWERLINE CONDUCTED EMISSIONS

### LIMIT

According to §15.207(a), except as shown in paragraphs (b) and (c) of this section, for an intentional radiator that is designed to be connected to the public utility (AC) power line, the radio frequency voltage that is conducted back onto the AC power line on any frequency or frequencies within the band 150 kHz to 30 MHz shall not exceed the limits in the following table, as measured using a 50  $\mu$ H/50 ohms line impedance stabilization network (LISN). Compliance with the provisions of this paragraph shall be based on the measurement of the radio frequency voltage between each power line and ground at the power terminal. The lower limit applies at the boundary between the frequency ranges.

Frequency Range (MHz)	Limits (dB $\mu$ V)	
	Quasi-peak	Average
0.15 to 0.50	66 to 56*	56 to 46*
0.50 to 5	56	46
5 to 30	60	50

\* Decreases with the logarithm of the frequency.

### TEST EQUIPMENTS

Conducted Emission room				
Name of Equipment	Manufacturer	Model	Serial Number	Calibration Due
L.I.S.N.	SCHWARZBECK	NNLK 8121	8121-308	SEP. 06, 2012
TEST RECEIVER	Rohde & Schwarz	ESCS 30	100348	JUL. 03, 2012
BNC COAXIAL CABLE	CCS	BNC50	11	OCT. 04, 2012
Test S/W	e-3 (5.04211c) R&S (2.27)			

**Remark:** Each piece of equipment is scheduled for calibration once a year.





## TEST SETUP

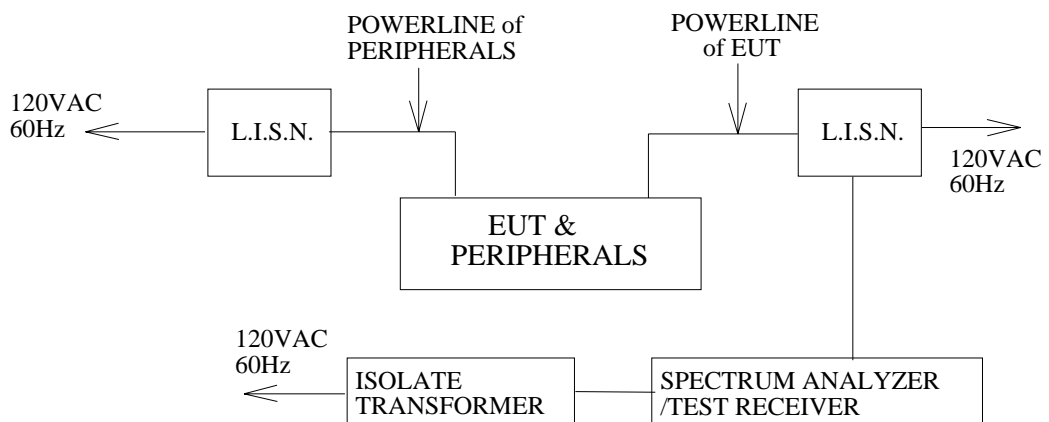
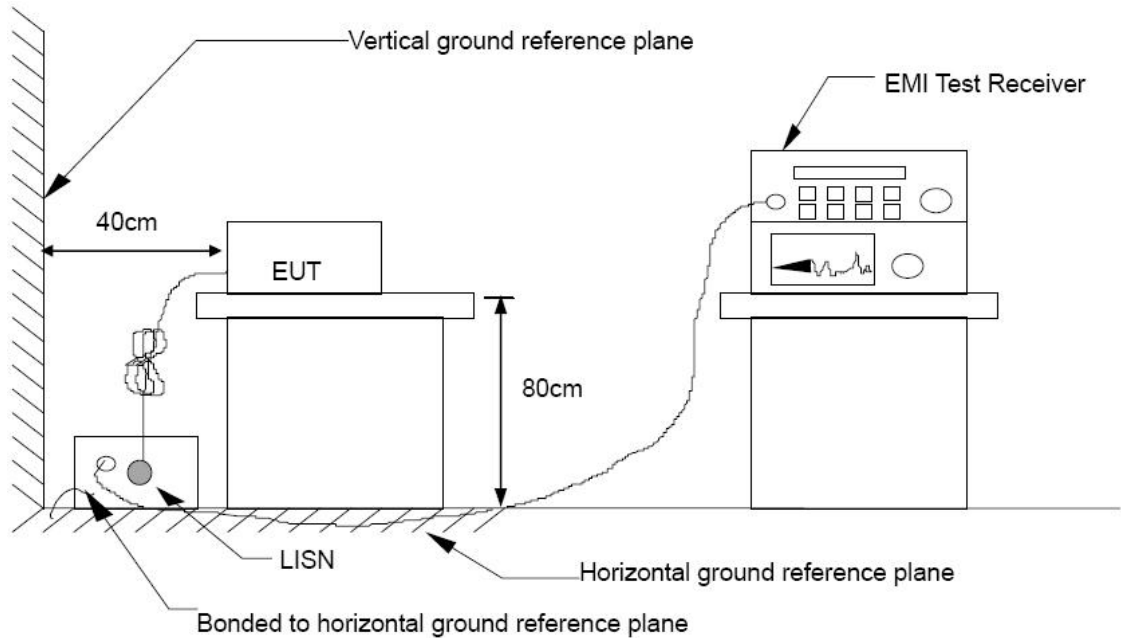

## TEST PROCEDURE

1. The EUT was placed on a table, which is 0.8m above ground plane.
2. Maximum procedure was performed on the six highest emissions to ensure EUT compliance.
3. Repeat above procedures until all frequency measured were complete.



## TEST RESULTS

<b>Product Name</b>	Wireless Mouse	<b>Test Date</b>	Nov. 17, 2011
<b>Model Name</b>	JF-04	<b>Test By</b>	Ted Huang
<b>Test Mode</b>	Charge Mode	<b>Temp &amp; Humidity</b>	25.4 , 65%

### LINE

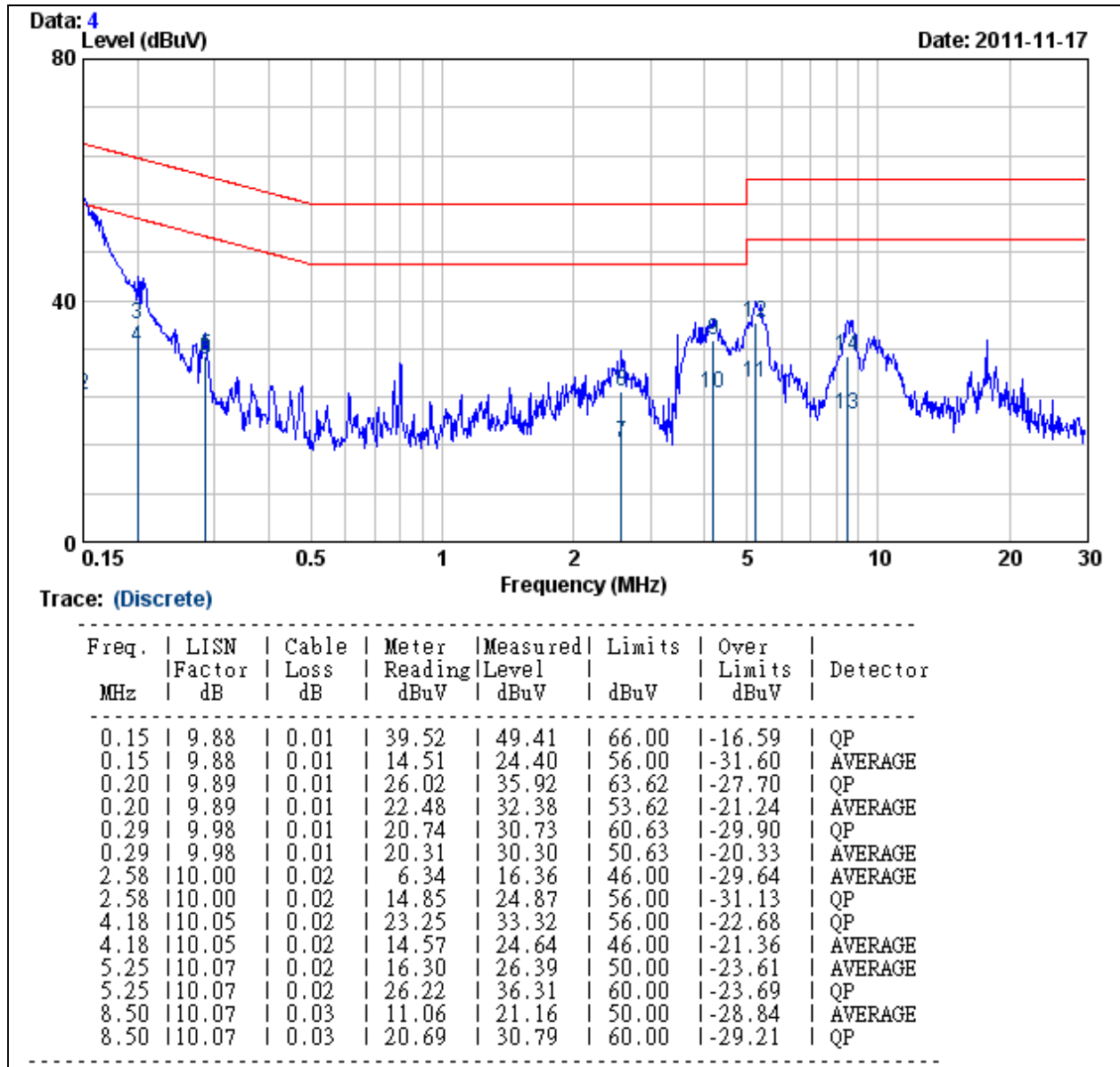

#### Remark:

1. Correction Factor = Insertion loss + cable loss
2. Margin value = Emission level – Limit value



<b>Product Name</b>	Wireless Mouse	<b>Test Date</b>	Nov. 17, 2011
<b>Model Name</b>	JF-04	<b>Test By</b>	Ted Huang
<b>Test Mode</b>	Charge Mode	<b>Temp &amp; Humidity</b>	25.4 , 65%

NEUTRAL

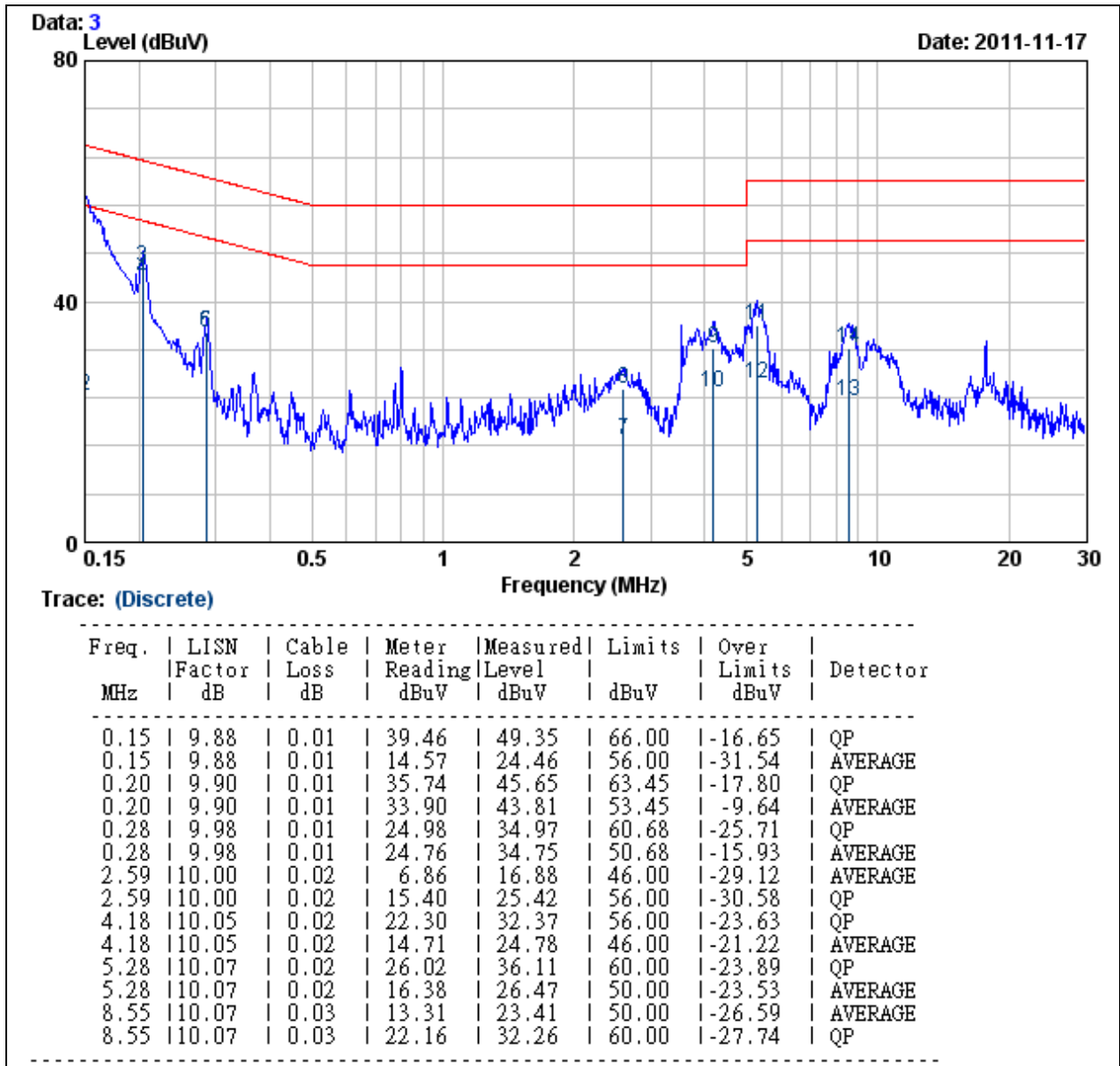

Remark:

1. Correction Factor = Insertion loss + cable loss
2. Margin value = Emission level – Limit value