



FCC ID: GDDJD-856M  
Report No.: T210120N02-RP1

Page: 1 / 47  
Rev.: 00

# FCC 47 CFR PART 15 SUBPART C ANSI C63.10: 2013

## TEST REPORT

For

### CHERRY Stream Desktop Recharge - Mouse

**Model: JD-856M**

**Brand: CHERRY**

Test Report Number:  
T210120N02-RP1

Issued to

**CHERRY GmbH**

Cherrystraße, 91275 Auerbach, Deutschland/Germany

Issued by

**Compliance Certification Services Inc.**

**Tainan Lab.**

**No.8, Jiucengling, Xinhua Dist.,**

**Tainan City, Taiwan**

**Issued Date: May 11, 2021**

---

**Note:** This report shall not be reproduced except in full, without the written approval of Compliance Certification Services Inc. Ltd. This document may be altered or revised by Compliance Certification Services Inc. personnel only, and shall be noted in the revision section of the document

Unless otherwise stated the results shown in this test report refer only to the sample(s) tested and such sample(s) are retained for 90 days only.  
除非另有說明，此報告結果僅對測試之樣品負責，同時此樣品僅保留90天。本報告未經本公司書面許可，不可部份複製。

This document is issued by the Company subject to its General Conditions of Service printed overleaf, available on request or accessible at <http://www.sgs.com.tw/Terms-and-Conditions> and, for electronic format documents, subject to Terms and Conditions for Electronic Documents at <http://www.sgs.com.tw/Terms-and-Conditions>. Attention is drawn to the limitation of liability, indemnification and jurisdiction issues defined therein. Any holder of this document is advised that information contained hereon reflects the Company's findings at the time of its intervention only and within the limits of client's instruction, if any. The Company's sole responsibility is to its Client and this document does not exonerate parties to a transaction from exercising all their rights and obligations under the transaction documents. This document cannot be reproduced, except in full, without prior written approval of the Company. Any unauthorized alteration, forgery or falsification of the content or appearance of this document is unlawful and offenders may be prosecuted to the fullest extent of the law.

**REVISION HISTORY**

Rev.	Issue Date	Revisions	Effect Page	Revised By
00	May 11, 2021	Initial Issue	ALL	Polly Wang

## TABLE OF CONTENTS

<b>1. TEST RESULT CERTIFICATION .....</b>	<b>4</b>
<b>2. EUT DESCRIPTION.....</b>	<b>5</b>
<b>3. TEST METHODOLOGY .....</b>	<b>6</b>
3.1 EUT CONFIGURATION .....	6
3.2 EUT EXERCISE .....	6
3.3 GENERAL TEST PROCEDURES .....	6
3.4 FCC PART 15.205 RESTRICTED BANDS OF OPERATIONS .....	7
3.5 DESCRIPTION OF TEST MODES .....	7
<b>4. INSTRUMENT CALIBRATION .....</b>	<b>8</b>
4.1 MEASURING INSTRUMENT CALIBRATION.....	8
4.2 MEASUREMENT EQUIPMENT USED .....	8
4.3 MEASUREMENT UNCERTAINTY .....	9
<b>5. FACILITIES AND ACCREDITATIONS .....</b>	<b>10</b>
5.1 FACILITIES .....	10
5.2 EQUIPMENT .....	10
5.3 LABORATORY ACCREDITATIONS LISTING.....	10
5.4 TABLE OF ACCREDITATIONS AND LISTINGS.....	11
<b>6. SETUP OF EQUIPMENT UNDER TEST .....</b>	<b>12</b>
6.1 SETUP CONFIGURATION OF EUT .....	12
6.2 SUPPORT EQUIPMENT .....	12
6.3 CONFIGURATION OF SYSTEM UNDER TEST .....	13
6.4 EUT OPERATING CONDITION .....	14
<b>7. FCC PART 15.249 REQUIREMENTS.....</b>	<b>15</b>
7.1 20 dB BANDWIDTH .....	15
7.2 BAND EDGES MEASUREMENT .....	19
7.3 DUTY CYCLE.....	25
7.4 SPURIOUS EMISSION .....	29
7.5 POWERLINE CONDUCTED EMISSIONS .....	43
<b>APPENDIX I - PHOTOGRAPHS OF TEST SETUP.....</b>	<b>44</b>

Report No.: T210120N02-RP1

# 1. TEST RESULT CERTIFICATION

<b>Product:</b>	CHERRY Stream Desktop Recharge - Mouse
<b>Model:</b>	JD-856M
<b>Brand Name:</b>	CHERRY
<b>Applicant:</b>	<b>CHERRY GmbH</b> Cherrystraße, 91275 Auerbach, Deutschland/Germany
<b>Manufacturer:</b>	<b>Jing Mold Electronic Tech. (Shen Zhen) Co., Ltd.</b> Xin Qiao 3rd Industrial Estate, Sha Jing, Bao An, Shenzhen, Guangdong, P.R. China
<b>Tested:</b>	February 24, 2021

APPLICABLE STANDARDS	
STANDARD	TEST RESULT
FCC 47 CFR Part 15 Subpart C ANSI C63.10: 2013	No non-compliance noted

**Statements of Conformity**

Determining compliance shall be based on the results of the compliance measurement, not taking into account measurement instrumentation uncertainty.

FCC Standard Section	Report Section	Test Item	Result
-	7.1	20dB BANDWIDTH	Pass
15.249(e)	7.2	BAND EDGES MEASUREMENT	Pass
-	7.3	DUTY CYCLE	Pass
15.249(a)	7.4	SPURIOUS EMISSION	Pass
15.207(a)	7.5	POWERLINE CONDUCTED EMISSIONS	Pass

**We hereby certify that:**

The above equipment was tested by Compliance Certification Services Inc. The test data, data evaluation, test procedures, and equipment configurations shown in this report were made in accordance with the procedures given in ANSI C63.10: 2013 and the energy emitted by the sample EUT tested as described in this report is in compliance with the requirements emission limits of FCC Rules Part 15.107, 15.109, 15.207, 15.209 and 15.249. The test results of this report relate only to the tested sample identified in this report.

*Approved by:*

**Eric Huang**  
Section Manager

## 2. EUT DESCRIPTION

<b>Product</b>	CHERRY Stream Desktop Recharge - Mouse
<b>Model Number</b>	JD-856M
<b>Brand Name</b>	CHERRY
<b>Received Date</b>	January 20, 2021
<b>Reported Date</b>	March 17, 2021
<b>Operation Frequency</b>	2406 MHz ~ 2476 MHz
<b>Transmit Peak Power</b>	101.808 dBuV/m
<b>Transmit Data Rate</b>	2Mbps
<b>Type of Modulation</b>	GFSK
<b>Number of Channels</b>	71 Channels
<b>Power Supply</b>	DC 1.2V, 20mA
<b>Antenna Type</b>	Type: PCB Antenna Model: N/A Manufacturer: Sunrex Gain: 0.37 dBi
<b>RF Module Model</b>	nRF51802
<b>Firmware Version</b>	V06
<b>Software Version</b>	N/A
<b>Temperature Range</b>	0°C ~ +40°C

### Remark:

1. Client consigns only one model sample to test (Model Number: **JD-856M**). Therefore, the testing Lab. just guarantees the unit, which has been tested.
2. This submittal(s) (test report) is intended for FCC ID: **GDDJD-856M** filing to comply with Section 15.107 & 15.109 (FCC Part 15, Subpart B) and Section 15.207, 15.209, 15.249.
3. For more details, please refer to the User's manual of the EUT.
4. According to customer declaration CHERRY Stream Desktop Recharge -Receiver (**JD-856R / FCC ID: GDDJD-856R**) for sale.

### 3. TEST METHODOLOGY

The tests documented in this report were performed in accordance with ANSI C63.10 and FCC CFR 47 2.1046, 2.1047, 2.1049, 2.1051, 2.1053, 2.1055, 2.1057, 15.207, 15.209 and 15.249.

#### 3.1 EUT CONFIGURATION

The EUT configuration for testing is installed on RF field strength measurement to meet the Commissions requirement and operating in a manner that intends to maximize its emission characteristics in a continuous normal application.

#### 3.2 EUT EXERCISE

The EUT was operated in the engineering mode to fix the TX frequency that was for the purpose of the measurements.

According to its specifications, the EUT must comply with the requirements of the Section 15.107 and 15.109 under the FCC Rules Part 15 Subpart B and Section 15.207, 15.209, 15.249 under the FCC Rules Part 15 Subpart C.

#### 3.3 GENERAL TEST PROCEDURES

##### Conducted Emissions

The EUT is placed on the turntable, which is 0.8 m above ground plane. According to the requirements in Section 13.1.4.1 of ANSI C63.10 Conducted emissions from the EUT measured in the frequency range between 0.15 MHz and 30MHz using CISPR Quasi-peak and average detector modes.

##### Radiated Emissions

The EUT is placed on a turn table, which is 1.5 m above ground plane. The turntable shall rotate 360 degrees to determine the position of maximum emission level. EUT is set 3m away from the receiving antenna, which varied from 1m to 4m to find out the highest emission. And also, each emission was to be maximized by changing the polarization of receiving antenna both horizontal and vertical. In order to find out the maximum emissions, exploratory radiated emission measurements were made according to the requirements in Section 13.1.4.1 of ANSI C63.10.

Report No.: T210120N02-RP1

### 3.4 FCC PART 15.205 RESTRICTED BANDS OF OPERATIONS

1. Except as shown in paragraph (d) of this section, only spurious emissions are permitted in any of the frequency bands listed below:

MHz	MHz	MHz	GHz
0.090 - 0.110	16.42 - 16.423	399.9 - 410	4.5 - 5.15
<sup>1</sup> 0.495 - 0.505	16.69475 - 16.69525	608 - 614	5.35 - 5.46
2.1735 - 2.1905	16.80425 - 16.80475	960 - 1240	7.25 - 7.75
4.125 - 4.128	25.5 - 25.67	1300 - 1427	8.025 - 8.5
4.17725 - 4.17775	37.5 - 38.25	1435 - 1626.5	9.0 - 9.2
4.20725 - 4.20775	73 - 74.6	1645.5 - 1646.5	9.3 - 9.5
6.215 - 6.218	74.8 - 75.2	1660 - 1710	10.6 - 12.7
6.26775 - 6.26825	108 - 121.94	1718.8 - 1722.2	13.25 - 13.4
6.31175 - 6.31225	123 - 138	2200 - 2300	14.47 - 14.5
8.291 - 8.294	149.9 - 150.05	2310 - 2390	15.35 - 16.2
8.362 - 8.366	156.52475 -	2483.5 - 2500	17.7 - 21.4
8.37625 - 8.38675	156.52525	2655 - 2900	22.01 - 23.12
8.41425 - 8.41475	156.7 - 156.9	3260 - 3267	23.6 - 24.0
12.29 - 12.293	162.0125 - 167.17	3332 - 3339	31.2 - 31.8
12.51975 - 12.52025	167.72 - 173.2	3345.8 - 3358	36.43 - 36.5
12.57675 - 12.57725	240 - 285	3600 - 4400	( <sup>2</sup> )
13.36 - 13.41	322 - 335.4		

<sup>1</sup> Until February 1, 1999, this restricted band shall be 0.490-0.510 MHz.

<sup>2</sup> Above 38.6

2. Except as provided in paragraphs (d) and (e), the field strength of emissions appearing within these frequency bands shall not exceed the limits shown in Section 15.209. At frequencies equal to or less than 1000 MHz, compliance with the limits in Section 15.209 shall be demonstrated using measurement instrumentation employing a CISPR quasi-peak detector. Above 1000 MHz, compliance with the emission limits in Section 15.209 shall be demonstrated based on the average value of the measured emissions. The provisions in Section 15.35 apply to these measurements.

### 3.5 DESCRIPTION OF TEST MODES

The EUT ( **Model: JD-856M** ) had been tested under engineering test mode condition and the EUT staying in continuous transmitting mode.

## 4. INSTRUMENT CALIBRATION

### 4.1 MEASURING INSTRUMENT CALIBRATION

The measuring equipment, which was utilized in performing the tests documented herein, has been calibrated in accordance with the manufacturer's recommendations for utilizing calibration equipment, which is traceable to recognized national standards.

### 4.2 MEASUREMENT EQUIPMENT USED

#### Equipment Used for Emissions Measurement

Chamber Room #966					
Name of Equipment	Manufacturer	Model	Serial Number	Calibration Date	Calibration Due
Active Loop Antenna	ETS-LINDREN	6502	8905-2356	08/02/2019	08/01/2021
Bilog Antenna With 6dB Attenuator	SUNOL SCIENCES & EMCI	JB1 & AT-N0681	A070506-1 & AT-N0681	09/14/2020	09/13/2021
Cable	Suhner	SUCOFLEX104 PEA	20520/4PEA&O6	01/29/2021	01/28/2022
Double Ridged Guide Horn Antenna	ETS-LINDGREN	3116	00078900	03/26/2020	03/25/2021
EMI Test Receiver	R&S	ESCI	100960	02/05/2021	02/04/2022
EXA Spectrum Analyzer	KEYSIGHT	N9010A	MY54430216	07/20/2020	07/19/2021
Horn Antenna	Com-Power	AH-118	071032	04/29/2020	04/28/2021
Pre-Amplifier	EMCI	EMC012645	980098	01/29/2021	01/28/2022
Pre-Amplifier	HP	8447F	2443A01683	01/19/2021	01/18/2022
Pre-Amplifier	Com-Power	PAM-840A	461378	07/20/2020	07/19/2021
Type N coaxial cable	Suhner	CHA9513	6	01/19/2021	01/18/2022
Notch Filter	MICRO-TRONICS	BRM50702-01	018	N.C.R	N.C.R
Software	Excel(ccs-o6-2020 v1.1) , e3(v6.101222)				

#### Equipment Used for POWERLINE CONDUCTED EMISSIONS

Conducted Emission room #1					
Name of Equipment	Manufacturer	Model	Serial Number	Calibration Date	Calibration Due
-	-	-	-	-	-
-	-	-	-	-	-
-	-	-	-	-	-
-	-	-	-	-	-
-	-	-	-	-	-
Test S/W	-				



### 4.3 MEASUREMENT UNCERTAINTY

PARAMETER	UNCERTAINTY
Radiated Emission, 30 to 200 MHz Test Site : OATS-6	±3.3456dB
Radiated Emission, 200 to 1000 MHz Test Site : OATS-6	±2.6828dB
Radiated Emission, 1 to 8 GHz	± 2.6485dB
Radiated Emission, 8 to 18 GHz	± 2.6852dB
Radiated Emission, 18 to 26.5 GHz	± 2.6485dB
Radiated Emission, 26 to 40 GHz	± 3.0295dB
Power Line Conducted Emission	±1.91dB
Band Width	136.49kHz
Peak Output Power MU	±1.904dB
Band Edge MU	±0.302dBuV
Channel Separation MU	361.69Hz
Duty Cycle MU	0.064ms
Frequency Stability MU	0.223kHz

Uncertainty figures are valid to a confidence level of 95%, k=2

## 5. FACILITIES AND ACCREDITATIONS

### 5.1 FACILITIES

All measurement facilities used to collect the measurement data are located at

No.8, Jiucengling, Xinhua Dist., Tainan City 712, Taiwan (R.O.C.)

The sites are constructed in conformance with the requirements of ANSI C63.7:1992, ANSI C63.10: 2013 and CISPR Publication 22.

### 5.2 EQUIPMENT

Radiated emissions are measured with one or more of the following types of linearly polarized antennas: tuned dipole, biconical, log periodic, bi-log, and/or ridged waveguide, horn. Spectrum analyzers with pre-selectors and quasi-peak detectors are used to perform radiated measurements.

Conducted emissions are measured with Line Impedance Stabilization Networks and EMI Test Receivers.

Calibrated wideband preamplifiers, coaxial cables, and coaxial attenuators are also used for making measurements.

All receiving equipment conforms to CISPR Publication 16-1, "Radio Interference Measuring Apparatus and Measurement Methods."

### 5.3 LABORATORY ACCREDITATIONS LISTING

The test facilities used to perform radiated and conducted emissions tests are accredited by Taiwan Accreditation Foundation for the specific scope of accreditation under Lab Code: 1109 to perform Electromagnetic Interference tests according to FCC PART 15 AND CISPR 22 requirements. No part of this report may be used to claim or imply product endorsement by TAF or any agency of the Government. In addition, the test facilities are listed with Federal Communications Commission (registration no: TW1109).

## 5.4 TABLE OF ACCREDITATIONS AND LISTINGS

Our laboratories are accredited and approved by the following accreditation body according to ISO/IEC 17025.

<b>Taiwan</b>	TAF
---------------	-----

The measuring facility of laboratories has been authorized or registered by the following approval agencies.

<b>Canada</b>	Industry Canada (TW1109)
<b>Germany</b>	TUV NORD
<b>Taiwan</b>	BSMI
<b>USA</b>	FCC
<b>Japan</b>	VCCI

Copies of granted accreditation certificates are available for downloading from our web site, <http://www.ccsrf.com>

## 6. SETUP OF EQUIPMENT UNDER TEST

### 6.1 SETUP CONFIGURATION OF EUT

See test photographs attached in Appendix I for the actual connections between EUT and support equipment.

### 6.2 SUPPORT EQUIPMENT

#### 【RF】

No.	Product	Manufacturer	Model No.	Certify No.	Signal cable
1	Note Book	Acer	AS 3830TG	DOC	DC IN, Unshielded, 1.8m with 1 core. AC IN, Unshielded, 1.8m.

No.	Signal cable description	
A	USB	Shielded, 1.0m, 1pcs.

#### 【EMC】

No.	Product	Manufacturer	Model No.	Certify No.	Signal cable
1	Note Book	TOSHIBA	PORTEGE R30-A	DOC	Unshielded, 1.8m with 1 core.
2	PC	Mavoly	1260B	N/A	N/A
3	Keyboard	CHERRY	JD-856K	N/A	N/A
4	Dongle	CHERRY	JD-856R	N/A	N/A

No.	Signal cable description	
A	DC IN (USB type C)	Unshielded, 1.6m, 1pcs.

#### Remark:

1. All the equipment/cables were placed in the worst-case configuration to maximize the emission during the test.
2. Grounding was established in accordance with the manufacturer's requirements and conditions for the intended use.

## 6.3 CONFIGURATION OF SYSTEM UNDER TEST

### 【RF】

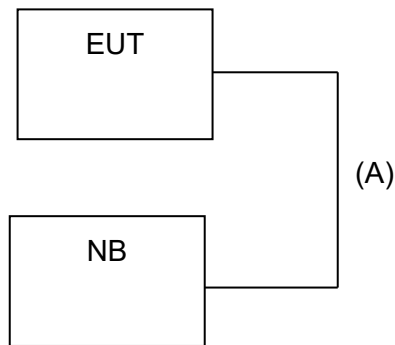

### 【EMC】

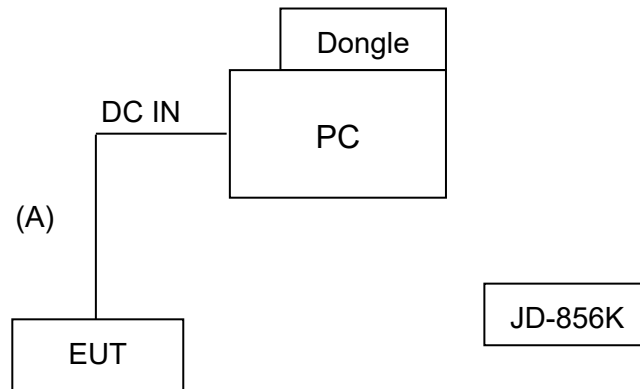

## 6.4 EUT OPERATING CONDITION

### RF Setup

1. Make sure mouse power off
2. Press Left, Right, and Scroll Wheel buttons with power on, continue for 3 seconds and release. (Red LED light keep on)
3. Press Scroll Wheel button into as below function. (Red LED off)
  - (1). Press Right button into Carrier Mode 2406MHz emission, one more time into Carrier Mode 2440MHz emission, one more time into Carrier Mode 2476MHz emission, going cycle.
  - (2). Press Left button into Modulation Mode 2406MHz emission, one more time into Modulation Mode 2440MHz emission, one more time into Modulation Mode 2476MHz emission, going cycle.

## 7. FCC PART 15.249 REQUIREMENTS

### 7.1 20 dB BANDWIDTH

#### LIMIT

None; for reporting purposes only.

#### Test Configuration

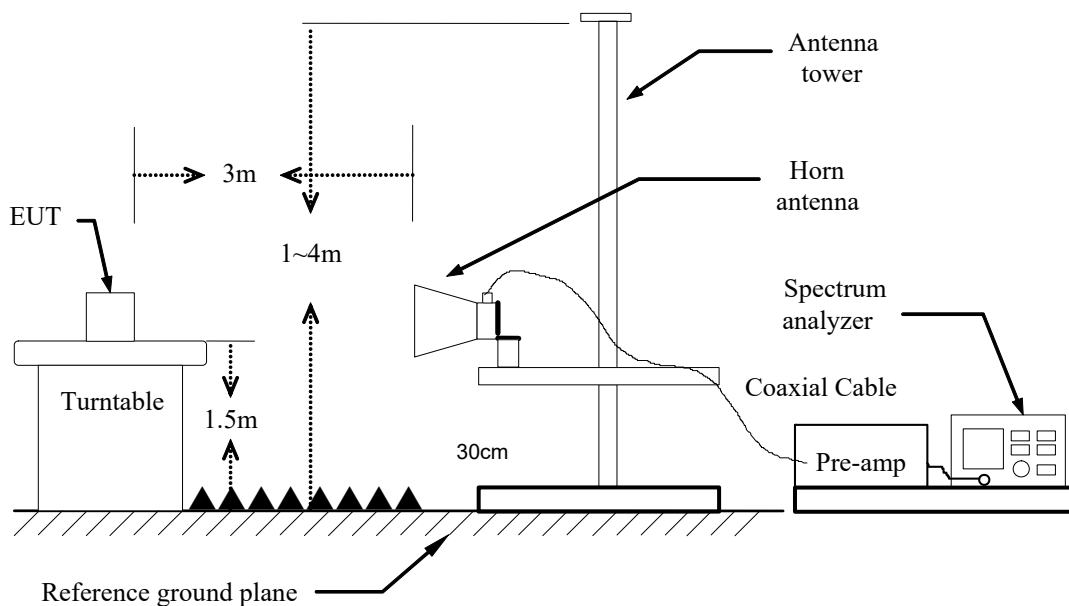

#### TEST PROCEDURE

1. The EUT is placed on a turntable, which is 1.5m above ground plane.
2. The turntable shall be rotated for 360 degrees to determine the position of maximum emission level.
3. EUT is set 3m away from the receiving antenna, which is varied from 1m to 4m to find out the highest emissions.
4. Maximum procedure was performed on the six highest emissions to ensure EUT compliance.
5. And also, each emission was to be maximized by changing the polarization of receiving antenna both horizontal and vertical.
6. Set the spectrum analyzer in the following setting as:  
RBW is set to 10 kHz and VBW is set 300kHz.

**TEST RESULTS**

No non-compliance noted.

**TEST DATA**

**Operation Mode:** TX

**Test Date:** 2021/02/24

**Temperature:** 24.5°C

**Tested by:** Ted Huang

**Humidity:** 52% RH

**Polarity:** Ver. / Hor.

Channel	Frequency (MHz)	20 dB Bandwidth (MHz)
LOW	2406	1.26
MIDDLE	2440	1.22
HIGH	2476	1.29



## TEST PLOT

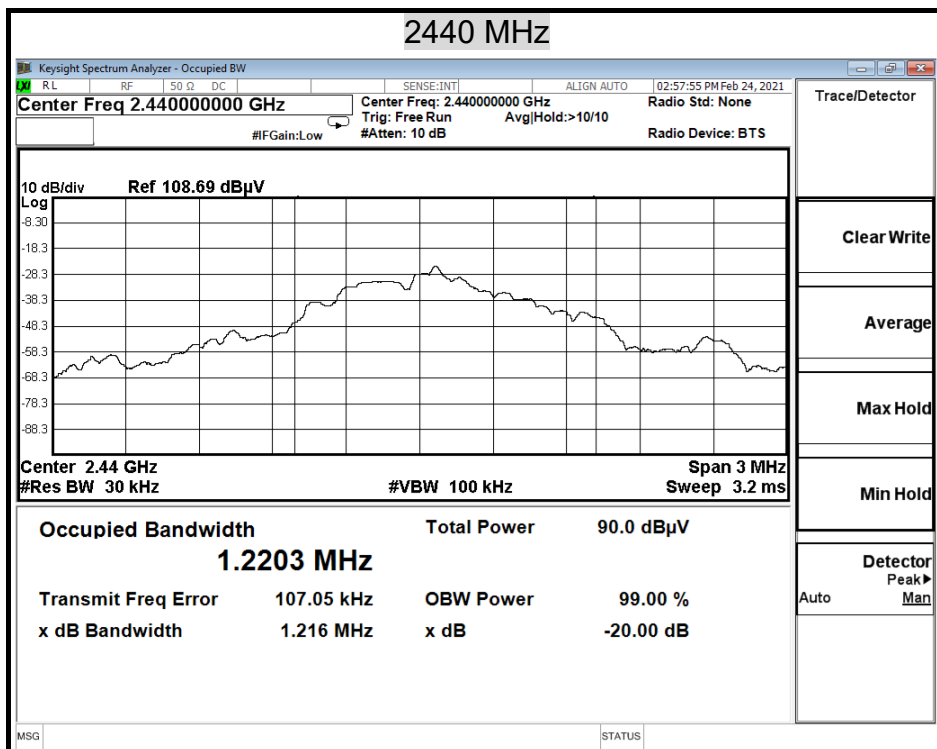
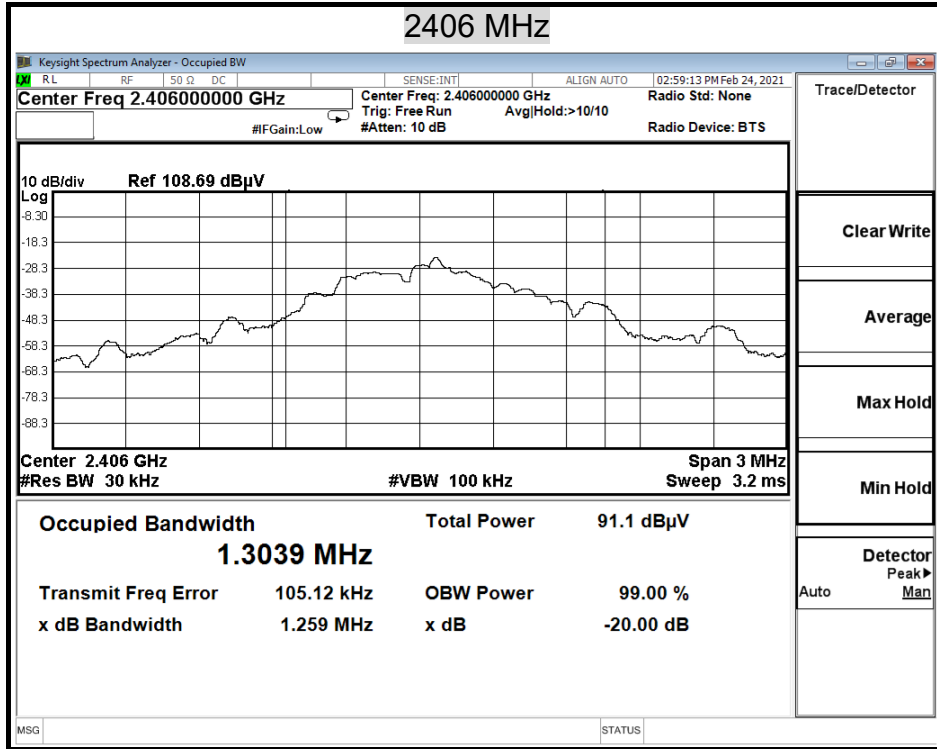

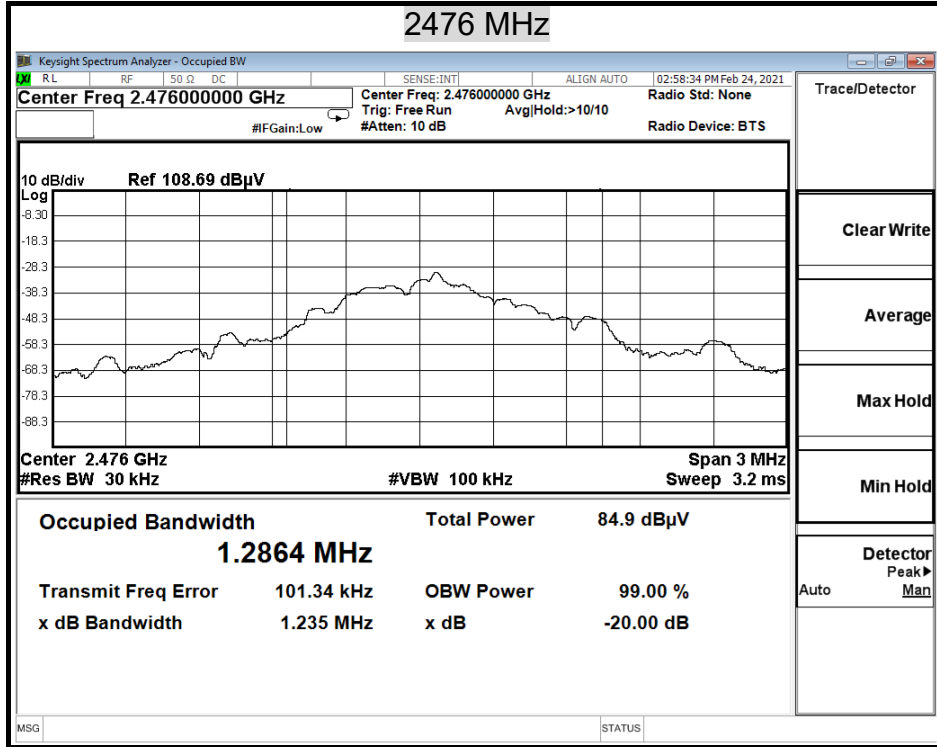

## 7.2 BAND EDGES MEASUREMENT

### LIMIT

1. In the above emission table, the tighter limit applies at the band edges.

Frequency (MHz)	Field Strength ( $\mu\text{V}/\text{m}$ at 3-meter)	Field Strength ( $\text{dB}\mu\text{V}/\text{m}$ at 3-meter)
30-88	100	40
88-216	150	43.5
216-960	200	46
Above 960	500	54

2. As shown in Section 15.35(b), for frequencies above 1000 MHz, the above field strength limits in paragraphs (a) and (b) of this section are based on average limits. However, the peak field strength of any emission shall not exceed the maximum permitted average limits specified above by more than 20 dB under any condition of modulation. For point-to-point operation under paragraph (b) of this section, the peak field strength shall not exceed 2500 millivolts/meter at 3 meters along the antenna azimuth.

### TEST CONFIGURATION

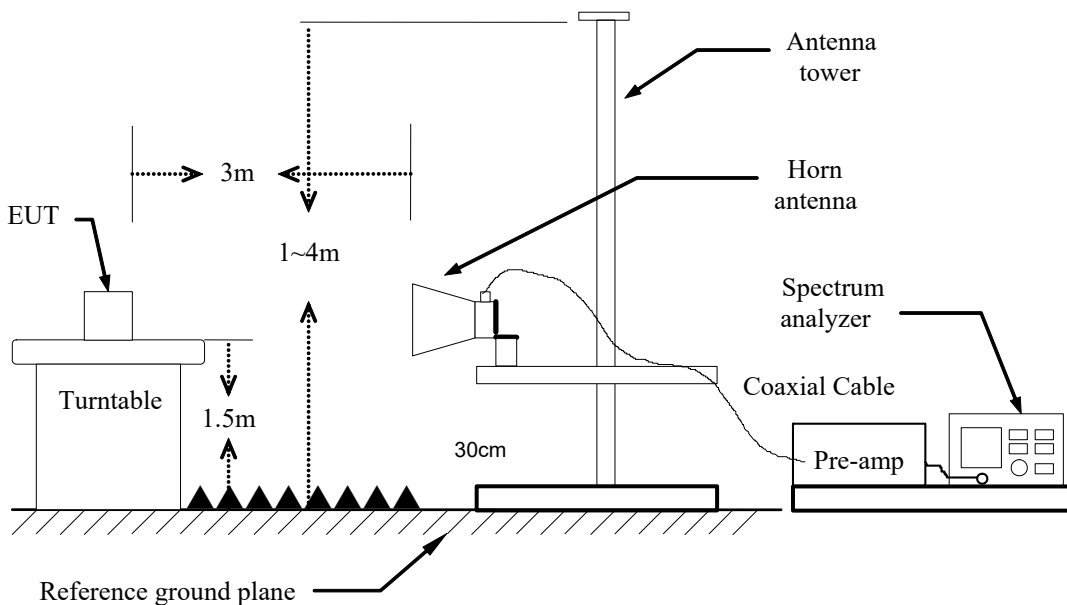

## **TEST PROCEDURE**

1. The EUT is placed on a turntable, which is 1.5m above the ground plane.
2. The turntable shall be rotated for 360 degrees to determine the position of maximum emission level.
3. EUT is set 3m away from the receiving antenna, which is varied from 1m to 4m to find out the highest emission.
4. Set the spectrum analyzer in the following setting in order to capture the lower and upper band-edges of the emission:
  - (a) PEAK: RBW=1MHz , VBW=3MHz / Sweep=AUTO
  - (b) AVERAGE: Peak Level + Duty Factor
5. Repeat the procedures until all the PEAK and AVERAGE versus polarization are measured.

## **TEST RESULTS**

**Operation Mode:** TX

**Temperature:** 24.5°C

**Humidity:** 52% RH

**Test Date:** 2021/02/24

**Tested by:** Ted Huang

**Polarity:** Ver. / Hor.

**TEST PLOT**

**Detector mode : Peak**

**Polarity : Horizontal**

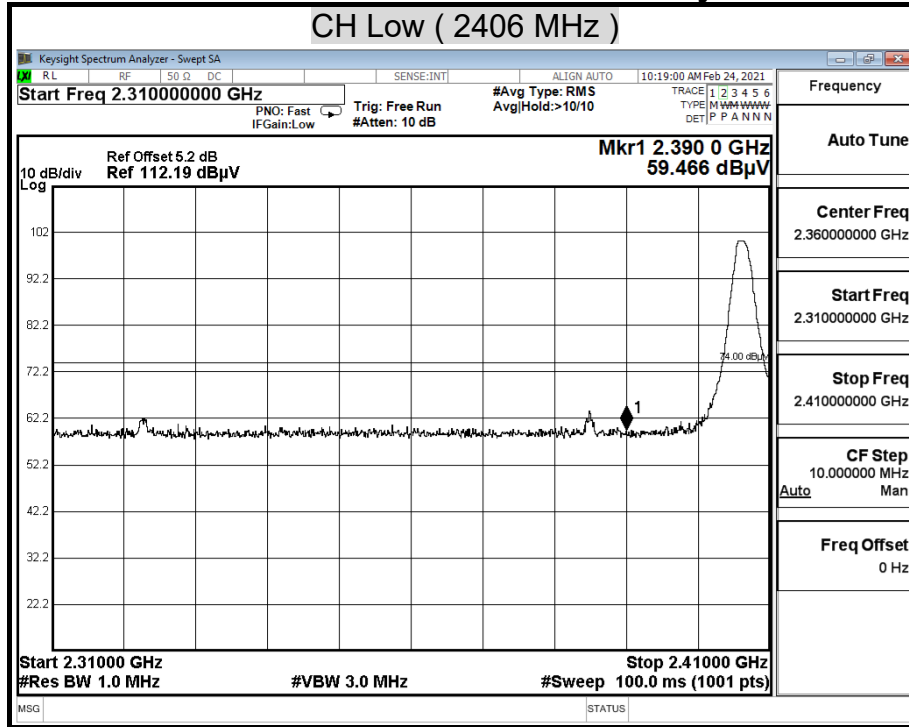

**Detector mode : Average**

**Polarity : Horizontal**

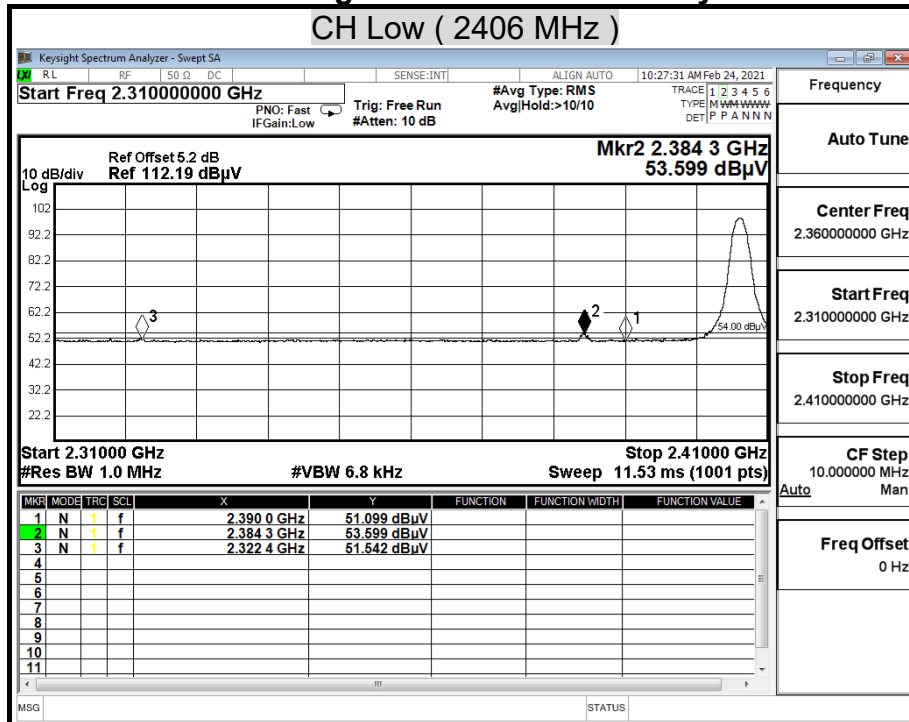

Detector mode : Peak

Polarity : Vertical

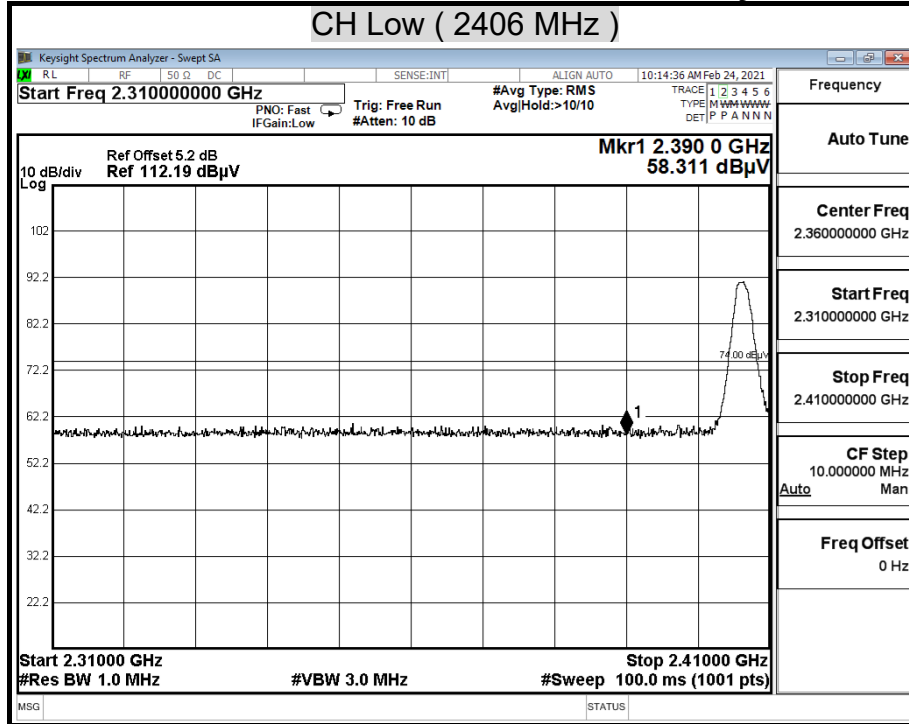

Detector mode : Average

Polarity : Vertical

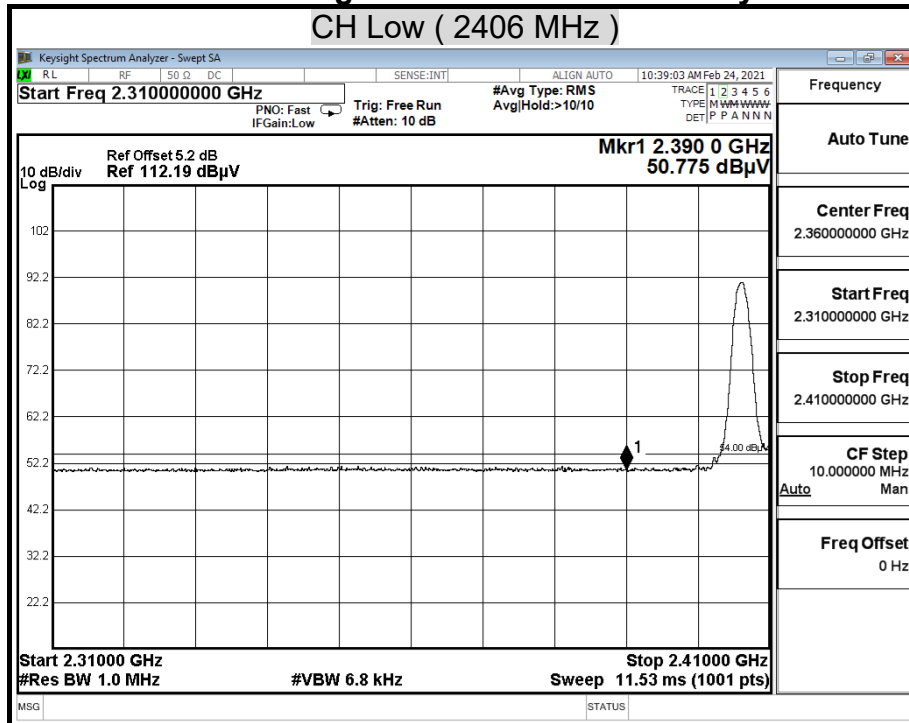

**Detector mode : Peak**

**Polarity : Horizontal**

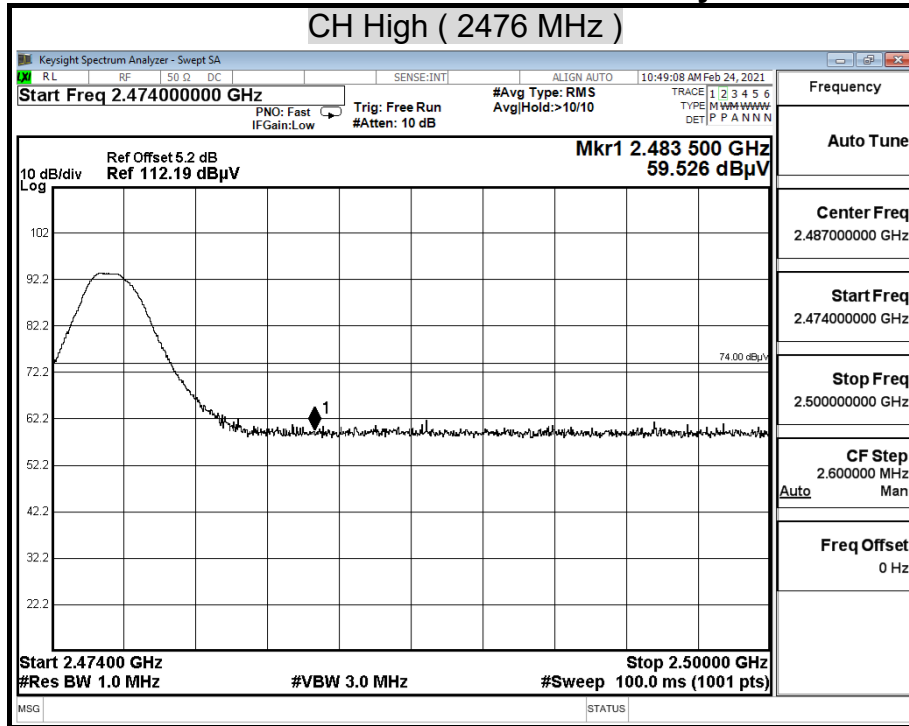

**Detector mode : Average**

**Polarity : Horizontal**

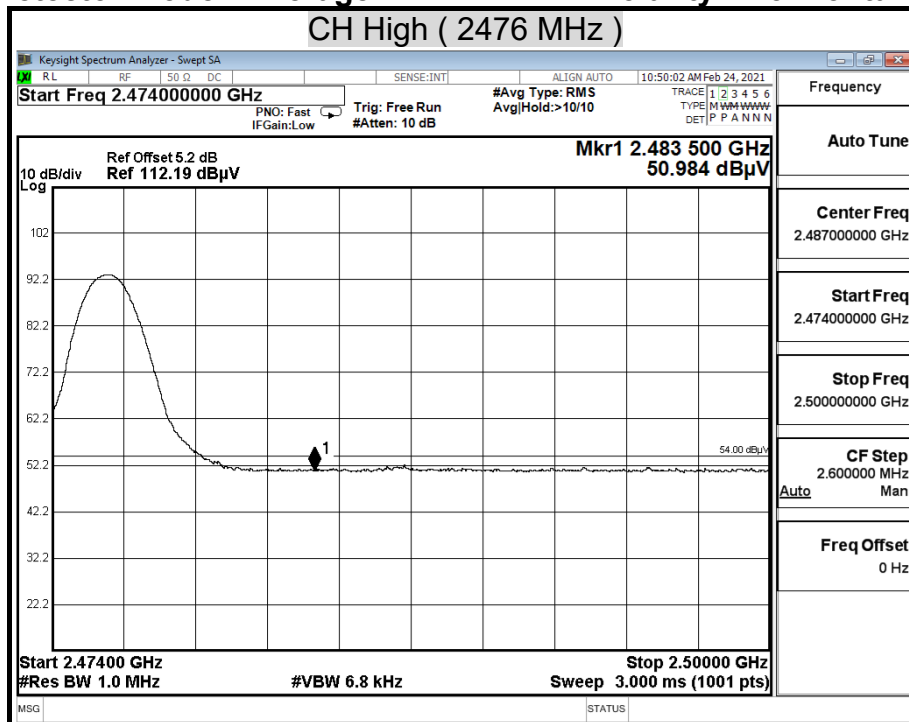

Detector mode : Peak

Polarity : Vertical

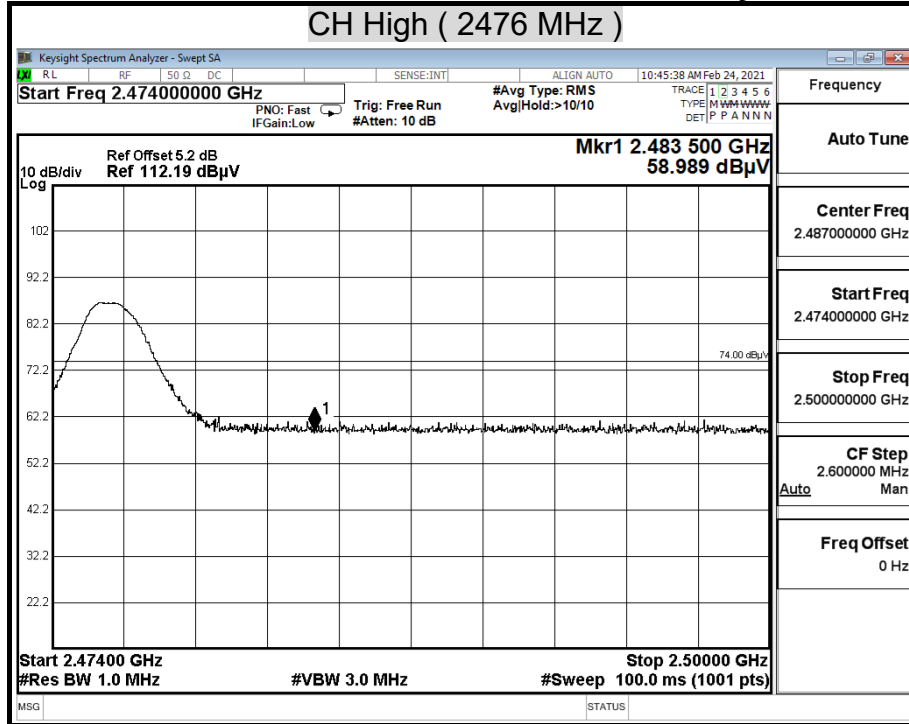

Detector mode : Average

Polarity : Vertical

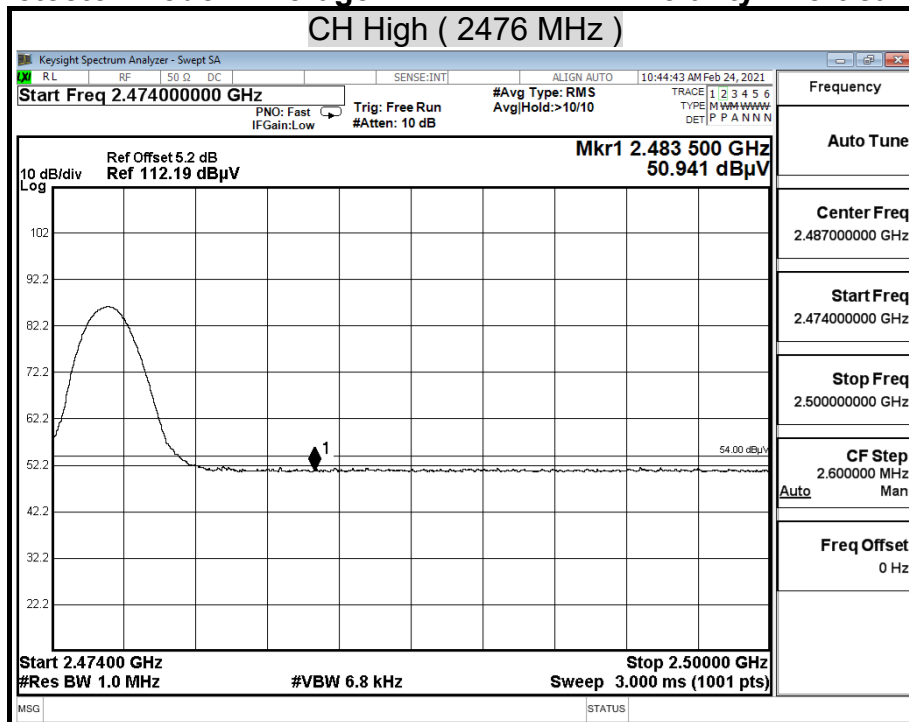



## 7.3 DUTY CYCLE

### LIMIT

Nil (No dedicated limit specified in the Rules)

### TEST CONFIGURATIONS

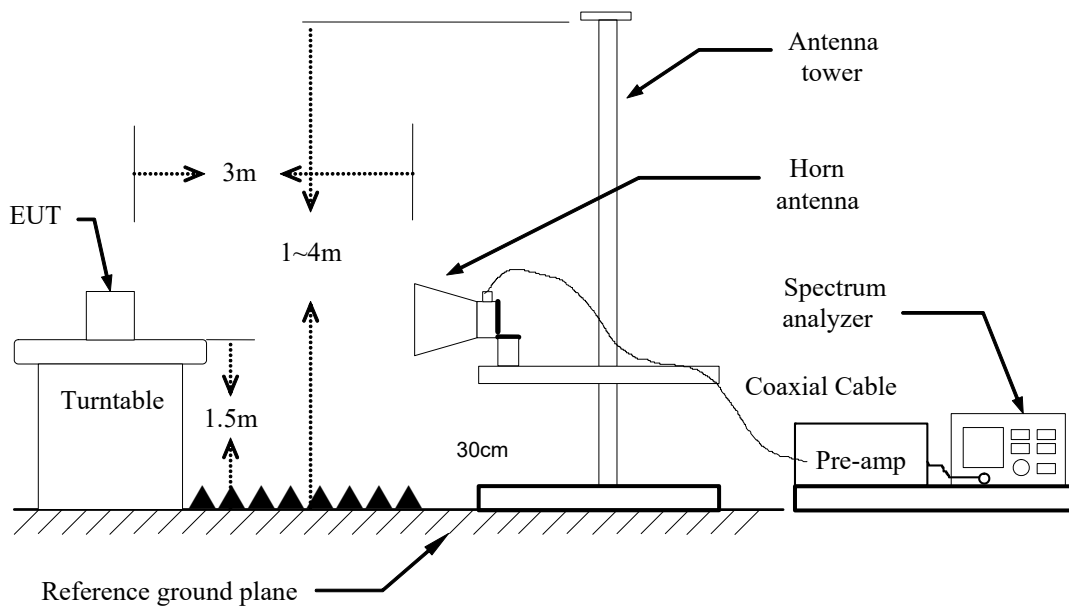

### TEST PROCEDURE

1. Place the EUT on the table and set it in transmitting mode.
2. Set center frequency of spectrum analyzer = operating frequency.
3. Set the spectrum analyzer as RBW, VBW=100KHz, Span = 0Hz, a suitable Sweep Time.
4. Repeat above procedures until all frequency measured were complete.

### TEST RESULTS

No non-compliance noted.

**TEST DATA**

**Operation Mode:** TX

**Test Date:** 2021/02/24

**Temperature:** 24.5°C

**Tested by:** Ted Huang

**Humidity:** 52% RH

**Polarity:** Ver. / Hor.

	us	Times	Ton	Total Ton time(ms)
Ton1	150.000	1	150.000	0.150
Ton2		0	0.000	
Ton3		0	0.000	
Tp				0.625

Ton	0.150
Tp(Ton+Toff)	0.625
Duty Cycle	0.240
Duty Factor	-12.396

24 %

## TEST PLOT

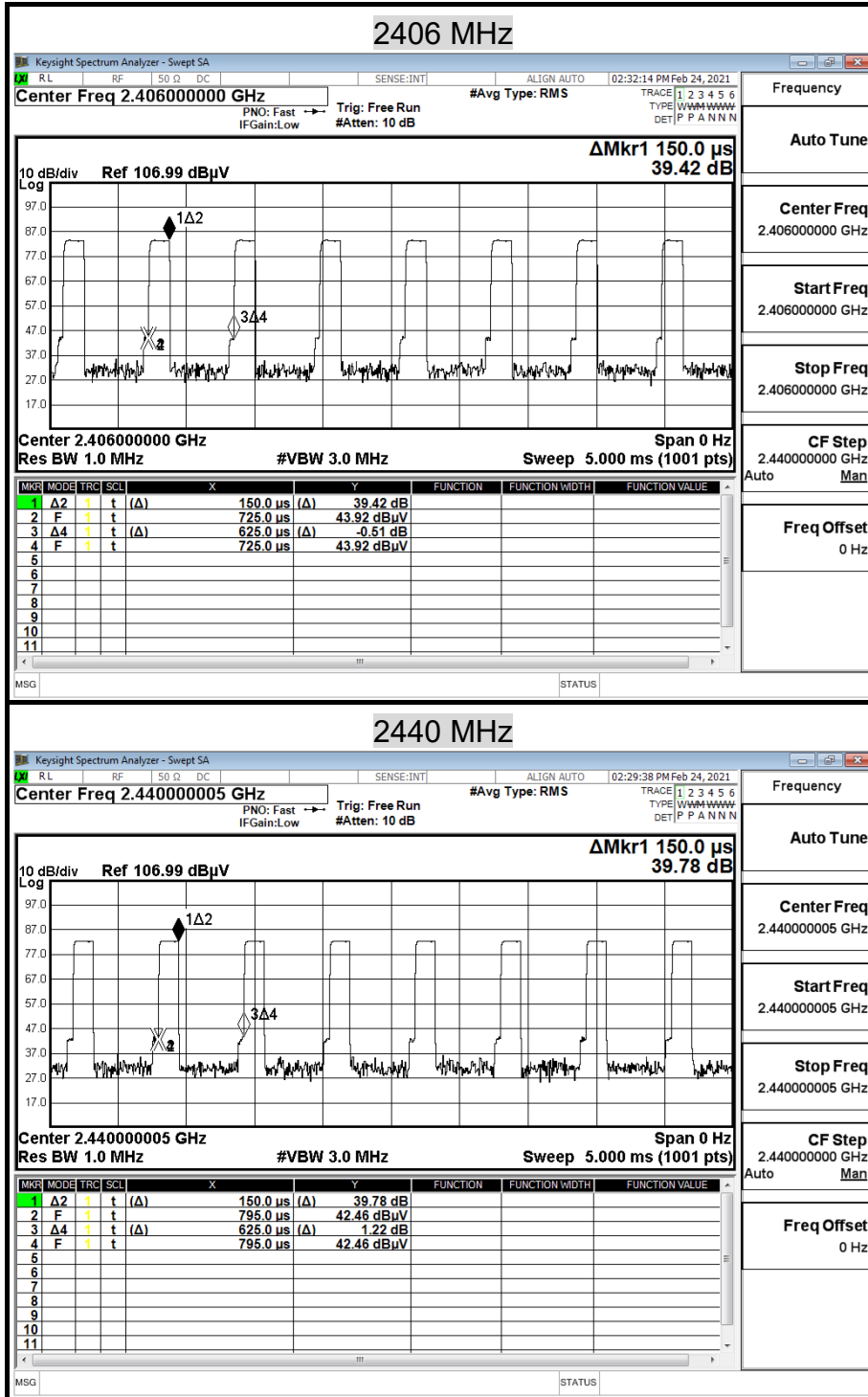

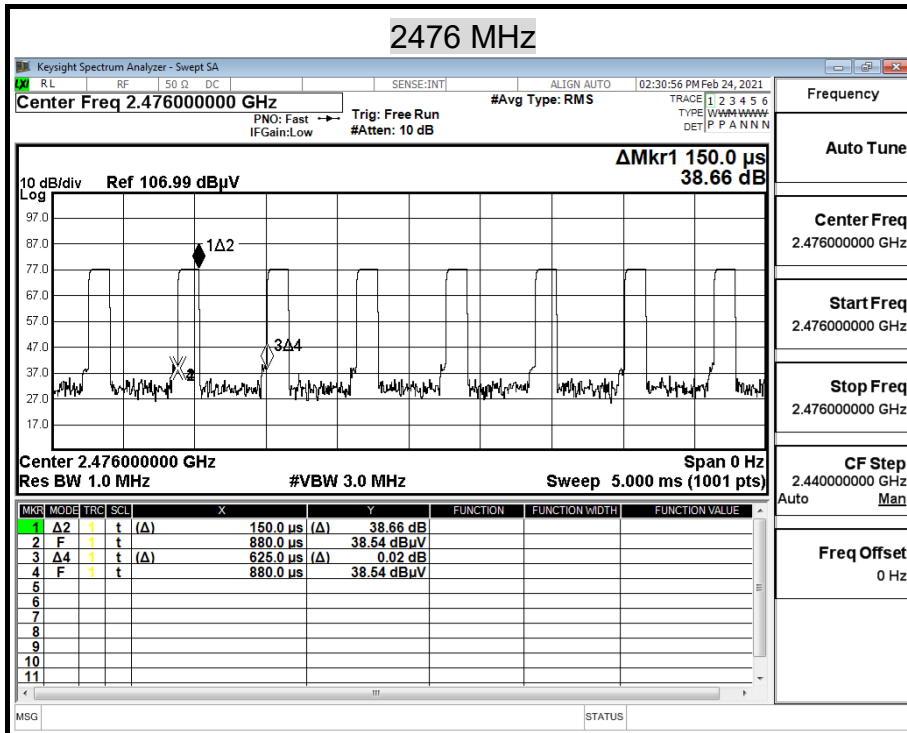

Report No.: T210120N02-RP1

## 7.4 SPURIOUS EMISSION

### LIMIT

1. In the section 15.249(a):

Except as provided in paragraph (b) of this section, the field strength of emissions from intentional radiators operated within these frequency bands shall comply with the following:

Fundamental Frequency (MHz)	Field Strength of Fundamental Field Strength (mV/m)	Field Strength of Harmonics ( $\mu\text{V/m}$ )
902-928 MHz	50	500
2400 - 2483.5 MHz	50	500
5725 - 5875 MHz	50	500
24.0 - 24.25 GHz	250	2500

2. Except as provided elsewhere in this Subpart, the emissions from an intentional radiator shall not exceed the field strength levels specified in the following table:

Frequency (MHz)	Field Strength ( $\mu\text{V/m}$ )	Measurement Distance (m)
30-88	100*	3
88-216	150*	3
216-960	200*	3
Above 960	500	3

**Remark:** Except as provided in paragraph (g), fundamental emissions from intentional radiators operating under this Section shall not be located in the frequency bands 54-72 MHz, 76-88 MHz, 174-216 MHz or 470-806 MHz. However, operation within these frequency bands is permitted under other sections of this Part, e.g., Sections 15.231 and 15.241.

3. In the above emission table, the tighter limit applies at the band edges.

Frequency (MHz)	Field Strength ( $\mu\text{V/m}$ at 3-meter)	Field Strength (dB $\mu\text{V/m}$ at 3-meter)
30-88	100	40
88-216	150	43.5
216-960	200	46
Above 960	500	54

## TEST CONFIGURATION

9kHz ~ 30MHz

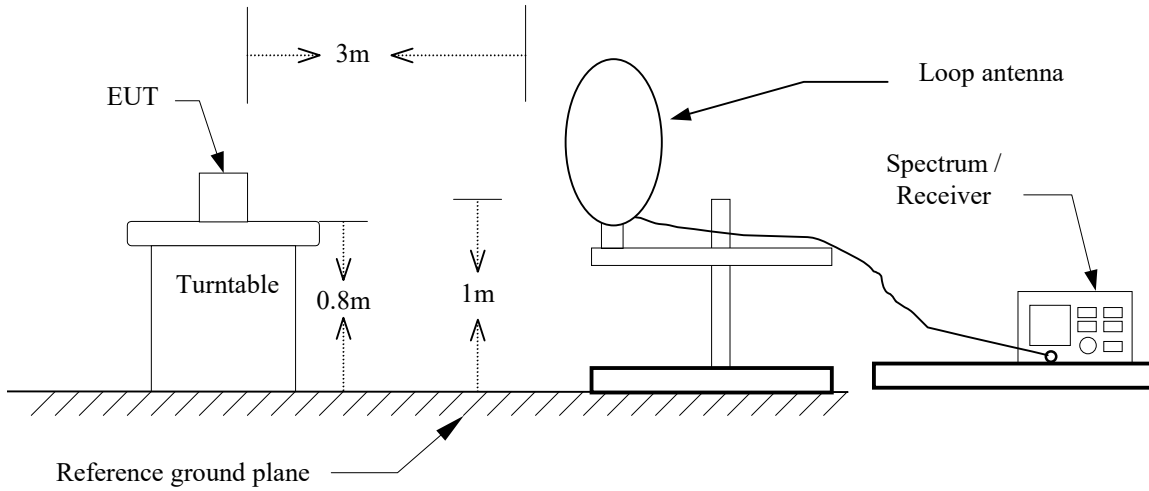

30MHz ~ 1GHz

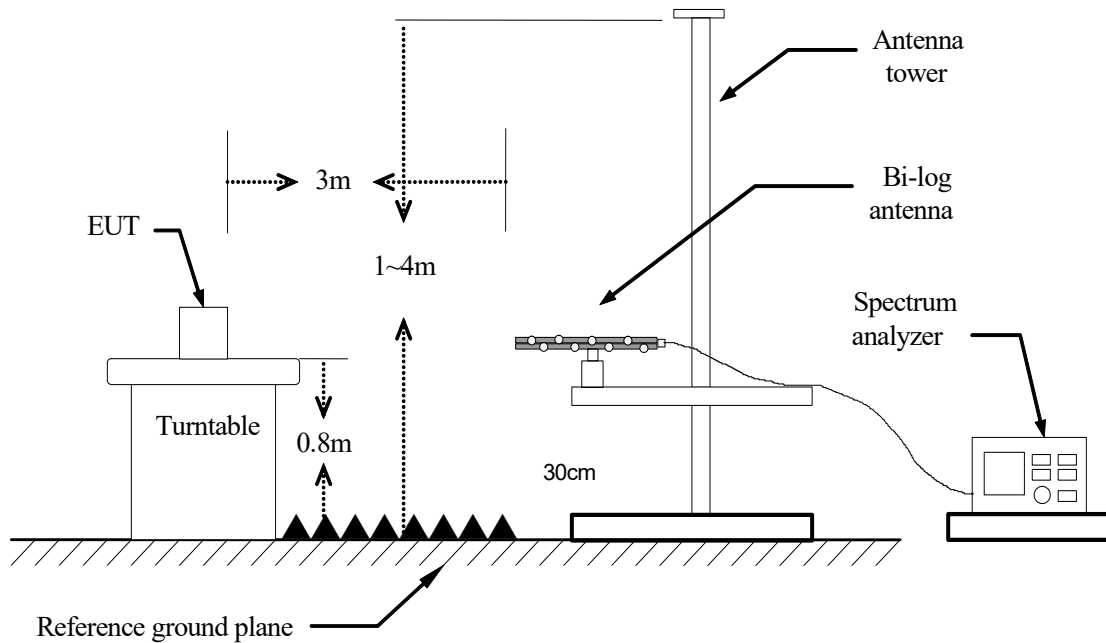

Report No.: T210120N02-RP1

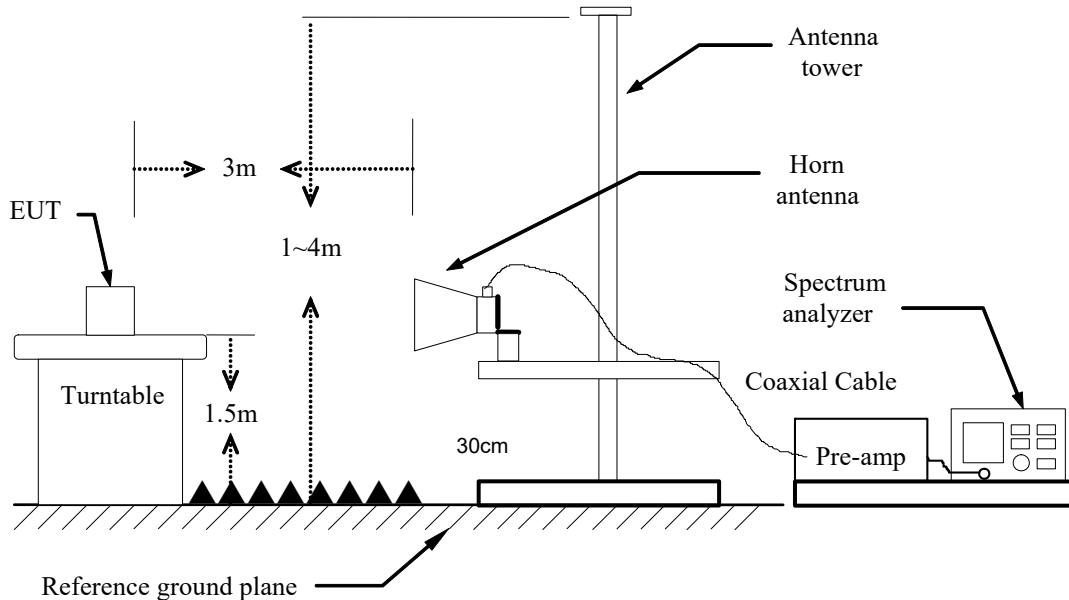
**Above 1 GHz****TEST PROCEDURE**

1. The EUT is placed on a turntable, which is 0.8/1.5m above ground plane.
2. The turntable shall be rotated for 360 degrees to determine the position of maximum emission level.
3. EUT is set 3m away from the receiving antenna, which is varied from 1m to 4m to find out the highest emissions.
4. Maximum procedure was performed on the six highest emissions to ensure EUT compliance.
5. And also, each emission was to be maximized by changing the polarization of receiving antenna both horizontal and vertical.
6. Set the spectrum analyzer in the following setting as:  
Below 1GHz:  
RBW=100kHz / VBW=300kHz / Sweep=AUTO  
Above 1GHz:  
(a) PEAK: RBW=1MHz, VBW=3MHz, Sweep=100ms, Detector=Peak  
(b) AVERAGE: RBW=1MHz, VBW=3MHz, Sweep=100ms, Detector=Average
7. Repeat above procedures until the measurements for all frequencies are complete.

Report No.: T210120N02-RP1

### Below 1 GHz

Operation Mode: TX

Test Date: 2021/02/24

Temperature: 26.7°C

Tested by: Ted Huang

Humidity: 52% RH

Polarity: Ver. / Hor.

### Vertical

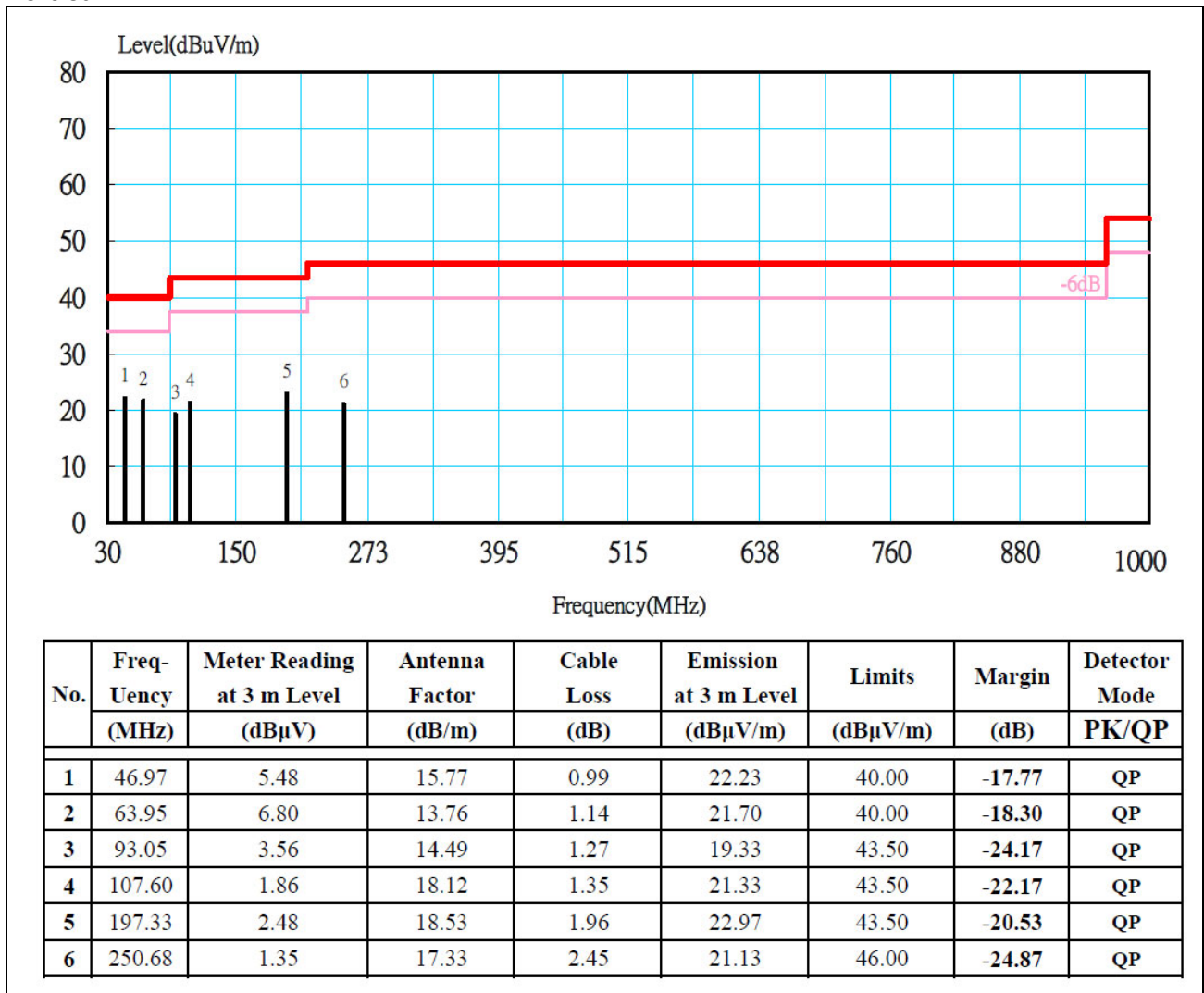

### Remark:

- No emission found between lowest internal used/generated frequency to 30MHz (9kHz~30MHz).
- Radiated emissions measured in frequency range from 30 MHz to 1000MHz were made with an instrument using peak/quasi-peak detector mode.
- Quasi-peak test would be performed if the peak result were greater than the quasi-peak limit or as required by the applicant.
- Measurements above show only up to 6 maximum emissions noted, or would be lesser, with " N/A " remark, if no specific emissions from the EUT are recorded (ie: margin>20dB from the applicable limit) and considered that's already beyond the background noise floor.
- Emission at 3m Level=Meter Reading +Antenna Factor +Cable Loss  
Margin= Emission at 3m Level -Limits
- That the limit for signals below 1GHz is a QP limit and peak readings are below the QP limit.
- The fundamental signal is not shown in the test data because measurements at fundamental frequency are shown separately and were ignored during the 30 – 1000 MHz scan.



Report No.: T210120N02-RP1

Operation Mode: TX

Test Date: 2021/02/24

Temperature: 26.7°C

Tested by: Ted Huang

Humidity: 52% RH

Polarity: Ver. / Hor.

**Horizontal**

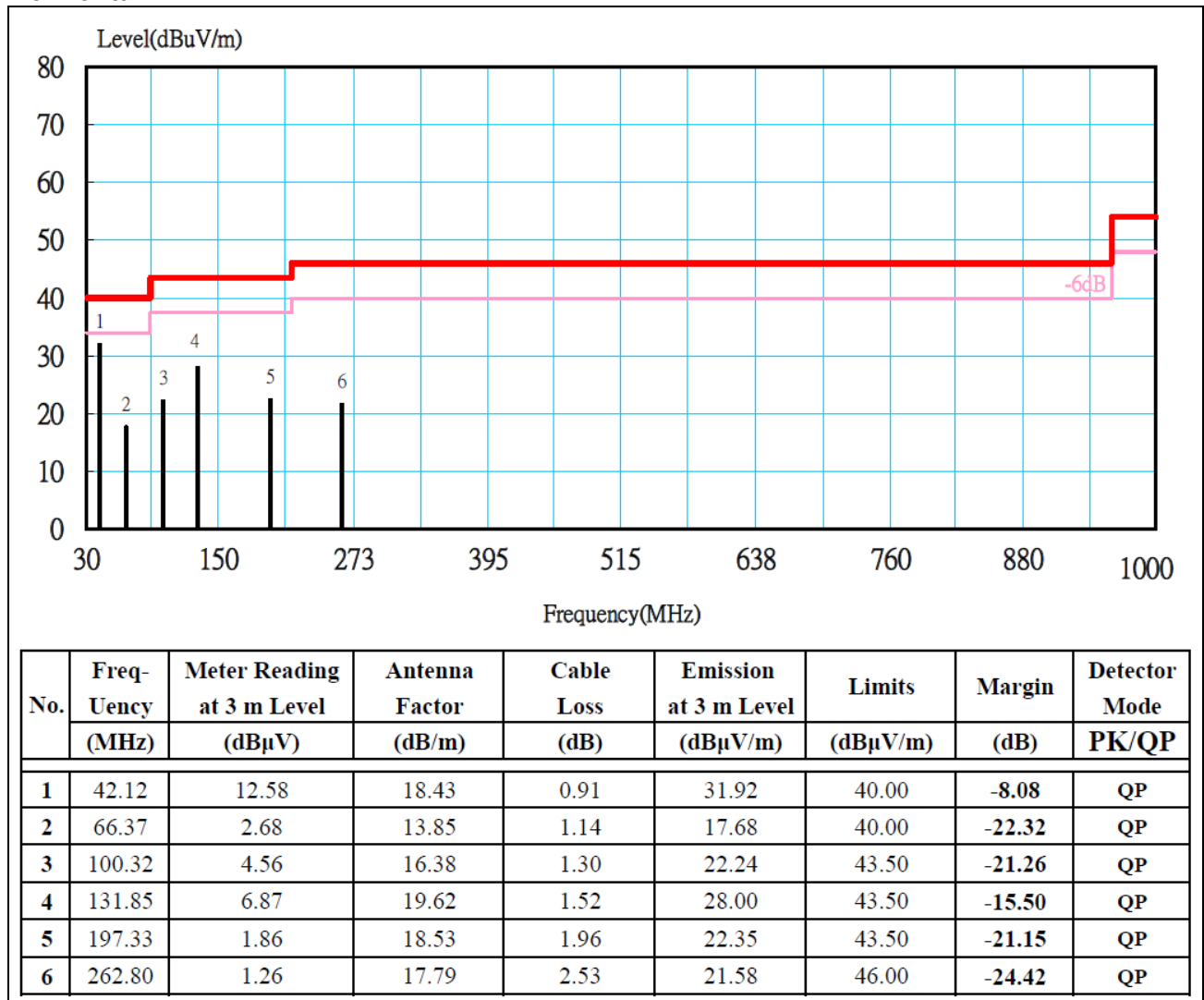

No.	Freq- Uency (MHz)	Meter Reading at 3 m Level (dBμV)	Antenna Factor (dB/m)	Cable Loss (dB)	Emission at 3 m Level (dBμV/m)	Limits (dBμV/m)	Margin (dB)	Detector Mode PK/QP
1	42.12	12.58	18.43	0.91	31.92	40.00	-8.08	QP
2	66.37	2.68	13.85	1.14	17.68	40.00	-22.32	QP
3	100.32	4.56	16.38	1.30	22.24	43.50	-21.26	QP
4	131.85	6.87	19.62	1.52	28.00	43.50	-15.50	QP
5	197.33	1.86	18.53	1.96	22.35	43.50	-21.15	QP
6	262.80	1.26	17.79	2.53	21.58	46.00	-24.42	QP

**Remark:**

- No emission found between lowest internal used/generated frequency to 30MHz (9kHz~30MHz).
- Radiated emissions measured in frequency range from 30 MHz to 1000MHz were made with an instrument using peak/quasi-peak detector mode.
- Quasi-peak test would be performed if the peak result were greater than the quasi-peak limit or as required by the applicant.
- Measurements above show only up to 6 maximum emissions noted, or would be lesser, with " N/A " remark, if no specific emissions from the EUT are recorded (ie: margin>20dB from the applicable limit) and considered that's already beyond the background noise floor.
- Emission at 3m Level=Meter Reading +Antenna Factor +Cable Loss  
Margin= Emission at 3m Level -Limits
- That the limit for signals below 1GHz is a QP limit and peak readings are below the QP limit.
- The fundamental signal is not shown in the test data because measurements at fundamental frequency are shown separately and were ignored during the 30 – 1000 MHz scan.

Report No.: T210120N02-RP1

### The fundamental signal

Operation Mode: TX CH Low

Test Date: 2021/02/24

Temperature: 24.5°C

Tested by: Ted Huang

Humidity: 52% RH

Polarity: Ver. / Hor.

#### Horizontal

Freq.	Reading	AF	Cable Loss	Pre-amp	Filter	Level	Limit	Margin	Mark
(MHz)	(dBμV)	(dB/m)	(dB)	(dB)	(dB)	(dBμV/m)	(dBμV/m)	(dB)	(P/Q/A)
2406.000	96.340	30.275	3.895	43.751	0.000	101.808	114.000	-12.192	P
2406.000	-	-	-	-	-	89.41	94.000	-4.588	A

#### Vertical

Freq.	Reading	AF	Cable Loss	Pre-amp	Filter	Level	Limit	Margin	Mark
(MHz)	(dBμV)	(dB/m)	(dB)	(dB)	(dB)	(dBμV/m)	(dBμV/m)	(dB)	(P/Q/A)
2406.000	89.091	30.275	3.895	43.751	0.000	94.559	114.000	-19.441	P
2406.000	-	-	-	-	-	82.16	94.000	-11.837	A

#### Remark:

1. Level = Reading + AF + Cable Loss - Pre-amp + Filter

2. Margin = Level - Limit

3. Average level = Peak level + Duty factor

**Operation Mode:** TX CH Middle  
**Temperature:** 24.5°C  
**Humidity:** 52% RH

**Test Date:** 2021/02/24  
**Tested by:** Ted Huang  
**Polarity:** Ver. / Hor.

Horizontal

Freq.	Reading	AF	Cable Loss	Pre-amp	Filter	Level	Limit	Margin	Mark
(MHz)	(dBμV)	(dB/m)	(dB)	(dB)	(dB)	(dBμV/m)	(dBμV/m)	(dB)	(P/Q/A)
2440.00	93.82	30.25	3.92	43.73	0.00	99.31	114.00	-14.69	P
2440.00	-	-	-	-	-	86.91	94.00	-7.09	A

Vertical

Freq.	Reading	AF	Cable Loss	Pre-amp	Filter	Level	Limit	Margin	Mark
(MHz)	(dBμV)	(dB/m)	(dB)	(dB)	(dB)	(dBμV/m)	(dBμV/m)	(dB)	(P/Q/A)
2440.00	87.15	30.25	3.92	43.73	0.00	92.64	114.00	-21.36	P
2440.00	-	-	-	-	-	80.24	94.00	-13.76	A

**Remark:**

1.  $Level = Reading + AF + Cable\ Loss - Pre\ amp + Filter$
2.  $Margin = Level - Limit$
3.  $Average\ level = Peak\ level + Duty\ factor$

**Operation Mode:** TX CH High  
**Temperature:** 24.5°C  
**Humidity:** 52% RH

**Test Date:** 2021/02/24  
**Tested by:** Ted Huang  
**Polarity:** Ver. / Hor.

Horizontal

Freq.	Reading	AF	Cable Loss	Pre-amp	Filter	Level	Limit	Margin	Mark
(MHz)	(dBμV)	(dB/m)	(dB)	(dB)	(dB)	(dBμV/m)	(dBμV/m)	(dB)	(P/Q/A)
2476.00	90.63	30.22	3.94	43.70	0.00	96.14	114.00	-17.86	P
2476.00	-	-	-	-	-	83.74	94.00	-10.26	A

Vertical

Freq.	Reading	AF	Cable Loss	Pre-amp	Filter	Level	Limit	Margin	Mark
(MHz)	(dBμV)	(dB/m)	(dB)	(dB)	(dB)	(dBμV/m)	(dBμV/m)	(dB)	(P/Q/A)
2476.00	84.52	30.22	3.94	43.70	0.00	90.03	114.00	-23.97	P
2476.00	-	-	-	-	-	77.63	94.00	-16.37	A

**Remark:**

1.  $Level = Reading + AF + Cable\ Loss - Pre\ amp + Filter$
2.  $Margin = Level - Limit$
3.  $Average\ level = Peak\ level + Duty\ factor$

**Above 1 GHz**

**Operation Mode:** TX CH Low  
**Temperature:** 24.5°C  
**Humidity:** 52% RH

**Test Date:** 2021/02/24  
**Tested by:** Ted Huang  
**Polarity:** Ver. / Hor.

Horizontal

Freq.	Reading	AF	Cable Loss	Pre-amp	Filter	Level	Limit	Margin	Mark
(MHz)	(dBµV)	(dB/m)	(dB)	(dB)	(dB)	(dBµV/m)	(dBµV/m)	(dB)	(P/Q/A)
* 1210.05	62.42	25.28	2.83	44.82	1.27	46.98	74.00	-27.02	P
* 1210.05	-	-	-	-	-	34.58	54.00	-19.42	A
* 4811.34	67.53	33.26	5.46	42.61	0.36	64.00	74.00	-10.00	P
* 4811.34	-	-	-	-	-	51.61	54.00	-2.39	A
7218.20	60.21	38.73	6.57	42.42	0.33	63.41	74.00	-10.59	P
7218.20	-	-	-	-	-	51.02	54.00	-2.98	A

**Remark:**

1. Measuring frequencies from 1 GHz to the 10th harmonic of highest fundamental frequency.
2. Radiated emissions measured in frequency above 1000MHz were made with an instrument using peak/average detector mode.
3. Average test would be performed if the peak result were greater than the average limit or as required by the applicant.
4. Data of measurement within this frequency range shown " --- " in the table above means the reading of emissions are attenuated more than 20dB below the permissible limits or the field strength is too small to be measured.
5. Measurements above show only up to 6 maximum emissions noted, or would be lesser, with " N/A " remark, if no specific emissions from the EUT are recorded (ie: margin>20dB from the applicable limit) and considered that's already beyond the background noise floor.
6. Level (QP)=Reading +AF +Cable Loss -Pre-amp +Filter  
Margin= Level -Limit  
Level (Average)=Peak level +Duty factor
7. \*=Restricted bands of operation

Report No.: T210120N02-RP1

Operation Mode: TX CH Low

Test Date: 2021/02/24

Temperature: 24.5°C

Tested by: Ted Huang

Humidity: 52% RH

Polarity: Ver. / Hor.

Vertical

Freq.	Reading	AF	Cable Loss	Pre-amp	Filter	Level	Limit	Margin	Mark
(MHz)	(dBμV)	(dB/m)	(dB)	(dB)	(dB)	(dBμV/m)	(dBμV/m)	(dB)	(P/Q/A)
* 1092.08	60.45	24.79	2.68	44.85	1.45	44.51	74.00	-29.49	P
* 1092.08	-	-	-	-	-	32.12	54.00	-21.88	A
* 4811.50	69.06	33.26	5.46	42.61	0.36	65.53	74.00	-8.47	P
* 4811.50	-	-	-	-	-	53.14	54.00	-0.86	A
7218.95	59.58	38.73	6.57	42.42	0.33	62.79	74.00	-11.21	P
7218.95	-	-	-	-	-	50.39	54.00	-3.61	A

Remark:

1. Measuring frequencies from 1 GHz to the 10th harmonic of highest fundamental frequency.
2. Radiated emissions measured in frequency above 1000MHz were made with an instrument using peak/average detector mode.
3. Average test would be performed if the peak result were greater than the average limit or as required by the applicant.
4. Data of measurement within this frequency range shown " --- " in the table above means the reading of emissions are attenuated more than 20dB below the permissible limits or the field strength is too small to be measured.
5. Measurements above show only up to 6 maximum emissions noted, or would be lesser, with " N/A " remark, if no specific emissions from the EUT are recorded (ie: margin>20dB from the applicable limit) and considered that's already beyond the background noise floor.
6. Level (QP)=Reading +AF +Cable Loss -Pre-amp +Filter  
Margin= Level -Limit  
Level (Average)=Peak level +Duty factor
7. \*=Restricted bands of operation

Report No.: T210120N02-RP1

Operation Mode: TX CH Middle

Test Date: 2021/02/24

Temperature: 24.5°C

Tested by: Ted Huang

Humidity: 52% RH

Polarity: Ver. / Hor.

Horizontal

Freq.	Reading	AF	Cable Loss	Pre-amp	Filter	Level	Limit	Margin	Mark
(MHz)	(dBμV)	(dB/m)	(dB)	(dB)	(dB)	(dBμV/m)	(dBμV/m)	(dB)	(P/Q/A)
* 1209.35	61.78	25.28	2.83	44.82	1.27	46.33	74.00	-27.67	P
* 1209.35	-	-	-	-	-	33.94	54.00	-20.06	A
* 4880.41	67.57	33.49	5.51	42.60	0.38	64.35	74.00	-9.65	P
* 4880.41	-	-	-	-	-	51.96	54.00	-2.04	A
* 7319.69	60.37	39.11	6.59	42.29	0.32	64.11	74.00	-9.89	P
* 7319.69	-	-	-	-	-	51.71	54.00	-2.29	A

Remark:

1. Measuring frequencies from 1 GHz to the 10th harmonic of highest fundamental frequency.
2. Radiated emissions measured in frequency above 1000MHz were made with an instrument using peak/average detector mode.
3. Average test would be performed if the peak result were greater than the average limit or as required by the applicant.
4. Data of measurement within this frequency range shown " --- " in the table above means the reading of emissions are attenuated more than 20dB below the permissible limits or the field strength is too small to be measured.
5. Measurements above show only up to 6 maximum emissions noted, or would be lesser, with " N/A " remark, if no specific emissions from the EUT are recorded (ie: margin>20dB from the applicable limit) and considered that's already beyond the background noise floor.
6. Level (QP)=Reading +AF +Cable Loss -Pre-amp +Filter  
Margin= Level -Limit  
Level (Average)=Peak level +Duty factor
7. \*=Restricted bands of operation

Report No.: T210120N02-RP1

Operation Mode: TX CH Middle

Test Date: 2021/02/24

Temperature: 24.5°C

Tested by: Ted Huang

Humidity: 52% RH

Polarity: Ver. / Hor.

Vertical

Freq.	Reading	AF	Cable Loss	Pre-amp	Filter	Level	Limit	Margin	Mark
(MHz)	(dBμV)	(dB/m)	(dB)	(dB)	(dB)	(dBμV/m)	(dBμV/m)	(dB)	(P/Q/A)
* 1091.52	60.18	24.78	2.68	44.85	1.45	44.24	74.00	-29.76	P
* 1091.52	-	-	-	-	-	31.84	54.00	-22.16	A
* 4880.41	67.70	33.49	5.51	42.60	0.38	64.48	74.00	-9.52	P
* 4880.41	-	-	-	-	-	52.09	54.00	-1.91	A
* 7319.27	57.77	39.11	6.59	42.29	0.32	61.51	74.00	-12.49	P
* 7319.27	-	-	-	-	-	49.11	54.00	-4.89	A

Remark:

1. Measuring frequencies from 1 GHz to the 10th harmonic of highest fundamental frequency.
2. Radiated emissions measured in frequency above 1000MHz were made with an instrument using peak/average detector mode.
3. Average test would be performed if the peak result were greater than the average limit or as required by the applicant.
4. Data of measurement within this frequency range shown " --- " in the table above means the reading of emissions are attenuated more than 20dB below the permissible limits or the field strength is too small to be measured.
5. Measurements above show only up to 6 maximum emissions noted, or would be lesser, with " N/A " remark, if no specific emissions from the EUT are recorded (ie: margin>20dB from the applicable limit) and considered that's already beyond the background noise floor.
6. Level (QP)=Reading +AF +Cable Loss -Pre-amp +Filter  
Margin= Level -Limit  
Level (Average)=Peak level +Duty factor
7. \*=Restricted bands of operation



**Operation Mode:** TX CH High  
**Temperature:** 24.5°C  
**Humidity:** 52% RH

**Test Date:** 2021/02/24  
**Tested by:** Ted Huang  
**Polarity:** Ver. / Hor.

Horizontal

Freq.	Reading	AF	Cable Loss	Pre-amp	Filter	Level	Limit	Margin	Mark
(MHz)	(dBμV)	(dB/m)	(dB)	(dB)	(dB)	(dBμV/m)	(dBμV/m)	(dB)	(P/Q/A)
* 1209.78	61.68	25.28	2.83	44.82	1.27	46.24	74.00	-27.76	P
* 1209.78	-	-	-	-	-	33.84	54.00	-20.16	A
* 4951.31	67.83	33.73	5.56	42.59	0.40	64.93	74.00	-9.07	P
* 4951.31	-	-	-	-	-	52.53	54.00	-1.47	A
* 7427.71	60.27	39.53	6.61	42.15	0.32	64.58	74.00	-9.42	P
* 7427.71	-	-	-	-	-	52.18	54.00	-1.82	A

**Remark:**

1. Measuring frequencies from 1 GHz to the 10th harmonic of highest fundamental frequency.
2. Radiated emissions measured in frequency above 1000MHz were made with an instrument using peak/average detector mode.
3. Average test would be performed if the peak result were greater than the average limit or as required by the applicant.
4. Data of measurement within this frequency range shown " --- " in the table above means the reading of emissions are attenuated more than 20dB below the permissible limits or the field strength is too small to be measured.
5. Measurements above show only up to 6 maximum emissions noted, or would be lesser, with " N/A " remark, if no specific emissions from the EUT are recorded (ie: margin>20dB from the applicable limit) and considered that's already beyond the background noise floor.
6. Level (QP)=Reading +AF +Cable Loss -Pre-amp +Filter  
Margin= Level -Limit  
Level (Average)=Peak level +Duty factor
7. \*=Restricted bands of operation

Report No.: T210120N02-RP1

Operation Mode: TX CH High

Test Date: 2021/02/24

Temperature: 24.5°C

Tested by: Ted Huang

Humidity: 52% RH

Polarity: Ver. / Hor.

Vertical

Freq.	Reading	AF	Cable Loss	Pre-amp	Filter	Level	Limit	Margin	Mark
(MHz)	(dBμV)	(dB/m)	(dB)	(dB)	(dB)	(dBμV/m)	(dBμV/m)	(dB)	(P/Q/A)
* 1091.78	60.68	24.79	2.68	44.85	1.45	44.74	74.00	-29.26	P
* 1091.78	-	-	-	-	-	32.35	54.00	-21.65	A
* 4951.85	66.27	33.74	5.56	42.59	0.40	63.37	74.00	-10.63	P
* 4951.85	-	-	-	-	-	50.98	54.00	-3.02	A
* 7428.33	58.05	39.53	6.61	42.14	0.32	62.36	74.00	-11.64	P
* 7428.33	-	-	-	-	-	49.97	54.00	-4.03	A

**Remark:**

1. Measuring frequencies from 1 GHz to the 10th harmonic of highest fundamental frequency.
2. Radiated emissions measured in frequency above 1000MHz were made with an instrument using peak/average detector mode.
3. Average test would be performed if the peak result were greater than the average limit or as required by the applicant.
4. Data of measurement within this frequency range shown " --- " in the table above means the reading of emissions are attenuated more than 20dB below the permissible limits or the field strength is too small to be measured.
5. Measurements above show only up to 6 maximum emissions noted, or would be lesser, with " N/A " remark, if no specific emissions from the EUT are recorded (ie: margin>20dB from the applicable limit) and considered that's already beyond the background noise floor.
6. Level (QP)=Reading +AF +Cable Loss -Pre-amp +Filter  
Margin= Level -Limit  
Level (Average)=Peak level +Duty factor
7. \*=Restricted bands of operation

## 7.5 POWERLINE CONDUCTED EMISSIONS

### LIMIT

According to §15.207(a), except as shown in paragraphs (b) and (c) of this section, for an intentional radiator that is designed to be connected to the public utility (AC) power line, the radio frequency voltage that is conducted back onto the AC power line on any frequency or frequencies within the band 150 kHz to 30 MHz shall not exceed the limits in the following table, as measured using a 50  $\mu$ H/50 ohms line impedance stabilization network (LISN). Compliance with the provisions of this paragraph shall be based on the measurement of the radio frequency voltage between each power line and ground at the power terminal. The lower limit applies at the boundary between the frequency ranges.

Frequency Range (MHz)	Limits (dB $\mu$ V)	
	Quasi-peak	Average
0.15 to 0.50	66 to 56	56 to 46
0.50 to 5	56	46
5 to 30	60	50

Compliance with this provision shall be based on the measurement of the radio frequency voltage between each power line (LINE and NEUTRAL) and ground at the power terminals.

### TEST RESULTS

※ This EUT is not connected to AC Source directly. No applicability for this test.

===End of Test Report===