

# AY-x6355 Family

## CSN SELECT Smart Card Readers/Controllers

Installation and User Manual

### Models:

**AYC-H6355**

**AYC-M6355**



AYC-H6355



AYC-M6355

**ROSSLARE**  
SECURITY PRODUCTS

## **Copyright © 2015 by Rosslare. All rights reserved.**

This manual and the information contained herein are proprietary to ROSSLARE ENTERPRISES LIMITED and/or its related companies and/or subsidiaries' (hereafter: "ROSSLARE"). Only ROSSLARE and its customers have the right to use the information.

No part of this manual may be re-produced or transmitted in any form or by any means, electronic or mechanical, for any purpose, without the express written permission of ROSSLARE.

ROSSLARE owns patents and patent applications, trademarks, copyrights, or other intellectual property rights covering the subject matter in this manual.

TEXTS, IMAGES, AND ILLUSTRATIONS INCLUDING THEIR ARRANGEMENT IN THIS DOCUMENT ARE SUBJECT TO THE PROTECTION OF COPYRIGHT LAWS AND OTHER LEGAL RIGHTS WORLDWIDE. THEIR USE, REPRODUCTION, AND TRANSMITTAL TO THIRD PARTIES WITHOUT EXPRESS WRITTEN PERMISSION MAY RESULT IN LEGAL PROCEEDINGS.

The furnishing of this manual to any party does not give that party or any third party any license to these patents, trademarks, copyrights or other intellectual property rights, except as expressly provided in any written agreement of ROSSLARE.

ROSSLARE reserves the right to revise and change this document at any time, without being obliged to announce such revisions or changes beforehand or after the fact.

# Table of Contents

<b>1. Introduction</b>	<b>9</b>
1.1 Box Content	10
1.2 Ancillary Equipment	10
1.2.1 Reader	10
1.2.2 Controller	10
<b>2. Technical Specifications</b>	<b>11</b>
<b>3. Mounting</b>	<b>13</b>
<b>4. Wiring Instructions</b>	<b>15</b>
<b>5. Reader Operation</b>	<b>17</b>
<b>6. OSDP Operation</b>	<b>18</b>
<b>7. Reader Functionality</b>	<b>19</b>
7.1 Transmit Mode	19
7.2 Programming the AYC-x6355 Series	19
7.2.1 Entering Programming Mode	21
7.2.2 Exiting Programming Mode	21
7.2.3 Selecting Keypad Transmission Format	22
7.2.4 Selecting Proximity Card Transmission Format	27
7.2.5 Changing the Programming Code	29
7.2.6 Changing the Facility Code	30
7.3 Setting the Backlight	30
7.4 Return to Factory Default Settings	31
7.5 Replacing a Lost Programming Code	32
<b>8. Controller Functionality</b>	<b>33</b>
8.1 Normal, Secure, and Master Users	33

## Table of Contents

---

8.2	Modes of Operation .....	34
8.2.1	Normal Mode .....	34
8.2.2	Bypass Mode .....	34
8.2.3	Secure Mode .....	35
8.2.4	Changing the Modes of Operation .....	35
8.3	Auxiliary Input and Output.....	36
8.4	Door Alarms .....	37
8.5	Internal Case and Back Tamper .....	37
8.6	Lockout Feature (Keypad/Card Tamper) .....	37
8.7	REX Function .....	37
8.8	Secure Application Appurtenances.....	38
8.9	Programming the AYC-x6355.....	38
8.9.1	Entering Programming Mode.....	39
8.9.2	Exiting Programming Mode .....	40
8.9.3	Changing Lock Strike Code .....	40
8.9.4	Changing Auxiliary Code .....	41
8.9.5	Changing the Programming Code .....	42
8.9.6	Changing the Normal/Secure Code .....	42
8.9.7	Changing the Normal/Bypass Code and Door Chime Settings .....	43
8.9.8	Setting Fail Safe/Secure Operation, Tamper Siren and Lock Strike Release Time .....	44
8.9.9	Defining the Auxiliary Input and Output .....	45
8.9.10	Detailed Reference Guide .....	47
8.9.11	Setting the Lockout Feature .....	50
8.9.12	Setting the Backlight Behavior .....	51
8.9.13	Enrolling Primary and Secondary Codes .....	52
8.9.14	Deleting Primary and Secondary Codes.....	55
8.9.15	Relay Codes Assignment.....	57

## Table of Contents

8.9.16	Relay Code Assignment using Standard Method .....	58
8.9.17	Relay Code Assignment using Search Method .....	58
8.9.18	PIN Code Length/Factory Default Settings.....	59
8.9.19	Replacing a Lost Programming Code .....	60
8.9.20	Exiting Secure Mode if Normal/Secure Code was Lost.....	61
<b>A.</b>	<b>Declaration of Conformity.....</b>	<b>62</b>
<b>B.</b>	<b>Limited Warranty .....</b>	<b>63</b>

## List of Figures

Figure 1: Removing the Top Cover .....	13
--	----

## List of Tables

Table 1: Wiring.....	15
Table 2: Reader Programming Menus.....	20
Table 3: Keypad Transmission Format Option Number .....	23
Table 4: Controller Programming Menu .....	39
Table 5: Quick Reference Guide for Auxiliary Mode Setting.....	46

# Notice and Disclaimer

This manual's sole purpose is to assist installers and/or users in the safe and efficient installation and usage of the system and/or product, and/or software described herein.

**BEFORE ATTEMPTING TO INSTALL AND/OR USE THE SYSTEM, THE INSTALLER AND THE USER MUST READ THIS MANUAL AND BECOME FAMILIAR WITH ALL SAFETY REQUIREMENTS AND OPERATING PROCEDURES.**

- The system must not be used for purposes other than those for which it was designed.
- The use of the software associated with the system and/or product, if applicable, is subject to the terms of the license provided as part of the purchase documents.
- ROSSLARE exclusive warranty and liability is limited to the warranty and liability statement provided in an appendix at the end of this document.
- This manual describes the maximum configuration of the system with the maximum number of functions, including future options. Therefore, not all functions described in this manual may be available in the specific system and/or product configuration you purchased.
- Incorrect operation or installation, or failure of the user to effectively maintain the system, relieves the manufacturer (and seller) from all or any responsibility for consequent noncompliance, damage, or injury.
- The text, images and graphics contained in the manual are for the purpose of illustration and reference only.
- All data contained herein subject to change without prior notice.
- In no event shall manufacturer be liable for any special, direct, indirect, incidental, consequential, exemplary or punitive damages (including, without limitation, any and all damages from business interruption, loss of profits or revenue, cost of capital or loss of use of any property or capital or injury).
- All graphics in this manual are for reference only, some deviation between the image(s) and the actual product may occur.
- All wiring diagrams are intended for reference only, the photograph or graphic of the PCB(s) are intended for clearer illustration and understanding of the product and may differ from the actual PCB(s).



# 1. Introduction

The AYC-x6355 is a family of multi-format contactless smart card convertible integrated readers and controllers for use in access control system solutions.

The AYC-x6355 series automatically determines whether to function as a reader or as a controller. If the unit is connected to a standard access control unit, then it functions as a reader. If the unit is connected to Rosslare's secure application appurtenances such as the PS-A25T, PS-C25T or PS-C25TU, it functions as a secured controller.

Both units are water resistant and suitable for indoor or outdoor mounting. As a controller, the units accept up to 500 users, and allow entry via a personal identification number (PIN) and/or by presenting a proximity card. The PIN code length for the controller has several options. The PIN code length can be a set number of 4, 5, or 6 digits or it can be a 4-8 digits option.

CSN SELECT readers support reading from the secure memory of the following credential technologies:

- MIFARE Ultralight / Ultralight C
- MIFARE Classic
- MIFARE Plus S / Plus X
- MIFARE DESFire EV1
- ISO 14443A
- ISO 14443B
- ISO 15693
- iClass
- ISO 18092 (NFCIP-1)
- FeliCa

For information on how the unit functions as a reader, see Chapter 6. For information on how the unit functions as a controller, see Chapter 8.

### 1.1 Box Content

Before beginning, verify that all of the following is in the box. If anything is missing, please report the discrepancy to your nearest Rosslare office.

- One AYC-x6355 unit
- Installation kit – Includes two wall plugs, two mounting screws, security Torx screw, and security Torx screw tool
- Installation and operating instructions

### 1.2 Ancillary Equipment

The following equipment is required to complete your installation:

#### 1.2.1 Reader

- Compatible host controller (not supplied) – UL listed access control unit, such as model AC-215U

#### 1.2.2 Controller

- Secure application appurtenances (such as the PS-A25T, PS-C25T or PS-C25TU secure controllers)

The controller connects to the following:

- Electric lock strike mechanism or a magnetic lock device, which implements fail safe (power to lock) or fail secure (power to open) functions.
- REX button – Normally open type, switch is closed when pressed.
- Door monitor switch

Rosslare accessories can be found on [www.rosslaresecurity.com](http://www.rosslaresecurity.com).

## 2. Technical Specifications

### Electrical Characteristics

<b>Power Supply Type</b>	Linear (recommended)
<b>Operating Voltage Range</b>	6 to 16 VDC
<b>Current @ 12 V</b>	Standby: 85 mA Maximum: 110 mA
<b>Read Range</b>	MIFARE Classic EV1: 40 to 45 mm (1.5 to 1.8 in.) MIFARE Plus: 30 mm (1.2 in.) MIFARE DESFire EV1: 30 mm (1.2 in.)
<b>LED Control Input 1**</b>	Green LED control, TTL
<b>Auxiliary Input**</b>	Buzzer control, TTL
<b>Auxiliary Output**</b>	Tamper output (open collector, active low, max. sink current 30 mA)
<b>Maximum Cable Distance to Controller</b>	Wiegand: 150 m (500 ft) with 18-AWG cable OSDP (RS-485): 1200 m (4,000 ft) with 2x2 18-AWG twisted shielded cable

### Environmental Characteristics

<b>Operating Temp. Range</b>	-25°C to 65°C (-13°F to 149°F)
<b>Operating Humidity Range</b>	0 to 95% (non-condensing)
<b>Outdoor Usage</b>	Weather-resistant, meets IP65, epoxy-potted, suitable for indoor and outdoor use

\* Measured using Rosslare O2S ISO cards. Range also depends on electrical environment and proximity to metal.

\*\* Standard configuration. Custom configurations are available.

## Technical Specifications

---

### Physical Characteristics

---

<b>Dimensions (H x W x D)</b>	AYC-H6255: 110.7 × 75.0 × 18.2 mm (4.4 x 3.0 x 0.6 in.)
	AYC-M6255: 89.5 × 88.9 × 18.3 mm (3.5 x 3.5 x 0.7 in.)
<b>Weight</b>	AYC-H6255: 220 g (7.8 oz)
	AYC-M6255: 215 g (7.6 oz.)

---

### 3. Mounting

Before mounting, you should determine the best location for the reader.

***To mount the units:***

1. Peel off the back of the self-adhesive mounting label template and place it at the required mounting location.
2. Using the template as a guide, drill two holes (sizes indicated on the template) used for mounting the back plate onto the surface.
3. Insert a suitable wall plug into each screw hole.
4. Drill a 10-mm (7/16") hole for the cable. If mounting on metal, place a grommet or electrical tape around the edge of the hole.
5. Wire the reader as described in Chapter 4. A linear type power supply is recommended.
6. Remove the reader's snap-off front cover to reveal the two screw holes (see Figure 1).

**Figure 1: Removing the Top Cover**

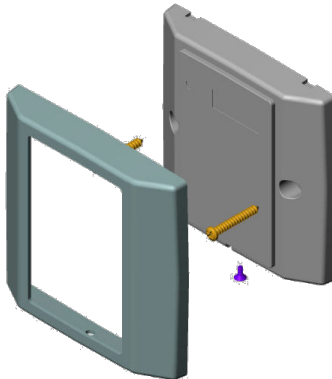

## Mounting

---

7. Align the two holes of the reader with those drilled in the wall and firmly attach the reader to the wall with two screws, whose size is indicated on the template.
8. Relocate the front cover onto the reader.



The reader can also be mounted using strong epoxy glue. After application, the reader should be firmly held in place until the glue dries

## 4. Wiring Instructions

The units are supplied with a 10-conductor 18" (46 cm) pigtail or with 10 terminal blocks.

### ***To connect a pigtail reader to the controller:***

1. Prepare the reader cable by cutting its jacket back 3.2 cm (1¼") and strip the insulation from the wires 1.3 cm (½").
2. Prepare the controller cable by cutting its jacket back 3.2 cm (1¼") and strip the insulation from the wires 1.3 cm (½").
3. Splice the reader's pigtail wires to the corresponding controller wires (as indicated in Table 1) and cover each joint with insulating tape.

**Table 1: Wiring**

<b>Terminals</b>	<b>Wire Color</b>	<b>Output</b>
1	Red	Power
2	Black	Ground
3	Green	Data 0 / Data
4	White	Data 1 / Clock
5	Blue	OSDP / RS-485-A2
6	Gray	OSDP / RS-485-B2
7	Orange	LED Control 1
8	Brown	LED Control 2
9	Yellow	Auxiliary Input
10	Purple	Tamper Output

4. If the tamper output is being utilized, connect the purple wire to the correct input on the controller.

The LED control may be configured by the factory to function either as a LED control or as buzzer control. Currently, Auxiliary Input is used as buzzer control and LED Control 1 is used as the green LED control.

5. Trim and cover all unused conductors.

## Wiring Instructions

---



Note

- The individual wires from the reader are color coded according the Wiegand standard.
- When using a separate power supply for the reader, this supply and that of the controller must have a common ground.
- The reader's cable shield wire should be preferably attached to an earth ground, or a signal ground connection at the panel, or power supply end of the cable. This configuration is best for shielding the reader cable from external interference.



## 5. Reader Operation

Once the reader is wired to a power supply and to the controller, you should test the reader.

### ***To test the reader:***

1. Power up the reader.

To indicate that the reader is working properly, the reader flashes red, then green, and then orange, each for 1 second and a beep is heard for each color. The LED returns to its idle state (red).

2. Present the appropriate type of proximity card to the reader.

The LED momentarily flashes green and a short beep is emitted indicating that the card was read properly by the reader.

The reader transmits the card's data to the controller.

# 6. OSDP Operation

CSN SELECT readers that support OSDP operation are compatible with most OSDP commands. The reader address is set using DIP switches on the back of the reader.

The DIP switch settings are as follows:

### **DIP Switch 1**

This switch is used to select the reader output (Wiegand or OSDP):

- Off = Wiegand
- On = OSDP

### **DIP Switch 2**

This switch is reserved for future use.

### **DIP Switch 3**

This switch is reserved for future use.

### **DIP Switches 4 to 8**

These switches set the address of the reader for OSDP protocol.

DIP Switch 4 is MSB and DIP Switch 8 is LSB. The address is the DIP switch state +1.

Examples:

- All the DIP switches in Off position, state is = 0 => address = 1
- All the DIP switches in On position, state is = 0x1F => address = 0x20 = 32
- DIP switches 4, 6, 8 in On position and 5, 7 in Off position, state is = 0x15 => address = 0x16 = 22

## 7. Reader Functionality

Upon power-on reset, the unit searches for the presence of Rosslare's secure application appurtenances. If a secured controller is not detected, it is automatically configured as a reader, as indicated by the red Mode LED.

This chapter explains how the AYC-x6355 series functions as a reader.

### 7.1 Transmit Mode

When the unit is in Transmit mode, it is ready to receive data from a presented proximity card or from an entered PIN code.

When the reader is in Transmit mode, the Transmit LED is red and the Program LED is off.

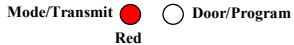

When a proximity card or PIN entry is being transmitted, the Transmit LED flashes green.



Keyboard data can be sent via one of eight different Keypad Transmission Formats (see Section 7.2.3).

Proximity cards presented to the reader are always sent in either Wiegand 26-Bit or Clock & Data format (see Section 7.2.4).

### 7.2 Programming the AYC-x6355 Series

Programming the AYC-x6355 is done solely via the unit's keypad driven Programming Menu System. During the AYC-x6355's manufacturing process, certain codes and settings are pre-programmed. These settings are called the default factory settings.

Table 2 shows the names of all the AYC-x6355 reader menus.

Default factory settings are marked by a "\*" sign.

**Table 2: Reader Programming Menus**

<b>Menu Description</b>	<b>Default</b>
<b>1 Selecting Keypad Transmission Format</b> Single Key, 6-Bit Wiegand (Rosslare Format) Single Key, 6-Bit Wiegand with Nibble + Parity Bits Single Key, 8-Bit Wiegand, Nibbles Complemented 4 Keys Binary + Facility Code, Wiegand 26-Bit 1 to 5 Keys + Facility Code, Wiegand 26-Bit 6 Keys BCD and Parity Bits, Wiegand 26-Bit 1 to 8 Keys BCD, Clock & Data Single Key, Wiegand 4-Bit	*
<b>2 Selecting Card Transmission Format</b> Wiegand 26-Bit Clock & Data	*
<b>3 Changing the Programming Code</b>	<b>1234</b>
<b>4 Changing the Facility Code</b>	<b>0</b>
<b>6 Backlight Options</b> Off On (Default) Off until key press when on for 10 seconds Dimmed until key press when on for 10 seconds	*
<b>0 Return to Factory Default Settings</b>	

## 7.2.1 Entering Programming Mode

To reach the Programming Menu System, the AYC-x6355 must first be placed into Programming mode.

### *To enter Programming mode:*

1. Press # 4 times.

The Transmit LED turns off and the Program LED turns red.

Mode/Transmit   Door/Program  
Red

2. Enter your 4-digit Programming code.

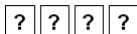

If the Programming code is valid, the Door LED turns green and the unit enters Programming mode.

Mode/Transmit   Door/Program  
Green



Note

- The factory 4-digit Programming code is 1234.
- If a Programming code is not entered within 20 seconds, the unit returns to Transmit mode.

## 7.2.2 Exiting Programming Mode

### *To exit Programming mode:*

1. Press # to exit the Programming mode at any time.
  - You hear a beep.
  - The Program LED turns off and the Transmit LED turns red.

Mode/Transmit   Door/Program  
Red

This indicates that the unit has returned to Transmit mode.

Wrong entries may reset the reader back to Transmit mode.

While in Programming mode, if no key is pressed for 20 seconds, the unit exits Programming mode and returns to Transmit mode.

### 7.2.3 Selecting Keypad Transmission Format

The AYC-x6355 has eight different keypad transmission formats. See Table 3 in Section 7.2.3.1 for more information on keypad transmission formats.

*To select the appropriate keypad transmission format:*

1. Enter Programming mode. Mode/Transmit   Door/Program  
Green

2. Press **1** to enter Menu 1.  1

The Transmit LED turns red. Mode/Transmit   Door/Program  
Red Green

3. Enter the appropriate option number for the keypad transmission format that you wish to select.  ?

You hear three beeps.  
The system returns to Transmit mode. Mode/Transmit   Door/Program  
Red

If an incorrect option number is entered, the reader returns to Transmit mode and the keypad transmission format remains unchanged.



**Note**

- Only one keypad transmission format can be active at any one time.
- When using the keypad transmission format "1 to 8 keys BCD, Clock & Data" (Option 8), an additional input is required to specify the number of keys in the PIN code.

### 7.2.3.1 Keypad Transmission Format Option Number

Table 3 presents the nine different keypad transmission formats.

**Table 3: Keypad Transmission Format Option Number**

Keypad Transmission Format	Option Number
Single Key, Wiegand 6-Bit (Rosslare Format)	1*
Single Key, Wiegand 6-Bit with Nibble + Parity Bits	2
Single Key, Wiegand 8-Bit, Nibbles Complemented	3
4 Keys Binary + Facility Code, Wiegand 26-Bit	4
1 to 5 Keys + Facility Code, Wiegand 26-Bit	5
6 Keys BCD and Parity Bits, Wiegand 26-Bit	6
1 to 8 Keys BCD, Clock & Data Single Key	8
Single Key, Wiegand 4-Bit	9

\* Option 1 is the default factory setting.

More information on each of the different keypad transmission formats is available below and on the following pages.

#### **Option 1: Single Key, Wiegand 6-Bit (Rosslare Format)**

Each key press immediately sends 4 bits with 2 parity bits added – even parity for the first 3 bits and odd parity for the last 3 bits.

0 = 1 1010 0 = "A" in Hexadecimal	6 = 1 0110 0
1 = 0 0001 0	7 = 1 0111 1
2 = 0 0010 0	8 = 1 1000 1
3 = 0 0011 1	9 = 1 1001 0
4 = 1 0100 1	*☺ = 1 1011 1 = "B" in Hexadecimal
5 = 1 0101 0	# = 0 1100 1 = "C" in Hexadecimal

### Option 2: Single Key, Wiegand 6-Bit Nibble and Parities

Each key press immediately sends 4 bits with 2 parity bits added – even parity for the first 3 bits and odd parity for the last 3 bits.

0 = 0 0000 1	6 = 1 0110 0
1 = 0 0001 0	7 = 1 0111 1
2 = 0 0010 0	8 = 1 1000 1
3 = 0 0011 1	9 = 1 1001 0
4 = 1 0100 1	Ⓐ = 1 1010 0 = "A" in Hexadecimal
5 = 1 0101 0	# = 1 1011 1 = "B" in Hexadecimal

### Option 3: Single Key, Wiegand 8-Bit Nibbles Complemented

This option inverts the most significant bits in the message leaving the least 4 significant bits as a Binary Coded Decimal (BCD) representation of the key. The host system receives an 8-bit message.

0 = 11110000	6 = 10010110
1 = 11100001	7 = 10000111
2 = 11010010	8 = 01111000
3 = 11000011	9 = 01101001
4 = 10110100	Ⓐ = 01011010 = "A" in Hexadecimal
5 = 10100101	# = 01001011 = "B" in Hexadecimal

### Option 4: 4 Keys Binary + Facility Code, Wiegand 26-Bit

This option buffers 4 keys and outputs keypad data with a 3-digit Facility code like a standard 26-Bit card output.

The Facility code is set in Programming Menu number four and can be in the range 000 to 255. The factory default setting for the Facility code is 000 (see Section 7.2.6).

The keypad PIN code is 4-digit long and can range between 0000 and 9999. On the fourth key press of the 4-digit PIN code, the data is sent across the Wiegand Data lines as binary data in the same format as a 26-Bit Card.

If Ⓐ or # are pressed during PIN code entry, the keypad clears the PIN code entry buffer, generate a beep and is ready to receive a new 4-digit keypad PIN code.



If the entry of the 4-digit keypad PIN code is disrupted and no number key is pressed within 5 seconds, the keypad clears the PIN code entry buffer, generate a beep and is ready to receive a new 4-digit keypad PIN code.

(EP) FFFF FFFF AAAA AAAA AAAA AAAA (OP)

Where:

EP = Even parity for first 12 bits

OP = Odd parity for last 12 bits

F = 8-bit Facility code

A = 16-bit code generated from keyboard

#### **Option 5: 1 to 5 Keys + Facility Code, Wiegand 26-Bit**

Option 5 buffers up to 5 keys and outputs keypad data with a Facility code like a 26-Bit card output.

The Facility code is set in Programming Menu number four and can be in the range 000 to 255. The factory default setting for the Facility code is 000 (see Section 7.2.6).

The keypad PIN code can be one to five digits in length and can range between 1 and 65,535. When entering a keypad PIN code that is less than 5 digits in length, # must be pressed to signify the end of PIN code entry. For keypad PIN codes that are 5 digits in length, on the fifth key press of the 5-digit PIN code, the data is sent across the Wiegand Data lines as binary data in the same format as a 26-Bit Card.

If  is pressed during PIN code entry or a PIN code greater than 65,535 is entered, the keypad clears the PIN code entry buffer, generates a beep and is ready to receive a new 5-digit keypad PIN code.

If the entry of the 1- to 5-digit keypad PIN code is disrupted and a number key or # is not pressed within 5 seconds, the keypad clears the PIN code entry buffer, generates a medium length beep and is ready to receive a new 1- to 5-digit keypad PIN code.

## Reader Functionality

---

(EP) FFFF FFFF AAAA AAAA AAAA AAAA (OP)

Where:

EP = Even parity for first 12 bits

OP = Odd parity for last 12 bits

F = 8-bit Facility code

A = 16-bit code generated from keyboard

### **Option 6: 6 Keys BCD and Parity Bits, Wiegand 26-Bit**

Option 6 sends buffer of 6 keys, adds parity and sends a 26-Bit Binary BCD message. Each key is a four bit equivalent of the decimal number.

The keypad PIN code must be 6 key presses long. On the sixth key press of the 6-digit PIN code, the data is sent across the Wiegand Data lines as a BCD message.

If the entry of the 6-digit keypad PIN code is disrupted and no number key is pressed within 5 seconds, the keypad clears the PIN code entry buffer, generates a medium length beep and is ready to receive a new 6-digit keypad PIN code.

(EP) AAAA BBBB CCCC DDDD EEEE FFFF (OP)

Where:

EP = Even parity for first 12 bits

OP = Odd parity for last 12 bits

A = The first key entered

D = Fourth key entered

B = Second key entered

E = Fifth key entered

C = Third key entered

F = Sixth key entered

### **Option 7: 1 to 8 Keys BCD, Clock & Data**

Buffers up to 8 keys and outputs keypad data without a Facility code like standard Clock and Data card output.

The keypad PIN code can be one to eight digits in length. The PIN code length is selected while programming the reader for Option 8. The reader transmits the data when it receives the last key press of

the PIN code. The data is sent across the two data output lines as binary data in Clock & Data format.

If **⏏** or **#** key are pressed during PIN code entry, the keypad clears the PIN code entry buffer, generates a beep, and is ready to receive a new keypad PIN code.

If the entry of the digit keypad PIN code is disrupted and a number key or **#** is not pressed within 5 seconds, the keypad clears the PIN code entry buffer, generates a medium length beep, and is ready to receive a new keypad PIN code.



When using the keypad transmission format "1 to 8 keys BCD, Clock & Data" (Option 8) an additional input is required to specify the number of keys in the PIN code.

### Option 8: Single Key, Wiegand 4-Bit

Each key press immediately sends 4 bits of data, with no parity bits added.

0 = 0000	6 = 0110
1 = 0001	7 = 0111
2 = 0010	8 = 1000
3 = 0011	9 = 1001
4 = 0100	* = 1010 = "A" in Hexadecimal
5 = 0101	# = 1011 = "B" in Hexadecimal

## 7.2.4 Selecting Proximity Card Transmission Format

The AYC-x6355 has three different proximity card formats to select from.

*To select the Proximity Card Transmission format:*

- Enter Programming mode.
 

Mode/Transmit	<input type="radio"/>	<input checked="" type="radio"/> Door/Program
		Green
- Press **2** to enter Menu 2.
 

2
---

The Transmit LED turns red.

Mode/Transmit	<input checked="" type="radio"/>	<input type="radio"/> Door/Program
	Red	Green

3. Enter the appropriate option number for the proxy card transmission format that you wish to select:
  - Option 1: Wiegand 26-Bit
  - Option 2: Clock & Data

You hear three beeps.

The system returns to Transmit mode.

Mode/Transmit  Door/Program   
Red

If the Programming code is invalid, you hear a long beep and the controller returns to Normal mode.

### 7.2.4.1 "Wiegand Card + PIN" Transmission Format

This unique mode is intended to let host controllers get card and keypad data simultaneously. This option overrides the selected Keypad Transmission Format and sends the keypad data as described below.

After a card is presented to the AYC-x6355, the program LED starts to flash in green and indicates that unit is waiting for the PIN code. If the entry of 1- to 5-digit keypad PIN code is disturbed and a number key or # is not pressed within 5 seconds, the keypad clears the card buffer and the PIN code entry buffer, generates a medium length beep, and is ready to receive a new card.

The keypad PIN code can be one to five digits in length in the range of 0 to 99,999. When entering a keypad PIN code, # must be pressed to signify the end of the PIN entry. When pressing #, the data is sent by the Wiegand data lines. If \* is pressed, the keypad clears the card buffer and the PIN code entry buffer, generates a medium length beep, and is ready to receive a new card.

The AYC-X6355 output card data comes in Wiegand 26-Bit with the following keypad data in Wiegand 26-Bit format:

- Card Data: (EP) AAAA AAAA AAAA BBBB BBBB BBBB (OP)

Where:

- EP = Even parity for first 12 A bits
- OP = Odd parity for last B 12 bits

- PIN Data: (EP) 0000 AAAA BBBB CCCC DDDD EEEE (OP)

Where:

A = The first key entered

D = Fourth key entered

B = Second key entered

E = Fifth key entered

C = Third key entered

EP = Even parity for first 12 bits

OP = Odd parity for last 12 bits

If the PIN code is less than 5 digits, all the most significant nibbles are filled with 0.

Example: (EP) 0000 0000 0000 0000 AAAA BBBB (OP)

Where:

A = The first key entered

B = Second key entered

EP = Even parity for first 12 bits

OP = Odd parity for last 12 bits

### 7.2.5 Changing the Programming Code

1. Enter Programming mode.

Mode/Transmit   Door/Program  
Green

2. Press **3** to enter Menu 3.

**3**

The Transmit LED turns red.

Mode/Transmit   Door/Program  
Red Green

3. Enter the new 4-digit code you wish to set as the Programming code.

**?** **?** **?** **?**

You hear three beeps.

The system returns to Transmit mode.

Mode/Transmit  Red    Door/Program  Green



Note

- The Programming code cannot be erased, meaning the code 0000 is invalid and does not erase the Programming code.
- The factory default 4-digit Programming code is 1234.

### 7.2.6 Changing the Facility Code

1. Enter Programming mode.

Mode/Transmit  Red    Door/Program  Green

2. Press **4** to enter Menu 4.

4

The Transmit LED turns red.

Mode/Transmit  Red    Door/Program  Green

3. Enter the new 3-digit code you wish to set as the Facility code.

? ? ?

You hear three beeps.

The system returns to Transmit mode.

Mode/Transmit  Red    Door/Program  Green



Note

- The Facility code can be in the range of 000 to 255.
- The default Facility code is 0.

### 7.3 Setting the Backlight

1. Enter Programming mode.

Mode/Transmit  Red    Door/Program  Green

2. Press **6** to enter Menu 6.

6

The Transmit LED turns red.

Mode/Transmit  Red    Door/Program  Green

- Enter the appropriate option number for the backlight option that you wish to select:
  - 0** for always off
  - 1** for always on
  - 2** for 10 sec. backlight after a key is pressed otherwise off
  - 3** for 10 sec. backlight after a key is pressed otherwise dimmed

You hear three beeps.

The system returns to Transmit mode.



Mode/Transmit   Door/Program  
Red

## 7.4 Return to Factory Default Settings



You must be very careful before using this command! This erases the entire memory and return all codes to their factory default setting.

- Enter Programming mode.
 

Mode/Transmit   Door/Program  
Green
- Press **0** to enter Menu 0.
 



The Transmit and Program LEDs flash red.

Mode/Transmit   Door/Program  
Red Red

- Enter your 4-digit programming code.
 

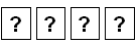

If the Programming code is valid, all memory is erased. You hear three beeps and the controller returns to Normal mode.

If the Programming code is invalid, you hear a long beep and the controller returns to Normal mode without erasing the memory of the controller.

### **7.5 Replacing a Lost Programming Code**

In the event that the Programming code is forgotten, the AYC-x6355 can be reprogrammed in the field using the following instructions:

1. Remove power from the reader.
2. Activate tamper by removing the reader from the wall or removing the reader's case.
3. Apply power to the reader.
4. You now have 10 seconds to enter Programming mode using the factory default Programming code 1234.



## 8. Controller Functionality

Upon power-on reset, the AYC-x6355 searches for the presence of Rosslare's secure application appurtenances. If a secure application appurtenance is detected, then the AYC-x6355 is automatically configured as a secure access control unit, as indicated by the orange Mode LED.

The Lock Strike and Auxiliary outputs, as well as the REX input, are not located on the AYC-x6355 unit, eliminating the possibility of unauthorized entry to the restricted area.

This chapter explains how the unit functions as a controller.

### 8.1 Normal, Secure, and Master Users

The AYC-x6355 accepts up to 500 users and provides entry via the use of PIN codes and/or proximity cards. Each user is provided with two code memory slots, Memory Slot 1 (Primary code) and Memory Slot 2 (Secondary code).

The PIN code length has several options. The PIN code length can be a set number of 4, 5 or 6 digits or it can be a 4-8 digits option. When choosing the 4- to 8-digit option, please note that you should either enter zeros before the code, or press pound at the end (for example, if your code is 12345, enter either **00012345** or **12345#**).



Entering a code refers to either PIN or card.

Note

The way in which the two memory slots are programmed determines a user's access level and also determines the way in which the unit grants access in its three modes of operation. There are three user levels:

- Normal user

A Normal user only has a Primary code and is only granted access when the unit is in Normal or Bypass mode.

- Secure user

A Secure user must have a Primary and Secondary code programmed; the two codes must not be the same. The Secure user can gain access when the unit is in any of its three modes of operation. In Normal mode, the Secure user must use their Primary code to gain entry. In Secure mode, the Secure user must present both the Primary and Secondary codes to gain entry.

- Master user

A Master user must have both Primary and Secondary codes programmed with the same PIN/card code. The Master user can gain access during any mode of operation by presenting their PIN/card code once to the controller. (The Master user is convenient but is less secure than a Secure user.)

## 8.2 Modes of Operation

The AYC-x6355 has three modes of operation:

### 8.2.1 Normal Mode

The Mode LED is green.

Mode/Transmit   Door/Program  
Green

Normal mode is the default mode. In Normal mode, the door is locked until a Primary code is presented to the controller. Special codes such as Lock Strike code and Auxiliary code are active in Normal mode. See Sections 8.9.3 and 0 for more information on the Lock Strike and Auxiliary codes.

### 8.2.2 Bypass Mode

The Mode LED is orange.

Mode/Transmit   Door/Program  
Orange

In Bypass mode, access to the premises is dependent on whether the controller's Lock Strike Relay is programmed for Fail Safe Operation or Fail Secure Operation. When the Lock Strike is programmed for Fail Secure Operation, the door is locked until  is pressed. When the

Lock Strike is programmed for Fail Safe Operation, the door is constantly unlocked.

### 8.2.3 Secure Mode

The Mode LED is red.

Mode/Transmit   Door/Program  
Red

Only Secure and Master users can access the premises during the Secured mode.

A Secure user must enter the Primary and Secondary codes to gain entry. After entering their Primary code, the Door LED flashes green for 10 seconds, during which the Secondary code must be entered. A Master user only needs to present the code once to gain entry.

### 8.2.4 Changing the Modes of Operation

#### 8.2.4.1 Changing from Normal Mode to Secure Mode

The default factory setting for the Normal/Secure code is **3838**.

1. Enter the Normal/Secure code. Mode/Transmit   Door/Program  
Green

The Mode LED flashes red.

Mode/Transmit   Door/Program  
Red

2. Press # to confirm the mode change.

Mode LED turns red.

Mode/Transmit   Door/Program  
Red

#### 8.2.4.2 Changing from Secure Mode to Normal Mode

The default factory setting for the Normal/Secure code is **3838**.

1. Enter the Normal/Secure code. Mode/Transmit   Door/Program  
Red

The Mode LED flashes green.

Mode/Transmit   Door/Program  
Green

## Controller Functionality

---

2. Press # key to confirm the mode change.

Mode LED turns green.

Mode/Transmit   Door/Program  
Green

### 8.2.4.3 Changing from Normal Mode to Bypass Mode

See Section 0 to create/modify the Normal/Bypass code.

1. Enter the Normal/Secure code. Mode/Transmit   Door/Program  
Green

The Mode LED flashes orange.

Mode/Transmit   Door/Program  
Orange

2. Press # key to confirm the mode change.

Mode LED turns orange.

Mode/Transmit   Door/Program  
Orange

### 8.2.4.4 Changing from Bypass Mode to Normal Mode

See Section 0 to create/modify the Normal/Bypass code.

1. Enter the Normal/Secure code. Mode/Transmit   Door/Program  
Orange

The Mode LED flashes green.

Mode/Transmit   Door/Program  
Green

2. Press # key to confirm the mode change.

Mode LED turns green.

Mode/Transmit   Door/Program  
Green

## 8.3 Auxiliary Input and Output

For optimum usability in different applications, the controller's auxiliary input and output can be configured in ten different modes of operation.

### 8.4 Door Alarms

Door alarms can be generated by connecting the Auxiliary Input to a Door Position Switch. Either Door-Forced or Door-Ajar conditions are supported, as well as, a configurable delay timer for each alarm type. Only one Door-alarm is enabled at any one time. Door alarms may activate auxiliary output and siren depending on the auxiliary settings.

### 8.5 Internal Case and Back Tamper

If the unit is forcibly opened or it is removed from the wall, a tamper event is triggered. A tamper output opens sending a to the connected Alarm system (purple wire) the event closes when the tamper is closed (case is re-closed or re-attached to the wall).

The tamper event can also activate the auxiliary output if the controller is in Auxiliary Mode 3 (see Table 5).

### 8.6 Lockout Feature (Keypad/Card Tamper)

If the controller is presented with wrong codes (PIN or card), consecutively several times the unit goes into lockout mode.

When a lockout occurs, the controller keypad is de-activated so no codes can be entered until the set lockout period expires.

During Lockout, Mode LED is Off, Door LED flashes red, and the controller beeps every two seconds.

### 8.7 REX Function

The REX button is connected to Rosslare's secure application appurtenance. The REX button must be located inside the premises to be secured and is used to open the door without the use of a code. It is usually located in a convenient location, such as inside the door or at a receptionist's desk. The function of the REX button depends on whether the Lock Strike Relay is programmed for Fail Safe Operation or Fail Secure Operation.

- Fail Secure Operation – From the moment the REX button is pressed, the door is unlocked until the Lock Strike Release Time

passes. After this time, the door is locked even if the REX button is not released.

- Fail Safe Operation – From the moment the REX button is pressed, the door is unlocked until the REX button is released, plus the Lock Strike Release Time. In this case, the Lock Strike Relay only begins its count down once the REX button is released.

### **8.8 Secure Application Appurtenances**

Rosslare's secure application appurtenances are designed for use with Rosslare's secured series standalone access control units, including the AYC-x6355 series. These units are designed to operate indoors and installed within the secured premises. The units must be used with one of Rosslare's secure application appurtenances, which provide Lock Strike output and REX Input.

Both units communicate through a proprietary Rosslare protocol, which provides a secure link between the AYC-x6355 and the appurtenances. This in turn activates the door lock.

The units also function as the power supply for the AYC-x6355; they also contain a speaker connection for all sounder abilities.

For more information see the specific Appurtenances Manual.

### **8.9 Programming the AYC-x6355**

Programming the AYC-x6355 is done solely via the unit's keypad driven Programming Menu System. To reach the Programming Menu System, the unit must first be put into Programming mode (see Section 8.9.1).

During a unit's manufacturing process, certain codes and settings are pre-programmed. These settings are the called the default factory settings.

Table 4 shows the names of all the AYC-x6355 controller menus. It also shows of all the default factory codes and settings for the units.

Table 4: Controller Programming Menu

Menu No.	Menu Description	Default			
		4 digits	5 digits	6 digits	4-8 digits
1	Changing Lock Strike Code	2580	25802	258025	25802580
2	Change Auxiliary Code	0852	08520	085208	08520852
3	Changing Program Code	1234	12341	123412	12341234
4	Changing Normal/Secure Code	3838	38383	383838	38383838
5	Changing Normal/Bypass Code	N/A			
6	Changing Door Release Time	0004			
	Define auxiliary inputs/outputs	2004			
	Set Lockout	4000			
	Backlight Behavior	5100			
7	Enrolling PIN Code				
8	Deleting PIN Code				
9	Code assignment with strike/auxiliary				
0	Return to factory defaults or change PIN code Length				

You will find a complete description and instructions for each of the above menu items on the following subsections.

### 8.9.1 Entering Programming Mode

1. Press # twice within 2 seconds.

The Mode LED turns off and the Door LED turns red.

Mode/Transmit   Door/Program Red

2. Enter your Programming code.

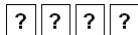

The Door LED turns green.

Mode/Transmit   Door/Program Green

### 8.9.2 Exiting Programming Mode

1. Press **#** twice.

You hear a long beep.

The Door LED turns off and the Mode LED returns to Normal mode.

Mode/Transmit  Green  Door/Program

Wrong entries reset the controller back to Normal mode.

While in Programming mode, if no key is pressed for one minute, the unit exits Programming mode and returns to Normal mode.

### 8.9.3 Changing Lock Strike Code

The Lock Strike code is mainly used as a method to quickly test the Lock Strike Relay during installation.

When the first user is added to the controller, the default Lock Strike code is automatically deleted. Once the code is programmed again, it is not deleted with the entry of additional user codes.

1. Enter Programming mode.

Mode/Transmit   Door/Program  
Green

2. Press **1** to enter Menu 1.

1

The Mode LED turns red.

Mode/Transmit  Red  Door/Program  
Green

3. Enter the new code you wish to set as Lock Strike Code 1.

? ? ? ?

You hear three beeps.

The system returns to Normal mode.

Mode/Transmit  Green  Door/Program  
Green





Note

- Lock Strike Code 1 does not work in the Secure mode.
- Wrong entries returns the controller to Normal mode.
- Code 0000 erases the Lock Strike Code 1.
- The factory default 4-digit Lock Strike code is 2580.

## 8.9.4 Changing Auxiliary Code

The Auxiliary code is mainly used as a method to quickly test the Auxiliary Relay during installation.

When the first user is added to the controller, the default Auxiliary code is automatically deleted. Once the code is programmed again, it is not deleted with the entry of additional user codes.

1. Enter Programming mode.

Mode/Transmit   Door/Program  
Green

2. Press **2** to enter Menu 2.

**2**

The Mode LED turns orange.

Mode/Transmit   Door/Program  
Orange Green

3. Enter the new code you wish to set as the Auxiliary code.

You hear three beeps.

The system returns to Normal mode.





Mode/Transmit   Door/Program  
Green



Note

- Auxiliary code does not work in the Secure mode.
- Wrong entries return the controller to Normal mode.
- Code 0000 erases the Auxiliary code.
- The factory default 4-digit Auxiliary code is 0852.

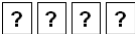
### 8.9.5 Changing the Programming Code



1. Enter Programming mode.   
Mode/Transmit  Door/Program  
Green
2. Press **3** to enter Menu 3.   
The Mode LED turns green.   
Mode/Transmit  Door/Program  
Green Green
3. Enter the new code you wish to set as the Programming code.   
You hear three beeps.  
The system returns to Normal mode.   
Mode/Transmit  Door/Program  
Green



Note

- Programming code cannot be erased, meaning the code 0000 is not valid and does not erase the Programming code.
- The factory four-digit programming code is 1234.

### 8.9.6 Changing the Normal/Secure Code

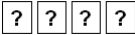
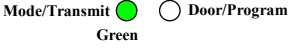
1. Enter Programming mode.   
Mode/Transmit  Door/Program  
Green
2. Press **4** to enter Menu 4.   
The Mode LED flashes red.   
Mode/Transmit  Door/Program  
Red Green
3. Enter the new code you wish to set as Normal/Secure code.   
You hear three beeps.  
The system returns to Normal mode.   
Mode/Transmit  Door/Program  
Green



- Code 0000 erases the Normal/Secure code.
- This code is disabled if the Auxiliary Input is set to toggle between Normal and Secure access modes.
- Default Normal/Secure code is 3838.

## 8.9.7 Changing the Normal/Bypass Code and Door Chime Settings

1. Enter Programming mode.

Mode/Transmit   Door/Program  
Green

2. Press **5** to enter Menu 5.

5

The Mode LED flashes orange.

Mode/Transmit   Door/Program  
Orange Green

3. Enter the new code you wish to set as Normal/Secure code.

? ? ? ?

There are four different ways to program the Normal/Bypass code and door chime.

- a. Enter the code **0000** to disable both Bypass code and the door chime.

0 0 0 0

- b. Enter the code **0001** to disable the Bypass code and enable the door chime.

0 0 0 1

- c. Enter any code ending with 0 to enable the Bypass code and disable the door chime.

? ? ? 0

- d. Enter a code not ending with 0 to enable the Bypass code and enable the door chime.

? ? ? ~~0~~

## Controller Functionality

You hear three beeps.

The system returns to Normal mode.

Mode/Transmit   Door/Program  
Green



### 8.9.8 Setting Fail Safe/Secure Operation, Tamper Siren and Lock Strike Release Time

1. Enter Programming mode.

Mode/Transmit   Door/Program  
Green

2. Press **6** to enter Menu 6.

The Mode LED flashes green.

  
Mode/Transmit   Door/Program  
Green Green

3. Construct a code using the following instructions:

- First Digit  
For Fail Secure Operation, the first digit should be **0**.  
For Fail Safe Operation the first digit should be **1**.
- Second Digit  
Siren Time in minutes (1-9, 0-disabled)
- Third and Fourth Digits  
Enter the number of seconds (from 1 to 99) that you want the Lock Strike to be released.

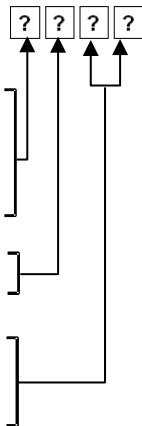

For example, 0312 means a Fail Secure Operation consisting of a 3-minute siren and a 12-second Lock Strike release time.

You hear three beeps.

The system returns to Normal mode.

Mode/Transmit   Door/Program  
Green



The default value is 0004, which corresponds to Fail Secure operation, no siren, and 4-seconds Lock Strike release time.

## 8.9.9 Defining the Auxiliary Input and Output

1. Enter Programming mode.

Mode/Transmit   Door/Program  
Green

2. Press **6** to enter Menu 6.

6

The Mode LED flashes green.

Mode/Transmit   Door/Program  
Green Green

3. Construct a code using the following instructions:

Auxiliary mode  
Auxiliary setting

2 ? ? ?

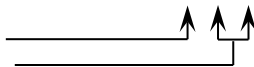

- Auxiliary mode

In addition to the Lock Strike Relay and Lock Strike REX, the unit features an Auxiliary Input. The Auxiliary mode defines the function of the Auxiliary Input.

Each of the Auxiliary modes has a two-digit setting that affects how the Auxiliary mode functions.

- Auxiliary settings

The second digit defines the Auxiliary Input function while the third and fourth digits either may have no meaning or may define delay times for door monitor functions (Table 5).

You hear three beeps.

The system returns to Normal mode.

Mode/Transmit   Door/Program  
Green

## Controller Functionality

Table 5: Quick Reference Guide for Auxiliary Mode Setting

<b>Aux. Mode</b>	<b>Aux. Input Function</b>	<b>Aux. Output Activated by</b>	<b>Aux. Relay</b>	<b>Aux. Settings (in seconds)</b>
0	AUX REX	Valid code or AUX REX	N.O.	01 to 99 Aux. relay release time
1	Normal/Secure switch	Valid code	N.O.	01 to 99 Aux. relay release time
2	Normal/Secure switch	Star button (*)	N.O.	01 to 99 Aux. relay release time
3	Normal/Secure switch	Tamper event	N.C.	01 to 99 Aux. relay release time
6	Door Monitor	Forced door	N.C.	01 to 99 Forced delay
7	Door Monitor	Door ajar	N.C.	01 to 99 Ajar delay
8	LED control – Green	Valid code	N.O.	01 to 99 Aux. relay release time
9	LED control – Red	Valid code	N.O.	01 to 99 Aux. relay release time

### 8.9.10 Detailed Reference Guide

The following are brief descriptions of each auxiliary mode. To implement the features of each mode, refer to Section 8.9.9.

#### 8.9.10.1 Auxiliary Mode 0

**Auxiliary input function:** Activates the auxiliary output

**Auxiliary output activated by:** Valid user code, Auxiliary code, and Auxiliary input

For example, in Auxiliary Mode 0, the controller can function as a two-door controller. The auxiliary relay is to be attached to the lock on the second door. The auxiliary setting defines the door open time for the second door. The auxiliary input is to be attached to the REX pushbutton for the second door. The Door Monitor input feature for the second door is not enabled when using this mode.

#### 8.9.10.2 Auxiliary Mode 1

**Auxiliary input function:** Toggles Normal/Secure modes

**Auxiliary output activated by:** Valid user code, Auxiliary code

For example, in Auxiliary Mode 1, the controller can function as a two-door controller. The auxiliary relay is to be attached to the lock on the second door. The REX feature for the second door is not enabled when using this mode.

The auxiliary setting defines the door open time for the second door. The auxiliary input can switch the mode of operation of the controller between Normal and Secure modes. By connecting a switch timer or alarm system output to the auxiliary input, the controller can be automatically switched from Normal mode (during office hours) to Secure mode (after office hours).

### 8.9.10.3 Auxiliary Mode 2

**Auxiliary input function:** Toggles Normal/Secure modes

**Auxiliary output activated by:** Bell Button (🔔)

For example, in Auxiliary Mode 2, the auxiliary relay can function as a general purpose time switch that can be activated when 🔔 is pressed. The auxiliary setting establishes for how long the auxiliary relay is to be activated. The auxiliary input can switch the mode of operation of the controller between Normal and Secure modes. By connecting a switch timer or alarm system output to the auxiliary input, the controller can be automatically switched from Normal mode (during office hours) to Secure mode (after office hours).

### 8.9.10.4 Auxiliary Mode 3

**Auxiliary input function:** Toggles Normal/Secure modes

**Auxiliary output activated by:** Alarms

For example, in Auxiliary Mode 3, the auxiliary output is activated if the controller is tampered; that is, if the case is forcibly opened or removed from the wall. The auxiliary input can switch the mode of operation of the controller between Normal and Secure modes. By connecting a switch timer or alarm system output to the auxiliary input, the controller can be automatically switched from Normal mode (during office hours) to Secure mode (after office hours).

### 8.9.10.5 Auxiliary Mode 4

**Auxiliary input function:** Door Monitor

**Auxiliary output activated by:** Forced entry

For example, in Auxiliary Mode 6, the controller can trigger the auxiliary relay if the door has been forced. If the siren settings are enabled, the siren is activated.

In this mode, the auxiliary input functions as a door monitor switch and is wired to the magnetic contact switch on the door. The auxiliary relay is to be wired to the alarm system. If the door is forced open, the controller waits for the period of the forced door delay time to elapse and then it activates the auxiliary relay. The auxiliary setting sets the forced door delay period.



### 8.9.10.6 Auxiliary Mode 5

**Auxiliary input function:** Door Monitor

**Auxiliary output activated by:** Door Ajar (door held open)

For example, in Auxiliary Mode 7, the controller can trigger the auxiliary relay, if it detects that the door has been held open (ajar) too long. In this mode the auxiliary input functions as a door monitor switch and is wired to the magnetic contact switch on the door. The auxiliary relay is to be wired to the alarm system. If the door is opened, the controller waits for the door ajar delay time to elapse and if the door does not close prior to the end of this period, the controller activates the auxiliary relay. The auxiliary setting defines the door-ajar time.

### 8.9.10.7 Auxiliary Mode 6

**Auxiliary input function:** Green LED control

**Auxiliary output activated by:** Valid user code, Auxiliary code

For example, in Auxiliary Mode 8, the controller can function as a two-door controller and also provide indicator functionality control. The auxiliary relay is connected to the lock on the second door. The auxiliary setting defines the door open time for the second door. The auxiliary input is used to control the Door indicator. If the auxiliary input is open, the indicator flashes green; if the auxiliary input is closed, the door indicator flashes red.



Note

This mode takes control of the Door indicator LED.

The indicator LED is not be lit when:

- A valid code is entered
- While in secure mode, when waiting for a secondary code

### 8.9.10.8 Auxiliary Mode 7

**Auxiliary input function:** Red LED control

**Auxiliary output activated by:** Valid user code, Auxiliary code

For example, in Auxiliary Mode 9, the controller can function as a two-door controller and also provide indicator functionality control. The auxiliary relay is connected to the lock on the second door. The

## Controller Functionality

auxiliary setting defines the door open time for the second door. The auxiliary input is used to control the indicator. If the auxiliary input is open the door indicator flashes red; if the auxiliary input is closed the door indicator flashes green.



This mode takes control of the Door indicator LED.

The indicator LED is not be lit when:

- A valid code is entered
- While in secure mode, when waiting for a Secondary code

### 8.9.11 Setting the Lockout Feature

If the controller is presented with wrong codes several times consecutively, the unit goes into Lockout mode.

When a lockout occurs, the controller keypad and reader are locked so no codes can be entered until the set lockout period expires.

During Lockout, Mode LED is off, Door LED flashes red, and the controller beeps every two seconds.

The default setting for the Lockout Feature is 4000 (Lockout Disabled).



Using the lockout feature is highly recommended, especially when selecting to use short PIN code length (4 or 5 digits).

1. Enter Programming mode.

Mode/Transmit  Door/Program  
Green

2. Press **6** to enter Menu 6.

6

The Mode LED flashes green.

Mode/Transmit  Door/Program  
Green Green

3. Construct a code using the following instructions:

4 ? ? ?

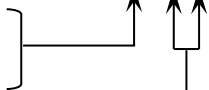

Set the number of wrong code attempts, which causes a Lockout between 0 and 9 attempts.

Sets the Duration of the lockout, between 00 and 99; the value is multiplied by ten, resulting in 0 to 990 seconds.

### 8.9.12 Setting the Backlight Behavior

The controller allows you to define the way the unit's backlight works.

1. Enter Programming mode.

Mode/Transmit   Door/Program  
Green

2. Press **6** to enter Menu 6.

**6**

The Mode LED flashes green.

Mode/Transmit   Door/Program  
Green Green

3. Construct a code using the following instructions:

The first digit is “5” indicating the backlight and LED option.

The second key can be 0-3 indicating the type of activity.

- Option 0 – Backlight Off
- Option 1 – Backlight On (default)
- Option 2 – Backlight Off, activated on any key press for ten seconds.
- Option 3 – Backlight Dimmed, backlight activated on any key press for ten seconds.

5 ? 0 0

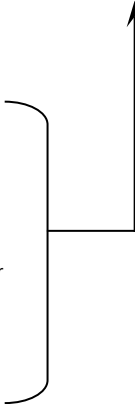

### 8.9.13 Enrolling Primary and Secondary Codes

#### 8.9.13.1 Primary Codes

- Primary codes can only be enrolled to an empty user slot, meaning a slot where there is no existing Primary code.
- Primary codes must be unique, meaning one user’s Primary code may not be the same as other user’s Primary code.
- Primary codes cannot be the same as any system codes, such as the Normal/Secure code or Lock Strike code.
- Users who hold a Primary code can gain entry only during Normal mode.

#### 8.9.13.2 Secondary Codes

- Secondary codes can only be enrolled to a user slot that already has a Primary code enrolled but has no Secondary code.
- Secondary codes do not have to be unique, meaning multiple users can all hold the same Secondary code.

- Secondary codes cannot be the same as any system codes, such as the Normal/Secure or Lock Strike codes.
- Users who hold Secondary codes can gain entry in any mode of operation.

### 8.9.13.3 Enrolling Primary and Secondary Codes

There are two methods to enroll Primary and Secondary codes:

- Standard Method

The Standard Method is mainly used when the user slot number for the user you wish to program is known. You can program both Primary and Secondary codes using the Standard method (see Section 8.9.13.4).

- Code Search Method

The Code Search Method is mainly used when enrolling a user's Secondary code and the user slot code is unknown.

The Code Search method only works if a user's Primary code is already enrolled but the Secondary code is not (see Section 8.9.13.5).

### 8.9.13.4 Enrolling Primary & Secondary Codes using Standard Method

1. Enter Programming mode.

Mode/Transmit   Door/Program  
Green

2. Press **7** to enter Menu 7.

**7**

The Door LED turns orange.

Mode/Transmit   Door/Program  
Orange

3. Enter the 3-digit user slot number between 001 and 500 that you wish to enroll a Primary or Secondary code to.

**?** **?** **?**

For example, User Slot 003 represents User #3.

## Controller Functionality

---

If the selected slot has no Primary code, the Mode LED flashes green, indicating that the controller is ready to accept a Primary code.

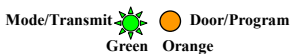

If the selected slot already has a Primary code but no Secondary code, the Mode LED flashes red, indicating that the controller is ready to accept a Secondary code.



If the selected slot already has a Primary and Secondary code, you hear a long beep and the controller returns to Normal mode.



4. Enter the 4- to 8-digit PIN code that you want to assign as the Primary or Secondary code for this slot number.

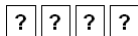

If the PIN that is entered is valid, the Mode LED stops flashing and then the controller is ready for you to enter the next 3-digit slot number (refer to Step 2) that you want to assign a code to.

5. Press # to move to the next slot number.

If you do not wish to continue enrolling codes, press # twice and the controller returns to Normal mode.

### 8.9.13.5 Enrolling Secondary Codes using Search Method

The Code Search feature enables you to quickly enroll a Secondary code to a user who already has a Primary code.

1. Enter Programming mode.



2. Press **7** to enter Menu 7.

**7**

The Door LED turns orange.

Mode/Transmit



Door/Program  
Orange

3. Enter 000 as the 3-digit user slot number.

**0 0 0**

The Door LED flashes orange.

Mode/Transmit



Door/Program  
Orange

The controller is now waiting for the Primary code of the user to whom you want to add a Secondary code.

4. Enter the 4- to 8-digit PIN code of the Primary code belonging to the user to whom you want to add a Secondary code.

5. The Mode LED flashes red.

Mode/Transmit



Red



Orange

Door/Program  
Orange

If the Primary code entered is not valid, you hear a long beep and the unit continues to wait for a valid Primary code.

6. Enter the 4- to 8-digit code to be used as the Secondary code.

If the Secondary code is valid, the controller beeps three times and returns to Normal mode.

If the Secondary code is invalid, the controller sounds a long beep, and the unit continues to wait for a valid Secondary code to be entered.

### 8.9.14 Deleting Primary and Secondary Codes

There are two methods to delete Primary and Secondary codes: the Standard Method and the Code Search Method.



When deleting a user slot, both the Primary code and the Secondary code are erased.

## Controller Functionality

### 8.9.14.1 Deleting Primary & Secondary Codes using Standard Method

1. Enter Programming mode. Mode/Transmit   Door/Program Green

2. Press **8** to enter Menu 8. 





The Mode LED turns red and the Door LED turns orange. Mode/Transmit   Door/Program Red Orange

3. Enter the 3-digit user slot code you wish to delete.   

The Mode LED flashes red indicating the controller is waiting for the Programming code to confirm the deletion.

Mode/Transmit   Door/Program Red Orange

If the user slot is empty, you hear a long beep and the unit returns to Normal mode.

4. Enter your programming code to confirm the deletion.    

If the programming code is valid, three beeps are heard and the controller returns to Normal mode.

If the programming code is invalid, a long beep is heard and the controller returns to Normal mode.



Note

It is recommended that a record be kept of added and deleted users so that it is easier to keep track of which user slots are empty and which user slots are not.

### 8.9.14.2 Deleting Primary & Secondary Codes using Search Method



1. Enter Programming mode. Mode/Transmit   Door/Program Green



2. Press **8** to enter Menu 8.

**8**

The Mode LED turns red and the Door LED turns orange.

Mode/Transmit   Door/Program  
Red Orange

3. Enter 000 as the 3-digit user slot number.

**0 0 0**

The Mode LED turns red and the Door LED flashes orange.

Mode/Transmit   Door/Program  
Red Orange

The controller is now waiting for the Primary code of the user you want to delete.

4. Enter the 4- to 8-digit PIN code of the Primary code belonging to the user you want to delete.

**? ? ? ?**

The Mode LED flashes red and the Door LED flashes orange.

Mode/Transmit   Door/Program  
Red Orange

5. Enter your Programming code to confirm the deletion.

If the Programming code is valid, you hear three beeps and the unit returns to Normal mode.

If the Programming code is invalid, you hear a long beep and the unit returns to Normal mode.



Note

It is recommended that a record be kept of added and deleted users so that it is easier to keep track of which user slots are empty and which user slots are not.

## 8.9.15 Relay Codes Assignment

When a primary code is enrolled for any user, the user is authorized to activate the Lock Strike relay. However, different user codes may be set to operate the auxiliary relay instead or operate both the Lock strike and auxiliary relay. Assignment of such codes is achievable for any valid user code entered in the controller.

## Controller Functionality



---



There are two methods to assign relay codes to users: a standard method and a search method.



### 8.9.16 Relay Code Assignment using Standard Method

1. Enter Programming mode. Mode/Transmit  Door/Program   
Green

2. Press **9** to enter Menu 9. 

The Mode LED turns green and the Door LED turns orange. Mode/Transmit  Door/Program   
Green Orange

3. Enter the 3-digit user slot for code assignment.   

The Mode LED flashes green. Mode/Transmit  Door/Program   
Green Orange

4. Enter the assignment digit for the current user slot:
- **1** activates the Lock Strike relay only default
  - **2** activates the Auxiliary relay only
  - **3** activates the Lock Strike and Auxiliary relays

If the assignment code is valid, the Mode indicator stops flashing. The controller is now waiting for another slot number.

5. Press **#** to move to the next slot or enter a new slot number. If you do not wish to continue, press **#** twice and the controller returns to Normal mode.

### 8.9.17 Relay Code Assignment using Search Method

1. Enter Programming mode. Mode/Transmit  Door/Program   
Green

2. Press **9** to enter Menu 9. 

The Mode LED turns green and the Door LED turns orange.

Mode/Transmit  Door/Program   
Green Orange

3. Enter 000 for user slot access.

The Door LED flashes orange.

Mode/Transmit  Door/Program   
Green Orange

The controller is now waiting for the primary code of the user.

4. Enter the primary code belonging to the user

The Mode LED flashes green.

Mode/Transmit  Door/Program   
Green Orange

5. Enter the assignment digit for the current user slot:

- **1** activates the Lock Strike relay only default
- **2** activates the Auxiliary relay only
- **3** activates the Lock Strike and Auxiliary relays

If the assignment digit is valid, three beeps are heard and the controller returns to Normal mode.



If the assignment digit is invalid, a long beep sounds and the controller waits for another assignment digit to be entered.

### 8.9.18 PIN Code Length/Factory Default Settings



Warning

You must be very careful before using this command! Changing the PIN code length also erases the entire memory contents, including all user and special codes, and return all codes to their factory default settings.

1. Enter Programming mode. Mode/Transmit   Door/Program Green
2. Select the desired PIN code length as follows:
  - **00** – Returns to factory defaults and sets a 4-digit code.
  - **05** – Returns to factory defaults and sets a 5-digit code.
  - **06** – Returns to factory defaults and sets a 6-digit code.
  - **08** – Returns to factory defaults and sets a 4- to 8-digit code

Both the Mode and Door LEDs flash red.

Mode/Transmit   Door/Program Red Red

3. Enter your 4- to 8-digit Programming code

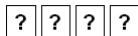

If the Programming code is valid, all memory is erased. You hear three beeps and the controller returns to Normal mode.

If the Programming code is invalid, you hear a long beep and the controller returns to Normal mode without erasing the memory contents.

### 8.9.19 Replacing a Lost Programming Code



The AYC-Ex5 and AYC-T65 must be in Normal mode; otherwise, this does not work. Make sure that the Mode LED is green before proceeding.

#### *To replace a lost Programming code:*

1. Remove power from the Power Supply Unit.
2. Press the REX button on the Power Supply Unit.
3. Apply power to the unit with REX button pressed.
4. Release the REX button.
5. You now have 10 seconds to program a new Programming code into the Access Control unit using the initial default code 1234, before the controller reverts to the existing code.

### 8.9.20 Exiting Secure Mode if Normal/Secure Code was Lost

*To exit Secure mode if Normal/Secure Code was lost:*

1. Remove power from the Power Supply Unit.
2. Press the REX button on the Power Supply Unit.
3. Apply power to the unit with the REX button pressed.
4. Release the REX button.
5. You now have 10 seconds to exit Secure mode using the initial default Normal/Secure code 3838.
6. Program a new normal/secure code as described in Section 0.

### A. Declaration of Conformity

This device complies with Part 15 of the FCC Rules. Operation is subject to the following two conditions:

- This device may not cause harmful interference.
- This device must accept any interference received, including interference that may cause undesired operation.

Changes or modifications not expressly approved by the party responsible for compliance could void the user's authority to operate the equipment.

This equipment has been tested and found to comply with the limits for a Class B digital device, pursuant to part 15 of the FCC Rules. These limits are designed to provide reasonable protection against harmful interference in a residential installation.

This equipment generates, uses, and can radiate radio frequency energy and, if not installed and used in accordance with the instructions, may cause harmful interference to radio communications. However, there is no guarantee that interference will not occur in a particular installation. If this equipment does cause harmful interference to radio or television reception, which can be determined by turning the equipment off and on, the user is encouraged to try to correct the interference by one or more of the following measures:

- Reorient or relocate the receiving antenna.
- Increase the separation between the equipment and receiver.
- Connect the equipment into an outlet on a circuit different from that to which the receiver is connected.
- Consult the dealer or an experienced radio/TV technician for help.

### B. Limited Warranty

The full ROSSLARE Limited Warranty Statement is available in the Quick Links section on the ROSSLARE website at [www.rosslaresecurity.com](http://www.rosslaresecurity.com).

Rosslare considers any use of this product as agreement to the Warranty Terms even if you do not review them.



AYC-x6355

## Asia Pacific, Middle East, Africa

Rosslare Enterprises Ltd.

Kowloon Bay, Hong Kong

Tel: +852-2795-5630

Fax: +852-2795-1508

support.apac@rosslaresecurity.com

## United States and Canada

Rosslare Security Products, Inc.

Southlake, TX, USA

Toll Free: +1-866-632-1101

Local: +1-817-305-0006

Fax: +1-817-305-0069

support.na@rosslaresecurity.com

## Europe

Rosslare Israel Ltd.

Rosh HaAyin, Israel

Tel: +972-3-938-6838

Fax: +972-3-938-6830

support.eu@rosslaresecurity.com

## Latin America

Rosslare Latin America

Buenos Aires, Argentina

Tel: +54-11-4001-3104

support.la@rosslaresecurity.com

## China

Rosslare Electronics (Shenzhen) Ltd.

Shenzhen, China

Tel: +86-755-8610 6842

Fax: +86-755-8610 6101

support.cn@rosslaresecurity.com

## India

Rosslare Electronics India Pvt Ltd.

Tel/Fax: +91-20-40147830

Mobile: +91-9975768824

sales.in@rosslaresecurity.com

**ROSSLARE**  
SECURITY PRODUCTS  
[www.rosslaresecurity.com](http://www.rosslaresecurity.com)



00-00606000-0706