

FCC REPORT

(GSM & WCDMA)

Applicant: Collage Investments LLC.

Address of Applicant: 6030 NW 99 Ave #414, DORAL, FL 33178, United States

Equipment Under Test (EUT)

Product Name: MOBILE PHONE

Model No.: 1 UNO 3G

Trade mark: S SMOOTH

FCC ID: GAO-ONE3G

FCC CFR Title 47 Part 2

Applicable standards: FCC CFR Title 47 Part 22 Subpart H

FCC CFR Title 47 Part 24 Subpart E

Date of sample receipt: 26 Mar., 2019

Date of Test: 26 Mar., to 18 Apr., 2019

Date of report issued: 18 Apr., 2019

Test Result: PASS*

* In the configuration tested, the EUT complied with the standards specified above.

Authorized Signature:

A blue circular stamp from CCIS Shenzhen Zhongjian Nanfang Testing Co., Ltd. is overlaid on a handwritten signature in blue ink.

Bruce Zhang
Laboratory Manager

This report details the results of the testing carried out on one sample. The results contained in this test report do not relate to other samples of the same product and does not permit the use of the CCIS product certification mark. The manufacturer should ensure that all products in series production are in conformity with the product sample detailed in this report.

This report may only be reproduced and distributed in full. If the product in this report is used in any configuration other than that detailed in the report, the manufacturer must ensure the new system complies with all relevant standards.

This document cannot be reproduced except in full, without prior written approval of the Company. Any unauthorized alteration, forgery or falsification of the content or appearance of this document is unlawful and offenders may be prosecuted to the fullest extent of the law. Unless otherwise stated the results shown in this test report refer only to the sample(s) tested and such sample(s) are retained for 90 days only.

2. Version

Version No.	Date	Description
00	18 Apr., 2019	Original
01	26 Apr., 2019	Update page 9/11/27 and 32~36

Tested by:

Mike.ou

Date:

18 Apr., 2019

Test Engineer

Reviewed by:

Wimer zhang

Date:

18 Apr., 2019

Project Engineer

3. Contents

	Page
1. COVER PAGE	1
2. VERSION	2
3. CONTENTS	3
4. TEST SUMMARY	4
5. GENERAL INFORMATION	5
5.1 CLIENT INFORMATION.....	5
5.2 GENERAL DESCRIPTION OF E.U.T.....	5
5.3 TEST MODES.....	7
5.4 DESCRIPTION OF SUPPORT UNITS.....	7
5.5 MEASUREMENT UNCERTAINTY.....	7
5.6 LABORATORY FACILITY.....	7
5.7 LABORATORY LOCATION.....	8
5.8 TEST INSTRUMENTS LIST.....	8
6. TEST RESULTS	9
6.1 CONDUCTED OUTPUT POWER, ERP AND EIRP.....	9
6.2 PEAK-TO-AVERAGE POWER RATIO.....	12
6.3 OCCUPY BANDWIDTH.....	14
6.4 MODULATION CHARACTERISTIC.....	20
6.5 OUT OF BAND EMISSION AT ANTENNA TERMINALS.....	20
6.6 FIELD STRENGTH OF SPURIOUS RADIATION MEASUREMENT.....	27
6.7 FREQUENCY STABILITY V.S. TEMPERATURE MEASUREMENT.....	32
6.8 FREQUENCY STABILITY V.S. VOLTAGE MEASUREMENT.....	35
7 TEST SETUP PHOTO	37
8 EUT CONSTRUCTIONAL DETAILS	38

4. Test Summary

Test Item	Section in CFR 47	Result
RF Exposure (SAR)	Part 1.1307 Part 2.1093	Pass (Please refer to SAR Report)
RF Output Power	Part 2.1046 Part 22.913 (a)(2) Part 24.232 (c)	Pass
Peak-to-Average Power Ratio	Part 24.232 (d)	Pass
Modulation Characteristics	Part 2.1047	Pass
99% & -26 dB Occupied Bandwidth	Part 2.1049 Part 22.917(b) Part 24.238(b)	Pass
Out of band emission at antenna terminals	Part 2.1053 Part 22.917 (a) Part 24.238 (a)	Pass
Field strength of spurious radiation	Part 22.917 (a) Part 24.238 (a)	Pass
Frequency stability vs. temperature	Part 22.355 Part 24.235 Part 2.1055(a)(1)(b)	Pass
Frequency stability vs. voltage	Part 22.355 Part 24.235 Part 2.1055(d)(2)	Pass
<i>Pass: The EUT complies with the essential requirements in the standard.</i>		

5. General Information

5.1 Client Information

Applicant:	Collage Investments LLC.
Address:	6030 NW 99 Ave #414, DORAL, FL 33178, United States
Manufacturer:	Collage Investments LLC.
Address:	6030 NW 99 Ave #414, DORAL, FL 33178, United States

5.2 General Description of E.U.T.

Product Name:	MOBILE PHONE
Model No.:	1 UNO 3G
Operation Frequency range:	GSM 850: 824.20MHz-848.80MHz PCS1900: 1850.20MHz-1909.80MHz WCDMA Band V: 826.4MHz-846.6MHz WCDMA Band II: 1852.4 MHz-1907.6 MHz
Modulation type:	GSM/GPRS: GMSK, UMTS: QPSK
Antenna type:	Internal Antenna
Antenna gain:	GSM 850: -1.2 dBi PCS 1900: 0.8 dBi WCDMA Band V: -1.2 dBi WCDMA Band II: -0.8 dBi
Power supply:	Rechargeable Li-ion Battery DC3.7V-1000mAh
AC adapter:	Input: AC100-240V, 50/60Hz Output: DC 5.0V, 1000mA
Test Sample Condition:	The test samples were provided in good working order with no visible defects.

Operation Frequency List:

GSM 850		PCS1900	
Channel	Frequency (MHz)	Channel	Frequency (MHz)
128	824.20	512	1850.20
129	824.40	513	1850.40
....
189	836.40	660	1879.80
190	836.60	661	1880.00
191	836.80	662	1880.20
...
250	848.60	809	1909.60
251	848.80	810	1909.80
WCDMA Band V		WCDMA Band II	
Channel	Frequency (MHz)	Channel	Frequency (MHz)
4132	826.40	9262	1852.40
4133	826.60	9263	1852.60
....
4182	836.40	9399	1879.80
4183	836.60	9400	1880.00
4184	836.80	9401	1880.20
...
4232	846.40	9537	1907.40
4233	846.60	9538	1907.60

Regards to the operating frequency range over 10 MHz, the Lowest frequency, the middle frequency, and the highest frequency of channel were selected to perform the test, and the selected channel see below:

GSM850			PCS1900		
Channel	Frequency(MHz)		Channel	Frequency(MHz)	
Lowest	128	824.20	Lowest	512	1850.20
Middle	190	836.60	Middle	661	1880.00
Highest	251	848.80	Highest	810	1909.80
WCDMA Band V			WCDMA Band II		
Channel	Frequency(MHz)		Channel	Frequency(MHz)	
Lowest	4132	826.40	Lowest	9262	1852.40
Middle	4183	836.60	Middle	9400	1880.00
Highest	4233	846.60	Highest	9538	1907.60

5.3 Test modes

Operating Environment:	
Temperature:	Normal: 15°C ~ 35°C, Extreme: -30°C ~ +50°C
Humidity:	20 % ~ 75 % RH
Atmospheric Pressure:	1008 mbar
Voltage:	Nominal: 3.7Vdc, Extreme: Low 3.5 Vdc, High 4.2 Vdc
Test mode:	
GSM mode	Keep the EUT communication with simulated station in GSM mode
GPRS mode	Keep the EUT communication with simulated station in GPRS mode
RMC mode	Keep the EUT communication with simulated station in RMC mode
HSDPA	Keep the EUT communication with simulated station in HSDPA mode
HSUPA	Keep the EUT communication with simulated station in HSUPA mode
Remark: The EUT has been tested under continuous transmitting mode. Channel Low, Mid and High for each type band with rated data rate were chosen for full testing. The field strength of spurious radiation emission was measured as EUT stand-up position (H mode) and lie down position (E1, E2 mode) for these modes with power adaptor, earphone and Data cable. Just the worst case position (H mode) shown in report.	

5.4 Description of Support Units

Test Equipment	Manufacturer	Model No.	Serial No.
Simulated Station	Anritsu	MT8820C	6201026545

5.5 Measurement Uncertainty

Parameters	Expanded Uncertainty
Radiated Emission (9kHz ~ 30MHz)	±2.76 dB (k=2)
Radiated Emission (30MHz ~ 1000MHz)	±4.28 dB (k=2)
Radiated Emission (1GHz ~ 18GHz)	±5.72 dB (k=2)
Radiated Emission (18GHz ~ 40GHz)	±2.88 dB (k=2)

5.6 Laboratory Facility

<p>The test facility is recognized, certified, or accredited by the following organizations:</p> <ul style="list-style-type: none"> FCC - Registration No.: 727551 Shenzhen Zhongjian Nanfang Testing Co., Ltd. has been accredited as a testing laboratory by FCC (Federal Communications Commission). The Registration No. is 727551. IC - Registration No.: 10106A-1 The 3m Semi-anechoic chamber of Shenzhen Zhongjian Nanfang Testing Co., Ltd. has been Registered by Certification and Engineering Bureau of Industry Canada for radio equipment testing with Registration No.: 10106A-1. CNAS - Registration No.: CNAS L6048 Shenzhen Zhongjian Nanfang Testing Co., Ltd. is accredited to ISO/IEC 17025:2005 General Requirements for the Competence of Testing and Calibration laboratories for the competence of testing. The Registration No. is CNAS L6048. A2LA - Registration No.: 4346.01 This laboratory is accredited in accordance with the recognized International Standard ISO/IEC 17025:2005 General requirements for the competence of testing and calibration laboratories. The test scope can be found as below link: https://portal.a2la.org/scopepdf/4346-01.pdf

5.7 Laboratory Location

Shenzhen Zhongjian Nanfang Testing Co., Ltd.
 Address: No. B-C, 1/F., Building 2, Laodong No.2 Industrial Park, Xixiang Road,
 Bao'an District, Shenzhen, Guangdong, China
 Tel: +86-755-23118282, Fax: +86-755-23116366
 Email: info@ccis-cb.com, Website: http://www.ccis-cb.com

5.8 Test Instruments list

Test Equipment	Manufacturer	Model No.	Serial No.	Cal. Date (mm-dd-yy)	Cal. Due date (mm-dd-yy)
3m SAC	SAEMC	9m*6m*6m	966	07-22-2017	07-21-2020
BiConiLog Antenna	SCHWARZBECK	VULB9163	497	03-18-2019	03-17-2020
Biconical Antenna	SCHWARZBECK	VUBA9117	359	06-22-2017	06-21-2020
Horn Antenna	SCHWARZBECK	BBHA9120D	916	03-18-2019	03-17-2020
Horn Antenna	SCHWARZBECK	BBHA9120D	1805	06-22-2017	06-21-2020
Horn Antenna	SCHWARZBECK	BBHA 9170	BBHA9170582	11-21-2018	11-20-2019
EMI Test Software	AUDIX	E3	Version: 6.110919b		
Pre-amplifier	HP	8447D	2944A09358	03-18-2019	03-17-2020
Pre-amplifier	CD	PAP-1G18	11804	03-18-2019	03-17-2020
Spectrum analyzer	Rohde & Schwarz	FSP30	101454	03-18-2019	03-17-2020
Spectrum analyzer	Rohde & Schwarz	FSP40	100363	11-21-2018	11-20-2019
EMI Test Receiver	Rohde & Schwarz	ESRP7	101070	03-18-2019	03-17-2020
Spectrum Analyzer	Agilent	N9020A	MY50510123	11-10-2018	11-09-2019
Signal Generator	Rohde & Schwarz	SMX	835454/016	03-18-2019	03-17-2020
Signal Generator	R&S	SMR20	1008100050	03-18-2019	03-17-2020
RF Switch Unit	MWRFTTEST	MW200	N/A	N/A	N/A
Test Software	MWRFTTEST	MTS8200	Version: 2.0.0.0		
Cable	ZDECL	Z108-NJ-NJ-81	1608458	03-18-2019	03-17-2020
Cable	MICRO-COAX	MFR64639	K10742-5	03-18-2019	03-17-2020
Cable	SUHNER	SUCOFLEX100	58193/4PE	03-18-2019	03-17-2020
DC Power Supply	XinNuoEr	WYK-10020K	1409050110020	10-31-2018	10-30-2019
Temperature Humidity Chamber	HengPu	HPGDS-500	20140828008	09-24-2018	09-23-2019
Simulated Station	Rohde & Schwarz	CMW500	140493	07-16-2018	07-15-2019

6. Test results

6.1 Conducted Output Power, ERP and EIRP

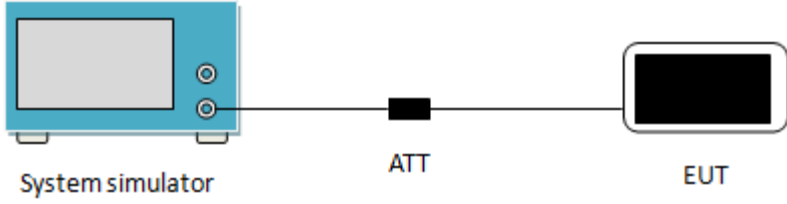
Test Requirement:	FCC part 22.913(a)(5), FCC part 24.232(c)
Test Method:	ANSI/TIA-603-D 2010
Limit:	GSM 850: 7W, PCS 1900: 2W WCDMA Band V: 7W, WCDMA Band II: 2W
Test setup:	 <p>The diagram illustrates the test setup. On the left is a blue 'System simulator' with a screen and two ports. A line connects it to a black 'ATT' (attenuator) block. Another line connects the 'ATT' to a black 'EUT' (Equipment Under Test) device.</p>
Test Procedure:	The transmitter output was connected to a calibrated attenuator, the other end of which was connected to the simulated station. Transmitter output power was read off in dBm.
Test Instruments:	Refer to section 5.8 for details
Test mode:	Refer to section 5.3 for details
Test results:	Passed

Measurement Data:

EUT Mode	Burst Average power (dBm)		
	128	190	251
	824.20 (MHz)	836.60 (MHz)	848.80 (MHz)
GSM 850	33.07	33.24	33.33
GPRS 850 (1 Uplink slot)	33.03	33.23	33.30
GPRS 850 (2 Uplink slot)	31.33	31.52	31.63
GPRS 850 (3 Uplink slot)	29.43	29.61	29.73
GPRS 850 (4 Uplink slot)	27.37	27.56	27.72
Antenna Gain (dBi)	-1.2		
Max. ERP (dBm)	29.98		
ERP Limit (dBm)	38.45		
EUT Mode	Burst Average power (dBm)		
	512	661	810
	1850.20 (MHz)	1880.00 (MHz)	1909.80 (MHz)
PCS 1900	29.46	28.50	28.48
GPRS 1900 (1 Uplink slot)	29.47	28.51	28.51
GPRS 1900 (2 Uplink slot)	28.05	27.63	27.58
GPRS 1900 (3 Uplink slot)	26.15	25.68	25.63
GPRS 1900 (4 Uplink slot)	24.08	23.65	23.68
Antenna Gain (dBi)	0.8		
Max. EIRP (dBm)	30.27		
EIRP Limit (dBm)	33.00		
<p>Note: $EIRP (dBm) = Burst\ Average\ power (dBm) + Antenna\ Gain (dBi)$.</p> <p>$ERP (dBm) = EIRP (dBm) - 2.15 (dB)$.</p>			

EUT Mode		Burst Average power (dBm)		
		4132	4183	4233
		826.40 (MHz)	836.60 (MHz)	846.60 (MHz)
UMTS 850 HSDPA	Subtest 1	22.10	22.78	21.70
	Subtest 2	21.75	22.58	21.68
	Subtest 3	21.24	22.11	21.23
	Subtest 4	20.62	21.76	20.92
UMTS 850 HSUPA	Subtest 1	21.31	22.29	21.35
	Subtest 2	21.45	22.31	21.40
	Subtest 3	21.02	21.94	21.03
	Subtest 4	21.62	22.56	21.68
	Subtest 5	21.19	22.14	21.38
UMTS 850 RMC	12.2kbps	22.81	22.52	22.85
UMTS 850 AMR	12.2kbps	22.73	22.67	22.89
Antenna Gain (dBi)		-1.2		
Max. ERP (dBm)		19.54		
ERP Limit (dBm)		38.45		
EUT Mode		Burst Average power (dBm)		
		9262	9400	9538
		1852.40 (MHz)	1880.00 (MHz)	1907.60 (MHz)
UMTS 1900 HSDPA	Subtest 1	22.17	22.15	21.49
	Subtest 2	22.16	22.17	21.25
	Subtest 3	21.57	21.57	20.86
	Subtest 4	21.34	21.52	20.51
UMTS 1900 HSUPA	Subtest 1	21.81	21.84	21.01
	Subtest 2	22.00	21.89	21.07
	Subtest 3	21.45	21.45	20.76
	Subtest 4	22.21	22.20	21.30
	Subtest 5	21.65	21.67	20.85
UMTS 1900 RMC	12.2kbps	22.56	22.12	22.00
UMTS 1900 AMR	12.2kbps	22.48	22.02	21.92
Antenna Gain (dBi)		-0.8		
Max. EIRP (dBm)		21.76		
EIRP Limit (dBm)		33.00		
<p>Note: EIRP (dBm) = Burst Average power (dBm) + Antenna Gain (dBi). ERP (dBm) = EIRP (dBm) - 2.15 (dB).</p>				

6.2 Peak-to-Average Power Ratio

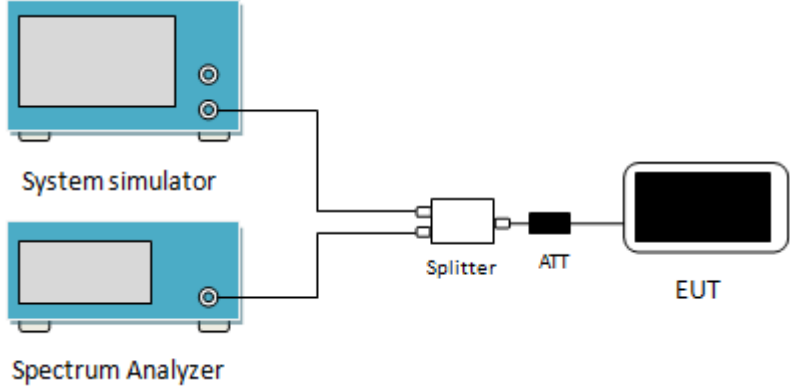
Test Requirement:	FCC part 24.232(d)
Test Method	ANSI/TIA-603-D 2010
Limit:	The peak-to-average ratio (PAR) of the transmission may not exceed 13 dB.
Test setup:	 <p>The diagram shows a test setup where a System simulator and a Spectrum Analyzer are connected to a Splitter. The Splitter is connected to an ATT (Attenuator) and an EUT (Equipment Under Test).</p>
Test Procedure:	<ol style="list-style-type: none"> 1 The RF output of the transceiver was connected to a spectrum analyzer through appropriate attenuation. 2 Set the CCDF option in spectrum analyzer, RBW \geq OBW, 3 Set the EUT working in highest power level, measured and recorded the 0.1% as PAPR level. 4 Repeat step 1~3 at other frequency and modulations.
Test Instruments:	Refer to section 5.8 for details
Test mode:	Refer to section 5.3 for details
Test results:	Passed

Measurement Data:

Modulation	Test channel	PAPR
GSM 850	190	0.19
PCS 1900	661	0.08
UMTS 850 RMC	4183	3.32
UMTS 1900 RMC	9400	3.08

Test plots as below:

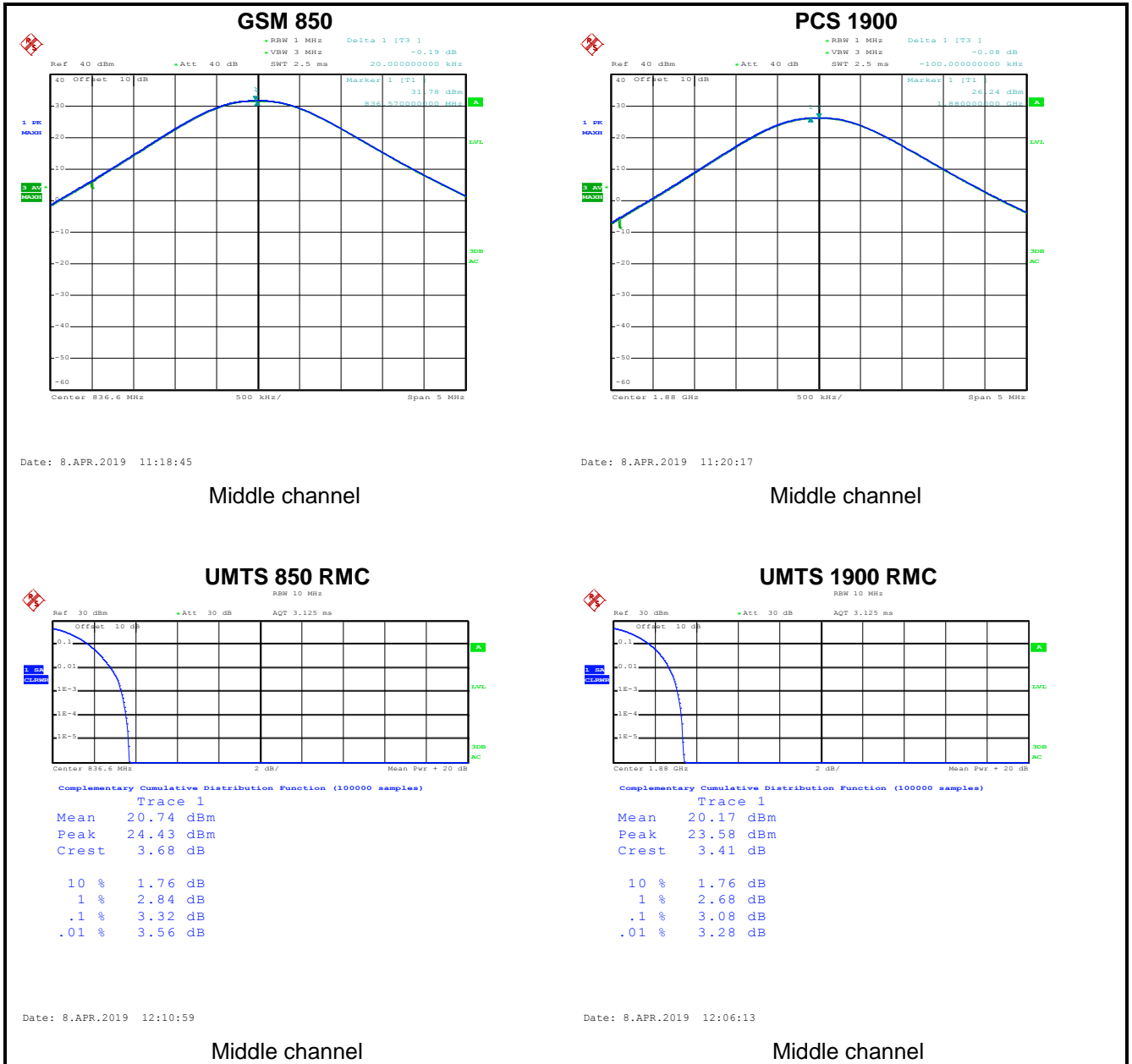

6.3 Occupy Bandwidth

Test Requirement:	FCC part 22.917(b), FCC part 24.238(b)
Test Method:	ANSI/TIA-603-D 2010
Test setup:	<p>The diagram shows a test setup for occupying bandwidth. On the left, there are two blue rectangular units: the top one is labeled 'System simulator' and the bottom one is labeled 'Spectrum Analyzer'. Both have a screen and two circular ports on the right side. A single line from the top port of the System simulator and a single line from the top port of the Spectrum Analyzer merge into a single line that enters a white rectangular 'Splitter' box. From the right side of the Splitter, a line goes to a black rectangular 'ATT' (Attenuator) box. From the right side of the ATT, a line goes to a white rectangular 'EUT' (Equipment Under Test) box with a black screen.</p>
Test Procedure:	<ol style="list-style-type: none"> 1. The EUT's output RF connector was connected with a short cable to the spectrum analyzer 2. RBW was set to about 1% of emission BW, VBW= 3 times RBW. 3. -26dBc display line was placed on the screen (or 99% bandwidth), the occupied bandwidth is the delta frequency between the two points where the display line intersects the signal trace.
Test Instruments:	Refer to section 5.8 for details
Test mode:	Refer to section 5.3 for details
Test results:	Passed

Measurement Data:

EUT Mode	Channel	Frequency (MHz)	99% Occupancy bandwidth (kHz)	-26dB bandwidth (kHz)
GSM 850	128	824.2	252	320
	190	836.6	254	314
	251	848.8	248	308
PCS 1900	512	1850.2	248	320
	661	1880.0	252	318
	810	1909.8	248	316
UMTS 850 12.2k RMC	4132	826.4	4120	4680
	4183	836.6	4080	4660
	4233	846.6	4120	4680
UMTS 1900 12.2k RMC	9262	1852.4	4120	4680
	9400	1880.0	4080	4640
	9538	1907.6	4120	4640

Note:

GSM & GPRS use the same modulation technical (GMSK), and with the same channels, so the 99% OBW and the -26dB of GPRS not performed.

Test plot as follows:

GSM 850

99% Occupancy bandwidth

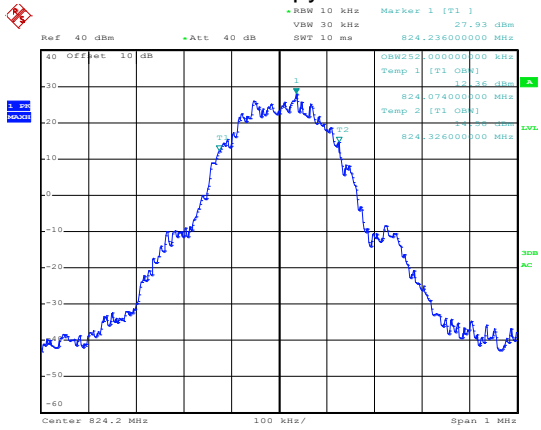

Date: 8.APR.2019 11:13:57

26dB Emission Bandwidth

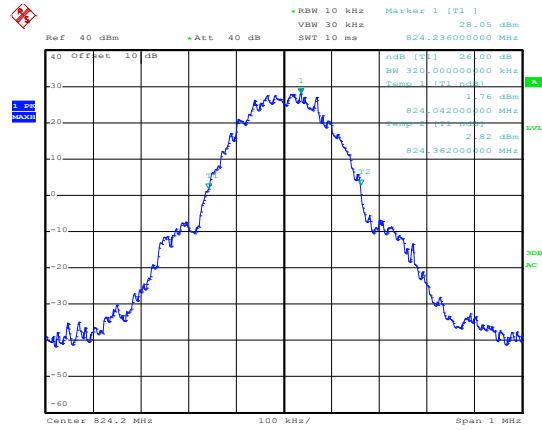

Date: 8.APR.2019 11:14:08

Lowest channel

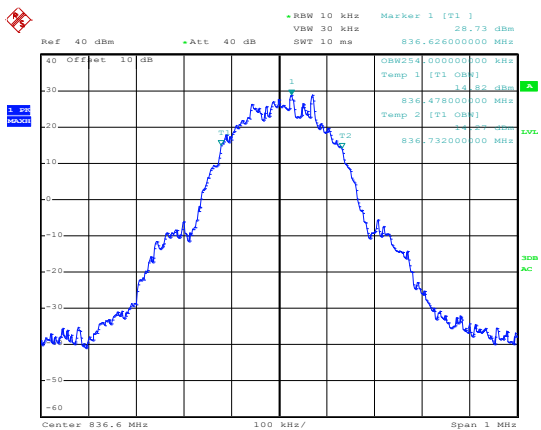

Date: 8.APR.2019 11:14:30

Lowest channel

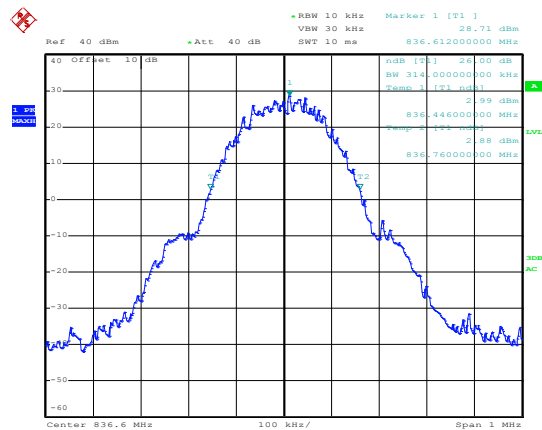

Date: 8.APR.2019 11:14:20

Middle channel

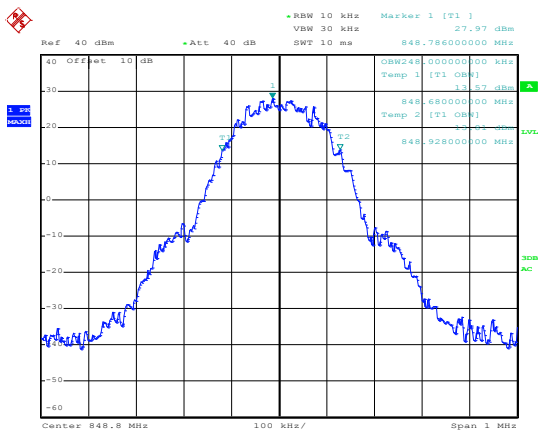

Date: 8.APR.2019 11:14:44

Middle channel

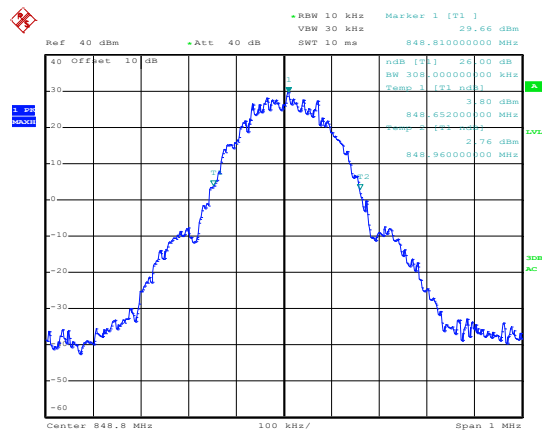

Date: 8.APR.2019 11:14:53

Highest channel

Highest channel

PCS 1900

99% Occupancy bandwidth

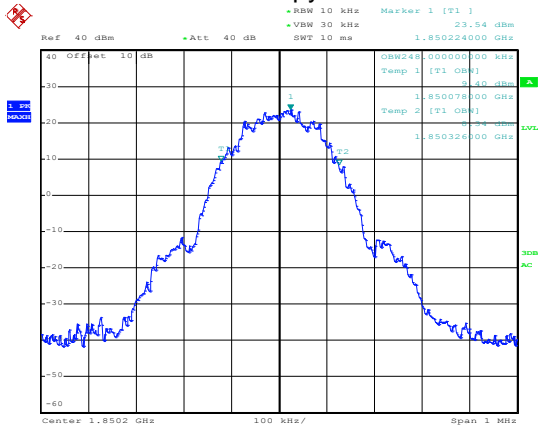

Date: 8.APR.2019 11:21:25

26dB Emission Bandwidth

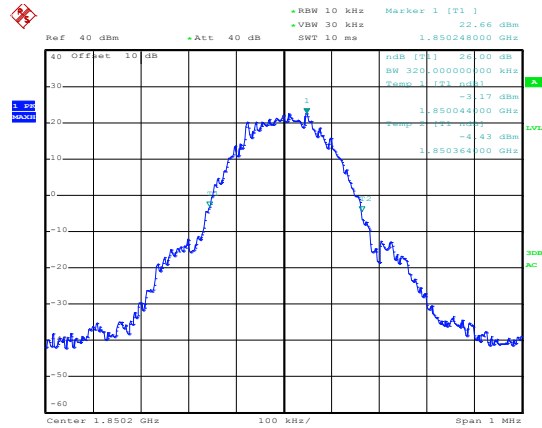

Date: 8.APR.2019 11:21:34

Lowest channel

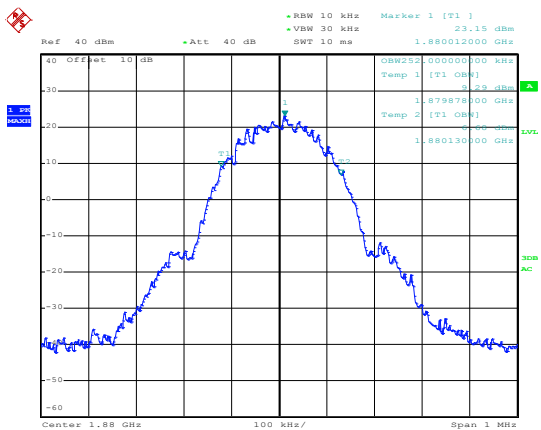

Date: 8.APR.2019 11:22:14

Lowest channel

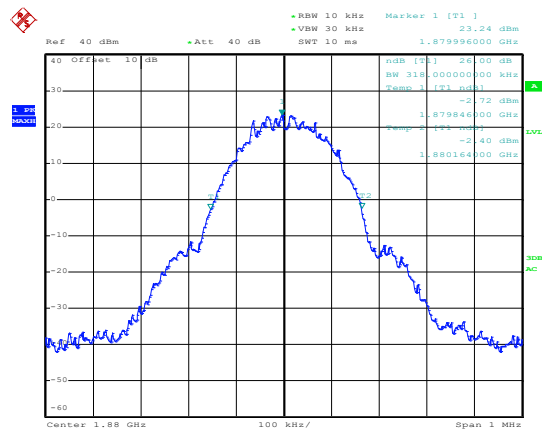

Date: 8.APR.2019 11:21:54

Middle channel

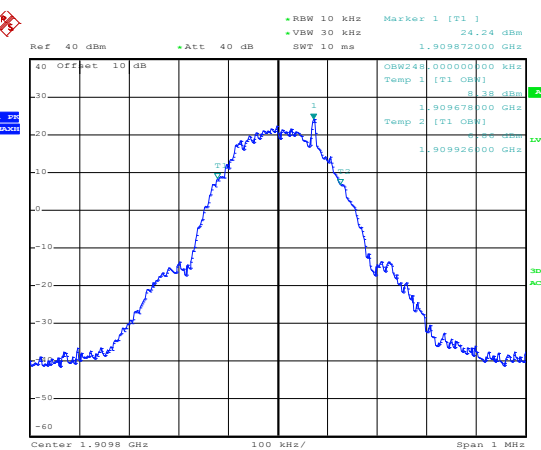

Date: 8.APR.2019 11:22:37

Middle channel

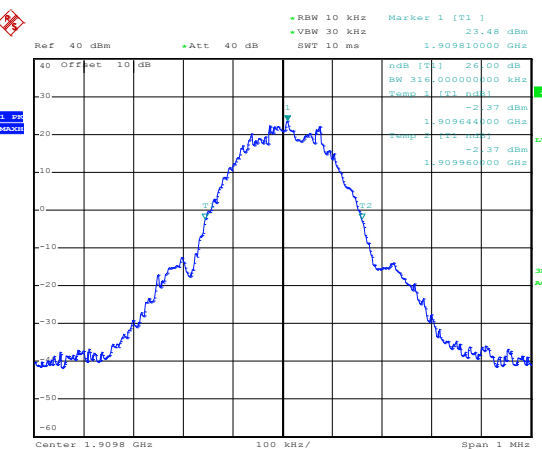

Date: 8.APR.2019 11:22:52

Highest channel

Highest channel

UMTS 850 12.2k RMC

99% Occupancy bandwidth

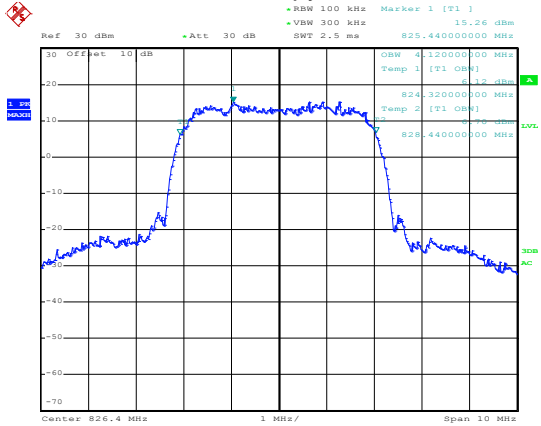

Date: 8.APR.2019 12:08:35

26dB Emission Bandwidth

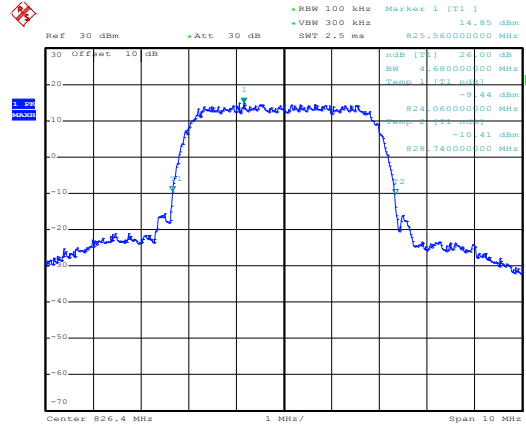

Date: 8.APR.2019 12:08:27

Lowest channel

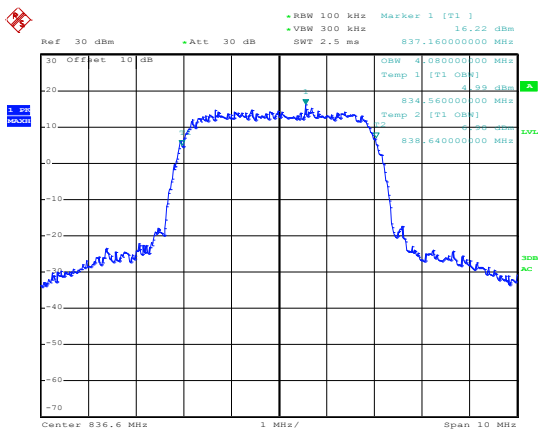

Date: 8.APR.2019 12:08:46

Lowest channel

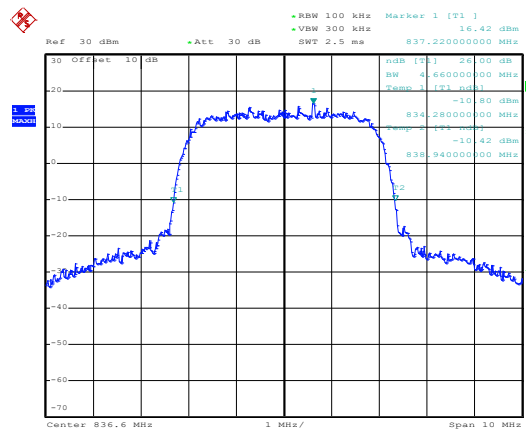

Date: 8.APR.2019 12:08:53

Middle channel

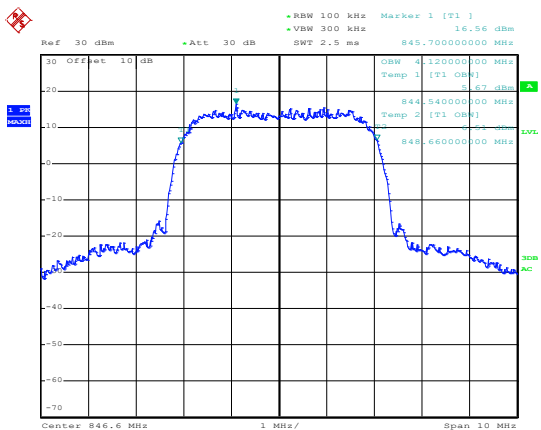

Date: 8.APR.2019 12:09:19

Middle channel

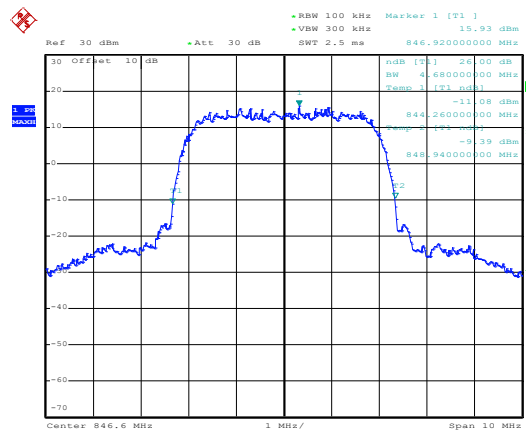

Date: 8.APR.2019 12:09:11

Highest channel

Highest channel

UMTS 1900 12.2k RMC

99% Occupancy bandwidth

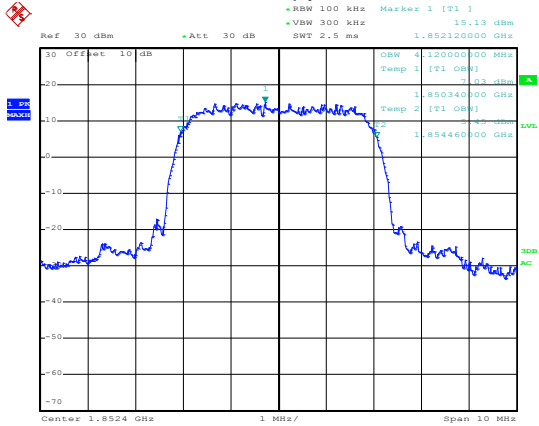

Date: 8.APR.2019 12:06:45

26dB Emission Bandwidth

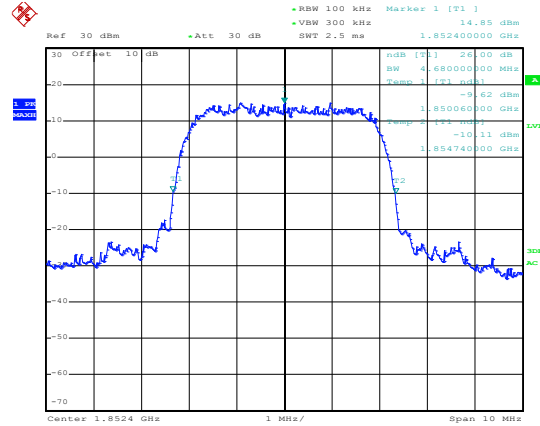

Date: 8.APR.2019 12:06:53

Lowest channel

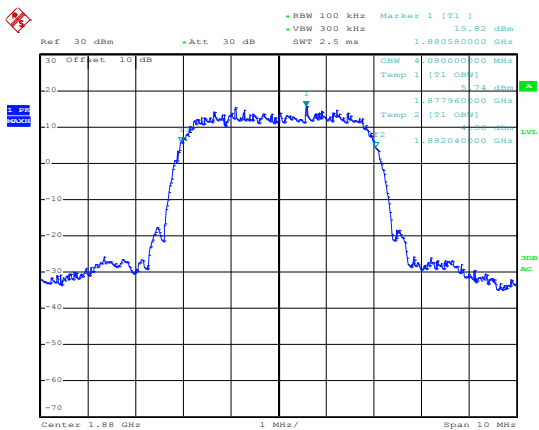

Date: 8.APR.2019 12:07:12

Lowest channel

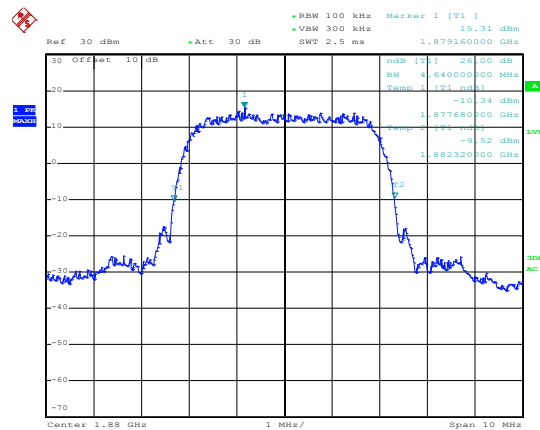

Date: 8.APR.2019 12:07:04

Middle channel

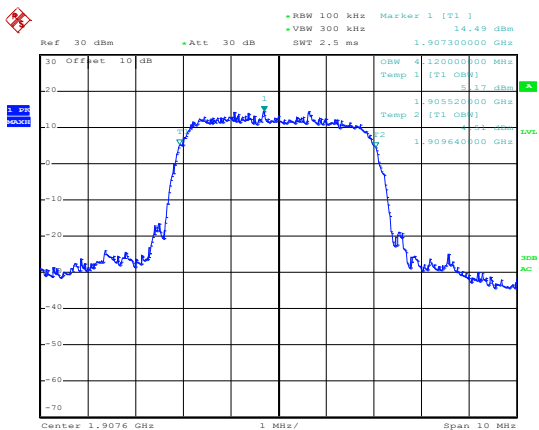

Date: 8.APR.2019 12:07:43

Middle channel

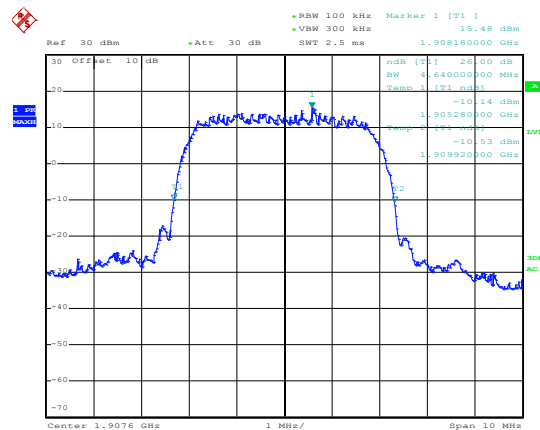

Date: 8.APR.2019 12:07:50

Highest channel

Highest channel

6.4 Modulation Characteristic

According to FCC § 2.1047(d), Part 22H & 24E there is no specific requirement for digital modulation, therefore modulation characteristic is not presented.

6.5 Out of band emission at antenna terminals

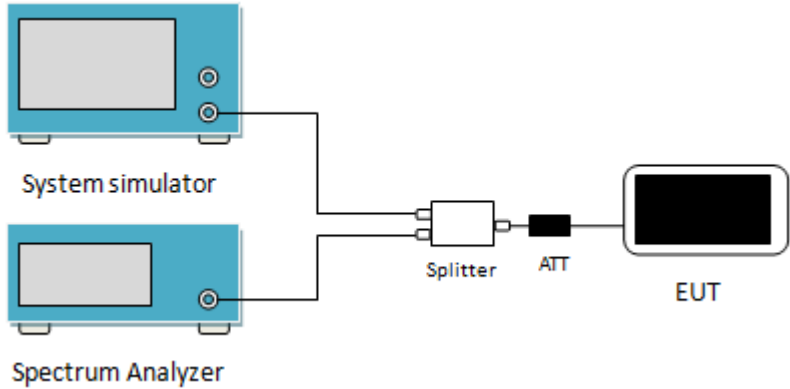
Test Requirement:	FCC part 22.917(a), FCC part 24.238(a)
Test Method:	ANSI/TIA-603-D 2010
Limit:	-13dBm
Test setup:	 <p>The diagram illustrates the test setup. On the left, there are two blue rectangular units: the top one is labeled 'System simulator' and the bottom one is labeled 'Spectrum Analyzer'. Both have a circular port on their right side. These two ports are connected to a white rectangular 'Splitter' box. From the right side of the Splitter, a line goes to a black rectangular 'ATT' (attenuator) box. Finally, a line connects the ATT to a black rectangular 'EUT' (Equipment Under Test) box on the far right.</p>
Test Procedure:	<ol style="list-style-type: none"> 1 The RF output of the transceiver was connected to a spectrum analyzer through appropriate attenuation. 2 The resolution bandwidth of the spectrum analyzer was set at 100 kHz when below 1GHz, 1MHz when above 1 GHz; sufficient scans were taken to show the out of band Emissions if any up to 10th harmonic. 3 For the out of band: Set the RBW=100 kHz, VBW=300 kHz when below 1 GHz, RBW =1 MHz, VBW=3 MHz when above 1 GHz, Start=30MHz, Stop= 10th harmonic. 4 Band Edge Requirements: In the 1 MHz bands immediately outside and adjacent to the frequency block, a resolution bandwidth of at least 1 percent of the emission bandwidth of the fundamental emission of the transmitter may be employed to measure the out of band Emissions.
Test Instruments:	Refer to section 5.8 for details
Test mode:	Refer to section 5.3 for details
Test results:	Passed

Test plots as follows (Spurious emission):

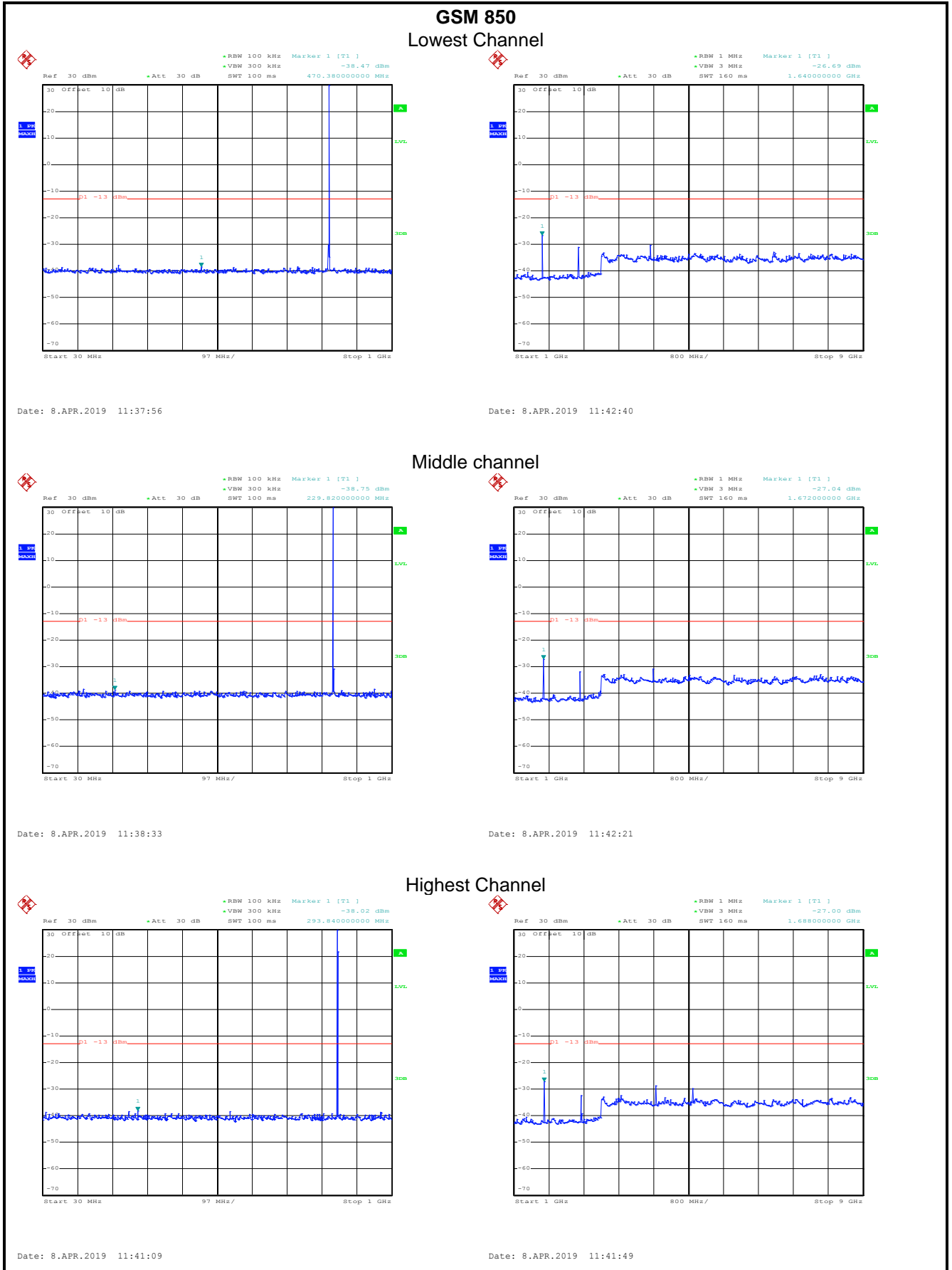

PCS 1900 Lowest Channel

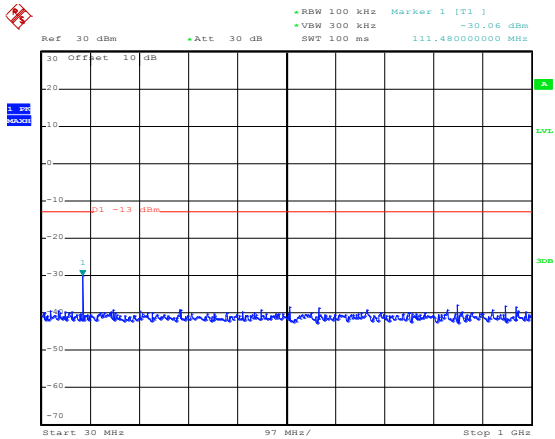

Date: 8.APR.2019 11:47:03

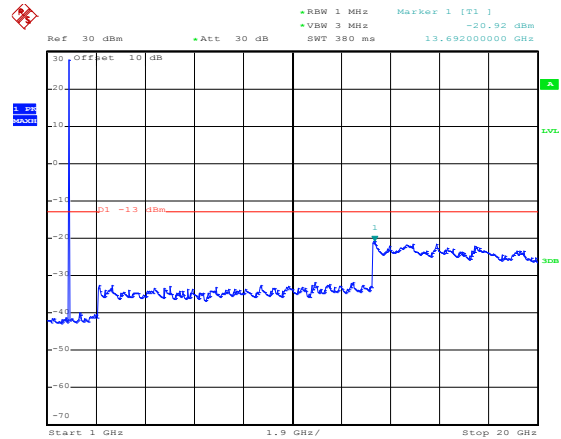

Date: 8.APR.2019 11:44:27

Middle Channel

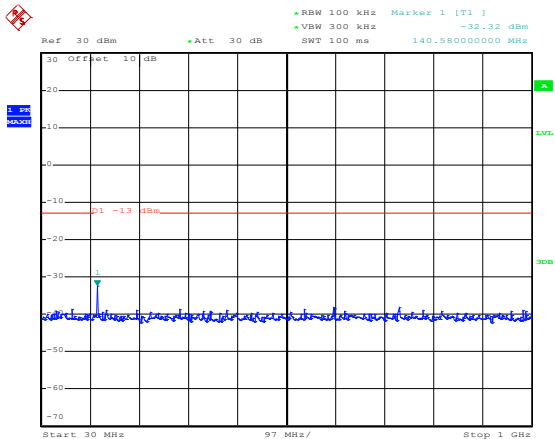

Date: 8.APR.2019 11:46:51

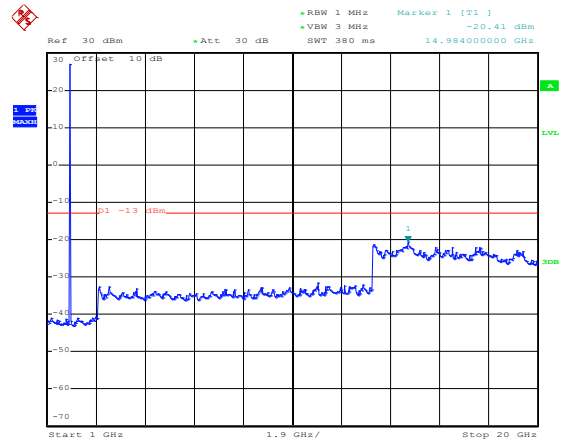

Date: 8.APR.2019 11:44:56

Highest Channel

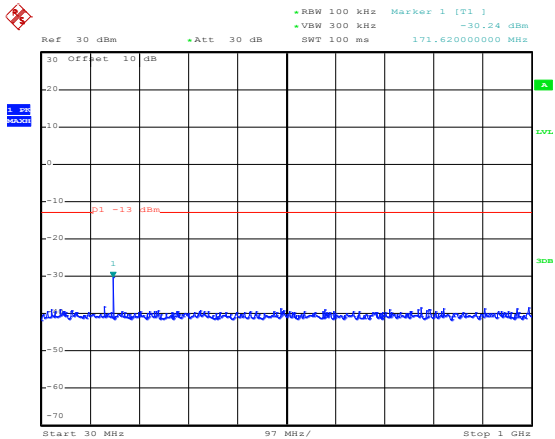

Date: 8.APR.2019 11:46:35

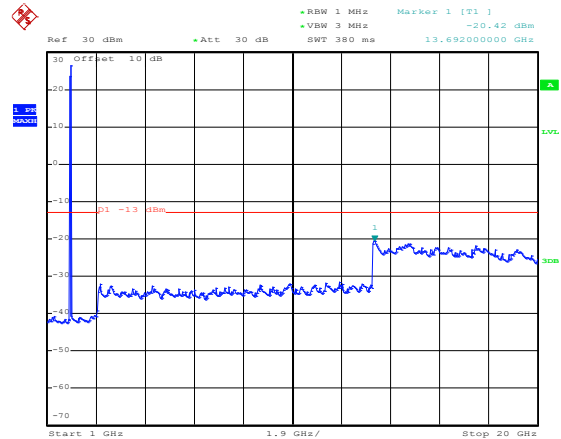

Date: 8.APR.2019 11:46:05

UMTS 850 12.2k RMC Lowest Channel

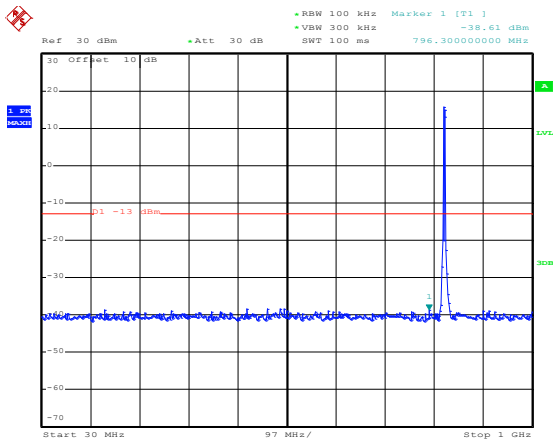

Date: 8.APR.2019 12:04:27

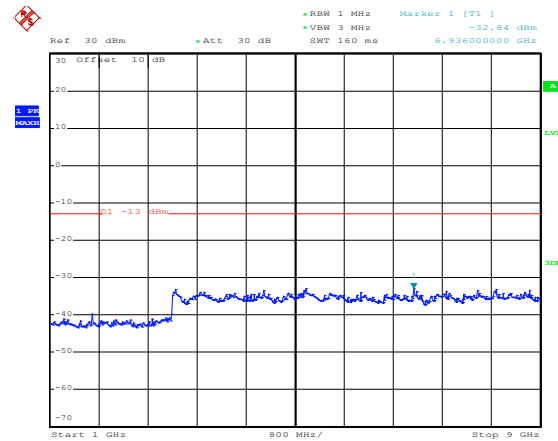

Date: 8.APR.2019 12:05:27

Middle Channel

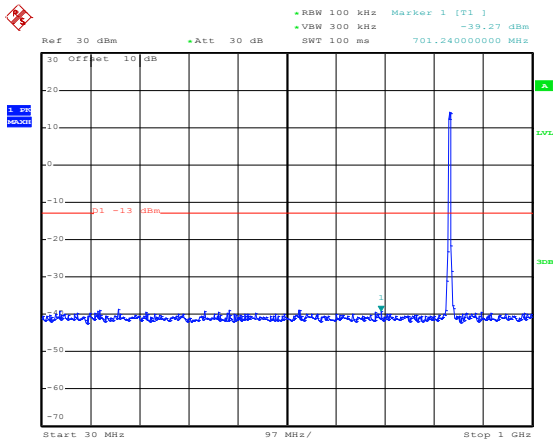

Date: 8.APR.2019 12:04:41

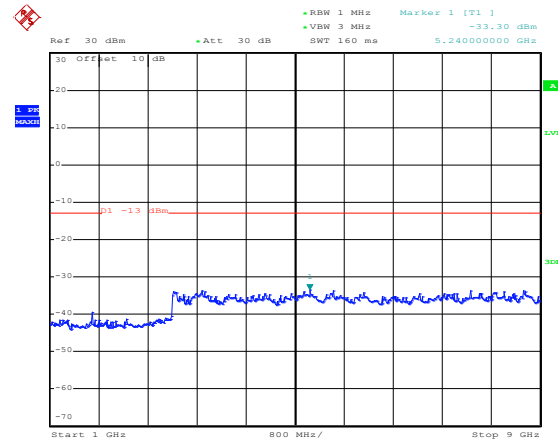

Date: 8.APR.2019 12:05:35

Highest Channel

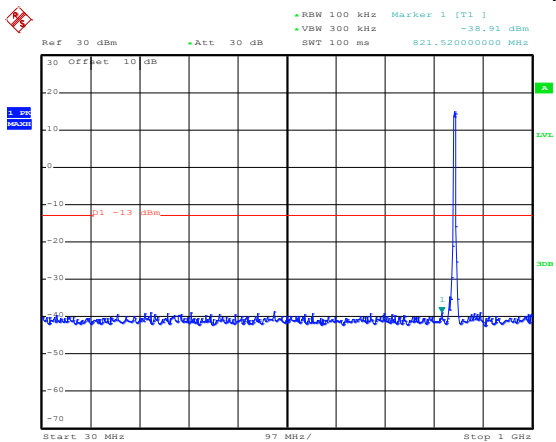

Date: 8.APR.2019 12:04:54

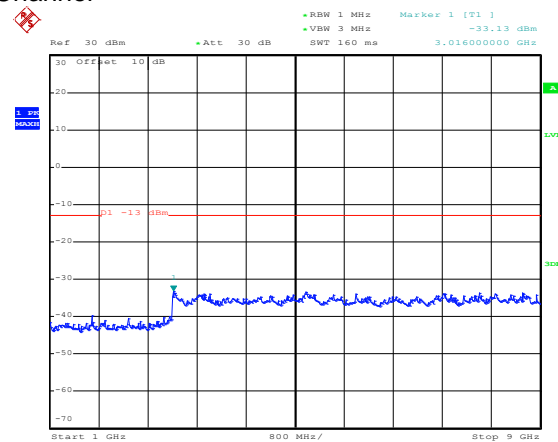

Date: 8.APR.2019 12:05:44

UMTS 1900 12.2k RMC Lowest Channel

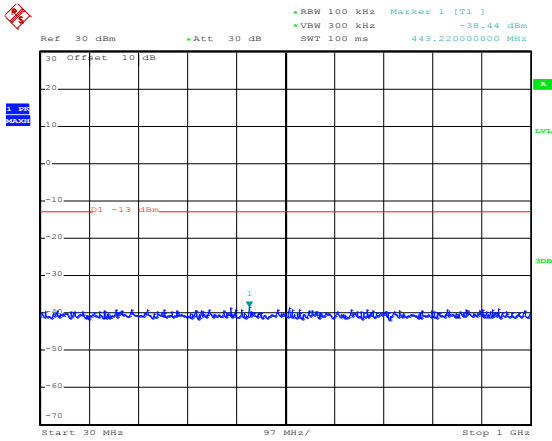

Date: 8.APR.2019 12:03:35

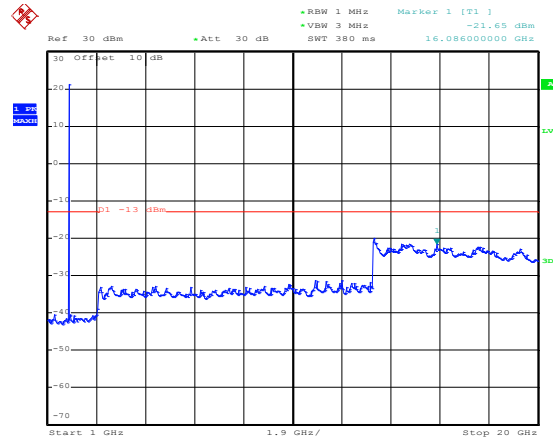

Date: 8.APR.2019 12:02:39

Middle Channel

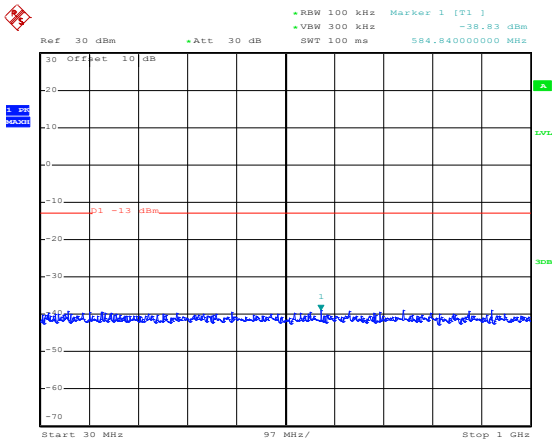

Date: 8.APR.2019 12:03:43

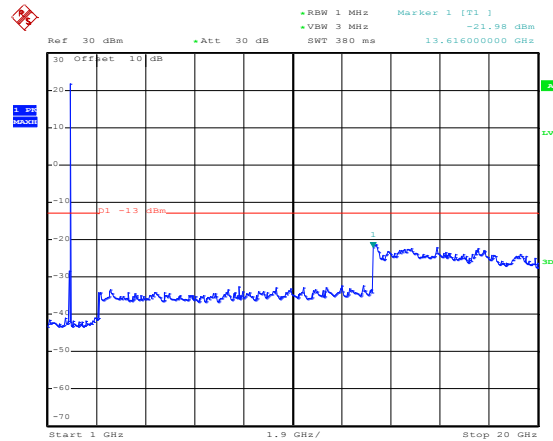

Date: 8.APR.2019 12:02:52

Highest Channel

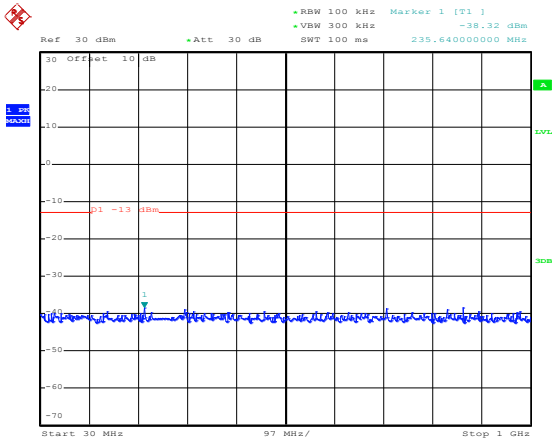

Date: 8.APR.2019 12:03:51

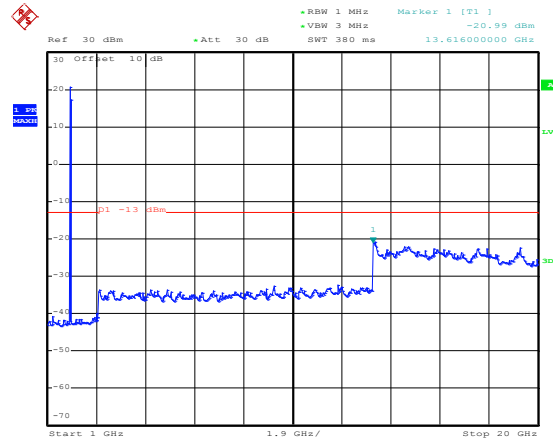

Date: 8.APR.2019 12:03:07

Band edge emission:

GSM850

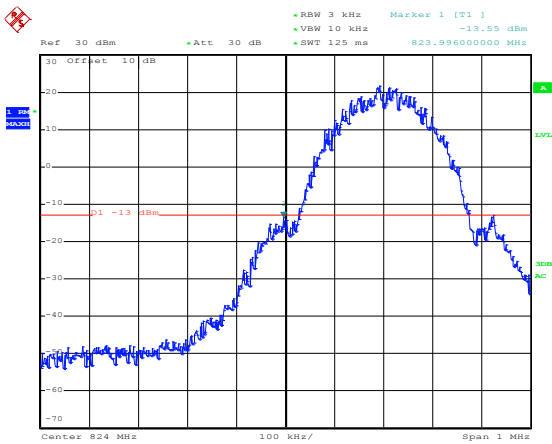

Date: 8.APR.2019 11:17:01

Lowest channel

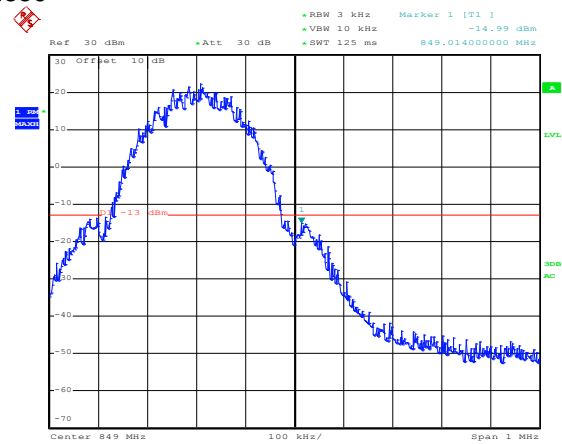

Date: 8.APR.2019 11:16:30

Highest channel

PCS1900

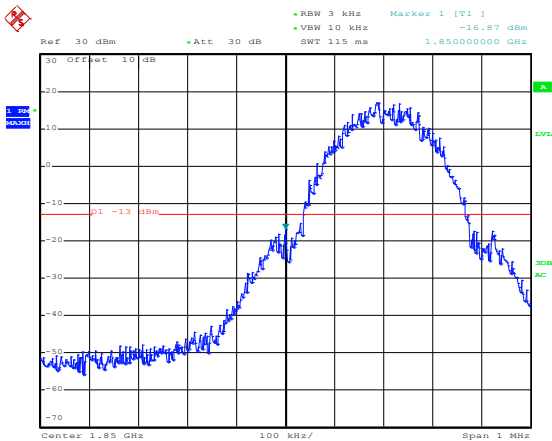

Date: 8.APR.2019 11:24:27

Lowest channel

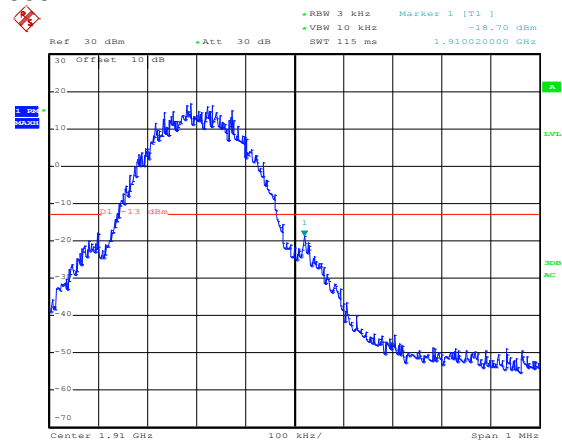

Date: 8.APR.2019 11:23:47

Highest channel

UMTS 850 RMC 12.2kbps

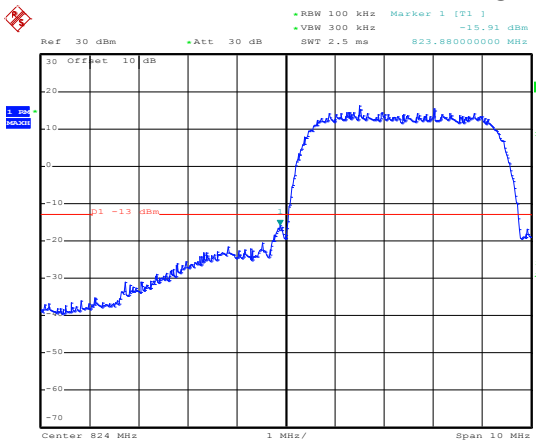

Date: 8.APR.2019 12:10:35

Lowest channel

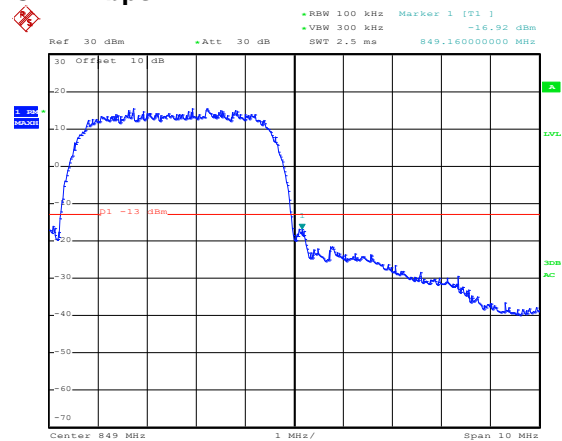

Date: 8.APR.2019 12:10:07

Highest channel

UMTS 1900 RMC 12.2kbps

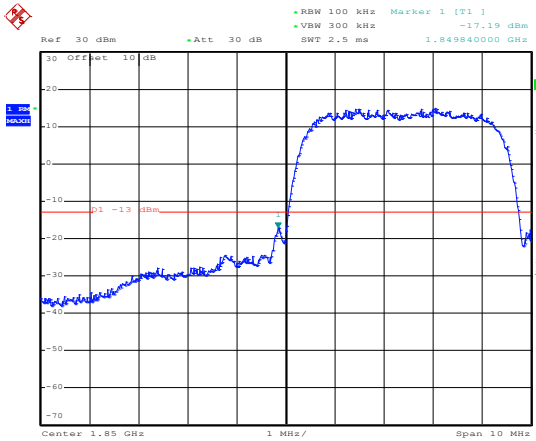

Date: 8.APR.2019 12:05:12

Lowest channel

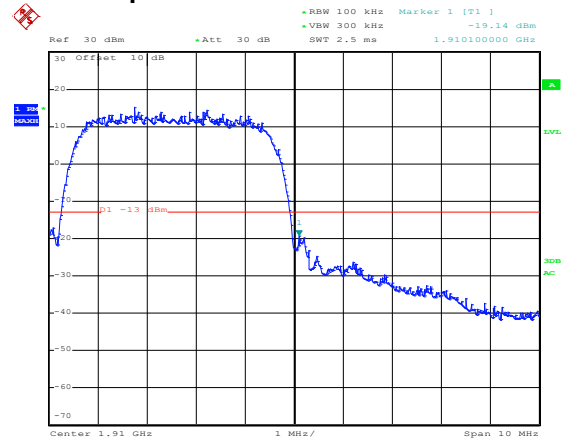

Date: 8.APR.2019 12:05:31

Highest channel

6.6 Field strength of spurious radiation measurement

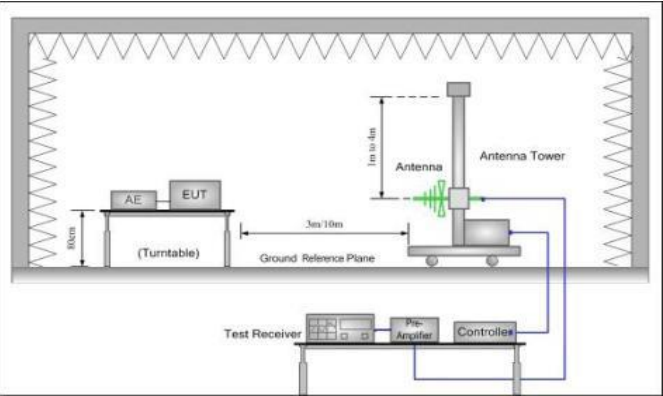
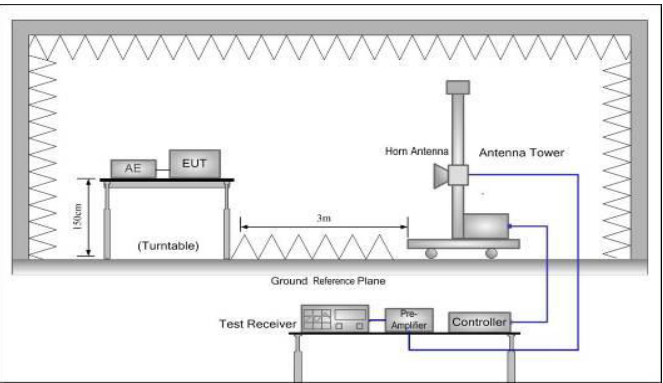
Test Requirement:	FCC part 22.917(a), FCC part 24.238(a)
Test Method:	ANSI/TIA-603-D 2010
Limit:	-13dBm
Test setup:	<p>Below 1GHz</p>  <p>Above 1GHz</p> 
Test Procedure:	<ol style="list-style-type: none"> 1. The EUT was placed on an non-conductive turntable using a non-conductive support. The radiated emission at the fundamental frequency was measured at 3 m with a test antenna and EMI spectrum analyzer. 2. During the tests, the antenna height and the EUT azimuth were varied in order to identify the maximum level of emissions from the EUT. This maximization process was repeated with the EUT positioned in each of its three orthogonal orientations. 3. The frequency range up to tenth harmonic was investigated for each of three fundamental frequency (low, middle and high channels). Once spurious emission was identified, the power of the emission was determined using the substitution method. 4. The spurious emissions attenuation was calculated as the difference between radiated power at the fundamental frequency and the spurious emissions frequency. <ul style="list-style-type: none"> ERP / EIRP = S.G. output (dBm) + Antenna Gain(dB/dBi) – Cable Loss (dB)
Test Instruments:	Refer to section 5.8 for details
Test mode:	Refer to section 5.3 for details.
Test results:	Passed

Measurement Data (worst case):

GSM850				
Lowest channel				
Frequency (MHz)	Spurious Emission		Limit (dBm)	Result
	Polarization	Level (dBm)		
1648.40	Vertical	-48.63	-13.00	Pass
2472.60	V	-46.09		
3296.80	V	-40.03		
1648.40	Horizontal	-49.68	-13.00	Pass
2472.60	H	-51.72		
3296.80	H	-41.80		
Middle channel				
Frequency (MHz)	Spurious Emission		Limit (dBm)	Result
	Polarization	Level (dBm)		
1673.20	Vertical	-51.39	-13.00	Pass
2509.80	V	-48.19		
3346.40	V	-48.75		
1673.20	Horizontal	-49.48	-13.00	Pass
2509.80	H	-53.17		
3346.40	H	-48.69		
Highest channel				
Frequency (MHz)	Spurious Emission		Limit (dBm)	Result
	Polarization	Level (dBm)		
1697.60	Vertical	-51.38	-13.00	Pass
2546.40	V	-46.69		
3395.20	V	-47.84		
1697.60	Horizontal	-51.94	-13.00	Pass
2546.40	H	-52.74		
3395.20	H	-41.38		
<i>Remark:</i>				
1. The emission levels of below 1 GHz are very lower than the limit and not show in test report.				

PCS1900				
Lowest channel				
Frequency (MHz)	Spurious Emission		Limit (dBm)	Result
	Polarization	Level (dBm)		
3700.40	Vertical	-17.84	-13.00	Pass
5550.60	V	-32.17		
3700.40	Horizontal	-22.40	-13.00	Pass
5550.60	H	-34.96		
Middle channel				
Frequency (MHz)	Spurious Emission		Limit (dBm)	Result
	Polarization	Level (dBm)		
3760.00	Vertical	-15.64	-13.00	Pass
5640.00	V	-26.86		
3760.00	Horizontal	-19.72	-13.00	Pass
5640.00	H	-31.13		
Highest channel				
Frequency (MHz)	Spurious Emission		Limit (dBm)	Result
	Polarization	Level (dBm)		
3819.60	Vertical	-21.60	-13.00	Pass
5729.40	V	-31.42		
3819.60	Horizontal	-20.12	-13.00	Pass
5729.40	H	-32.92		
<i>Remark:</i>				
1. The emission levels of below 1 GHz are very lower than the limit and not show in test report.				

WCDMA BAND V 12.2k RMC				
Lowest channel				
Frequency (MHz)	Spurious Emission		Limit (dBm)	Result
	Polarization	Level (dBm)		
1652.80	Vertical	-54.51	-13.00	Pass
2479.20	V	-56.00		
3305.60	V	-52.73		
1652.80	Horizontal	-56.73	-13.00	Pass
2479.20	H	-56.04		
3305.60	H	-53.14		
Middle channel				
Frequency (MHz)	Spurious Emission		Limit (dBm)	Result
	Polarization	Level (dBm)		
1673.20	Vertical	-55.62	-13.00	Pass
2509.80	V	-50.36		
3346.40	V	-50.28		
1673.20	Horizontal	-56.32	-13.00	Pass
2509.80	H	-48.69		
3346.40	H	-51.87		
Highest channel				
Frequency (MHz)	Spurious Emission		Limit (dBm)	Result
	Polarization	Level (dBm)		
1693.20	Vertical	-59.29	-13.00	Pass
2539.80	V	-50.33		
3386.40	V	-51.34		
1693.20	Horizontal	-57.71	-13.00	Pass
2539.80	H	-49.17		
3386.40	H	-50.08		
Remark: 1. The emission levels of below 1 GHz are very lower than the limit and not show in test report.				

WCDMA Band II 12.2k RMC				
Lowest channel				
Frequency (MHz)	Spurious Emission		Limit (dBm)	Result
	Polarization	Level (dBm)		
3704.80	Vertical	-33.91	-13.00	Pass
5557.20	V	-46.06		
3704.80	Horizontal	-33.41	-13.00	Pass
5557.20	H	-46.03		
Middle channel				
Frequency (MHz)	Spurious Emission		Limit (dBm)	Result
	Polarization	Level (dBm)		
3760.00	Vertical	-32.37	-13.00	Pass
5640.00	V	-44.78		
3760.00	Horizontal	-32.22	-13.00	Pass
5640.00	H	-44.92		
Highest channel				
Frequency (MHz)	Spurious Emission		Limit (dBm)	Result
	Polarization	Level (dBm)		
3815.20	Vertical	-33.12	-13.00	Pass
5722.80	V	-43.65		
3815.20	Horizontal	-30.87	-13.00	Pass
5722.80	H	-44.87		
<i>Remark:</i> 1. The emission levels of below 1 GHz are very lower than the limit and not show in test report.				

6.7 Frequency stability V.S. Temperature measurement

Test Requirement:	FCC Part 22.355, FCC Part 24.235 FCC Part 2.1055(a)(1)(b)
Test Method:	ANSI/TIA-6-3-D 2010
Limit:	±2.5 ppm for GSM 850 and WCDMA BAND V N/A for PCS 1900 and WCDMA BAND II
Test setup:	
Test procedure:	<ol style="list-style-type: none"> 1. The equipment under test was connected to an external DC power supply and input rated voltage. 2. RF output was connected to a frequency counter or spectrum analyzer via feed through attenuators. 3. The EUT was placed inside the temperature chamber. 4. Set the spectrum analyzer RBW low enough to obtain the desired frequency resolution and measure EUT 25°C operating frequency as reference frequency. 5. Turn EUT off and set the chamber temperature to -30°C. After the temperature stabilized for approximately 30 minutes recorded the frequency. 6. Repeat step measure with 10°C increased per stage until the highest temperature of +50°C reached
Test Instruments:	Refer to section 5.8 for details
Test mode:	Refer to section 5.3 for details
Test results:	Passed

Measurement Data (the worst channel):

Reference Frequency: GSM850 Middle channel=190 channel=836.6MHz					
Power supplied (Vdc)	Temperature (°C)	Frequency error		Limit (ppm)	Result
		Hz	ppm		
3.80	-30	178	0.212766	±2.5	Pass
	-20	164	0.196032		
	-10	157	0.187664		
	0	156	0.186469		
	10	158	0.188860		
	20	162	0.193641		
	30	153	0.182883		
	40	149	0.178102		
	50	150	0.179297		

Reference Frequency: PCS1900 Middle channel=661 channel=1880MHz					
Power supplied (Vdc)	Temperature (°C)	Frequency error		Limit (ppm)	Result
		Hz	ppm		
3.80	-30	132	0.070213	N/A	Pass
	-20	128	0.068085		
	-10	124	0.065957		
	0	123	0.065426		
	10	118	0.062766		
	20	116	0.061702		
	30	103	0.054787		
	40	117	0.062234		
	50	120	0.063830		

Note: Only the worst case shown in the report.

Reference Frequency: WCDMA BAND V 12.2k RMC Middle channel=4183 channel=836.6MHz					
Power supplied (Vdc)	Temperature (°C)	Frequency error		Limit (ppm)	Result
		Hz	ppm		
3.80	-30	143	0.170930	±2.5	Pass
	-20	136	0.162563		
	-10	132	0.157781		
	0	134	0.160172		
	10	129	0.154196		
	20	127	0.151805		
	30	134	0.160172		
	40	135	0.161367		
	50	122	0.145828		
Reference Frequency: WCDMA BAND II 12.2k RMC Middle channel=9400 channel=1880MHz					
Power supplied (Vdc)	Temperature (°C)	Frequency error		Limit (ppm)	Result
		Hz	ppm		
3.80	-30	117	0.062234	N/A	Pass
	-20	96	0.051064		
	-10	108	0.057447		
	0	107	0.056915		
	10	113	0.060106		
	20	115	0.061170		
	30	108	0.057447		
	40	94	0.050000		
	50	109	0.057979		
<i>Note: Only the worst case shown in the report.</i>					

6.8 Frequency stability V.S. Voltage measurement

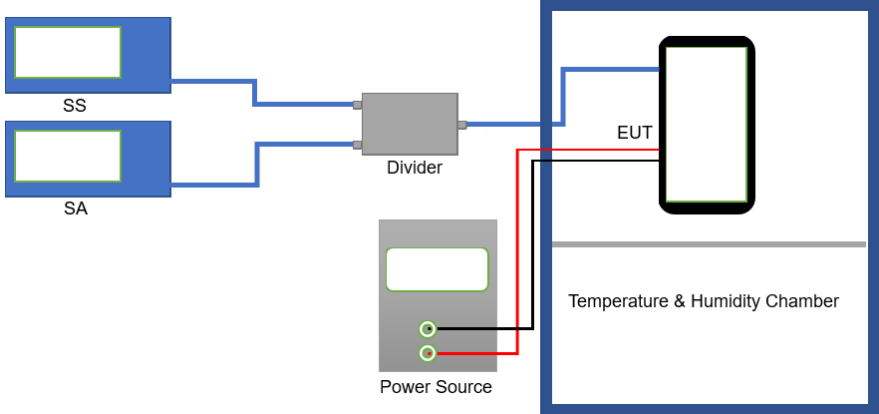
Test Requirement:	FCC Part 22.355, FCC Part 24.235 FCC Part 2.1055(d)(2)
Test Method:	ANSI/TIA-603-D 2010
Limit:	±2.5 ppm for GSM 850 and WCDMA BAND V N/A for PCS 1900 and WCDMA BAND II
Test setup:	 <p>The diagram illustrates the test setup. On the left, there are two blue rectangular boxes labeled 'SS' (Spectrum Scanner) and 'SA' (Spectrum Analyzer). Both are connected to a central grey box labeled 'Divider'. The output of the 'Divider' is connected to a black rectangular box labeled 'EUT' (Equipment Under Test) which is situated inside a larger blue-bordered box labeled 'Temperature & Humidity Chamber'. Below the chamber, there is a grey box labeled 'Power Source' with two green circular terminals. Red and black wires connect the 'Power Source' to the 'EUT'.</p>
Test procedure:	<ol style="list-style-type: none"> 1. Set chamber temperature to 25°C. Use a variable DC power source to power the EUT and set the voltage to rated voltage. 2. Set the spectrum analyzer RBW low enough to obtain the desired frequency resolution and recorded the frequency. 3. Reduce the input voltage to specify extreme voltage variation (+/- 15%) and endpoint, record the maximum frequency change.
Test Instruments:	Refer to section 5.8 for details
Test mode:	Refer to section 5.3 for details
Test results:	Passed

Measurement Data (the worst channel):

Reference Frequency: GSM850 Middle channel=190 channel=836.6MHz					
Temperature (°C)	Power supplied (Vdc)	Frequency error		Limit (ppm)	Result
		Hz	ppm		
25	4.35	96	0.114750	±2.5	Pass
	3.80	94	0.112360		
	3.55	87	0.103992		
Reference Frequency: PCS1900 Middle channel=661 channel=1880MHz					
Temperature (°C)	Power supplied (Vdc)	Frequency error		Limit (ppm)	Result
		Hz	ppm		
25	4.35	98	0.052128	N/A	Pass
	3.80	86	0.045745		
	3.55	90	0.047872		
<i>Note: Only the worst case shown in the report.</i>					

Reference Frequency: UMTS 850 12.2k RMC Middle channel=4183 channel=836.6MHz					
Temperature (°C)	Power supplied (Vdc)	Frequency error		Limit (ppm)	Result
		Hz	ppm		
25	4.35	86	0.102797	±2.5	Pass
	3.80	81	0.096820		
	3.55	83	0.099211		
Reference Frequency: UMTS 1900 12.2k RMC Middle channel=9400 channel=1880MHz					
Temperature (°C)	Power supplied (Vdc)	Frequency error		Limit (ppm)	Result
		Hz	ppm		
25	4.35	106	0.056383	N/A	Pass
	3.80	94	0.050000		
	3.55	89	0.047340		
<i>Note: Only the worst case shown in the report.</i>					