

THIS DOCUMENT CONTAINS INFORMATION PROPRIETARY TO REON CORPORATION (REON). USE OR DISCLOSURE WITHOUT THE WRITTEN PERMISSION OF AN OFFICER OF REON IS EXPRESSLY FORBIDDEN.

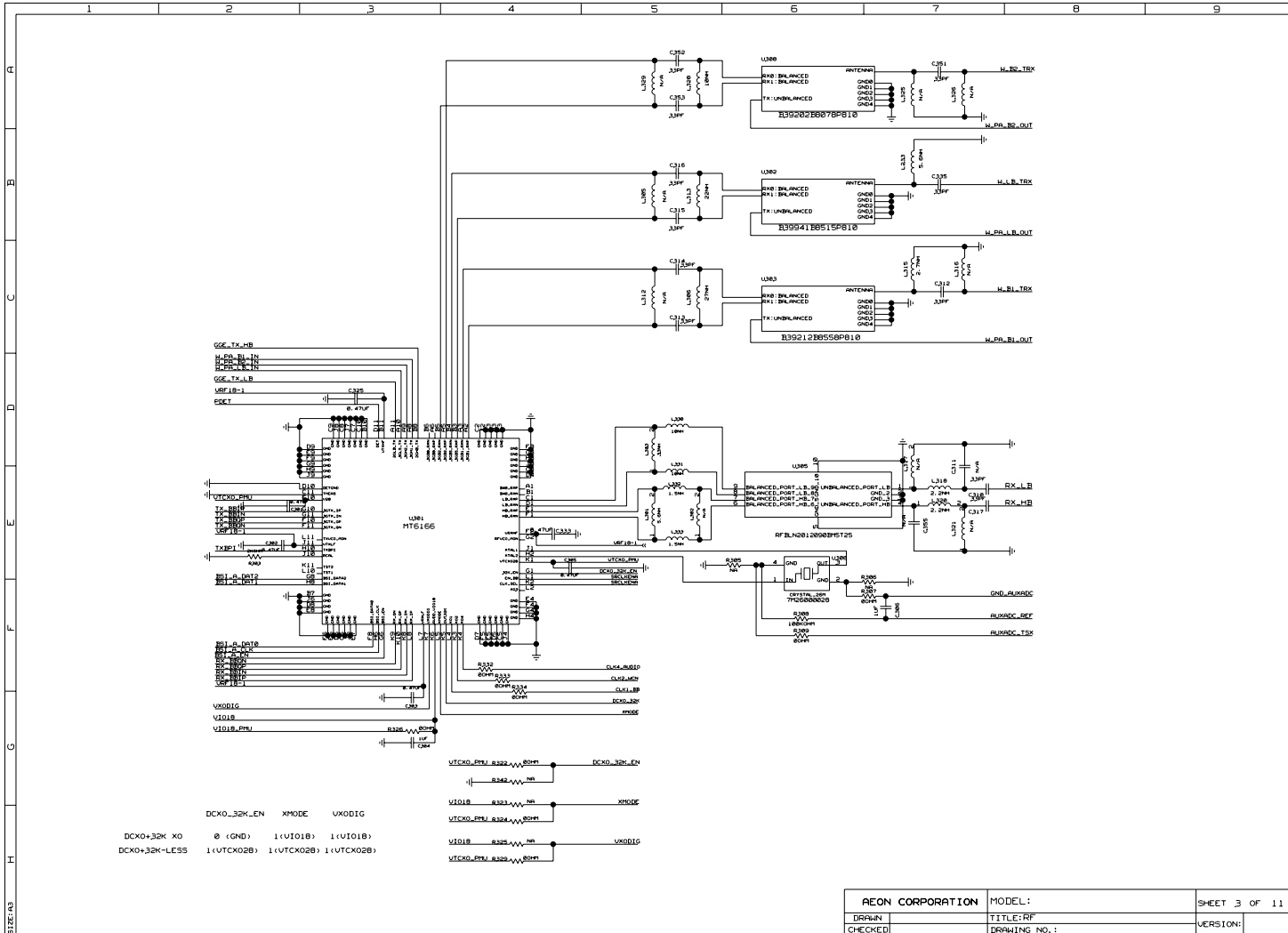

DCKO_32K_X0 @ (GND) 1(U1018) 1(U1018)
 DCKO_32K_LESS 1(UTCK02B) 1(UTCK02B) 1(UTCK02B)

VTCX0_PSW 832K 80m
 DCKO_32K_EN 832K 80m
 XMODE 832K 80m
 VTCX0_PSW 832K 80m
 VDD18 832K 80m
 VTCX0_PSW 832K 80m

REON CORPORATION		MODEL:	SHEET 3 OF 11
DRAWN		TITLE:RF	
CHECKED		DRAWING NO.:	VERSION:

THIS DOCUMENT CONTAINS INFORMATION PROPRIETARY TO AECN CORPORATION (AECN). USE OR DISCLOSURE WITHOUT THE WRITTEN PERMISSION OF AN OFFICER OF AECN IS EXPRESSLY FORBIDDEN.

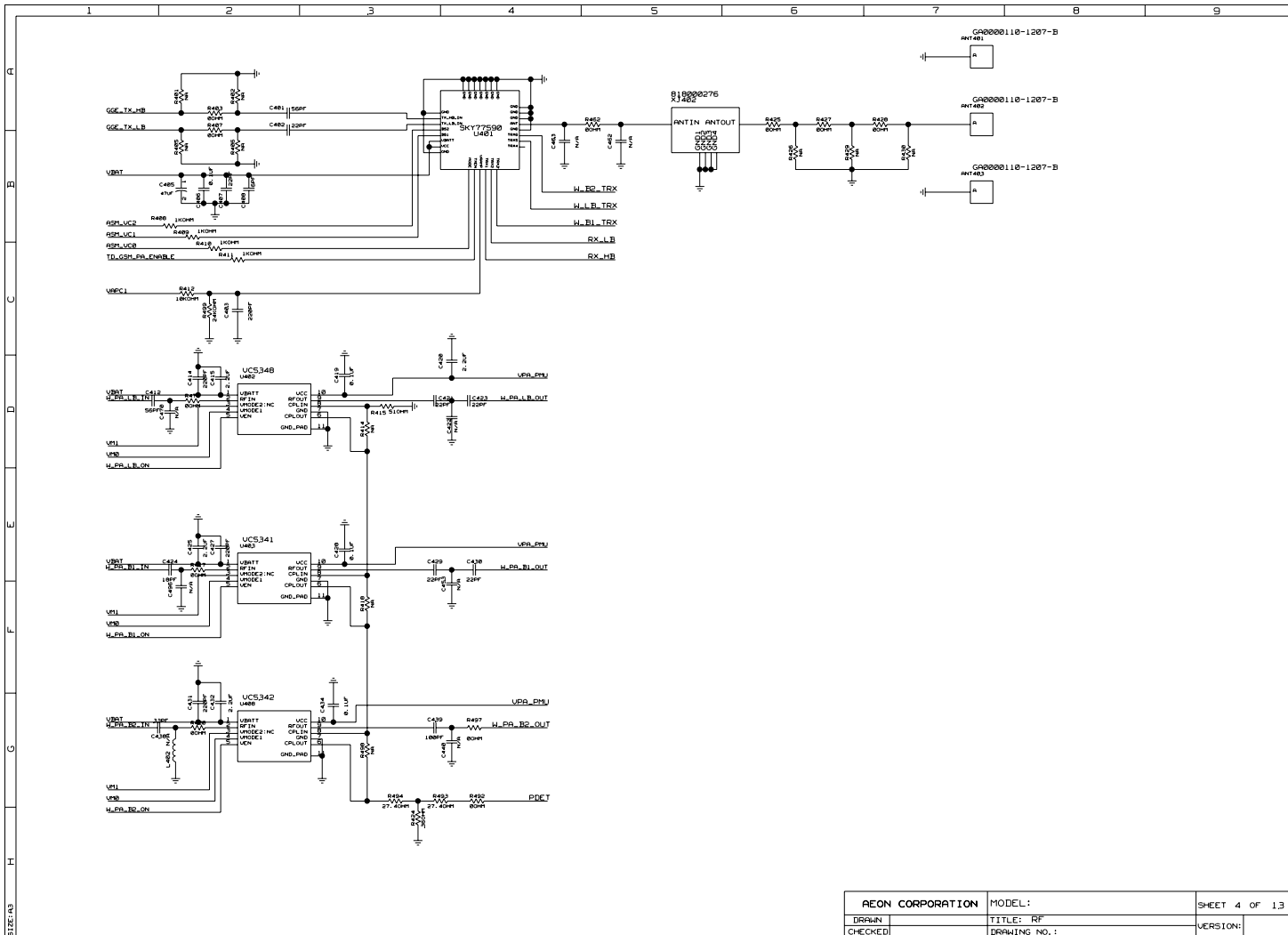

AECN CORPORATION		MODEL:	SHEET 4 OF 13
DRAWN		TITLE: RF	
CHECKED		DRAWING NO.:	VERSION:

THIS DOCUMENT CONTAINS INFORMATION PROPRIETARY TO AECOR CORPORATION (AECOR). USE OR DISCLOSURE WITHOUT THE WRITTEN PERMISSION OF AN OFFICER OF AECOR IS EXPRESSLY FORBIDDEN.

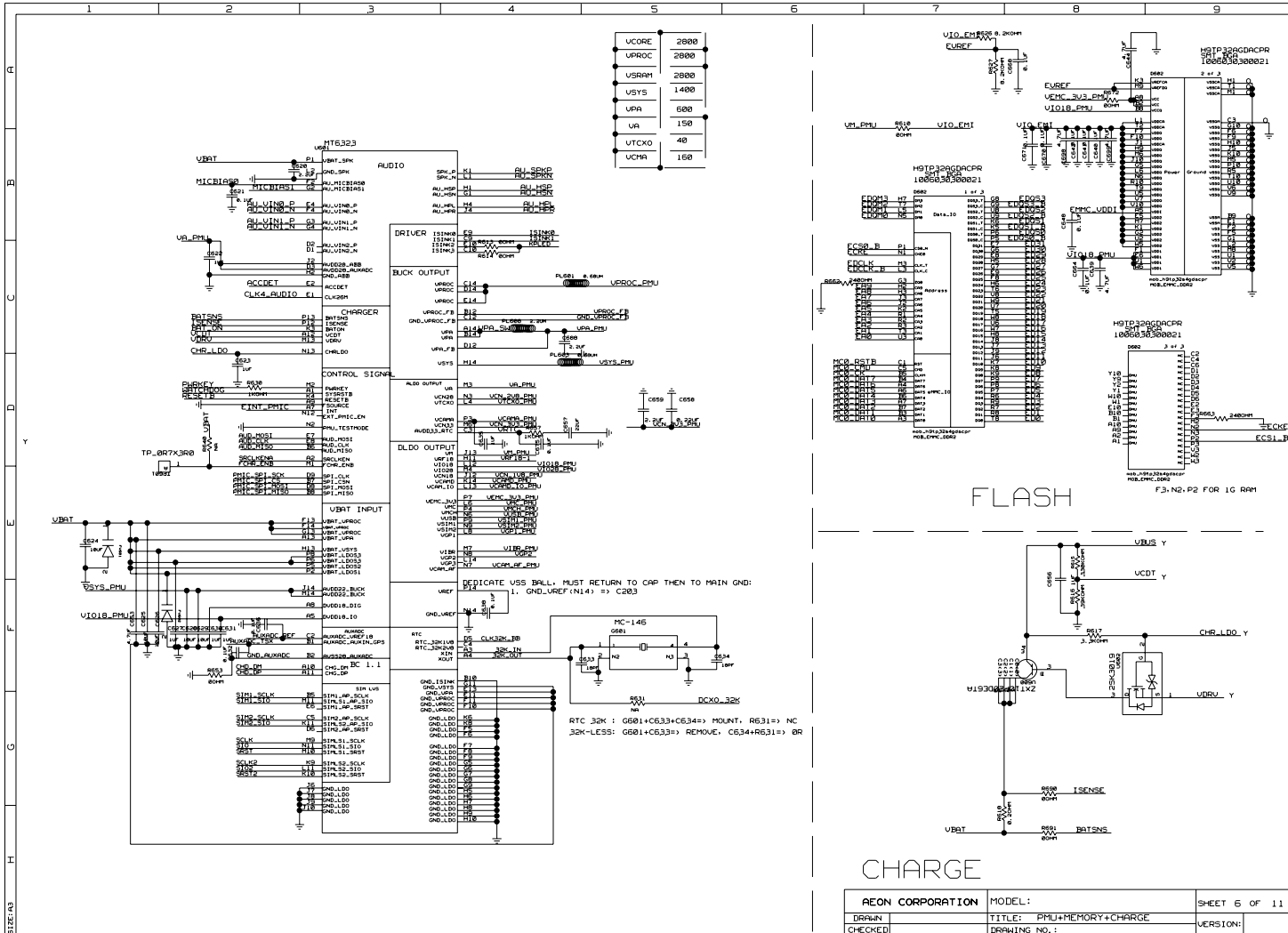

AECOR CORPORATION	MODEL:	SHEET 6 OF 11
DRAWN	TITLE: CPU+MEMORY+CHARGE	VERSION:
CHECKED	DRAWING NO.:	

THIS DOCUMENT CONTAINS INFORMATION PROPRIETARY TO AEON CORPORATION (AEON). USE OR DISCLOSURE WITHOUT THE WRITTEN PERMISSION OF AN OFFICER OF AEON IS EXPRESSLY FORBIDDEN.

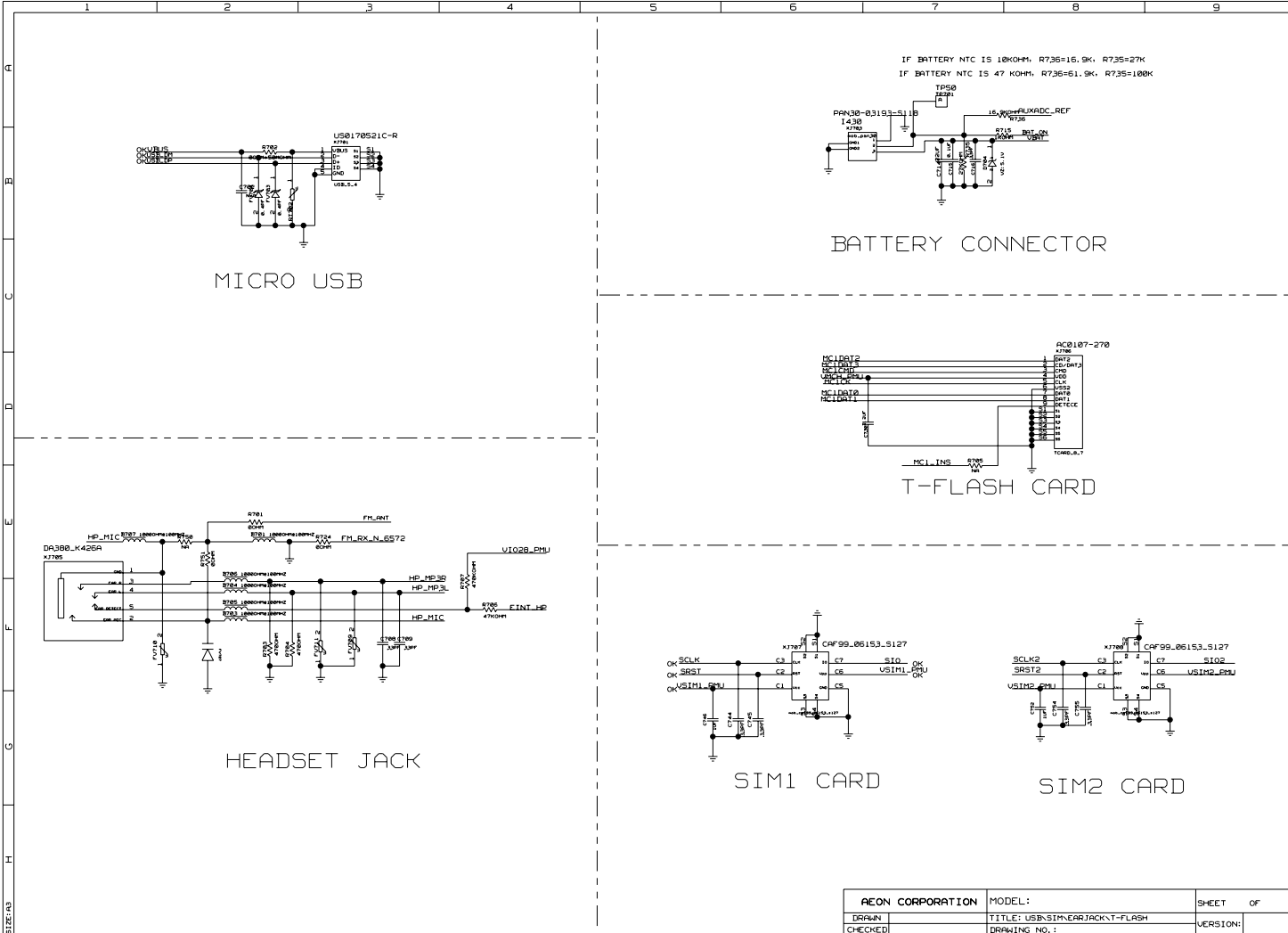

AEON CORPORATION	MODEL:	SHEET	OF
DRAWN	TITLE: USB/SIM/EAR/JACK/T-FLASH	VERSION:	
CHECKED	DRAWING NO.:		

THIS DOCUMENT CONTAINS INFORMATION PROPRIETARY TO REON CORPORATION (REON). USE OR DISCLOSURE WITHOUT THE WRITTEN PERMISSION OF AN OFFICER OF REON IS EXPRESSLY FORBIDDEN.

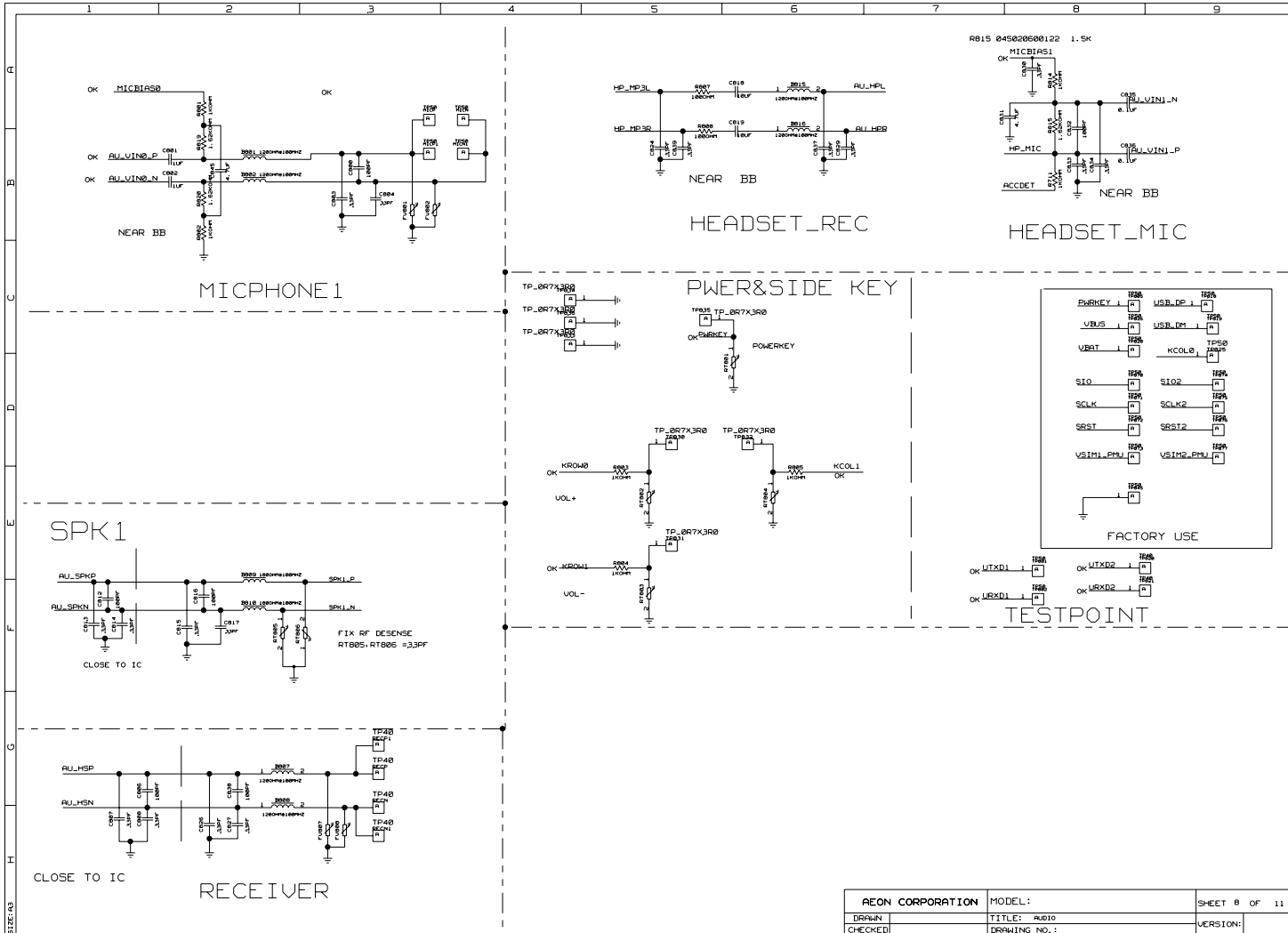

REON CORPORATION	MODEL:	SHEET 8 OF 11
DRAWN	TITLE: R4010	VERSION:
CHECKED	DRAWING NO.:	

THIS DOCUMENT CONTAINS INFORMATION PROPRIETARY TO AECOR CORPORATION (AECOR). USE OR DISCLOSURE WITHOUT THE WRITTEN PERMISSION OF AN OFFICER OF AECOR IS EXPRESSLY FORBIDDEN.

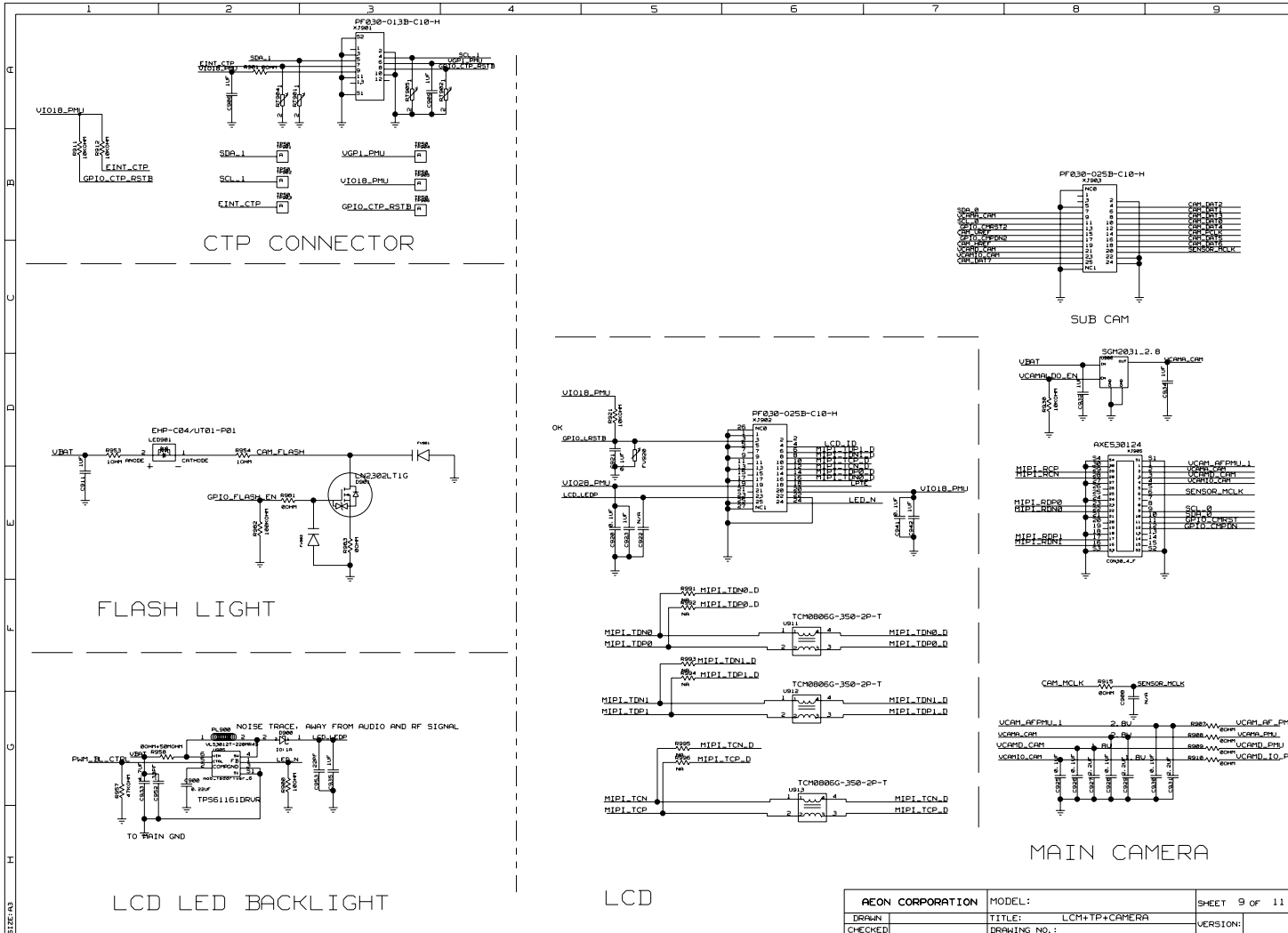

AECOR CORPORATION		MODEL:	SHEET 9 of 11
DRAWN	CHECKED	TITLE: LCM+TP+CAMERA	VERSION:
		DRAWING NO.:	

THIS DOCUMENT CONTAINS INFORMATION PROPRIETARY TO REON CORPORATION (REON). USE OR DISCLOSURE WITHOUT THE WRITTEN PERMISSION OF AN OFFICER OF REON IS EXPRESSLY FORBIDDEN.

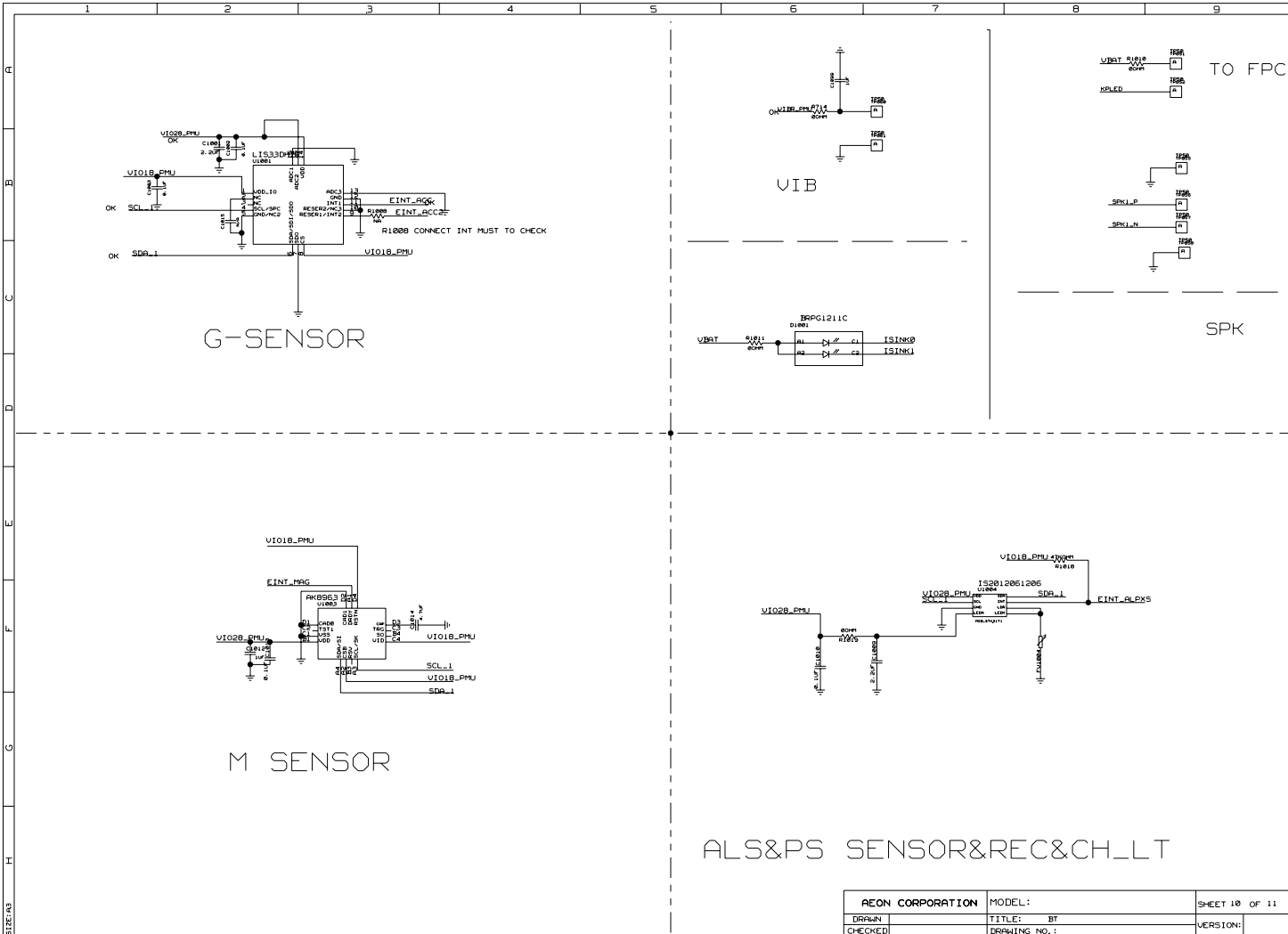

REON CORPORATION		MODEL:	SHEET 10 OF 11
DRAWN		TITLE: BT	VERSION:
CHECKED		DRAWING NO.:	

THIS DOCUMENT CONTAINS INFORMATION PROPRIETARY TO AEON CORPORATION (AEON). USE OR DISCLOSURE WITHOUT THE WRITTEN PERMISSION OF AN OFFICER OF AEON IS EXPRESSLY FORBIDDEN.

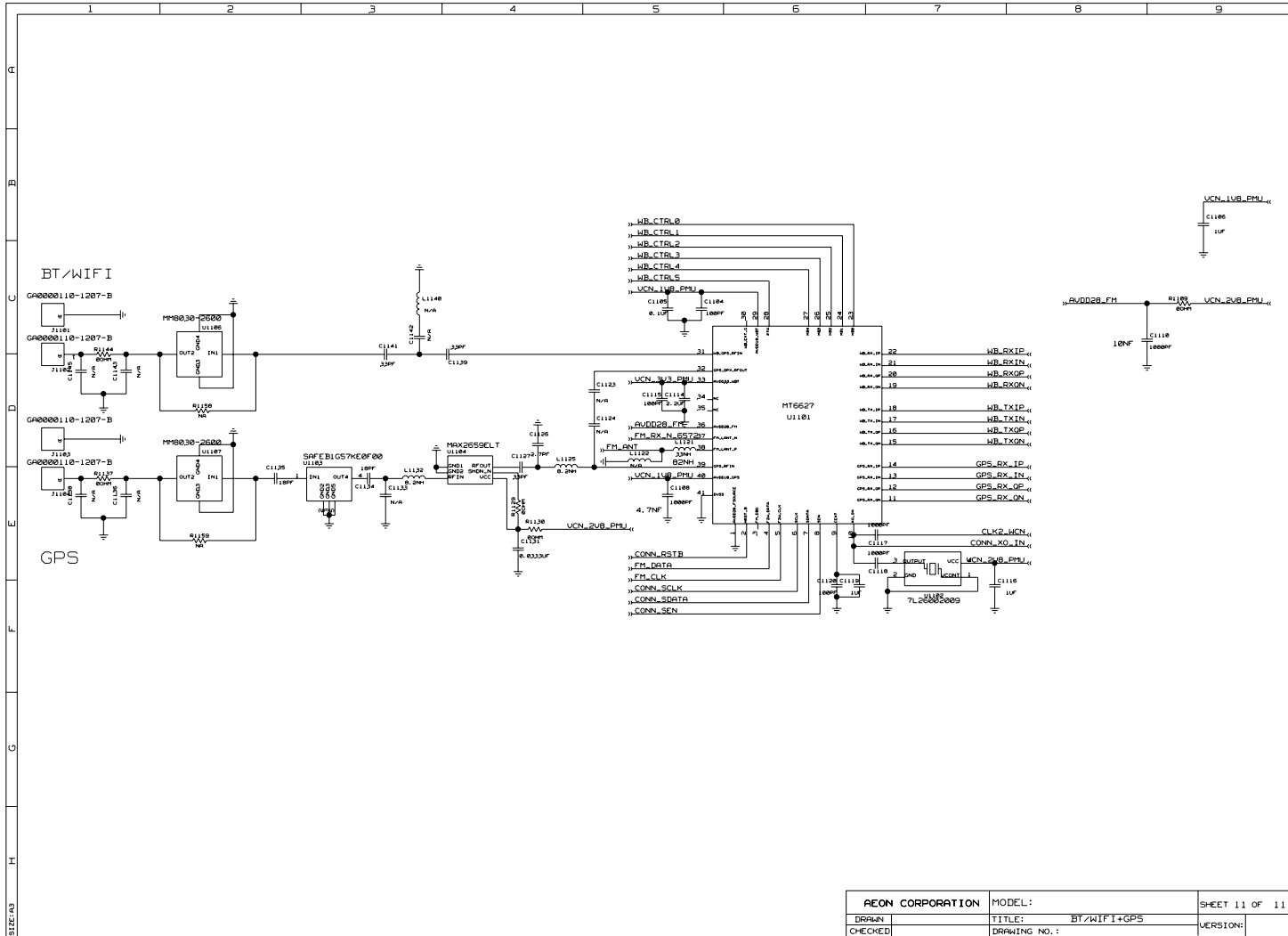

AEON CORPORATION	MODEL:	SHEET 11 OF 11
DRAWN	TITLE: BT/WiFi+GPS	VERSION:
CHECKED	DRAWING NO.:	