

Annex A CALIBRATION REPORTS

SARTIMO Calibration Certificate-Extended Dipole Calibrations

According to KDB 450824 D02, Dipoles must be recalibrated at least once every three years; however, immediate re-calibration is required for folmiddleing conditions. The test laboratory must ensure that the required supporting information and documentation have been included in the SAR report to qualify for extended 3-year calibration interval.

- 1) When the most recent return-loss, measured at least annually, deviates by more than 20% from the previous measurement (i.e. 0.2 of the dB value) or not meeting the required -20 dB return-loss specification
- 2) When the most recent measurement of the real or imaginary parts of the impedance, measured at least annually, deviates by more than 5 Ω from the previous measurement

Dipole Verification plot: SID 835 SN 31/10 DIPC150

835MHz for Head:

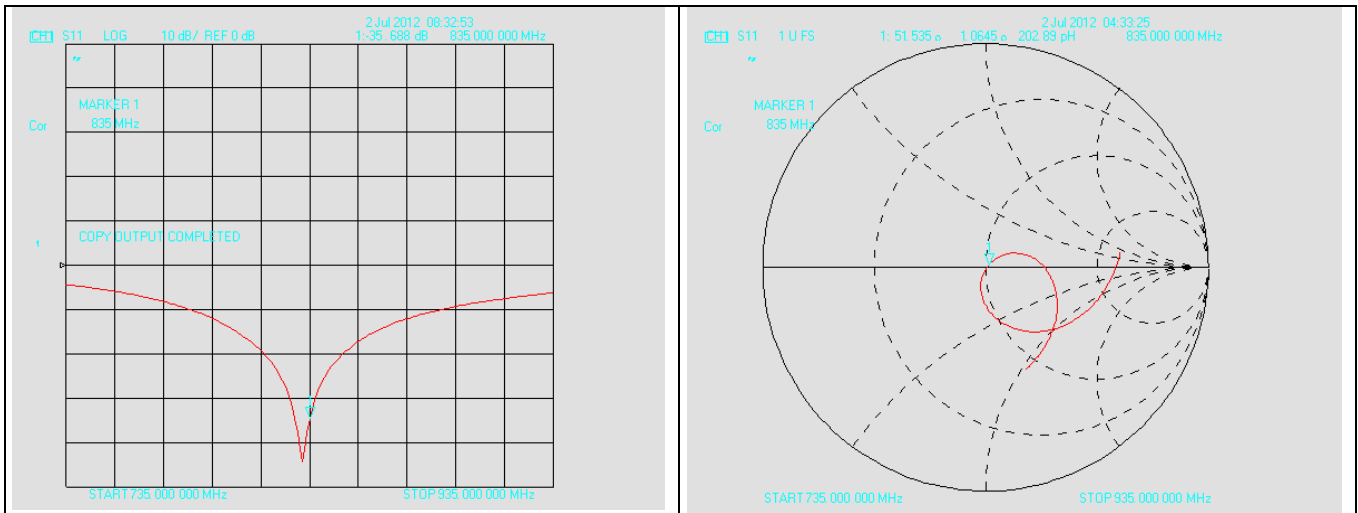

835MHz for Body:

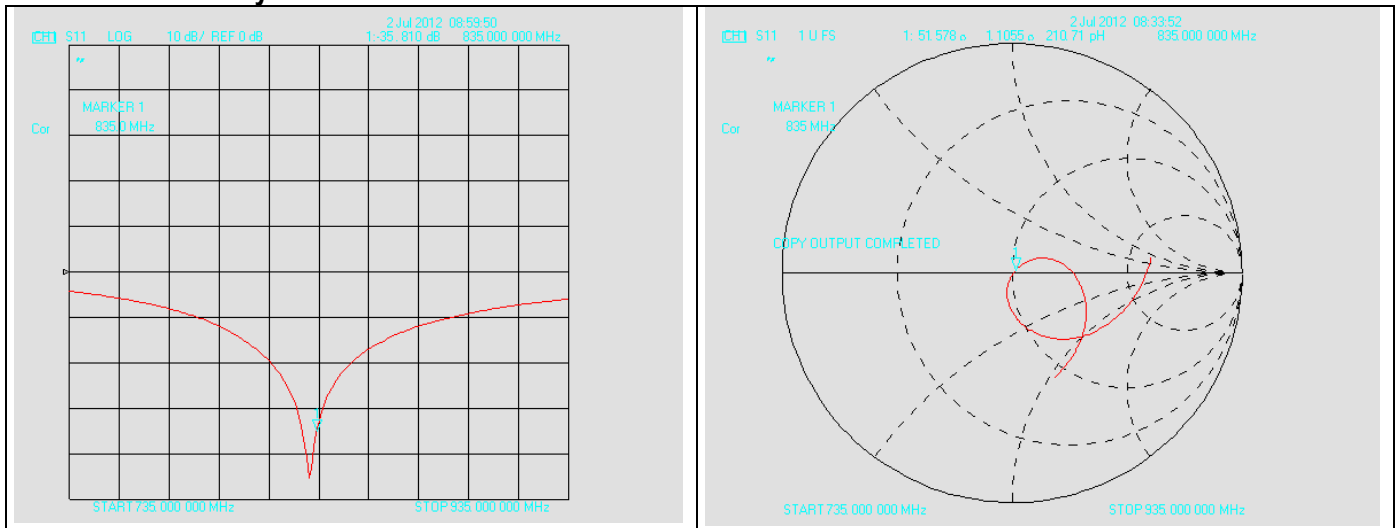

Dipole Verification plot: SID 1900 SN 31/10 DIPG153

1900MHz for Head:

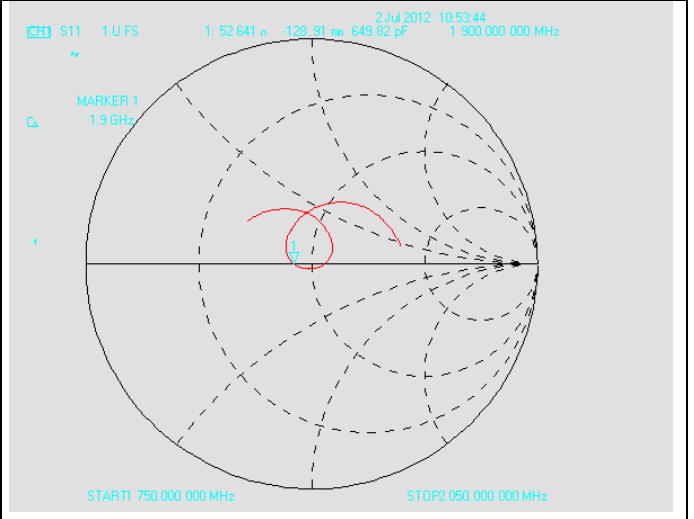
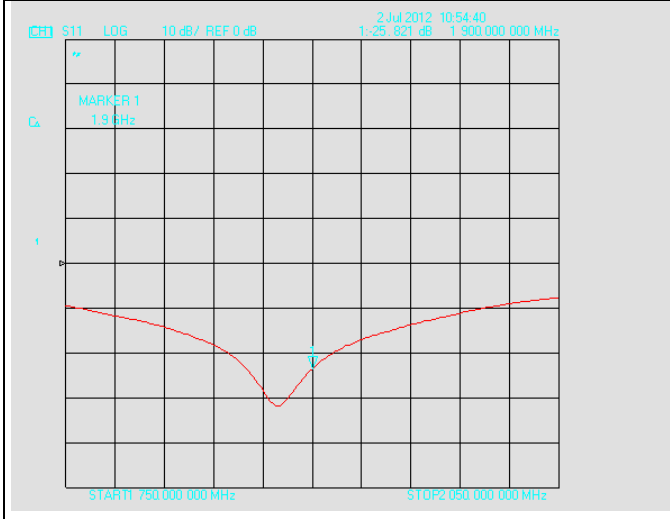

1900MHz for Body:

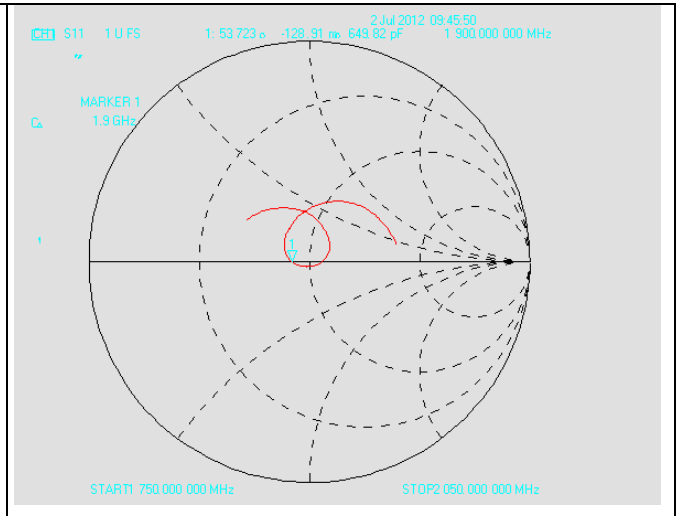
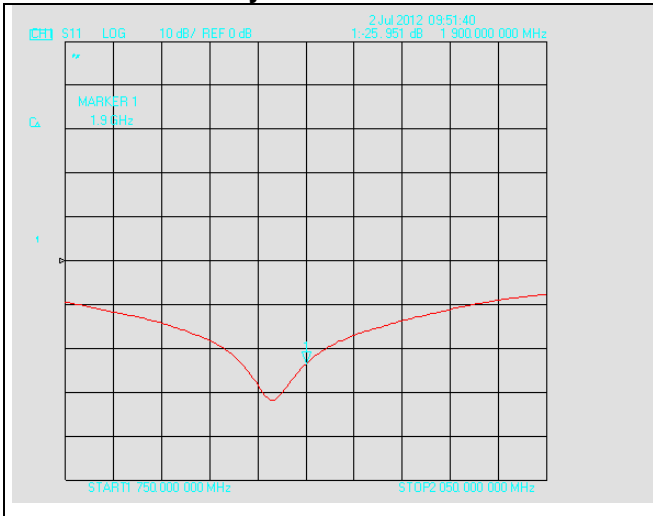

SID 835 SN 31/10 DIPC150 For Head

Return- Loss (dB)	Deviate (dB)	Real Impedance (Ω)	Imaginary Impedance (Ω)	Deviate (Ω)	Calibrate Date
-35.8	-----	-----	50	-----	06/01/2011
-35.688	0.112	51.535	50	1.535	07/02/2012

SID 835 SN 31/10 DIPC150 For Body

-35.810	-0.01	51.578	50	1.578	07/02/2012
---------	-------	--------	----	-------	------------

SID 1900 SN 31/10 DIPCG153 For Head

Return- Loss (dB)	Deviate (dB)	Real Impedance (Ω)	Imaginary Impedance (Ω)	Deviate (Ω)	Calibrate Date
-25.9	-----	-----	50	-----	06/01/2011
-25.821	0.079	52.641	50	2.641	07/02/2012

SID 1900 SN 31/10 DIPG153 For Body

-24.951	-0.051	53.723	50	3.723	07/02/2012
---------	--------	--------	----	-------	------------

According to up table, the return loss is <-20dB, deviates by less than 20% from the previous measurement; the real impedance are all within 5 Ω compared to the required impedance (50 Ω).



COMOSAR E-Field Probe Calibration Report

Ref : ACR.170.1.12.SATU.A

SIEMIC TESTING AND CERTIFICATION SERVICES
2206 RINGWOOD AVE.
SAN JOSE, CA 95131, USA
SATIMO COMOSAR DOSIMETRIC E-FIELD PROBE
SERIAL NO.: SN 18/11 EPG123

Calibrated at **SATIMO US**
2105 Barrett Park Dr. - Kennesaw, GA 30144

ACCREDITED
Calibration CERT #2246.02
13/06/2012

Summary:
This document presents the method and results from an accredited COMOSAR Dosimetric E-Field Probe calibration performed in SATIMO USA using the CALISAR / CALIBAIR test bench, for use with a SATIMO COMOSAR system only. All calibration results are traceable to national metrology institutions.



COMOSAR E-FIELD PROBE CALIBRATION REPORT

Ref: ACR.170.1.12.SATU.A

	<i>Name</i>	<i>Function</i>	<i>Date</i>	<i>Signature</i>
<i>Prepared by :</i>	Jérôme LUC	Product Manager	6/18/2012	<i>JS</i>
<i>Checked by :</i>	Jérôme LUC	Product Manager	6/18/2012	<i>JS</i>
<i>Approved by :</i>	Kim RUTKOWSKI	Quality Manager	6/18/2012	<i>Kim Rutkowski</i>

	<i>Customer Name</i>
<i>Distribution :</i>	SIEMIC Testing and Certification Services

<i>Issue</i>	<i>Date</i>	<i>Modifications</i>
A	6/18/2012	Initial release



COMOSAR E-FIELD PROBE CALIBRATION REPORT

Ref. ACR.170.1.12.SATU.A

TABLE OF CONTENTS

1	Device Under Test	4
2	Product Description	4
2.1	General Information	4
3	Measurement Method	4
3.1	Linearity	4
3.2	Sensitivity	5
3.3	Lower Detection Limit	5
3.4	Isotropy	5
3.5	Boundary Effect	5
4	Measurement Uncertainty	5
5	Calibration Measurement Results	6
5.1	Sensitivity in air	6
5.2	Linearity	7
5.3	Sensitivity in liquid	7
5.4	Isotropy	8
6	List of Equipment	10



1 DEVICE UNDER TEST

Device Under Test	
Device Type	COMOSAR DOSIMETRIC E FIELD PROBE
Manufacturer	Satimo
Model	SSE2
Serial Number	SN 18/11 EPG123
Product Condition (new / used)	used
Frequency Range of Probe	0.7 GHz-6GHz
Resistance of Three Dipoles at Connector	Dipole 1: R1=0.179 MΩ Dipole 2: R2=0.191 MΩ Dipole 3: R3=0.189 MΩ

A yearly calibration interval is recommended.

2 PRODUCT DESCRIPTION

2.1 GENERAL INFORMATION

Satimo's COMOSAR E field Probes are built in accordance to the IEEE 1528, OET 65 Bulletin C and CEI/IEC 62209 standards.



Figure 1 – Satimo COMOSAR Dosimetric E field Dipole

Probe Length	330 mm
Length of Individual Dipoles	2 mm
Maximum external diameter	8 mm
Probe Tip External Diameter	2.5 mm
Distance between dipoles / probe extremity	1 mm

3 MEASUREMENT METHOD

The IEEE 1528, OET 65 Bulletin C, CENELEC EN50361 and CEI/IEC 62209 standards provide recommended practices for the probe calibrations, including the performance characteristics of interest and methods by which to assess their affect. All calibrations / measurements performed meet the fore mentioned standards.

3.1 LINEARITY

The evaluation of the linearity was done in free space using the waveguide, performing a power sweep to cover the SAR range 0.01W/kg to 100W/kg.



COMOSAR E-FIELD PROBE CALIBRATION REPORT

Ref: ACR.170.1.12.SATU.A

3.2 SENSITIVITY

The sensitivity factors of the three dipoles were determined using a two step calibration method (air and tissue simulating liquid) using waveguides as outlined in the standards.

3.3 LOWER DETECTION LIMIT

The lower detection limit was assessed using the same measurement set up as used for the linearity measurement. The required lower detection limit is 10 mW/kg.

3.4 ISOTROPY

The axial isotropy was evaluated by exposing the probe to a reference wave from a standard dipole with the dipole mounted under the flat phantom in the test configuration suggested for system validations and checks. The probe was rotated along its main axis from 0 - 360 degrees in 15 degree steps. The hemispherical isotropy is determined by inserting the probe in a thin plastic box filled with tissue-equivalent liquid, with the plastic box illuminated with the fields from a half wave dipole. The dipole is rotated about its axis (0°–180°) in 15° increments. At each step the probe is rotated about its axis (0°–360°).

3.5 BOUNDARY EFFECT

The boundary effect is defined as the deviation between the SAR measured data and the expected exponential decay in the liquid when the probe is oriented normal to the interface. To evaluate this effect, the liquid filled flat phantom is exposed to fields from either a reference dipole or waveguide. With the probe normal to the phantom surface, the peak spatial average SAR is measured and compared to the analytical value at the surface.

4 MEASUREMENT UNCERTAINTY

The guidelines outlined in the IEEE 1528, OET 65 Bulletin C, CENELEC EN50361 and CEI/IEC 62209 standards were followed to generate the measurement uncertainty associated with an E-field probe calibration using the waveguide technique. All uncertainties listed below represent an expanded uncertainty expressed at approximately the 95% confidence level using a coverage factor of k=2, traceable to the Internationally Accepted Guides to Measurement Uncertainty.

Uncertainty analysis of the probe calibration in waveguide					
ERROR SOURCES	Uncertainty value (%)	Probability Distribution	Divisor	ci	Standard Uncertainty (%)
Incident or forward power	3.00%	Rectangular	$\sqrt{3}$	1	1.732%
Reflected power	3.00%	Rectangular	$\sqrt{3}$	1	1.732%
Liquid conductivity	5.00%	Rectangular	$\sqrt{3}$	1	2.887%
Liquid permittivity	4.00%	Rectangular	$\sqrt{3}$	1	2.309%
Field homogeneity	3.00%	Rectangular	$\sqrt{3}$	1	1.732%
Field probe positioning	5.00%	Rectangular	$\sqrt{3}$	1	2.887%
Field probe linearity	3.00%	Rectangular	$\sqrt{3}$	1	1.732%

This document shall not be reproduced, except in full or in part, without the written approval of SATIMO. The information contained herein is to be used only for the purpose for which it is submitted and is not to be released in whole or part without written approval of SATIMO.



COMOSAR E-FIELD PROBE CALIBRATION REPORT

Ref: ACR.170.1.12.SATU.A

Combined standard uncertainty					5.831%
Expanded uncertainty 95 % confidence level k = 2					11.662%

5 CALIBRATION MEASUREMENT RESULTS

Calibration Parameters	
Liquid Temperature	21 °C
Lab Temperature	21 °C
Lab Humidity	45 %

5.1 SENSITIVITY IN AIR

Normx dipole 1 ($\mu\text{V}/(\text{V}/\text{m})^2$)	Normy dipole 2 ($\mu\text{V}/(\text{V}/\text{m})^2$)	Normz dipole 3 ($\mu\text{V}/(\text{V}/\text{m})^2$)
0.77	0.86	0.55

DCP dipole 1 (mV)	DCP dipole 2 (mV)	DCP dipole 3 (mV)
111	110	101

Calibration curves $e_i=f(V)$ ($i=1,2,3$) allow to obtain H-field value using the formula:

$$E = \sqrt{E_1^2 + E_2^2 + E_3^2}$$

Calibration curves

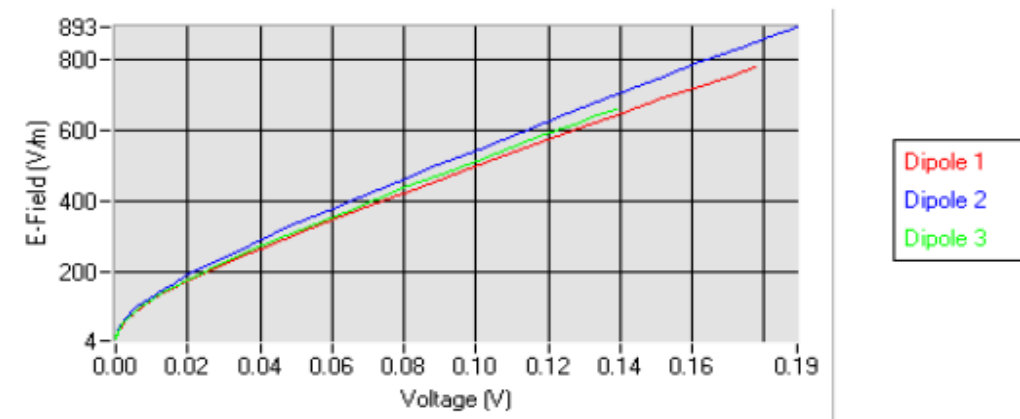



COMOSAR E-FIELD PROBE CALIBRATION REPORT

Ref: ACR.170.1.12.SATU.A

5.2 LINEARITY

Linearity

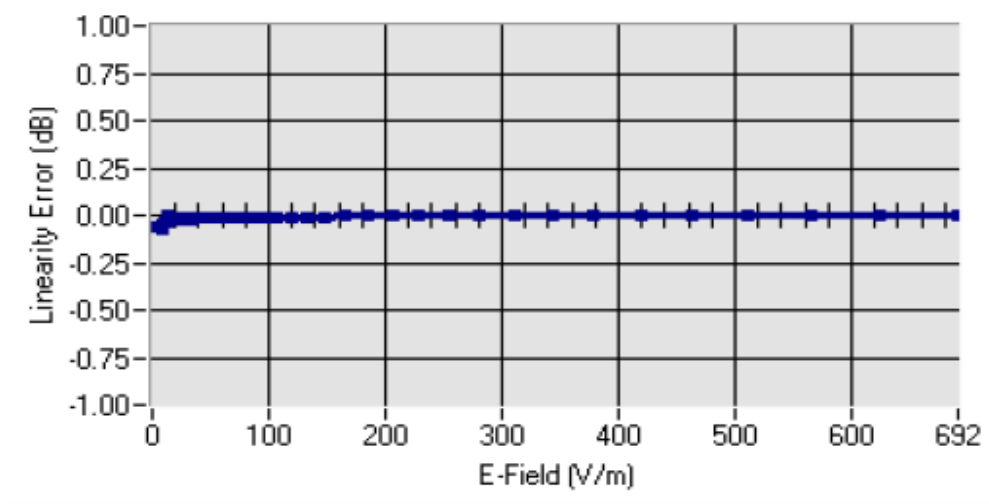

Linearity: $\pm 1.59\%$ ($\pm 0.07\text{dB}$)

5.3 SENSITIVITY IN LIQUID

<u>Liquid</u>	<u>Frequency</u> (MHz +/- 100MHz)	<u>Permittivity</u>	<u>Epsilon (S/m)</u>	<u>ConvF</u>
HL850	835	40.96	0.90	7.53
BL850	835	54.10	0.99	7.75
HL900	900	40.60	0.97	7.08
BL900	900	53.00	1.04	7.35
HL1800	1750	40.45	1.38	7.26
BL1800	1750	54.23	1.50	7.54
HL1900	1880	38.89	1.38	7.92
BL1900	1880	53.89	1.52	8.18
HL2000	1950	39.47	1.43	7.76
BL2000	1950	52.75	1.47	7.92
HL2450	2450	38.97	1.88	7.93
BL2450	2450	51.87	1.95	8.16
HL3500	3500	39.83	2.85	5.45
BL3500	3500	51.00	3.16	5.67
HL5200	5200	36.95	4.61	5.29
BL5200	5200	48.99	5.00	5.47
HL5500	5500	34.70	4.96	5.91
BL5500	5500	49.28	5.76	6.07
HL5800	5800	33.69	5.62	6.13
BL5800	5800	48.13	6.14	6.27

LOWER DETECTION LIMIT: 7mW/kg



5.4 ISOTROPY

HL900 MHz

- Axial isotropy: 0.04 dB
- Hemispherical isotropy: 0.08 dB

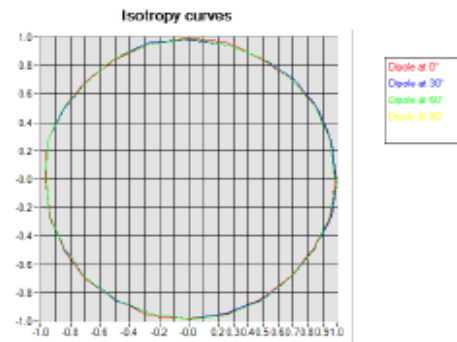

HL1800 MHz

- Axial isotropy: 0.06 dB
- Hemispherical isotropy: 0.10 dB

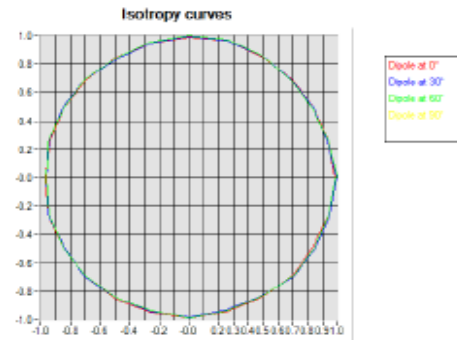

HL5500 MHz

- Axial isotropy: 0.08 dB
- Hemispherical isotropy: 0.15 dB



SIEMIC, Inc.

Accessing global markets

Title: SAR Test Report of Mobile Phone
Model : L1-Forst 3G
To : C95.1, IEEE 1528, OET Bulletin 65 Supplement C, IEC62209-2 & RSS-102
Issue 4 and Safety Code 6

Serial# 13050019-FCC-H
Issue Date May 21th, 2013
Page 80 of 105
www.siemic.com



COMOSAR E-FIELD PROBE CALIBRATION REPORT

Ref: ACR.170.1.12.SATU

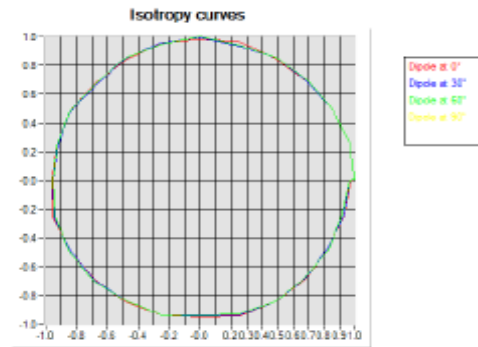



6 LIST OF EQUIPMENT

Equipment Summary Sheet				
Equipment Description	Manufacturer / Model	Identification No.	Current Calibration Date	Next Calibration Date
Flat Phantom	Satimo	SN-20/09-SAM71	Validated. No cal required.	Validated. No cal required.
COMOSAR Test Bench	Version 3	NA	Validated. No cal required.	Validated. No cal required.
Network Analyzer	Rhode & Schwarz ZVA	SN100132	02/2010	02/2013
Reference Probe	Satimo	EP 94 SN 37/08	Characterized prior to test. No cal required.	Characterized prior to test. No cal required.
Multimeter	Keithley 2000	1188656	11/2010	11/2013
Signal Generator	Agilent E4438C	MY49070581	12/2010	12/2013
Amplifier	Aethercomm	SN 046	Characterized prior to test. No cal required.	Characterized prior to test. No cal required.
Power Meter	HP E4418A	US38261498	11/2010	11/2013
Power Sensor	HP ECP-E26A	US37181460	11/2010	11/2013
Directional Coupler	Narda 4216-20	01386	Characterized prior to test. No cal required.	Characterized prior to test. No cal required.
Waveguide	Mega Industries	069Y7-158-13-712	Validated. No cal required.	Validated. No cal required.
Waveguide Transition	Mega Industries	069Y7-158-13-701	Validated. No cal required.	Validated. No cal required.
Waveguide Termination	Mega Industries	069Y7-158-13-701	Validated. No cal required.	Validated. No cal required.
Temperature / Humidity Sensor	Control Company	11-661-9	3/2012	3/2014



SAR Reference Dipole Calibration Report

Ref : ACR.158.4.11.SATU.A

SIEMIC TESTING AND CERTIFICATION SERVICES

SUITE 311, BUILDING 1, SECTION 30 ,NO.2 KEFA ROAD,
SCIENCE AND TECHNOLOGY PARK
NAN SHAN DISTRICT, SHENZHEN 518057 , GUANGDONG
,P.R.C.

SATIMO COMOSAR REFERENCE DIPOLE

Calibrated at SATIMO US
2105 Barrett Park Dr. - Kennesaw, GA 30144



06/01/2011



Summary:

This document presents the method and results from an accredited SAR reference dipole calibration performed in SATIMO USA using the COMOSAR test bench. All calibration results are traceable to national metrology institutions.



SAR REFERENCE DIPOLE CALIBRATION REPORT

Ref: ACR.158.4.11.SATU.A

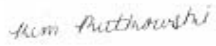
	<i>Name</i>	<i>Function</i>	<i>Date</i>	<i>Signature</i>
<i>Prepared by :</i>	Jérôme LUC	Product Manager	6/7/2011	
<i>Checked by :</i>	Jérôme LUC	Product Manager	6/7/2011	
<i>Approved by :</i>	Kim RUTKOWSKI	Quality Manager	6/7/2011	

	<i>Customer Name</i>
<i>Distribution :</i>	SIEMIC Testing and Certification Services

<i>Issue</i>	<i>Date</i>	<i>Modifications</i>
A	6/7/2011	Initial release



TABLE OF CONTENTS

1	Introduction.....	4
2	Device Under Test	4
3	Product Description	4
3.1	General Information	4
4	Measurement Method	5
4.1	Return Loss Requirements	5
4.2	Mechanical Requirements.....	5
5	Measurement Uncertainty.....	5
5.1	Return Loss.....	5
5.2	Dimension Measurement	5
5.3	Validation Measurement.....	5
6	Calibration Measurement Results	6
6.1	Return Loss.....	6
6.2	Mechanical Dimensions	6
7	Validation measurement	7
7.1	Measurement Condition	7
7.2	Head Liquid Measurement	7
7.3	Measurement Result	8
8	List of Equipment	8



1 INTRODUCTION

This document contains a summary of the requirements set forth by the IEEE 1528, OET 65 Bulletin C and CEI/IEC 62209 standards for reference dipoles used for SAR measurement system validations and the measurements that were performed to verify that the product complies with the fore mentioned standards.

2 DEVICE UNDER TEST

Device Under Test	
Device Type	COMOSAR 835 MHz REFERENCE DIPOLE
Manufacturer	Satimo
Model	SID835
Serial Number	SN 18/11 DIPC150
Product Condition (new / used)	new

A yearly calibration interval is recommended.

3 PRODUCT DESCRIPTION

3.1 GENERAL INFORMATION

Satimo's COMOSAR Validation Dipoles are built in accordance to the IEEE 1528, OET 65 Bulletin C and CEI/IEC 62209 standards. The product is designed for use with the COMOSAR test bench only.



Figure 1 – Satimo COMOSAR Validation Dipole



4 MEASUREMENT METHOD

The IEEE 1528, OET 65 Bulletin C and CEI/IEC 62209 standards provide requirements for reference dipoles used for system validation measurements. The following measurements were performed to verify that the product complies with the fore mentioned standards.

4.1 RETURN LOSS REQUIREMENTS

The dipole used for SAR system validation measurements and checks must have a return loss of -20 dB or better. The return loss measurement shall be performed against a liquid filled flat phantom, with the phantom constructed as outlined in the fore mentioned standards.

4.2 MECHANICAL REQUIREMENTS

The IEEE Std. 1528 and CEI/IEC 62209 standards specify the mechanical components and dimensions of the validation dipoles, with the dimensions frequency and phantom shell thickness dependent. The COMOSAR test bench employs a 2 mm phantom shell thickness therefore the dipoles sold for use with the COMOSAR test bench comply with the requirements set forth for a 2 mm phantom shell thickness.

5 MEASUREMENT UNCERTAINTY

All uncertainties listed below represent an expanded uncertainty expressed at approximately the 95% confidence level using a coverage factor of k=2, traceable to the Internationally Accepted Guides to Measurement Uncertainty.

5.1 RETURN LOSS

The following uncertainties apply to the return loss measurement:

Frequency band	Expanded Uncertainty on Return Loss
400-6000MHz	0.1 dB

5.2 DIMENSION MEASUREMENT

The following uncertainties apply to the dimension measurements:

Length (mm)	Expanded Uncertainty on Length
3 - 300	0.05 mm

5.3 VALIDATION MEASUREMENT

The guidelines outlined in the IEEE 1528, OET 65 Bulletin C, CENELEC EN50361 and CEI/IEC 62209 standards were followed to generate the measurement uncertainty for validation measurements.

Scan Volume	Expanded Uncertainty
1 g	16.19 %
10 g	15.86 %



SAR REFERENCE DIPOLE CALIBRATION REPORT

Ref: ACR.158.4.11.SATU.A

6 CALIBRATION MEASUREMENT RESULTS

6.1 RETURN LOSS

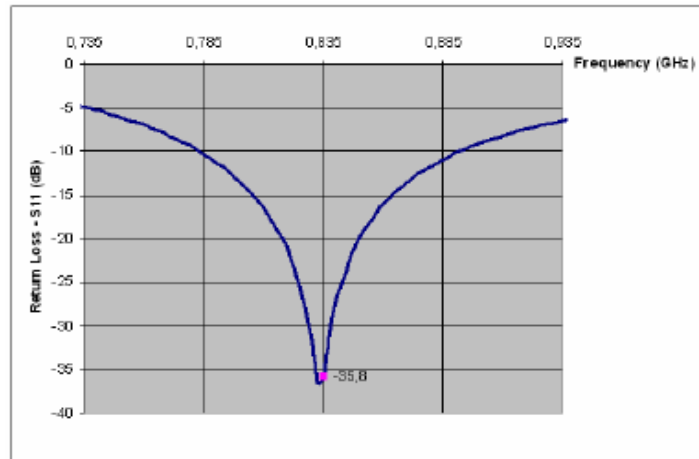

Frequency (MHz)	Return Loss (dB)	Requirement (dB)
835	-35.8	-20

6.2 MECHANICAL DIMENSIONS

Frequency MHz	L mm		h mm		d mm	
	required	measured	required	measured	required	measured
300	420.0 ±1 %.		250.0 ±1 %.		6.35 ±1 %.	
450	290.0 ±1 %.		166.7 ±1 %.		6.35 ±1 %.	
750	176.0 ±1 %.		100.0 ±1 %.		6.35 ±1 %.	
835	161.0 ±1 %.	PASS	89.8 ±1 %.	PASS	3.6 ±1 %.	PASS
900	149.0 ±1 %.		83.3 ±1 %.		3.6 ±1 %.	
1450	89.1 ±1 %.		51.7 ±1 %.		3.6 ±1 %.	
1500	80.5 ±1 %.		50.0 ±1 %.		3.6 ±1 %.	
1640	79.0 ±1 %.		45.7 ±1 %.		3.6 ±1 %.	
1750	75.2 ±1 %.		42.9 ±1 %.		3.6 ±1 %.	
1800	72.0 ±1 %.		41.7 ±1 %.		3.6 ±1 %.	
1900	68.0 ±1 %.		39.5 ±1 %.		3.6 ±1 %.	
1950	66.3 ±1 %.		38.5 ±1 %.		3.6 ±1 %.	
2000	64.5 ±1 %.		37.5 ±1 %.		3.6 ±1 %.	
2100	61.0 ±1 %.		35.7 ±1 %.		3.6 ±1 %.	
2300	55.5 ±1 %.		32.6 ±1 %.		3.6 ±1 %.	
2450	51.5 ±1 %.		30.4 ±1 %.		3.6 ±1 %.	
2600	48.5 ±1 %.		28.8 ±1 %.		3.6 ±1 %.	
3000	41.5 ±1 %.		25.0 ±1 %.		3.6 ±1 %.	
3500	37.0 ±1 %.		26.4 ±1 %.		3.6 ±1 %.	
3700	34.7 ±1 %.		26.4 ±1 %.		3.6 ±1 %.	



7 VALIDATION MEASUREMENT

The IEEE Std. 1528, OET 65 Bulletin C and CEI/IEC 62209 standards state that the system validation measurements must be performed using a reference dipole meeting the fore mentioned return loss and mechanical dimension requirements. The validation measurement must be performed against a liquid filled flat phantom, with the phantom constructed as outlined in the fore mentioned standards. Per the standards, the dipole shall be positioned below the bottom of the phantom, with the dipole length centered and parallel to the longest dimension of the flat phantom, with the top surface of the dipole at the described distance from the bottom surface of the phantom.

7.1 MEASUREMENT CONDITION

Software	OPENSAR V4
Phantom	SN 20/09 SAM71
Probe	SN 18/11 EPG122
Liquid	Head Liquid Values: eps' : 43.0 sigma : 0.88
Distance between dipole center and liquid	15.0 mm
Area scan resolution	dx=8mm/dy=8mm
Zoon Scan Resolution	dx=8mm/dy=8m/dz=5mm
Frequency	835 MHz
Input power	20 dBm
Liquid Temperature	21 °C
Lab Temperature	21 °C
Lab Humidity	45 %

7.2 HEAD LIQUID MEASUREMENT

Frequency MHz	Relative permittivity (ϵ_r')		Conductivity (σ) S/m	
	required	measured	required	measured
300	45.3 ±5 %		0.87 ±5 %	
450	43.5 ±5 %		0.87 ±5 %	
750	41.9 ±5 %		0.89 ±5 %	
835	41.5 ±5 %	PASS	0.90 ±5 %	PASS
900	41.5 ±5 %		0.97 ±5 %	
1450	40.5 ±5 %		1.20 ±5 %	
1500	40.4 ±5 %		1.23 ±5 %	
1640	40.2 ±5 %		1.31 ±5 %	
1750	40.1 ±5 %		1.37 ±5 %	
1800	40.0 ±5 %		1.40 ±5 %	
1900	40.0 ±5 %		1.40 ±5 %	
1950	40.0 ±5 %		1.40 ±5 %	
2000	40.0 ±5 %		1.40 ±5 %	
2100	39.8 ±5 %		1.49 ±5 %	
2300	39.5 ±5 %		1.67 ±5 %	
2450	39.2 ±5 %		1.80 ±5 %	
2600	39.0 ±5 %		1.96 ±5 %	
3000	38.5 ±5 %		2.40 ±5 %	
3500	37.9 ±5 %		2.91 ±5 %	



7.3 MEASUREMENT RESULT

The IEEE Std. 1528 and CEI/IEC 62209 standards state that the system validation measurements should produce the SAR values shown below (for phantom thickness of 2 mm), within the uncertainty for the system validation. All SAR values are normalized to 1 W forward power. In bracket, the measured SAR is given with the used input power.

Frequency MHz	1 g SAR (W/kg/W)		10 g SAR (W/kg/W)	
	required	measured	required	measured
300	2.85		1.94	
450	4.58		3.06	
750	8.49		5.55	
835	9.56	9.59 (0.96)	6.22	6.25 (0.62)
900	10.9		6.99	
1450	29		16	
1500	30.5		16.8	
1640	34.2		18.4	
1750	36.4		19.3	
1800	38.4		20.1	
1900	39.7		20.5	
1950	40.5		20.9	
2000	41.1		21.1	
2100	43.6		21.9	
2300	48.7		23.3	
2450	52.4		24	
2600	55.3		24.6	
3000	63.8		25.7	
3500	67.1		25	

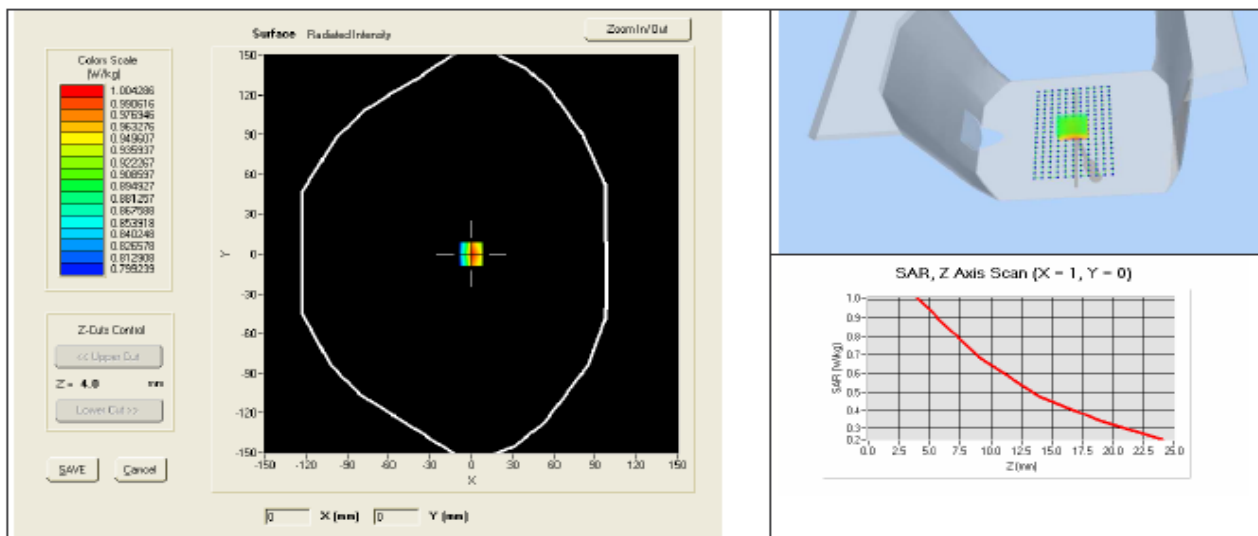



8 LIST OF EQUIPMENT

Equipment Summary Sheet				
Equipment Description	Manufacturer / Model	Identification No.	Current Calibration Date	Next Calibration Date
Flat Phantom	Satimo	SN-20/09-SAM71	Validated. No cal required.	Validated. No cal required.
COMOSAR Test Bench	Version 3	NA	Validated. No cal required.	Validated. No cal required.
Network Analyzer	Rhode & Schwarz ZVA	SN100132	02/2010	02/2013
Calipers	Carrera	CALIPER-01	12/2010	12/2013
Reference Probe	Satimo	EPG122 SN 18/11	Characterized prior to test. No cal required.	Characterized prior to test. No cal required.
Multimeter	Keithley 2000	1188656	11/2010	11/2013
Signal Generator	Agilent E4438C	MY49070581	12/2010	12/2013
Amplifier	Aethercomm	SN 046	Characterized prior to test. No cal required.	Characterized prior to test. No cal required.
Power Meter	HP E4418A	US38261498	11/2010	11/2013
Power Sensor	HP ECP-E26A	US37181460	11/2010	11/2013
Directional Coupler	Narda 4216-20	01386	Characterized prior to test. No cal required.	Characterized prior to test. No cal required.
Temperature and Humidity Sensor	Control Company	11-661-9	3/2010	3/2012



SAR Reference Dipole Calibration Report

Ref : ACR.158.7.11.SATU.A

SIEMIC TESTING AND CERTIFICATION SERVICES

SUITE 311, BUILDING 1, SECTION 30 ,NO.2 KEFA ROAD,
SCIENCE AND TECHNOLOGY PARK
NAN SHAN DISTRICT, SHENZHEN 518057 , GUANGDONG
,P.R.C.

SATIMO COMOSAR REFERENCE DIPOLE

Calibrated at SATIMO US
2105 Barrett Park Dr. - Kennesaw, GA 30144



06/01/2011

Summary:

This document presents the method and results from an accredited SAR reference dipole calibration performed in SATIMO USA using the COMOSAR test bench. All calibration results are traceable to national metrology institutions.



SAR REFERENCE DIPOLE CALIBRATION REPORT

Ref: ACR.158.7.11.SATU.A

	<i>Name</i>	<i>Function</i>	<i>Date</i>	<i>Signature</i>
<i>Prepared by :</i>	Jérôme LUC	Product Manager	6/7/2011	<i>JL</i>
<i>Checked by :</i>	Jérôme LUC	Product Manager	6/7/2011	<i>JL</i>
<i>Approved by :</i>	Kim RUTKOWSKI	Quality Manager	6/7/2011	<i>Kim Rutkowski</i>

	<i>Customer Name</i>
<i>Distribution :</i>	SIEMIC Testing and Certification Services

<i>Issue</i>	<i>Date</i>	<i>Modifications</i>
A	6/7/2011	Initial release



TABLE OF CONTENTS

1	Introduction.....	4
2	Device Under Test	4
3	Product Description	4
3.1	General Information	4
4	Measurement Method	5
4.1	Return Loss Requirements	5
4.2	Mechanical Requirements.....	5
5	Measurement Uncertainty.....	5
5.1	Return Loss.....	5
5.2	Dimension Measurement	5
5.3	Validation Measurement.....	5
6	Calibration Measurement Results	6
6.1	Return Loss.....	6
6.2	Mechanical Dimensions	6
7	Validation measurement	7
7.1	Measurement Condition	7
7.2	Head Liquid Measurement	7
7.3	Measurement Result	8
8	List of Equipment	8



1 INTRODUCTION

This document contains a summary of the requirements set forth by the IEEE 1528, OET 65 Bulletin C and CEI/IEC 62209 standards for reference dipoles used for SAR measurement system validations and the measurements that were performed to verify that the product complies with the fore mentioned standards.

2 DEVICE UNDER TEST

Device Under Test	
Device Type	COMOSAR 1900 MHz REFERENCE DIPOLE
Manufacturer	Satimo
Model	SID1900
Serial Number	SN 18/11 DIPG153
Product Condition (new / used)	new

A yearly calibration interval is recommended.

3 PRODUCT DESCRIPTION

3.1 GENERAL INFORMATION

Satimo's COMOSAR Validation Dipoles are built in accordance to the IEEE 1528, OET 65 Bulletin C and CEI/IEC 62209 standards. The product is designed for use with the COMOSAR test bench only.



Figure 1 – Satimo COMOSAR Validation Dipole



4 MEASUREMENT METHOD

The IEEE 1528, OET 65 Bulletin C and CEI/IEC 62209 standards provide requirements for reference dipoles used for system validation measurements. The following measurements were performed to verify that the product complies with the fore mentioned standards.

4.1 RETURN LOSS REQUIREMENTS

The dipole used for SAR system validation measurements and checks must have a return loss of -20 dB or better. The return loss measurement shall be performed against a liquid filled flat phantom, with the phantom constructed as outlined in the fore mentioned standards.

4.2 MECHANICAL REQUIREMENTS

The IEEE Std. 1528 and CEI/IEC 62209 standards specify the mechanical components and dimensions of the validation dipoles, with the dimensions frequency and phantom shell thickness dependent. The COMOSAR test bench employs a 2 mm phantom shell thickness therefore the dipoles sold for use with the COMOSAR test bench comply with the requirements set forth for a 2 mm phantom shell thickness.

5 MEASUREMENT UNCERTAINTY

All uncertainties listed below represent an expanded uncertainty expressed at approximately the 95% confidence level using a coverage factor of k=2, traceable to the Internationally Accepted Guides to Measurement Uncertainty.

5.1 RETURN LOSS

The following uncertainties apply to the return loss measurement:

Frequency band	Expanded Uncertainty on Return Loss
400-6000MHz	0.1 dB

5.2 DIMENSION MEASUREMENT

The following uncertainties apply to the dimension measurements:

Length (mm)	Expanded Uncertainty on Length
3 - 300	0.05 mm

5.3 VALIDATION MEASUREMENT

The guidelines outlined in the IEEE 1528, OET 65 Bulletin C, CENELEC EN50361 and CEI/IEC 62209 standards were followed to generate the measurement uncertainty for validation measurements.

Scan Volume	Expanded Uncertainty
1 g	16.19 %
10 g	15.86 %



SAR REFERENCE DIPOLE CALIBRATION REPORT

Ref: ACR.158.7.11.SATU.A

6 CALIBRATION MEASUREMENT RESULTS

6.1 RETURN LOSS

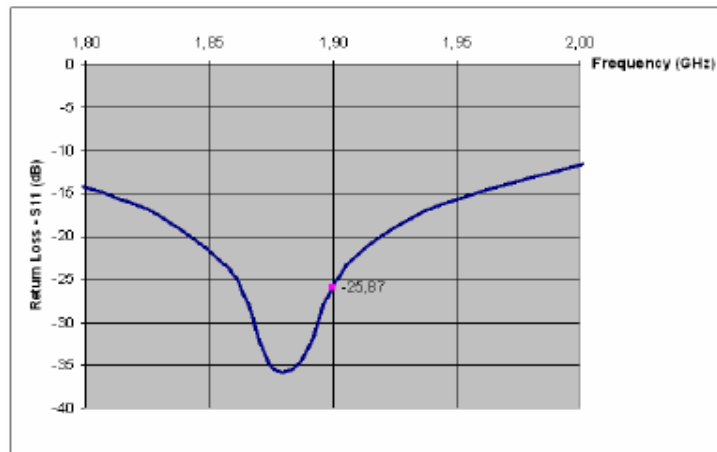

Frequency (MHz)	Return Loss (dB)	Requirement (dB)
1900	-25.9	-20

6.2 MECHANICAL DIMENSIONS

Frequency MHz	L mm		h mm		d mm	
	required	measured	required	measured	required	measured
300	420.0 ±1 %.		250.0 ±1 %.		6.35 ±1 %.	
450	290.0 ±1 %.		166.7 ±1 %.		6.35 ±1 %.	
750	176.0 ±1 %.		100.0 ±1 %.		6.35 ±1 %.	
835	161.0 ±1 %.		89.8 ±1 %.		3.6 ±1 %.	
900	149.0 ±1 %.		83.3 ±1 %.		3.6 ±1 %.	
1450	89.1 ±1 %.		51.7 ±1 %.		3.6 ±1 %.	
1500	80.5 ±1 %.		50.0 ±1 %.		3.6 ±1 %.	
1640	79.0 ±1 %.		45.7 ±1 %.		3.6 ±1 %.	
1750	75.2 ±1 %.		42.9 ±1 %.		3.6 ±1 %.	
1800	72.0 ±1 %.		41.7 ±1 %.		3.6 ±1 %.	
1900	68.0 ±1 %.	PASS	39.5 ±1 %.	PASS	3.6 ±1 %.	PASS
1950	66.3 ±1 %.		38.5 ±1 %.		3.6 ±1 %.	
2000	64.5 ±1 %.		37.5 ±1 %.		3.6 ±1 %.	
2100	61.0 ±1 %.		35.7 ±1 %.		3.6 ±1 %.	
2300	55.5 ±1 %.		32.6 ±1 %.		3.6 ±1 %.	
2450	51.5 ±1 %.		30.4 ±1 %.		3.6 ±1 %.	
2600	48.5 ±1 %.		28.8 ±1 %.		3.6 ±1 %.	
3000	41.5 ±1 %.		25.0 ±1 %.		3.6 ±1 %.	
3500	37.0±1 %.		26.4 ±1 %.		3.6 ±1 %.	
3700	34.7±1 %.		26.4 ±1 %.		3.6 ±1 %.	



7 VALIDATION MEASUREMENT

The IEEE Std. 1528, OET 65 Bulletin C and CEI/IEC 62209 standards state that the system validation measurements must be performed using a reference dipole meeting the fore mentioned return loss and mechanical dimension requirements. The validation measurement must be performed against a liquid filled flat phantom, with the phantom constructed as outlined in the fore mentioned standards. Per the standards, the dipole shall be positioned below the bottom of the phantom, with the dipole length centered and parallel to the longest dimension of the flat phantom, with the top surface of the dipole at the described distance from the bottom surface of the phantom.

7.1 MEASUREMENT CONDITION

Software	OPENSAR V4
Phantom	SN 20/09 SAM71
Probe	SN 18/11 EPG122
Liquid	Head Liquid Values: eps' : 38.5 sigma : 1.42
Distance between dipole center and liquid	10.0 mm
Area scan resolution	dx=8mm/dy=8mm
Zoon Scan Resolution	dx=8mm/dy=8m/dz=5mm
Frequency	1900 MHz
Input power	20 dBm
Liquid Temperature	21 °C
Lab Temperature	21 °C
Lab Humidity	45 %

7.2 HEAD LIQUID MEASUREMENT

Frequency MHz	Relative permittivity (ϵ_r')		Conductivity (σ) S/m	
	required	measured	required	measured
300	45.3 ±5 %		0.87 ±5 %	
450	43.5 ±5 %		0.87 ±5 %	
750	41.9 ±5 %		0.89 ±5 %	
835	41.5 ±5 %		0.90 ±5 %	
900	41.5 ±5 %		0.97 ±5 %	
1450	40.5 ±5 %		1.20 ±5 %	
1500	40.4 ±5 %		1.23 ±5 %	
1640	40.2 ±5 %		1.31 ±5 %	
1750	40.1 ±5 %		1.37 ±5 %	
1800	40.0 ±5 %		1.40 ±5 %	
1900	40.0 ±5 %	PASS	1.40 ±5 %	PASS
1950	40.0 ±5 %		1.40 ±5 %	
2000	40.0 ±5 %		1.40 ±5 %	
2100	39.8 ±5 %		1.49 ±5 %	
2300	39.5 ±5 %		1.67 ±5 %	
2450	39.2 ±5 %		1.80 ±5 %	
2600	39.0 ±5 %		1.96 ±5 %	
3000	38.5 ±5 %		2.40 ±5 %	
3500	37.9 ±5 %		2.91 ±5 %	



SAR REFERENCE DIPOLE CALIBRATION REPORT

Ref: ACR.158.7.11.SATU.A

7.3 MEASUREMENT RESULT

The IEEE Std. 1528 and CEI/IEC 62209 standards state that the system validation measurements should produce the SAR values shown below (for phantom thickness of 2 mm), within the uncertainty for the system validation. All SAR values are normalized to 1 W forward power. In bracket, the measured SAR is given with the used input power.

Frequency MHz	1 g SAR (W/kg/W)		10 g SAR (W/kg/W)	
	required	measured	required	measured
300	2.85		1.94	
450	4.58		3.06	
750	8.49		5.55	
835	9.56		6.22	
900	10.9		6.99	
1450	29		16	
1500	30.5		16.8	
1640	34.2		18.4	
1750	36.4		19.3	
1800	38.4		20.1	
1900	39.7	39.92 (3.99)	20.5	20.49 (2.05)
1950	40.5		20.9	
2000	41.1		21.1	
2100	43.6		21.9	
2300	48.7		23.3	
2450	52.4		24	
2600	55.3		24.6	
3000	63.8		25.7	
3500	67.1		25	

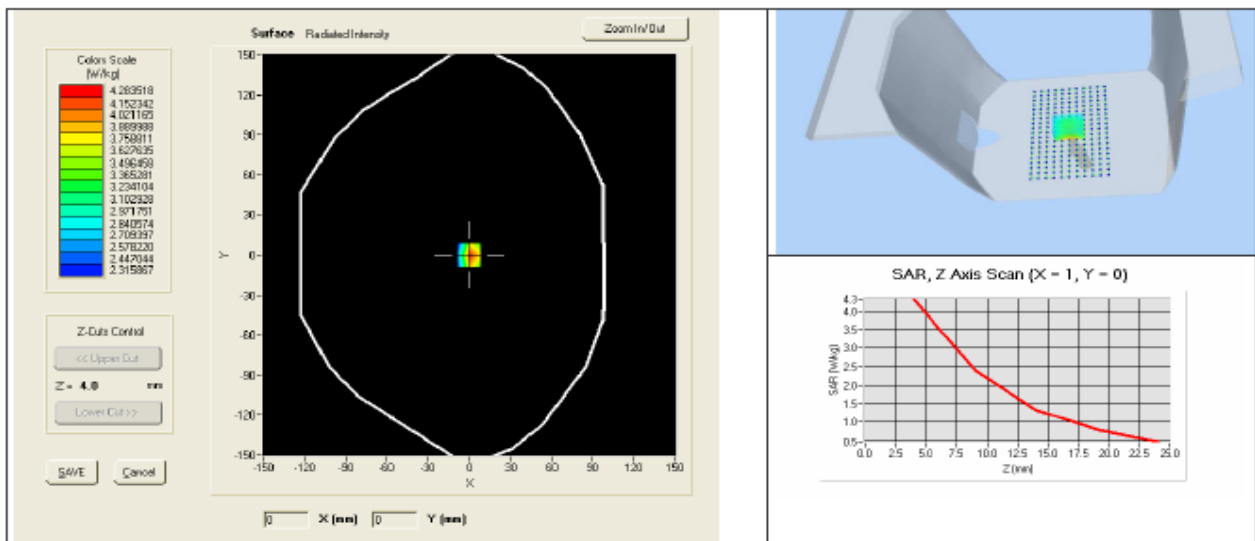



8 LIST OF EQUIPMENT

Equipment Summary Sheet				
Equipment Description	Manufacturer / Model	Identification No.	Current Calibration Date	Next Calibration Date
Flat Phantom	Satimo	SN-20/09-SAM71	Validated. No cal required.	Validated. No cal required.
COMOSAR Test Bench	Version 3	NA	Validated. No cal required.	Validated. No cal required.
Network Analyzer	Rhode & Schwarz ZVA	SN100132	02/2010	02/2013
Calipers	Carrera	CALIPER-01	12/2010	12/2013
Reference Probe	Satimo	EPG122 SN 18/11	Characterized prior to test. No cal required.	Characterized prior to test. No cal required.
Multimeter	Keithley 2000	1188656	11/2010	11/2013
Signal Generator	Agilent E4438C	MY49070581	12/2010	12/2013
Amplifier	Aethercomm	SN 046	Characterized prior to test. No cal required.	Characterized prior to test. No cal required.
Power Meter	HP E4418A	US38261498	11/2010	11/2013
Power Sensor	HP ECP-E26A	US37181460	11/2010	11/2013
Directional Coupler	Narda 4216-20	01386	Characterized prior to test. No cal required.	Characterized prior to test. No cal required.
Temperature and Humidity Sensor	Control Company	11-661-9	3/2010	3/2012