

FCC Test Report (PART 22)

Report No.: RF160314E01-3

FCC ID: G95TCA300

Test Model: TCA300COM

Received Date: Mar. 14, 2016

Test Date: Apr. 18 to 25, 2016

Issued Date: May 23, 2016

Applicant: Technicolor Connected Home USA LLC

Address: 101 West 103rd Street, Indianapolis, IN 46290 United States

Issued By: Bureau Veritas Consumer Products Services (H.K.) Ltd., Taoyuan Branch
Hsin Chu Laboratory

Lab Address: E-2, No.1, Li Hsin 1st Road, Hsinchu Science Park, Hsinchu City 300,
Taiwan R.O.C.

Test Location (1): E-2, No.1, Li Hsin 1st Road, Hsinchu Science Park, Hsinchu City 300,
Taiwan R.O.C.

Test Location (2): No. 49, Ln. 206, Wende Rd., Shangshan Tsuen, Chiung Lin Hsiang, Hsin
Chu Hsien 307, Taiwan R.O.C.



This report is for your exclusive use. Any copying or replication of this report to or for any other person or entity, or use of our name or trademark, is permitted only with our prior written permission. This report sets forth our findings solely with respect to the test samples identified herein. The results set forth in this report are not indicative or representative of the quality or characteristics of the lot from which a test sample was taken or any similar or identical product unless specifically and expressly noted. Our report includes all of the tests requested by you and the results thereof based upon the information that you provided to us. You have 60 days from date of issuance of this report to notify us of any material error or omission caused by our negligence, provided, however, that such notice shall be in writing and shall specifically address the issue you wish to raise. A failure to raise such issue within the prescribed time shall constitute your unqualified acceptance of the completeness of this report, the tests conducted and the correctness of the report contents. Unless specific mention, the uncertainty of measurement has been explicitly taken into account to declare the compliance or non-compliance to the specification. The report must not be used by the client to claim product certification, approval, or endorsement by TAF or any government agencies

Table of Contents

Release Control Record	3
1 Certificate of Conformity	4
2 Summary of Test Results	5
2.1 Measurement Uncertainty.....	5
2.2 Test Site and Instruments.....	6
3 General Information	8
3.1 General Description of EUT.....	8
3.2 Configuration of System under Test.....	10
3.2.1 Description of Support Units.....	11
3.3 Test Mode Applicability and Tested Channel Detail.....	12
3.4 EUT Operating Conditions.....	12
3.5 General Description of Applied Standards.....	13
4 Test Types and Results	14
4.1 Output Power Measurement.....	14
4.1.1 Limits of Output Power Measurement.....	14
4.1.2 Test Procedures.....	14
4.1.3 Test Setup.....	15
4.1.4 Test Results.....	16
4.2 Frequency Stability Measurement.....	17
4.2.1 Limits of Frequency Stability Measurement.....	17
4.2.2 Test Procedure.....	17
4.2.3 Test Setup.....	18
4.2.4 Test Results.....	19
4.3 Occupied Bandwidth Measurement.....	20
4.3.1 Test Procedure.....	20
4.3.2 Test Setup.....	20
4.3.3 Test Result.....	21
4.4 Band Edge Measurement.....	22
4.4.1 Limits of Band Edge Measurement.....	22
4.4.2 Test Setup.....	22
4.4.3 Test Procedures.....	22
4.4.4 Test Results.....	23
4.5 Peak to Average Ratio.....	26
4.5.1 Limits of Peak to Average Ratio Measurement.....	26
4.5.2 Test Setup.....	26
4.5.3 Test Procedures.....	26
4.5.4 Test Results.....	27
4.6 Conducted Spurious Emissions.....	28
4.6.1 Limits of Conducted Spurious Emissions Measurement.....	28
4.6.2 Test Setup.....	28
4.6.3 Test Procedure.....	28
4.6.4 Test Results.....	29
4.7 Radiated Emission Measurement.....	30
4.7.1 Limits of Radiated Emission Measurement.....	30
4.7.2 Test Procedure.....	30
4.7.3 Deviation from Test Standard.....	30
4.7.4 Test Setup.....	31
4.7.5 Test Results.....	32
5 Pictures of Test Arrangements	38
Appendix – Information on the Testing Laboratories	39



A D T

Release Control Record

Issue No.	Description	Date Issued
RF160314E01-3	Original release.	May 23, 2016

1 Certificate of Conformity

Product: Integrated Device

Brand: Technicolor

Test Model: TCA300COM

Sample Status: ENGINEERING SAMPLE

Applicant: Technicolor Connected Home USA LLC

Test Date: Apr. 18 to 25, 2016

Standards: FCC Part 22, Subpart H

The above equipment has been tested by **Bureau Veritas Consumer Products Services (H.K.) Ltd., Taoyuan Branch**, and found compliance with the requirement of the above standards. The test record, data evaluation & Equipment Under Test (EUT) configurations represented herein are true and accurate accounts of the measurements of the sample's EMC characteristics under the conditions specified in this report.

Prepared by :  _____, **Date:** _____ May 23, 2016
Claire Kuan / Specialist

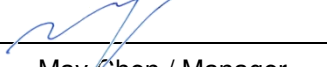
Approved by :  _____, **Date:** _____ May 23, 2016
May Chen / Manager

2 Summary of Test Results

Applied Standard: FCC Part 22 & Part 2			
FCC Clause	Test Item	Result	Remarks
2.1046 22.913 (a)	Effective Radiated Power	PASS	Meet the requirement of limit.
---	Peak To Average Ratio	PASS	Meet the requirement of limit.
2.1055 22.355	Frequency Stability	PASS	Meet the requirement of limit.
2.1049	Occupied Bandwidth	PASS	Meet the requirement of limit.
22.917	Band Edge Measurements	PASS	Meet the requirement of limit.
2.1051 22.917	Conducted Spurious Emissions	PASS	Meet the requirement of limit.
2.1053 22.917	Radiated Spurious Emissions	PASS	Meet the requirement of limit. Minimum passing margin is -21.42dB at 33.4MHz.

2.1 Measurement Uncertainty

Where relevant, the following measurement uncertainty levels have been estimated for tests performed on the EUT as specified in CISPR 16-4-2:

Measurement	Frequency	Expanded Uncertainty (k=2) (±)
Radiated Emissions up to 1 GHz	30MHz ~ 1GHz	5.31 dB
Radiated Emissions above 1 GHz	1GHz ~ 6GHz	3.40 dB
	6GHz ~ 18GHz	3.73 dB
	18GHz ~ 40GHz	4.11 dB



2.2 Test Site and Instruments

For Effective Radiated Power & Radiated Spurious Emissions test:

DESCRIPTION & MANUFACTURER	MODEL NO.	SERIAL NO.	CALIBRATED DATE	CALIBRATED UNTIL
Test Receiver Agilent	N9038A	MY50010156	Aug. 12, 2015	Aug. 11, 2016
Pre-Amplifier Mini-Circuits	ZFL-1000VH2 B	AMP-ZFL-07	May 08, 2015	May 07, 2016
Trilog Broadband Antenna SCHWARZBECK	VULB 9168	9168-156	Jan. 04, 2016	Jan. 03, 2017
RF Cable	8D	966-3-1 966-3-2 966-3-3	Apr. 02, 2016	Apr. 01, 2017
Horn_Antenna SCHWARZBECK	BBHA9120-D	9120D-406	Jan. 20, 2016	Jan. 19, 2017
Pre-Amplifier Agilent	8449B	3008A02465	Apr. 05, 2016	Apr. 04, 2017
RF Cable	EMC104-SM- SM-2000 EMC104-SM- SM-5000 EMC104-SM- SM-5000	150317 150321 150322	Mar. 30, 2016	Mar. 29, 2017
Spectrum Analyzer Keysight	N9030A	MY54490520	July 26, 2015	July 25, 2016
Pre-Amplifier EMCI	EMC184045	980143	Jan. 15, 2016	Jan. 14, 2017
Horn_Antenna SCHWARZBECK	BBHA 9170	BBHA9170608	Jan. 08, 2016	Jan. 07, 2017
RF Cable	SUCOFLEX 102	36432/2 36441/2	Jan. 16, 2016	Jan. 15, 2017
Software	ADT_Radiated _V8.7.07	NA	NA	NA
Antenna Tower & Turn Table CT	MF-7802	MF780208406	NA	NA
Boresight Antenna Fixture	FBA-01	FBA-SIP01	NA	NA
Communication Simulator R&S	CMU200	121040	Dec. 25, 2015	Dec. 24, 2016

Note:

1. The calibration interval of the above test instruments is 12 months and the calibrations are traceable to NML/ROC and NIST/USA.
2. The test was performed in 966 Chamber No. 3.
3. The FCC Site Registration No. is 147459
4. The CANADA Site Registration No. is 20331-1
5. Tested Date: Apr. 18, 2016

For other test items:

DESCRIPTION & MANUFACTURER	MODEL NO.	SERIAL NO.	CALIBRATED DATE	CALIBRATED UNTIL
SPECTRUM ANALYZER R&S	FSP 40	100060	May 08, 2015	May 07, 2016
SPECTRUM ANALYZER R&S	FSV 40	100964	June 26, 2015	June 25, 2016
Spectrum Analyzer Agilent	E4446A	MY48250253	Dec. 22, 2015	Dec. 21, 2016
Power meter Anritsu	ML2495A	1014008	Apr. 28, 2015	Apr. 27, 2016
Power sensor Anritsu	MA2411B	0917122	Apr. 28, 2015	Apr. 27, 2016
AC Power Source EXTECH Electronics	6205	1440452	NA	NA
Temperature & Humidity Chamber GIANTFORCE	GTH-150-40-SP-AR	MAA0812-008	Jan. 15, 2016	Jan. 14, 2017
DC Power Supply Topward	6603D	795558	NA	NA
ESG Vector signal generator Agilent	E4438C	MY45094468/0 05 506 602 UK6 UNJ	Dec. 01, 2015	Nov. 30, 2016
MSP4TA-18+ MECH SWITCH ABSORPTIVE / SMA Mini-Circuits	MSP4TA-18+	0140	Mar. 19, 2016	Mar. 18, 2017
FXD ATTEN/SMA/3dB 2W Mini-Circuits	BW-S3W2+	MN71981	Mar. 19, 2016	Mar. 18, 2017
Software	ADT_RF Test Software V6.6.5.3	NA	NA	NA
Band Reject Filter	WRCGV824/849-810/863-60/8SS	4	June 23, 2015	June 22, 2016
Communication Simulator R&S	CMU200	121040	Dec. 25, 2015	Dec. 24, 2016

- NOTE:**
1. The test was performed in Oven room 2.
 2. The calibration interval of the above test instruments is 12 months and the calibrations are traceable to NML/ROC and NIST/USA.
 3. Tested Date: Apr. 25, 2016

3 General Information

3.1 General Description of EUT

Product	Integrated Device	
Brand	Technicolor	
Test Model	TCA300COM	
IMEI Code	35999804	
HW Version	FGR	
Status of EUT	ENGINEERING SAMPLE	
Power Supply Rating	12Vdc from power adapter or 4Vdc from battery	
Modulation Type	WCDMA, HSDPA, HSUPA	BPSK
Operating Frequency	WCDMA, HSDPA, HSUPA	826.4MHz ~ 846.6MHz
Max. ERP Power	WCDMA	370.68mW
Emission Designator	WCDMA	4M17F9W
	HSDPA	4M18F9W
	HSUPA	4M18F9W
Antenna Type	Please see NOTE	
Antenna Connector	Please see NOTE	
Accessory Device	Adapter x1 Battery x1	
Data Cable Supplied	NA	

Note:

1. There are WLAN, Bluetooth, Zigbee and WWAN(3G) technology used for the EUT.
2. The EUT power needs to be supplied from one power adapter or battery, the information is as below table:

Adapter		
Brand	Model	Spec.
XHPSU-TC	37469780	Input: 100-120Vac, 50/60Hz, 0.7A Output: 12V, 1.5A DC output cable (Unshielded, 3m)
Battery		
Brand	Model	Spec.
Li-polymer	U46P313.00	4V, 2520mAh, 10.08Wh

The EUT was pre-tested with Adapter & Battery, the worst case was found in Adapter. Therefore only the test data of the Adapter was recorded in this report.

3. The antennas provided to the EUT, please refer to the following table:

Antenna NO.	Brand	Antenna Gain(dBi) (Including cable loss)	Frequency range (GHz)	Antenna Type	Connecter Type
Zigbee 1	INPAQ	2.84	2.4~2.4835GHz	PCB	i-pex(MHF)
Zigbee 2	INPAQ	3.1	2.4~2.4835GHz	PCB	i-pex(MHF)
WiFi 1 & BT	INPAQ	2.06	2.4~2.4835GHz	PCB	Pogo pin
		3.13	5.15~5.25GHz		
		3.79	5.25~5.35GHz		
		3.9	5.47~5.725GHz		
		2.39	5.725~5.85GHz		
WiFi 2	INPAQ	0.73	2.4~2.4835GHz	PCB	i-pex(MHF)
		2.86	5.15~5.25GHz		
		3.02	5.25~5.35GHz		
		3.33	5.47~5.725GHz		
		3.84	5.725~5.85GHz		
WWAN	INPAQ	2.56	824~849MHz	PCB	Pogo pin
		3.72	1850~1960MHz		

4. The above EUT information is declared by manufacturer and for more detailed features description, please refer to the manufacturer's specifications or User's Manual.

3.2 Configuration of System under Test

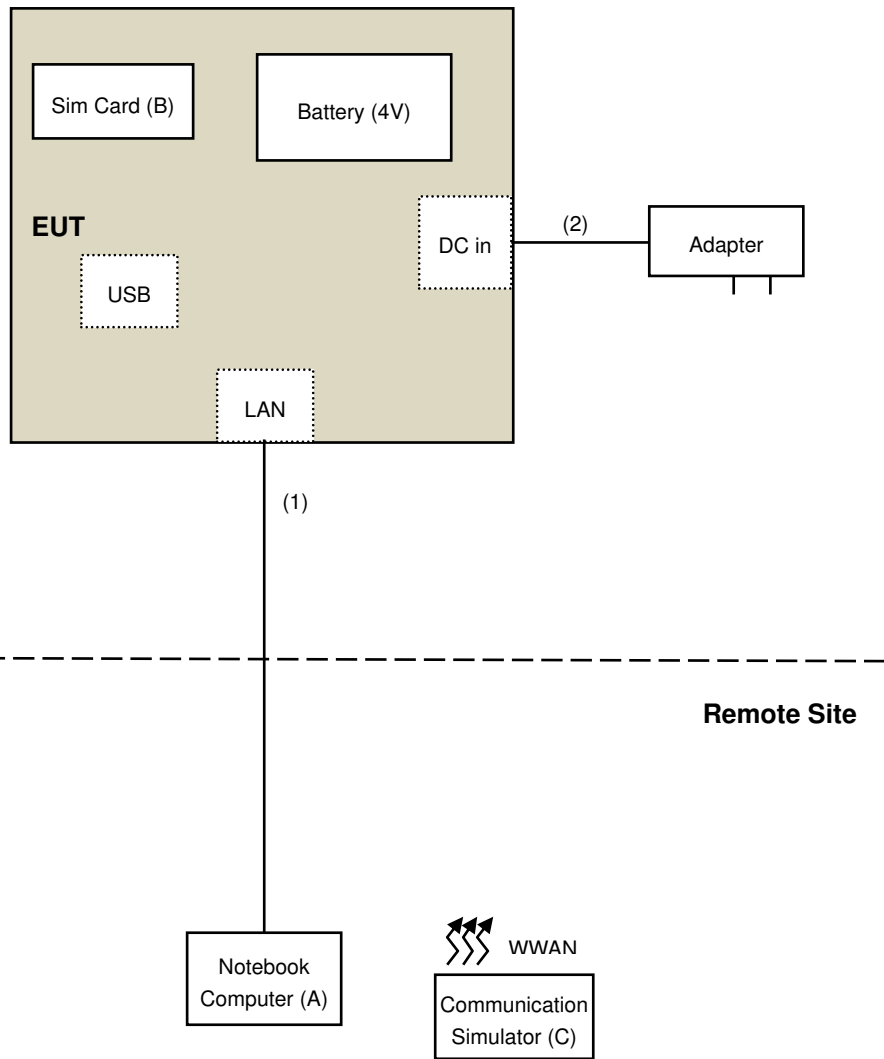

3.2.1 Description of Support Units

The EUT has been tested as an independent unit together with other necessary accessories or support units. The following support units or accessories were used to form a representative test configuration during the tests.

No.	Product	Brand	Model No.	Serial No.	FCC ID	Remark
A	Notebook Computer	DELL	E5430	HYV4VY1	FCC DoC	Provided by Lab
B	Sim Card	R&S	CRT-Z3	NA	NA	Provided by Lab
C	Communication Simulator	R&S	CMU200	121040	NA	Provided by Lab

NOTE:

1. All power cords of the above support units are non-shielded (1.8 m).

No.	Cable	Qty.	Length (m)	Shielded (Yes/ No)	Cores (Number)	Remark
1	RJ-45	1	10	No	0	Provided by Lab
2	DC	1	3	No	0	Supplied by client

3.3 Test Mode Applicability and Tested Channel Detail

Pre-Scan has been conducted to determine the worst-case mode from all possible combinations between available modulations, data rates, XYZ axis and antenna ports

The worst case was found when positioned on Y-plane. Following channel(s) was (were) selected for the final test as listed below:

WCDMA MODE

Test Item	Available Channel	Tested Channel	Mode
ERP	4132 to 4233	4132, 4182, 4233	WCDMA
Frequency Stability	4132 to 4233	4182	WCDMA
Occupied Bandwidth	4132 to 4233	4132, 4182, 4233	WCDMA, HSDPA, HSUPA
Band Edge	4132 to 4233	4132, 4233	WCDMA, HSDPA, HSUPA
Peak To Average Ratio	4132 to 4233	4132, 4182, 4233	WCDMA
Conducted Emission	4132 to 4233	4182	WCDMA
Radiated Emission Below 1GHz	4132 to 4233	4132, 4182, 4233	WCDMA
Radiated Emission Above 1GHz	4132 to 4233	4132, 4182, 4233	WCDMA

Test Condition:

Test Item	Environmental Conditions	Input Power	Tested By
ERP	25deg. C, 63%RH	120Vac, 60Hz	Robert Cheng
Frequency Stability	25deg. C, 63%RH	120Vac, 60Hz	Robert Cheng
Occupied Bandwidth	25deg. C, 63%RH	120Vac, 60Hz	Robert Cheng
Band Edge	25deg. C, 63%RH	120Vac, 60Hz	Robert Cheng
Peak To Average Ratio	24deg. C, 64%RH	120Vac, 60Hz	Robert Cheng
Conducted Emission	25deg. C, 63%RH	120Vac, 60Hz	Robert Cheng
Radiated Emission Below 1GHz	25deg. C, 68%RH	120Vac, 60Hz	Andy Ho
Radiated Emission Above 1GHz	25deg. C, 68%RH	120Vac, 60Hz	Andy Ho

3.4 EUT Operating Conditions

The EUT makes a call to the communication simulator. The communication simulator station system controlled a EUT to export maximum output power under transmission mode and specific channel frequency



3.5 General Description of Applied Standards

The EUT is a RF Product. According to the specifications of the manufacturer, it must comply with the requirements of the following standards:

FCC 47 CFR Part 2

FCC 47 CFR Part 22

KDB 971168 D01 Power Meas License Digital Systems v02r02

ANSI/TIA/EIA-603-D 2010

NOTE: All test items have been performed and recorded as per the above standards.

4 Test Types and Results

4.1 Output Power Measurement

4.1.1 Limits of Output Power Measurement

Mobile / Portable station are limited to 7 watts e.r.p.

4.1.2 Test Procedures

EIRP / ERP Measurement:

- a. All measurements were done at low, middle and high operational frequency range. RBW and VBW is 5MHz for WCDMA mode.
- b. Substitution method is used for EIRP measurement. In the semi-anechoic chamber, EUT placed on the 0.8m height of Turn Table, rotated the table around 360 degrees to search the maximum radiation power and receiver antenna shall be rotated vertical and horizontal polarization and moved height from 1m to 4m to find the maximum polar radiated power. The "Read Value" is the spectrum reading the maximum power value.
- c. The substitution horn antenna is substituted for EUT at the same position and signals generator export the CW signal to the substitution antenna via a TX cable. Rotated the Turn Table and moved receiving antenna to find the maximum radiation power. Adjust output power level of S.G to get a Value of spectrum reading equal to "Read Value" of step b. Record the power level of S.G
- d. $EIRP = \text{Output power level of S.G} - \text{TX cable loss} + \text{Antenna gain of substitution horn}.$
- e. ERP power can be calculated form EIRP power by subtracting the gain of dipole, $ERP \text{ power} = EIPR \text{ power} - 2.15\text{dBi}.$

Conducted Power Measurement:

The EUT was set up for the maximum power with WCDMA link data modulation and link up with simulator. Set the EUT to transmit under low, middle and high channel and record the power level shown on simulator.

4.1.3 Test Setup EIRP / ERP MEASUREMENT:

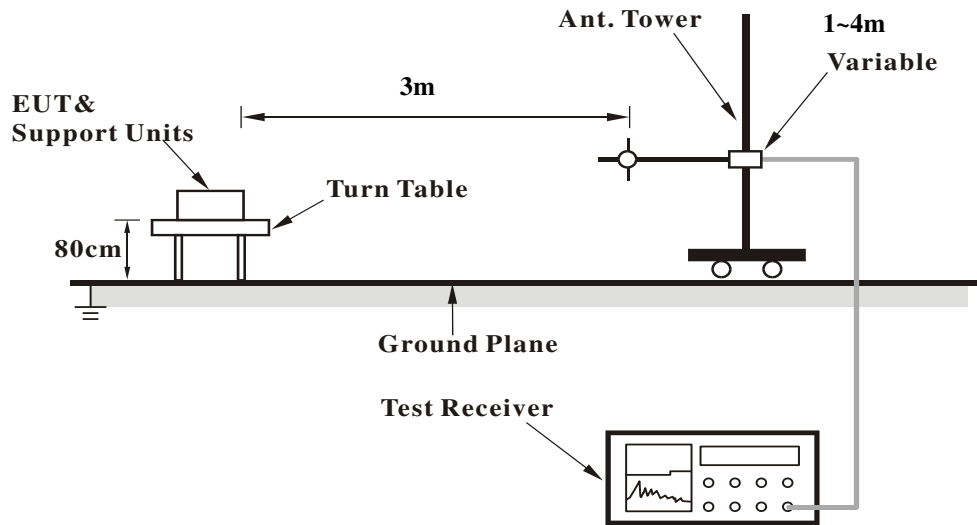

For the actual test configuration, please refer to the attached file (Test Setup Photo).

CONDUCTED POWER MEASUREMENT:

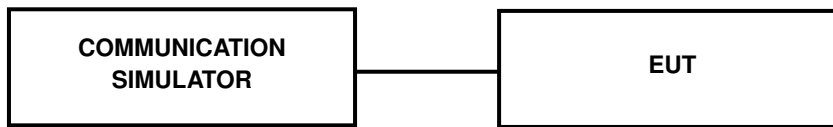

For the actual test configuration, please refer to the attached file (Test Setup Photo).

4.1.4 Test Results

CONDUCTED OUTPUT POWER (dBm)

Band	WCDMA V		
	4132	4182	4233
Channel	826.4	836.4	846.6
Frequency (MHz)	826.4	836.4	846.6
RMC	23.42	22.79	23.24
HSDPA Subtest-1	22.89	22.20	22.90
HSDPA Subtest-2	22.69	22.16	22.77
HSDPA Subtest-3	22.81	22.16	22.93
HSDPA Subtest-4	22.67	22.31	22.55
HSUPA Subtest-1	22.65	22.20	22.79
HSUPA Subtest-2	23.00	22.34	22.58
HSUPA Subtest-3	23.07	22.10	22.93
HSUPA Subtest-4	22.75	22.27	22.62
HSUPA Subtest-5	23.07	22.25	22.87

ERP POWER (dBm)

WCDMA

Channel	Frequency (MHz)	LVL (dBm)	Correction Factor(dB)	ERP(dBm)	ERP(mW)
4132	826.4	22.34	2.78	25.12	325.09
4182	836.4	22.78	2.78	25.56	359.75
4233	846.6	22.88	2.81	25.69	370.68

HSDPA

Channel	Frequency (MHz)	LVL (dBm)	Correction Factor(dB)	ERP(dBm)	ERP(mW)
4132	826.4	22.08	2.78	24.86	306.20
4182	836.4	22.42	2.78	25.20	331.13
4233	846.6	22.66	2.81	25.47	352.37

HSUPA

Channel	Frequency (MHz)	LVL (dBm)	Correction Factor(dB)	ERP(dBm)	ERP(mW)
4132	826.4	22.10	2.78	24.88	307.61
4182	836.4	22.37	2.78	25.15	327.34
4233	846.6	22.52	2.81	25.33	341.19

REMARKS: 1. Output Power (dBm) = SPA Reading (dBm) + Correction Factor (dB).
 2. Correction factor (dB) = Free Space Loss + Antenna Factor + Cable Loss.

4.2 Frequency Stability Measurement

4.2.1 Limits of Frequency Stability Measurement

1.5 ppm is for base and fixed station. 2.5 ppm is for mobile station.

4.2.2 Test Procedure

- a. Device is placed at the oven room. The oven room could control the temperatures and humidity. Power warm up is at least 15 min and power applied should perform before recording frequency error.
- b. EUT is connected the external power supply to control the AC input power. The test voltage range is from minimum to maximum working voltage. Each step shall be record the frequency error rate.
- c. The temperature range step is 10 degrees in this test items. All temperature levels shall be hold the ± 0.5 °C during the measurement testing. The each temperature step shall be at least 0.5 hours, consider the EUT could be test under the stability condition.

NOTE: The frequency error was recorded frequency error from the communication simulator.

4.2.3 Test Setup

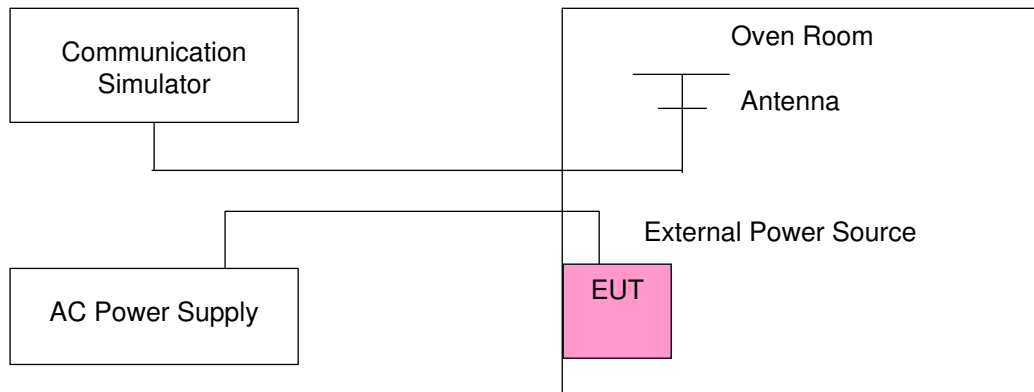

4.2.4 Test Results

Frequency Error vs. Voltage

Voltage (Volts)	Frequency Error (ppm)	Limit (ppm)
	WCDMA	
102	0.012	2.5
138	0.010	2.5

Frequency Error vs. Temperature.

TEMP. (°C)	Frequency Error (ppm)	Limit (ppm)
	WCDMA	
75	0.025	2.5
70	0.024	2.5
60	0.019	2.5
50	0.017	2.5
40	0.012	2.5
30	0.011	2.5
20	0.010	2.5
10	0.013	2.5
0	0.014	2.5
-10	0.016	2.5
-20	0.017	2.5
-30	0.019	2.5

4.3 Occupied Bandwidth Measurement

4.3.1 Test Procedure

The EUT makes a call to the communication simulator. All measurements were done at low, middle and high operational frequency range. The communication simulator station system controlled a EUT to export maximum output power under transmission mode and specific channel frequency. Use OBW measurement function of Spectrum analyzer to measure 99 % occupied bandwidth.

4.3.2 Test Setup

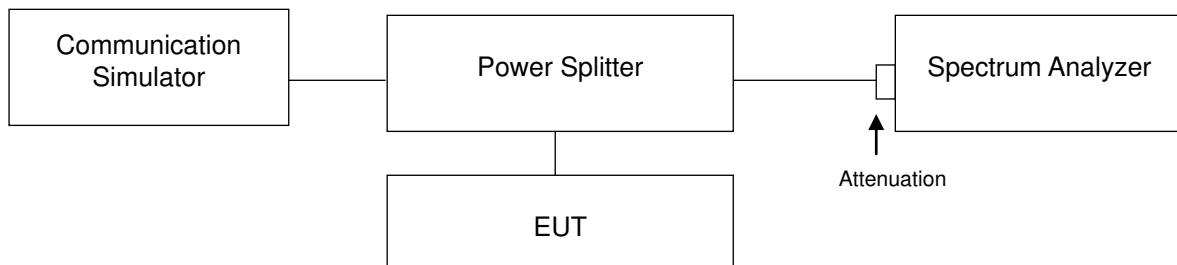

4.3.3 Test Result

Channel	FREQ. (MHz)	99% Occupied Bandwidth (MHz)		
		WCDMA	HSDPA	HSUPA
4132	826.4	4.17	4.18	4.16
4182	836.4	4.17	4.18	4.18
4233	846.6	4.17	4.18	4.18

Spectrum Plot Of Worst Value

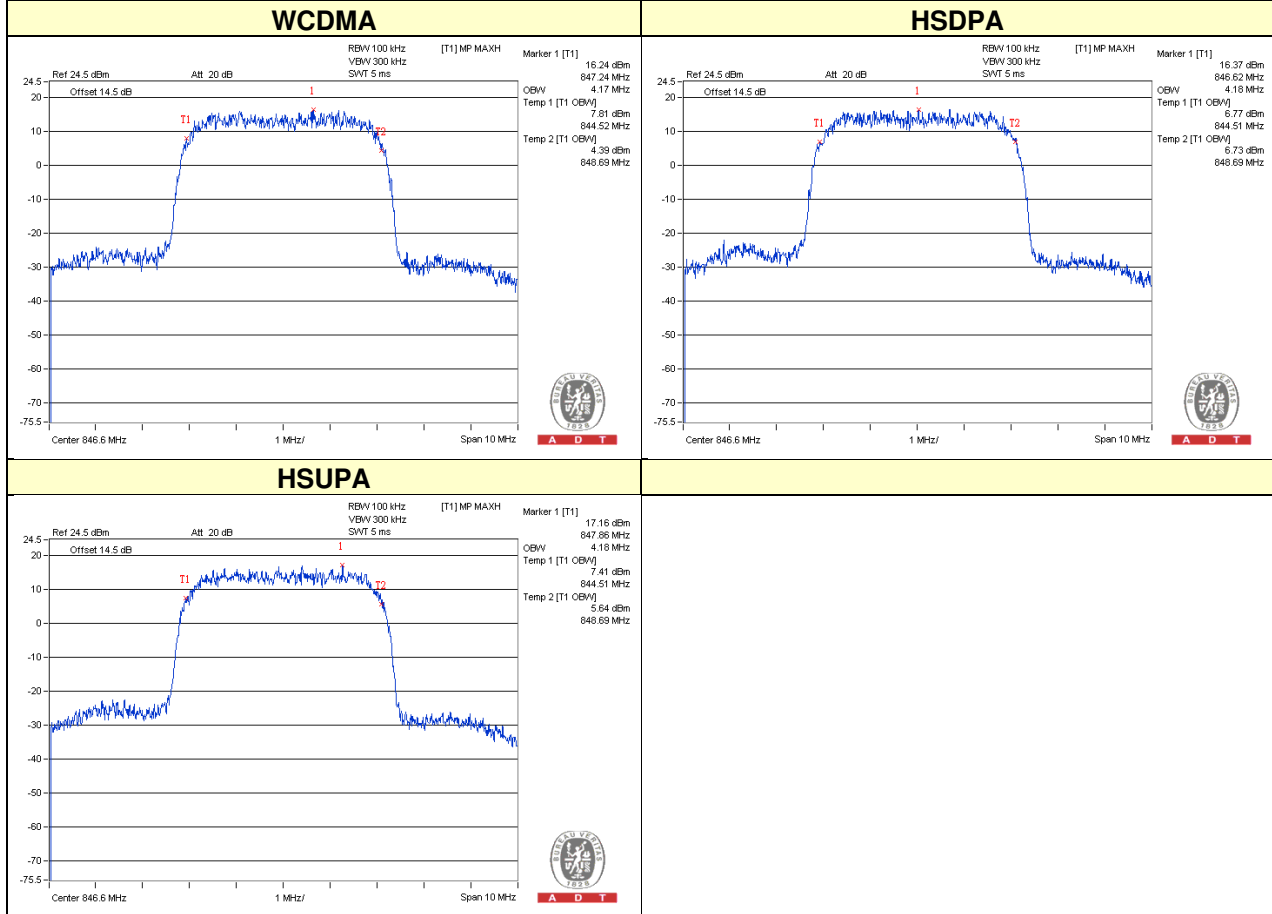

4.4 Band Edge Measurement

4.4.1 Limits of Band Edge Measurement

Power of any emission outside of the authorized operating frequency ranges must be attenuated below the transmitting power (P) by a factor of at least $43 + 10 \log(P)$ dB. In the 1 MHz bands immediately outside and adjacent to the frequency block a resolution bandwidth of at least one percent of the emission bandwidth of the fundamental emission of the transmitter may be employed.

4.4.2 Test Setup

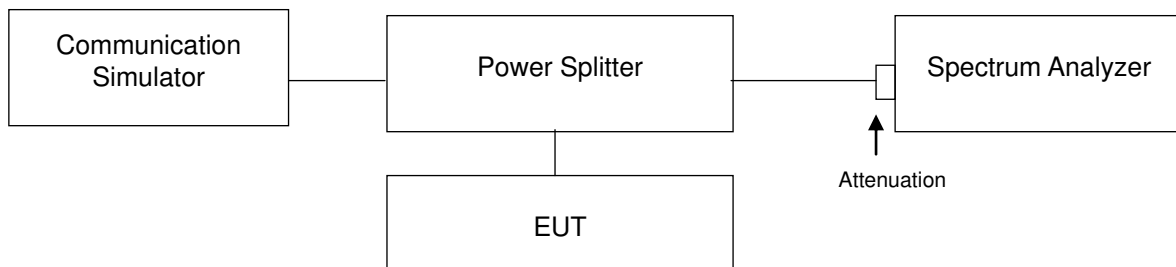

4.4.3 Test Procedures

- All measurements were done at low and high operational frequency range.
- The center frequency of spectrum is the band edge frequency and s RB of the spectrum is $>1\%$ OCCUPIED BANDWIDTH and VB of the spectrum is $\geq 3*RB$.
- Record the max trace plot into the test report.

4.4.4 Test Results

WCDMA				
Frequency(MHz)	Measurement Value	Limit	Margin	Result
826.4	-20.16	-13.00	-7.16	Pass
846.6	-22.85	-13.00	-9.85	Pass

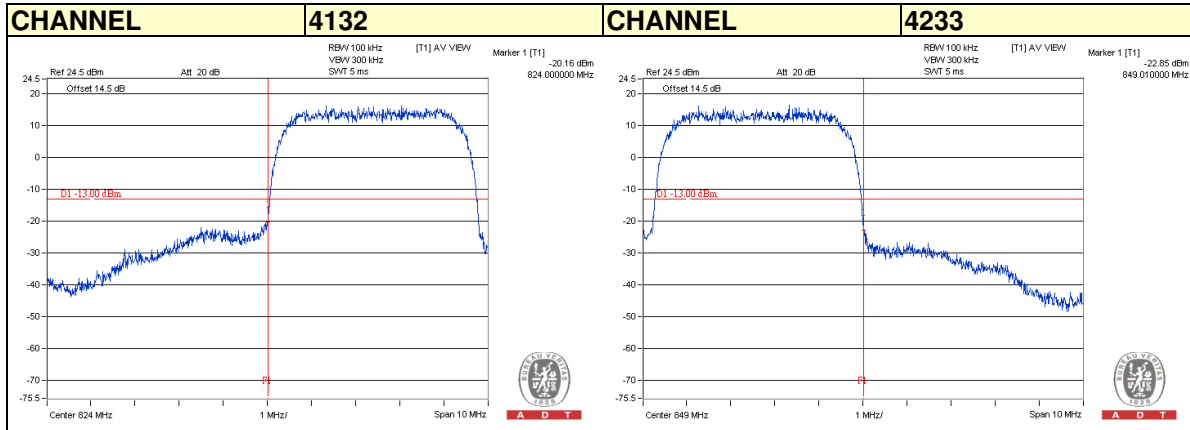

HSDPA

Frequency(MHz)	Measurement Value	Limit	Margin	Result
826.4	-19.84	-13.00	-6.84	Pass
846.6	-20.45	-13.00	-7.45	Pass

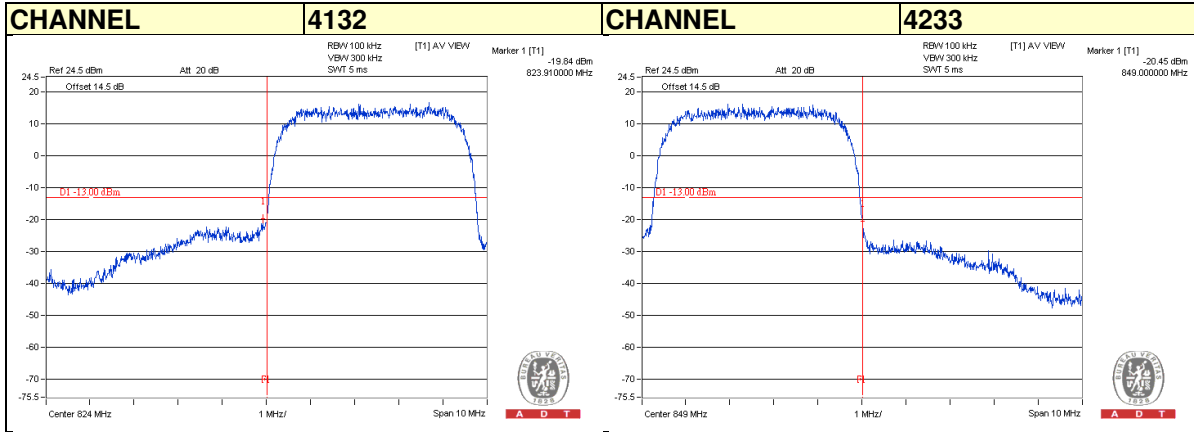

HSUPA				
Frequency(MHz)	Measurement Value	Limit	Margin	Result
826.4	-16.54	-13.00	-3.54	Pass
846.6	-22.39	-13.00	-9.39	Pass

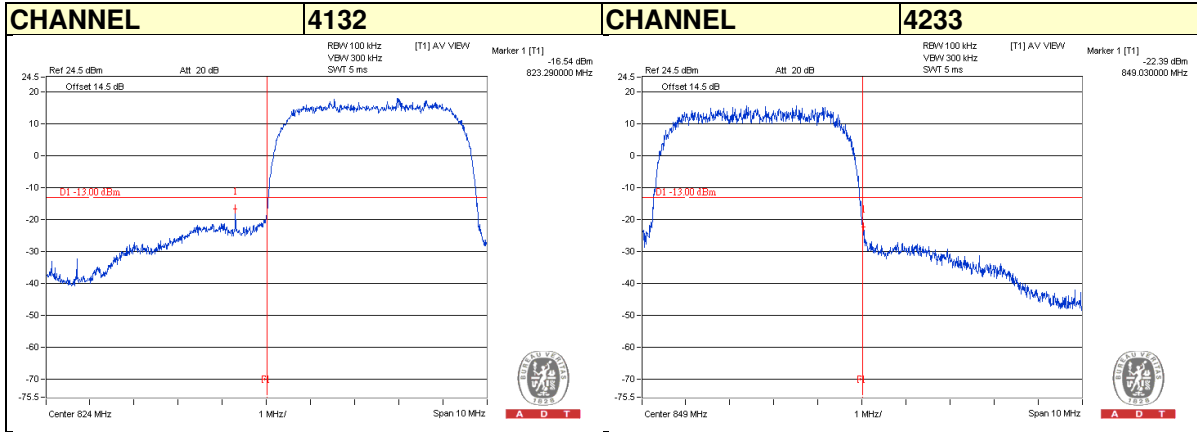

4.5 Peak to Average Ratio

4.5.1 Limits of Peak to Average Ratio Measurement

In measuring transmissions in this band using an average power technique, the peak to-average ratio (PAR) of the transmission may not exceed 13 dB

4.5.2 Test Setup

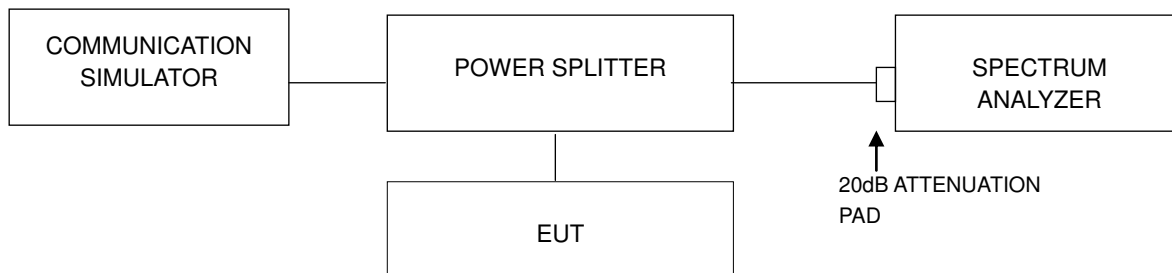

4.5.3 Test Procedures

1. Set resolution/measurement bandwidth \geq signal's occupied bandwidth;
2. Set the number of counts to a value that stabilizes the measured CCDF curve;
3. Record the maximum PAPR level associated with a probability of 0.1%.

4.5.4 Test Results

Channel	Freq. (MHz)	Peak To Average Ratio (dB)
		WCDMA
4132	826.4	3.02
4182	836.4	3.06
4233	846.6	3.05

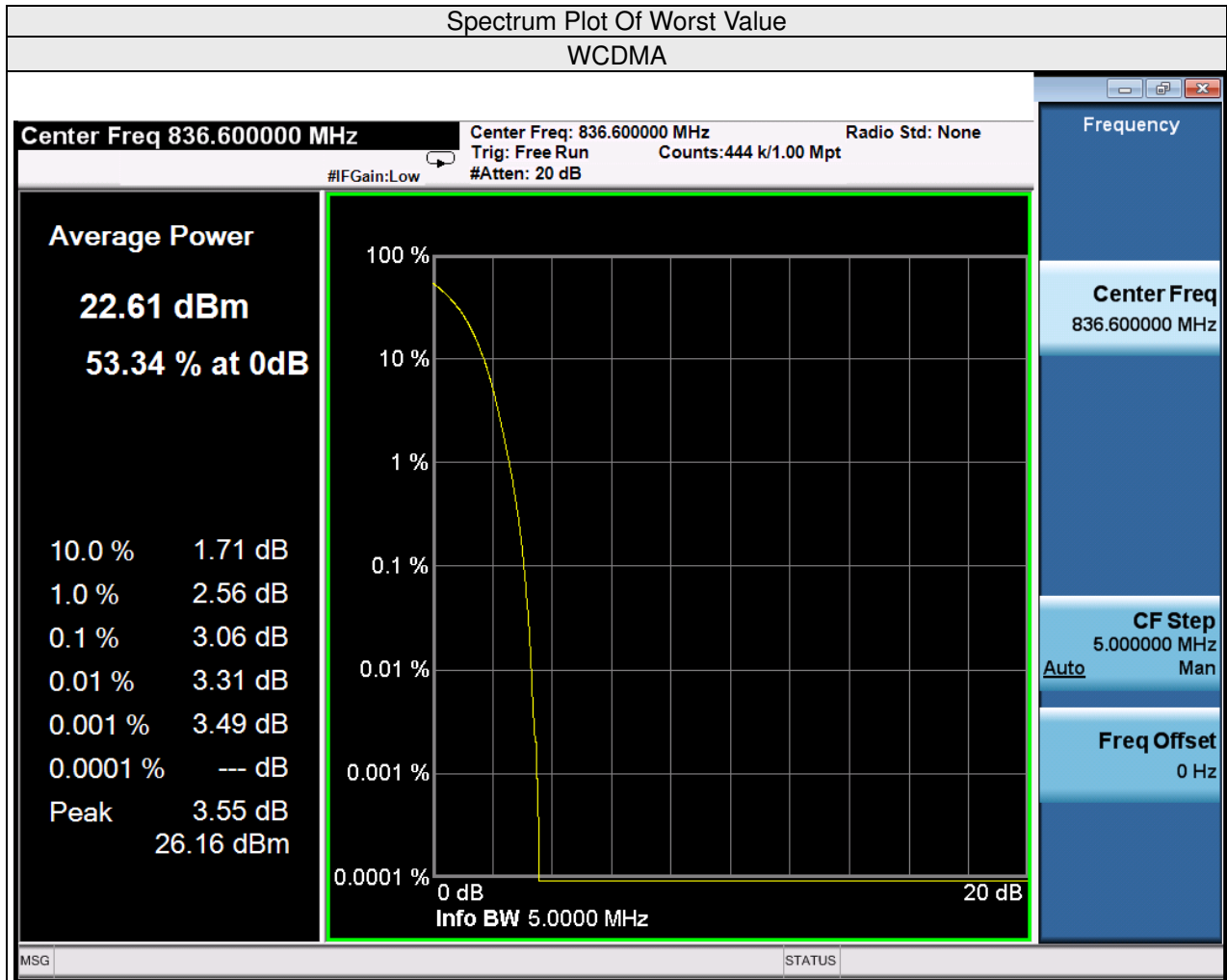

4.6 Conducted Spurious Emissions

4.6.1 Limits of Conducted Spurious Emissions Measurement

The power of any emission outside of the authorized operating frequency ranges must be attenuated below the transmitting power (P) by a factor of at least $43 + 10 \log(P)$ dB. The emission limit equal to -13dBm .

4.6.2 Test Setup

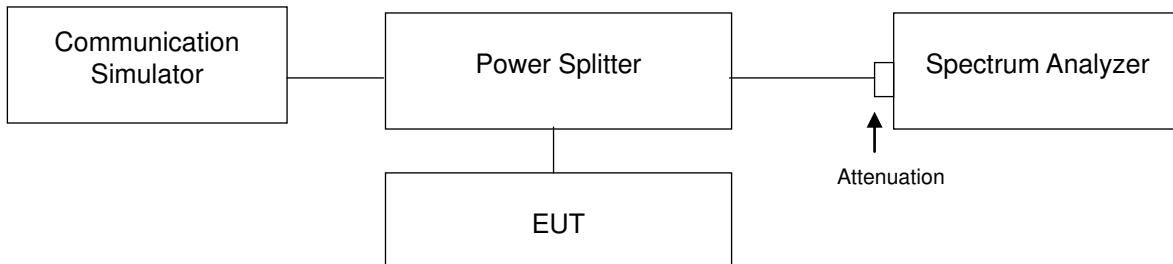

4.6.3 Test Procedure

- The EUT makes a phone call to the communication simulator. All measurements were done at low, middle and high operational frequency range.
- Measuring frequency range is from 9 kHz to 9GHz. 20dB attenuation pad is connected with spectrum. RBW=1MHz and VBW=3MHz is used for conducted emission measurement.

4.6.4 Test Results

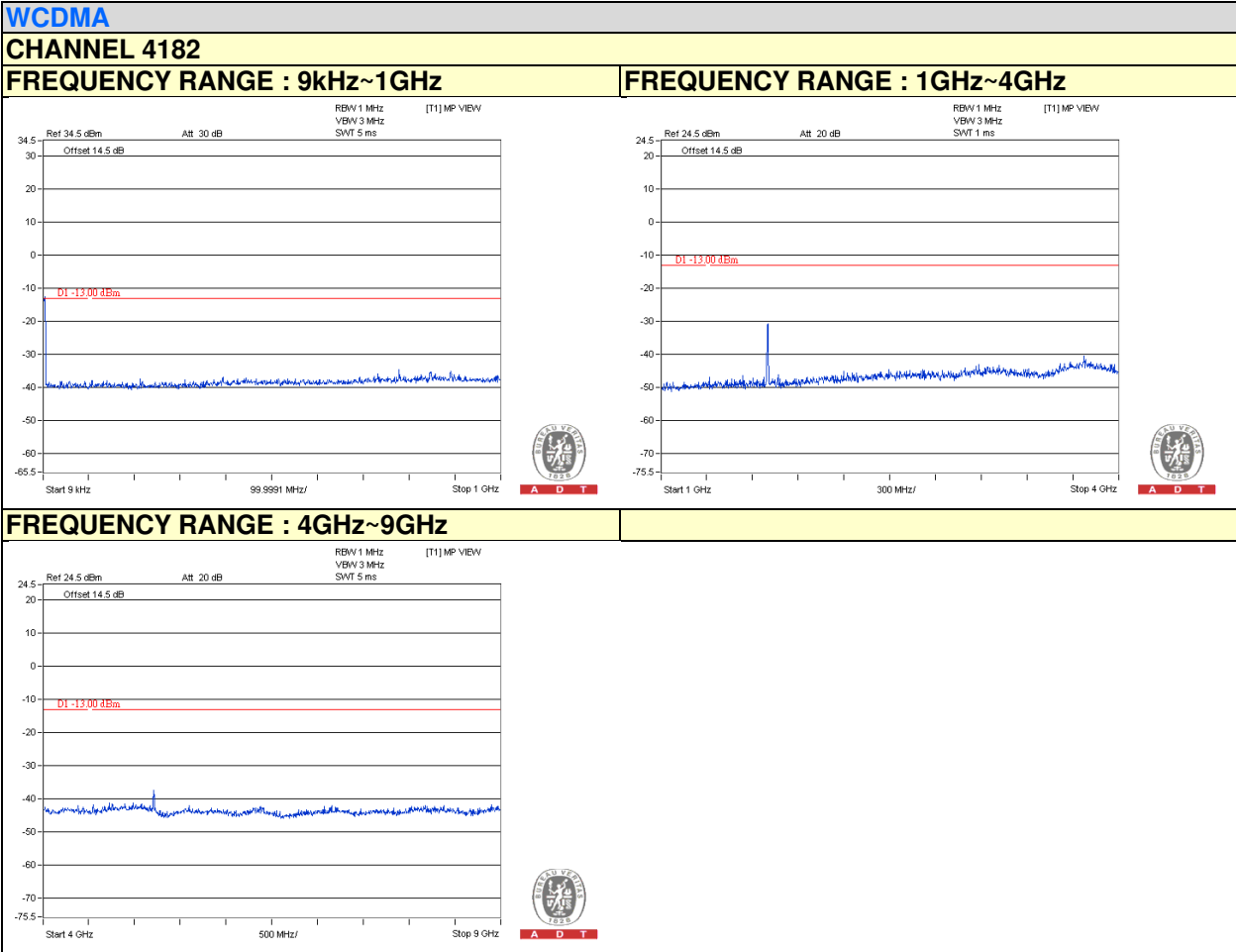

4.7 Radiated Emission Measurement

4.7.1 Limits of Radiated Emission Measurement

The power of any emission outside of the authorized operating frequency ranges must be attenuated below the transmitting power (P) by a factor of at least $43 + 10 \log(P)$ dB. The emission limit equal to -13dBm .

4.7.2 Test Procedure

- a. Substitution method is used for EIRP measurement. In the semi-anechoic chamber, EUT placed on the 0.8m height of Turn Table, rotated the table around 360 degrees to search the maximum radiation power and receiver antenna shall be rotated vertical and horizontal polarization and moved height from 1m to 4m to find the maximum polar radiated power. The "Read Value" is the spectrum reading the maximum power value.
- b. The substitution horn antenna is substituted for EUT at the same position and signals generator export the CW signal to the substitution antenna via a TX cable. Rotated the Turn Table and moved receiving antenna to find the maximum radiation power. Adjust output power level of S.G to get a Value of spectrum reading equal to "Read Value" of step a. Record the power level of S.G
- c. $\text{EIRP} = \text{Output power level of S.G} - \text{TX cable loss} + \text{Antenna gain of substitution horn}$.
- d. ERP power can be calculated form EIRP power by subtracting the gain of dipole, $\text{ERP power} = \text{EIPR power} - 2.15\text{dBi}$.

NOTE: The resolution bandwidth and video bandwidth of test receiver/spectrum analyzer is 1MHz/3MHz.

4.7.3 Deviation from Test Standard

No deviation.

4.7.4 Test Setup

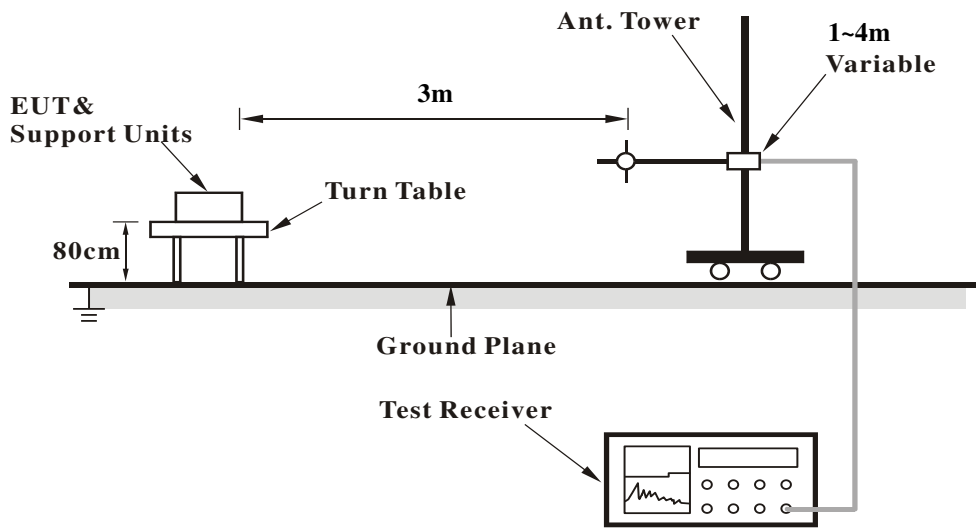

For the actual test configuration, please refer to the attached file (Test Setup Photo).

4.7.5 Test Results
Below 1GHz
WCDMA:

MODE	TX channel 4132	FREQUENCY RANGE	Below 1000MHz
-------------	-----------------	------------------------	---------------

Antenna Polarity & Test Distance: Horizontal at 3 M

No.	Freq. (MHz)	Reading (dBuV/m)	S.G Power Value (dBm)	Correction Factor (dB)	EIRP (dBm)	Limit (dBm)	Margin (dB)
1	49.55	29.63	-48.71	-10.13	-58.84	-13	-38.58
2	150.1	32.83	-58.21	-1.00	-59.21	-13	-57.21
3	251.22	47.00	-47.92	3.90	-44.01	-13	-51.82
4	352.2	32.83	-65.03	3.58	-61.45	-13	-68.62
5	390.32	45.4	-52.36	3.44	-48.93	-13	-55.80
6	783.1	48.3	-49.63	1.30	-48.33	-13	-50.93

Antenna Polarity & Test Distance: Vertical at 3 M

No.	Freq. (MHz)	Reading (dBuV/m)	S.G Power Value (dBm)	Correction Factor (dB)	EIRP (dBm)	Limit (dBm)	Margin (dB)
1	33.4	37	-35.49	-14.07	-49.56	-13	-21.42
2	41.4	36.2	-34.77	-12.97	-47.74	-13	-21.80
3	62.3	34.71	-62.44	-2.80	-65.24	-13	-59.65
4	157.53	32.7	-56.21	-0.77	-56.98	-13	-55.44
5	250.1	36.19	-58.77	3.90	-54.88	-13	-62.67
6	450.2	32.87	-65.39	2.80	-62.58	-13	-68.19

Remarks:

1. EIRP (dBm) = S.G Value (dBm) + Correction Factor (dB).
2. Correction Factor (dB) = Substitution Antenna Gain (dB) + Cable Loss (dB).



MODE	TX channel 4182	FREQUENCY RANGE	Below 1000MHz
-------------	-----------------	------------------------	---------------

Antenna Polarity & Test Distance: Horizontal at 3 M

No.	Freq. (MHz)	Reading (dBuV/m)	S.G Power Value (dBm)	Correction Factor (dB)	EIRP (dBm)	Limit (dBm)	Margin (dB)
1	30.51	29.71	-41.74	-14.78	-56.51	-13	-26.96
2	37.88	33.27	-89.96	-4.44	-94.40	-13	-85.52
3	59.03	47.70	-54.72	2.38	-52.35	-13	-57.10
4	154.67	32.67	-65.28	4.62	-60.66	-13	-69.90
5	247.11	45.17	-51.41	4.94	-46.47	-13	-56.35
6	446.28	48.55	-33.56	-3.67	-37.23	-13	-29.89

Antenna Polarity & Test Distance: Vertical at 3 M

No.	Freq. (MHz)	Reading (dBuV/m)	S.G Power Value (dBm)	Correction Factor (dB)	EIRP (dBm)	Limit (dBm)	Margin (dB)
1	35.2	37.86	-35.28	-13.63	-48.91	-13	-21.65
2	43.1	35.55	-36.44	-12.48	-48.92	-13	-23.96
3	63.7	34.65	-62.26	-2.72	-64.98	-13	-59.55
4	159	32.69	-55.80	-0.73	-56.53	-13	-55.07
5	253.47	36.53	-58.30	3.92	-54.38	-13	-62.22
6	452.2	32.77	-65.50	2.78	-62.72	-13	-68.29

Remarks:

1. EIRP (dBm) = S.G Value (dBm) + Correction Factor (dB).
2. Correction Factor (dB) = Substitution Antenna Gain (dB) + Cable Loss (dB).



MODE	TX channel 4233	FREQUENCY RANGE	Below 1000MHz
-------------	-----------------	------------------------	---------------

Antenna Polarity & Test Distance: Horizontal at 3 M

No.	Freq. (MHz)	Reading (dBuV/m)	S.G Power Value (dBm)	Correction Factor (dB)	EIRP (dBm)	Limit (dBm)	Margin (dB)
1	29.59	29.95	-41.16	-15.00	-56.16	-13	-26.16
2	37.84	33.72	-89.52	-4.44	-93.97	-13	-85.08
3	59.48	48.08	-54.32	2.38	-51.94	-13	-56.70
4	153.6	33.66	-64.29	4.62	-59.67	-13	-68.92
5	247.78	44.38	-52.21	4.94	-47.27	-13	-57.14
6	447.85	47.56	-34.63	-3.64	-38.27	-13	-30.98

Antenna Polarity & Test Distance: Vertical at 3 M

No.	Freq. (MHz)	Reading (dBuV/m)	S.G Power Value (dBm)	Correction Factor (dB)	EIRP (dBm)	Limit (dBm)	Margin (dB)
1	35.8	37.78	-35.58	-13.48	-49.06	-13	-22.10
2	43.4	36.87	-35.30	-12.39	-47.69	-13	-22.91
3	64.2	35.49	-61.34	-2.69	-64.03	-13	-58.65
4	158.2	32.55	-56.17	-0.75	-56.92	-13	-55.42
5	251.21	36.42	-58.50	3.90	-54.59	-13	-62.40
6	454.4	32.83	-65.46	2.76	-62.70	-13	-68.22

Remarks:

1. EIRP (dBm) = S.G Value (dBm) + Correction Factor (dB).
2. Correction Factor (dB) = Substitution Antenna Gain (dB) + Cable Loss (dB).

**Above 1GHz
WCDMA:**

MODE	TX channel 4132	FREQUENCY RANGE	Above 1000MHz
-------------	-----------------	------------------------	---------------

Antenna Polarity & Test Distance: Horizontal at 3 M							
No.	Freq. (MHz)	Reading (dBuV/m)	S.G Power Value (dBm)	Correction Factor (dB)	EIRP (dBm)	Limit (dBm)	Margin (dB)
1	1652.8	62.30	-40.42	6.27	-34.15	-13	-46.69
2	2479.2	47.00	-51.32	6.66	-44.66	-13	-57.98
3	3305.6	42.60	-59.48	7.57	-51.91	-13	-67.05
4	4132	45.4	-59.50	7.47	-52.03	-13	-66.96
5	4958.4	48.3	-55.90	7.03	-48.87	-13	-62.93
6	5784.8	49.2	-55.30	6.92	-48.38	-13	-62.22
7	6611.2	50.5	-53.17	5.71	-47.45	-13	-58.88
8	7437.6	53.8	-48.82	4.60	-44.22	-13	-53.42
9	8264	55.7	-46.92	4.17	-42.75	-13	-51.09
Antenna Polarity & Test Distance: Vertical at 3 M							
No.	Freq. (MHz)	Reading (dBuV/m)	S.G Power Value (dBm)	Correction Factor (dB)	EIRP (dBm)	Limit (dBm)	Margin (dB)
1	1652.8	62.3	-40.42	6.27	-34.15	-13	-46.69
2	2479.2	40.8	-57.52	6.66	-50.86	-13	-64.18
3	3305.6	42.3	-59.78	7.57	-52.21	-13	-67.35
4	4132	45.5	-59.40	7.47	-51.93	-13	-66.86
5	4958.4	48.2	-56.00	7.03	-48.97	-13	-63.03
6	5784.8	49.2	-55.30	6.92	-48.38	-13	-62.22
7	6611.2	50.5	-53.17	5.71	-47.45	-13	-58.88
8	7437.6	53.8	-48.82	4.60	-44.22	-13	-53.42
9	8264	55.6	-47.02	4.17	-42.85	-13	-51.19

Remarks:

1. EIRP (dBm) = S.G Value (dBm) + Correction Factor (dB).
2. Correction Factor (dB) = Substitution Antenna Gain (dB) + Cable Loss (dB).

MODE	TX channel 4182	FREQUENCY RANGE	Above 1000MHz
-------------	-----------------	------------------------	---------------

Antenna Polarity & Test Distance: Horizontal at 3 M

No.	Freq. (MHz)	Reading (dBuV/m)	S.G Power Value (dBm)	Correction Factor (dB)	EIRP (dBm)	Limit (dBm)	Margin (dB)
1	1673.2	61.85	-40.78	6.31	-34.47	-13	-47.09
2	2509.8	46.81	-51.70	6.64	-45.05	-13	-58.34
3	3346.4	41.85	-61.16	7.63	-53.53	-13	-68.79
4	4183	45.97	-58.87	7.44	-51.43	-13	-66.32
5	5019.6	49.12	-55.12	7.00	-48.13	-13	-62.12
6	5856.2	49.53	-54.90	6.92	-47.98	-13	-61.82
7	6692.8	51.04	-52.28	5.56	-46.72	-13	-57.84
8	7529.4	53.18	-49.44	4.52	-44.92	-13	-53.96
9	8366	54.96	-47.66	4.18	-43.48	-13	-51.84

Antenna Polarity & Test Distance: Vertical at 3 M

No.	Freq. (MHz)	Reading (dBuV/m)	S.G Power Value (dBm)	Correction Factor (dB)	EIRP (dBm)	Limit (dBm)	Margin (dB)
1	1673.2	62.8	-39.83	6.31	-33.52	-13	-46.14
2	2509.8	40.22	-58.29	6.64	-51.64	-13	-64.93
3	3346.4	43	-60.01	7.63	-52.38	-13	-67.64
4	4183	46.35	-58.49	7.44	-51.05	-13	-65.94
5	5019.6	47.58	-56.66	7.00	-49.67	-13	-63.66
6	5856.2	49.44	-54.99	6.92	-48.07	-13	-61.91
7	6692.8	51.17	-52.15	5.56	-46.59	-13	-57.71
8	7529.4	53.27	-49.35	4.52	-44.83	-13	-53.87
9	8366	55.16	-47.46	4.18	-43.28	-13	-51.64

Remarks:

1. EIRP (dBm) = S.G Value (dBm) + Correction Factor (dB).
2. Correction Factor (dB) = Substitution Antenna Gain (dB) + Cable Loss (dB).

MODE	TX channel 4233	FREQUENCY RANGE	Above 1000MHz
-------------	-----------------	------------------------	---------------

Antenna Polarity & Test Distance: Horizontal at 3 M

No.	Freq. (MHz)	Reading (dBuV/m)	S.G Power Value (dBm)	Correction Factor (dB)	EIRP (dBm)	Limit (dBm)	Margin (dB)
1	1693.2	61.52	-41.01	6.34	-34.66	-13	-47.35
2	2539.8	46.79	-51.92	6.63	-45.29	-13	-58.55
3	3386.4	42.67	-60.39	7.69	-52.71	-13	-68.08
4	4233	46.07	-58.72	7.42	-51.30	-13	-66.14
5	5079.6	49.53	-54.75	6.96	-47.79	-13	-61.71
6	5926.2	48.9	-55.27	6.92	-48.35	-13	-62.19
7	6772.8	50.89	-52.09	5.41	-46.69	-13	-57.50
8	7619.4	54.16	-48.46	4.44	-44.02	-13	-52.91
9	8466	54.9	-47.70	4.20	-43.50	-13	-51.90

Antenna Polarity & Test Distance: Vertical at 3 M

No.	Freq. (MHz)	Reading (dBuV/m)	S.G Power Value (dBm)	Correction Factor (dB)	EIRP (dBm)	Limit (dBm)	Margin (dB)
1	1693.2	63.04	-39.49	6.34	-33.14	-13	-45.83
2	2539.8	40.89	-57.82	6.63	-51.19	-13	-64.45
3	3386.4	43.76	-59.30	7.69	-51.62	-13	-66.99
4	4233	46.73	-58.06	7.42	-50.64	-13	-65.48
5	5079.6	46.7	-57.58	6.96	-50.62	-13	-64.54
6	5926.2	50.22	-53.95	6.92	-47.03	-13	-60.87
7	6772.8	50.51	-52.47	5.41	-47.07	-13	-57.88
8	7619.4	52.96	-49.66	4.44	-45.22	-13	-54.11
9	8466	55	-47.60	4.20	-43.40	-13	-51.80

Remarks:

1. Output Power (dBm) = S.G Value (dBm) + Correction Factor (dB).
2. Correction Factor (dB) = Substitution Antenna Gain (dB) + Cable Loss (dB).

5 Pictures of Test Arrangements

Please refer to the attached file (Test Setup Photo).



A D T

Appendix – Information on the Testing Laboratories

We, Bureau Veritas Consumer Products Services (H.K.) Ltd., Taoyuan Branch, were founded in 1988 to provide our best service in EMC, Radio, Telecom and Safety consultation. Our laboratories are accredited and approved according to ISO/IEC 17025.

If you have any comments, please feel free to contact us at the following:

Linko EMC/RF Lab

Tel: 886-2-26052180

Fax: 886-2-26051924

Hsin Chu EMC/RF/Telecom Lab

Tel: 886-3-6668565

Fax: 886-3-6668323

Hwa Ya EMC/RF/Safety

Tel: 886-3-3183232

Fax: 886-3-3270892

Email: service.adt@tw.bureauveritas.com

Web Site: www.bureauveritas-adt.com

The address and road map of all our labs can be found in our web site also.

--- END ---