

FCC Test Report

Report No.: RF160314E01-1

FCC ID: G95TCA300

Test Model: TCA300COM

Received Date: Mar. 14, 2016

Test Date: Apr. 21 to 29, 2016

Issued Date: May 23, 2016

Applicant: Technicolor Connected Home USA LLC

Address: 101 West 103rd Street, Indianapolis, IN 46290 United States

Issued By: Bureau Veritas Consumer Products Services (H.K.) Ltd., Taoyuan Branch
Hsin Chu Laboratory

Lab Address: E-2, No.1, Li Hsin 1st Road, Hsinchu Science Park, Hsinchu City 300,
Taiwan R.O.C.

Test Location (1): E-2, No.1, Li Hsin 1st Road, Hsinchu Science Park, Hsinchu City 300,
Taiwan R.O.C.

Test Location (2): No. 49, Ln. 206, Wende Rd., Shangshan Tsuen, Chiung Lin Hsiang, Hsin
Chu Hsien 307, Taiwan R.O.C.



This report is for your exclusive use. Any copying or replication of this report to or for any other person or entity, or use of our name or trademark, is permitted only with our prior written permission. This report sets forth our findings solely with respect to the test samples identified herein. The results set forth in this report are not indicative or representative of the quality or characteristics of the lot from which a test sample was taken or any similar or identical product unless specifically and expressly noted. Our report includes all of the tests requested by you and the results thereof based upon the information that you provided to us. You have 60 days from date of issuance of this report to notify us of any material error or omission caused by our negligence, provided, however, that such notice shall be in writing and shall specifically address the issue you wish to raise. A failure to raise such issue within the prescribed time shall constitute your unqualified acceptance of the completeness of this report, the tests conducted and the correctness of the report contents. Unless specific mention, the uncertainty of measurement has been explicitly taken into account to declare the compliance or non-compliance to the specification. The report must not be used by the client to claim product certification, approval, or endorsement by TAF or any government agencies.

Table of Contents

Release Control Record	4
1 Certificate of Conformity	5
2 Summary of Test Results	6
2.1 Measurement Uncertainty.....	6
2.2 Modification Record.....	6
3 General Information	7
3.1 General Description of EUT (WLAN 5GHz).....	7
3.2 Description of Test Modes.....	10
3.2.1 Test Mode Applicability and Tested Channel Detail.....	12
3.3 Duty Cycle of Test Signal.....	16
3.4 Description of Support Units.....	19
3.4.1 Configuration of System under Test.....	20
3.5 General Description of Applied Standard.....	21
4 Test Types and Results	22
4.1 Radiated Emission and Bandedge Measurement.....	22
4.1.1 Limits of Radiated Emission and Bandedge Measurement.....	22
4.1.2 Test Instruments.....	23
4.1.3 Test Procedure.....	24
4.1.4 Deviation from Test Standard.....	24
4.1.5 Test Setup.....	25
4.1.6 EUT Operating Condition.....	25
4.1.7 Test Results (Bandedge).....	26
4.1.8 Test Results (Spurious emission).....	224
4.2 Conducted Emission Measurement.....	324
4.2.1 Limits of Conducted Emission Measurement.....	324
4.2.2 Test Instruments.....	324
4.2.3 Test Procedure.....	325
4.2.4 Deviation from Test Standard.....	325
4.2.5 Test Setup.....	325
4.2.6 EUT Operating Condition.....	325
4.2.7 Test Results.....	326
4.3 Transmit Power Measurement.....	328
4.3.1 Limits of Transmit Power Measurement.....	328
4.3.2 Test Setup.....	328
4.3.3 Test Instruments.....	329
4.3.4 Test Procedure.....	329
4.3.5 Deviation from Test Standard.....	329
4.3.6 EUT Operating Condition.....	329
4.3.7 Test Result.....	330
4.4 Peak Power Spectral Density Measurement.....	351
4.4.1 Limits of Peak Power Spectral Density Measurement.....	351
4.4.2 Test Setup.....	351
4.4.3 Test Instruments.....	351
4.4.4 Test Procedure.....	352
4.4.5 Deviation from Test Standard.....	352
4.4.6 EUT Operating Condition.....	352
4.4.7 Test Results.....	353
4.5 Frequency Stability Measurement.....	363
4.5.1 Limits of Frequency Stability Measurement.....	363
4.5.2 Test Setup.....	363
4.5.3 Test Instruments.....	363
4.5.4 Test Procedure.....	363
4.5.5 Deviation from Test Standard.....	363



4.5.6 EUT Operating Condition	363
4.5.7 Test Results	364
4.6 6dB Bandwidth Measurement	365
4.6.1 Limits of 6dB Bandwidth Measurement	365
4.6.2 Test Setup	365
4.6.3 Test Instruments	365
4.6.4 Test Procedure	365
4.6.5 Deviation from Test Standard	365
4.6.6 EUT Operating Condition	365
4.6.7 Test Results	366
5 Pictures of Test Arrangements	370
Appendix – Information on the Testing Laboratories	371



A D T

Release Control Record

Issue No.	Description	Date Issued
RF160314E01-1	Original release.	May 23, 2016

1 Certificate of Conformity

Product: Integrated Device

Brand: Technicolor

Test Model: TCA300COM

Sample Status: ENGINEERING SAMPLE

Applicant: Technicolor Connected Home USA LLC

Test Date: Apr. 21 to 29, 2016

Standard: 47 CFR FCC Part 15, Subpart E (Section 15.407)
ANSI C63.10: 2013

The above equipment has been tested by **Bureau Veritas Consumer Products Services (H.K.) Ltd., Taoyuan Branch**, and found compliance with the requirement of the above standards. The test record, data evaluation & Equipment Under Test (EUT) configurations represented herein are true and accurate accounts of the measurements of the sample's EMC characteristics under the conditions specified in this report.

Prepared by :  _____, **Date:** _____ May 23, 2016
Claire Kuan / Specialist

Approved by :  _____, **Date:** _____ May 23, 2016
May Chen / Manager

2 Summary of Test Results

47 CFR FCC Part 15, Subpart E (SECTION 15.407)			
FCC Clause	Test Item	Result	Remarks
15.407(b)(6)	AC Power Conducted Emissions	PASS	Meet the requirement of limit. Minimum passing margin is -11.86dB at 0.28672MHz.
15.407(b)(1/2/3/4/6)	Radiated Emissions & Band Edge Measurement	PASS	Meet the requirement of limit. Minimum passing margin is -0.1dB at 5150.00MHz and 5350.00MHz and 5470.00MHz and 5715.00MHz and 5725.00MHz and 5860.00MHz.
15.407(a)(1/2/3)	Max Average Transmit Power	PASS	Meet the requirement of limit.
15.407(a)(1/2/3)	Peak Power Spectral Density	PASS	Meet the requirement of limit.
15.407(e)	6dB bandwidth	PASS	Meet the requirement of limit. (U-NII-3 Band only)
15.407(g)	Frequency Stability	PASS	Meet the requirement of limit.
15.203	Antenna Requirement	PASS	Antenna connectors are i-pex (MHF) and Pogo pin not a standard connector.

NOTE: 1. For WLAN: The EUT was operating in 2.412 ~ 2.472GHz, 5.18~5.24 GHz, 5.26~5.32 GHz, 5.50~5.72GHz and 5.745~5.825GHz frequency bands. This report was recorded the RF parameters including 5.18~5.24 GHz, 5.26~5.32 GHz, 5.50~5.72GHz and 5.745~5.825GHz. For the 2.412 ~ 2.472GHz RF parameters was recorded in another test report.

2.1 Measurement Uncertainty

Where relevant, the following measurement uncertainty levels have been estimated for tests performed on the EUT as specified in CISPR 16-4-2:

Measurement	Frequency	Expanded Uncertainty (k=2) (±)
Conducted Emissions at mains ports	150kHz ~ 30MHz	1.83 dB
Radiated Emissions up to 1 GHz	30MHz ~ 1GHz	5.31 dB
Radiated Emissions above 1 GHz	1GHz ~ 6GHz	3.40 dB
	6GHz ~ 18GHz	3.73 dB
	18GHz ~ 40GHz	4.11 dB

2.2 Modification Record

There were no modifications required for compliance.

3 General Information

3.1 General Description of EUT (WLAN 5GHz)

Product	Integrated Device
Brand	Technicolor
Test Model	TCA300COM
Status of EUT	ENGINEERING SAMPLE
Power Supply Rating	12Vdc from power adapter or 4Vdc from battery
Modulation Type	CCK, DQPSK, DBPSK for DSSS 64QAM, 16QAM, QPSK, BPSK for OFDM
Modulation Technology	DSSS, OFDM
Transfer Rate	802.11b: up to 11Mbps 802.11a/g: up to 54Mbps 802.11n: up to 300Mbps
Operating Frequency	For 15.407: 5.18~5.24GHz, 5.26~5.32GHz, 5.50~5.70GHz, 5.745~5.825GHz
	For 15.247: 2.412 ~ 2.462GHz
Number of Channel	For 15.407: 802.11a, 802.11n (20MHz): 24 802.11n (40MHz): 11
	For 15.247: 802.11b, 802.11g, 802.11n (20MHz): 11 802.11n (40MHz): 7
Output Power	For 15.407: 1TX Antenna 1 5.18~5.24GHz 125.026mW 5.26~5.32GHz 122.462mW 5.50~5.70GHz 91.622mW 5.745~5.825GHz 94.624mW Antenna 2 5.18~5.24GHz 108.143mW 5.26~5.32GHz 110.662mW 5.50~5.70GHz 73.451mW 5.745~5.825GHz 67.92mW 2TX 5.18~5.24GHz 229.018mW 5.26~5.32GHz 227.54mW 5.50~5.70GHz 156.97mW 5.745~5.825GHz 150.418mW

	For 15.247: 1TX Antenna 1 127.644mW Antenna 2 125.314mW 2TX 126.409mW
Antenna Type	Refer to Note
Antenna Connector	Refer to Note
Accessory Device	Adapter x1 Battery x1
Data Cable Supplied	NA
HW Version	FGR

Note:

1. There are WLAN, Bluetooth, Zigbee and WWAN(3G) technology used for the EUT.
2. The EUT power needs to be supplied from one power adapter or battery, the information is as below table:

Adapter		
Brand	Model	Spec.
XHPSU-TC	37469780	Input: 100-120Vac, 50/60Hz, 0.7A Output: 12V, 1.5A DC output cable (Unshielded, 3m)
Battery		
Brand	Model	Spec.
Li-polymer	U46P313.00	4V, 2520mAh, 10.08Wh

3. The antennas provided to the EUT, please refer to the following table:

Antenna NO.	Brand	Antenna Gain(dBi) (Including cable loss)	Frequency range (GHz)	Antenna Type	Connecter Type
Zigbee 1	INPAQ	2.84	2.4~2.4835GHz	PCB	i-pex(MHF)
Zigbee 2	INPAQ	3.1	2.4~2.4835GHz	PCB	i-pex(MHF)
WiFi 1 & BT	INPAQ	2.06	2.4~2.4835GHz	PCB	Pogo pin
		3.13	5.15~5.25GHz		
		3.79	5.25~5.35GHz		
		3.9	5.47~5.725GHz		
		2.39	5.725~5.85GHz		
WiFi 2	INPAQ	0.73	2.4~2.4835GHz	PCB	i-pex(MHF)
		2.86	5.15~5.25GHz		
		3.02	5.25~5.35GHz		
		3.33	5.47~5.725GHz		
WWAN	INPAQ	2.56	824~849MHz	PCB	Pogo pin
		3.72	1850~1960MHz		

4. The EUT incorporates a MIMO function.

2.4GHz Band			
MODULATION MODE	DATA RATE (MCS)	TX & RX CONFIGURATION	
802.11b	1 ~ 11Mbps	1TX diversity	2RX
802.11g	6 ~ 54Mbps	1TX diversity / 2TX	2RX
802.11n (20MHz)	MCS 0~7	1TX diversity / 2TX	2RX
	MCS 8~15	2TX	2RX
802.11n (40MHz)	MCS 0~7	1TX diversity / 2TX	2RX
	MCS 8~15	2TX	2RX
5GHz Band			
MODULATION MODE	DATA RATE (MCS)	TX & RX CONFIGURATION	
802.11a	6 ~ 54Mbps	1TX diversity / 2TX	2RX
802.11n (20MHz)	MCS 0~7	1TX diversity / 2TX	2RX
	MCS 8~15	2TX	2RX
802.11n (40MHz)	MCS 0~7	1TX diversity / 2TX	2RX
	MCS 8~15	2TX	2RX

5. The above EUT information is declared by manufacturer and for more detailed features description, please refer to the manufacturer's specifications or user's manual.

3.2 Description of Test Modes

FOR 5180 ~ 5240MHz

4 channels are provided for 802.11a, 802.11n (20MHz):

Channel	Frequency	Channel	Frequency
36	5180 MHz	44	5220 MHz
40	5200 MHz	48	5240 MHz

2 channels are provided for 802.11n (40MHz):

Channel	Frequency	Channel	Frequency
38	5190 MHz	46	5230 MHz

FOR 5260 ~ 5320MHz

4 channels are provided for 802.11a (20MHz):

Channel	Frequency	Channel	Frequency
52	5260 MHz	60	5300 MHz
56	5280 MHz	64	5320 MHz

2 channels are provided for 802.11n (40MHz):

Channel	Frequency	Channel	Frequency
54	5270 MHz	62	5310 MHz

FOR 5500 ~ 5700MHz

11 channels are provided for 802.11a, 802.11n (20MHz):

Channel	Frequency	Channel	Frequency
100	5500 MHz	124	5620 MHz
104	5520 MHz	128	5640 MHz
108	5540 MHz	132	5660 MHz
112	5560 MHz	136	5680 MHz
116	5580 MHz	140	5700 MHz
120	5600 MHz		

5 channels are provided for 802.11n (40MHz):

Channel	Frequency	Channel	Frequency
102	5510 MHz	126	5630 MHz
110	5550 MHz	134	5670 MHz
118	5590 MHz		

FOR 5745 ~ 5825MHz:

5 channels are provided for 802.11a, 802.11n (20MHz):

Channel	Frequency	Channel	Frequency
149	5745MHz	161	5805MHz
153	5765MHz	165	5825MHz
157	5785MHz		

2 channels are provided for 802.11n (40MHz):

Channel	Frequency	Channel	Frequency
151	5755MHz	159	5795MHz

3.2.1 Test Mode Applicability and Tested Channel Detail

EUT CONFIGURE MODE	APPLICABLE TO				DESCRIPTION
	RE \geq 1G	RE $<$ 1G	PLC	APCM	
-	√	√	√	√	-

Where **RE \geq 1G**: Radiated Emission above 1GHz **RE $<$ 1G**: Radiated Emission below 1GHz
PLC: Power Line Conducted Emission **APCM**: Antenna Port Conducted Measurement

NOTE:

1. The EUT had been pre-tested on the positioned of each 3 axis. The worst case was found when positioned on **X-plane**.

Radiated Emission Test (Above 1GHz):

- Pre-Scan has been conducted to determine the worst-case mode from all possible combinations between available modulations, data rates and antenna ports (if EUT with antenna diversity architecture).
- Following channel(s) was (were) selected for the final test as listed below.

1TX						
Antenna 1						
Mode	FREQ. Band (MHz)	Available Channel	Tested Channel	Modulation Technology	Modulation Type	Data Rate (Mbps)
802.11a	5180-5240	36 to 48	36, 40, 48	OFDM	BPSK	6.0
802.11n (20MHz)		36 to 48	36, 40, 48	OFDM	BPSK	6.5
802.11n (40MHz)		38 to 46	38, 46	OFDM	BPSK	13.5
802.11a	5260-5320	52 to 64	52, 60, 64	OFDM	BPSK	6.0
802.11n (20MHz)		52 to 64	52, 60, 64	OFDM	BPSK	6.5
802.11n (40MHz)		54 to 62	54, 62	OFDM	BPSK	13.5
802.11a	5500-5700	100 to 140	100, 116, 140	OFDM	BPSK	6.0
802.11n (20MHz)		100 to 140	100, 116, 140	OFDM	BPSK	6.5
802.11n (40MHz)		102 to 134	102, 110, 134	OFDM	BPSK	13.5
802.11a	5745-5825	149 to 165	149, 157, 165	OFDM	BPSK	6.0
802.11n (20MHz)		149 to 165	149, 157, 165	OFDM	BPSK	6.5
Antenna 2						
Mode	FREQ. Band (MHz)	Available Channel	Tested Channel	Modulation Technology	Modulation Type	Data Rate (Mbps)
802.11a	5180-5240	36 to 48	36, 40, 48	OFDM	BPSK	6.0
802.11n (20MHz)		36 to 48	36, 40, 48	OFDM	BPSK	6.5
802.11n (40MHz)		38 to 46	38, 46	OFDM	BPSK	13.5
802.11a	5260-5320	52 to 64	52, 60, 64	OFDM	BPSK	6.0
802.11n (20MHz)		52 to 64	52, 60, 64	OFDM	BPSK	6.5
802.11n (40MHz)		54 to 62	54, 62	OFDM	BPSK	13.5
802.11a	5500-5700	100 to 140	100, 116, 140	OFDM	BPSK	6.0
802.11n (20MHz)		100 to 140	100, 116, 140	OFDM	BPSK	6.5
802.11n (40MHz)		102 to 134	102, 110, 134	OFDM	BPSK	13.5
802.11a	5745-5825	149 to 165	149, 157, 165	OFDM	BPSK	6.0
802.11n (20MHz)		149 to 165	149, 157, 165	OFDM	BPSK	6.5
802.11n (40MHz)		151 to 159	151, 159	OFDM	BPSK	13.5

2TX						
CDD Mode						
Mode	FREQ. Band (MHz)	Available Channel	Tested Channel	Modulation Technology	Modulation Type	Data Rate (Mbps)
802.11a	5180-5240	36 to 48	36, 40, 48	OFDM	BPSK	6.0
802.11n (20MHz)		36 to 48	36, 40, 48	OFDM	BPSK	6.5
802.11n (40MHz)		38 to 46	38, 46	OFDM	BPSK	13.5
802.11a	5260-5320	52 to 64	52, 60, 64	OFDM	BPSK	6.0
802.11n (20MHz)		52 to 64	52, 60, 64	OFDM	BPSK	6.5
802.11n (40MHz)		54 to 62	54, 62	OFDM	BPSK	13.5
802.11a	5500-5700	100 to 140	100, 116, 140	OFDM	BPSK	6.0
802.11n (20MHz)		100 to 140	100, 116, 140	OFDM	BPSK	6.5
802.11n (40MHz)		102 to 134	102, 110, 134	OFDM	BPSK	13.5
802.11a	5745-5825	149 to 165	149, 157, 165	OFDM	BPSK	6.0
802.11n (20MHz)		149 to 165	149, 157, 165	OFDM	BPSK	6.5
802.11n (40MHz)		151 to 159	151, 159	OFDM	BPSK	13.5

Radiated Emission Test (Below 1GHz):

- Pre-Scan has been conducted to determine the worst-case mode from all possible combinations between available modulations, data rates and antenna ports (if EUT with antenna diversity architecture).
- Following channel(s) was (were) selected for the final test as listed below.

2TX						
CDD Mode						
Mode	FREQ. Band (MHz)	Available Channel	Tested Channel	Modulation Technology	Modulation Type	Data Rate (Mbps)
802.11a	5180-5825	36 to 165	52	OFDM	BPSK	6.0

Power Line Conducted Emission Test:

- Pre-Scan has been conducted to determine the worst-case mode from all possible combinations between available modulations, data rates and antenna ports (if EUT with antenna diversity architecture).
- Following channel(s) was (were) selected for the final test as listed below.

2TX						
CDD Mode						
Mode	FREQ. Band (MHz)	Available Channel	Tested Channel	Modulation Technology	Modulation Type	Data Rate (Mbps)
802.11a	5180-5825	36 to 165	52	OFDM	BPSK	6.0

Antenna Port Conducted Measurement:

- This item includes all test value of each mode, but only includes spectrum plot of worst value of each mode.
- Pre-Scan has been conducted to determine the worst-case mode from all possible combinations between available modulations, data rates and antenna ports (if EUT with antenna diversity architecture).
- Following channel(s) was (were) selected for the final test as listed below.

1TX						
Antenna 1						
Mode	FREQ. Band (MHz)	Available Channel	Tested Channel	Modulation Technology	Modulation Type	Data Rate (Mbps)
802.11a	5180-5240	36 to 48	36, 40, 48	OFDM	BPSK	6.0
802.11n (20MHz)		36 to 48	36, 40, 48	OFDM	BPSK	6.5
802.11n (40MHz)		38 to 46	38, 46	OFDM	BPSK	13.5
802.11a	5260-5320	52 to 64	52, 60, 64	OFDM	BPSK	6.0
802.11n (20MHz)		52 to 64	52, 60, 64	OFDM	BPSK	6.5
802.11n (40MHz)		54 to 62	54, 62	OFDM	BPSK	13.5
802.11a	5500-5700	100 to 140	100, 116, 140	OFDM	BPSK	6.0
802.11n (20MHz)		100 to 140	100, 116, 140	OFDM	BPSK	6.5
802.11n (40MHz)		102 to 134	102, 110, 134	OFDM	BPSK	13.5
802.11a	5745-5825	149 to 165	149, 157, 165	OFDM	BPSK	6.0
802.11n (20MHz)		149 to 165	149, 157, 165	OFDM	BPSK	6.5
802.11n (40MHz)		151 to 159	151, 159	OFDM	BPSK	13.5
Antenna 2						
Mode	FREQ. Band (MHz)	Available Channel	Tested Channel	Modulation Technology	Modulation Type	Data Rate (Mbps)
802.11a	5180-5240	36 to 48	36, 40, 48	OFDM	BPSK	6.0
802.11n (20MHz)		36 to 48	36, 40, 48	OFDM	BPSK	6.5
802.11n (40MHz)		38 to 46	38, 46	OFDM	BPSK	13.5
802.11a	5260-5320	52 to 64	52, 60, 64	OFDM	BPSK	6.0
802.11n (20MHz)		52 to 64	52, 60, 64	OFDM	BPSK	6.5
802.11n (40MHz)		54 to 62	54, 62	OFDM	BPSK	13.5
802.11a	5500-5700	100 to 140	100, 116, 140	OFDM	BPSK	6.0
802.11n (20MHz)		100 to 140	100, 116, 140	OFDM	BPSK	6.5
802.11n (40MHz)		102 to 134	102, 110, 134	OFDM	BPSK	13.5
802.11a	5745-5825	149 to 165	149, 157, 165	OFDM	BPSK	6.0
802.11n (20MHz)		149 to 165	149, 157, 165	OFDM	BPSK	6.5
802.11n (40MHz)		151 to 159	151, 159	OFDM	BPSK	13.5

Note: Antenna combination 2 was performed output power measurement only.

2TX						
CDD Mode						
Mode	FREQ. Band (MHz)	Available Channel	Tested Channel	Modulation Technology	Modulation Type	Data Rate (Mbps)
802.11a	5180-5240	36 to 48	36, 40, 48	OFDM	BPSK	6.0
802.11n (20MHz)		36 to 48	36, 40, 48	OFDM	BPSK	6.5
802.11n (40MHz)		38 to 46	38, 46	OFDM	BPSK	13.5
802.11a	5260-5320	52 to 64	52, 60, 64	OFDM	BPSK	6.0
802.11n (20MHz)		52 to 64	52, 60, 64	OFDM	BPSK	6.5
802.11n (40MHz)		54 to 62	54, 62	OFDM	BPSK	13.5
802.11a	5500-5700	100 to 140	100, 116, 140	OFDM	BPSK	6.0
802.11n (20MHz)		100 to 140	100, 116, 140	OFDM	BPSK	6.5
802.11n (40MHz)		102 to 134	102, 110, 134	OFDM	BPSK	13.5
802.11a	5745-5825	149 to 165	149, 157, 165	OFDM	BPSK	6.0
802.11n (20MHz)		149 to 165	149, 157, 165	OFDM	BPSK	6.5
802.11n (40MHz)		151 to 159	151, 159	OFDM	BPSK	13.5

Test Condition:

APPLICABLE TO	ENVIRONMENTAL CONDITIONS	INPUT POWER	TESTED BY	TEST LOCATION
RE\geq1G	25deg. C, 65%RH	120Vac, 60Hz	Tim Ho	1
RE$<$1G	25deg. C, 65%RH	120Vac, 60Hz	Tim Ho	1
PLC	25deg. C, 64%RH	120Vac, 60Hz	Anderson Chen	1
APCM	25deg. C, 60%RH	120Vac, 60Hz	Robert Cheng	1

3.3 Duty Cycle of Test Signal

1TX

For Antenna 1:

If duty cycle of test signal is $\geq 98\%$, duty factor is not required.

802.11a: Duty cycle = $2.063 \text{ ms} / 2.094 \text{ ms} = 0.985$

802.11n (20MHz): Duty cycle = $1.919 \text{ ms} / 1.951 \text{ ms} = 0.984$

802.11n (40MHz): Duty cycle = $0.954 \text{ ms} / 0.972 \text{ ms} = 0.981$

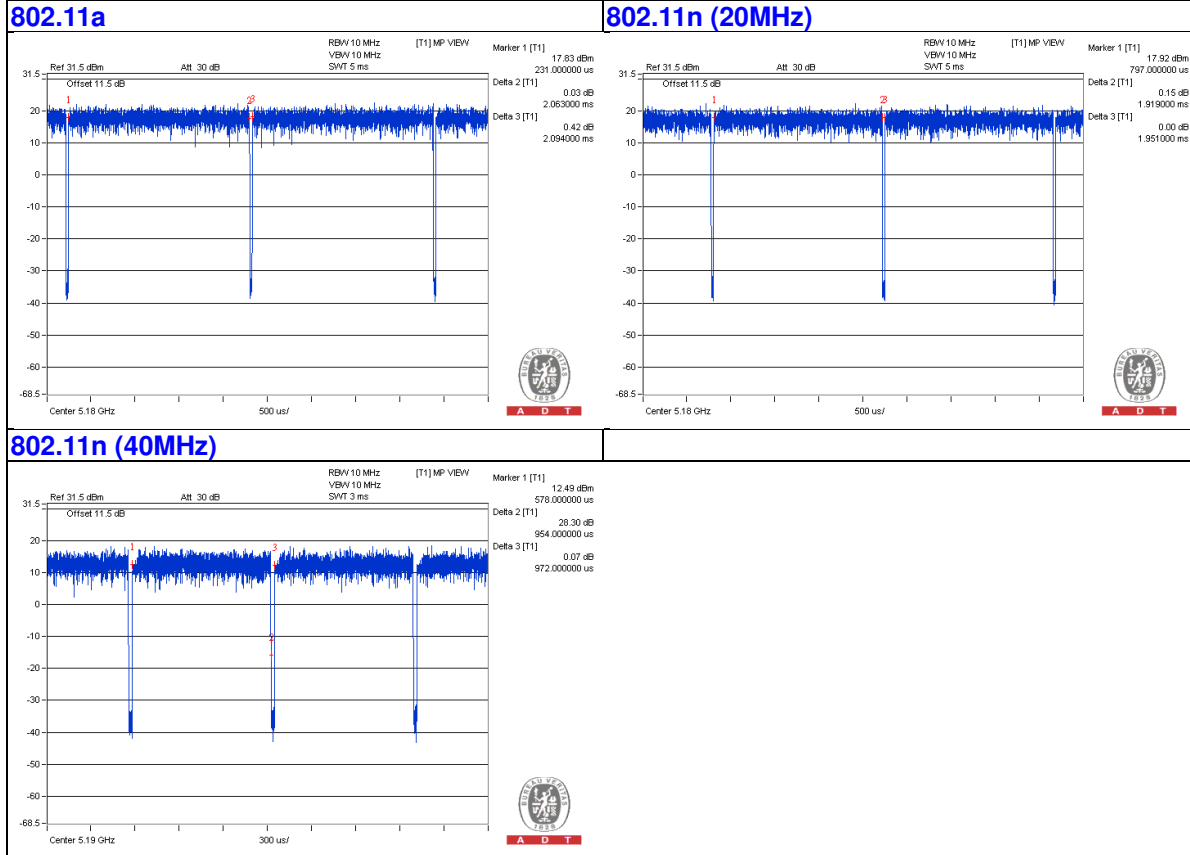

For Antenna 2:

If duty cycle of test signal is $\geq 98\%$, duty factor is not required.

802.11a: Duty cycle = $2.063 \text{ ms} / 2.094 \text{ ms} = 0.985$

802.11n (20MHz): Duty cycle = $1.919 \text{ ms} / 1.951 \text{ ms} = 0.984$

802.11n (40MHz): Duty cycle = $0.954 \text{ ms} / 0.972 \text{ ms} = 0.981$

802.11a

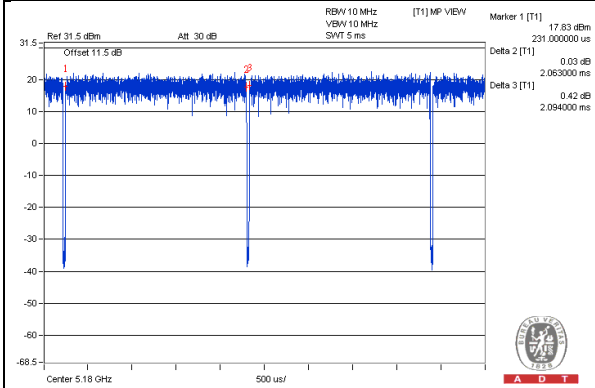

802.11n (20MHz)

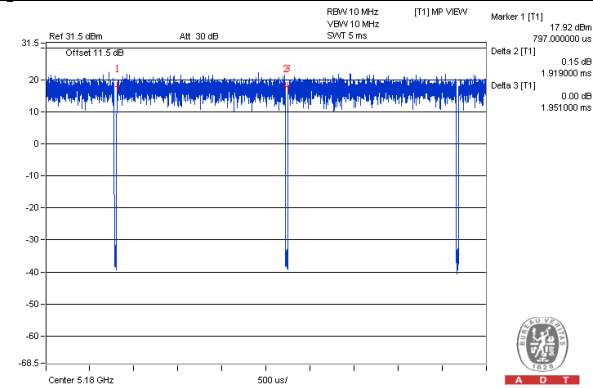

802.11n (40MHz)

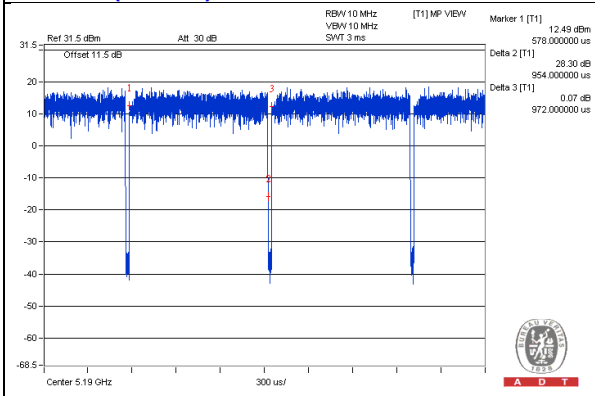

2TX
CDD Mode

If duty cycle of test signal is $\geq 98\%$, duty factor is not required.

802.11a: Duty cycle = $2.063 \text{ ms} / 2.094 \text{ ms} = 0.985$

802.11n (20MHz): Duty cycle = $1.919 \text{ ms} / 1.951 \text{ ms} = 0.984$

802.11n (40MHz): Duty cycle = $0.954 \text{ ms} / 0.972 \text{ ms} = 0.981$

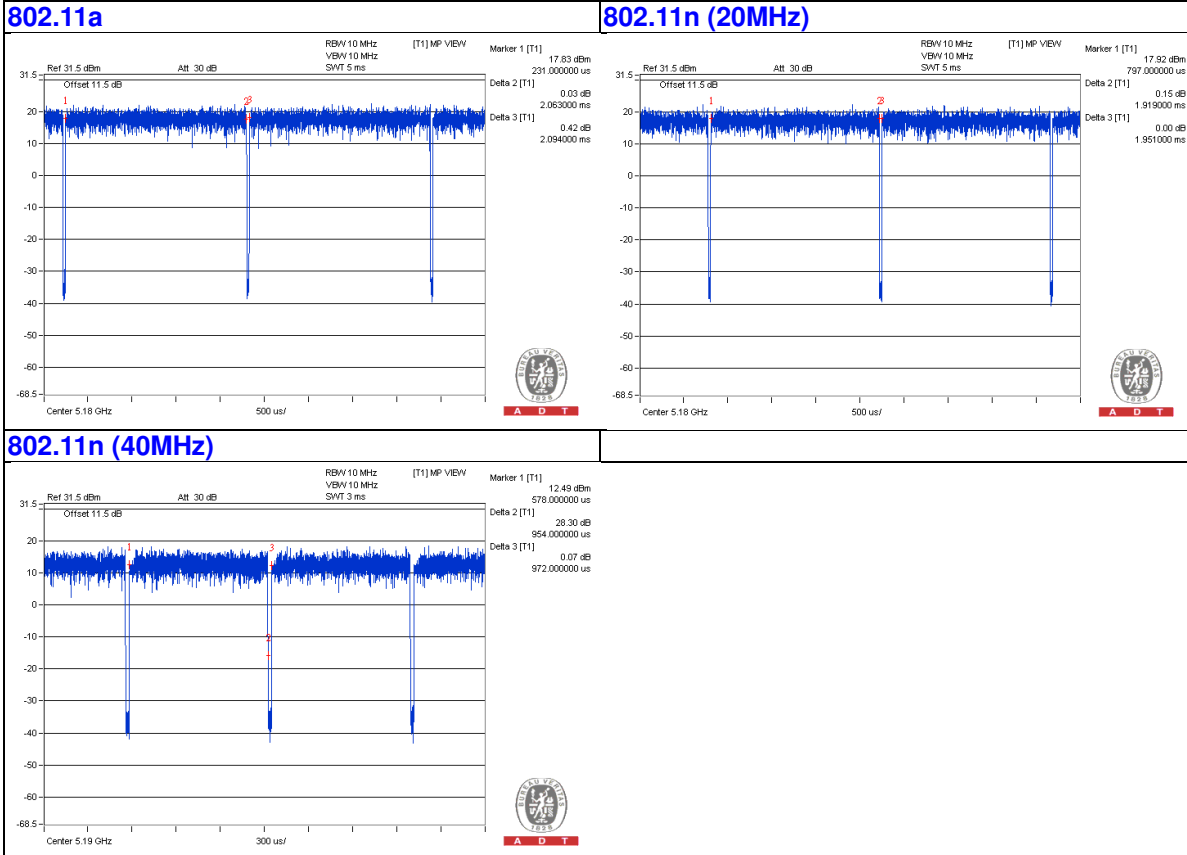

3.4 Description of Support Units

The EUT has been tested as an independent unit together with other necessary accessories or support units. The following support units or accessories were used to form a representative test configuration during the tests.

ID	Product	Brand	Model No.	Serial No.	FCC ID	Remarks
A.	Notebook Computer	DELL	E5430	HYV4VY1	FCC DoC	Provided by Lab

Note:

1. All power cords of the above support units are non-shielded (1.8m).

ID	Descriptions	Qty.	Length (m)	Shielding (Yes/No)	Cores (Qty.)	Remarks
1.	RJ45 cable	1	10	No	0	Provided by Lab
2.	DC cable	1	3	No	0	Supplied by Client

3.4.1 Configuration of System under Test

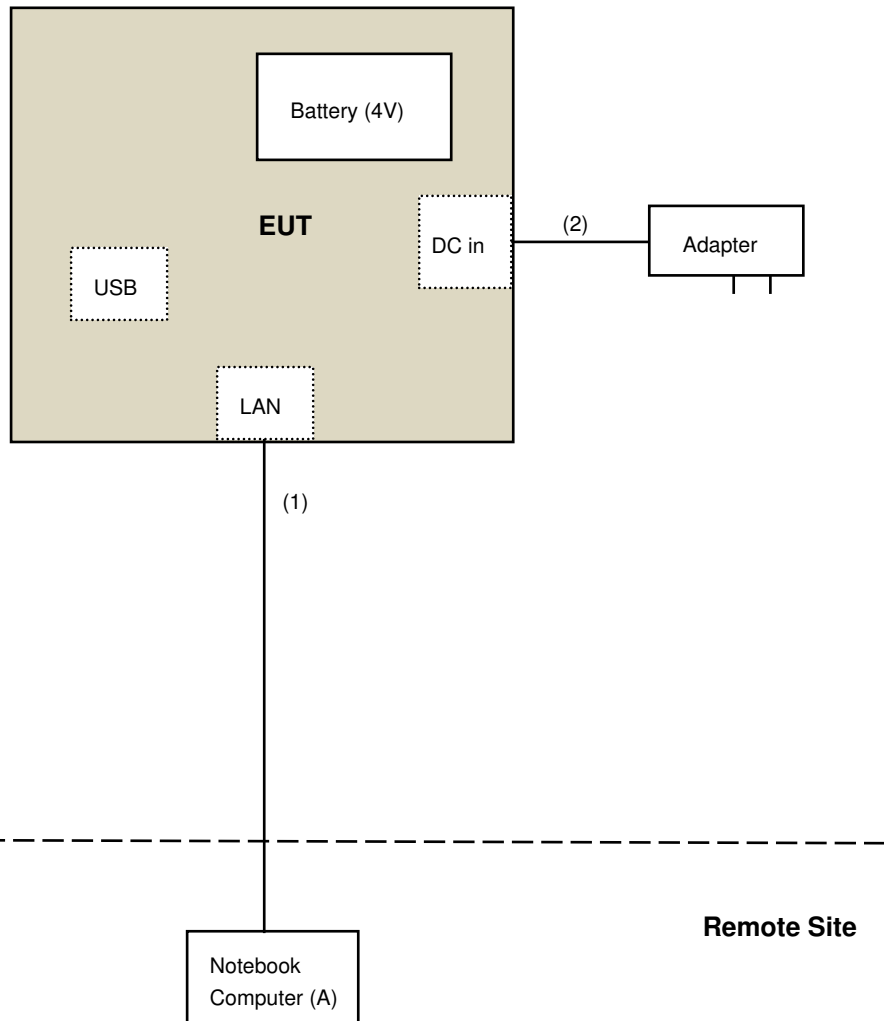

3.5 General Description of Applied Standard

The EUT is a RF Product. According to the specifications of the manufacturer, it must comply with the requirements of the following standards:

FCC Part 15, Subpart E (15.407)

KDB 789033 D02 General UNII Test Procedure New Rules v01r02

KDB 662911 D01 Multiple Transmitter Output v02r01

ANSI C63.10-2013 2013

All test items have been performed and recorded as per the above standards.

4 Test Types and Results

4.1 Radiated Emission and Bandedge Measurement

4.1.1 Limits of Radiated Emission and Bandedge Measurement

Radiated emissions which fall in the restricted bands must comply with the radiated emission limits specified as below table.

Frequencies (MHz)	Field Strength (microvolts/meter)	Measurement Distance (meters)
0.009 ~ 0.490	2400/F(kHz)	300
0.490 ~ 1.705	24000/F(kHz)	30
1.705 ~ 30.0	30	30
30 ~ 88	100	3
88 ~ 216	150	3
216 ~ 960	200	3
Above 960	500	3

NOTE:

1. The lower limit shall apply at the transition frequencies.
2. Emission level (dBuV/m) = 20 log Emission level (uV/m).
3. For frequencies above 1000MHz, the field strength limits are based on average detector, however, the peak field strength of any emission shall not exceed the maximum permitted average limits, specified above by more than 20dB under any condition of modulation.

LIMITS OF UNWANTED EMISSION OUT OF THE RESTRICTED BANDS

APPLICABLE TO	LIMIT	
789033 D02 General UNII Test Procedure New Rules v01r02	FIELD STRENGTH AT 3m	
	PK:74 (dBμV/m)	AV:54 (dBμV/m)
APPLICABLE TO	EIRP LIMIT	EQUIVALENT FIELD STRENGTH AT 3m
15.407(b)(1)	PK:-27 (dBm/MHz)	PK:68.2(dBμV/m)
15.407(b)(2)		
15.407(b)(3)		
15.407(b)(4)	PK:-27 (dBm/MHz) ^{*1} PK:-17 (dBm/MHz) ^{*2}	PK: 68.2(dBμV/m) ^{*1} PK:78.2 (dBμV/m) ^{*2}

NOTE: ^{*1} beyond 10MHz of the band edge ^{*2} within 10 MHz of band edge

The following formula is used to convert the equipment isotropic radiated power (eirp) to field strength:

$$E = \frac{1000000\sqrt{30P}}{3} \mu\text{V/m, where P is the eirp (Watts).}$$



A D T

4.1.2 Test Instruments

DESCRIPTION & MANUFACTURER	MODEL NO.	SERIAL NO.	CALIBRATED DATE	CALIBRATED UNTIL
Test Receiver Agilent	N9038A	MY50010156	Aug. 12, 2015	Aug. 11, 2016
Pre-Amplifier ^(*) EMCI	EMC001340	980142	Jan. 20, 2016	Jan. 19, 2018
Loop Antenna ^(*) Electro-Metrics	EM-6879	264	Dec. 16, 2014	Dec. 15, 2016
RF Cable	NA	LOOPCAB-001 LOOPCAB-002	Jan. 18, 2016	Jan. 17, 2017
Pre-Amplifier Mini-Circuits	ZFL-1000VH2B	AMP-ZFL-07	May 08, 2015	May 07, 2016
Trilog Broadband Antenna SCHWARZBECK	VULB 9168	9168-156	Jan. 04, 2016	Jan. 03, 2017
RF Cable	8D	966-3-1 966-3-2 966-3-3	Apr. 02, 2016	Apr. 01, 2017
Horn_Antenna SCHWARZBECK	BBHA9120-D	9120D-406	Jan. 20, 2016	Jan. 19, 2017
Pre-Amplifier Agilent	8449B	3008A02465	Apr. 05, 2016	Apr. 04, 2017
RF Cable	EMC104-SM-SM-2000 EMC104-SM-SM-5000 EMC104-SM-SM-5000	150317 150321 150322	Mar. 30, 2016	Mar. 29, 2017
Spectrum Analyzer Keysight	N9030A	MY54490520	July 26, 2015	July 25, 2016
Pre-Amplifier EMCI	EMC184045	980143	Jan. 15, 2016	Jan. 14, 2017
Horn_Antenna SCHWARZBECK	BBHA 9170	BBHA9170608	Jan. 08, 2016	Jan. 07, 2017
RF Cable	SUCOFLEX 102	36432/2 36441/2	Jan. 16, 2016	Jan. 15, 2017
Software	ADT_Radiated_V8.7.07	NA	NA	NA
Antenna Tower & Turn Table CT	NA	NA	NA	NA
Boresight Antenna Fixture	NA	NA	NA	NA
Temperature & Humidity Chamber TERCHY	MHU-225AU	911033	Dec. 03, 2015	Dec. 02, 2016
True RMS Multimeter FLUKE	87III	73680266	Nov. 10, 2015	Nov. 09, 2016
AC Power Source Extech Electronics	6205	1440452	NA	NA

Note:

1. The calibration interval of the above test instruments is 12 months and the calibrations are traceable to NML/ROC and NIST/USA.
2. *The calibration interval of the above test instruments is 24 months and the calibrations are traceable to NML/ROC and NIST/USA.
Loop antenna was used for all emissions below 30 MHz.
3. The test was performed in 966 Chamber No. 3.
4. The FCC Site Registration No. is 147459
5. The CANADA Site Registration No. is 20331-1
6. Tested Date: Apr. 21 to 28, 2016

4.1.3 Test Procedure

- a. The EUT was placed on the top of a rotating table 0.8 meters (for below 1GHz) / 1.5 meters (for above 1GHz) above the ground at 3 meter chamber room for test. The table was rotated 360 degrees to determine the position of the highest radiation.
- b. The EUT was set 3 meters away from the interference-receiving antenna, which was mounted on the top of a variable-height antenna tower.
- c. The height of antenna is varied from one meter to four meters above the ground to determine the maximum value of the field strength. Both horizontal and vertical polarizations of the antenna are set to make the measurement.
- d. For each suspected emission, the EUT was arranged to its worst case and then the antenna was tuned to heights from 1 meter to 4 meters and the rotatable table was turned from 0 degrees to 360 degrees to find the maximum reading.
- e. The test-receiver system was set to quasi-peak detect function and specified bandwidth with maximum hold mode when the test frequency is below 1 GHz.
- f. The test-receiver system was set to peak and average detect function and specified bandwidth with maximum hold mode when the test frequency is above 1 GHz. If the peak reading value also meets average limit, measurement with the average detector is unnecessary.

Note:

1. The resolution bandwidth and video bandwidth of test receiver/spectrum analyzer is 120kHz for Quasi-peak detection (QP) at frequency below 1GHz.
2. The resolution bandwidth of test receiver/spectrum analyzer is 1 MHz and the video bandwidth is 3 MHz for Peak detection (PK) at frequency above 1GHz.
3. The resolution bandwidth of test receiver/spectrum analyzer is 1MHz and the video bandwidth is 3MHz for RMS Average (Duty cycle < 98%) for Average detection (AV) at frequency above 1GHz, then the measurement results was added to a correction factor ($10 \log(1/\text{duty cycle})$).
4. The resolution bandwidth of test receiver/spectrum analyzer is 1MHz and the video bandwidth is 10Hz (Duty cycle $\geq 98\%$) for Average detection (AV) at frequency above 1GHz.
5. All modes of operation were investigated and the worst-case emissions are reported.

4.1.4 Deviation from Test Standard

No deviation.

4.1.5 Test Setup

<Frequency Range below 1GHz>

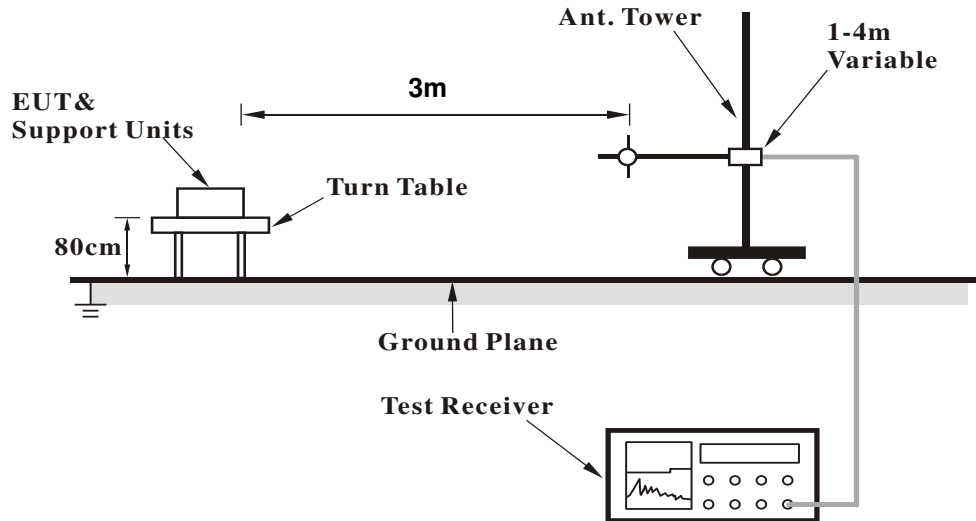

<Frequency Range above 1GHz>

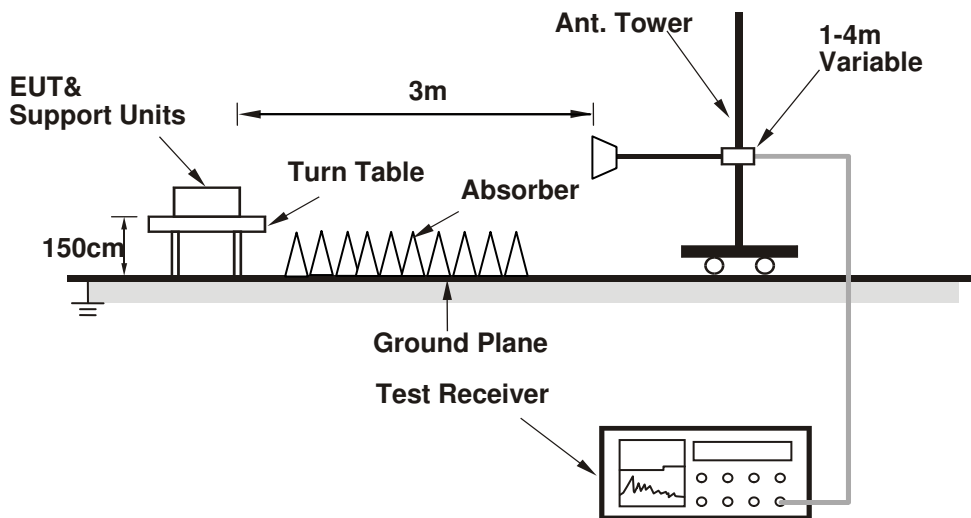

For the actual test configuration, please refer to the attached file (Test Setup Photo).

4.1.6 EUT Operating Condition

1. Connect the EUT with the support unit A (Notebook Computer) which is placed on test table.
2. The communication partner run test program "adb.exe [Android 4.4.2]" to enable EUT under transmission/receiving condition continuously at specific channel frequency.

4.1.7 Test Results (Bandedge)

1TX

Antenna Combination- WiFi- 1

802.11a

CHANNEL	TX Channel 36	DETECTOR FUNCTION	Peak (PK)
FREQUENCY RANGE	1GHz ~ 40GHz		Average (AV)

ANTENNA POLARITY & TEST DISTANCE: HORIZONTAL AT 3 M

NO.	FREQ. (MHz)	EMISSION LEVEL (dBuV/m)	LIMIT (dBuV/m)	MARGIN (dB)	ANTENNA HEIGHT (m)	TABLE ANGLE (Degree)	RAW VALUE (dBuV)	CORRECTION FACTOR (dB/m)
1	5150.00	61.6 PK	74.0	-12.4	1.74 H	266	58.62	2.98
2	5150.00	47.9 AV	54.0	-6.1	1.74 H	266	44.92	2.98
3	*5180.00	103.3 PK			1.74 H	266	100.24	3.06
4	*5180.00	94.1 AV			1.74 H	266	91.04	3.06

REMARKS:

1. Emission Level(dBuV/m) = Raw Value(dBuV) + Correction Factor(dB/m)
2. Correction Factor(dB/m) = Antenna Factor(dB/m) + Cable Factor(dB) – Pre-Amplifier Factor(dB)
3. The other emission levels were very low against the limit.
4. Margin value = Emission Level – Limit value
5. " * ": Fundamental frequency.

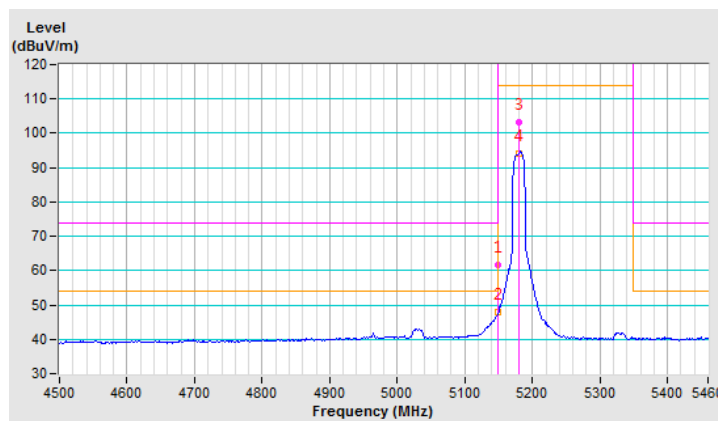

CHANNEL	TX Channel 36	DETECTOR FUNCTION	Peak (PK)
FREQUENCY RANGE	1GHz ~ 40GHz		Average (AV)

ANTENNA POLARITY & TEST DISTANCE: VERTICAL AT 3 M

NO.	FREQ. (MHz)	EMISSION LEVEL (dBuV/m)	LIMIT (dBuV/m)	MARGIN (dB)	ANTENNA HEIGHT (m)	TABLE ANGLE (Degree)	RAW VALUE (dBuV)	CORRECTION FACTOR (dB/m)
1	5150.00	68.5 PK	74.0	-5.5	1.03 V	290	65.52	2.98
2	5150.00	53.5 AV	54.0	-0.5	1.03 V	290	50.52	2.98
3	*5180.00	106.5 PK			1.03 V	290	103.44	3.06
4	*5180.00	98.4 AV			1.03 V	290	95.34	3.06

REMARKS:

1. Emission Level(dBuV/m) = Raw Value(dBuV) + Correction Factor(dB/m)
2. Correction Factor(dB/m) = Antenna Factor(dB/m) + Cable Factor(dB) – Pre-Amplifier Factor(dB)
3. The other emission levels were very low against the limit.
4. Margin value = Emission Level – Limit value
5. " * ": Fundamental frequency.

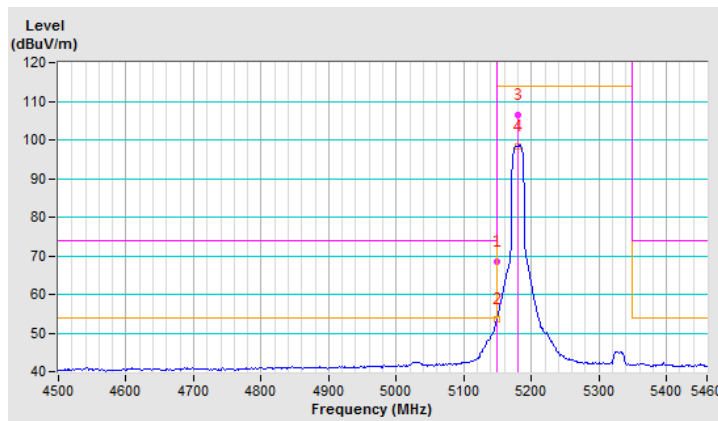

CHANNEL	TX Channel 40	DETECTOR FUNCTION	Peak (PK)
FREQUENCY RANGE	1GHz ~ 40GHz		Average (AV)

ANTENNA POLARITY & TEST DISTANCE: HORIZONTAL AT 3 M

NO.	FREQ. (MHz)	EMISSION LEVEL (dBuV/m)	LIMIT (dBuV/m)	MARGIN (dB)	ANTENNA HEIGHT (m)	TABLE ANGLE (Degree)	RAW VALUE (dBuV)	CORRECTION FACTOR (dB/m)
1	5150.00	63.9 PK	74.0	-10.1	3.28 H	266	60.92	2.98
2	5150.00	48.7 AV	54.0	-5.3	3.28 H	266	45.72	2.98
3	*5200.00	105.5 PK			3.28 H	266	102.40	3.10
4	*5200.00	96.2 AV			3.28 H	266	93.10	3.10

REMARKS:

1. Emission Level(dBuV/m) = Raw Value(dBuV) + Correction Factor(dB/m)
2. Correction Factor(dB/m) = Antenna Factor(dB/m) + Cable Factor(dB) – Pre-Amplifier Factor(dB)
3. The other emission levels were very low against the limit.
4. Margin value = Emission Level – Limit value
5. " * ": Fundamental frequency.

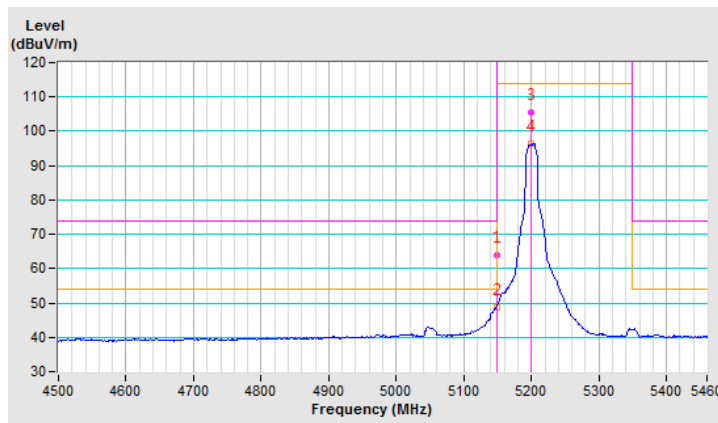

CHANNEL	TX Channel 40	DETECTOR FUNCTION	Peak (PK)
FREQUENCY RANGE	1GHz ~ 40GHz		Average (AV)

ANTENNA POLARITY & TEST DISTANCE: VERTICAL AT 3 M

NO.	FREQ. (MHz)	EMISSION LEVEL (dBuV/m)	LIMIT (dBuV/m)	MARGIN (dB)	ANTENNA HEIGHT (m)	TABLE ANGLE (Degree)	RAW VALUE (dBuV)	CORRECTION FACTOR (dB/m)
1	5150.00	69.6 PK	74.0	-4.4	1.00 V	280	66.62	2.98
2	5150.00	53.4 AV	54.0	-0.6	1.00 V	280	50.42	2.98
3	*5200.00	109.3 PK			1.00 V	280	106.20	3.10
4	*5200.00	99.9 AV			1.00 V	280	96.80	3.10

REMARKS:

1. Emission Level(dBuV/m) = Raw Value(dBuV) + Correction Factor(dB/m)
2. Correction Factor(dB/m) = Antenna Factor(dB/m) + Cable Factor(dB) – Pre-Amplifier Factor(dB)
3. The other emission levels were very low against the limit.
4. Margin value = Emission Level – Limit value
5. " * ": Fundamental frequency.

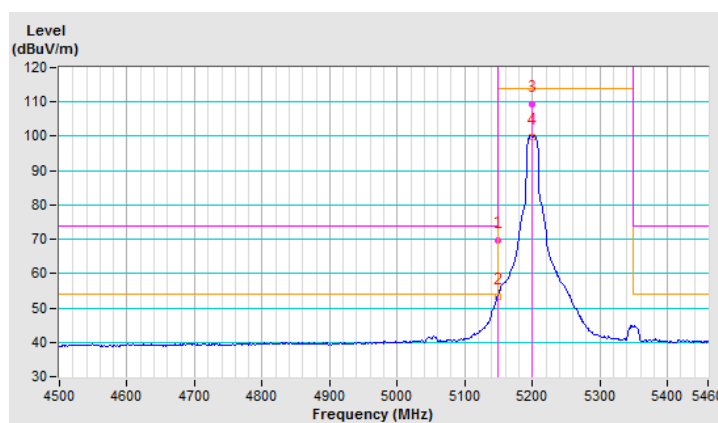

CHANNEL	TX Channel 48	DETECTOR FUNCTION	Peak (PK)
FREQUENCY RANGE	1GHz ~ 40GHz		Average (AV)

ANTENNA POLARITY & TEST DISTANCE: HORIZONTAL AT 3 M

NO.	FREQ. (MHz)	EMISSION LEVEL (dBuV/m)	LIMIT (dBuV/m)	MARGIN (dB)	ANTENNA HEIGHT (m)	TABLE ANGLE (Degree)	RAW VALUE (dBuV)	CORRECTION FACTOR (dB/m)
1	5150.00	51.3 PK	74.0	-22.7	2.33 H	300	48.32	2.98
2	5150.00	40.8 AV	54.0	-13.2	2.33 H	300	37.82	2.98
3	*5240.00	109.1 PK			2.33 H	300	105.89	3.21
4	*5240.00	99.7 AV			2.33 H	300	96.49	3.21
5	5390.00	54.2 PK	74.0	-19.8	2.33 H	300	50.57	3.63
6	5390.00	43.4 AV	54.0	-10.6	2.33 H	300	39.77	3.63

REMARKS:

1. Emission Level(dBuV/m) = Raw Value(dBuV) + Correction Factor(dB/m)
2. Correction Factor(dB/m) = Antenna Factor(dB/m) + Cable Factor(dB) – Pre-Amplifier Factor(dB)
3. The other emission levels were very low against the limit.
4. Margin value = Emission Level – Limit value
5. " * ": Fundamental frequency.

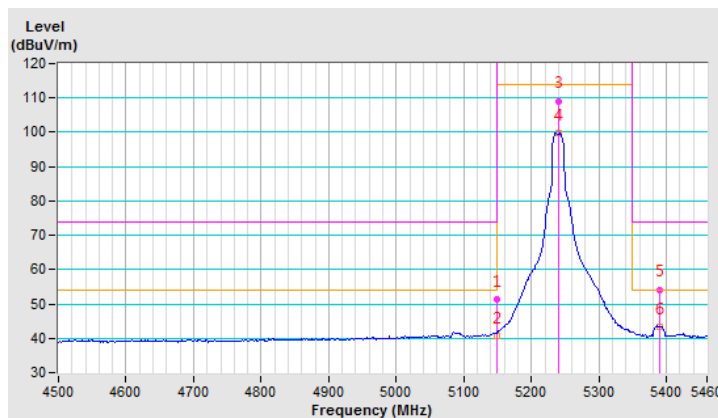

CHANNEL	TX Channel 48	DETECTOR FUNCTION	Peak (PK)
FREQUENCY RANGE	1GHz ~ 40GHz		Average (AV)

ANTENNA POLARITY & TEST DISTANCE: VERTICAL AT 3 M

NO.	FREQ. (MHz)	EMISSION LEVEL (dBuV/m)	LIMIT (dBuV/m)	MARGIN (dB)	ANTENNA HEIGHT (m)	TABLE ANGLE (Degree)	RAW VALUE (dBuV)	CORRECTION FACTOR (dB/m)
1	5150.00	55.0 PK	74.0	-19.0	1.00 V	292	52.02	2.98
2	5150.00	42.7 AV	54.0	-11.3	1.00 V	292	39.72	2.98
3	*5240.00	111.3 PK			1.00 V	292	108.09	3.21
4	*5240.00	101.6 AV			1.00 V	292	98.39	3.21
5	5390.00	54.2 PK	74.0	-19.8	1.00 V	292	50.57	3.63
6	5390.00	42.3 AV	54.0	-11.7	1.00 V	292	38.67	3.63

REMARKS:

1. Emission Level(dBuV/m) = Raw Value(dBuV) + Correction Factor(dB/m)
2. Correction Factor(dB/m) = Antenna Factor(dB/m) + Cable Factor(dB) – Pre-Amplifier Factor(dB)
3. The other emission levels were very low against the limit.
4. Margin value = Emission Level – Limit value
5. " * ": Fundamental frequency.

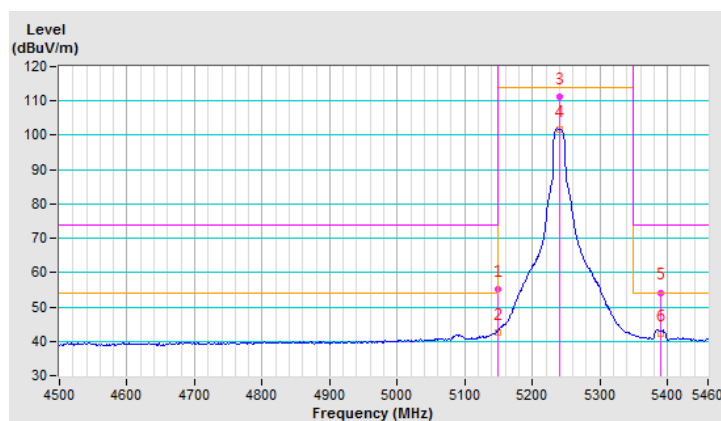

CHANNEL	TX Channel 52	DETECTOR FUNCTION	Peak (PK)
FREQUENCY RANGE	1GHz ~ 40GHz		Average (AV)

ANTENNA POLARITY & TEST DISTANCE: HORIZONTAL AT 3 M

NO.	FREQ. (MHz)	EMISSION LEVEL (dBuV/m)	LIMIT (dBuV/m)	MARGIN (dB)	ANTENNA HEIGHT (m)	TABLE ANGLE (Degree)	RAW VALUE (dBuV)	CORRECTION FACTOR (dB/m)
1	5114.00	51.2 PK	74.0	-22.8	2.31 H	300	48.30	2.90
2	5114.00	40.7 AV	54.0	-13.3	2.31 H	300	37.80	2.90
3	*5260.00	110.1 PK			2.31 H	300	106.84	3.26
4	*5260.00	100.1 AV			2.31 H	300	96.84	3.26
5	5406.00	57.7 PK	74.0	-16.3	2.31 H	300	54.03	3.67
6	5406.00	43.6 AV	54.0	-10.4	2.31 H	300	39.93	3.67

REMARKS:

1. Emission Level(dBuV/m) = Raw Value(dBuV) + Correction Factor(dB/m)
2. Correction Factor(dB/m) = Antenna Factor(dB/m) + Cable Factor(dB) – Pre-Amplifier Factor(dB)
3. The other emission levels were very low against the limit.
4. Margin value = Emission Level – Limit value
5. " * ": Fundamental frequency.

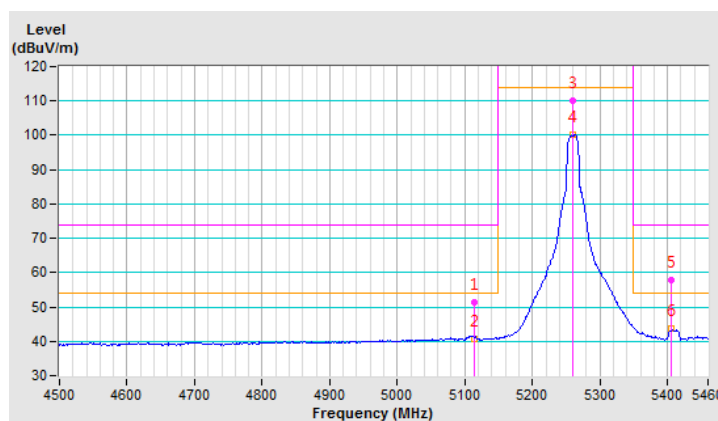

CHANNEL	TX Channel 52	DETECTOR FUNCTION	Peak (PK)
FREQUENCY RANGE	1GHz ~ 40GHz		Average (AV)

ANTENNA POLARITY & TEST DISTANCE: VERTICAL AT 3 M

NO.	FREQ. (MHz)	EMISSION LEVEL (dBuV/m)	LIMIT (dBuV/m)	MARGIN (dB)	ANTENNA HEIGHT (m)	TABLE ANGLE (Degree)	RAW VALUE (dBuV)	CORRECTION FACTOR (dB/m)
1	5114.00	50.8 PK	74.0	-23.2	1.00 V	298	47.90	2.90
2	5114.00	41.0 AV	54.0	-13.0	1.00 V	298	38.10	2.90
3	*5260.00	112.4 PK			1.00 V	298	109.14	3.26
4	*5260.00	102.7 AV			1.00 V	298	99.44	3.26
5	5406.00	59.8 PK	74.0	-14.2	1.00 V	298	56.13	3.67
6	5406.00	43.4 AV	54.0	-10.6	1.00 V	298	39.73	3.67

REMARKS:

1. Emission Level(dBuV/m) = Raw Value(dBuV) + Correction Factor(dB/m)
2. Correction Factor(dB/m) = Antenna Factor(dB/m) + Cable Factor(dB) – Pre-Amplifier Factor(dB)
3. The other emission levels were very low against the limit.
4. Margin value = Emission Level – Limit value
5. " * ": Fundamental frequency.

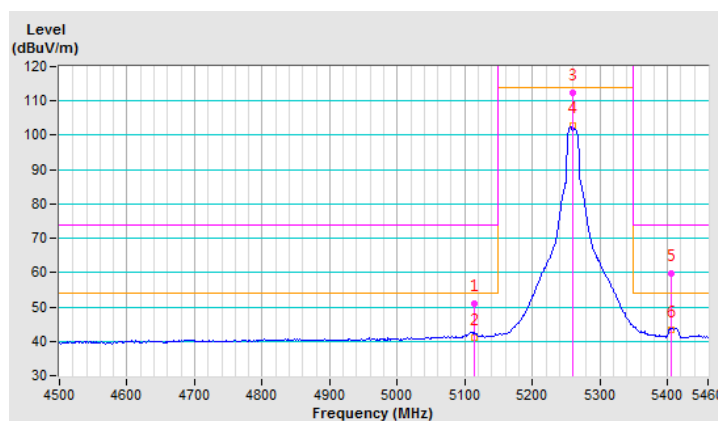

CHANNEL	TX Channel 60	DETECTOR FUNCTION	Peak (PK)
FREQUENCY RANGE	1GHz ~ 40GHz		Average (AV)

ANTENNA POLARITY & TEST DISTANCE: HORIZONTAL AT 3 M

NO.	FREQ. (MHz)	EMISSION LEVEL (dBuV/m)	LIMIT (dBuV/m)	MARGIN (dB)	ANTENNA HEIGHT (m)	TABLE ANGLE (Degree)	RAW VALUE (dBuV)	CORRECTION FACTOR (dB/m)
1	5150.00	51.1 PK	74.0	-22.9	2.32 H	298	48.12	2.98
2	5150.00	40.1 AV	54.0	-13.9	2.32 H	298	37.12	2.98
3	*5300.00	109.8 PK			2.32 H	298	106.43	3.37
4	*5300.00	100.4 AV			2.32 H	298	97.03	3.37
5	5350.00	65.4 PK	74.0	-8.6	2.32 H	298	61.89	3.51
6	5350.00	52.0 AV	54.0	-2.0	2.32 H	298	48.49	3.51

REMARKS:

1. Emission Level(dBuV/m) = Raw Value(dBuV) + Correction Factor(dB/m)
2. Correction Factor(dB/m) = Antenna Factor(dB/m) + Cable Factor(dB) – Pre-Amplifier Factor(dB)
3. The other emission levels were very low against the limit.
4. Margin value = Emission Level – Limit value
5. " * ": Fundamental frequency.

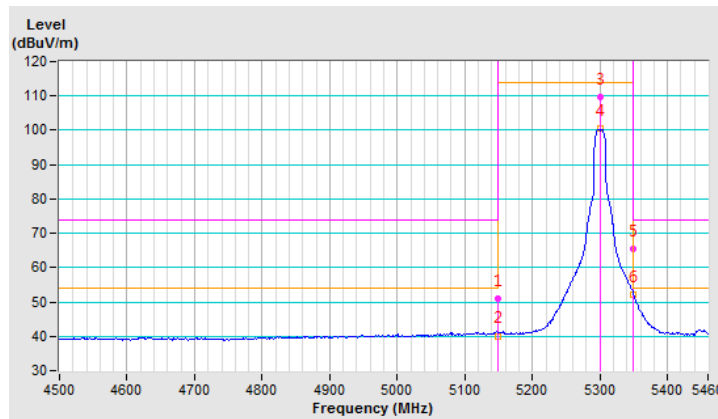

CHANNEL	TX Channel 60	DETECTOR FUNCTION	Peak (PK)
FREQUENCY RANGE	1GHz ~ 40GHz		Average (AV)

ANTENNA POLARITY & TEST DISTANCE: VERTICAL AT 3 M

NO.	FREQ. (MHz)	EMISSION LEVEL (dBuV/m)	LIMIT (dBuV/m)	MARGIN (dB)	ANTENNA HEIGHT (m)	TABLE ANGLE (Degree)	RAW VALUE (dBuV)	CORRECTION FACTOR (dB/m)
1	5150.00	52.5 PK	74.0	-21.5	1.00 V	294	49.52	2.98
2	5150.00	41.4 AV	54.0	-12.6	1.00 V	294	38.42	2.98
3	*5300.00	111.1 PK			1.00 V	294	107.73	3.37
4	*5300.00	101.5 AV			1.00 V	294	98.13	3.37
5	5350.00	67.0 PK	74.0	-7.0	1.00 V	294	63.49	3.51
6	5350.00	53.4 AV	54.0	-0.6	1.00 V	294	49.89	3.51

REMARKS:

1. Emission Level(dBuV/m) = Raw Value(dBuV) + Correction Factor(dB/m)
2. Correction Factor(dB/m) = Antenna Factor(dB/m) + Cable Factor(dB) – Pre-Amplifier Factor(dB)
3. The other emission levels were very low against the limit.
4. Margin value = Emission Level – Limit value
5. " * ": Fundamental frequency.

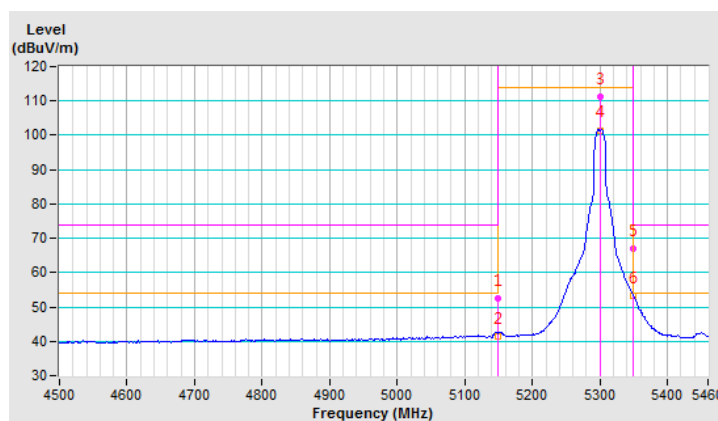

CHANNEL	TX Channel 64	DETECTOR FUNCTION	Peak (PK)
FREQUENCY RANGE	1GHz ~ 40GHz		Average (AV)

ANTENNA POLARITY & TEST DISTANCE: HORIZONTAL AT 3 M

NO.	FREQ. (MHz)	EMISSION LEVEL (dBuV/m)	LIMIT (dBuV/m)	MARGIN (dB)	ANTENNA HEIGHT (m)	TABLE ANGLE (Degree)	RAW VALUE (dBuV)	CORRECTION FACTOR (dB/m)
1	*5320.00	108.1 PK			2.40 H	300	104.67	3.43
2	*5320.00	98.8 AV			2.40 H	300	95.37	3.43
3	5350.00	67.5 PK	74.0	-6.5	2.40 H	300	63.99	3.51
4	5350.00	52.8 AV	54.0	-1.2	2.40 H	300	49.29	3.51

REMARKS:

1. Emission Level(dBuV/m) = Raw Value(dBuV) + Correction Factor(dB/m)
2. Correction Factor(dB/m) = Antenna Factor(dB/m) + Cable Factor(dB) – Pre-Amplifier Factor(dB)
3. The other emission levels were very low against the limit.
4. Margin value = Emission Level – Limit value
5. " * ": Fundamental frequency.

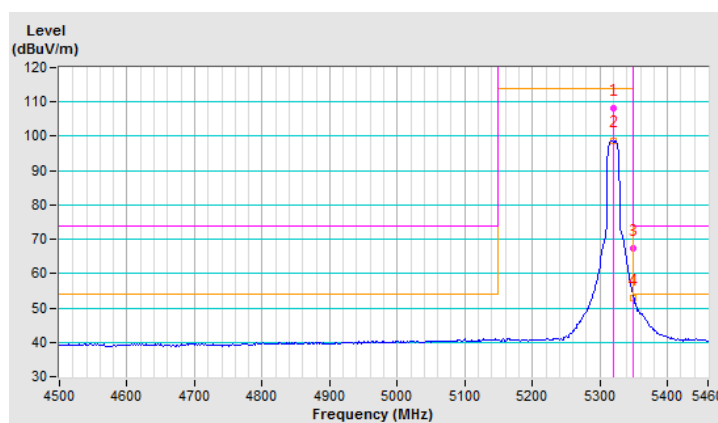

CHANNEL	TX Channel 64	DETECTOR FUNCTION	Peak (PK)
FREQUENCY RANGE	1GHz ~ 40GHz		Average (AV)

ANTENNA POLARITY & TEST DISTANCE: VERTICAL AT 3 M

NO.	FREQ. (MHz)	EMISSION LEVEL (dBuV/m)	LIMIT (dBuV/m)	MARGIN (dB)	ANTENNA HEIGHT (m)	TABLE ANGLE (Degree)	RAW VALUE (dBuV)	CORRECTION FACTOR (dB/m)
1	*5320.00	109.6 PK			1.00 V	297	106.17	3.43
2	*5320.00	99.5 AV			1.00 V	297	96.07	3.43
3	5350.00	70.3 PK	74.0	-3.7	1.00 V	297	66.79	3.51
4	5350.00	53.6 AV	54.0	-0.4	1.00 V	297	50.09	3.51

REMARKS:

1. Emission Level(dBuV/m) = Raw Value(dBuV) + Correction Factor(dB/m)
2. Correction Factor(dB/m) = Antenna Factor(dB/m) + Cable Factor(dB) – Pre-Amplifier Factor(dB)
3. The other emission levels were very low against the limit.
4. Margin value = Emission Level – Limit value
5. " * ": Fundamental frequency.

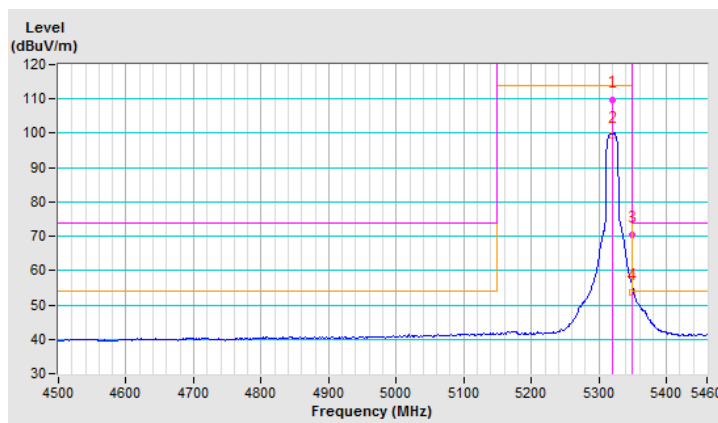

CHANNEL	TX Channel 100	DETECTOR FUNCTION	Peak (PK)
FREQUENCY RANGE	1GHz ~ 40GHz		Average (AV)

ANTENNA POLARITY & TEST DISTANCE: HORIZONTAL AT 3 M

NO.	FREQ. (MHz)	EMISSION LEVEL (dBuV/m)	LIMIT (dBuV/m)	MARGIN (dB)	ANTENNA HEIGHT (m)	TABLE ANGLE (Degree)	RAW VALUE (dBuV)	CORRECTION FACTOR (dB/m)
1	5460.00	64.2 PK	74.0	-9.8	2.59 H	292	60.46	3.74
2	5460.00	49.0 AV	54.0	-5.0	2.59 H	292	45.26	3.74
3	#5470.00	72.0 PK	74.0	-2.0	2.59 H	292	68.24	3.76
4	#5470.00	53.1 AV	54.0	-0.9	2.59 H	292	49.34	3.76
5	*5500.00	106.2 PK			2.59 H	292	102.41	3.79
6	*5500.00	97.2 AV			2.59 H	292	93.41	3.79

REMARKS:

1. Emission Level(dBuV/m) = Raw Value(dBuV) + Correction Factor(dB/m)
2. Correction Factor(dB/m) = Antenna Factor(dB/m) + Cable Factor(dB) – Pre-Amplifier Factor(dB)
3. The other emission levels were very low against the limit.
4. Margin value = Emission Level – Limit value
5. " * ": Fundamental frequency.
6. " # ": The radiated frequency is out of the restricted band.

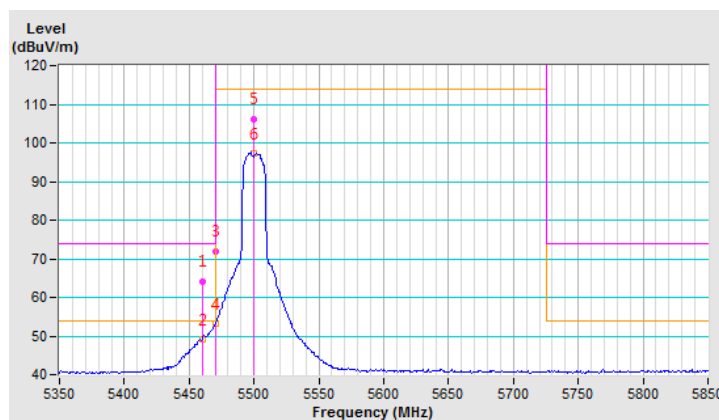

CHANNEL	TX Channel 100	DETECTOR FUNCTION	Peak (PK)
FREQUENCY RANGE	1GHz ~ 40GHz		Average (AV)

ANTENNA POLARITY & TEST DISTANCE: VERTICAL AT 3 M

NO.	FREQ. (MHz)	EMISSION LEVEL (dBuV/m)	LIMIT (dBuV/m)	MARGIN (dB)	ANTENNA HEIGHT (m)	TABLE ANGLE (Degree)	RAW VALUE (dBuV)	CORRECTION FACTOR (dB/m)
1	5460.00	64.2 PK	74.0	-9.8	1.00 V	332	60.46	3.74
2	5460.00	48.7 AV	54.0	-5.3	1.00 V	332	44.96	3.74
3	#5470.00	71.7 PK	74.0	-2.3	1.00 V	332	67.94	3.76
4	#5470.00	53.4 AV	54.0	-0.6	1.00 V	332	49.64	3.76
5	*5500.00	106.9 PK			1.00 V	332	103.11	3.79
6	*5500.00	96.7 AV			1.00 V	332	92.91	3.79

REMARKS:

1. Emission Level(dBuV/m) = Raw Value(dBuV) + Correction Factor(dB/m)
2. Correction Factor(dB/m) = Antenna Factor(dB/m) + Cable Factor(dB) – Pre-Amplifier Factor(dB)
3. The other emission levels were very low against the limit.
4. Margin value = Emission Level – Limit value
5. " * ": Fundamental frequency.
6. " # ": The radiated frequency is out of the restricted band.

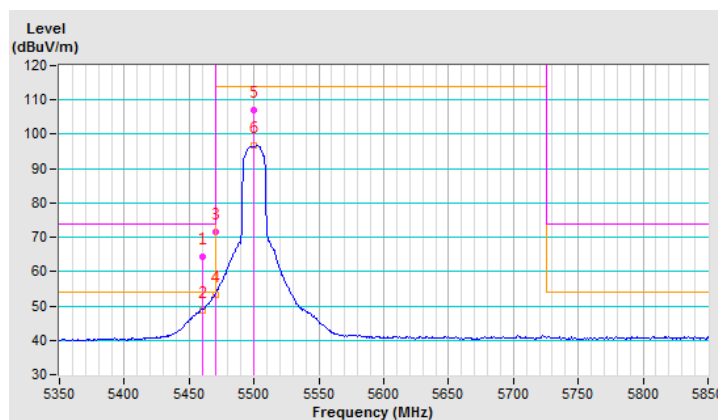

CHANNEL	TX Channel 116	DETECTOR FUNCTION	Peak (PK)
FREQUENCY RANGE	1GHz ~ 40GHz		Average (AV)

ANTENNA POLARITY & TEST DISTANCE: HORIZONTAL AT 3 M

NO.	FREQ. (MHz)	EMISSION LEVEL (dBuV/m)	LIMIT (dBuV/m)	MARGIN (dB)	ANTENNA HEIGHT (m)	TABLE ANGLE (Degree)	RAW VALUE (dBuV)	CORRECTION FACTOR (dB/m)
1	5373.00	54.6 PK	74.0	-19.4	2.46 H	302	51.01	3.59
2	5373.00	43.2 AV	54.0	-10.8	2.46 H	302	39.61	3.59
3	*5580.00	109.5 PK			2.46 H	302	105.59	3.91
4	*5580.00	100.6 AV			2.46 H	302	96.69	3.91
5	#5725.00	51.9 PK	74.0	-22.1	2.46 H	302	47.71	4.19
6	#5725.00	40.6 AV	54.0	-13.4	2.46 H	302	36.41	4.19

REMARKS:

1. Emission Level(dBuV/m) = Raw Value(dBuV) + Correction Factor(dB/m)
2. Correction Factor(dB/m) = Antenna Factor(dB/m) + Cable Factor(dB) – Pre-Amplifier Factor(dB)
3. The other emission levels were very low against the limit.
4. Margin value = Emission Level – Limit value
5. " * ": Fundamental frequency.
6. " # ": The radiated frequency is out of the restricted band.

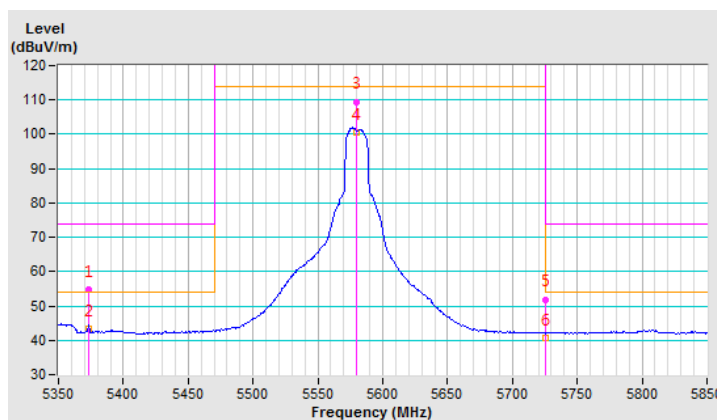

CHANNEL	TX Channel 116	DETECTOR FUNCTION	Peak (PK)
FREQUENCY RANGE	1GHz ~ 40GHz		Average (AV)

ANTENNA POLARITY & TEST DISTANCE: VERTICAL AT 3 M

NO.	FREQ. (MHz)	EMISSION LEVEL (dBuV/m)	LIMIT (dBuV/m)	MARGIN (dB)	ANTENNA HEIGHT (m)	TABLE ANGLE (Degree)	RAW VALUE (dBuV)	CORRECTION FACTOR (dB/m)
1	#5470.00	51.0 PK	74.0	-23.0	1.00 V	335	47.24	3.76
2	#5470.00	40.1 AV	54.0	-13.9	1.00 V	335	36.34	3.76
3	*5580.00	107.7 PK			1.00 V	335	103.79	3.91
4	*5580.00	98.4 AV			1.00 V	335	94.49	3.91
5	#5725.00	51.7 PK	74.0	-22.3	1.00 V	335	47.51	4.19
6	#5725.00	39.9 AV	54.0	-14.1	1.00 V	335	35.71	4.19

REMARKS:

1. Emission Level(dBuV/m) = Raw Value(dBuV) + Correction Factor(dB/m)
2. Correction Factor(dB/m) = Antenna Factor(dB/m) + Cable Factor(dB) – Pre-Amplifier Factor(dB)
3. The other emission levels were very low against the limit.
4. Margin value = Emission Level – Limit value
5. " * ": Fundamental frequency.
6. " # ": The radiated frequency is out of the restricted band.

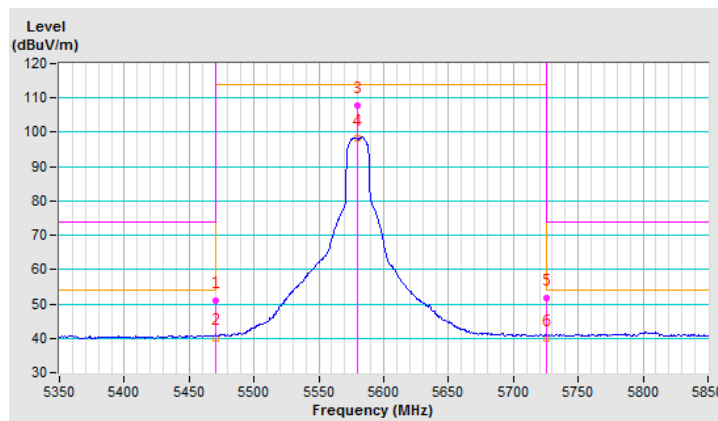

CHANNEL	TX Channel 140	DETECTOR FUNCTION	Peak (PK)
FREQUENCY RANGE	1GHz ~ 40GHz		Average (AV)

ANTENNA POLARITY & TEST DISTANCE: HORIZONTAL AT 3 M

NO.	FREQ. (MHz)	EMISSION LEVEL (dBuV/m)	LIMIT (dBuV/m)	MARGIN (dB)	ANTENNA HEIGHT (m)	TABLE ANGLE (Degree)	RAW VALUE (dBuV)	CORRECTION FACTOR (dB/m)
1	*5700.00	102.1 PK			2.31 H	301	97.91	4.19
2	*5700.00	94.0 AV			2.31 H	301	89.81	4.19
3	#5725.00	68.8 PK	74.0	-5.2	2.31 H	301	64.61	4.19
4	#5725.00	52.8 AV	54.0	-1.2	2.31 H	301	48.61	4.19

REMARKS:

1. Emission Level(dBuV/m) = Raw Value(dBuV) + Correction Factor(dB/m)
2. Correction Factor(dB/m) = Antenna Factor(dB/m) + Cable Factor(dB) – Pre-Amplifier Factor(dB)
3. The other emission levels were very low against the limit.
4. Margin value = Emission Level – Limit value
5. " * ": Fundamental frequency.
6. " # ": The radiated frequency is out of the restricted band.

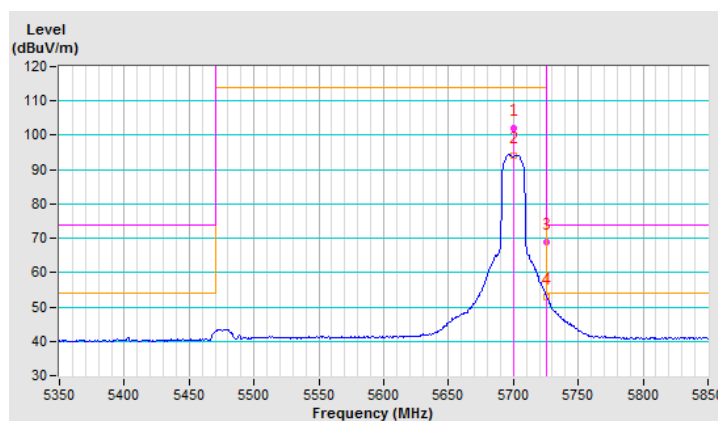

CHANNEL	TX Channel 140	DETECTOR FUNCTION	Peak (PK)
FREQUENCY RANGE	1GHz ~ 40GHz		Average (AV)

ANTENNA POLARITY & TEST DISTANCE: VERTICAL AT 3 M

NO.	FREQ. (MHz)	EMISSION LEVEL (dBuV/m)	LIMIT (dBuV/m)	MARGIN (dB)	ANTENNA HEIGHT (m)	TABLE ANGLE (Degree)	RAW VALUE (dBuV)	CORRECTION FACTOR (dB/m)
1	*5700.00	104.0 PK			1.02 V	337	99.81	4.19
2	*5700.00	94.8 AV			1.02 V	337	90.61	4.19
3	#5725.00	69.3 PK	74.0	-4.7	1.02 V	337	65.11	4.19
4	#5725.00	53.7 AV	54.0	-0.3	1.02 V	337	49.51	4.19

REMARKS:

1. Emission Level(dBuV/m) = Raw Value(dBuV) + Correction Factor(dB/m)
2. Correction Factor(dB/m) = Antenna Factor(dB/m) + Cable Factor(dB) – Pre-Amplifier Factor(dB)
3. The other emission levels were very low against the limit.
4. Margin value = Emission Level – Limit value
5. " * ": Fundamental frequency.
6. " # ": The radiated frequency is out of the restricted band.

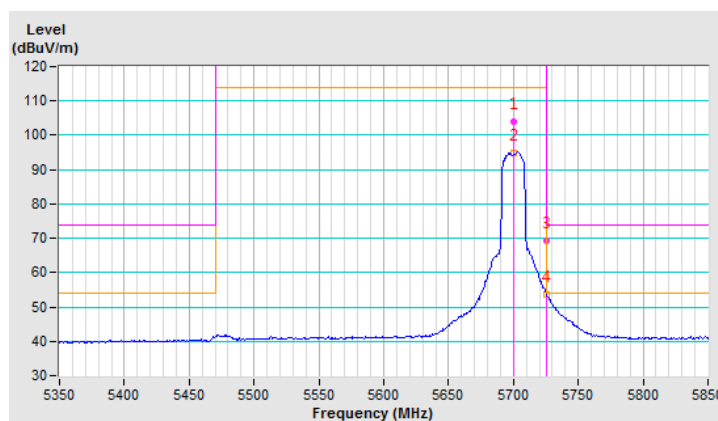

CHANNEL	TX Channel 149	DETECTOR FUNCTION	Peak (PK)
FREQUENCY RANGE	1GHz ~ 40GHz		Average (AV)

ANTENNA POLARITY & TEST DISTANCE: HORIZONTAL AT 3 M

NO.	FREQ. (MHz)	EMISSION LEVEL (dBuV/m)	LIMIT (dBuV/m)	MARGIN (dB)	ANTENNA HEIGHT (m)	TABLE ANGLE (Degree)	RAW VALUE (dBuV)	CORRECTION FACTOR (dB/m)
1	#5715.00	67.9 PK	74.0	-6.1	2.51 H	301	63.71	4.19
2	#5715.00	49.5 AV	54.0	-4.5	2.51 H	301	45.31	4.19
3	#5725.00	73.9 PK	78.2	-4.3	2.51 H	301	69.71	4.19
4	*5745.00	102.2 PK			2.51 H	301	98.01	4.19
5	*5745.00	94.0 AV			2.51 H	301	89.81	4.19

REMARKS:

1. Emission Level(dBuV/m) = Raw Value(dBuV) + Correction Factor(dB/m)
2. Correction Factor(dB/m) = Antenna Factor(dB/m) + Cable Factor(dB) – Pre-Amplifier Factor(dB)
3. The other emission levels were very low against the limit.
4. Margin value = Emission Level – Limit value
5. " * ": Fundamental frequency.
6. " # ": The radiated frequency is out of the restricted band.

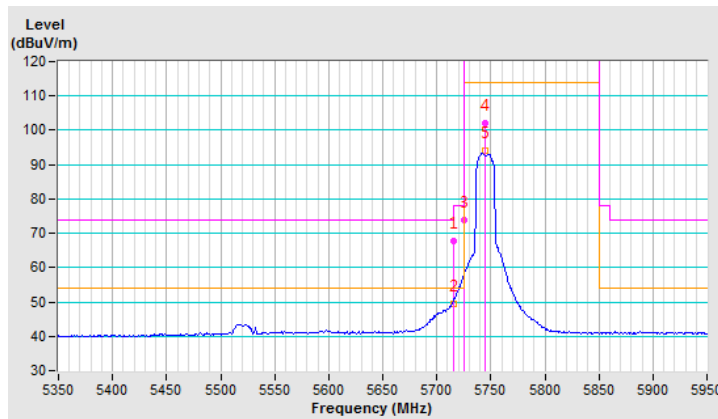

CHANNEL	TX Channel 149	DETECTOR FUNCTION	Peak (PK)
FREQUENCY RANGE	1GHz ~ 40GHz		Average (AV)

ANTENNA POLARITY & TEST DISTANCE: VERTICAL AT 3 M

NO.	FREQ. (MHz)	EMISSION LEVEL (dBuV/m)	LIMIT (dBuV/m)	MARGIN (dB)	ANTENNA HEIGHT (m)	TABLE ANGLE (Degree)	RAW VALUE (dBuV)	CORRECTION FACTOR (dB/m)
1	#5715.00	72.7 PK	74.0	-1.3	1.01 V	339	68.51	4.19
2	#5715.00	53.1 AV	54.0	-0.9	1.01 V	339	48.91	4.19
3	#5725.00	77.9 PK	78.2	-0.3	1.01 V	339	73.71	4.19
4	*5745.00	106.3 PK			1.01 V	339	102.11	4.19
5	*5745.00	96.2 AV			1.01 V	339	92.01	4.19

REMARKS:

1. Emission Level(dBuV/m) = Raw Value(dBuV) + Correction Factor(dB/m)
2. Correction Factor(dB/m) = Antenna Factor(dB/m) + Cable Factor(dB) – Pre-Amplifier Factor(dB)
3. The other emission levels were very low against the limit.
4. Margin value = Emission Level – Limit value
5. " * ": Fundamental frequency.
6. " # ": The radiated frequency is out of the restricted band.

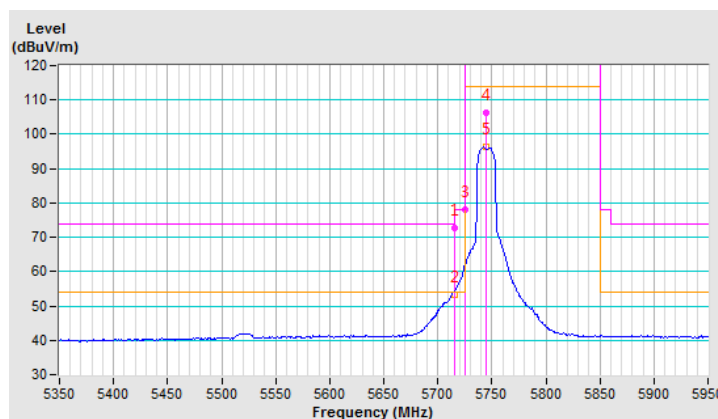

CHANNEL	TX Channel 157	DETECTOR FUNCTION	Peak (PK)
FREQUENCY RANGE	1GHz ~ 40GHz		Average (AV)

ANTENNA POLARITY & TEST DISTANCE: HORIZONTAL AT 3 M

NO.	FREQ. (MHz)	EMISSION LEVEL (dBuV/m)	LIMIT (dBuV/m)	MARGIN (dB)	ANTENNA HEIGHT (m)	TABLE ANGLE (Degree)	RAW VALUE (dBuV)	CORRECTION FACTOR (dB/m)
1	#5715.00	61.2 PK	74.0	-12.8	2.53 H	310	57.01	4.19
2	#5715.00	45.6 AV	54.0	-8.4	2.53 H	310	41.41	4.19
3	#5725.00	65.5 PK	78.2	-12.7	2.53 H	310	61.31	4.19
4	*5785.00	106.1 PK			2.53 H	310	101.92	4.18
5	*5785.00	96.0 AV			2.53 H	310	91.82	4.18
6	#5850.00	61.9 PK	78.2	-16.3	2.53 H	310	57.65	4.25
7	#5860.00	57.4 PK	74.0	-16.6	2.53 H	310	53.14	4.26
8	#5860.00	43.5 AV	54.0	-10.5	2.53 H	310	39.24	4.26

REMARKS:

1. Emission Level(dBuV/m) = Raw Value(dBuV) + Correction Factor(dB/m)
2. Correction Factor(dB/m) = Antenna Factor(dB/m) + Cable Factor(dB) – Pre-Amplifier Factor(dB)
3. The other emission levels were very low against the limit.
4. Margin value = Emission Level – Limit value
5. " * ": Fundamental frequency.
6. " # ": The radiated frequency is out of the restricted band.

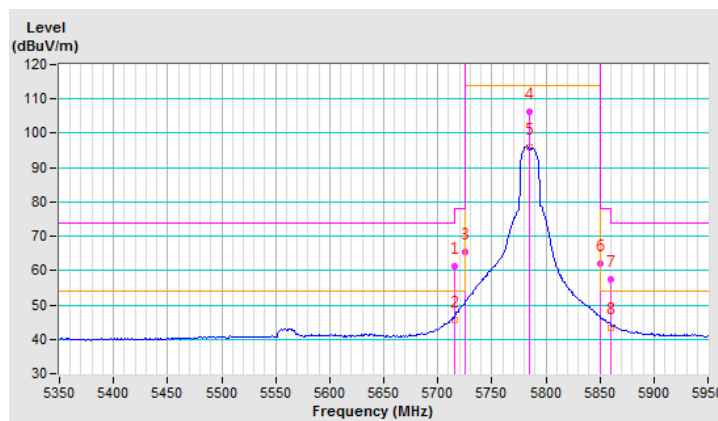

CHANNEL	TX Channel 157	DETECTOR FUNCTION	Peak (PK)
FREQUENCY RANGE	1GHz ~ 40GHz		Average (AV)

ANTENNA POLARITY & TEST DISTANCE: VERTICAL AT 3 M

NO.	FREQ. (MHz)	EMISSION LEVEL (dBuV/m)	LIMIT (dBuV/m)	MARGIN (dB)	ANTENNA HEIGHT (m)	TABLE ANGLE (Degree)	RAW VALUE (dBuV)	CORRECTION FACTOR (dB/m)
1	#5715.00	61.3 PK	74.0	-12.7	1.00 V	344	57.11	4.19
2	#5715.00	47.3 AV	54.0	-6.7	1.00 V	344	43.11	4.19
3	#5725.00	67.6 PK	78.2	-10.6	1.00 V	344	63.41	4.19
4	*5785.00	108.3 PK			1.00 V	344	104.12	4.18
5	*5785.00	99.2 AV			1.00 V	344	95.02	4.18
6	#5850.00	64.8 PK	78.2	-13.4	1.00 V	344	60.55	4.25
7	#5860.00	60.2 PK	74.0	-13.8	1.00 V	344	55.94	4.26
8	#5860.00	46.2 AV	54.0	-7.8	1.00 V	344	41.94	4.26

REMARKS:

1. Emission Level(dBuV/m) = Raw Value(dBuV) + Correction Factor(dB/m)
2. Correction Factor(dB/m) = Antenna Factor(dB/m) + Cable Factor(dB) – Pre-Amplifier Factor(dB)
3. The other emission levels were very low against the limit.
4. Margin value = Emission Level – Limit value
5. " * ": Fundamental frequency.
6. " # ": The radiated frequency is out of the restricted band.

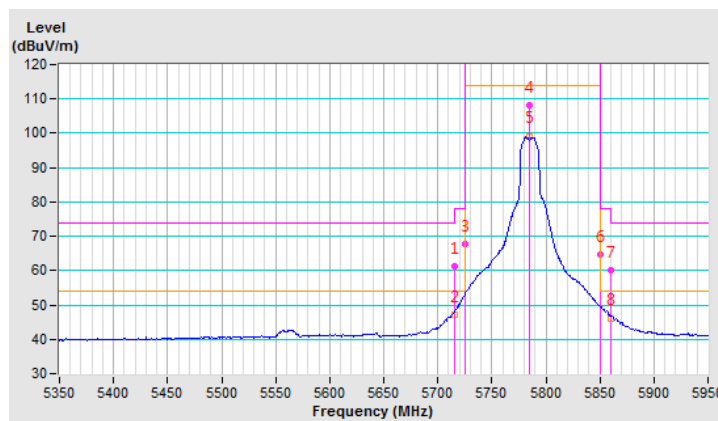

CHANNEL	TX Channel 165	DETECTOR FUNCTION	Peak (PK)
FREQUENCY RANGE	1GHz ~ 40GHz		Average (AV)

ANTENNA POLARITY & TEST DISTANCE: HORIZONTAL AT 3 M

NO.	FREQ. (MHz)	EMISSION LEVEL (dBuV/m)	LIMIT (dBuV/m)	MARGIN (dB)	ANTENNA HEIGHT (m)	TABLE ANGLE (Degree)	RAW VALUE (dBuV)	CORRECTION FACTOR (dB/m)
1	*5825.00	103.2 PK			2.51 H	304	98.98	4.22
2	*5825.00	94.3 AV			2.51 H	304	90.08	4.22
3	#5850.00	70.3 PK	78.2	-7.9	2.51 H	304	66.05	4.25
4	#5860.00	63.9 PK	74.0	-10.1	2.51 H	304	59.64	4.26
5	#5860.00	49.7 AV	54.0	-4.3	2.51 H	304	45.44	4.26

REMARKS:

1. Emission Level(dBuV/m) = Raw Value(dBuV) + Correction Factor(dB/m)
2. Correction Factor(dB/m) = Antenna Factor(dB/m) + Cable Factor(dB) – Pre-Amplifier Factor(dB)
3. The other emission levels were very low against the limit.
4. Margin value = Emission Level – Limit value
5. " * ": Fundamental frequency.
6. " # ": The radiated frequency is out of the restricted band.

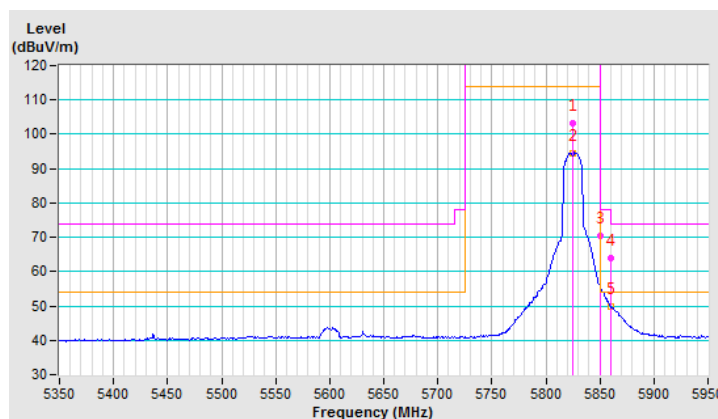

CHANNEL	TX Channel 165	DETECTOR FUNCTION	Peak (PK)
FREQUENCY RANGE	1GHz ~ 40GHz		Average (AV)

ANTENNA POLARITY & TEST DISTANCE: VERTICAL AT 3 M

NO.	FREQ. (MHz)	EMISSION LEVEL (dBuV/m)	LIMIT (dBuV/m)	MARGIN (dB)	ANTENNA HEIGHT (m)	TABLE ANGLE (Degree)	RAW VALUE (dBuV)	CORRECTION FACTOR (dB/m)
1	*5825.00	107.4 PK			1.00 V	346	103.18	4.22
2	*5825.00	97.1 AV			1.00 V	346	92.88	4.22
3	#5850.00	72.2 PK	78.2	-6.0	1.00 V	346	67.95	4.25
4	#5860.00	68.8 PK	74.0	-5.2	1.00 V	346	64.54	4.26
5	#5860.00	53.6 AV	54.0	-0.4	1.00 V	346	49.34	4.26

REMARKS:

1. Emission Level(dBuV/m) = Raw Value(dBuV) + Correction Factor(dB/m)
2. Correction Factor(dB/m) = Antenna Factor(dB/m) + Cable Factor(dB) – Pre-Amplifier Factor(dB)
3. The other emission levels were very low against the limit.
4. Margin value = Emission Level – Limit value
5. " * ": Fundamental frequency.
6. " # ": The radiated frequency is out of the restricted band.

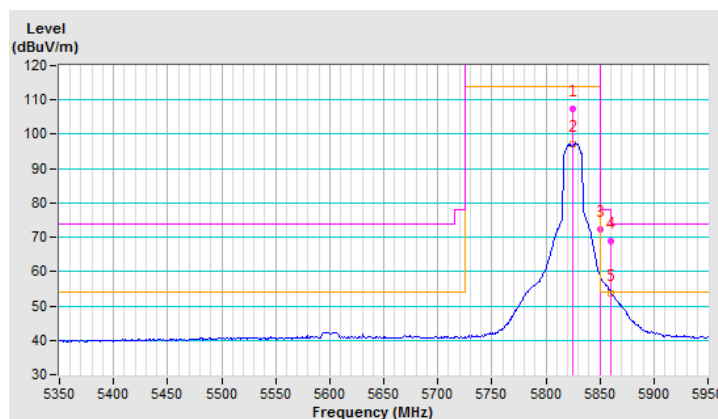

802.11n (20MHz)

CHANNEL	TX Channel 36	DETECTOR FUNCTION	Peak (PK)
FREQUENCY RANGE	1GHz ~ 40GHz		Average (AV)

ANTENNA POLARITY & TEST DISTANCE: HORIZONTAL AT 3 M								
NO.	FREQ. (MHz)	EMISSION LEVEL (dBuV/m)	LIMIT (dBuV/m)	MARGIN (dB)	ANTENNA HEIGHT (m)	TABLE ANGLE (Degree)	RAW VALUE (dBuV)	CORRECTION FACTOR (dB/m)
1	5150.00	65.9 PK	74.0	-8.1	1.73 H	266	62.92	2.98
2	5150.00	50.1 AV	54.0	-3.9	1.73 H	266	47.12	2.98
3	*5180.00	103.7 PK			1.73 H	266	100.64	3.06
4	*5180.00	94.2 AV			1.73 H	266	91.14	3.06

REMARKS:

1. Emission Level(dBuV/m) = Raw Value(dBuV) + Correction Factor(dB/m)
2. Correction Factor(dB/m) = Antenna Factor(dB/m) + Cable Factor(dB) – Pre-Amplifier Factor(dB)
3. The other emission levels were very low against the limit.
4. Margin value = Emission Level – Limit value
5. " * ": Fundamental frequency.

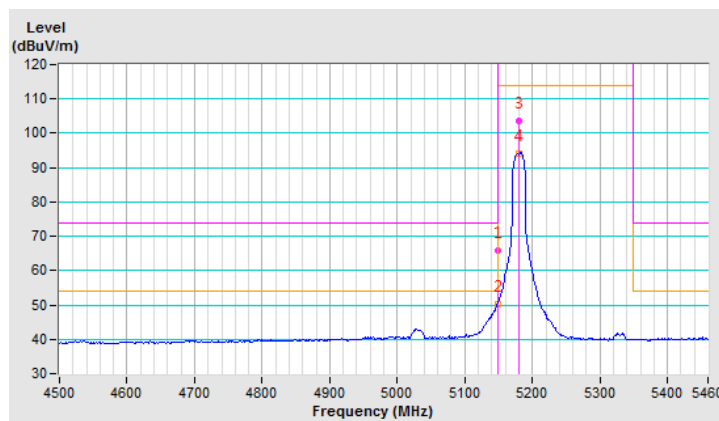

CHANNEL	TX Channel 36	DETECTOR FUNCTION	Peak (PK)
FREQUENCY RANGE	1GHz ~ 40GHz		Average (AV)

ANTENNA POLARITY & TEST DISTANCE: VERTICAL AT 3 M

NO.	FREQ. (MHz)	EMISSION LEVEL (dBuV/m)	LIMIT (dBuV/m)	MARGIN (dB)	ANTENNA HEIGHT (m)	TABLE ANGLE (Degree)	RAW VALUE (dBuV)	CORRECTION FACTOR (dB/m)
1	5150.00	69.4 PK	74.0	-4.6	1.00 V	298	66.42	2.98
2	5150.00	53.1 AV	54.0	-0.9	1.00 V	298	50.12	2.98
3	*5180.00	106.6 PK			1.00 V	298	103.54	3.06
4	*5180.00	97.1 AV			1.00 V	298	94.04	3.06

REMARKS:

1. Emission Level(dBuV/m) = Raw Value(dBuV) + Correction Factor(dB/m)
2. Correction Factor(dB/m) = Antenna Factor(dB/m) + Cable Factor(dB) – Pre-Amplifier Factor(dB)
3. The other emission levels were very low against the limit.
4. Margin value = Emission Level – Limit value
5. " * ": Fundamental frequency.

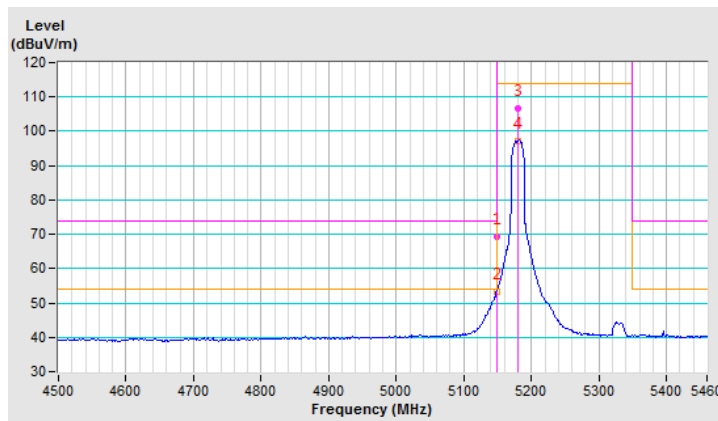

CHANNEL	TX Channel 40	DETECTOR FUNCTION	Peak (PK)
FREQUENCY RANGE	1GHz ~ 40GHz		Average (AV)

ANTENNA POLARITY & TEST DISTANCE: HORIZONTAL AT 3 M

NO.	FREQ. (MHz)	EMISSION LEVEL (dBuV/m)	LIMIT (dBuV/m)	MARGIN (dB)	ANTENNA HEIGHT (m)	TABLE ANGLE (Degree)	RAW VALUE (dBuV)	CORRECTION FACTOR (dB/m)
1	5150.00	63.4 PK	74.0	-10.6	1.34 H	266	60.42	2.98
2	5150.00	50.2 AV	54.0	-3.8	1.34 H	266	47.22	2.98
3	*5200.00	104.3 PK			1.34 H	266	101.20	3.10
4	*5200.00	95.2 AV			1.34 H	266	92.10	3.10
5	5350.00	51.4 PK	74.0	-22.6	1.34 H	266	47.89	3.51
6	5350.00	41.5 AV	54.0	-12.5	1.34 H	266	37.99	3.51

REMARKS:

1. Emission Level(dBuV/m) = Raw Value(dBuV) + Correction Factor(dB/m)
2. Correction Factor(dB/m) = Antenna Factor(dB/m) + Cable Factor(dB) – Pre-Amplifier Factor(dB)
3. The other emission levels were very low against the limit.
4. Margin value = Emission Level – Limit value
5. " * ": Fundamental frequency.

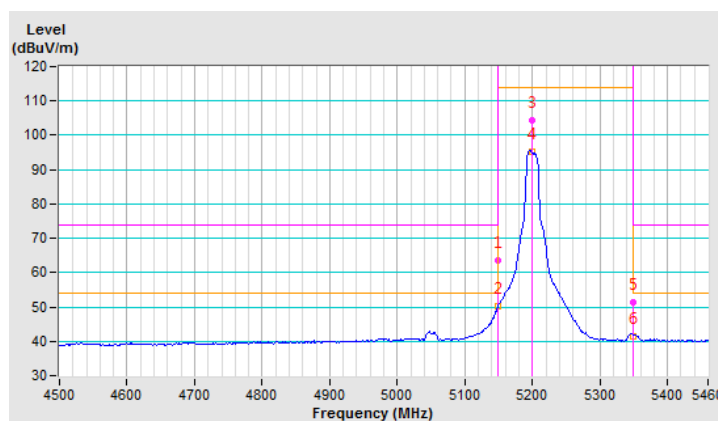

CHANNEL	TX Channel 40	DETECTOR FUNCTION	Peak (PK)
FREQUENCY RANGE	1GHz ~ 40GHz		Average (AV)

ANTENNA POLARITY & TEST DISTANCE: VERTICAL AT 3 M

NO.	FREQ. (MHz)	EMISSION LEVEL (dBuV/m)	LIMIT (dBuV/m)	MARGIN (dB)	ANTENNA HEIGHT (m)	TABLE ANGLE (Degree)	RAW VALUE (dBuV)	CORRECTION FACTOR (dB/m)
1	5150.00	69.5 PK	74.0	-4.5	1.00 V	290	66.52	2.98
2	5150.00	53.5 AV	54.0	-0.5	1.00 V	290	50.52	2.98
3	*5200.00	109.9 PK			1.00 V	290	106.80	3.10
4	*5200.00	100.5 AV			1.00 V	290	97.40	3.10
5	5350.00	53.6 PK	74.0	-20.4	1.00 V	290	50.09	3.51
6	5350.00	43.8 AV	54.0	-10.2	1.00 V	290	40.29	3.51

REMARKS:

1. Emission Level(dBuV/m) = Raw Value(dBuV) + Correction Factor(dB/m)
2. Correction Factor(dB/m) = Antenna Factor(dB/m) + Cable Factor(dB) – Pre-Amplifier Factor(dB)
3. The other emission levels were very low against the limit.
4. Margin value = Emission Level – Limit value
5. " * ": Fundamental frequency.

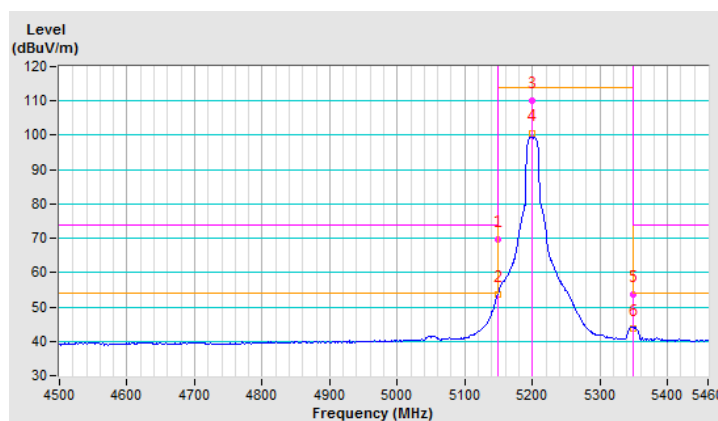

CHANNEL	TX Channel 48	DETECTOR FUNCTION	Peak (PK)
FREQUENCY RANGE	1GHz ~ 40GHz		Average (AV)

ANTENNA POLARITY & TEST DISTANCE: HORIZONTAL AT 3 M

NO.	FREQ. (MHz)	EMISSION LEVEL (dBuV/m)	LIMIT (dBuV/m)	MARGIN (dB)	ANTENNA HEIGHT (m)	TABLE ANGLE (Degree)	RAW VALUE (dBuV)	CORRECTION FACTOR (dB/m)
1	5150.00	51.7 PK	74.0	-22.3	3.14 H	272	48.72	2.98
2	5150.00	41.2 AV	54.0	-12.8	3.14 H	272	38.22	2.98
3	*5240.00	108.3 PK			3.14 H	272	105.09	3.21
4	*5240.00	98.7 AV			3.14 H	272	95.49	3.21
5	5390.00	52.5 PK	74.0	-21.5	3.14 H	272	48.87	3.63
6	5390.00	42.5 AV	54.0	-11.5	3.14 H	272	38.87	3.63

REMARKS:

1. Emission Level(dBuV/m) = Raw Value(dBuV) + Correction Factor(dB/m)
2. Correction Factor(dB/m) = Antenna Factor(dB/m) + Cable Factor(dB) – Pre-Amplifier Factor(dB)
3. The other emission levels were very low against the limit.
4. Margin value = Emission Level – Limit value
5. " * ": Fundamental frequency.

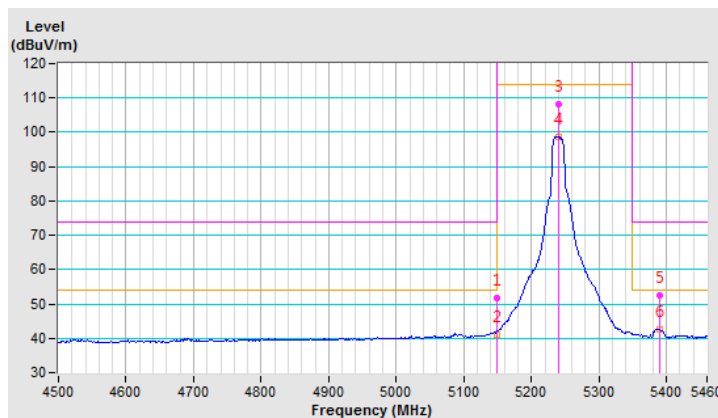

CHANNEL	TX Channel 48	DETECTOR FUNCTION	Peak (PK)
FREQUENCY RANGE	1GHz ~ 40GHz		Average (AV)

ANTENNA POLARITY & TEST DISTANCE: VERTICAL AT 3 M

NO.	FREQ. (MHz)	EMISSION LEVEL (dBuV/m)	LIMIT (dBuV/m)	MARGIN (dB)	ANTENNA HEIGHT (m)	TABLE ANGLE (Degree)	RAW VALUE (dBuV)	CORRECTION FACTOR (dB/m)
1	5150.00	57.4 PK	74.0	-16.6	1.00 V	290	54.42	2.98
2	5150.00	43.2 AV	54.0	-10.8	1.00 V	290	40.22	2.98
3	*5240.00	111.0 PK			1.00 V	290	107.79	3.21
4	*5240.00	101.5 AV			1.00 V	290	98.29	3.21
5	5390.00	54.4 PK	74.0	-19.6	1.00 V	290	50.77	3.63
6	5390.00	42.8 AV	54.0	-11.2	1.00 V	290	39.17	3.63

REMARKS:

1. Emission Level(dBuV/m) = Raw Value(dBuV) + Correction Factor(dB/m)
2. Correction Factor(dB/m) = Antenna Factor(dB/m) + Cable Factor(dB) – Pre-Amplifier Factor(dB)
3. The other emission levels were very low against the limit.
4. Margin value = Emission Level – Limit value
5. " * ": Fundamental frequency.

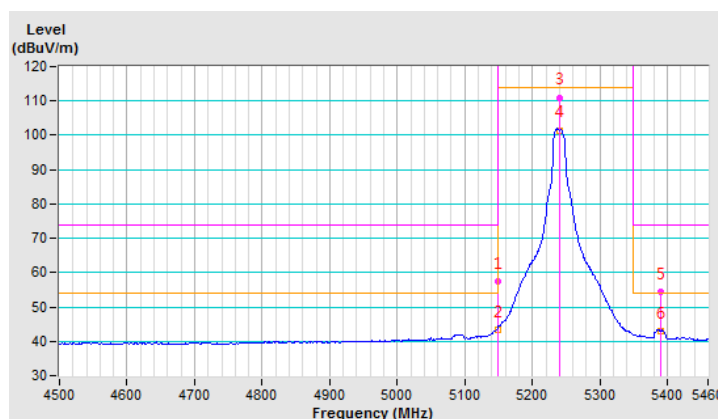

CHANNEL	TX Channel 52	DETECTOR FUNCTION	Peak (PK)
FREQUENCY RANGE	1GHz ~ 40GHz		Average (AV)

ANTENNA POLARITY & TEST DISTANCE: HORIZONTAL AT 3 M

NO.	FREQ. (MHz)	EMISSION LEVEL (dBuV/m)	LIMIT (dBuV/m)	MARGIN (dB)	ANTENNA HEIGHT (m)	TABLE ANGLE (Degree)	RAW VALUE (dBuV)	CORRECTION FACTOR (dB/m)
1	5150.00	50.8 PK	74.0	-23.2	3.13 H	273	47.82	2.98
2	5150.00	40.6 AV	54.0	-13.4	3.13 H	273	37.62	2.98
3	*5260.00	109.9 PK			3.13 H	273	106.64	3.26
4	*5260.00	100.3 AV			3.13 H	273	97.04	3.26
5	5350.00	57.2 PK	74.0	-16.8	3.13 H	273	53.69	3.51
6	5350.00	42.8 AV	54.0	-11.2	3.13 H	273	39.29	3.51

REMARKS:

1. Emission Level(dBuV/m) = Raw Value(dBuV) + Correction Factor(dB/m)
2. Correction Factor(dB/m) = Antenna Factor(dB/m) + Cable Factor(dB) – Pre-Amplifier Factor(dB)
3. The other emission levels were very low against the limit.
4. Margin value = Emission Level – Limit value
5. " * ": Fundamental frequency.

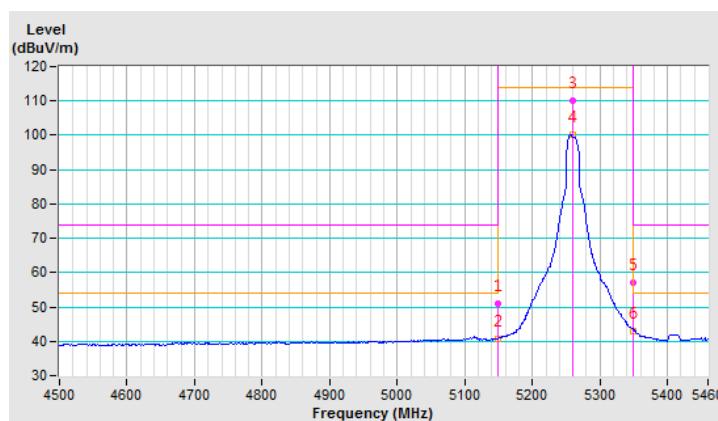

CHANNEL	TX Channel 52	DETECTOR FUNCTION	Peak (PK)
FREQUENCY RANGE	1GHz ~ 40GHz		Average (AV)

ANTENNA POLARITY & TEST DISTANCE: VERTICAL AT 3 M

NO.	FREQ. (MHz)	EMISSION LEVEL (dBuV/m)	LIMIT (dBuV/m)	MARGIN (dB)	ANTENNA HEIGHT (m)	TABLE ANGLE (Degree)	RAW VALUE (dBuV)	CORRECTION FACTOR (dB/m)
1	5150.00	51.9 PK	74.0	-22.1	1.00 V	297	48.92	2.98
2	5150.00	41.2 AV	54.0	-12.8	1.00 V	297	38.22	2.98
3	*5260.00	111.9 PK			1.00 V	297	108.64	3.26
4	*5260.00	102.3 AV			1.00 V	297	99.04	3.26
5	5350.00	58.5 PK	74.0	-15.5	1.00 V	297	54.99	3.51
6	5350.00	45.2 AV	54.0	-8.8	1.00 V	297	41.69	3.51

REMARKS:

1. Emission Level(dBuV/m) = Raw Value(dBuV) + Correction Factor(dB/m)
2. Correction Factor(dB/m) = Antenna Factor(dB/m) + Cable Factor(dB) – Pre-Amplifier Factor(dB)
3. The other emission levels were very low against the limit.
4. Margin value = Emission Level – Limit value
5. " * ": Fundamental frequency.

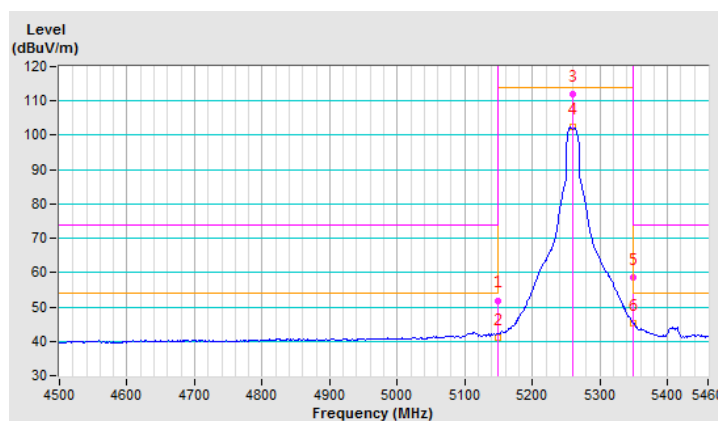

CHANNEL	TX Channel 60	DETECTOR FUNCTION	Peak (PK)
FREQUENCY RANGE	1GHz ~ 40GHz		Average (AV)

ANTENNA POLARITY & TEST DISTANCE: HORIZONTAL AT 3 M

NO.	FREQ. (MHz)	EMISSION LEVEL (dBuV/m)	LIMIT (dBuV/m)	MARGIN (dB)	ANTENNA HEIGHT (m)	TABLE ANGLE (Degree)	RAW VALUE (dBuV)	CORRECTION FACTOR (dB/m)
1	5150.00	51.1 PK	74.0	-22.9	2.48 H	279	48.12	2.98
2	5150.00	40.2 AV	54.0	-13.8	2.48 H	279	37.22	2.98
3	*5300.00	107.2 PK			2.48 H	279	103.83	3.37
4	*5300.00	98.6 AV			2.48 H	279	95.23	3.37
5	5350.00	62.1 PK	74.0	-11.9	2.48 H	279	58.59	3.51
6	5350.00	49.3 AV	54.0	-4.7	2.48 H	279	45.79	3.51

REMARKS:

1. Emission Level(dBuV/m) = Raw Value(dBuV) + Correction Factor(dB/m)
2. Correction Factor(dB/m) = Antenna Factor(dB/m) + Cable Factor(dB) – Pre-Amplifier Factor(dB)
3. The other emission levels were very low against the limit.
4. Margin value = Emission Level – Limit value
5. " * ": Fundamental frequency.

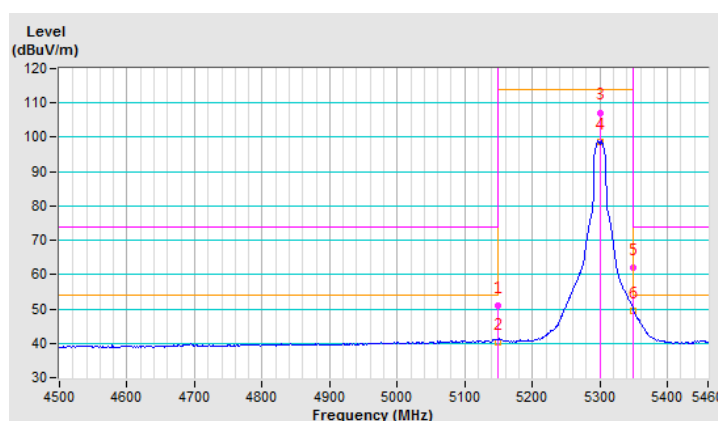

CHANNEL	TX Channel 60	DETECTOR FUNCTION	Peak (PK)
FREQUENCY RANGE	1GHz ~ 40GHz		Average (AV)

ANTENNA POLARITY & TEST DISTANCE: VERTICAL AT 3 M

NO.	FREQ. (MHz)	EMISSION LEVEL (dBuV/m)	LIMIT (dBuV/m)	MARGIN (dB)	ANTENNA HEIGHT (m)	TABLE ANGLE (Degree)	RAW VALUE (dBuV)	CORRECTION FACTOR (dB/m)
1	5150.00	51.8 PK	74.0	-22.2	1.00 V	299	48.82	2.98
2	5150.00	41.1 AV	54.0	-12.9	1.00 V	299	38.12	2.98
3	*5300.00	111.1 PK			1.00 V	299	107.73	3.37
4	*5300.00	101.3 AV			1.00 V	299	97.93	3.37
5	5350.00	66.4 PK	74.0	-7.6	1.00 V	299	62.89	3.51
6	5350.00	53.9 AV	54.0	-0.1	1.00 V	299	50.39	3.51

REMARKS:

1. Emission Level(dBuV/m) = Raw Value(dBuV) + Correction Factor(dB/m)
2. Correction Factor(dB/m) = Antenna Factor(dB/m) + Cable Factor(dB) – Pre-Amplifier Factor(dB)
3. The other emission levels were very low against the limit.
4. Margin value = Emission Level – Limit value
5. " * ": Fundamental frequency.

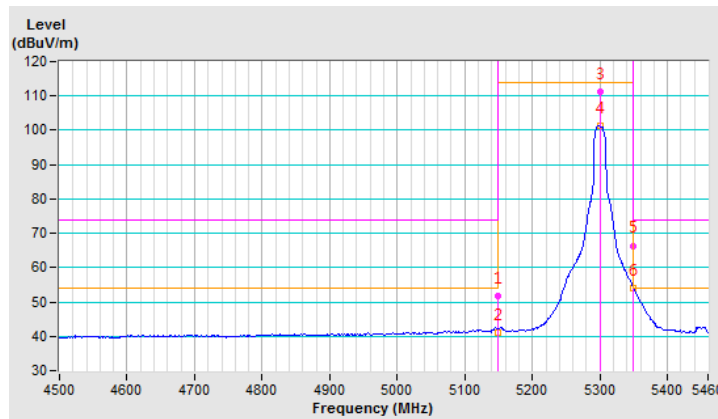

CHANNEL	TX Channel 64	DETECTOR FUNCTION	Peak (PK)
FREQUENCY RANGE	1GHz ~ 40GHz		Average (AV)

ANTENNA POLARITY & TEST DISTANCE: HORIZONTAL AT 3 M

NO.	FREQ. (MHz)	EMISSION LEVEL (dBuV/m)	LIMIT (dBuV/m)	MARGIN (dB)	ANTENNA HEIGHT (m)	TABLE ANGLE (Degree)	RAW VALUE (dBuV)	CORRECTION FACTOR (dB/m)
1	*5320.00	107.4 PK			2.48 H	289	103.97	3.43
2	*5320.00	97.5 AV			2.48 H	289	94.07	3.43
3	5350.00	65.4 PK	74.0	-8.6	2.48 H	289	61.89	3.51
4	5350.00	51.1 AV	54.0	-2.9	2.48 H	289	47.59	3.51

REMARKS:

1. Emission Level(dBuV/m) = Raw Value(dBuV) + Correction Factor(dB/m)
2. Correction Factor(dB/m) = Antenna Factor(dB/m) + Cable Factor(dB) – Pre-Amplifier Factor(dB)
3. The other emission levels were very low against the limit.
4. Margin value = Emission Level – Limit value
5. " * ": Fundamental frequency.

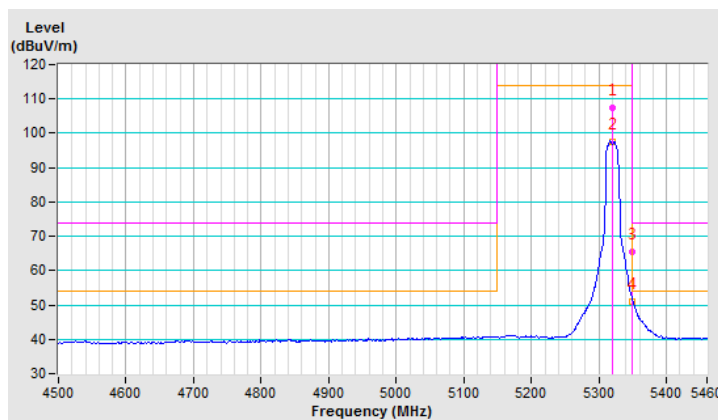

CHANNEL	TX Channel 64	DETECTOR FUNCTION	Peak (PK)
FREQUENCY RANGE	1GHz ~ 40GHz		Average (AV)

ANTENNA POLARITY & TEST DISTANCE: VERTICAL AT 3 M

NO.	FREQ. (MHz)	EMISSION LEVEL (dBuV/m)	LIMIT (dBuV/m)	MARGIN (dB)	ANTENNA HEIGHT (m)	TABLE ANGLE (Degree)	RAW VALUE (dBuV)	CORRECTION FACTOR (dB/m)
1	*5320.00	108.8 PK			1.00 V	298	105.37	3.43
2	*5320.00	99.3 AV			1.00 V	298	95.87	3.43
3	5350.00	71.5 PK	74.0	-2.5	1.00 V	298	67.99	3.51
4	5350.00	53.5 AV	54.0	-0.5	1.00 V	298	49.99	3.51

REMARKS:

1. Emission Level(dBuV/m) = Raw Value(dBuV) + Correction Factor(dB/m)
2. Correction Factor(dB/m) = Antenna Factor(dB/m) + Cable Factor(dB) – Pre-Amplifier Factor(dB)
3. The other emission levels were very low against the limit.
4. Margin value = Emission Level – Limit value
5. " * ": Fundamental frequency.

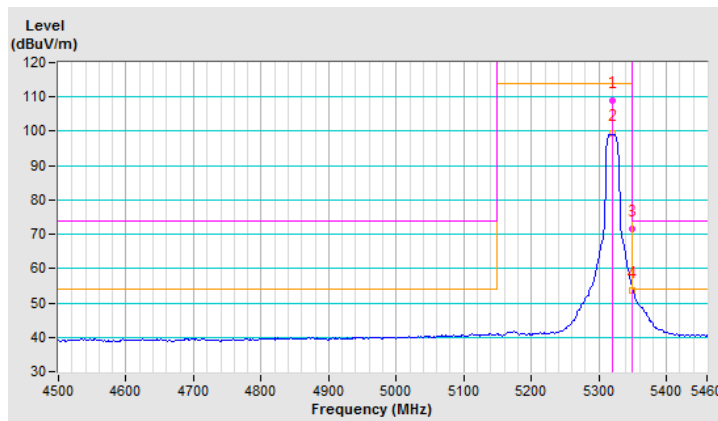

CHANNEL	TX Channel 100	DETECTOR FUNCTION	Peak (PK)
FREQUENCY RANGE	1GHz ~ 40GHz		Average (AV)

ANTENNA POLARITY & TEST DISTANCE: HORIZONTAL AT 3 M

NO.	FREQ. (MHz)	EMISSION LEVEL (dBuV/m)	LIMIT (dBuV/m)	MARGIN (dB)	ANTENNA HEIGHT (m)	TABLE ANGLE (Degree)	RAW VALUE (dBuV)	CORRECTION FACTOR (dB/m)
1	#5470.00	71.9 PK	74.0	-2.1	2.44 H	301	68.14	3.76
2	#5470.00	53.5 AV	54.0	-0.5	2.44 H	301	49.74	3.76
3	*5500.00	107.5 PK			2.44 H	301	103.71	3.79
4	*5500.00	97.6 AV			2.44 H	301	93.81	3.79

REMARKS:

1. Emission Level(dBuV/m) = Raw Value(dBuV) + Correction Factor(dB/m)
2. Correction Factor(dB/m) = Antenna Factor(dB/m) + Cable Factor(dB) – Pre-Amplifier Factor(dB)
3. The other emission levels were very low against the limit.
4. Margin value = Emission Level – Limit value
5. " * ": Fundamental frequency.
6. " # ": The radiated frequency is out of the restricted band.

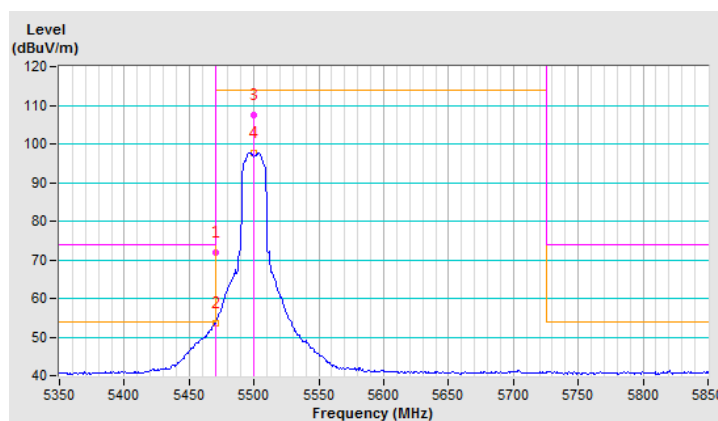

CHANNEL	TX Channel 100	DETECTOR FUNCTION	Peak (PK)
FREQUENCY RANGE	1GHz ~ 40GHz		Average (AV)

ANTENNA POLARITY & TEST DISTANCE: VERTICAL AT 3 M

NO.	FREQ. (MHz)	EMISSION LEVEL (dBuV/m)	LIMIT (dBuV/m)	MARGIN (dB)	ANTENNA HEIGHT (m)	TABLE ANGLE (Degree)	RAW VALUE (dBuV)	CORRECTION FACTOR (dB/m)
1	#5470.00	68.1 PK	74.0	-5.9	1.00 V	333	64.34	3.76
2	#5470.00	53.7 AV	54.0	-0.3	1.00 V	333	49.94	3.76
3	*5500.00	106.3 PK			1.00 V	333	102.51	3.79
4	*5500.00	96.5 AV			1.00 V	333	92.71	3.79

REMARKS:

1. Emission Level(dBuV/m) = Raw Value(dBuV) + Correction Factor(dB/m)
2. Correction Factor(dB/m) = Antenna Factor(dB/m) + Cable Factor(dB) – Pre-Amplifier Factor(dB)
3. The other emission levels were very low against the limit.
4. Margin value = Emission Level – Limit value
5. " * ": Fundamental frequency.
6. " # ": The radiated frequency is out of the restricted band.

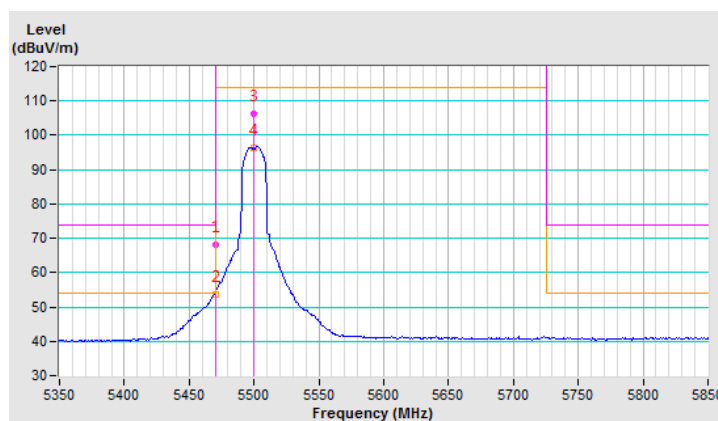

CHANNEL	TX Channel 116	DETECTOR FUNCTION	Peak (PK)
FREQUENCY RANGE	1GHz ~ 40GHz		Average (AV)

ANTENNA POLARITY & TEST DISTANCE: HORIZONTAL AT 3 M

NO.	FREQ. (MHz)	EMISSION LEVEL (dBuV/m)	LIMIT (dBuV/m)	MARGIN (dB)	ANTENNA HEIGHT (m)	TABLE ANGLE (Degree)	RAW VALUE (dBuV)	CORRECTION FACTOR (dB/m)
1	5352.00	52.9 PK	74.0	-21.1	2.52 H	303	49.37	3.53
2	5352.00	42.6 AV	54.0	-11.4	2.52 H	303	39.07	3.53
3	*5580.00	109.2 PK			2.52 H	303	105.29	3.91
4	*5580.00	99.7 AV			2.52 H	303	95.79	3.91
5	#5725.00	52.8 PK	74.0	-21.2	2.52 H	303	48.61	4.19
6	#5725.00	40.6 AV	54.0	-13.4	2.52 H	303	36.41	4.19

REMARKS:

1. Emission Level(dBuV/m) = Raw Value(dBuV) + Correction Factor(dB/m)
2. Correction Factor(dB/m) = Antenna Factor(dB/m) + Cable Factor(dB) – Pre-Amplifier Factor(dB)
3. The other emission levels were very low against the limit.
4. Margin value = Emission Level – Limit value
5. " * ": Fundamental frequency.
6. " # ": The radiated frequency is out of the restricted band.

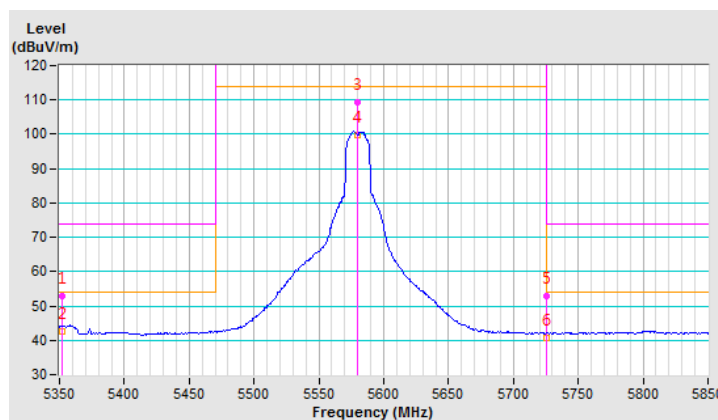

CHANNEL	TX Channel 116	DETECTOR FUNCTION	Peak (PK)
FREQUENCY RANGE	1GHz ~ 40GHz		Average (AV)

ANTENNA POLARITY & TEST DISTANCE: VERTICAL AT 3 M

NO.	FREQ. (MHz)	EMISSION LEVEL (dBuV/m)	LIMIT (dBuV/m)	MARGIN (dB)	ANTENNA HEIGHT (m)	TABLE ANGLE (Degree)	RAW VALUE (dBuV)	CORRECTION FACTOR (dB/m)
1	#5470.00	52.2 PK	74.0	-21.8	1.00 V	335	48.44	3.76
2	#5470.00	39.7 AV	54.0	-14.3	1.00 V	335	35.94	3.76
3	*5580.00	108.4 PK			1.00 V	335	104.49	3.91
4	*5580.00	98.5 AV			1.00 V	335	94.59	3.91
5	#5725.00	51.8 PK	74.0	-22.2	1.00 V	335	47.61	4.19
6	#5725.00	40.7 AV	54.0	-13.3	1.00 V	335	36.51	4.19

REMARKS:

1. Emission Level(dBuV/m) = Raw Value(dBuV) + Correction Factor(dB/m)
2. Correction Factor(dB/m) = Antenna Factor(dB/m) + Cable Factor(dB) – Pre-Amplifier Factor(dB)
3. The other emission levels were very low against the limit.
4. Margin value = Emission Level – Limit value
5. " * ": Fundamental frequency.
6. " # ": The radiated frequency is out of the restricted band.

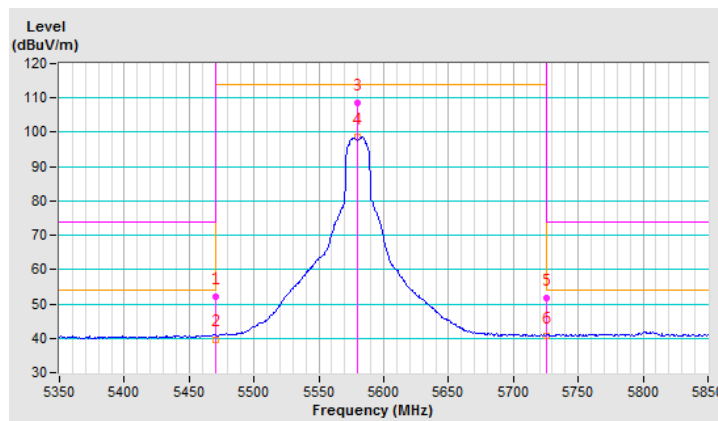

CHANNEL	TX Channel 140	DETECTOR FUNCTION	Peak (PK)
FREQUENCY RANGE	1GHz ~ 40GHz		Average (AV)

ANTENNA POLARITY & TEST DISTANCE: HORIZONTAL AT 3 M

NO.	FREQ. (MHz)	EMISSION LEVEL (dBuV/m)	LIMIT (dBuV/m)	MARGIN (dB)	ANTENNA HEIGHT (m)	TABLE ANGLE (Degree)	RAW VALUE (dBuV)	CORRECTION FACTOR (dB/m)
1	*5700.00	102.4 PK			2.40 H	305	98.21	4.19
2	*5700.00	93.8 AV			2.40 H	305	89.61	4.19
3	#5725.00	69.2 PK	74.0	-4.8	2.40 H	305	65.01	4.19
4	#5725.00	50.6 AV	54.0	-3.4	2.40 H	305	46.41	4.19

REMARKS:

1. Emission Level(dBuV/m) = Raw Value(dBuV) + Correction Factor(dB/m)
2. Correction Factor(dB/m) = Antenna Factor(dB/m) + Cable Factor(dB) – Pre-Amplifier Factor(dB)
3. The other emission levels were very low against the limit.
4. Margin value = Emission Level – Limit value
5. " * ": Fundamental frequency.
6. " # ": The radiated frequency is out of the restricted band.

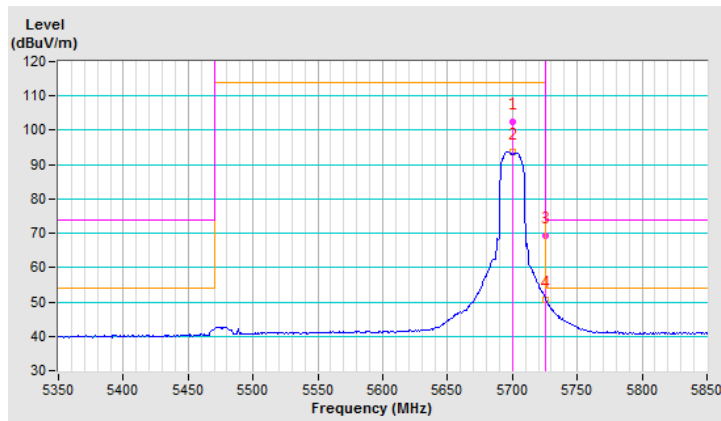

CHANNEL	TX Channel 140	DETECTOR FUNCTION	Peak (PK)
FREQUENCY RANGE	1GHz ~ 40GHz		Average (AV)

ANTENNA POLARITY & TEST DISTANCE: VERTICAL AT 3 M

NO.	FREQ. (MHz)	EMISSION LEVEL (dBuV/m)	LIMIT (dBuV/m)	MARGIN (dB)	ANTENNA HEIGHT (m)	TABLE ANGLE (Degree)	RAW VALUE (dBuV)	CORRECTION FACTOR (dB/m)
1	*5700.00	104.3 PK			1.00 V	338	100.11	4.19
2	*5700.00	94.2 AV			1.00 V	338	90.01	4.19
3	#5725.00	68.4 PK	74.0	-5.6	1.00 V	338	64.21	4.19
4	#5725.00	53.5 AV	54.0	-0.5	1.00 V	338	49.31	4.19

REMARKS:

1. Emission Level(dBuV/m) = Raw Value(dBuV) + Correction Factor(dB/m)
2. Correction Factor(dB/m) = Antenna Factor(dB/m) + Cable Factor(dB) – Pre-Amplifier Factor(dB)
3. The other emission levels were very low against the limit.
4. Margin value = Emission Level – Limit value
5. " * ": Fundamental frequency.
6. " # ": The radiated frequency is out of the restricted band.

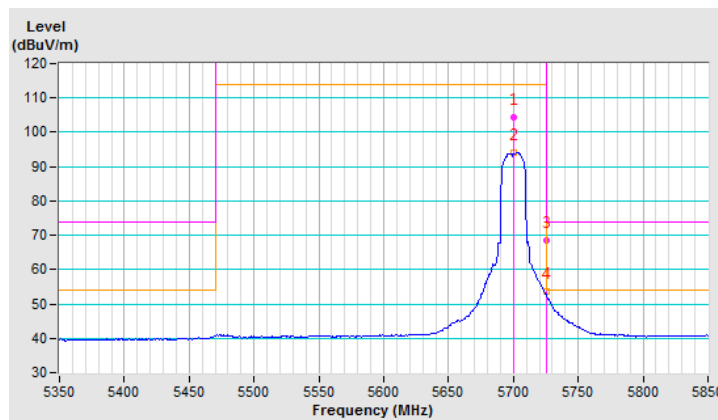

CHANNEL	TX Channel 149	DETECTOR FUNCTION	Peak (PK)
FREQUENCY RANGE	1GHz ~ 40GHz		Average (AV)

ANTENNA POLARITY & TEST DISTANCE: HORIZONTAL AT 3 M

NO.	FREQ. (MHz)	EMISSION LEVEL (dBuV/m)	LIMIT (dBuV/m)	MARGIN (dB)	ANTENNA HEIGHT (m)	TABLE ANGLE (Degree)	RAW VALUE (dBuV)	CORRECTION FACTOR (dB/m)
1	#5715.00	72.0 PK	74.0	-2.0	2.33 H	303	67.81	4.19
2	#5715.00	51.7 AV	54.0	-2.3	2.33 H	303	47.51	4.19
3	#5725.00	75.4 PK	78.2	-2.8	2.33 H	303	71.21	4.19
4	*5745.00	102.7 PK			2.33 H	303	98.51	4.19
5	*5745.00	93.3 AV			2.33 H	303	89.11	4.19

REMARKS:

1. Emission Level(dBuV/m) = Raw Value(dBuV) + Correction Factor(dB/m)
2. Correction Factor(dB/m) = Antenna Factor(dB/m) + Cable Factor(dB) – Pre-Amplifier Factor(dB)
3. The other emission levels were very low against the limit.
4. Margin value = Emission Level – Limit value
5. " * ": Fundamental frequency.
6. " # ": The radiated frequency is out of the restricted band.

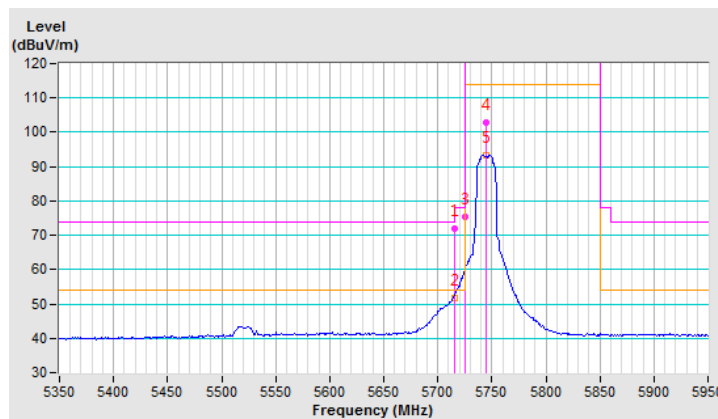

CHANNEL	TX Channel 149	DETECTOR FUNCTION	Peak (PK)
FREQUENCY RANGE	1GHz ~ 40GHz		Average (AV)

ANTENNA POLARITY & TEST DISTANCE: VERTICAL AT 3 M

NO.	FREQ. (MHz)	EMISSION LEVEL (dBuV/m)	LIMIT (dBuV/m)	MARGIN (dB)	ANTENNA HEIGHT (m)	TABLE ANGLE (Degree)	RAW VALUE (dBuV)	CORRECTION FACTOR (dB/m)
1	#5715.00	72.8 PK	74.0	-1.2	1.00 V	338	68.61	4.19
2	#5715.00	53.4 AV	54.0	-0.6	1.00 V	338	49.21	4.19
3	#5725.00	78.1 PK	78.2	-0.1	1.00 V	338	73.91	4.19
4	*5745.00	104.9 PK			1.00 V	338	100.71	4.19
5	*5745.00	95.4 AV			1.00 V	338	91.21	4.19

REMARKS:

1. Emission Level(dBuV/m) = Raw Value(dBuV) + Correction Factor(dB/m)
2. Correction Factor(dB/m) = Antenna Factor(dB/m) + Cable Factor(dB) – Pre-Amplifier Factor(dB)
3. The other emission levels were very low against the limit.
4. Margin value = Emission Level – Limit value
5. " * ": Fundamental frequency.
6. " # ": The radiated frequency is out of the restricted band.

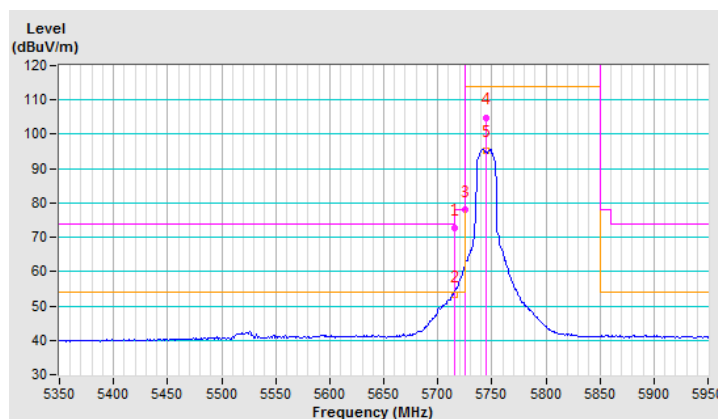

CHANNEL	TX Channel 157	DETECTOR FUNCTION	Peak (PK)
FREQUENCY RANGE	1GHz ~ 40GHz		Average (AV)

ANTENNA POLARITY & TEST DISTANCE: HORIZONTAL AT 3 M

NO.	FREQ. (MHz)	EMISSION LEVEL (dBuV/m)	LIMIT (dBuV/m)	MARGIN (dB)	ANTENNA HEIGHT (m)	TABLE ANGLE (Degree)	RAW VALUE (dBuV)	CORRECTION FACTOR (dB/m)
1	#5715.00	61.8 PK	74.0	-12.2	2.32 H	305	57.61	4.19
2	#5715.00	46.3 AV	54.0	-7.7	2.32 H	305	42.11	4.19
3	#5725.00	67.5 PK	78.2	-10.7	2.32 H	305	63.31	4.19
4	*5785.00	105.3 PK			2.32 H	305	101.12	4.18
5	*5785.00	96.0 AV			2.32 H	305	91.82	4.18
6	#5850.00	62.2 PK	78.2	-16.0	2.32 H	306	57.95	4.25
7	#5860.00	60.0 PK	74.0	-14.0	2.32 H	305	55.74	4.26
8	#5860.00	44.0 AV	54.0	-10.0	2.32 H	305	39.74	4.26

REMARKS:

1. Emission Level(dBuV/m) = Raw Value(dBuV) + Correction Factor(dB/m)
2. Correction Factor(dB/m) = Antenna Factor(dB/m) + Cable Factor(dB) – Pre-Amplifier Factor(dB)
3. The other emission levels were very low against the limit.
4. Margin value = Emission Level – Limit value
5. " * ": Fundamental frequency.
6. " # ": The radiated frequency is out of the restricted band.

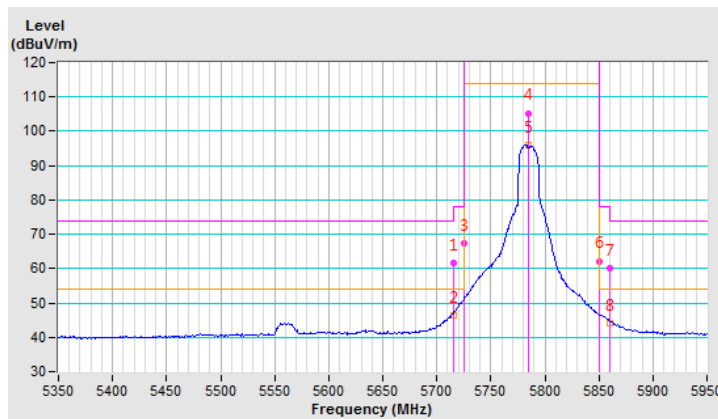

CHANNEL	TX Channel 157	DETECTOR FUNCTION	Peak (PK)
FREQUENCY RANGE	1GHz ~ 40GHz		Average (AV)

ANTENNA POLARITY & TEST DISTANCE: VERTICAL AT 3 M

NO.	FREQ. (MHz)	EMISSION LEVEL (dBuV/m)	LIMIT (dBuV/m)	MARGIN (dB)	ANTENNA HEIGHT (m)	TABLE ANGLE (Degree)	RAW VALUE (dBuV)	CORRECTION FACTOR (dB/m)
1	#5715.00	62.5 PK	74.0	-11.5	1.00 V	343	58.31	4.19
2	#5715.00	47.6 AV	54.0	-6.4	1.00 V	343	43.41	4.19
3	#5725.00	67.1 PK	78.2	-11.1	1.00 V	343	62.91	4.19
4	*5785.00	108.1 PK			1.00 V	343	103.92	4.18
5	*5785.00	98.6 AV			1.00 V	343	94.42	4.18
6	#5850.00	64.7 PK	78.2	-13.5	1.00 V	343	60.45	4.25
7	#5860.00	62.0 PK	74.0	-12.0	1.00 V	343	57.74	4.26
8	#5860.00	46.7 AV	54.0	-7.3	1.00 V	343	42.44	4.26

REMARKS:

1. Emission Level(dBuV/m) = Raw Value(dBuV) + Correction Factor(dB/m)
2. Correction Factor(dB/m) = Antenna Factor(dB/m) + Cable Factor(dB) – Pre-Amplifier Factor(dB)
3. The other emission levels were very low against the limit.
4. Margin value = Emission Level – Limit value
5. " * ": Fundamental frequency.
6. " # ": The radiated frequency is out of the restricted band.

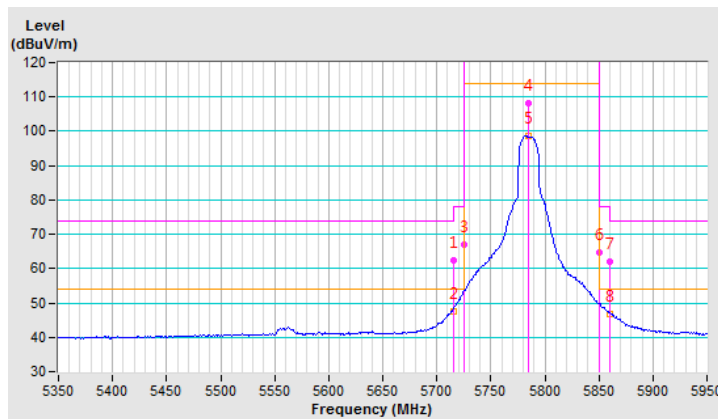

CHANNEL	TX Channel 165	DETECTOR FUNCTION	Peak (PK)
FREQUENCY RANGE	1GHz ~ 40GHz		Average (AV)

ANTENNA POLARITY & TEST DISTANCE: HORIZONTAL AT 3 M

NO.	FREQ. (MHz)	EMISSION LEVEL (dBuV/m)	LIMIT (dBuV/m)	MARGIN (dB)	ANTENNA HEIGHT (m)	TABLE ANGLE (Degree)	RAW VALUE (dBuV)	CORRECTION FACTOR (dB/m)
1	*5825.00	102.6 PK			2.48 H	305	98.38	4.22
2	*5825.00	93.9 AV			2.48 H	305	89.68	4.22
3	#5850.00	71.5 PK	78.2	-6.7	2.48 H	305	67.25	4.25
4	#5860.00	66.9 PK	74.0	-7.1	2.48 H	305	62.64	4.26
5	#5860.00	51.1 AV	54.0	-2.9	2.48 H	305	46.84	4.26

REMARKS:

1. Emission Level(dBuV/m) = Raw Value(dBuV) + Correction Factor(dB/m)
2. Correction Factor(dB/m) = Antenna Factor(dB/m) + Cable Factor(dB) – Pre-Amplifier Factor(dB)
3. The other emission levels were very low against the limit.
4. Margin value = Emission Level – Limit value
5. " * ": Fundamental frequency.
6. " # ": The radiated frequency is out of the restricted band.

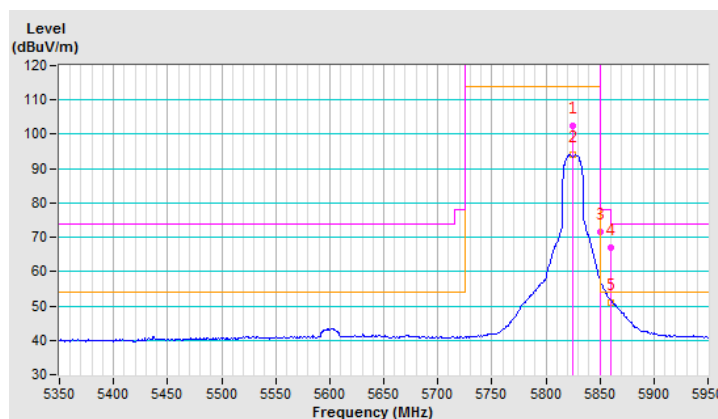

CHANNEL	TX Channel 165	DETECTOR FUNCTION	Peak (PK)
FREQUENCY RANGE	1GHz ~ 40GHz		Average (AV)

ANTENNA POLARITY & TEST DISTANCE: VERTICAL AT 3 M

NO.	FREQ. (MHz)	EMISSION LEVEL (dBuV/m)	LIMIT (dBuV/m)	MARGIN (dB)	ANTENNA HEIGHT (m)	TABLE ANGLE (Degree)	RAW VALUE (dBuV)	CORRECTION FACTOR (dB/m)
1	*5825.00	106.3 PK			1.00 V	345	102.08	4.22
2	*5825.00	97.1 AV			1.00 V	345	92.88	4.22
3	#5850.00	76.2 PK	78.2	-2.0	1.00 V	345	71.95	4.25
4	#5860.00	68.0 PK	74.0	-6.0	1.00 V	345	63.74	4.26
5	#5860.00	53.9 AV	54.0	-0.1	1.00 V	345	49.64	4.26

REMARKS:

1. Emission Level(dBuV/m) = Raw Value(dBuV) + Correction Factor(dB/m)
2. Correction Factor(dB/m) = Antenna Factor(dB/m) + Cable Factor(dB) – Pre-Amplifier Factor(dB)
3. The other emission levels were very low against the limit.
4. Margin value = Emission Level – Limit value
5. " * ": Fundamental frequency.
6. " # ": The radiated frequency is out of the restricted band.

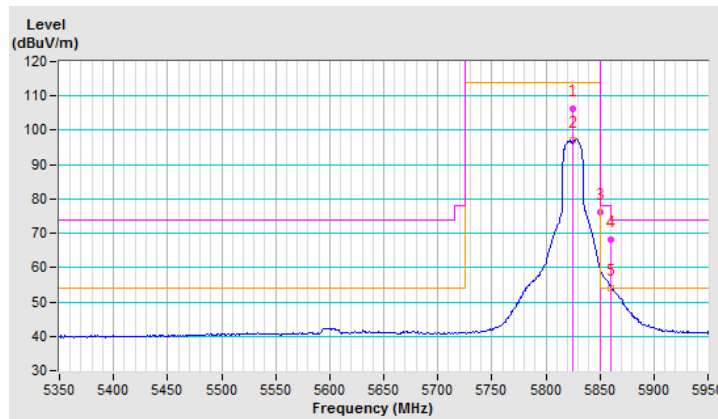

802.11n (40MHz)

CHANNEL	TX Channel 38	DETECTOR FUNCTION	Peak (PK)
FREQUENCY RANGE	1GHz ~ 40GHz		Average (AV)

ANTENNA POLARITY & TEST DISTANCE: HORIZONTAL AT 3 M								
NO.	FREQ. (MHz)	EMISSION LEVEL (dBuV/m)	LIMIT (dBuV/m)	MARGIN (dB)	ANTENNA HEIGHT (m)	TABLE ANGLE (Degree)	RAW VALUE (dBuV)	CORRECTION FACTOR (dB/m)
1	5150.00	67.5 PK	74.0	-6.5	2.53 H	285	64.52	2.98
2	5150.00	50.5 AV	54.0	-3.5	2.53 H	285	47.52	2.98
3	*5190.00	98.7 PK			2.53 H	285	95.63	3.07
4	*5190.00	89.2 AV			2.53 H	285	86.13	3.07
5	5350.00	51.5 PK	74.0	-22.5	2.53 H	285	47.99	3.51
6	5350.00	40.4 AV	54.0	-13.6	2.53 H	285	36.89	3.51

REMARKS:

1. Emission Level(dBuV/m) = Raw Value(dBuV) + Correction Factor(dB/m)
2. Correction Factor(dB/m) = Antenna Factor(dB/m) + Cable Factor(dB) – Pre-Amplifier Factor(dB)
3. The other emission levels were very low against the limit.
4. Margin value = Emission Level – Limit value
5. " * ": Fundamental frequency.

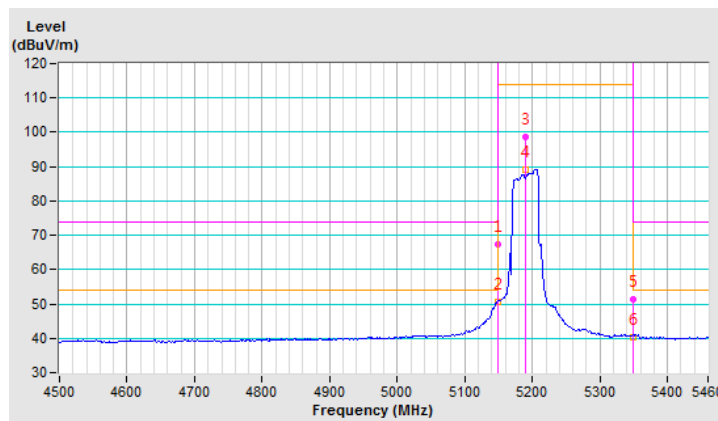

CHANNEL	TX Channel 38	DETECTOR FUNCTION	Peak (PK)
FREQUENCY RANGE	1GHz ~ 40GHz		Average (AV)

ANTENNA POLARITY & TEST DISTANCE: VERTICAL AT 3 M

NO.	FREQ. (MHz)	EMISSION LEVEL (dBuV/m)	LIMIT (dBuV/m)	MARGIN (dB)	ANTENNA HEIGHT (m)	TABLE ANGLE (Degree)	RAW VALUE (dBuV)	CORRECTION FACTOR (dB/m)
1	5150.00	67.1 PK	74.0	-6.9	1.00 V	293	64.12	2.98
2	5150.00	53.4 AV	54.0	-0.6	1.00 V	293	50.42	2.98
3	*5190.00	101.2 PK			1.00 V	293	98.13	3.07
4	*5190.00	91.1 AV			1.00 V	293	88.03	3.07
5	5350.00	52.7 PK	74.0	-21.3	1.00 V	293	49.19	3.51
6	5350.00	41.4 AV	54.0	-12.6	1.00 V	293	37.89	3.51

REMARKS:

1. Emission Level(dBuV/m) = Raw Value(dBuV) + Correction Factor(dB/m)
2. Correction Factor(dB/m) = Antenna Factor(dB/m) + Cable Factor(dB) – Pre-Amplifier Factor(dB)
3. The other emission levels were very low against the limit.
4. Margin value = Emission Level – Limit value
5. " * ": Fundamental frequency.

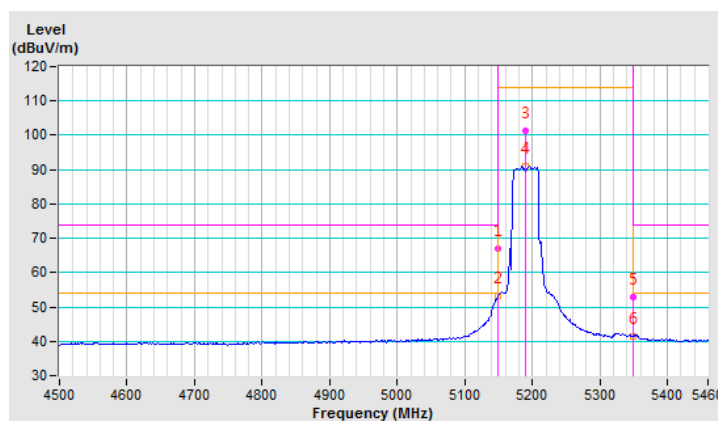

CHANNEL	TX Channel 46	DETECTOR FUNCTION	Peak (PK)
FREQUENCY RANGE	1GHz ~ 40GHz		Average (AV)

ANTENNA POLARITY & TEST DISTANCE: HORIZONTAL AT 3 M

NO.	FREQ. (MHz)	EMISSION LEVEL (dBuV/m)	LIMIT (dBuV/m)	MARGIN (dB)	ANTENNA HEIGHT (m)	TABLE ANGLE (Degree)	RAW VALUE (dBuV)	CORRECTION FACTOR (dB/m)
1	5150.00	64.7 PK	74.0	-9.3	2.34 H	300	61.72	2.98
2	5150.00	52.0 AV	54.0	-2.0	2.34 H	300	49.02	2.98
3	*5230.00	103.5 PK			2.34 H	300	100.32	3.18
4	*5230.00	93.7 AV			2.34 H	300	90.52	3.18
5	5350.00	56.6 PK	74.0	-17.4	2.34 H	300	53.09	3.51
6	5350.00	44.5 AV	54.0	-9.5	2.34 H	300	40.99	3.51

REMARKS:

1. Emission Level(dBuV/m) = Raw Value(dBuV) + Correction Factor(dB/m)
2. Correction Factor(dB/m) = Antenna Factor(dB/m) + Cable Factor(dB) – Pre-Amplifier Factor(dB)
3. The other emission levels were very low against the limit.
4. Margin value = Emission Level – Limit value
5. " * ": Fundamental frequency.

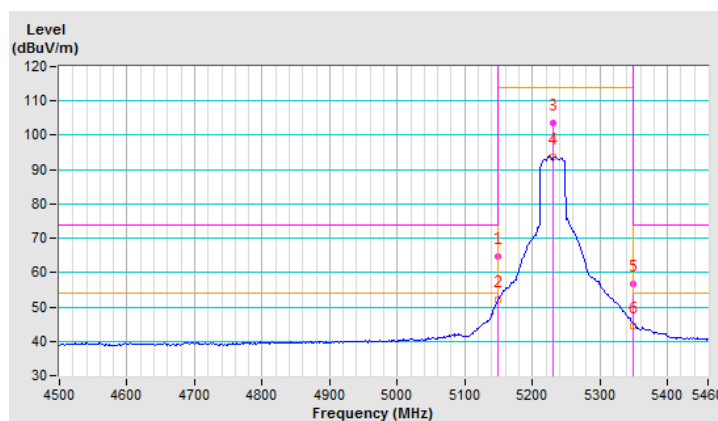

CHANNEL	TX Channel 46	DETECTOR FUNCTION	Peak (PK)
FREQUENCY RANGE	1GHz ~ 40GHz		Average (AV)

ANTENNA POLARITY & TEST DISTANCE: VERTICAL AT 3 M

NO.	FREQ. (MHz)	EMISSION LEVEL (dBuV/m)	LIMIT (dBuV/m)	MARGIN (dB)	ANTENNA HEIGHT (m)	TABLE ANGLE (Degree)	RAW VALUE (dBuV)	CORRECTION FACTOR (dB/m)
1	5150.00	66.7 PK	74.0	-7.3	1.00 V	292	63.72	2.98
2	5150.00	53.2 AV	54.0	-0.8	1.00 V	292	50.22	2.98
3	*5230.00	106.4 PK			1.00 V	292	103.22	3.18
4	*5230.00	96.2 AV			1.00 V	292	93.02	3.18
5	5350.00	57.2 PK	74.0	-16.8	1.00 V	292	53.69	3.51
6	5350.00	45.0 AV	54.0	-9.0	1.00 V	292	41.49	3.51

REMARKS:

1. Emission Level(dBuV/m) = Raw Value(dBuV) + Correction Factor(dB/m)
2. Correction Factor(dB/m) = Antenna Factor(dB/m) + Cable Factor(dB) – Pre-Amplifier Factor(dB)
3. The other emission levels were very low against the limit.
4. Margin value = Emission Level – Limit value
5. " * ": Fundamental frequency.

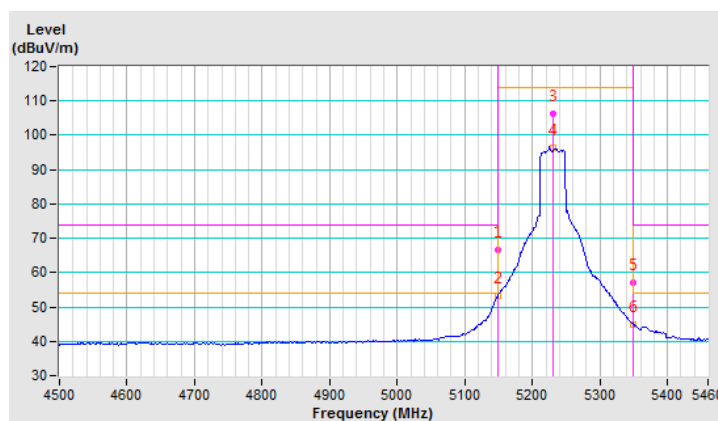

CHANNEL	TX Channel 54	DETECTOR FUNCTION	Peak (PK)
FREQUENCY RANGE	1GHz ~ 40GHz		Average (AV)

ANTENNA POLARITY & TEST DISTANCE: HORIZONTAL AT 3 M

NO.	FREQ. (MHz)	EMISSION LEVEL (dBuV/m)	LIMIT (dBuV/m)	MARGIN (dB)	ANTENNA HEIGHT (m)	TABLE ANGLE (Degree)	RAW VALUE (dBuV)	CORRECTION FACTOR (dB/m)
1	5150.00	52.6 PK	74.0	-21.4	2.26 H	291	49.62	2.98
2	5150.00	41.7 AV	54.0	-12.3	2.26 H	291	38.72	2.98
3	*5270.00	104.4 PK			2.26 H	291	101.11	3.29
4	*5270.00	94.8 AV			2.26 H	291	91.51	3.29
5	5350.00	61.9 PK	74.0	-12.1	2.26 H	291	58.39	3.51
6	5350.00	50.8 AV	54.0	-3.2	2.26 H	291	47.29	3.51

REMARKS:

1. Emission Level(dBuV/m) = Raw Value(dBuV) + Correction Factor(dB/m)
2. Correction Factor(dB/m) = Antenna Factor(dB/m) + Cable Factor(dB) – Pre-Amplifier Factor(dB)
3. The other emission levels were very low against the limit.
4. Margin value = Emission Level – Limit value
5. " * ": Fundamental frequency.

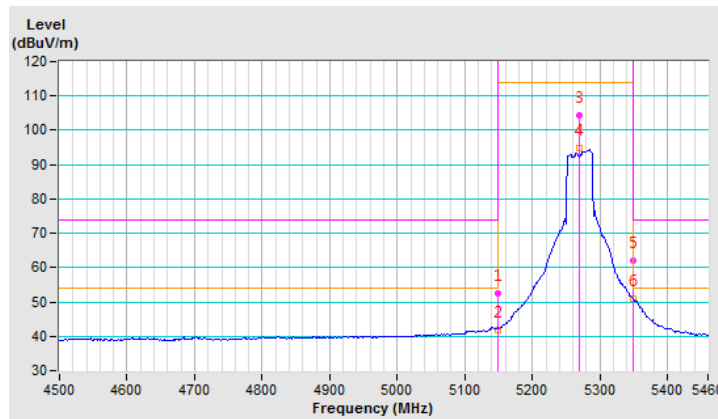

CHANNEL	TX Channel 54	DETECTOR FUNCTION	Peak (PK)
FREQUENCY RANGE	1GHz ~ 40GHz		Average (AV)

ANTENNA POLARITY & TEST DISTANCE: VERTICAL AT 3 M

NO.	FREQ. (MHz)	EMISSION LEVEL (dBuV/m)	LIMIT (dBuV/m)	MARGIN (dB)	ANTENNA HEIGHT (m)	TABLE ANGLE (Degree)	RAW VALUE (dBuV)	CORRECTION FACTOR (dB/m)
1	5150.00	55.2 PK	74.0	-18.8	1.00 V	293	52.22	2.98
2	5150.00	43.5 AV	54.0	-10.5	1.00 V	293	40.52	2.98
3	*5270.00	106.4 PK			1.00 V	293	103.11	3.29
4	*5270.00	96.8 AV			1.00 V	293	93.51	3.29
5	5350.00	66.2 PK	74.0	-7.8	1.00 V	293	62.69	3.51
6	5350.00	53.7 AV	54.0	-0.3	1.00 V	293	50.19	3.51

REMARKS:

1. Emission Level(dBuV/m) = Raw Value(dBuV) + Correction Factor(dB/m)
2. Correction Factor(dB/m) = Antenna Factor(dB/m) + Cable Factor(dB) – Pre-Amplifier Factor(dB)
3. The other emission levels were very low against the limit.
4. Margin value = Emission Level – Limit value
5. " * ": Fundamental frequency.

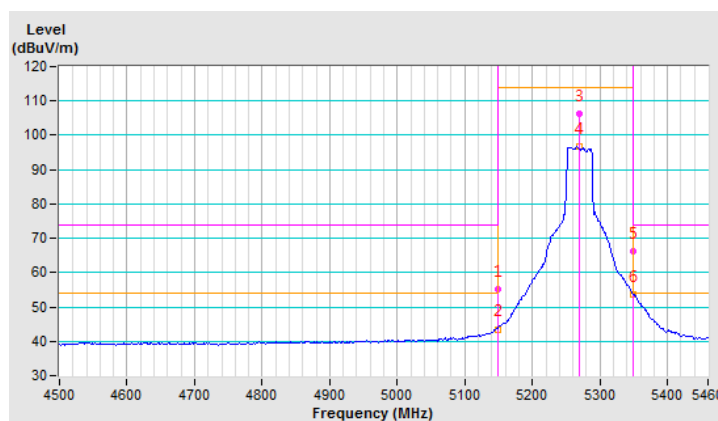

CHANNEL	TX Channel 62	DETECTOR FUNCTION	Peak (PK)
FREQUENCY RANGE	1GHz ~ 40GHz		Average (AV)

ANTENNA POLARITY & TEST DISTANCE: HORIZONTAL AT 3 M

NO.	FREQ. (MHz)	EMISSION LEVEL (dBuV/m)	LIMIT (dBuV/m)	MARGIN (dB)	ANTENNA HEIGHT (m)	TABLE ANGLE (Degree)	RAW VALUE (dBuV)	CORRECTION FACTOR (dB/m)
1	*5310.00	102.3 PK			2.31 H	297	98.90	3.40
2	*5310.00	92.2 AV			2.31 H	297	88.80	3.40
3	5350.00	67.1 PK	74.0	-6.9	2.31 H	297	63.59	3.51
4	5350.00	52.3 AV	54.0	-1.7	2.31 H	297	48.79	3.51

REMARKS:

1. Emission Level(dBuV/m) = Raw Value(dBuV) + Correction Factor(dB/m)
2. Correction Factor(dB/m) = Antenna Factor(dB/m) + Cable Factor(dB) – Pre-Amplifier Factor(dB)
3. The other emission levels were very low against the limit.
4. Margin value = Emission Level – Limit value
5. " * ": Fundamental frequency.

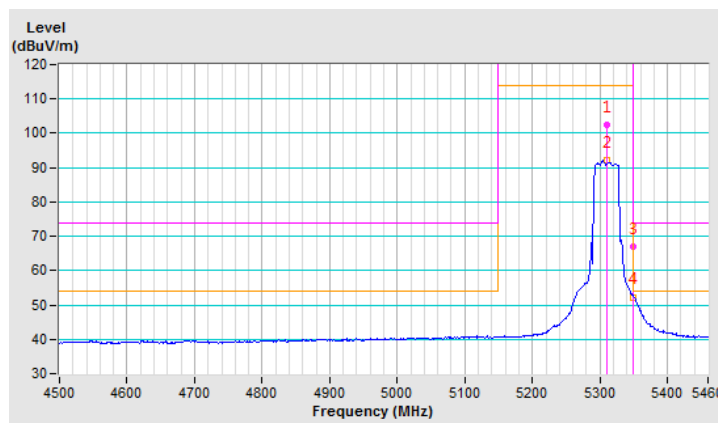

CHANNEL	TX Channel 62	DETECTOR FUNCTION	Peak (PK)
FREQUENCY RANGE	1GHz ~ 40GHz		Average (AV)

ANTENNA POLARITY & TEST DISTANCE: VERTICAL AT 3 M

NO.	FREQ. (MHz)	EMISSION LEVEL (dBuV/m)	LIMIT (dBuV/m)	MARGIN (dB)	ANTENNA HEIGHT (m)	TABLE ANGLE (Degree)	RAW VALUE (dBuV)	CORRECTION FACTOR (dB/m)
1	*5310.00	103.9 PK			1.00 V	294	100.50	3.40
2	*5310.00	93.5 AV			1.00 V	294	90.10	3.40
3	5350.00	71.9 PK	74.0	-2.1	1.00 V	294	68.39	3.51
4	5350.00	53.9 AV	54.0	-0.1	1.00 V	294	50.39	3.51

REMARKS:

1. Emission Level(dBuV/m) = Raw Value(dBuV) + Correction Factor(dB/m)
2. Correction Factor(dB/m) = Antenna Factor(dB/m) + Cable Factor(dB) – Pre-Amplifier Factor(dB)
3. The other emission levels were very low against the limit.
4. Margin value = Emission Level – Limit value
5. " * ": Fundamental frequency.

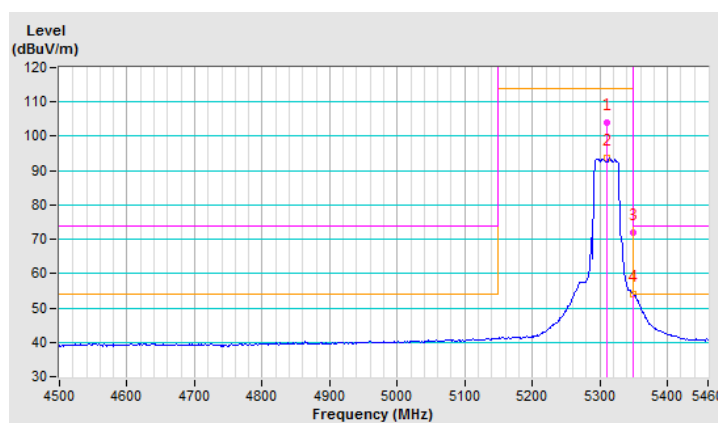

CHANNEL	TX Channel 102	DETECTOR FUNCTION	Peak (PK)
FREQUENCY RANGE	1GHz ~ 40GHz		Average (AV)

ANTENNA POLARITY & TEST DISTANCE: HORIZONTAL AT 3 M

NO.	FREQ. (MHz)	EMISSION LEVEL (dBuV/m)	LIMIT (dBuV/m)	MARGIN (dB)	ANTENNA HEIGHT (m)	TABLE ANGLE (Degree)	RAW VALUE (dBuV)	CORRECTION FACTOR (dB/m)
1	#5470.00	72.3 PK	74.0	-1.7	2.30 H	304	68.54	3.76
2	#5470.00	53.8 AV	54.0	-0.2	2.30 H	304	50.04	3.76
3	*5510.00	101.6 PK			2.30 H	304	97.79	3.81
4	*5510.00	92.2 AV			2.30 H	304	88.39	3.81

REMARKS:

1. Emission Level(dBuV/m) = Raw Value(dBuV) + Correction Factor(dB/m)
2. Correction Factor(dB/m) = Antenna Factor(dB/m) + Cable Factor(dB) – Pre-Amplifier Factor(dB)
3. The other emission levels were very low against the limit.
4. Margin value = Emission Level – Limit value
5. " * ": Fundamental frequency.
6. " # ": The radiated frequency is out of the restricted band.

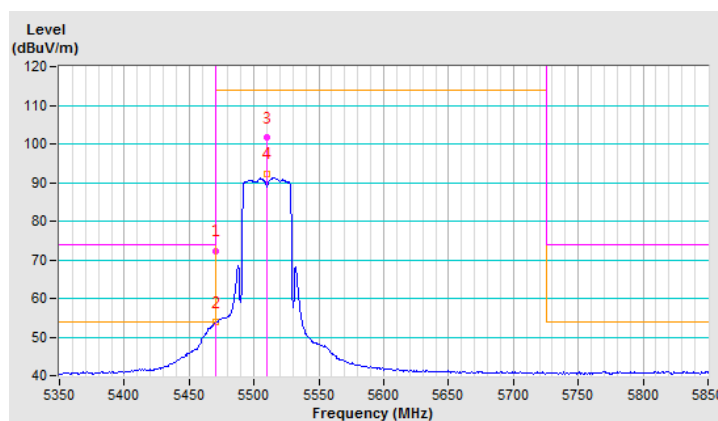

CHANNEL	TX Channel 102	DETECTOR FUNCTION	Peak (PK)
FREQUENCY RANGE	1GHz ~ 40GHz		Average (AV)

ANTENNA POLARITY & TEST DISTANCE: VERTICAL AT 3 M

NO.	FREQ. (MHz)	EMISSION LEVEL (dBuV/m)	LIMIT (dBuV/m)	MARGIN (dB)	ANTENNA HEIGHT (m)	TABLE ANGLE (Degree)	RAW VALUE (dBuV)	CORRECTION FACTOR (dB/m)
1	#5470.00	68.9 PK	74.0	-5.1	1.00 V	312	65.14	3.76
2	#5470.00	53.9 AV	54.0	-0.1	1.00 V	312	50.14	3.76
3	*5510.00	100.9 PK			1.00 V	312	97.09	3.81
4	*5510.00	90.6 AV			1.00 V	312	86.79	3.81

REMARKS:

1. Emission Level(dBuV/m) = Raw Value(dBuV) + Correction Factor(dB/m)
2. Correction Factor(dB/m) = Antenna Factor(dB/m) + Cable Factor(dB) – Pre-Amplifier Factor(dB)
3. The other emission levels were very low against the limit.
4. Margin value = Emission Level – Limit value
5. " * ": Fundamental frequency.
6. " # ": The radiated frequency is out of the restricted band.

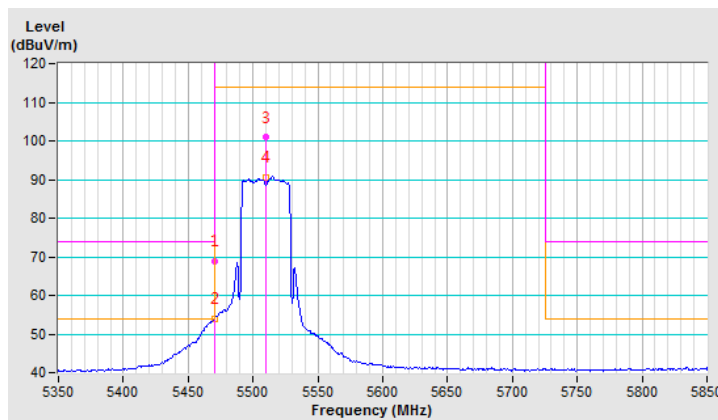

CHANNEL	TX Channel 110	DETECTOR FUNCTION	Peak (PK)
FREQUENCY RANGE	1GHz ~ 40GHz		Average (AV)

ANTENNA POLARITY & TEST DISTANCE: HORIZONTAL AT 3 M

NO.	FREQ. (MHz)	EMISSION LEVEL (dBuV/m)	LIMIT (dBuV/m)	MARGIN (dB)	ANTENNA HEIGHT (m)	TABLE ANGLE (Degree)	RAW VALUE (dBuV)	CORRECTION FACTOR (dB/m)
1	#5470.00	67.2 PK	74.0	-6.8	2.43 H	303	63.44	3.76
2	#5470.00	53.3 AV	54.0	-0.7	2.43 H	303	49.54	3.76
3	*5550.00	105.2 PK			2.43 H	303	101.34	3.86
4	*5550.00	95.2 AV			2.43 H	303	91.34	3.86
5	#5725.00	51.4 PK	74.0	-22.6	2.43 H	303	47.21	4.19
6	#5725.00	40.1 AV	54.0	-13.9	2.43 H	303	35.91	4.19

REMARKS:

1. Emission Level(dBuV/m) = Raw Value(dBuV) + Correction Factor(dB/m)
2. Correction Factor(dB/m) = Antenna Factor(dB/m) + Cable Factor(dB) – Pre-Amplifier Factor(dB)
3. The other emission levels were very low against the limit.
4. Margin value = Emission Level – Limit value
5. " * ": Fundamental frequency.
6. " # ": The radiated frequency is out of the restricted band.

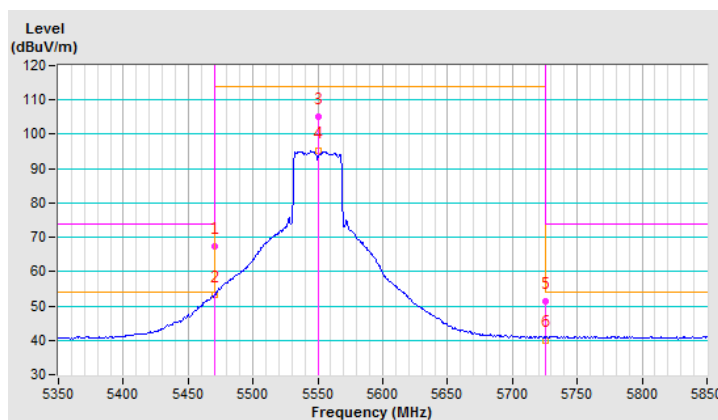

CHANNEL	TX Channel 110	DETECTOR FUNCTION	Peak (PK)
FREQUENCY RANGE	1GHz ~ 40GHz		Average (AV)

ANTENNA POLARITY & TEST DISTANCE: VERTICAL AT 3 M

NO.	FREQ. (MHz)	EMISSION LEVEL (dBuV/m)	LIMIT (dBuV/m)	MARGIN (dB)	ANTENNA HEIGHT (m)	TABLE ANGLE (Degree)	RAW VALUE (dBuV)	CORRECTION FACTOR (dB/m)
1	#5470.00	68.1 PK	74.0	-5.9	1.00 V	334	64.34	3.76
2	#5470.00	53.7 AV	54.0	-0.3	1.00 V	334	49.94	3.76
3	*5550.00	103.9 PK			1.00 V	334	100.04	3.86
4	*5550.00	94.1 AV			1.00 V	334	90.24	3.86
5	#5725.00	51.9 PK	74.0	-22.1	1.00 V	334	47.71	4.19
6	#5725.00	40.5 AV	54.0	-13.5	1.00 V	334	36.31	4.19

REMARKS:

1. Emission Level(dBuV/m) = Raw Value(dBuV) + Correction Factor(dB/m)
2. Correction Factor(dB/m) = Antenna Factor(dB/m) + Cable Factor(dB) – Pre-Amplifier Factor(dB)
3. The other emission levels were very low against the limit.
4. Margin value = Emission Level – Limit value
5. " * ": Fundamental frequency.
6. " # ": The radiated frequency is out of the restricted band.

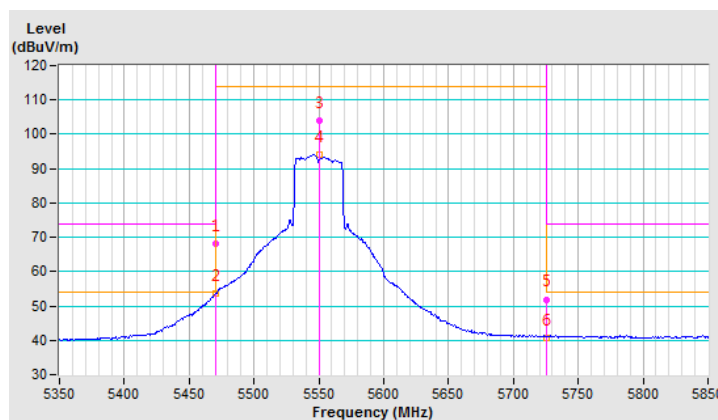

CHANNEL	TX Channel 134	DETECTOR FUNCTION	Peak (PK)
FREQUENCY RANGE	1GHz ~ 40GHz		Average (AV)

ANTENNA POLARITY & TEST DISTANCE: HORIZONTAL AT 3 M

NO.	FREQ. (MHz)	EMISSION LEVEL (dBuV/m)	LIMIT (dBuV/m)	MARGIN (dB)	ANTENNA HEIGHT (m)	TABLE ANGLE (Degree)	RAW VALUE (dBuV)	CORRECTION FACTOR (dB/m)
1	*5670.00	101.1 PK			2.52 H	305	96.99	4.11
2	*5670.00	91.8 AV			2.52 H	305	87.69	4.11
3	#5725.00	66.9 PK	74.0	-7.1	2.52 H	305	62.71	4.19
4	#5725.00	51.0 AV	54.0	-3.0	2.52 H	305	46.81	4.19

REMARKS:

1. Emission Level(dBuV/m) = Raw Value(dBuV) + Correction Factor(dB/m)
2. Correction Factor(dB/m) = Antenna Factor(dB/m) + Cable Factor(dB) – Pre-Amplifier Factor(dB)
3. The other emission levels were very low against the limit.
4. Margin value = Emission Level – Limit value
5. " * ": Fundamental frequency.
6. " # ": The radiated frequency is out of the restricted band.

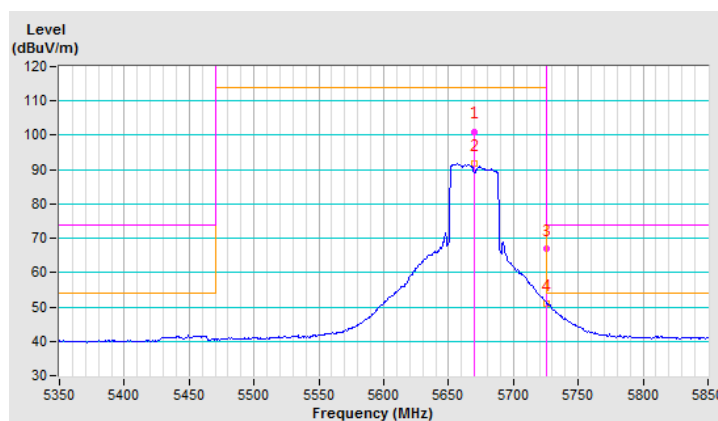

CHANNEL	TX Channel 134	DETECTOR FUNCTION	Peak (PK)
FREQUENCY RANGE	1GHz ~ 40GHz		Average (AV)

ANTENNA POLARITY & TEST DISTANCE: VERTICAL AT 3 M

NO.	FREQ. (MHz)	EMISSION LEVEL (dBuV/m)	LIMIT (dBuV/m)	MARGIN (dB)	ANTENNA HEIGHT (m)	TABLE ANGLE (Degree)	RAW VALUE (dBuV)	CORRECTION FACTOR (dB/m)
1	*5670.00	102.2 PK			1.00 V	336	98.09	4.11
2	*5670.00	91.4 AV			1.00 V	336	87.29	4.11
3	#5725.00	65.6 PK	74.0	-8.4	1.00 V	336	61.41	4.19
4	#5725.00	53.7 AV	54.0	-0.3	1.00 V	336	49.51	4.19

REMARKS:

1. Emission Level(dBuV/m) = Raw Value(dBuV) + Correction Factor(dB/m)
2. Correction Factor(dB/m) = Antenna Factor(dB/m) + Cable Factor(dB) – Pre-Amplifier Factor(dB)
3. The other emission levels were very low against the limit.
4. Margin value = Emission Level – Limit value
5. " * ": Fundamental frequency.
6. " # ": The radiated frequency is out of the restricted band.

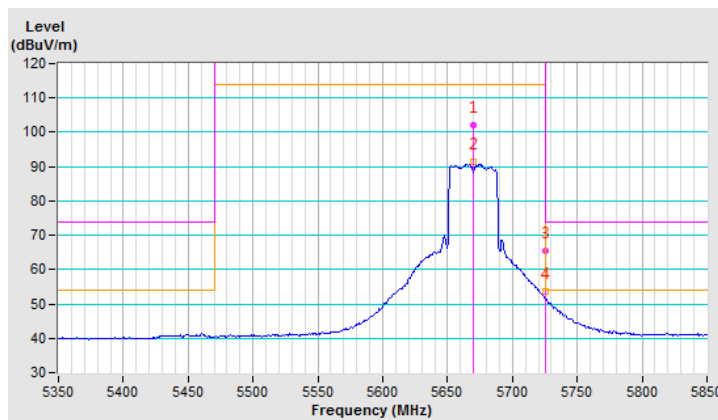

CHANNEL	TX Channel 151	DETECTOR FUNCTION	Peak (PK)
FREQUENCY RANGE	1GHz ~ 40GHz		Average (AV)

ANTENNA POLARITY & TEST DISTANCE: HORIZONTAL AT 3 M

NO.	FREQ. (MHz)	EMISSION LEVEL (dBuV/m)	LIMIT (dBuV/m)	MARGIN (dB)	ANTENNA HEIGHT (m)	TABLE ANGLE (Degree)	RAW VALUE (dBuV)	CORRECTION FACTOR (dB/m)
1	#5715.00	65.9 PK	74.0	-8.1	2.51 H	307	61.71	4.19
2	#5715.00	48.7 AV	54.0	-5.3	2.51 H	307	44.51	4.19
3	#5725.00	67.9 PK	78.2	-10.3	2.51 H	307	63.71	4.19
4	*5755.00	96.9 PK			2.51 H	307	92.72	4.18
5	*5755.00	87.2 AV			2.51 H	307	83.02	4.18

REMARKS:

1. Emission Level(dBuV/m) = Raw Value(dBuV) + Correction Factor(dB/m)
2. Correction Factor(dB/m) = Antenna Factor(dB/m) + Cable Factor(dB) – Pre-Amplifier Factor(dB)
3. The other emission levels were very low against the limit.
4. Margin value = Emission Level – Limit value
5. " * ": Fundamental frequency.
6. " # ": The radiated frequency is out of the restricted band.

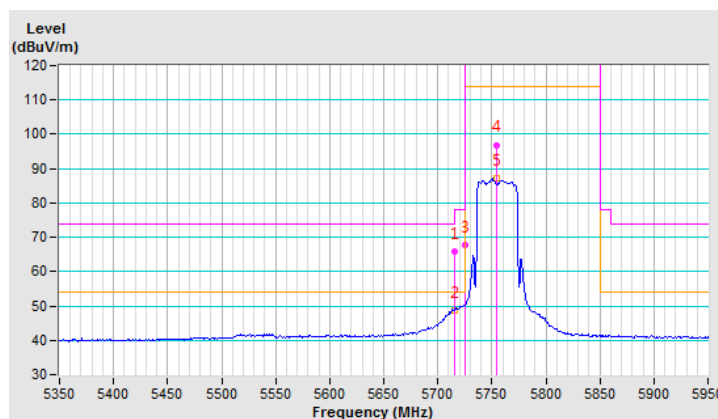

CHANNEL	TX Channel 151	DETECTOR FUNCTION	Peak (PK)
FREQUENCY RANGE	1GHz ~ 40GHz		Average (AV)

ANTENNA POLARITY & TEST DISTANCE: VERTICAL AT 3 M

NO.	FREQ. (MHz)	EMISSION LEVEL (dBuV/m)	LIMIT (dBuV/m)	MARGIN (dB)	ANTENNA HEIGHT (m)	TABLE ANGLE (Degree)	RAW VALUE (dBuV)	CORRECTION FACTOR (dB/m)
1	#5715.00	72.3 PK	74.0	-1.7	1.00 V	339	68.11	4.19
2	#5715.00	53.2 AV	54.0	-0.8	1.00 V	339	49.01	4.19
3	#5725.00	72.5 PK	78.2	-5.7	1.00 V	339	68.31	4.19
4	*5755.00	99.1 PK			1.00 V	339	94.92	4.18
5	*5755.00	89.5 AV			1.00 V	339	85.32	4.18

REMARKS:

1. Emission Level(dBuV/m) = Raw Value(dBuV) + Correction Factor(dB/m)
2. Correction Factor(dB/m) = Antenna Factor(dB/m) + Cable Factor(dB) – Pre-Amplifier Factor(dB)
3. The other emission levels were very low against the limit.
4. Margin value = Emission Level – Limit value
5. " * ": Fundamental frequency.
6. " # ": The radiated frequency is out of the restricted band.

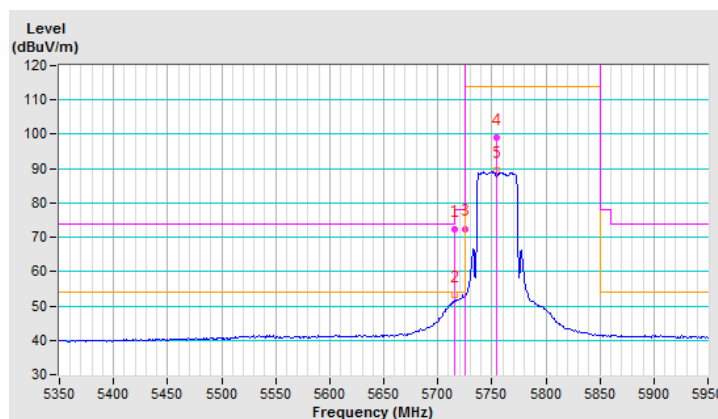

CHANNEL	TX Channel 159	DETECTOR FUNCTION	Peak (PK)
FREQUENCY RANGE	1GHz ~ 40GHz		Average (AV)

ANTENNA POLARITY & TEST DISTANCE: HORIZONTAL AT 3 M

NO.	FREQ. (MHz)	EMISSION LEVEL (dBuV/m)	LIMIT (dBuV/m)	MARGIN (dB)	ANTENNA HEIGHT (m)	TABLE ANGLE (Degree)	RAW VALUE (dBuV)	CORRECTION FACTOR (dB/m)
1	*5795.00	98.8 PK			2.50 H	310	94.61	4.19
2	*5795.00	90.2 AV			2.50 H	310	86.01	4.19
3	#5850.00	64.9 PK	78.2	-13.3	2.50 H	310	60.65	4.25
4	#5860.00	62.3 PK	74.0	-11.7	2.50 H	310	58.04	4.26
5	#5860.00	48.3 AV	54.0	-5.7	2.50 H	310	44.04	4.26

REMARKS:

1. Emission Level(dBuV/m) = Raw Value(dBuV) + Correction Factor(dB/m)
2. Correction Factor(dB/m) = Antenna Factor(dB/m) + Cable Factor(dB) – Pre-Amplifier Factor(dB)
3. The other emission levels were very low against the limit.
4. Margin value = Emission Level – Limit value
5. " * ": Fundamental frequency.
6. " # ": The radiated frequency is out of the restricted band.

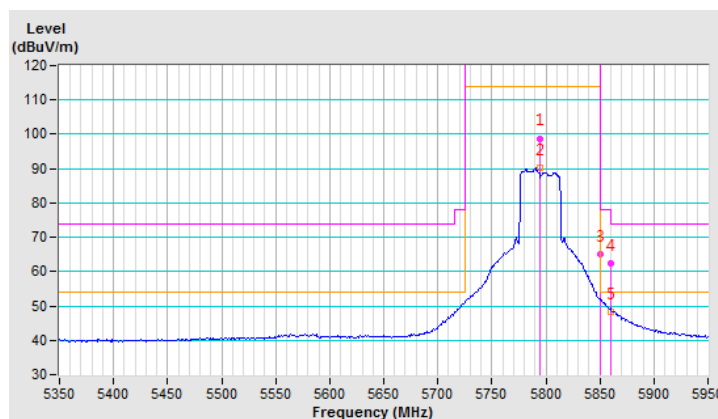

CHANNEL	TX Channel 159	DETECTOR FUNCTION	Peak (PK)
FREQUENCY RANGE	1GHz ~ 40GHz		Average (AV)

ANTENNA POLARITY & TEST DISTANCE: VERTICAL AT 3 M

NO.	FREQ. (MHz)	EMISSION LEVEL (dBuV/m)	LIMIT (dBuV/m)	MARGIN (dB)	ANTENNA HEIGHT (m)	TABLE ANGLE (Degree)	RAW VALUE (dBuV)	CORRECTION FACTOR (dB/m)
1	*5795.00	103.1 PK			1.00 V	343	98.91	4.19
2	*5795.00	93.1 AV			1.00 V	343	88.91	4.19
3	#5850.00	69.1 PK	78.2	-9.1	1.00 V	343	64.85	4.25
4	#5860.00	66.9 PK	74.0	-7.1	1.00 V	343	62.64	4.26
5	#5860.00	53.2 AV	54.0	-0.8	1.00 V	343	48.94	4.26

REMARKS:

1. Emission Level(dBuV/m) = Raw Value(dBuV) + Correction Factor(dB/m)
2. Correction Factor(dB/m) = Antenna Factor(dB/m) + Cable Factor(dB) – Pre-Amplifier Factor(dB)
3. The other emission levels were very low against the limit.
4. Margin value = Emission Level – Limit value
5. " * ": Fundamental frequency.
6. " # ": The radiated frequency is out of the restricted band.

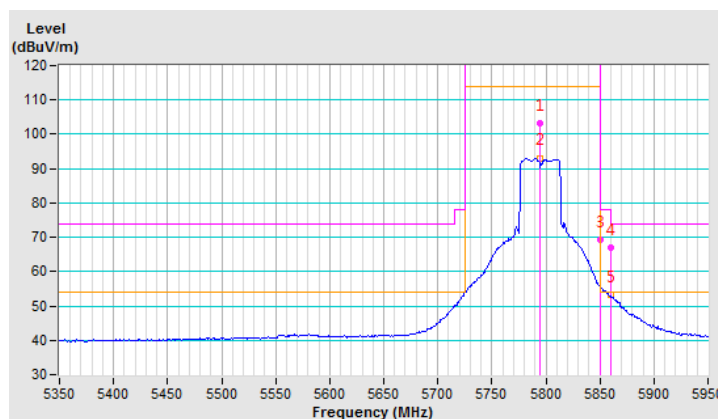

Antenna 2

802.11a

CHANNEL	TX Channel 36	DETECTOR FUNCTION	Peak (PK)
FREQUENCY RANGE	1GHz ~ 40GHz		Average (AV)

ANTENNA POLARITY & TEST DISTANCE: HORIZONTAL AT 3 M								
NO.	FREQ. (MHz)	EMISSION LEVEL (dBuV/m)	LIMIT (dBuV/m)	MARGIN (dB)	ANTENNA HEIGHT (m)	TABLE ANGLE (Degree)	RAW VALUE (dBuV)	CORRECTION FACTOR (dB/m)
1	5150.00	67.5 PK	74.0	-6.5	1.00 H	257	64.52	2.98
2	5150.00	52.1 AV	54.0	-1.9	1.00 H	257	49.12	2.98
3	*5180.00	107.9 PK			1.00 H	257	104.84	3.06
4	*5180.00	98.1 AV			1.00 H	257	95.04	3.06

REMARKS:

1. Emission Level(dBuV/m) = Raw Value(dBuV) + Correction Factor(dB/m)
2. Correction Factor(dB/m) = Antenna Factor(dB/m) + Cable Factor(dB) – Pre-Amplifier Factor(dB)
3. The other emission levels were very low against the limit.
4. Margin value = Emission Level – Limit value
5. " * ": Fundamental frequency.

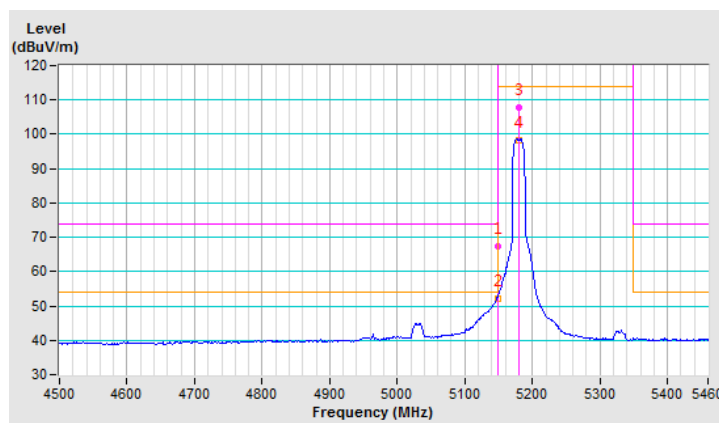

CHANNEL	TX Channel 36	DETECTOR FUNCTION	Peak (PK)
FREQUENCY RANGE	1GHz ~ 40GHz		Average (AV)

ANTENNA POLARITY & TEST DISTANCE: VERTICAL AT 3 M

NO.	FREQ. (MHz)	EMISSION LEVEL (dBuV/m)	LIMIT (dBuV/m)	MARGIN (dB)	ANTENNA HEIGHT (m)	TABLE ANGLE (Degree)	RAW VALUE (dBuV)	CORRECTION FACTOR (dB/m)
1	5150.00	63.2 PK	74.0	-10.8	1.00 V	343	60.22	2.98
2	5150.00	50.3 AV	54.0	-3.7	1.00 V	343	47.32	2.98
3	*5180.00	105.9 PK			1.00 V	343	102.84	3.06
4	*5180.00	96.5 AV			1.00 V	343	93.44	3.06

REMARKS:

1. Emission Level(dBuV/m) = Raw Value(dBuV) + Correction Factor(dB/m)
2. Correction Factor(dB/m) = Antenna Factor(dB/m) + Cable Factor(dB) – Pre-Amplifier Factor(dB)
3. The other emission levels were very low against the limit.
4. Margin value = Emission Level – Limit value
5. " * ": Fundamental frequency.

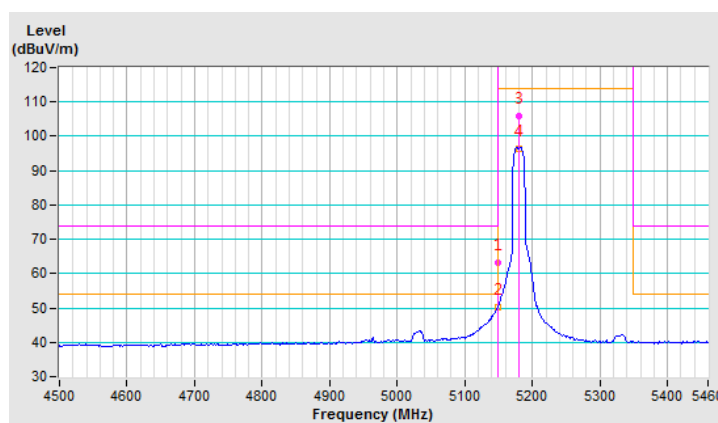

CHANNEL	TX Channel 40	DETECTOR FUNCTION	Peak (PK)
FREQUENCY RANGE	1GHz ~ 40GHz		Average (AV)

ANTENNA POLARITY & TEST DISTANCE: HORIZONTAL AT 3 M

NO.	FREQ. (MHz)	EMISSION LEVEL (dBuV/m)	LIMIT (dBuV/m)	MARGIN (dB)	ANTENNA HEIGHT (m)	TABLE ANGLE (Degree)	RAW VALUE (dBuV)	CORRECTION FACTOR (dB/m)
1	5150.00	69.6 PK	74.0	-4.4	1.00 H	256	66.62	2.98
2	5150.00	53.9 AV	54.0	-0.1	1.00 H	256	50.92	2.98
3	*5200.00	111.0 PK			1.00 H	256	107.90	3.10
4	*5200.00	101.2 AV			1.00 H	256	98.10	3.10
5	5350.00	53.7 PK	74.0	-20.3	1.00 H	256	50.19	3.51
6	5350.00	44.1 AV	54.0	-9.9	1.00 H	256	40.59	3.51

REMARKS:

1. Emission Level(dBuV/m) = Raw Value(dBuV) + Correction Factor(dB/m)
2. Correction Factor(dB/m) = Antenna Factor(dB/m) + Cable Factor(dB) – Pre-Amplifier Factor(dB)
3. The other emission levels were very low against the limit.
4. Margin value = Emission Level – Limit value
5. " * ": Fundamental frequency.

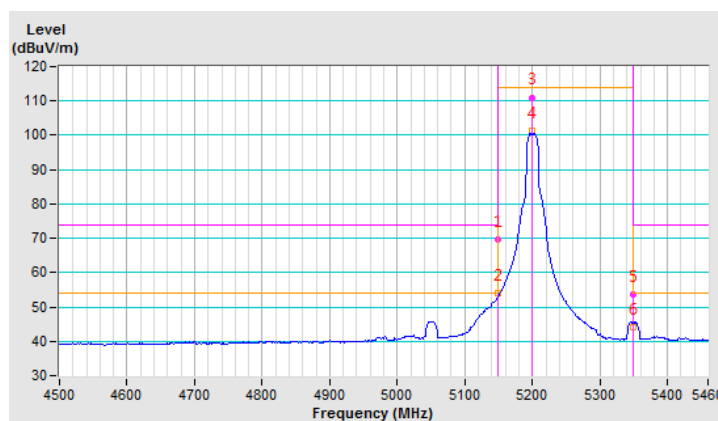

CHANNEL	TX Channel 40	DETECTOR FUNCTION	Peak (PK)
FREQUENCY RANGE	1GHz ~ 40GHz		Average (AV)

ANTENNA POLARITY & TEST DISTANCE: VERTICAL AT 3 M

NO.	FREQ. (MHz)	EMISSION LEVEL (dBuV/m)	LIMIT (dBuV/m)	MARGIN (dB)	ANTENNA HEIGHT (m)	TABLE ANGLE (Degree)	RAW VALUE (dBuV)	CORRECTION FACTOR (dB/m)
1	5150.00	66.2 PK	74.0	-7.8	1.04 V	49	63.22	2.98
2	5150.00	51.6 AV	54.0	-2.4	1.04 V	49	48.62	2.98
3	*5200.00	108.7 PK			1.04 V	49	105.60	3.10
4	*5200.00	99.5 AV			1.04 V	49	96.40	3.10
5	5350.00	53.7 PK	74.0	-20.3	1.04 V	49	50.19	3.51
6	5350.00	43.6 AV	54.0	-10.4	1.04 V	49	40.09	3.51

REMARKS:

1. Emission Level(dBuV/m) = Raw Value(dBuV) + Correction Factor(dB/m)
2. Correction Factor(dB/m) = Antenna Factor(dB/m) + Cable Factor(dB) – Pre-Amplifier Factor(dB)
3. The other emission levels were very low against the limit.
4. Margin value = Emission Level – Limit value
5. " * ": Fundamental frequency.

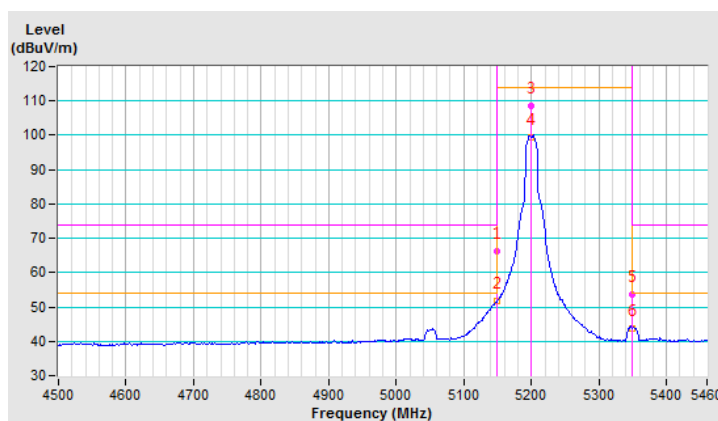

CHANNEL	TX Channel 48	DETECTOR FUNCTION	Peak (PK)
FREQUENCY RANGE	1GHz ~ 40GHz		Average (AV)

ANTENNA POLARITY & TEST DISTANCE: HORIZONTAL AT 3 M

NO.	FREQ. (MHz)	EMISSION LEVEL (dBuV/m)	LIMIT (dBuV/m)	MARGIN (dB)	ANTENNA HEIGHT (m)	TABLE ANGLE (Degree)	RAW VALUE (dBuV)	CORRECTION FACTOR (dB/m)
1	5150.00	60.1 PK	74.0	-13.9	1.00 H	256	57.12	2.98
2	5150.00	47.2 AV	54.0	-6.8	1.00 H	256	44.22	2.98
3	*5240.00	111.2 PK			1.00 H	256	107.99	3.21
4	*5240.00	102.1 AV			1.00 H	256	98.89	3.21
5	5390.00	54.2 PK	74.0	-19.8	1.00 H	256	50.57	3.63
6	5390.00	43.2 AV	54.0	-10.8	1.00 H	256	39.57	3.63

REMARKS:

1. Emission Level(dBuV/m) = Raw Value(dBuV) + Correction Factor(dB/m)
2. Correction Factor(dB/m) = Antenna Factor(dB/m) + Cable Factor(dB) – Pre-Amplifier Factor(dB)
3. The other emission levels were very low against the limit.
4. Margin value = Emission Level – Limit value
5. " * ": Fundamental frequency.

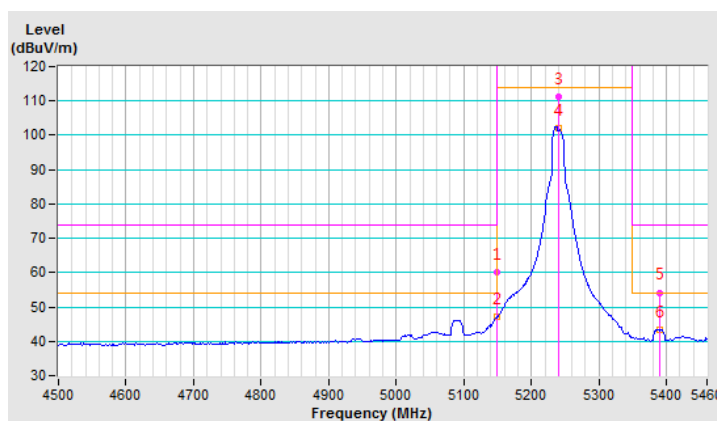

CHANNEL	TX Channel 48	DETECTOR FUNCTION	Peak (PK)
FREQUENCY RANGE	1GHz ~ 40GHz		Average (AV)

ANTENNA POLARITY & TEST DISTANCE: VERTICAL AT 3 M

NO.	FREQ. (MHz)	EMISSION LEVEL (dBuV/m)	LIMIT (dBuV/m)	MARGIN (dB)	ANTENNA HEIGHT (m)	TABLE ANGLE (Degree)	RAW VALUE (dBuV)	CORRECTION FACTOR (dB/m)
1	5150.00	58.2 PK	74.0	-15.8	1.06 V	46	55.22	2.98
2	5150.00	43.9 AV	54.0	-10.1	1.06 V	46	40.92	2.98
3	*5240.00	110.2 PK			1.06 V	46	106.99	3.21
4	*5240.00	100.8 AV			1.06 V	46	97.59	3.21
5	5390.00	54.2 PK	74.0	-19.8	1.06 V	46	50.57	3.63
6	5390.00	43.8 AV	54.0	-10.2	1.06 V	46	40.17	3.63

REMARKS:

1. Emission Level(dBuV/m) = Raw Value(dBuV) + Correction Factor(dB/m)
2. Correction Factor(dB/m) = Antenna Factor(dB/m) + Cable Factor(dB) – Pre-Amplifier Factor(dB)
3. The other emission levels were very low against the limit.
4. Margin value = Emission Level – Limit value
5. " * ": Fundamental frequency.

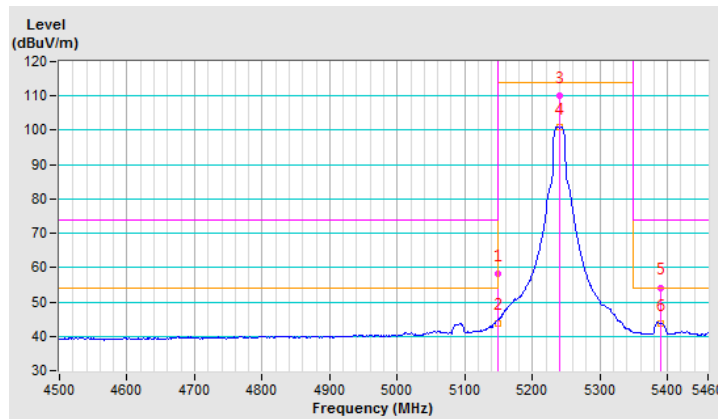

CHANNEL	TX Channel 52	DETECTOR FUNCTION	Peak (PK)
FREQUENCY RANGE	1GHz ~ 40GHz		Average (AV)

ANTENNA POLARITY & TEST DISTANCE: HORIZONTAL AT 3 M

NO.	FREQ. (MHz)	EMISSION LEVEL (dBuV/m)	LIMIT (dBuV/m)	MARGIN (dB)	ANTENNA HEIGHT (m)	TABLE ANGLE (Degree)	RAW VALUE (dBuV)	CORRECTION FACTOR (dB/m)
1	5150.00	56.0 PK	74.0	-18.0	1.00 H	257	53.02	2.98
2	5150.00	45.3 AV	54.0	-8.7	1.00 H	257	42.32	2.98
3	*5260.00	111.5 PK			1.00 H	257	108.24	3.26
4	*5260.00	101.9 AV			1.00 H	257	98.64	3.26
5	5350.00	57.9 PK	74.0	-16.1	1.00 H	257	54.39	3.51
6	5350.00	43.4 AV	54.0	-10.6	1.00 H	257	39.89	3.51

REMARKS:

1. Emission Level(dBuV/m) = Raw Value(dBuV) + Correction Factor(dB/m)
2. Correction Factor(dB/m) = Antenna Factor(dB/m) + Cable Factor(dB) – Pre-Amplifier Factor(dB)
3. The other emission levels were very low against the limit.
4. Margin value = Emission Level – Limit value
5. " * ": Fundamental frequency.

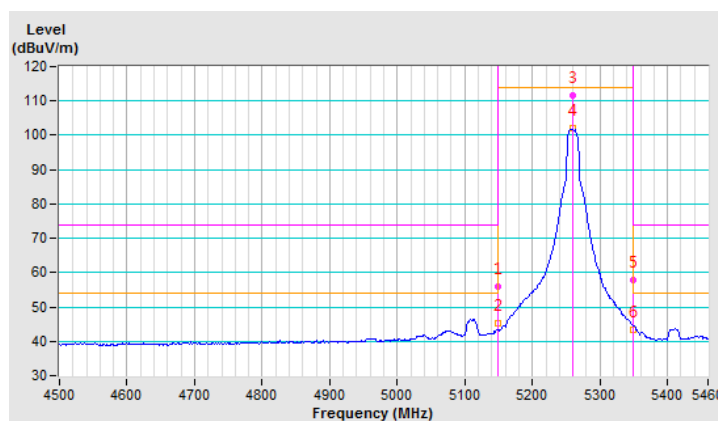

CHANNEL	TX Channel 52	DETECTOR FUNCTION	Peak (PK)
FREQUENCY RANGE	1GHz ~ 40GHz		Average (AV)

ANTENNA POLARITY & TEST DISTANCE: VERTICAL AT 3 M

NO.	FREQ. (MHz)	EMISSION LEVEL (dBuV/m)	LIMIT (dBuV/m)	MARGIN (dB)	ANTENNA HEIGHT (m)	TABLE ANGLE (Degree)	RAW VALUE (dBuV)	CORRECTION FACTOR (dB/m)
1	5114.00	53.4 PK	74.0	-20.6	1.03 V	48	50.50	2.90
2	5114.00	43.2 AV	54.0	-10.8	1.03 V	48	40.30	2.90
3	*5260.00	111.4 PK			1.03 V	48	108.14	3.26
4	*5260.00	101.1 AV			1.03 V	48	97.84	3.26
5	5350.00	55.9 PK	74.0	-18.1	1.03 V	48	52.39	3.51
6	5350.00	43.9 AV	54.0	-10.1	1.03 V	48	40.39	3.51

REMARKS:

1. Emission Level(dBuV/m) = Raw Value(dBuV) + Correction Factor(dB/m)
2. Correction Factor(dB/m) = Antenna Factor(dB/m) + Cable Factor(dB) – Pre-Amplifier Factor(dB)
3. The other emission levels were very low against the limit.
4. Margin value = Emission Level – Limit value
5. " * ": Fundamental frequency.

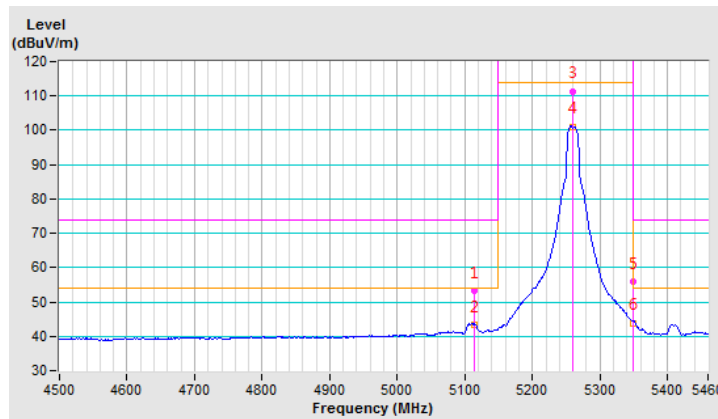

CHANNEL	TX Channel 60	DETECTOR FUNCTION	Peak (PK)
FREQUENCY RANGE	1GHz ~ 40GHz		Average (AV)

ANTENNA POLARITY & TEST DISTANCE: HORIZONTAL AT 3 M

NO.	FREQ. (MHz)	EMISSION LEVEL (dBuV/m)	LIMIT (dBuV/m)	MARGIN (dB)	ANTENNA HEIGHT (m)	TABLE ANGLE (Degree)	RAW VALUE (dBuV)	CORRECTION FACTOR (dB/m)
1	5150.00	54.7 PK	74.0	-19.3	1.00 H	257	51.72	2.98
2	5150.00	44.9 AV	54.0	-9.1	1.00 H	257	41.92	2.98
3	*5300.00	110.7 PK			1.00 H	257	107.33	3.37
4	*5300.00	101.6 AV			1.00 H	257	98.23	3.37
5	5350.00	65.8 PK	74.0	-8.2	1.00 H	257	62.29	3.51
6	5350.00	52.6 AV	54.0	-1.4	1.00 H	257	49.09	3.51

REMARKS:

1. Emission Level(dBuV/m) = Raw Value(dBuV) + Correction Factor(dB/m)
2. Correction Factor(dB/m) = Antenna Factor(dB/m) + Cable Factor(dB) – Pre-Amplifier Factor(dB)
3. The other emission levels were very low against the limit.
4. Margin value = Emission Level – Limit value
5. " * ": Fundamental frequency.

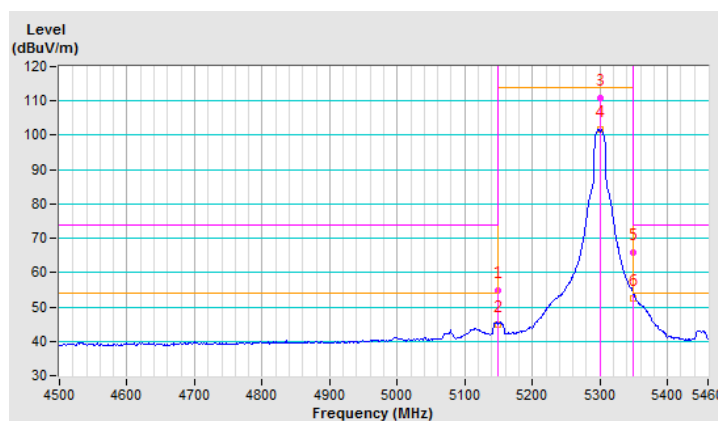

CHANNEL	TX Channel 60	DETECTOR FUNCTION	Peak (PK)
FREQUENCY RANGE	1GHz ~ 40GHz		Average (AV)

ANTENNA POLARITY & TEST DISTANCE: VERTICAL AT 3 M

NO.	FREQ. (MHz)	EMISSION LEVEL (dBuV/m)	LIMIT (dBuV/m)	MARGIN (dB)	ANTENNA HEIGHT (m)	TABLE ANGLE (Degree)	RAW VALUE (dBuV)	CORRECTION FACTOR (dB/m)
1	5150.00	53.4 PK	74.0	-20.6	1.00 V	50	50.42	2.98
2	5150.00	43.2 AV	54.0	-10.8	1.00 V	50	40.22	2.98
3	*5300.00	110.1 PK			1.00 V	50	106.73	3.37
4	*5300.00	100.5 AV			1.00 V	50	97.13	3.37
5	5350.00	68.3 PK	74.0	-5.7	1.00 V	50	64.79	3.51
6	5350.00	53.4 AV	54.0	-0.6	1.00 V	50	49.89	3.51

REMARKS:

1. Emission Level(dBuV/m) = Raw Value(dBuV) + Correction Factor(dB/m)
2. Correction Factor(dB/m) = Antenna Factor(dB/m) + Cable Factor(dB) – Pre-Amplifier Factor(dB)
3. The other emission levels were very low against the limit.
4. Margin value = Emission Level – Limit value
5. " * ": Fundamental frequency.

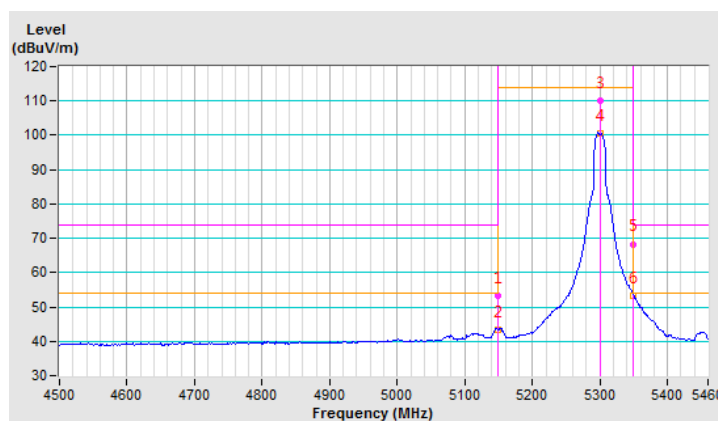

CHANNEL	TX Channel 64	DETECTOR FUNCTION	Peak (PK)
FREQUENCY RANGE	1GHz ~ 40GHz		Average (AV)

ANTENNA POLARITY & TEST DISTANCE: HORIZONTAL AT 3 M

NO.	FREQ. (MHz)	EMISSION LEVEL (dBuV/m)	LIMIT (dBuV/m)	MARGIN (dB)	ANTENNA HEIGHT (m)	TABLE ANGLE (Degree)	RAW VALUE (dBuV)	CORRECTION FACTOR (dB/m)
1	*5320.00	107.9 PK			1.00 H	278	104.47	3.43
2	*5320.00	98.9 AV			1.00 H	278	95.47	3.43
3	5350.00	66.2 PK	74.0	-7.8	1.00 H	278	62.69	3.51
4	5350.00	53.2 AV	54.0	-0.8	1.00 H	278	49.69	3.51

REMARKS:

1. Emission Level(dBuV/m) = Raw Value(dBuV) + Correction Factor(dB/m)
2. Correction Factor(dB/m) = Antenna Factor(dB/m) + Cable Factor(dB) – Pre-Amplifier Factor(dB)
3. The other emission levels were very low against the limit.
4. Margin value = Emission Level – Limit value
5. " * ": Fundamental frequency.

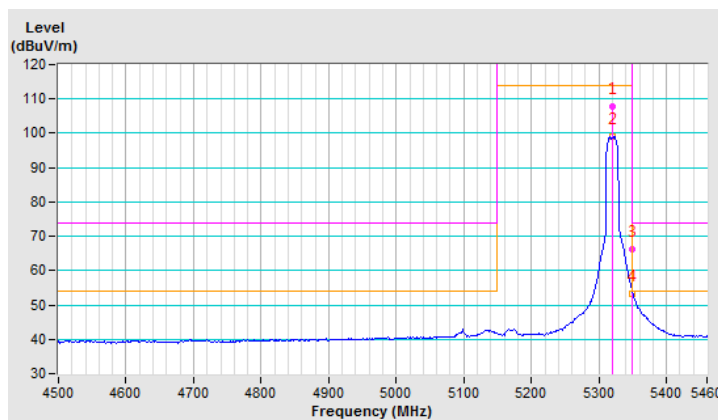

CHANNEL	TX Channel 64	DETECTOR FUNCTION	Peak (PK)
FREQUENCY RANGE	1GHz ~ 40GHz		Average (AV)

ANTENNA POLARITY & TEST DISTANCE: VERTICAL AT 3 M

NO.	FREQ. (MHz)	EMISSION LEVEL (dBuV/m)	LIMIT (dBuV/m)	MARGIN (dB)	ANTENNA HEIGHT (m)	TABLE ANGLE (Degree)	RAW VALUE (dBuV)	CORRECTION FACTOR (dB/m)
1	*5320.00	107.2 PK			1.00 V	55	103.77	3.43
2	*5320.00	97.8 AV			1.00 V	55	94.37	3.43
3	5350.00	66.7 PK	74.0	-7.3	1.00 V	55	63.19	3.51
4	5350.00	52.1 AV	54.0	-1.9	1.00 V	55	48.59	3.51

REMARKS:

1. Emission Level(dBuV/m) = Raw Value(dBuV) + Correction Factor(dB/m)
2. Correction Factor(dB/m) = Antenna Factor(dB/m) + Cable Factor(dB) – Pre-Amplifier Factor(dB)
3. The other emission levels were very low against the limit.
4. Margin value = Emission Level – Limit value
5. " * ": Fundamental frequency.

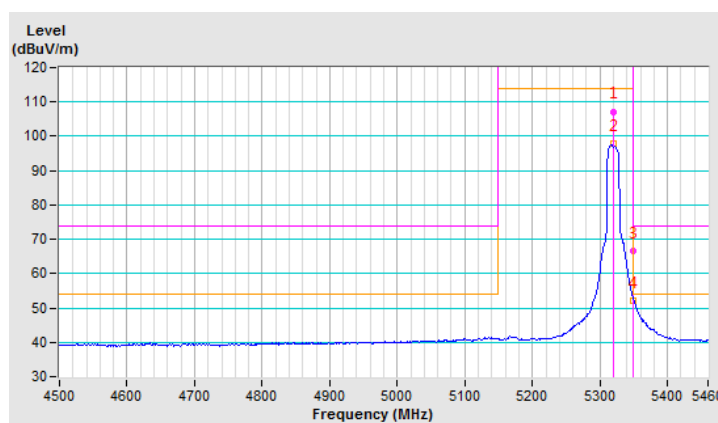

CHANNEL	TX Channel 100	DETECTOR FUNCTION	Peak (PK)
FREQUENCY RANGE	1GHz ~ 40GHz		Average (AV)

ANTENNA POLARITY & TEST DISTANCE: HORIZONTAL AT 3 M

NO.	FREQ. (MHz)	EMISSION LEVEL (dBuV/m)	LIMIT (dBuV/m)	MARGIN (dB)	ANTENNA HEIGHT (m)	TABLE ANGLE (Degree)	RAW VALUE (dBuV)	CORRECTION FACTOR (dB/m)
1	#5470.00	69.9 PK	74.0	-4.1	1.00 H	275	66.14	3.76
2	#5470.00	53.6 AV	54.0	-0.4	1.00 H	275	49.84	3.76
3	*5500.00	108.9 PK			1.00 H	275	105.11	3.79
4	*5500.00	99.1 AV			1.00 H	275	95.31	3.79

REMARKS:

1. Emission Level(dBuV/m) = Raw Value(dBuV) + Correction Factor(dB/m)
2. Correction Factor(dB/m) = Antenna Factor(dB/m) + Cable Factor(dB) – Pre-Amplifier Factor(dB)
3. The other emission levels were very low against the limit.
4. Margin value = Emission Level – Limit value
5. " * ": Fundamental frequency.
6. " # ": The radiated frequency is out of the restricted band.

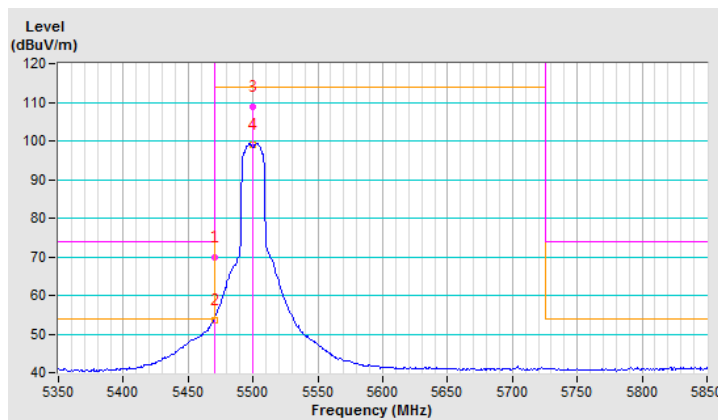

CHANNEL	TX Channel 100	DETECTOR FUNCTION	Peak (PK)
FREQUENCY RANGE	1GHz ~ 40GHz		Average (AV)

ANTENNA POLARITY & TEST DISTANCE: VERTICAL AT 3 M

NO.	FREQ. (MHz)	EMISSION LEVEL (dBuV/m)	LIMIT (dBuV/m)	MARGIN (dB)	ANTENNA HEIGHT (m)	TABLE ANGLE (Degree)	RAW VALUE (dBuV)	CORRECTION FACTOR (dB/m)
1	#5470.00	64.9 PK	74.0	-9.1	1.00 V	295	61.14	3.76
2	#5470.00	50.5 AV	54.0	-3.5	1.00 V	295	46.74	3.76
3	*5500.00	106.1 PK			1.00 V	295	102.31	3.79
4	*5500.00	96.7 AV			1.00 V	295	92.91	3.79

REMARKS:

1. Emission Level(dBuV/m) = Raw Value(dBuV) + Correction Factor(dB/m)
2. Correction Factor(dB/m) = Antenna Factor(dB/m) + Cable Factor(dB) – Pre-Amplifier Factor(dB)
3. The other emission levels were very low against the limit.
4. Margin value = Emission Level – Limit value
5. " * ": Fundamental frequency.
6. " # ": The radiated frequency is out of the restricted band.

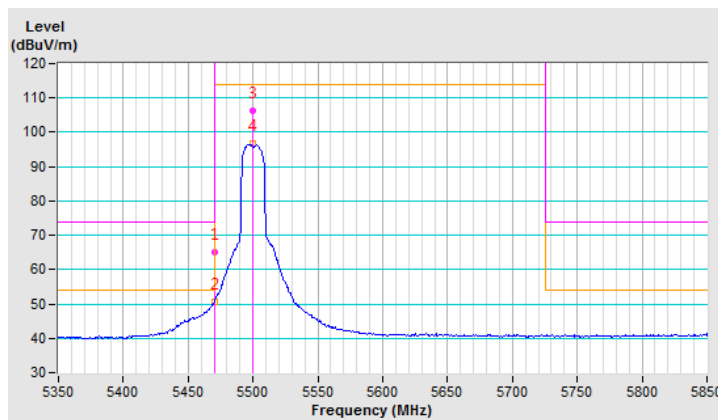

CHANNEL	TX Channel 116	DETECTOR FUNCTION	Peak (PK)
FREQUENCY RANGE	1GHz ~ 40GHz		Average (AV)

ANTENNA POLARITY & TEST DISTANCE: HORIZONTAL AT 3 M

NO.	FREQ. (MHz)	EMISSION LEVEL (dBuV/m)	LIMIT (dBuV/m)	MARGIN (dB)	ANTENNA HEIGHT (m)	TABLE ANGLE (Degree)	RAW VALUE (dBuV)	CORRECTION FACTOR (dB/m)
1	5352.00	54.8 PK	74.0	-19.2	1.00 H	277	51.27	3.53
2	5352.00	44.4 AV	54.0	-9.6	1.00 H	277	40.87	3.53
3	*5580.00	109.7 PK			1.00 H	277	105.79	3.91
4	*5580.00	100.5 AV			1.00 H	277	96.59	3.91
5	#5725.00	52.1 PK	74.0	-21.9	1.00 H	277	47.91	4.19
6	#5725.00	40.8 AV	54.0	-13.2	1.00 H	277	36.61	4.19

REMARKS:

1. Emission Level(dBuV/m) = Raw Value(dBuV) + Correction Factor(dB/m)
2. Correction Factor(dB/m) = Antenna Factor(dB/m) + Cable Factor(dB) – Pre-Amplifier Factor(dB)
3. The other emission levels were very low against the limit.
4. Margin value = Emission Level – Limit value
5. " * ": Fundamental frequency.
6. " # ": The radiated frequency is out of the restricted band.

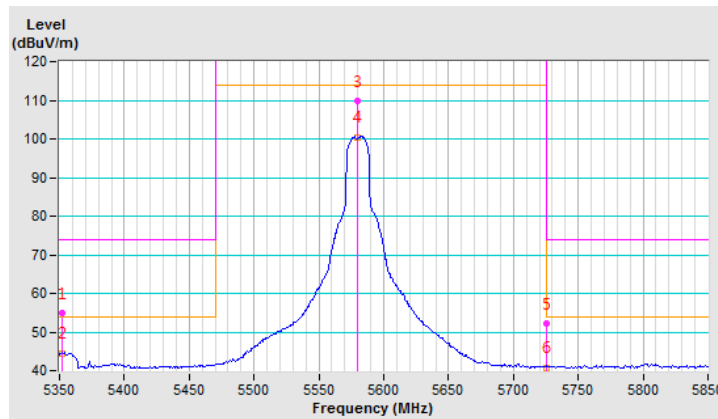

CHANNEL	TX Channel 116	DETECTOR FUNCTION	Peak (PK)
FREQUENCY RANGE	1GHz ~ 40GHz		Average (AV)

ANTENNA POLARITY & TEST DISTANCE: VERTICAL AT 3 M

NO.	FREQ. (MHz)	EMISSION LEVEL (dBuV/m)	LIMIT (dBuV/m)	MARGIN (dB)	ANTENNA HEIGHT (m)	TABLE ANGLE (Degree)	RAW VALUE (dBuV)	CORRECTION FACTOR (dB/m)
1	5352.00	53.4 PK	74.0	-20.6	1.09 V	294	49.87	3.53
2	5352.00	42.2 AV	54.0	-11.8	1.09 V	294	38.67	3.53
3	*5580.00	107.3 PK			1.09 V	294	103.39	3.91
4	*5580.00	98.5 AV			1.09 V	294	94.59	3.91
5	#5725.00	51.7 PK	74.0	-22.3	1.09 V	294	47.51	4.19
6	#5725.00	40.6 AV	54.0	-13.4	1.09 V	294	36.41	4.19

REMARKS:

1. Emission Level(dBuV/m) = Raw Value(dBuV) + Correction Factor(dB/m)
2. Correction Factor(dB/m) = Antenna Factor(dB/m) + Cable Factor(dB) – Pre-Amplifier Factor(dB)
3. The other emission levels were very low against the limit.
4. Margin value = Emission Level – Limit value
5. " * ": Fundamental frequency.
6. " # ": The radiated frequency is out of the restricted band.

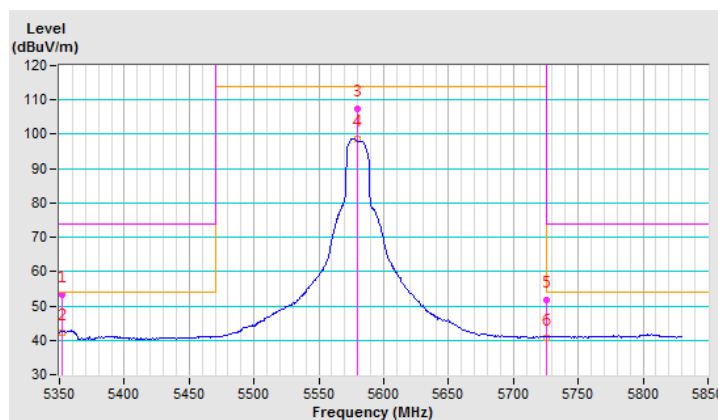

CHANNEL	TX Channel 140	DETECTOR FUNCTION	Peak (PK)
FREQUENCY RANGE	1GHz ~ 40GHz		Average (AV)

ANTENNA POLARITY & TEST DISTANCE: HORIZONTAL AT 3 M

NO.	FREQ. (MHz)	EMISSION LEVEL (dBuV/m)	LIMIT (dBuV/m)	MARGIN (dB)	ANTENNA HEIGHT (m)	TABLE ANGLE (Degree)	RAW VALUE (dBuV)	CORRECTION FACTOR (dB/m)
1	*5700.00	104.6 PK			1.00 H	278	100.41	4.19
2	*5700.00	95.3 AV			1.00 H	278	91.11	4.19
3	#5725.00	68.4 PK	74.0	-5.6	1.00 H	278	64.21	4.19
4	#5725.00	53.8 AV	54.0	-0.2	1.00 H	278	49.61	4.19

REMARKS:

1. Emission Level(dBuV/m) = Raw Value(dBuV) + Correction Factor(dB/m)
2. Correction Factor(dB/m) = Antenna Factor(dB/m) + Cable Factor(dB) – Pre-Amplifier Factor(dB)
3. The other emission levels were very low against the limit.
4. Margin value = Emission Level – Limit value
5. " * ": Fundamental frequency.
6. " # ": The radiated frequency is out of the restricted band.

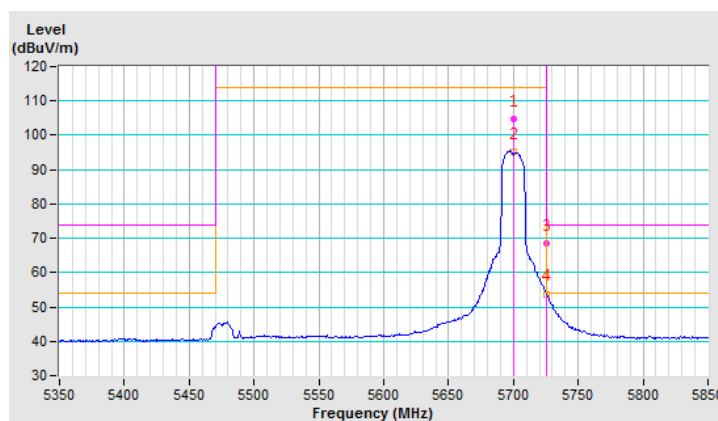

CHANNEL	TX Channel 140	DETECTOR FUNCTION	Peak (PK)
FREQUENCY RANGE	1GHz ~ 40GHz		Average (AV)

ANTENNA POLARITY & TEST DISTANCE: VERTICAL AT 3 M

NO.	FREQ. (MHz)	EMISSION LEVEL (dBuV/m)	LIMIT (dBuV/m)	MARGIN (dB)	ANTENNA HEIGHT (m)	TABLE ANGLE (Degree)	RAW VALUE (dBuV)	CORRECTION FACTOR (dB/m)
1	*5700.00	100.7 PK			1.09 V	294	96.51	4.19
2	*5700.00	91.5 AV			1.09 V	294	87.31	4.19
3	#5725.00	65.3 PK	74.0	-8.7	1.09 V	294	61.11	4.19
4	#5725.00	51.3 AV	54.0	-2.7	1.09 V	294	47.11	4.19

REMARKS:

1. Emission Level(dBuV/m) = Raw Value(dBuV) + Correction Factor(dB/m)
2. Correction Factor(dB/m) = Antenna Factor(dB/m) + Cable Factor(dB) – Pre-Amplifier Factor(dB)
3. The other emission levels were very low against the limit.
4. Margin value = Emission Level – Limit value
5. " * ": Fundamental frequency.
6. " # ": The radiated frequency is out of the restricted band.

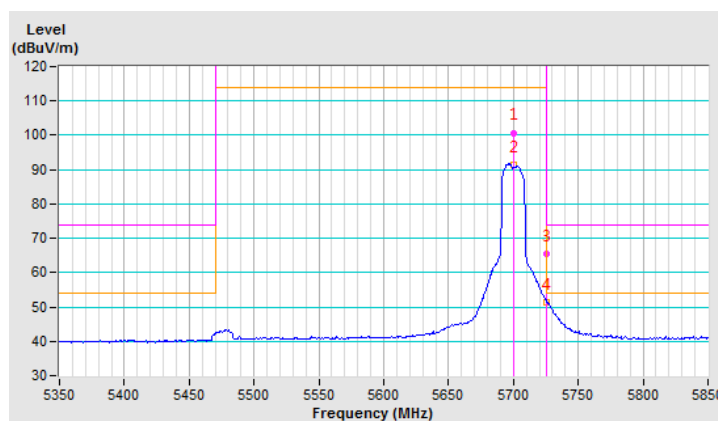

CHANNEL	TX Channel 149	DETECTOR FUNCTION	Peak (PK)
FREQUENCY RANGE	1GHz ~ 40GHz		Average (AV)

ANTENNA POLARITY & TEST DISTANCE: HORIZONTAL AT 3 M

NO.	FREQ. (MHz)	EMISSION LEVEL (dBuV/m)	LIMIT (dBuV/m)	MARGIN (dB)	ANTENNA HEIGHT (m)	TABLE ANGLE (Degree)	RAW VALUE (dBuV)	CORRECTION FACTOR (dB/m)
1	#5715.00	72.1 PK	74.0	-1.9	1.00 H	282	67.91	4.19
2	#5715.00	53.9 AV	54.0	-0.1	1.00 H	282	49.71	4.19
3	#5725.00	77.8 PK	78.2	-0.4	1.00 H	282	73.61	4.19
4	*5745.00	102.9 PK			1.00 H	282	98.71	4.19
5	*5745.00	94.0 AV			1.00 H	282	89.81	4.19

REMARKS:

1. Emission Level(dBuV/m) = Raw Value(dBuV) + Correction Factor(dB/m)
2. Correction Factor(dB/m) = Antenna Factor(dB/m) + Cable Factor(dB) – Pre-Amplifier Factor(dB)
3. The other emission levels were very low against the limit.
4. Margin value = Emission Level – Limit value
5. " * ": Fundamental frequency.
6. " # ": The radiated frequency is out of the restricted band.

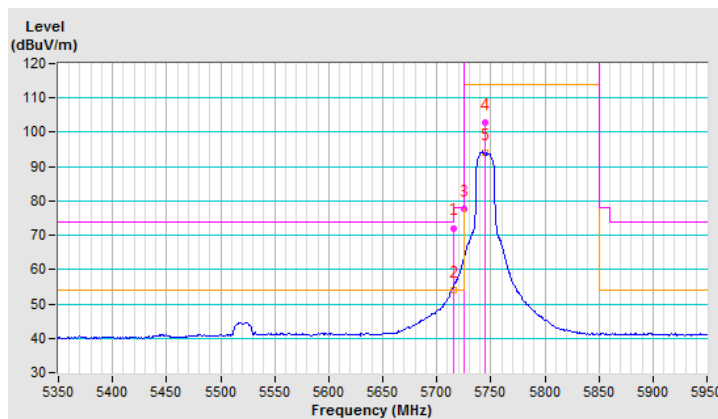

CHANNEL	TX Channel 149	DETECTOR FUNCTION	Peak (PK)
FREQUENCY RANGE	1GHz ~ 40GHz		Average (AV)

ANTENNA POLARITY & TEST DISTANCE: VERTICAL AT 3 M

NO.	FREQ. (MHz)	EMISSION LEVEL (dBuV/m)	LIMIT (dBuV/m)	MARGIN (dB)	ANTENNA HEIGHT (m)	TABLE ANGLE (Degree)	RAW VALUE (dBuV)	CORRECTION FACTOR (dB/m)
1	#5715.00	65.4 PK	74.0	-8.6	1.06 V	289	61.21	4.19
2	#5715.00	51.7 AV	54.0	-2.3	1.06 V	289	47.51	4.19
3	#5725.00	77.3 PK	78.2	-0.9	1.06 V	289	73.11	4.19
4	*5745.00	104.5 PK			1.06 V	289	100.31	4.19
5	*5745.00	94.9 AV			1.06 V	289	90.71	4.19

REMARKS:

1. Emission Level(dBuV/m) = Raw Value(dBuV) + Correction Factor(dB/m)
2. Correction Factor(dB/m) = Antenna Factor(dB/m) + Cable Factor(dB) – Pre-Amplifier Factor(dB)
3. The other emission levels were very low against the limit.
4. Margin value = Emission Level – Limit value
5. " * ": Fundamental frequency.
6. " # ": The radiated frequency is out of the restricted band.

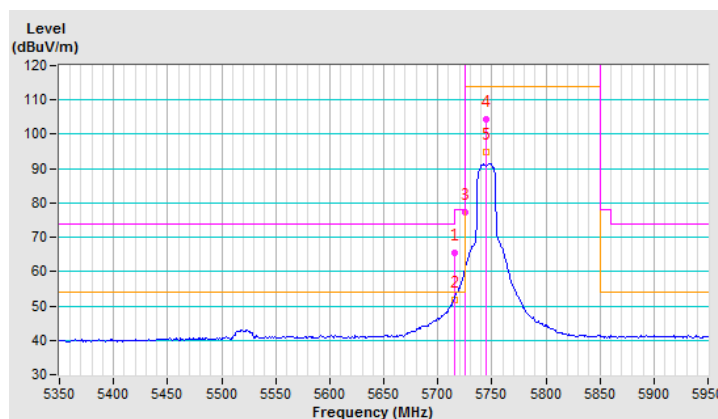

CHANNEL	TX Channel 157	DETECTOR FUNCTION	Peak (PK)
FREQUENCY RANGE	1GHz ~ 40GHz		Average (AV)

ANTENNA POLARITY & TEST DISTANCE: HORIZONTAL AT 3 M

NO.	FREQ. (MHz)	EMISSION LEVEL (dBuV/m)	LIMIT (dBuV/m)	MARGIN (dB)	ANTENNA HEIGHT (m)	TABLE ANGLE (Degree)	RAW VALUE (dBuV)	CORRECTION FACTOR (dB/m)
1	#5715.00	57.9 PK	74.0	-16.1	1.00 H	273	53.71	4.19
2	#5715.00	45.0 AV	54.0	-9.0	1.00 H	273	40.81	4.19
3	#5725.00	61.6 PK	78.2	-16.6	1.00 H	273	57.41	4.19
4	*5785.00	104.9 PK			1.00 H	273	100.72	4.18
5	*5785.00	96.5 AV			1.00 H	273	92.32	4.18
6	#5850.00	60.1 PK	78.2	-18.1	1.00 H	273	55.85	4.25
7	#5860.00	58.5 PK	74.0	-15.5	1.00 H	273	54.24	4.26
8	#5860.00	43.5 AV	54.0	-10.5	1.00 H	273	39.24	4.26

REMARKS:

1. Emission Level(dBuV/m) = Raw Value(dBuV) + Correction Factor(dB/m)
2. Correction Factor(dB/m) = Antenna Factor(dB/m) + Cable Factor(dB) – Pre-Amplifier Factor(dB)
3. The other emission levels were very low against the limit.
4. Margin value = Emission Level – Limit value
5. " * ": Fundamental frequency.
6. " # ": The radiated frequency is out of the restricted band.

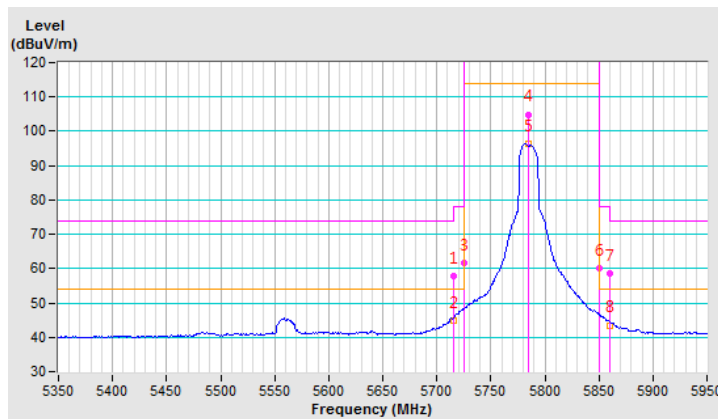

CHANNEL	TX Channel 157	DETECTOR FUNCTION	Peak (PK)
FREQUENCY RANGE	1GHz ~ 40GHz		Average (AV)

ANTENNA POLARITY & TEST DISTANCE: VERTICAL AT 3 M

NO.	FREQ. (MHz)	EMISSION LEVEL (dBuV/m)	LIMIT (dBuV/m)	MARGIN (dB)	ANTENNA HEIGHT (m)	TABLE ANGLE (Degree)	RAW VALUE (dBuV)	CORRECTION FACTOR (dB/m)
1	#5715.00	57.3 PK	74.0	-16.7	1.02 V	276	53.11	4.19
2	#5715.00	44.8 AV	54.0	-9.2	1.02 V	276	40.61	4.19
3	#5725.00	61.6 PK	78.2	-16.6	1.02 V	276	57.41	4.19
4	*5785.00	105.8 PK			1.02 V	276	101.62	4.18
5	*5785.00	96.5 AV			1.02 V	276	92.32	4.18
6	#5850.00	62.9 PK	78.2	-15.3	1.02 V	276	58.65	4.25
7	#5860.00	60.4 PK	74.0	-13.6	1.02 V	276	56.14	4.26
8	#5860.00	44.4 AV	54.0	-9.6	1.02 V	276	40.14	4.26

REMARKS:

1. Emission Level(dBuV/m) = Raw Value(dBuV) + Correction Factor(dB/m)
2. Correction Factor(dB/m) = Antenna Factor(dB/m) + Cable Factor(dB) – Pre-Amplifier Factor(dB)
3. The other emission levels were very low against the limit.
4. Margin value = Emission Level – Limit value
5. " * ": Fundamental frequency.
6. " # ": The radiated frequency is out of the restricted band.

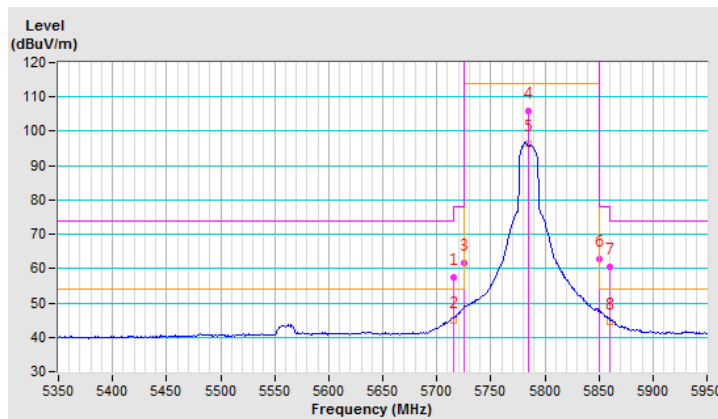

CHANNEL	TX Channel 165	DETECTOR FUNCTION	Peak (PK)
FREQUENCY RANGE	1GHz ~ 40GHz		Average (AV)

ANTENNA POLARITY & TEST DISTANCE: HORIZONTAL AT 3 M

NO.	FREQ. (MHz)	EMISSION LEVEL (dBuV/m)	LIMIT (dBuV/m)	MARGIN (dB)	ANTENNA HEIGHT (m)	TABLE ANGLE (Degree)	RAW VALUE (dBuV)	CORRECTION FACTOR (dB/m)
1	*5825.00	104.9 PK			1.07 H	48	100.68	4.22
2	*5825.00	95.6 AV			1.07 H	48	91.38	4.22
3	#5850.00	71.9 PK	78.2	-6.3	1.07 H	48	67.65	4.25
4	#5860.00	70.8 PK	74.0	-3.2	1.07 H	48	66.54	4.26
5	#5860.00	53.8 AV	54.0	-0.2	1.07 H	48	49.54	4.26

REMARKS:

1. Emission Level(dBuV/m) = Raw Value(dBuV) + Correction Factor(dB/m)
2. Correction Factor(dB/m) = Antenna Factor(dB/m) + Cable Factor(dB) – Pre-Amplifier Factor(dB)
3. The other emission levels were very low against the limit.
4. Margin value = Emission Level – Limit value
5. " * ": Fundamental frequency.
6. " # ": The radiated frequency is out of the restricted band.

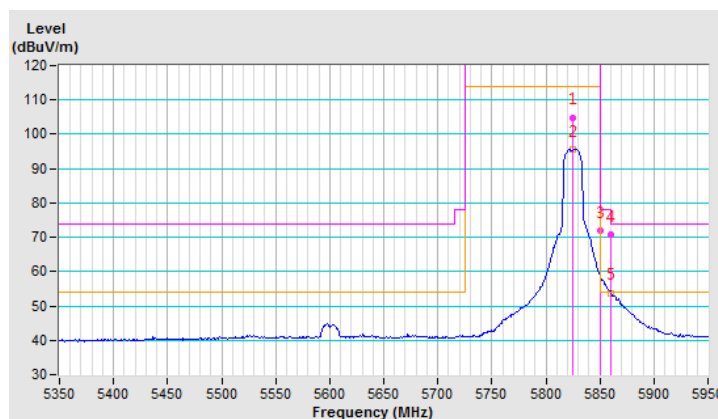

CHANNEL	TX Channel 165	DETECTOR FUNCTION	Peak (PK)
FREQUENCY RANGE	1GHz ~ 40GHz		Average (AV)

ANTENNA POLARITY & TEST DISTANCE: VERTICAL AT 3 M

NO.	FREQ. (MHz)	EMISSION LEVEL (dBuV/m)	LIMIT (dBuV/m)	MARGIN (dB)	ANTENNA HEIGHT (m)	TABLE ANGLE (Degree)	RAW VALUE (dBuV)	CORRECTION FACTOR (dB/m)
1	*5825.00	104.5 PK			1.00 V	277	100.28	4.22
2	*5825.00	95.1 AV			1.00 V	277	90.88	4.22
3	#5850.00	73.9 PK	78.2	-4.3	1.00 V	277	69.65	4.25
4	#5860.00	71.8 PK	74.0	-2.2	1.00 V	277	67.54	4.26
5	#5860.00	53.3 AV	54.0	-0.7	1.00 V	277	49.04	4.26

REMARKS:

1. Emission Level(dBuV/m) = Raw Value(dBuV) + Correction Factor(dB/m)
2. Correction Factor(dB/m) = Antenna Factor(dB/m) + Cable Factor(dB) – Pre-Amplifier Factor(dB)
3. The other emission levels were very low against the limit.
4. Margin value = Emission Level – Limit value
5. " * ": Fundamental frequency.
6. " # ": The radiated frequency is out of the restricted band.

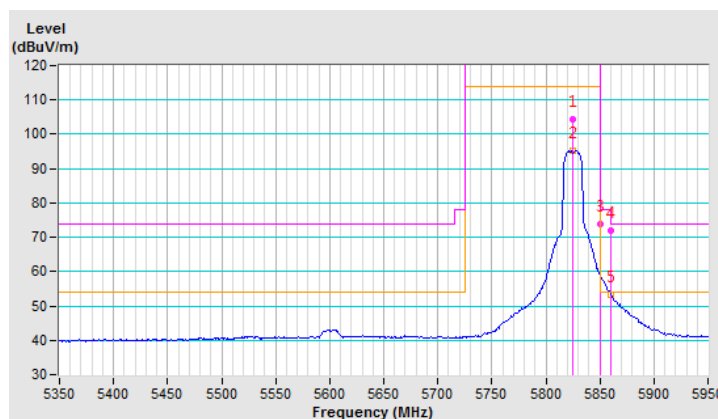

802.11n (20MHz)

CHANNEL	TX Channel 36	DETECTOR FUNCTION	Peak (PK)
FREQUENCY RANGE	1GHz ~ 40GHz		Average (AV)

ANTENNA POLARITY & TEST DISTANCE: HORIZONTAL AT 3 M								
NO.	FREQ. (MHz)	EMISSION LEVEL (dBuV/m)	LIMIT (dBuV/m)	MARGIN (dB)	ANTENNA HEIGHT (m)	TABLE ANGLE (Degree)	RAW VALUE (dBuV)	CORRECTION FACTOR (dB/m)
1	5150.00	66.8 PK	74.0	-7.2	1.00 H	47	63.82	2.98
2	5150.00	53.3 AV	54.0	-0.7	1.00 H	47	50.32	2.98
3	*5180.00	107.9 PK			1.00 H	47	104.84	3.06
4	*5180.00	98.4 AV			1.00 H	47	95.34	3.06

REMARKS:

1. Emission Level(dBuV/m) = Raw Value(dBuV) + Correction Factor(dB/m)
2. Correction Factor(dB/m) = Antenna Factor(dB/m) + Cable Factor(dB) – Pre-Amplifier Factor(dB)
3. The other emission levels were very low against the limit.
4. Margin value = Emission Level – Limit value
5. " * ": Fundamental frequency.

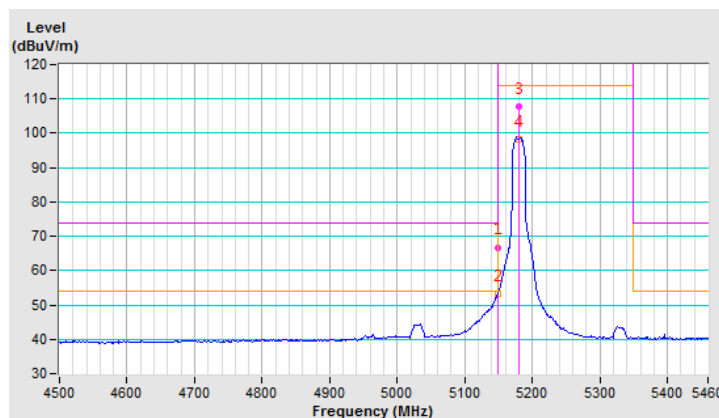

CHANNEL	TX Channel 36	DETECTOR FUNCTION	Peak (PK)
FREQUENCY RANGE	1GHz ~ 40GHz		Average (AV)

ANTENNA POLARITY & TEST DISTANCE: VERTICAL AT 3 M								
NO.	FREQ. (MHz)	EMISSION LEVEL (dBuV/m)	LIMIT (dBuV/m)	MARGIN (dB)	ANTENNA HEIGHT (m)	TABLE ANGLE (Degree)	RAW VALUE (dBuV)	CORRECTION FACTOR (dB/m)
1	5150.00	61.8 PK	74.0	-12.2	1.00 V	49	58.82	2.98
2	5150.00	51.3 AV	54.0	-2.7	1.00 V	49	48.32	2.98
3	*5180.00	106.2 PK			1.00 V	49	103.14	3.06
4	*5180.00	96.8 AV			1.00 V	49	93.74	3.06

REMARKS:

1. Emission Level(dBuV/m) = Raw Value(dBuV) + Correction Factor(dB/m)
2. Correction Factor(dB/m) = Antenna Factor(dB/m) + Cable Factor(dB) – Pre-Amplifier Factor(dB)
3. The other emission levels were very low against the limit.
4. Margin value = Emission Level – Limit value
5. " * ": Fundamental frequency.

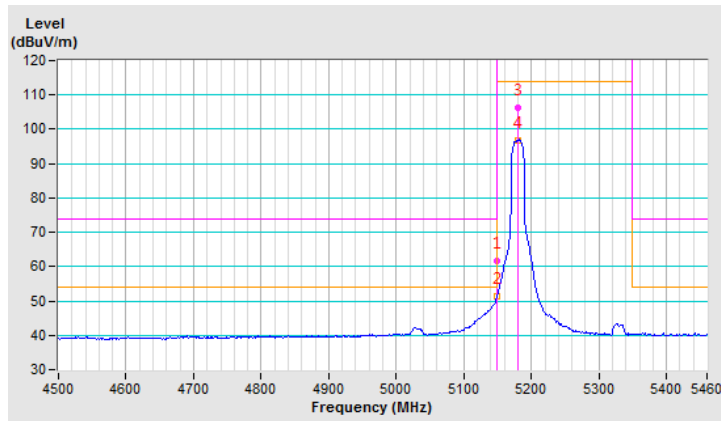

CHANNEL	TX Channel 40	DETECTOR FUNCTION	Peak (PK)
FREQUENCY RANGE	1GHz ~ 40GHz		Average (AV)

ANTENNA POLARITY & TEST DISTANCE: HORIZONTAL AT 3 M

NO.	FREQ. (MHz)	EMISSION LEVEL (dBuV/m)	LIMIT (dBuV/m)	MARGIN (dB)	ANTENNA HEIGHT (m)	TABLE ANGLE (Degree)	RAW VALUE (dBuV)	CORRECTION FACTOR (dB/m)
1	5150.00	65.3 PK	74.0	-8.7	1.08 H	46	62.32	2.98
2	5150.00	53.6 AV	54.0	-0.4	1.08 H	46	50.62	2.98
3	*5200.00	111.3 PK			1.08 H	46	108.20	3.10
4	*5200.00	101.9 AV			1.08 H	46	98.80	3.10
5	5350.00	54.7 PK	74.0	-19.3	1.08 H	46	51.19	3.51
6	5350.00	44.9 AV	54.0	-9.1	1.08 H	46	41.39	3.51

REMARKS:

1. Emission Level(dBuV/m) = Raw Value(dBuV) + Correction Factor(dB/m)
2. Correction Factor(dB/m) = Antenna Factor(dB/m) + Cable Factor(dB) – Pre-Amplifier Factor(dB)
3. The other emission levels were very low against the limit.
4. Margin value = Emission Level – Limit value
5. " * ": Fundamental frequency.

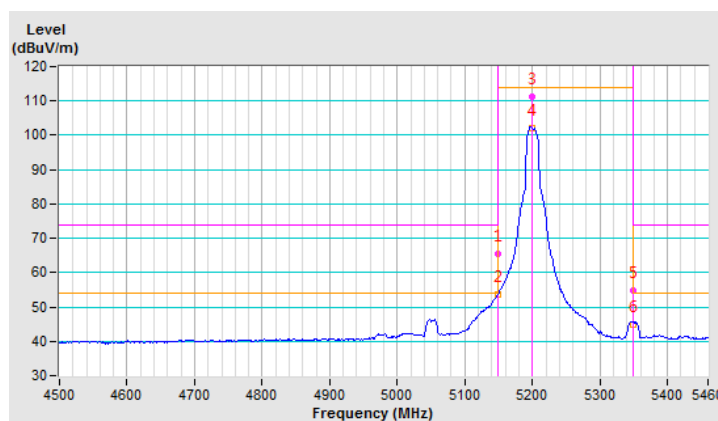

CHANNEL	TX Channel 40	DETECTOR FUNCTION	Peak (PK)
FREQUENCY RANGE	1GHz ~ 40GHz		Average (AV)

ANTENNA POLARITY & TEST DISTANCE: VERTICAL AT 3 M

NO.	FREQ. (MHz)	EMISSION LEVEL (dBuV/m)	LIMIT (dBuV/m)	MARGIN (dB)	ANTENNA HEIGHT (m)	TABLE ANGLE (Degree)	RAW VALUE (dBuV)	CORRECTION FACTOR (dB/m)
1	5150.00	66.0 PK	74.0	-8.0	1.05 V	49	63.02	2.98
2	5150.00	51.2 AV	54.0	-2.8	1.05 V	49	48.22	2.98
3	*5200.00	108.6 PK			1.05 V	49	105.50	3.10
4	*5200.00	99.6 AV			1.05 V	49	96.50	3.10
5	5350.00	54.6 PK	74.0	-19.4	1.05 V	49	51.09	3.51
6	5350.00	44.9 AV	54.0	-9.1	1.05 V	49	41.39	3.51

REMARKS:

1. Emission Level(dBuV/m) = Raw Value(dBuV) + Correction Factor(dB/m)
2. Correction Factor(dB/m) = Antenna Factor(dB/m) + Cable Factor(dB) – Pre-Amplifier Factor(dB)
3. The other emission levels were very low against the limit.
4. Margin value = Emission Level – Limit value
5. " * ": Fundamental frequency.

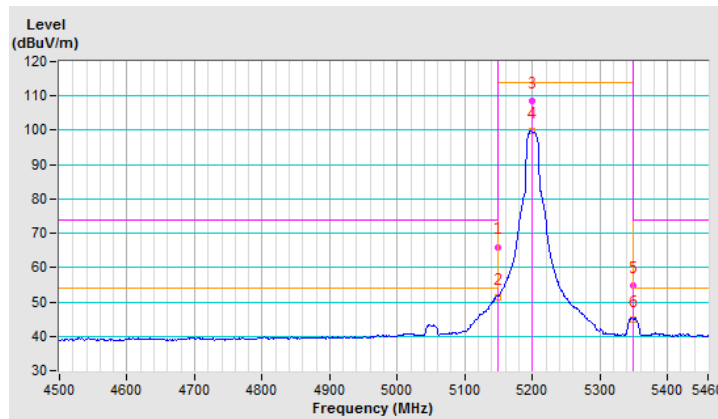

CHANNEL	TX Channel 48	DETECTOR FUNCTION	Peak (PK)
FREQUENCY RANGE	1GHz ~ 40GHz		Average (AV)

ANTENNA POLARITY & TEST DISTANCE: HORIZONTAL AT 3 M

NO.	FREQ. (MHz)	EMISSION LEVEL (dBuV/m)	LIMIT (dBuV/m)	MARGIN (dB)	ANTENNA HEIGHT (m)	TABLE ANGLE (Degree)	RAW VALUE (dBuV)	CORRECTION FACTOR (dB/m)
1	5150.00	58.1 PK	74.0	-15.9	1.08 H	47	55.12	2.98
2	5150.00	47.4 AV	54.0	-6.6	1.08 H	47	44.42	2.98
3	*5240.00	112.6 PK			1.08 H	47	109.39	3.21
4	*5240.00	102.7 AV			1.08 H	47	99.49	3.21
5	5390.00	55.5 PK	74.0	-18.5	1.08 H	47	51.87	3.63
6	5390.00	45.6 AV	54.0	-8.4	1.08 H	47	41.97	3.63

REMARKS:

1. Emission Level(dBuV/m) = Raw Value(dBuV) + Correction Factor(dB/m)
2. Correction Factor(dB/m) = Antenna Factor(dB/m) + Cable Factor(dB) – Pre-Amplifier Factor(dB)
3. The other emission levels were very low against the limit.
4. Margin value = Emission Level – Limit value
5. " * ": Fundamental frequency.

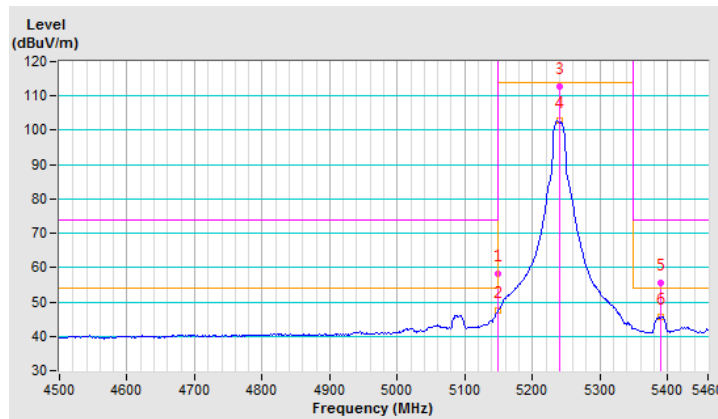

CHANNEL	TX Channel 48	DETECTOR FUNCTION	Peak (PK)
FREQUENCY RANGE	1GHz ~ 40GHz		Average (AV)

ANTENNA POLARITY & TEST DISTANCE: VERTICAL AT 3 M

NO.	FREQ. (MHz)	EMISSION LEVEL (dBuV/m)	LIMIT (dBuV/m)	MARGIN (dB)	ANTENNA HEIGHT (m)	TABLE ANGLE (Degree)	RAW VALUE (dBuV)	CORRECTION FACTOR (dB/m)
1	5150.00	55.7 PK	74.0	-18.3	1.04 V	51	52.72	2.98
2	5150.00	44.7 AV	54.0	-9.3	1.04 V	51	41.72	2.98
3	*5240.00	110.7 PK			1.04 V	51	107.49	3.21
4	*5240.00	101.1 AV			1.04 V	51	97.89	3.21
5	5390.00	55.7 PK	74.0	-18.3	1.04 V	51	52.07	3.63
6	5390.00	44.9 AV	54.0	-9.1	1.04 V	51	41.27	3.63

REMARKS:

1. Emission Level(dBuV/m) = Raw Value(dBuV) + Correction Factor(dB/m)
2. Correction Factor(dB/m) = Antenna Factor(dB/m) + Cable Factor(dB) – Pre-Amplifier Factor(dB)
3. The other emission levels were very low against the limit.
4. Margin value = Emission Level – Limit value
5. " * ": Fundamental frequency.

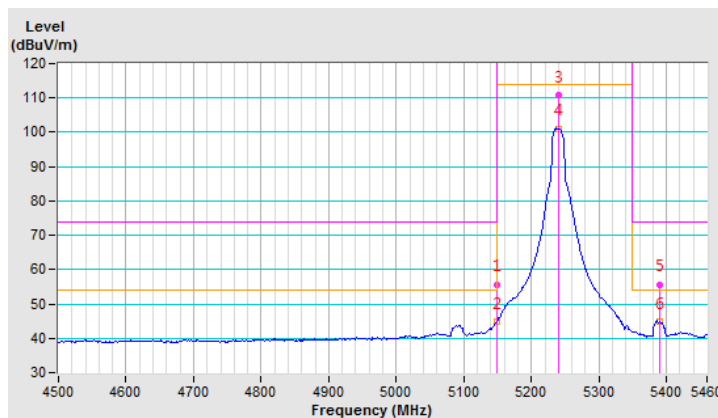

CHANNEL	TX Channel 52	DETECTOR FUNCTION	Peak (PK)
FREQUENCY RANGE	1GHz ~ 40GHz		Average (AV)

ANTENNA POLARITY & TEST DISTANCE: HORIZONTAL AT 3 M

NO.	FREQ. (MHz)	EMISSION LEVEL (dBuV/m)	LIMIT (dBuV/m)	MARGIN (dB)	ANTENNA HEIGHT (m)	TABLE ANGLE (Degree)	RAW VALUE (dBuV)	CORRECTION FACTOR (dB/m)
1	5115.00	54.5 PK	74.0	-19.5	1.04 H	45	51.60	2.90
2	5115.00	45.5 AV	54.0	-8.5	1.04 H	45	42.60	2.90
3	*5260.00	111.6 PK			1.04 H	45	108.34	3.26
4	*5260.00	102.3 AV			1.04 H	45	99.04	3.26
5	5350.00	57.1 PK	74.0	-16.9	1.04 H	45	53.59	3.51
6	5350.00	46.4 AV	54.0	-7.6	1.04 H	45	42.89	3.51

REMARKS:

1. Emission Level(dBuV/m) = Raw Value(dBuV) + Correction Factor(dB/m)
2. Correction Factor(dB/m) = Antenna Factor(dB/m) + Cable Factor(dB) – Pre-Amplifier Factor(dB)
3. The other emission levels were very low against the limit.
4. Margin value = Emission Level – Limit value
5. " * ": Fundamental frequency.

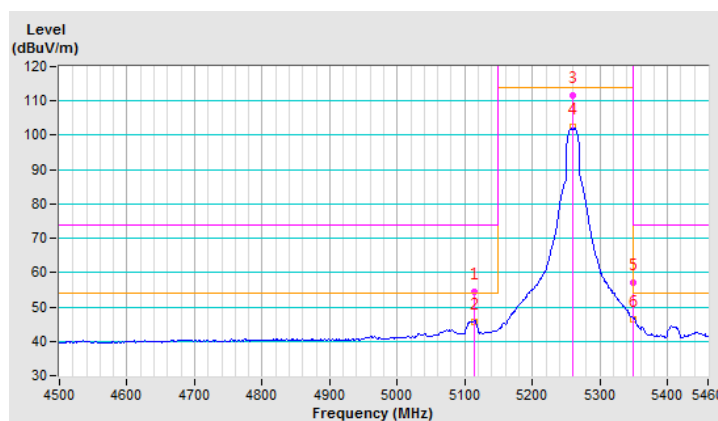

CHANNEL	TX Channel 52	DETECTOR FUNCTION	Peak (PK)
FREQUENCY RANGE	1GHz ~ 40GHz		Average (AV)

ANTENNA POLARITY & TEST DISTANCE: VERTICAL AT 3 M

NO.	FREQ. (MHz)	EMISSION LEVEL (dBuV/m)	LIMIT (dBuV/m)	MARGIN (dB)	ANTENNA HEIGHT (m)	TABLE ANGLE (Degree)	RAW VALUE (dBuV)	CORRECTION FACTOR (dB/m)
1	5115.00	54.3 PK	74.0	-19.7	1.00 V	42	51.40	2.90
2	5115.00	44.2 AV	54.0	-9.8	1.00 V	42	41.30	2.90
3	*5260.00	110.2 PK			1.00 V	42	106.94	3.26
4	*5260.00	100.9 AV			1.00 V	42	97.64	3.26
5	5350.00	56.7 PK	74.0	-17.3	1.00 V	42	53.19	3.51
6	5350.00	44.7 AV	54.0	-9.3	1.00 V	42	41.19	3.51

REMARKS:

1. Emission Level(dBuV/m) = Raw Value(dBuV) + Correction Factor(dB/m)
2. Correction Factor(dB/m) = Antenna Factor(dB/m) + Cable Factor(dB) – Pre-Amplifier Factor(dB)
3. The other emission levels were very low against the limit.
4. Margin value = Emission Level – Limit value
5. " * ": Fundamental frequency.

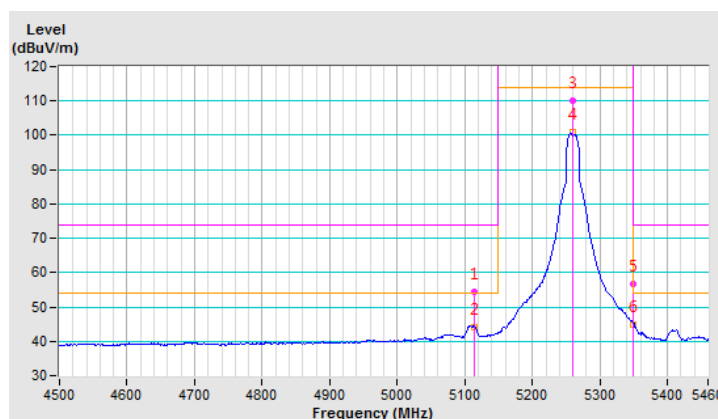

CHANNEL	TX Channel 60	DETECTOR FUNCTION	Peak (PK)
FREQUENCY RANGE	1GHz ~ 40GHz		Average (AV)

ANTENNA POLARITY & TEST DISTANCE: HORIZONTAL AT 3 M

NO.	FREQ. (MHz)	EMISSION LEVEL (dBuV/m)	LIMIT (dBuV/m)	MARGIN (dB)	ANTENNA HEIGHT (m)	TABLE ANGLE (Degree)	RAW VALUE (dBuV)	CORRECTION FACTOR (dB/m)
1	5150.00	54.2 PK	74.0	-19.8	1.09 H	45	51.22	2.98
2	5150.00	44.1 AV	54.0	-9.9	1.09 H	45	41.12	2.98
3	*5300.00	111.5 PK			1.09 H	45	108.13	3.37
4	*5300.00	102.5 AV			1.09 H	45	99.13	3.37
5	5350.00	68.2 PK	74.0	-5.8	1.09 H	45	64.69	3.51
6	5350.00	53.9 AV	54.0	-0.1	1.09 H	45	50.39	3.51

REMARKS:

1. Emission Level(dBuV/m) = Raw Value(dBuV) + Correction Factor(dB/m)
2. Correction Factor(dB/m) = Antenna Factor(dB/m) + Cable Factor(dB) – Pre-Amplifier Factor(dB)
3. The other emission levels were very low against the limit.
4. Margin value = Emission Level – Limit value
5. " * ": Fundamental frequency.

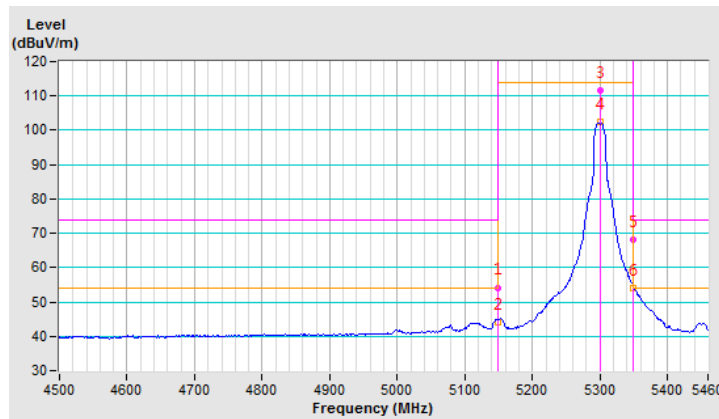

CHANNEL	TX Channel 60	DETECTOR FUNCTION	Peak (PK)
FREQUENCY RANGE	1GHz ~ 40GHz		Average (AV)

ANTENNA POLARITY & TEST DISTANCE: VERTICAL AT 3 M

NO.	FREQ. (MHz)	EMISSION LEVEL (dBuV/m)	LIMIT (dBuV/m)	MARGIN (dB)	ANTENNA HEIGHT (m)	TABLE ANGLE (Degree)	RAW VALUE (dBuV)	CORRECTION FACTOR (dB/m)
1	5150.00	51.6 PK	74.0	-22.4	1.00 V	50	48.62	2.98
2	5150.00	42.3 AV	54.0	-11.7	1.00 V	50	39.32	2.98
3	*5300.00	109.2 PK			1.00 V	50	105.83	3.37
4	*5300.00	99.9 AV			1.00 V	50	96.53	3.37
5	5350.00	63.5 PK	74.0	-10.5	1.00 V	50	59.99	3.51
6	5350.00	51.4 AV	54.0	-2.6	1.00 V	50	47.89	3.51

REMARKS:

1. Emission Level(dBuV/m) = Raw Value(dBuV) + Correction Factor(dB/m)
2. Correction Factor(dB/m) = Antenna Factor(dB/m) + Cable Factor(dB) – Pre-Amplifier Factor(dB)
3. The other emission levels were very low against the limit.
4. Margin value = Emission Level – Limit value
5. " * ": Fundamental frequency.

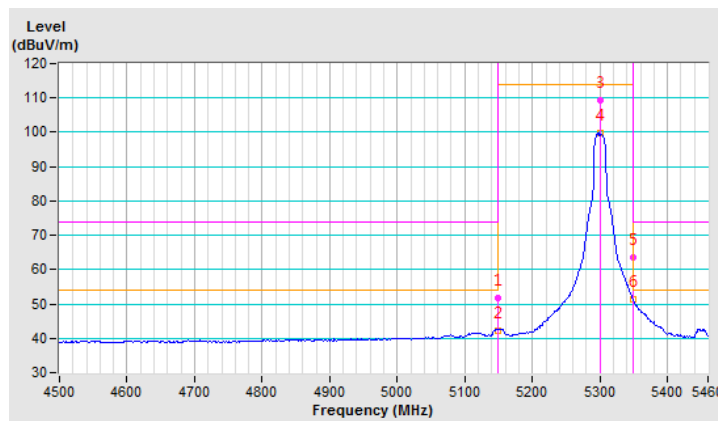

CHANNEL	TX Channel 64	DETECTOR FUNCTION	Peak (PK)
FREQUENCY RANGE	1GHz ~ 40GHz		Average (AV)

ANTENNA POLARITY & TEST DISTANCE: HORIZONTAL AT 3 M

NO.	FREQ. (MHz)	EMISSION LEVEL (dBuV/m)	LIMIT (dBuV/m)	MARGIN (dB)	ANTENNA HEIGHT (m)	TABLE ANGLE (Degree)	RAW VALUE (dBuV)	CORRECTION FACTOR (dB/m)
1	*5320.00	108.4 PK			1.09 H	280	104.97	3.43
2	*5320.00	98.9 AV			1.09 H	280	95.47	3.43
3	5350.00	68.2 PK	74.0	-5.8	1.09 H	280	64.69	3.51
4	5350.00	53.1 AV	54.0	-0.9	1.09 H	280	49.59	3.51

REMARKS:

1. Emission Level(dBuV/m) = Raw Value(dBuV) + Correction Factor(dB/m)
2. Correction Factor(dB/m) = Antenna Factor(dB/m) + Cable Factor(dB) – Pre-Amplifier Factor(dB)
3. The other emission levels were very low against the limit.
4. Margin value = Emission Level – Limit value
5. " * ": Fundamental frequency.

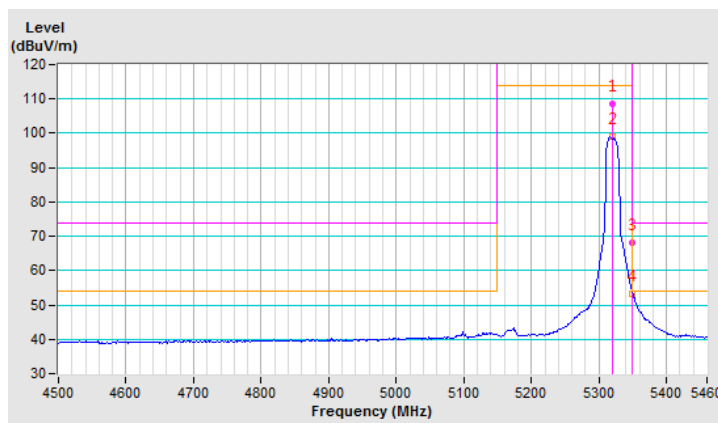

CHANNEL	TX Channel 64	DETECTOR FUNCTION	Peak (PK)
FREQUENCY RANGE	1GHz ~ 40GHz		Average (AV)

ANTENNA POLARITY & TEST DISTANCE: VERTICAL AT 3 M

NO.	FREQ. (MHz)	EMISSION LEVEL (dBuV/m)	LIMIT (dBuV/m)	MARGIN (dB)	ANTENNA HEIGHT (m)	TABLE ANGLE (Degree)	RAW VALUE (dBuV)	CORRECTION FACTOR (dB/m)
1	*5320.00	106.9 PK			1.02 V	49	103.47	3.43
2	*5320.00	97.6 AV			1.02 V	49	94.17	3.43
3	5350.00	66.5 PK	74.0	-7.5	1.02 V	49	62.99	3.51
4	5350.00	51.7 AV	54.0	-2.3	1.02 V	49	48.19	3.51

REMARKS:

1. Emission Level(dBuV/m) = Raw Value(dBuV) + Correction Factor(dB/m)
2. Correction Factor(dB/m) = Antenna Factor(dB/m) + Cable Factor(dB) – Pre-Amplifier Factor(dB)
3. The other emission levels were very low against the limit.
4. Margin value = Emission Level – Limit value
5. " * ": Fundamental frequency.

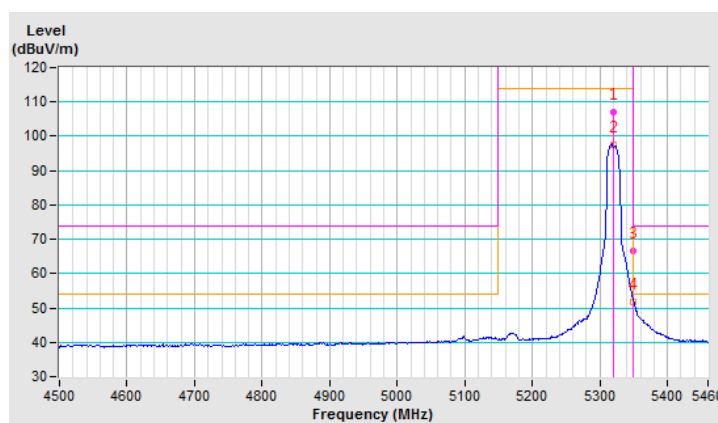

CHANNEL	TX Channel 100	DETECTOR FUNCTION	Peak (PK)
FREQUENCY RANGE	1GHz ~ 40GHz		Average (AV)

ANTENNA POLARITY & TEST DISTANCE: HORIZONTAL AT 3 M

NO.	FREQ. (MHz)	EMISSION LEVEL (dBuV/m)	LIMIT (dBuV/m)	MARGIN (dB)	ANTENNA HEIGHT (m)	TABLE ANGLE (Degree)	RAW VALUE (dBuV)	CORRECTION FACTOR (dB/m)
1	#5470.00	70.3 PK	74.0	-3.7	1.00 H	279	66.54	3.76
2	#5470.00	53.9 AV	54.0	-0.1	1.00 H	279	50.14	3.76
3	*5500.00	107.8 PK			1.00 H	279	104.01	3.79
4	*5500.00	98.8 AV			1.00 H	279	95.01	3.79

REMARKS:

1. Emission Level(dBuV/m) = Raw Value(dBuV) + Correction Factor(dB/m)
2. Correction Factor(dB/m) = Antenna Factor(dB/m) + Cable Factor(dB) – Pre-Amplifier Factor(dB)
3. The other emission levels were very low against the limit.
4. Margin value = Emission Level – Limit value
5. " * ": Fundamental frequency.
6. " # ": The radiated frequency is out of the restricted band.

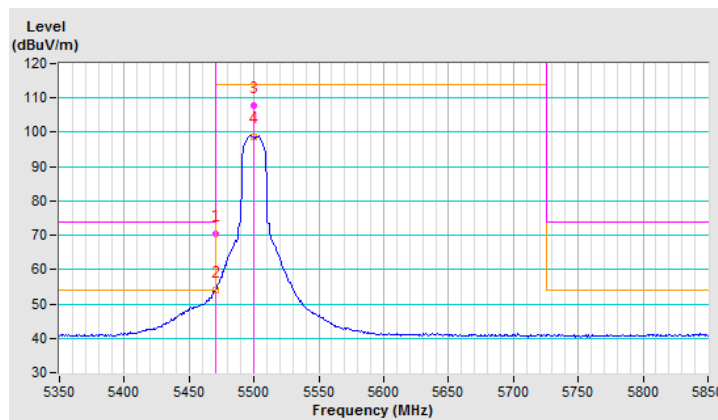

CHANNEL	TX Channel 100	DETECTOR FUNCTION	Peak (PK)
FREQUENCY RANGE	1GHz ~ 40GHz		Average (AV)

ANTENNA POLARITY & TEST DISTANCE: VERTICAL AT 3 M

NO.	FREQ. (MHz)	EMISSION LEVEL (dBuV/m)	LIMIT (dBuV/m)	MARGIN (dB)	ANTENNA HEIGHT (m)	TABLE ANGLE (Degree)	RAW VALUE (dBuV)	CORRECTION FACTOR (dB/m)
1	#5470.00	66.2 PK	74.0	-7.8	1.00 V	50	62.44	3.76
2	#5470.00	51.2 AV	54.0	-2.8	1.00 V	50	47.44	3.76
3	*5500.00	106.0 PK			1.00 V	50	102.21	3.79
4	*5500.00	96.5 AV			1.00 V	50	92.71	3.79

REMARKS:

1. Emission Level(dBuV/m) = Raw Value(dBuV) + Correction Factor(dB/m)
2. Correction Factor(dB/m) = Antenna Factor(dB/m) + Cable Factor(dB) – Pre-Amplifier Factor(dB)
3. The other emission levels were very low against the limit.
4. Margin value = Emission Level – Limit value
5. " * ": Fundamental frequency.
6. " # ": The radiated frequency is out of the restricted band.

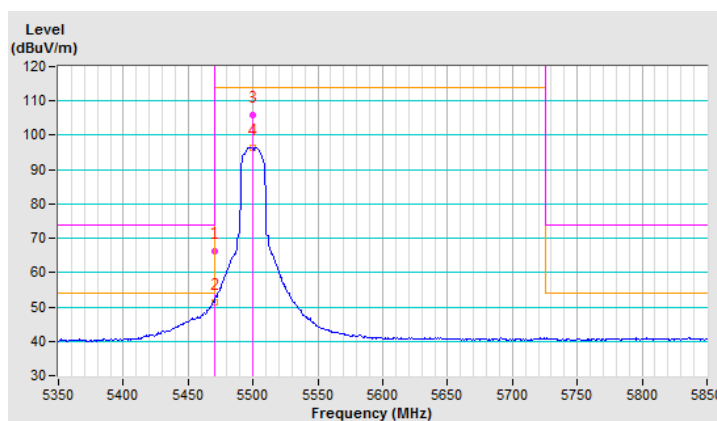

CHANNEL	TX Channel 116	DETECTOR FUNCTION	Peak (PK)
FREQUENCY RANGE	1GHz ~ 40GHz		Average (AV)

ANTENNA POLARITY & TEST DISTANCE: HORIZONTAL AT 3 M

NO.	FREQ. (MHz)	EMISSION LEVEL (dBuV/m)	LIMIT (dBuV/m)	MARGIN (dB)	ANTENNA HEIGHT (m)	TABLE ANGLE (Degree)	RAW VALUE (dBuV)	CORRECTION FACTOR (dB/m)
1	5352.00	55.3 PK	74.0	-18.7	1.00 H	279	51.77	3.53
2	5352.00	44.2 AV	54.0	-9.8	1.00 H	279	40.67	3.53
3	*5580.00	109.3 PK			1.00 H	279	105.39	3.91
4	*5580.00	99.5 AV			1.00 H	279	95.59	3.91
5	#5725.00	51.8 PK	74.0	-22.2	1.00 H	279	47.61	4.19
6	#5725.00	40.6 AV	54.0	-13.4	1.00 H	279	36.41	4.19

REMARKS:

1. Emission Level(dBuV/m) = Raw Value(dBuV) + Correction Factor(dB/m)
2. Correction Factor(dB/m) = Antenna Factor(dB/m) + Cable Factor(dB) – Pre-Amplifier Factor(dB)
3. The other emission levels were very low against the limit.
4. Margin value = Emission Level – Limit value
5. " * ": Fundamental frequency.
6. " # ": The radiated frequency is out of the restricted band.

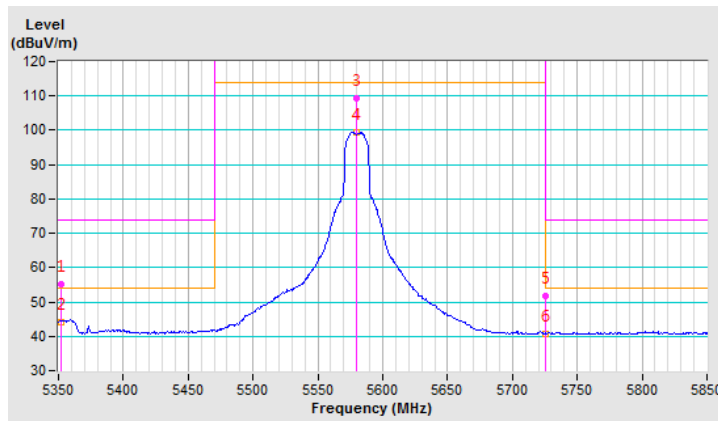

CHANNEL	TX Channel 116	DETECTOR FUNCTION	Peak (PK)
FREQUENCY RANGE	1GHz ~ 40GHz		Average (AV)

ANTENNA POLARITY & TEST DISTANCE: VERTICAL AT 3 M

NO.	FREQ. (MHz)	EMISSION LEVEL (dBuV/m)	LIMIT (dBuV/m)	MARGIN (dB)	ANTENNA HEIGHT (m)	TABLE ANGLE (Degree)	RAW VALUE (dBuV)	CORRECTION FACTOR (dB/m)
1	5352.00	52.1 PK	74.0	-21.9	1.00 V	51	48.57	3.53
2	5352.00	42.7 AV	54.0	-11.3	1.00 V	51	39.17	3.53
3	*5580.00	106.2 PK			1.00 V	51	102.29	3.91
4	*5580.00	97.3 AV			1.00 V	51	93.39	3.91
5	#5725.00	52.3 PK	74.0	-21.7	1.00 V	51	48.11	4.19
6	#5725.00	40.2 AV	54.0	-13.8	1.00 V	51	36.01	4.19

REMARKS:

1. Emission Level(dBuV/m) = Raw Value(dBuV) + Correction Factor(dB/m)
2. Correction Factor(dB/m) = Antenna Factor(dB/m) + Cable Factor(dB) – Pre-Amplifier Factor(dB)
3. The other emission levels were very low against the limit.
4. Margin value = Emission Level – Limit value
5. " * ": Fundamental frequency.
6. " # ": The radiated frequency is out of the restricted band.

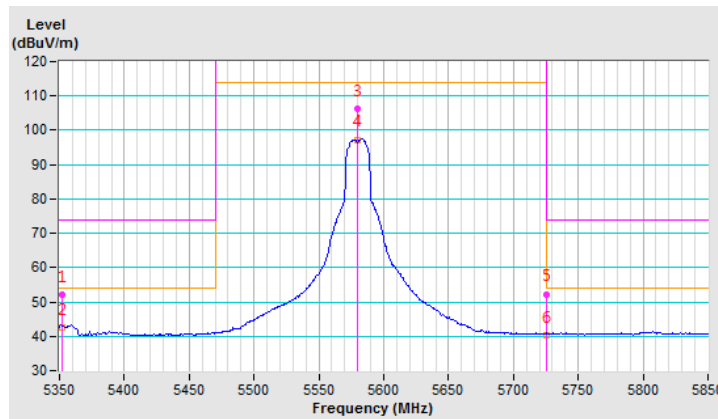

CHANNEL	TX Channel 140	DETECTOR FUNCTION	Peak (PK)
FREQUENCY RANGE	1GHz ~ 40GHz		Average (AV)

ANTENNA POLARITY & TEST DISTANCE: HORIZONTAL AT 3 M

NO.	FREQ. (MHz)	EMISSION LEVEL (dBuV/m)	LIMIT (dBuV/m)	MARGIN (dB)	ANTENNA HEIGHT (m)	TABLE ANGLE (Degree)	RAW VALUE (dBuV)	CORRECTION FACTOR (dB/m)
1	*5700.00	103.8 PK			1.18 H	49	99.61	4.19
2	*5700.00	94.7 AV			1.18 H	49	90.51	4.19
3	#5725.00	69.2 PK	74.0	-4.8	1.18 H	49	65.01	4.19
4	#5725.00	53.6 AV	54.0	-0.4	1.18 H	49	49.41	4.19

REMARKS:

1. Emission Level(dBuV/m) = Raw Value(dBuV) + Correction Factor(dB/m)
2. Correction Factor(dB/m) = Antenna Factor(dB/m) + Cable Factor(dB) – Pre-Amplifier Factor(dB)
3. The other emission levels were very low against the limit.
4. Margin value = Emission Level – Limit value
5. " * ": Fundamental frequency.
6. " # ": The radiated frequency is out of the restricted band.

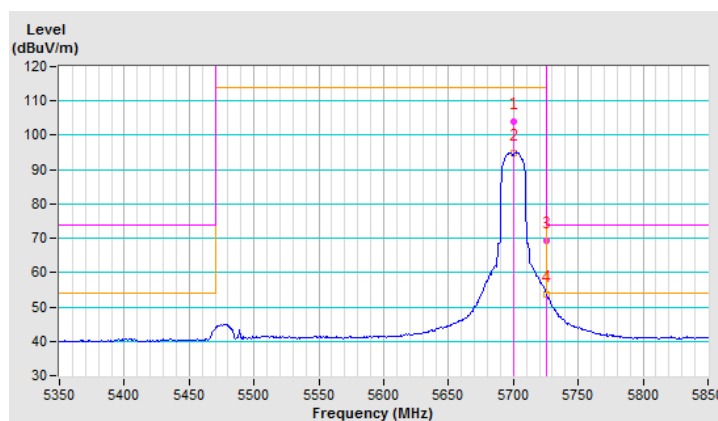

CHANNEL	TX Channel 140	DETECTOR FUNCTION	Peak (PK)
FREQUENCY RANGE	1GHz ~ 40GHz		Average (AV)

ANTENNA POLARITY & TEST DISTANCE: VERTICAL AT 3 M

NO.	FREQ. (MHz)	EMISSION LEVEL (dBuV/m)	LIMIT (dBuV/m)	MARGIN (dB)	ANTENNA HEIGHT (m)	TABLE ANGLE (Degree)	RAW VALUE (dBuV)	CORRECTION FACTOR (dB/m)
1	*5700.00	99.9 PK			1.00 V	65	95.71	4.19
2	*5700.00	91.2 AV			1.00 V	65	87.01	4.19
3	#5725.00	65.6 PK	74.0	-8.4	1.00 V	65	61.41	4.19
4	#5725.00	50.8 AV	54.0	-3.2	1.00 V	65	46.61	4.19

REMARKS:

1. Emission Level(dBuV/m) = Raw Value(dBuV) + Correction Factor(dB/m)
2. Correction Factor(dB/m) = Antenna Factor(dB/m) + Cable Factor(dB) – Pre-Amplifier Factor(dB)
3. The other emission levels were very low against the limit.
4. Margin value = Emission Level – Limit value
5. " * ": Fundamental frequency.
6. " # ": The radiated frequency is out of the restricted band.

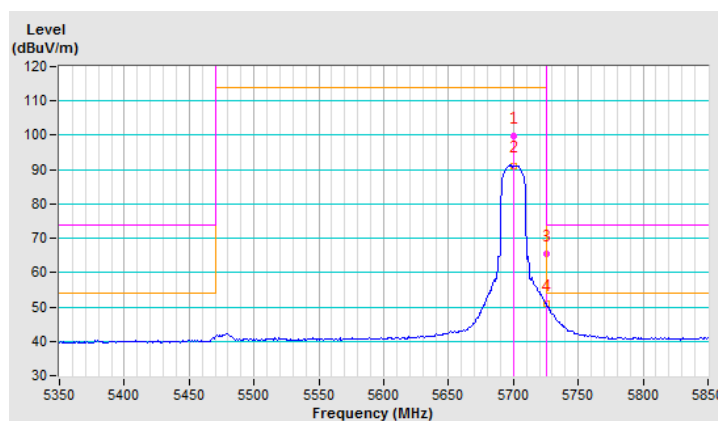

CHANNEL	TX Channel 149	DETECTOR FUNCTION	Peak (PK)
FREQUENCY RANGE	1GHz ~ 40GHz		Average (AV)

ANTENNA POLARITY & TEST DISTANCE: HORIZONTAL AT 3 M

NO.	FREQ. (MHz)	EMISSION LEVEL (dBuV/m)	LIMIT (dBuV/m)	MARGIN (dB)	ANTENNA HEIGHT (m)	TABLE ANGLE (Degree)	RAW VALUE (dBuV)	CORRECTION FACTOR (dB/m)
1	#5715.00	69.2 PK	74.0	-4.8	1.15 H	48	65.01	4.19
2	#5715.00	53.5 AV	54.0	-0.5	1.15 H	48	49.31	4.19
3	#5725.00	78.0 PK	78.2	-0.2	1.15 H	48	73.81	4.19
4	*5745.00	105.0 PK			1.15 H	48	100.81	4.19
5	*5745.00	95.2 AV			1.15 H	48	91.01	4.19

REMARKS:

1. Emission Level(dBuV/m) = Raw Value(dBuV) + Correction Factor(dB/m)
2. Correction Factor(dB/m) = Antenna Factor(dB/m) + Cable Factor(dB) – Pre-Amplifier Factor(dB)
3. The other emission levels were very low against the limit.
4. Margin value = Emission Level – Limit value
5. " * ": Fundamental frequency.
6. " # ": The radiated frequency is out of the restricted band.

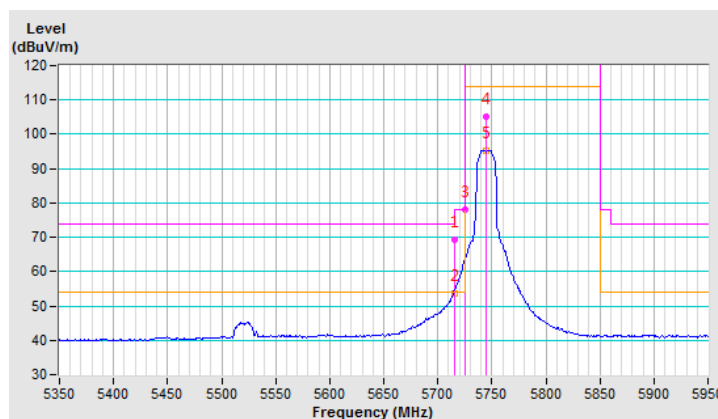

CHANNEL	TX Channel 149	DETECTOR FUNCTION	Peak (PK)
FREQUENCY RANGE	1GHz ~ 40GHz		Average (AV)

ANTENNA POLARITY & TEST DISTANCE: VERTICAL AT 3 M

NO.	FREQ. (MHz)	EMISSION LEVEL (dBuV/m)	LIMIT (dBuV/m)	MARGIN (dB)	ANTENNA HEIGHT (m)	TABLE ANGLE (Degree)	RAW VALUE (dBuV)	CORRECTION FACTOR (dB/m)
1	#5715.00	64.7 PK	74.0	-9.3	1.00 V	64	60.51	4.19
2	#5715.00	49.6 AV	54.0	-4.4	1.00 V	64	45.41	4.19
3	#5725.00	75.1 PK	78.2	-3.1	1.00 V	64	70.91	4.19
4	*5745.00	101.7 PK			1.00 V	64	97.51	4.19
5	*5745.00	92.4 AV			1.00 V	64	88.21	4.19

REMARKS:

1. Emission Level(dBuV/m) = Raw Value(dBuV) + Correction Factor(dB/m)
2. Correction Factor(dB/m) = Antenna Factor(dB/m) + Cable Factor(dB) – Pre-Amplifier Factor(dB)
3. The other emission levels were very low against the limit.
4. Margin value = Emission Level – Limit value
5. " * ": Fundamental frequency.
6. " # ": The radiated frequency is out of the restricted band.

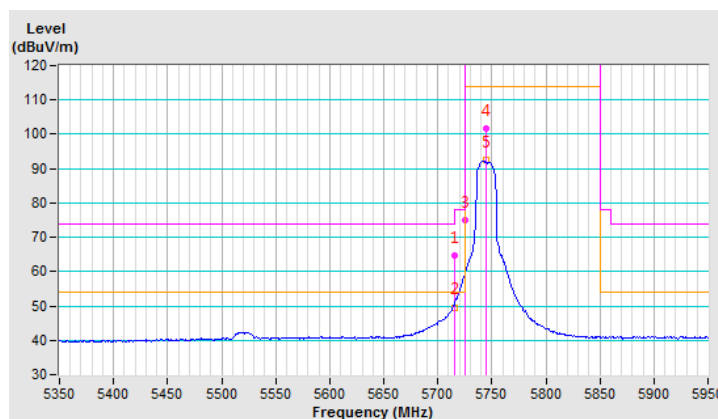

CHANNEL	TX Channel 157	DETECTOR FUNCTION	Peak (PK)
FREQUENCY RANGE	1GHz ~ 40GHz		Average (AV)

ANTENNA POLARITY & TEST DISTANCE: HORIZONTAL AT 3 M

NO.	FREQ. (MHz)	EMISSION LEVEL (dBuV/m)	LIMIT (dBuV/m)	MARGIN (dB)	ANTENNA HEIGHT (m)	TABLE ANGLE (Degree)	RAW VALUE (dBuV)	CORRECTION FACTOR (dB/m)
1	#5715.00	63.3 PK	74.0	-10.7	1.00 H	48	59.11	4.19
2	#5715.00	46.7 AV	54.0	-7.3	1.00 H	48	42.51	4.19
3	#5725.00	63.4 PK	78.2	-14.8	1.00 H	48	59.21	4.19
4	*5785.00	106.7 PK			1.00 H	48	102.52	4.18
5	*5785.00	97.1 AV			1.00 H	48	92.92	4.18
6	#5850.00	60.9 PK	78.2	-17.3	1.00 H	48	56.65	4.25
7	#5860.00	58.7 PK	74.0	-15.3	1.00 H	48	54.44	4.26
8	#5860.00	44.3 AV	54.0	-9.7	1.00 H	48	40.04	4.26

REMARKS:

1. Emission Level(dBuV/m) = Raw Value(dBuV) + Correction Factor(dB/m)
2. Correction Factor(dB/m) = Antenna Factor(dB/m) + Cable Factor(dB) – Pre-Amplifier Factor(dB)
3. The other emission levels were very low against the limit.
4. Margin value = Emission Level – Limit value
5. " * ": Fundamental frequency.
6. " # ": The radiated frequency is out of the restricted band.

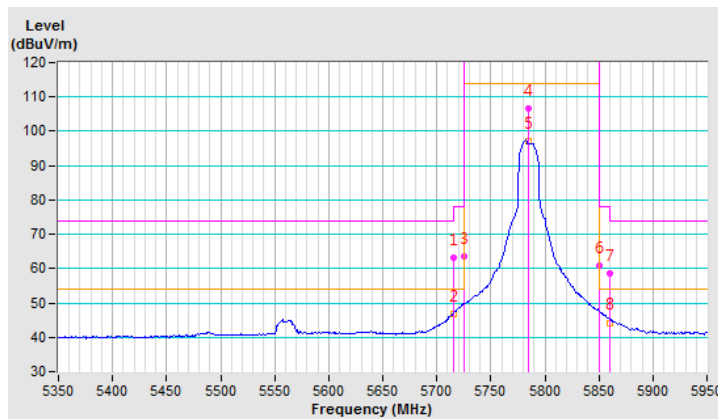

CHANNEL	TX Channel 157	DETECTOR FUNCTION	Peak (PK)
FREQUENCY RANGE	1GHz ~ 40GHz		Average (AV)

ANTENNA POLARITY & TEST DISTANCE: VERTICAL AT 3 M

NO.	FREQ. (MHz)	EMISSION LEVEL (dBuV/m)	LIMIT (dBuV/m)	MARGIN (dB)	ANTENNA HEIGHT (m)	TABLE ANGLE (Degree)	RAW VALUE (dBuV)	CORRECTION FACTOR (dB/m)
1	#5715.00	59.9 PK	74.0	-14.1	1.00 V	277	55.71	4.19
2	#5715.00	45.6 AV	54.0	-8.4	1.00 V	277	41.41	4.19
3	#5725.00	61.8 PK	78.2	-16.4	1.00 V	277	57.61	4.19
4	*5785.00	104.5 PK			1.00 V	277	100.32	4.18
5	*5785.00	95.4 AV			1.00 V	277	91.22	4.18
6	#5850.00	61.7 PK	78.2	-16.5	1.00 V	277	57.45	4.25
7	#5860.00	57.9 PK	74.0	-16.1	1.00 V	277	53.64	4.26
8	#5860.00	43.7 AV	54.0	-10.3	1.00 V	277	39.44	4.26

REMARKS:

1. Emission Level(dBuV/m) = Raw Value(dBuV) + Correction Factor(dB/m)
2. Correction Factor(dB/m) = Antenna Factor(dB/m) + Cable Factor(dB) – Pre-Amplifier Factor(dB)
3. The other emission levels were very low against the limit.
4. Margin value = Emission Level – Limit value
5. " * ": Fundamental frequency.
6. " # ": The radiated frequency is out of the restricted band.

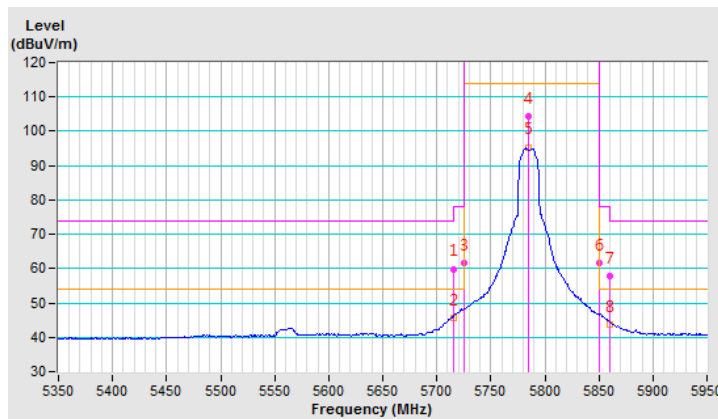

CHANNEL	TX Channel 165	DETECTOR FUNCTION	Peak (PK)
FREQUENCY RANGE	1GHz ~ 40GHz		Average (AV)

ANTENNA POLARITY & TEST DISTANCE: HORIZONTAL AT 3 M

NO.	FREQ. (MHz)	EMISSION LEVEL (dBuV/m)	LIMIT (dBuV/m)	MARGIN (dB)	ANTENNA HEIGHT (m)	TABLE ANGLE (Degree)	RAW VALUE (dBuV)	CORRECTION FACTOR (dB/m)
1	*5825.00	104.6 PK			1.00 H	48	100.38	4.22
2	*5825.00	94.9 AV			1.00 H	48	90.68	4.22
3	#5850.00	73.4 PK	78.2	-4.8	1.00 H	48	69.15	4.25
4	#5860.00	67.9 PK	74.0	-6.1	1.00 H	48	63.64	4.26
5	#5860.00	53.4 AV	54.0	-0.6	1.00 H	48	49.14	4.26

REMARKS:

1. Emission Level(dBuV/m) = Raw Value(dBuV) + Correction Factor(dB/m)
2. Correction Factor(dB/m) = Antenna Factor(dB/m) + Cable Factor(dB) – Pre-Amplifier Factor(dB)
3. The other emission levels were very low against the limit.
4. Margin value = Emission Level – Limit value
5. " * ": Fundamental frequency.
6. " # ": The radiated frequency is out of the restricted band.

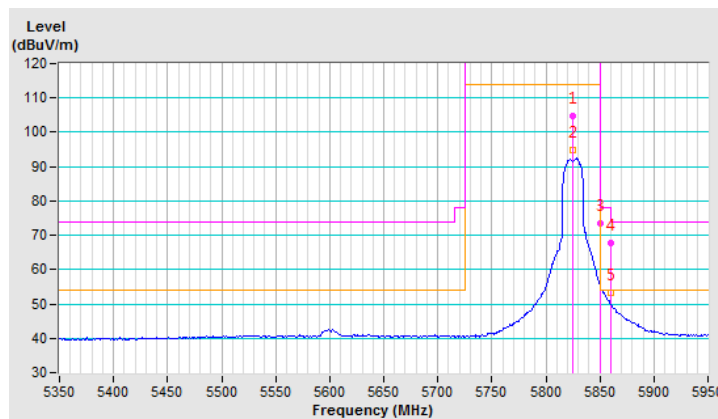

CHANNEL	TX Channel 165	DETECTOR FUNCTION	Peak (PK)
FREQUENCY RANGE	1GHz ~ 40GHz		Average (AV)

ANTENNA POLARITY & TEST DISTANCE: VERTICAL AT 3 M

NO.	FREQ. (MHz)	EMISSION LEVEL (dBuV/m)	LIMIT (dBuV/m)	MARGIN (dB)	ANTENNA HEIGHT (m)	TABLE ANGLE (Degree)	RAW VALUE (dBuV)	CORRECTION FACTOR (dB/m)
1	*5825.00	102.3 PK			1.00 V	285	98.08	4.22
2	*5825.00	93.4 AV			1.00 V	285	89.18	4.22
3	#5850.00	70.2 PK	78.2	-8.0	1.00 V	285	65.95	4.25
4	#5860.00	65.6 PK	74.0	-8.4	1.00 V	285	61.34	4.26
5	#5860.00	50.8 AV	54.0	-3.2	1.00 V	285	46.54	4.26

REMARKS:

1. Emission Level(dBuV/m) = Raw Value(dBuV) + Correction Factor(dB/m)
2. Correction Factor(dB/m) = Antenna Factor(dB/m) + Cable Factor(dB) – Pre-Amplifier Factor(dB)
3. The other emission levels were very low against the limit.
4. Margin value = Emission Level – Limit value
5. " * ": Fundamental frequency.
6. " # ": The radiated frequency is out of the restricted band.

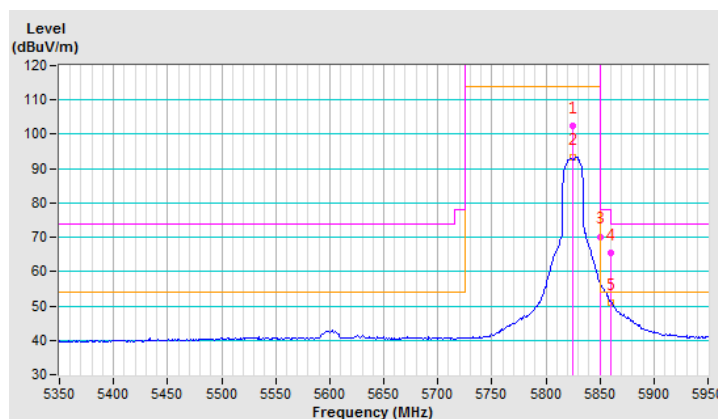

802.11n (40MHz)

CHANNEL	TX Channel 38	DETECTOR FUNCTION	Peak (PK)
FREQUENCY RANGE	1GHz ~ 40GHz		Average (AV)

ANTENNA POLARITY & TEST DISTANCE: HORIZONTAL AT 3 M								
NO.	FREQ. (MHz)	EMISSION LEVEL (dBuV/m)	LIMIT (dBuV/m)	MARGIN (dB)	ANTENNA HEIGHT (m)	TABLE ANGLE (Degree)	RAW VALUE (dBuV)	CORRECTION FACTOR (dB/m)
1	5150.00	67.2 PK	74.0	-6.8	1.23 H	46	64.22	2.98
2	5150.00	53.9 AV	54.0	-0.1	1.23 H	46	50.92	2.98
3	*5190.00	102.8 PK			1.23 H	46	99.73	3.07
4	*5190.00	93.9 AV			1.23 H	46	90.83	3.07
5	5350.00	51.5 PK	74.0	-22.5	1.23 H	46	47.99	3.51
6	5350.00	40.8 AV	54.0	-13.2	1.23 H	46	37.29	3.51

REMARKS:

1. Emission Level(dBuV/m) = Raw Value(dBuV) + Correction Factor(dB/m)
2. Correction Factor(dB/m) = Antenna Factor(dB/m) + Cable Factor(dB) – Pre-Amplifier Factor(dB)
3. The other emission levels were very low against the limit.
4. Margin value = Emission Level – Limit value
5. " * ": Fundamental frequency.

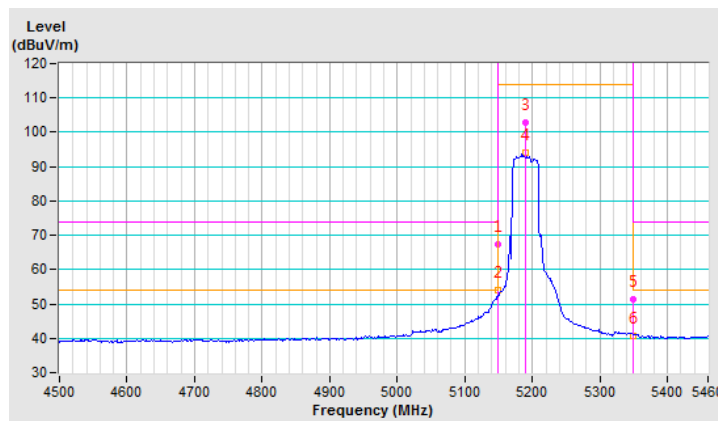

CHANNEL	TX Channel 38	DETECTOR FUNCTION	Peak (PK)
FREQUENCY RANGE	1GHz ~ 40GHz		Average (AV)

ANTENNA POLARITY & TEST DISTANCE: VERTICAL AT 3 M

NO.	FREQ. (MHz)	EMISSION LEVEL (dBuV/m)	LIMIT (dBuV/m)	MARGIN (dB)	ANTENNA HEIGHT (m)	TABLE ANGLE (Degree)	RAW VALUE (dBuV)	CORRECTION FACTOR (dB/m)
1	5150.00	65.2 PK	74.0	-8.8	1.00 V	335	62.22	2.98
2	5150.00	50.4 AV	54.0	-3.6	1.00 V	335	47.42	2.98
3	*5190.00	100.3 PK			1.00 V	335	97.23	3.07
4	*5190.00	91.3 AV			1.00 V	335	88.23	3.07
5	5350.00	51.6 PK	74.0	-22.4	1.00 V	335	48.09	3.51
6	5350.00	40.4 AV	54.0	-13.6	1.00 V	335	36.89	3.51

REMARKS:

1. Emission Level(dBuV/m) = Raw Value(dBuV) + Correction Factor(dB/m)
2. Correction Factor(dB/m) = Antenna Factor(dB/m) + Cable Factor(dB) – Pre-Amplifier Factor(dB)
3. The other emission levels were very low against the limit.
4. Margin value = Emission Level – Limit value
5. " * ": Fundamental frequency.

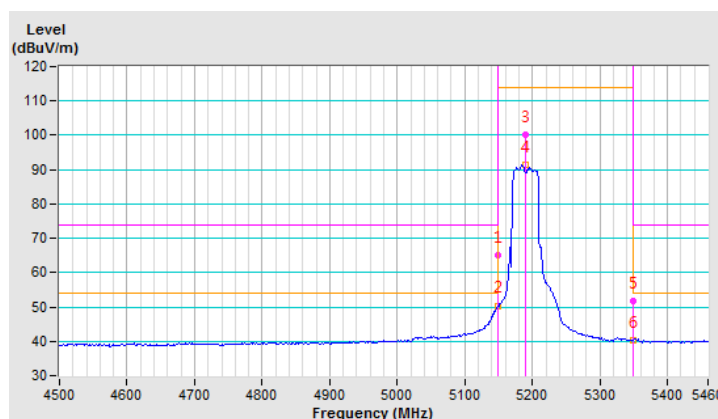

CHANNEL	TX Channel 46	DETECTOR FUNCTION	Peak (PK)
FREQUENCY RANGE	1GHz ~ 40GHz		Average (AV)

ANTENNA POLARITY & TEST DISTANCE: HORIZONTAL AT 3 M

NO.	FREQ. (MHz)	EMISSION LEVEL (dBuV/m)	LIMIT (dBuV/m)	MARGIN (dB)	ANTENNA HEIGHT (m)	TABLE ANGLE (Degree)	RAW VALUE (dBuV)	CORRECTION FACTOR (dB/m)
1	5150.00	64.4 PK	74.0	-9.6	1.08 H	47	61.42	2.98
2	5150.00	53.8 AV	54.0	-0.2	1.08 H	47	50.82	2.98
3	*5230.00	108.5 PK			1.08 H	47	105.32	3.18
4	*5230.00	97.7 AV			1.08 H	47	94.52	3.18
5	5362.00	55.5 PK	74.0	-18.5	1.08 H	47	51.94	3.56
6	5362.00	44.1 AV	54.0	-9.9	1.08 H	47	40.54	3.56

REMARKS:

1. Emission Level(dBuV/m) = Raw Value(dBuV) + Correction Factor(dB/m)
2. Correction Factor(dB/m) = Antenna Factor(dB/m) + Cable Factor(dB) – Pre-Amplifier Factor(dB)
3. The other emission levels were very low against the limit.
4. Margin value = Emission Level – Limit value
5. " * ": Fundamental frequency.

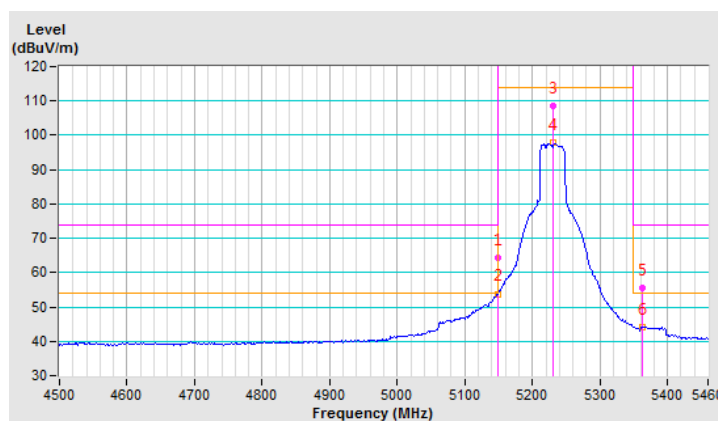

CHANNEL	TX Channel 46	DETECTOR FUNCTION	Peak (PK)
FREQUENCY RANGE	1GHz ~ 40GHz		Average (AV)

ANTENNA POLARITY & TEST DISTANCE: VERTICAL AT 3 M

NO.	FREQ. (MHz)	EMISSION LEVEL (dBuV/m)	LIMIT (dBuV/m)	MARGIN (dB)	ANTENNA HEIGHT (m)	TABLE ANGLE (Degree)	RAW VALUE (dBuV)	CORRECTION FACTOR (dB/m)
1	5150.00	62.3 PK	74.0	-11.7	1.00 V	48	59.32	2.98
2	5150.00	51.3 AV	54.0	-2.7	1.00 V	48	48.32	2.98
3	*5230.00	105.5 PK			1.00 V	48	102.32	3.18
4	*5230.00	96.0 AV			1.00 V	48	92.82	3.18
5	5362.00	55.6 PK	74.0	-18.4	1.00 V	48	52.04	3.56
6	5362.00	44.1 AV	54.0	-9.9	1.00 V	48	40.54	3.56

REMARKS:

1. Emission Level(dBuV/m) = Raw Value(dBuV) + Correction Factor(dB/m)
2. Correction Factor(dB/m) = Antenna Factor(dB/m) + Cable Factor(dB) – Pre-Amplifier Factor(dB)
3. The other emission levels were very low against the limit.
4. Margin value = Emission Level – Limit value
5. " * ": Fundamental frequency.

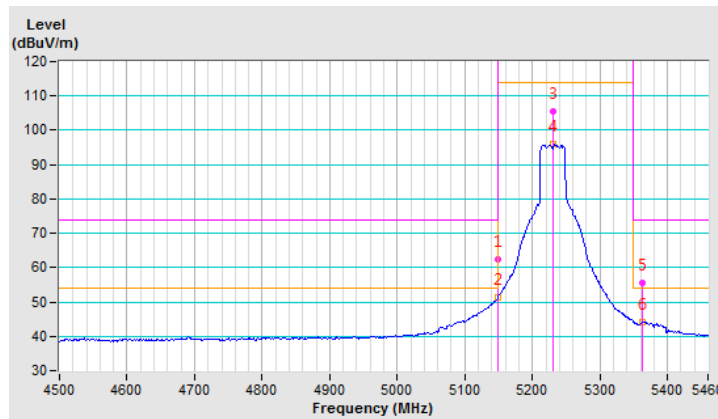

CHANNEL	TX Channel 54	DETECTOR FUNCTION	Peak (PK)
FREQUENCY RANGE	1GHz ~ 40GHz		Average (AV)

ANTENNA POLARITY & TEST DISTANCE: HORIZONTAL AT 3 M

NO.	FREQ. (MHz)	EMISSION LEVEL (dBuV/m)	LIMIT (dBuV/m)	MARGIN (dB)	ANTENNA HEIGHT (m)	TABLE ANGLE (Degree)	RAW VALUE (dBuV)	CORRECTION FACTOR (dB/m)
1	5150.00	55.3 PK	74.0	-18.7	1.08 H	280	52.32	2.98
2	5150.00	44.8 AV	54.0	-9.2	1.08 H	280	41.82	2.98
3	*5270.00	107.3 PK			1.08 H	280	104.01	3.29
4	*5270.00	96.8 AV			1.08 H	280	93.51	3.29
5	5350.00	62.3 PK	74.0	-11.7	1.08 H	280	58.79	3.51
6	5350.00	50.8 AV	54.0	-3.2	1.08 H	280	47.29	3.51

REMARKS:

1. Emission Level(dBuV/m) = Raw Value(dBuV) + Correction Factor(dB/m)
2. Correction Factor(dB/m) = Antenna Factor(dB/m) + Cable Factor(dB) – Pre-Amplifier Factor(dB)
3. The other emission levels were very low against the limit.
4. Margin value = Emission Level – Limit value
5. " * ": Fundamental frequency.

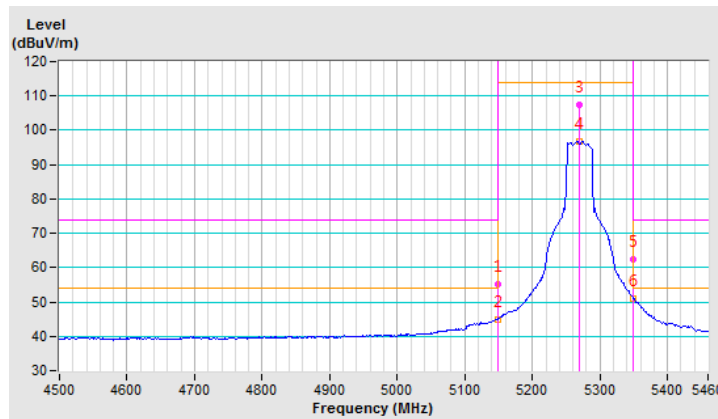

CHANNEL	TX Channel 54	DETECTOR FUNCTION	Peak (PK)
FREQUENCY RANGE	1GHz ~ 40GHz		Average (AV)

ANTENNA POLARITY & TEST DISTANCE: VERTICAL AT 3 M

NO.	FREQ. (MHz)	EMISSION LEVEL (dBuV/m)	LIMIT (dBuV/m)	MARGIN (dB)	ANTENNA HEIGHT (m)	TABLE ANGLE (Degree)	RAW VALUE (dBuV)	CORRECTION FACTOR (dB/m)
1	5150.00	57.3 PK	74.0	-16.7	1.00 V	46	54.32	2.98
2	5150.00	43.2 AV	54.0	-10.8	1.00 V	46	40.22	2.98
3	*5270.00	104.6 PK			1.00 V	46	101.31	3.29
4	*5270.00	95.9 AV			1.00 V	46	92.61	3.29
5	5350.00	61.3 PK	74.0	-12.7	1.00 V	46	57.79	3.51
6	5350.00	49.6 AV	54.0	-4.4	1.00 V	46	46.09	3.51

REMARKS:

1. Emission Level(dBuV/m) = Raw Value(dBuV) + Correction Factor(dB/m)
2. Correction Factor(dB/m) = Antenna Factor(dB/m) + Cable Factor(dB) – Pre-Amplifier Factor(dB)
3. The other emission levels were very low against the limit.
4. Margin value = Emission Level – Limit value
5. " * ": Fundamental frequency.

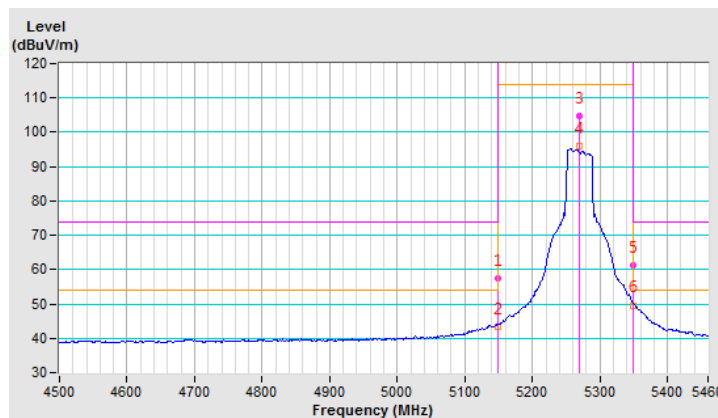

CHANNEL	TX Channel 62	DETECTOR FUNCTION	Peak (PK)
FREQUENCY RANGE	1GHz ~ 40GHz		Average (AV)

ANTENNA POLARITY & TEST DISTANCE: HORIZONTAL AT 3 M

NO.	FREQ. (MHz)	EMISSION LEVEL (dBuV/m)	LIMIT (dBuV/m)	MARGIN (dB)	ANTENNA HEIGHT (m)	TABLE ANGLE (Degree)	RAW VALUE (dBuV)	CORRECTION FACTOR (dB/m)
1	*5310.00	103.9 PK			1.01 H	282	100.50	3.40
2	*5310.00	93.9 AV			1.01 H	282	90.50	3.40
3	5350.00	73.5 PK	74.0	-0.5	1.01 H	282	69.99	3.51
4	5350.00	53.8 AV	54.0	-0.2	1.01 H	282	50.29	3.51

REMARKS:

1. Emission Level(dBuV/m) = Raw Value(dBuV) + Correction Factor(dB/m)
2. Correction Factor(dB/m) = Antenna Factor(dB/m) + Cable Factor(dB) – Pre-Amplifier Factor(dB)
3. The other emission levels were very low against the limit.
4. Margin value = Emission Level – Limit value
5. " * ": Fundamental frequency.

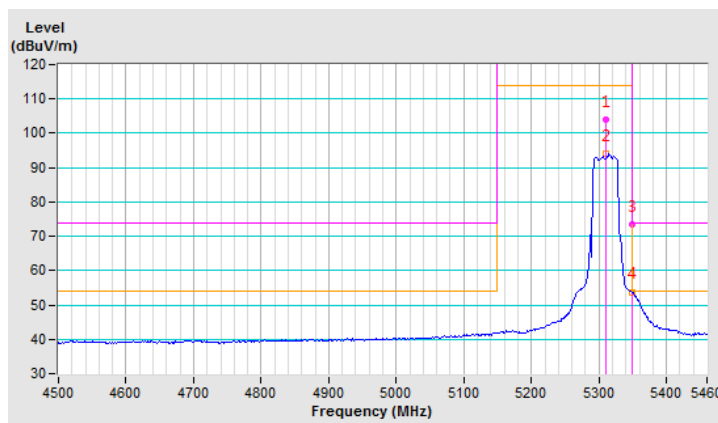

CHANNEL	TX Channel 62	DETECTOR FUNCTION	Peak (PK)
FREQUENCY RANGE	1GHz ~ 40GHz		Average (AV)

ANTENNA POLARITY & TEST DISTANCE: VERTICAL AT 3 M

NO.	FREQ. (MHz)	EMISSION LEVEL (dBuV/m)	LIMIT (dBuV/m)	MARGIN (dB)	ANTENNA HEIGHT (m)	TABLE ANGLE (Degree)	RAW VALUE (dBuV)	CORRECTION FACTOR (dB/m)
1	*5310.00	101.8 PK			1.00 V	42	98.40	3.40
2	*5310.00	92.0 AV			1.00 V	42	88.60	3.40
3	5350.00	68.7 PK	74.0	-5.3	1.00 V	42	65.19	3.51
4	5350.00	51.9 AV	54.0	-2.1	1.00 V	42	48.39	3.51

REMARKS:

1. Emission Level(dBuV/m) = Raw Value(dBuV) + Correction Factor(dB/m)
2. Correction Factor(dB/m) = Antenna Factor(dB/m) + Cable Factor(dB) – Pre-Amplifier Factor(dB)
3. The other emission levels were very low against the limit.
4. Margin value = Emission Level – Limit value
5. " * ": Fundamental frequency.

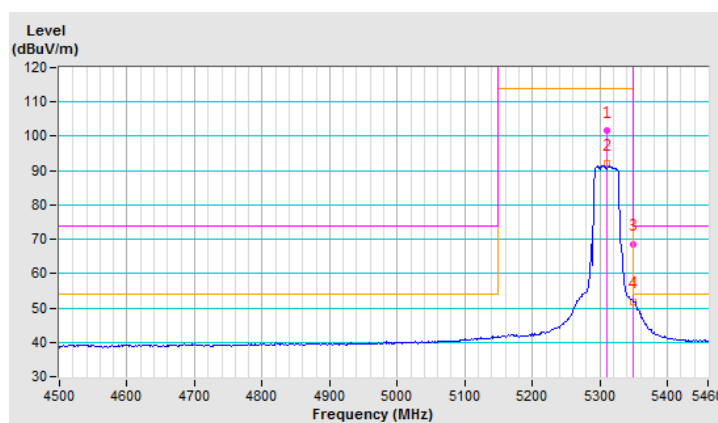

CHANNEL	TX Channel 102	DETECTOR FUNCTION	Peak (PK)
FREQUENCY RANGE	1GHz ~ 40GHz		Average (AV)

ANTENNA POLARITY & TEST DISTANCE: HORIZONTAL AT 3 M

NO.	FREQ. (MHz)	EMISSION LEVEL (dBuV/m)	LIMIT (dBuV/m)	MARGIN (dB)	ANTENNA HEIGHT (m)	TABLE ANGLE (Degree)	RAW VALUE (dBuV)	CORRECTION FACTOR (dB/m)
1	#5470.00	67.3 PK	74.0	-6.7	1.00 H	280	63.54	3.76
2	#5470.00	53.4 AV	54.0	-0.6	1.00 H	280	49.64	3.76
3	*5510.00	102.5 PK			1.00 H	280	98.69	3.81
4	*5510.00	92.8 AV			1.00 H	280	88.99	3.81

REMARKS:

1. Emission Level(dBuV/m) = Raw Value(dBuV) + Correction Factor(dB/m)
2. Correction Factor(dB/m) = Antenna Factor(dB/m) + Cable Factor(dB) – Pre-Amplifier Factor(dB)
3. The other emission levels were very low against the limit.
4. Margin value = Emission Level – Limit value
5. " * ": Fundamental frequency.
6. " # ": The radiated frequency is out of the restricted band.

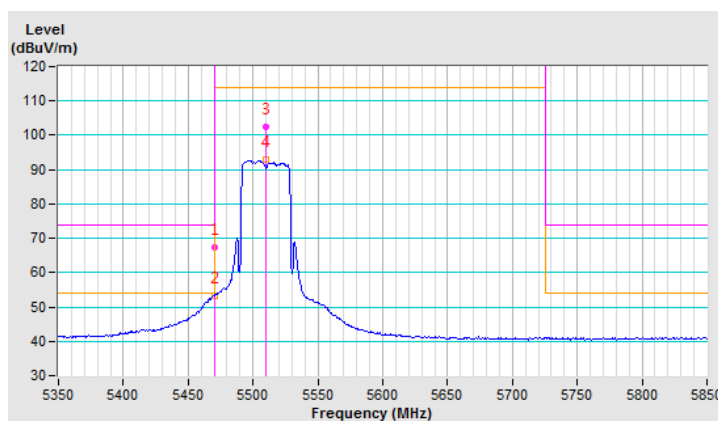

CHANNEL	TX Channel 102	DETECTOR FUNCTION	Peak (PK)
FREQUENCY RANGE	1GHz ~ 40GHz		Average (AV)

ANTENNA POLARITY & TEST DISTANCE: VERTICAL AT 3 M

NO.	FREQ. (MHz)	EMISSION LEVEL (dBuV/m)	LIMIT (dBuV/m)	MARGIN (dB)	ANTENNA HEIGHT (m)	TABLE ANGLE (Degree)	RAW VALUE (dBuV)	CORRECTION FACTOR (dB/m)
1	#5470.00	65.6 PK	74.0	-8.4	1.00 V	49	61.84	3.76
2	#5470.00	51.3 AV	54.0	-2.7	1.00 V	49	47.54	3.76
3	*5510.00	100.3 PK			1.00 V	49	96.49	3.81
4	*5510.00	90.6 AV			1.00 V	49	86.79	3.81

REMARKS:

1. Emission Level(dBuV/m) = Raw Value(dBuV) + Correction Factor(dB/m)
2. Correction Factor(dB/m) = Antenna Factor(dB/m) + Cable Factor(dB) – Pre-Amplifier Factor(dB)
3. The other emission levels were very low against the limit.
4. Margin value = Emission Level – Limit value
5. " * ": Fundamental frequency.
6. " # ": The radiated frequency is out of the restricted band.

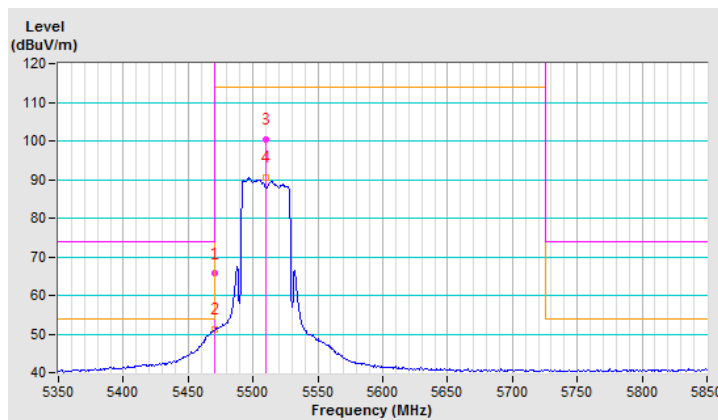

CHANNEL	TX Channel 110	DETECTOR FUNCTION	Peak (PK)
FREQUENCY RANGE	1GHz ~ 40GHz		Average (AV)

ANTENNA POLARITY & TEST DISTANCE: HORIZONTAL AT 3 M

NO.	FREQ. (MHz)	EMISSION LEVEL (dBuV/m)	LIMIT (dBuV/m)	MARGIN (dB)	ANTENNA HEIGHT (m)	TABLE ANGLE (Degree)	RAW VALUE (dBuV)	CORRECTION FACTOR (dB/m)
1	#5470.00	66.6 PK	74.0	-7.4	1.00 H	48	62.84	3.76
2	#5470.00	53.9 AV	54.0	-0.1	1.00 H	48	50.14	3.76
3	*5550.00	105.8 PK			1.00 H	48	101.94	3.86
4	*5550.00	96.1 AV			1.00 H	48	92.24	3.86
5	#5725.00	53.0 PK	74.0	-21.0	1.00 H	48	48.81	4.19
6	#5725.00	40.9 AV	54.0	-13.1	1.00 H	48	36.71	4.19

REMARKS:

1. Emission Level(dBuV/m) = Raw Value(dBuV) + Correction Factor(dB/m)
2. Correction Factor(dB/m) = Antenna Factor(dB/m) + Cable Factor(dB) – Pre-Amplifier Factor(dB)
3. The other emission levels were very low against the limit.
4. Margin value = Emission Level – Limit value
5. " * ": Fundamental frequency.
6. " # ": The radiated frequency is out of the restricted band.

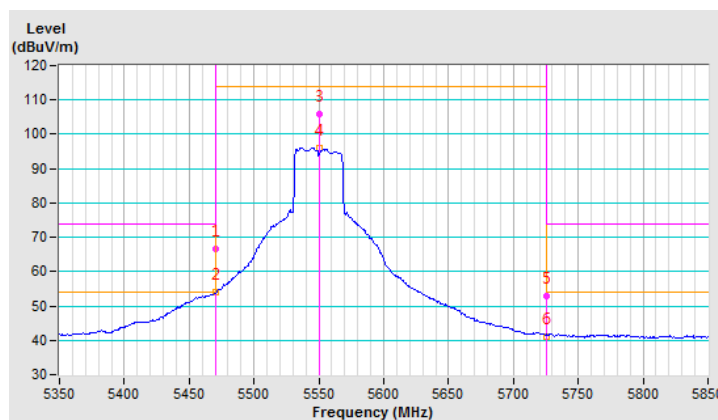

CHANNEL	TX Channel 110	DETECTOR FUNCTION	Peak (PK)
FREQUENCY RANGE	1GHz ~ 40GHz		Average (AV)

ANTENNA POLARITY & TEST DISTANCE: VERTICAL AT 3 M

NO.	FREQ. (MHz)	EMISSION LEVEL (dBuV/m)	LIMIT (dBuV/m)	MARGIN (dB)	ANTENNA HEIGHT (m)	TABLE ANGLE (Degree)	RAW VALUE (dBuV)	CORRECTION FACTOR (dB/m)
1	#5470.00	64.4 PK	74.0	-9.6	1.00 V	301	60.64	3.76
2	#5470.00	50.9 AV	54.0	-3.1	1.00 V	301	47.14	3.76
3	*5550.00	104.6 PK			1.00 V	301	100.74	3.86
4	*5550.00	93.9 AV			1.00 V	301	90.04	3.86
5	#5725.00	51.9 PK	74.0	-22.1	1.00 V	301	47.71	4.19
6	#5725.00	40.1 AV	54.0	-13.9	1.00 V	301	35.91	4.19

REMARKS:

1. Emission Level(dBuV/m) = Raw Value(dBuV) + Correction Factor(dB/m)
2. Correction Factor(dB/m) = Antenna Factor(dB/m) + Cable Factor(dB) – Pre-Amplifier Factor(dB)
3. The other emission levels were very low against the limit.
4. Margin value = Emission Level – Limit value
5. " * ": Fundamental frequency.
6. " # ": The radiated frequency is out of the restricted band.

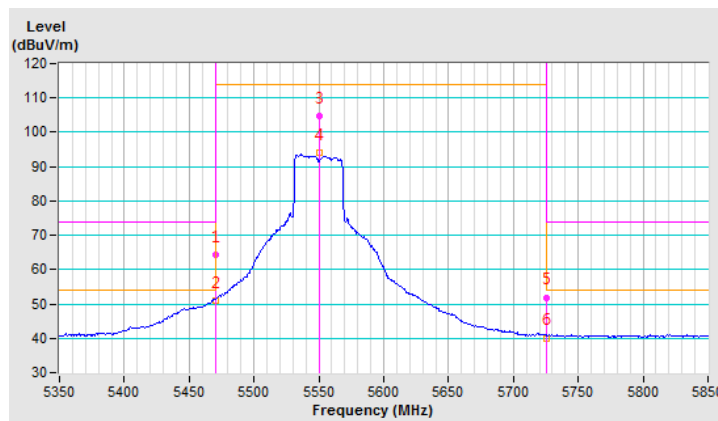

CHANNEL	TX Channel 134	DETECTOR FUNCTION	Peak (PK)
FREQUENCY RANGE	1GHz ~ 40GHz		Average (AV)

ANTENNA POLARITY & TEST DISTANCE: HORIZONTAL AT 3 M

NO.	FREQ. (MHz)	EMISSION LEVEL (dBuV/m)	LIMIT (dBuV/m)	MARGIN (dB)	ANTENNA HEIGHT (m)	TABLE ANGLE (Degree)	RAW VALUE (dBuV)	CORRECTION FACTOR (dB/m)
1	*5670.00	102.9 PK			1.21 H	50	98.79	4.11
2	*5670.00	92.7 AV			1.21 H	50	88.59	4.11
3	#5725.00	67.8 PK	74.0	-6.2	1.21 H	50	63.61	4.19
4	#5725.00	53.7 AV	54.0	-0.3	1.21 H	50	49.51	4.19

REMARKS:

1. Emission Level(dBuV/m) = Raw Value(dBuV) + Correction Factor(dB/m)
2. Correction Factor(dB/m) = Antenna Factor(dB/m) + Cable Factor(dB) – Pre-Amplifier Factor(dB)
3. The other emission levels were very low against the limit.
4. Margin value = Emission Level – Limit value
5. " * ": Fundamental frequency.
6. " # ": The radiated frequency is out of the restricted band.

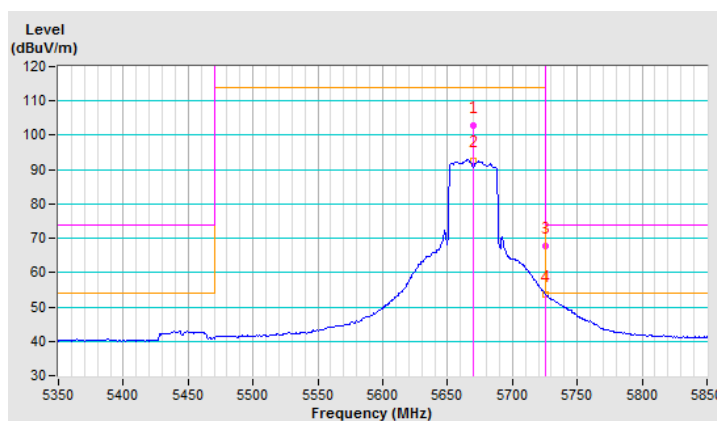

CHANNEL	TX Channel 134	DETECTOR FUNCTION	Peak (PK)
FREQUENCY RANGE	1GHz ~ 40GHz		Average (AV)

ANTENNA POLARITY & TEST DISTANCE: VERTICAL AT 3 M

NO.	FREQ. (MHz)	EMISSION LEVEL (dBuV/m)	LIMIT (dBuV/m)	MARGIN (dB)	ANTENNA HEIGHT (m)	TABLE ANGLE (Degree)	RAW VALUE (dBuV)	CORRECTION FACTOR (dB/m)
1	*5670.00	99.9 PK			1.00 V	55	95.79	4.11
2	*5670.00	89.7 AV			1.00 V	55	85.59	4.11
3	#5725.00	62.9 PK	74.0	-11.1	1.00 V	55	58.71	4.19
4	#5725.00	50.4 AV	54.0	-3.6	1.00 V	55	46.21	4.19

REMARKS:

1. Emission Level(dBuV/m) = Raw Value(dBuV) + Correction Factor(dB/m)
2. Correction Factor(dB/m) = Antenna Factor(dB/m) + Cable Factor(dB) – Pre-Amplifier Factor(dB)
3. The other emission levels were very low against the limit.
4. Margin value = Emission Level – Limit value
5. " * ": Fundamental frequency.
6. " # ": The radiated frequency is out of the restricted band.

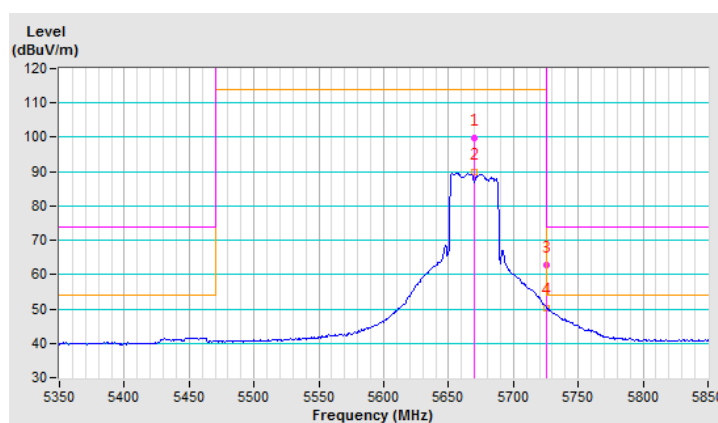

CHANNEL	TX Channel 151	DETECTOR FUNCTION	Peak (PK)
FREQUENCY RANGE	1GHz ~ 40GHz		Average (AV)

ANTENNA POLARITY & TEST DISTANCE: HORIZONTAL AT 3 M

NO.	FREQ. (MHz)	EMISSION LEVEL (dBuV/m)	LIMIT (dBuV/m)	MARGIN (dB)	ANTENNA HEIGHT (m)	TABLE ANGLE (Degree)	RAW VALUE (dBuV)	CORRECTION FACTOR (dB/m)
1	#5715.00	68.0 PK	74.0	-6.0	1.28 H	50	63.81	4.19
2	#5715.00	53.2 AV	54.0	-0.8	1.28 H	50	49.01	4.19
3	#5725.00	74.4 PK	78.2	-3.8	1.28 H	50	70.21	4.19
4	*5755.00	100.2 PK			1.28 H	50	96.02	4.18
5	*5755.00	89.5 AV			1.28 H	50	85.32	4.18

REMARKS:

1. Emission Level(dBuV/m) = Raw Value(dBuV) + Correction Factor(dB/m)
2. Correction Factor(dB/m) = Antenna Factor(dB/m) + Cable Factor(dB) – Pre-Amplifier Factor(dB)
3. The other emission levels were very low against the limit.
4. Margin value = Emission Level – Limit value
5. " * ": Fundamental frequency.
6. " # ": The radiated frequency is out of the restricted band.

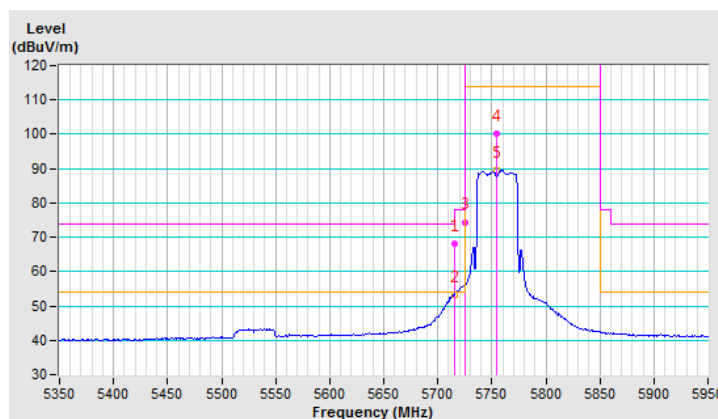

CHANNEL	TX Channel 151	DETECTOR FUNCTION	Peak (PK)
FREQUENCY RANGE	1GHz ~ 40GHz		Average (AV)

ANTENNA POLARITY & TEST DISTANCE: VERTICAL AT 3 M

NO.	FREQ. (MHz)	EMISSION LEVEL (dBuV/m)	LIMIT (dBuV/m)	MARGIN (dB)	ANTENNA HEIGHT (m)	TABLE ANGLE (Degree)	RAW VALUE (dBuV)	CORRECTION FACTOR (dB/m)
1	#5715.00	70.1 PK	74.0	-3.9	1.00 V	276	65.91	4.19
2	#5715.00	51.1 AV	54.0	-2.9	1.00 V	276	46.91	4.19
3	#5725.00	73.1 PK	78.2	-5.1	1.00 V	276	68.91	4.19
4	*5755.00	97.1 PK			1.00 V	276	92.92	4.18
5	*5755.00	87.3 AV			1.00 V	276	83.12	4.18

REMARKS:

1. Emission Level(dBuV/m) = Raw Value(dBuV) + Correction Factor(dB/m)
2. Correction Factor(dB/m) = Antenna Factor(dB/m) + Cable Factor(dB) – Pre-Amplifier Factor(dB)
3. The other emission levels were very low against the limit.
4. Margin value = Emission Level – Limit value
5. " * ": Fundamental frequency.
6. " # ": The radiated frequency is out of the restricted band.

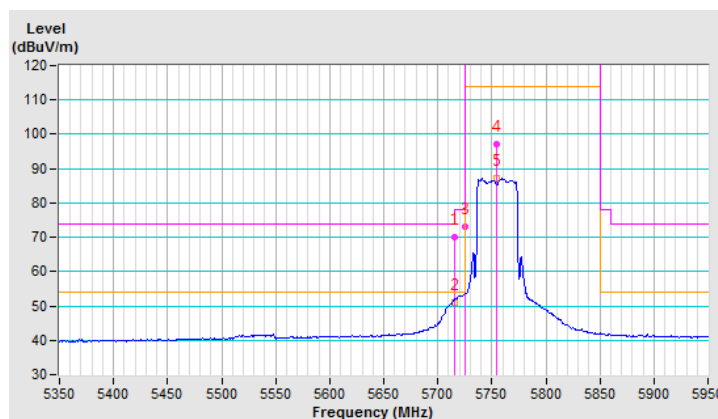

CHANNEL	TX Channel 159	DETECTOR FUNCTION	Peak (PK)
FREQUENCY RANGE	1GHz ~ 40GHz		Average (AV)

ANTENNA POLARITY & TEST DISTANCE: HORIZONTAL AT 3 M

NO.	FREQ. (MHz)	EMISSION LEVEL (dBuV/m)	LIMIT (dBuV/m)	MARGIN (dB)	ANTENNA HEIGHT (m)	TABLE ANGLE (Degree)	RAW VALUE (dBuV)	CORRECTION FACTOR (dB/m)
1	*5795.00	101.9 PK			1.03 H	49	97.71	4.19
2	*5795.00	91.7 AV			1.03 H	49	87.51	4.19
3	#5850.00	68.9 PK	78.2	-9.3	1.03 H	49	64.65	4.25
4	#5860.00	66.2 PK	74.0	-7.8	1.03 H	49	61.94	4.26
5	#5860.00	53.6 AV	54.0	-0.4	1.03 H	49	49.34	4.26

REMARKS:

1. Emission Level(dBuV/m) = Raw Value(dBuV) + Correction Factor(dB/m)
2. Correction Factor(dB/m) = Antenna Factor(dB/m) + Cable Factor(dB) – Pre-Amplifier Factor(dB)
3. The other emission levels were very low against the limit.
4. Margin value = Emission Level – Limit value
5. " * ": Fundamental frequency.
6. " # ": The radiated frequency is out of the restricted band.

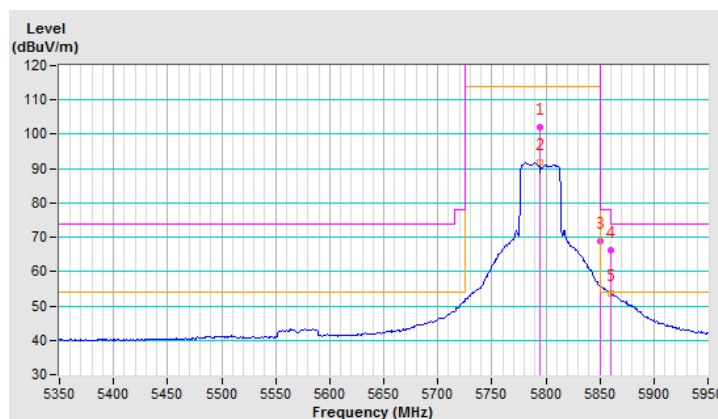

CHANNEL	TX Channel 159	DETECTOR FUNCTION	Peak (PK)
FREQUENCY RANGE	1GHz ~ 40GHz		Average (AV)

ANTENNA POLARITY & TEST DISTANCE: VERTICAL AT 3 M

NO.	FREQ. (MHz)	EMISSION LEVEL (dBuV/m)	LIMIT (dBuV/m)	MARGIN (dB)	ANTENNA HEIGHT (m)	TABLE ANGLE (Degree)	RAW VALUE (dBuV)	CORRECTION FACTOR (dB/m)
1	*5795.00	100.3 PK			1.00 V	277	96.11	4.19
2	*5795.00	90.2 AV			1.00 V	277	86.01	4.19
3	#5850.00	67.8 PK	78.2	-10.4	1.00 V	277	63.55	4.25
4	#5860.00	65.1 PK	74.0	-8.9	1.00 V	277	60.84	4.26
5	#5860.00	51.9 AV	54.0	-2.1	1.00 V	277	47.64	4.26

REMARKS:

1. Emission Level(dBuV/m) = Raw Value(dBuV) + Correction Factor(dB/m)
2. Correction Factor(dB/m) = Antenna Factor(dB/m) + Cable Factor(dB) – Pre-Amplifier Factor(dB)
3. The other emission levels were very low against the limit.
4. Margin value = Emission Level – Limit value
5. " * ": Fundamental frequency.
6. " # ": The radiated frequency is out of the restricted band.

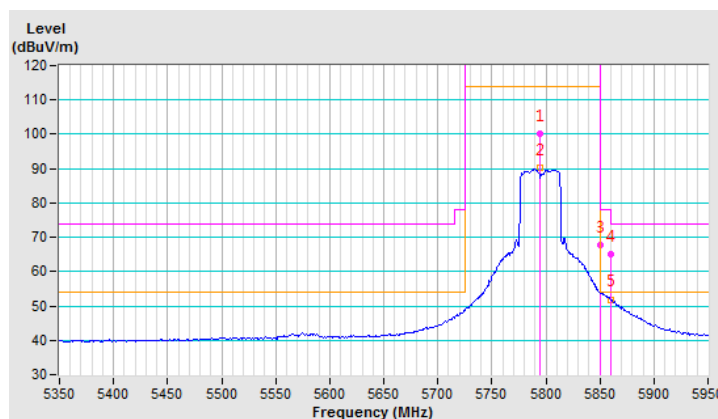

2TX

802.11a

CHANNEL	TX Channel 36	DETECTOR FUNCTION	Peak (PK)
FREQUENCY RANGE	1GHz ~ 40GHz		Average (AV)

ANTENNA POLARITY & TEST DISTANCE: HORIZONTAL AT 3 M

NO.	FREQ. (MHz)	EMISSION LEVEL (dBuV/m)	LIMIT (dBuV/m)	MARGIN (dB)	ANTENNA HEIGHT (m)	TABLE ANGLE (Degree)	RAW VALUE (dBuV)	CORRECTION FACTOR (dB/m)
1	5150.00	67.3 PK	74.0	-6.7	1.00 H	291	64.32	2.98
2	5150.00	49.7 AV	54.0	-4.3	1.00 H	291	46.72	2.98
3	*5180.00	107.4 PK			1.00 H	291	104.34	3.06
4	*5180.00	98.5 AV			1.00 H	291	95.44	3.06

REMARKS:

1. Emission Level(dBuV/m) = Raw Value(dBuV) + Correction Factor(dB/m)
2. Correction Factor(dB/m) = Antenna Factor(dB/m) + Cable Factor(dB) – Pre-Amplifier Factor(dB)
3. The other emission levels were very low against the limit.
4. Margin value = Emission Level – Limit value
5. " * ": Fundamental frequency.

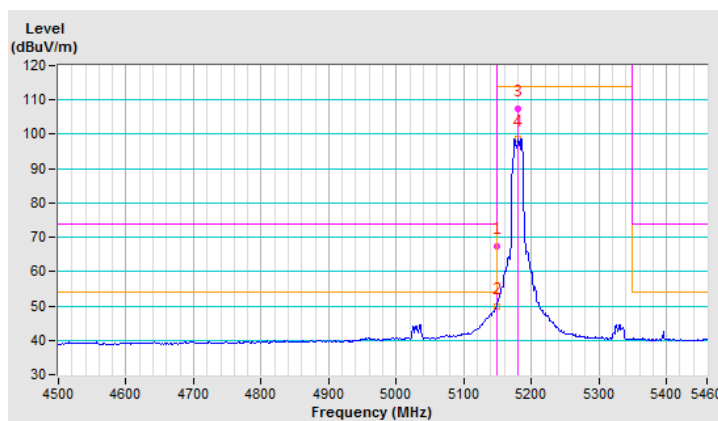

CHANNEL	TX Channel 36	DETECTOR FUNCTION	Peak (PK)
FREQUENCY RANGE	1GHz ~ 40GHz		Average (AV)

ANTENNA POLARITY & TEST DISTANCE: VERTICAL AT 3 M

NO.	FREQ. (MHz)	EMISSION LEVEL (dBuV/m)	LIMIT (dBuV/m)	MARGIN (dB)	ANTENNA HEIGHT (m)	TABLE ANGLE (Degree)	RAW VALUE (dBuV)	CORRECTION FACTOR (dB/m)
1	5150.00	70.3 PK	74.0	-3.7	1.00 V	298	67.32	2.98
2	5150.00	53.2 AV	54.0	-0.8	1.00 V	298	50.22	2.98
3	*5180.00	109.4 PK			1.00 V	298	106.34	3.06
4	*5180.00	100.2 AV			1.00 V	298	97.14	3.06

REMARKS:

1. Emission Level(dBuV/m) = Raw Value(dBuV) + Correction Factor(dB/m)
2. Correction Factor(dB/m) = Antenna Factor(dB/m) + Cable Factor(dB) – Pre-Amplifier Factor(dB)
3. The other emission levels were very low against the limit.
4. Margin value = Emission Level – Limit value
5. " * ": Fundamental frequency.

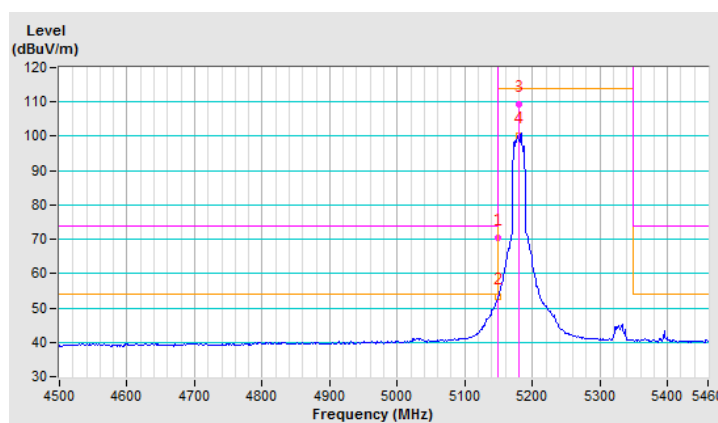

CHANNEL	TX Channel 40	DETECTOR FUNCTION	Peak (PK)
FREQUENCY RANGE	1GHz ~ 40GHz		Average (AV)

ANTENNA POLARITY & TEST DISTANCE: HORIZONTAL AT 3 M

NO.	FREQ. (MHz)	EMISSION LEVEL (dBuV/m)	LIMIT (dBuV/m)	MARGIN (dB)	ANTENNA HEIGHT (m)	TABLE ANGLE (Degree)	RAW VALUE (dBuV)	CORRECTION FACTOR (dB/m)
1	5150.00	62.6 PK	74.0	-11.4	1.10 H	277	59.62	2.98
2	5150.00	52.1 AV	54.0	-1.9	1.10 H	277	49.12	2.98
3	*5200.00	110.2 PK			1.10 H	277	107.10	3.10
4	*5200.00	102.1 AV			1.10 H	277	99.00	3.10

REMARKS:

1. Emission Level(dBuV/m) = Raw Value(dBuV) + Correction Factor(dB/m)
2. Correction Factor(dB/m) = Antenna Factor(dB/m) + Cable Factor(dB) – Pre-Amplifier Factor(dB)
3. The other emission levels were very low against the limit.
4. Margin value = Emission Level – Limit value
5. " * ": Fundamental frequency.

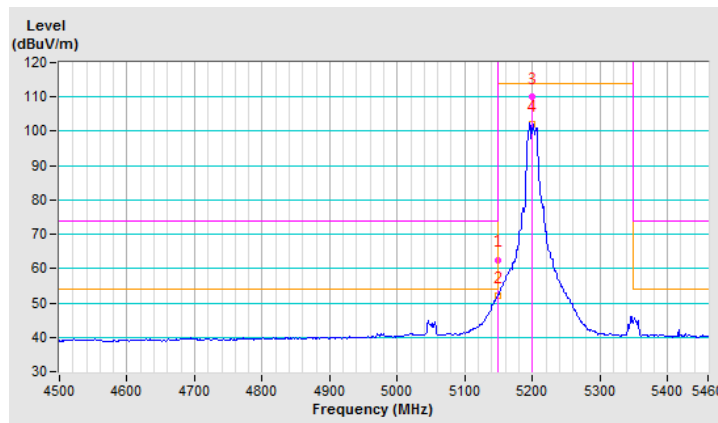

CHANNEL	TX Channel 40	DETECTOR FUNCTION	Peak (PK)
FREQUENCY RANGE	1GHz ~ 40GHz		Average (AV)

ANTENNA POLARITY & TEST DISTANCE: VERTICAL AT 3 M

NO.	FREQ. (MHz)	EMISSION LEVEL (dBuV/m)	LIMIT (dBuV/m)	MARGIN (dB)	ANTENNA HEIGHT (m)	TABLE ANGLE (Degree)	RAW VALUE (dBuV)	CORRECTION FACTOR (dB/m)
1	5150.00	67.1 PK	74.0	-6.9	1.00 V	285	64.12	2.98
2	5150.00	53.7 AV	54.0	-0.3	1.00 V	285	50.72	2.98
3	*5200.00	112.3 PK			1.00 V	285	109.20	3.10
4	*5200.00	103.3 AV			1.00 V	285	100.20	3.10

REMARKS:

1. Emission Level(dBuV/m) = Raw Value(dBuV) + Correction Factor(dB/m)
2. Correction Factor(dB/m) = Antenna Factor(dB/m) + Cable Factor(dB) – Pre-Amplifier Factor(dB)
3. The other emission levels were very low against the limit.
4. Margin value = Emission Level – Limit value
5. " * ": Fundamental frequency.

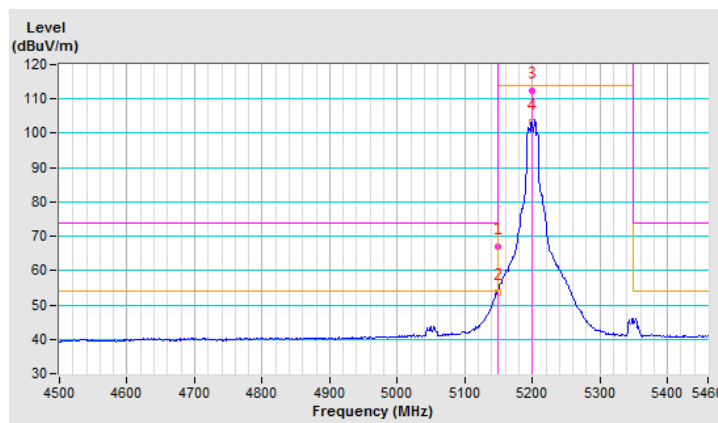

CHANNEL	TX Channel 48	DETECTOR FUNCTION	Peak (PK)
FREQUENCY RANGE	1GHz ~ 40GHz		Average (AV)

ANTENNA POLARITY & TEST DISTANCE: HORIZONTAL AT 3 M

NO.	FREQ. (MHz)	EMISSION LEVEL (dBuV/m)	LIMIT (dBuV/m)	MARGIN (dB)	ANTENNA HEIGHT (m)	TABLE ANGLE (Degree)	RAW VALUE (dBuV)	CORRECTION FACTOR (dB/m)
1	5090.00	55.4 PK	74.0	-18.6	1.22 H	276	52.57	2.83
2	5090.00	44.1 AV	54.0	-9.9	1.22 H	276	41.27	2.83
3	*5240.00	112.9 PK			1.22 H	276	109.69	3.21
4	*5240.00	103.8 AV			1.22 H	276	100.59	3.21
5	5395.00	55.4 PK	74.0	-18.6	1.22 H	276	51.75	3.65
6	5395.00	45.8 AV	54.0	-8.2	1.22 H	276	42.15	3.65

REMARKS:

1. Emission Level(dBuV/m) = Raw Value(dBuV) + Correction Factor(dB/m)
2. Correction Factor(dB/m) = Antenna Factor(dB/m) + Cable Factor(dB) – Pre-Amplifier Factor(dB)
3. The other emission levels were very low against the limit.
4. Margin value = Emission Level – Limit value
5. " * ": Fundamental frequency.

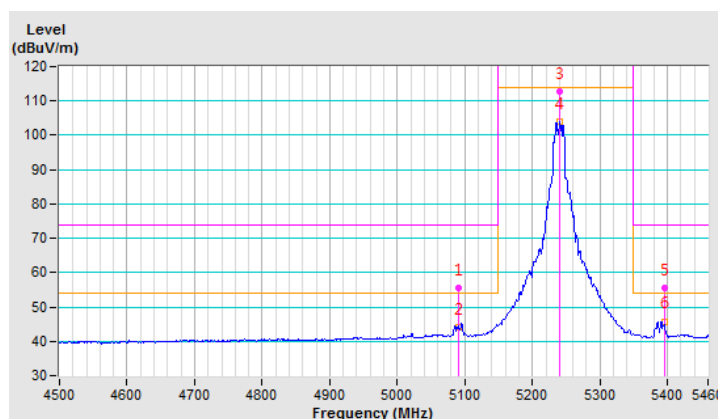

CHANNEL	TX Channel 48	DETECTOR FUNCTION	Peak (PK)
FREQUENCY RANGE	1GHz ~ 40GHz		Average (AV)

ANTENNA POLARITY & TEST DISTANCE: VERTICAL AT 3 M

NO.	FREQ. (MHz)	EMISSION LEVEL (dBuV/m)	LIMIT (dBuV/m)	MARGIN (dB)	ANTENNA HEIGHT (m)	TABLE ANGLE (Degree)	RAW VALUE (dBuV)	CORRECTION FACTOR (dB/m)
1	5090.00	57.5 PK	74.0	-16.5	1.00 V	287	54.67	2.83
2	5090.00	43.3 AV	54.0	-10.7	1.00 V	287	40.47	2.83
3	*5240.00	113.9 PK			1.00 V	287	110.69	3.21
4	*5240.00	105.1 AV			1.00 V	287	101.89	3.21
5	5395.00	56.5 PK	74.0	-17.5	1.00 V	287	52.85	3.65
6	5395.00	45.4 AV	54.0	-8.6	1.00 V	287	41.75	3.65

REMARKS:

1. Emission Level(dBuV/m) = Raw Value(dBuV) + Correction Factor(dB/m)
2. Correction Factor(dB/m) = Antenna Factor(dB/m) + Cable Factor(dB) – Pre-Amplifier Factor(dB)
3. The other emission levels were very low against the limit.
4. Margin value = Emission Level – Limit value
5. " * ": Fundamental frequency.

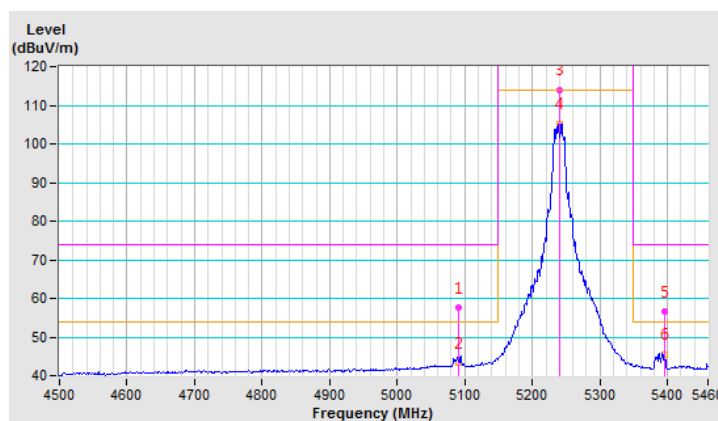

CHANNEL	TX Channel 52	DETECTOR FUNCTION	Peak (PK)
FREQUENCY RANGE	1GHz ~ 40GHz		Average (AV)

ANTENNA POLARITY & TEST DISTANCE: HORIZONTAL AT 3 M

NO.	FREQ. (MHz)	EMISSION LEVEL (dBuV/m)	LIMIT (dBuV/m)	MARGIN (dB)	ANTENNA HEIGHT (m)	TABLE ANGLE (Degree)	RAW VALUE (dBuV)	CORRECTION FACTOR (dB/m)
1	5115.00	54.2 PK	74.0	-19.8	1.06 H	276	51.30	2.90
2	5115.00	43.7 AV	54.0	-10.3	1.06 H	276	40.80	2.90
3	*5260.00	113.8 PK			1.06 H	276	110.54	3.26
4	*5260.00	103.8 AV			1.06 H	276	100.54	3.26

REMARKS:

1. Emission Level(dBuV/m) = Raw Value(dBuV) + Correction Factor(dB/m)
2. Correction Factor(dB/m) = Antenna Factor(dB/m) + Cable Factor(dB) – Pre-Amplifier Factor(dB)
3. The other emission levels were very low against the limit.
4. Margin value = Emission Level – Limit value
5. " * ": Fundamental frequency.

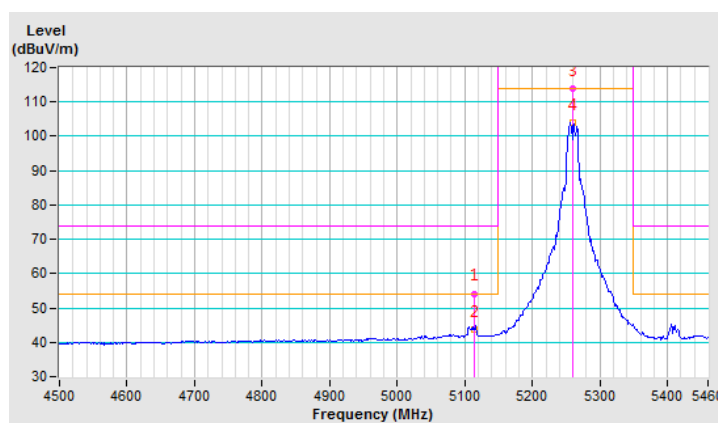

CHANNEL	TX Channel 52	DETECTOR FUNCTION	Peak (PK)
FREQUENCY RANGE	1GHz ~ 40GHz		Average (AV)

ANTENNA POLARITY & TEST DISTANCE: VERTICAL AT 3 M

NO.	FREQ. (MHz)	EMISSION LEVEL (dBuV/m)	LIMIT (dBuV/m)	MARGIN (dB)	ANTENNA HEIGHT (m)	TABLE ANGLE (Degree)	RAW VALUE (dBuV)	CORRECTION FACTOR (dB/m)
1	5115.00	53.5 PK	74.0	-20.5	1.00 V	287	50.60	2.90
2	5115.00	44.1 AV	54.0	-9.9	1.00 V	287	41.20	2.90
3	*5260.00	114.2 PK			1.00 V	287	110.94	3.26
4	*5260.00	105.5 AV			1.00 V	287	102.24	3.26

REMARKS:

1. Emission Level(dBuV/m) = Raw Value(dBuV) + Correction Factor(dB/m)
2. Correction Factor(dB/m) = Antenna Factor(dB/m) + Cable Factor(dB) – Pre-Amplifier Factor(dB)
3. The other emission levels were very low against the limit.
4. Margin value = Emission Level – Limit value
5. " * ": Fundamental frequency.

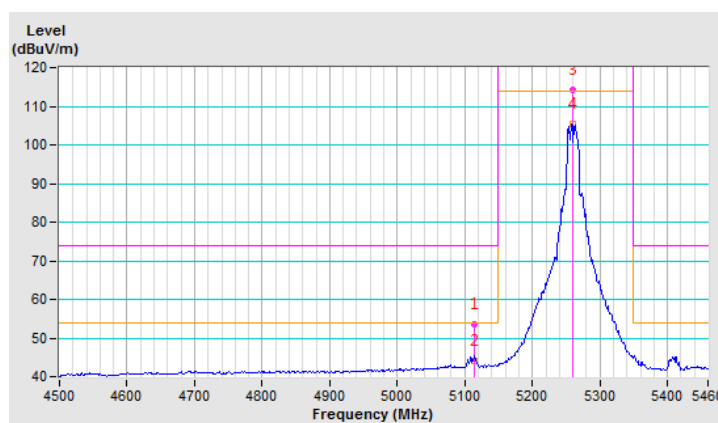

CHANNEL	TX Channel 60	DETECTOR FUNCTION	Peak (PK)
FREQUENCY RANGE	1GHz ~ 40GHz		Average (AV)

ANTENNA POLARITY & TEST DISTANCE: HORIZONTAL AT 3 M

NO.	FREQ. (MHz)	EMISSION LEVEL (dBuV/m)	LIMIT (dBuV/m)	MARGIN (dB)	ANTENNA HEIGHT (m)	TABLE ANGLE (Degree)	RAW VALUE (dBuV)	CORRECTION FACTOR (dB/m)
1	*5300.00	111.9 PK			1.07 H	278	108.53	3.37
2	*5300.00	102.9 AV			1.07 H	278	99.53	3.37
3	5350.00	68.5 PK	74.0	-5.5	1.07 H	278	64.99	3.51
4	5350.00	52.5 AV	54.0	-1.5	1.07 H	278	48.99	3.51

REMARKS:

1. Emission Level(dBuV/m) = Raw Value(dBuV) + Correction Factor(dB/m)
2. Correction Factor(dB/m) = Antenna Factor(dB/m) + Cable Factor(dB) – Pre-Amplifier Factor(dB)
3. The other emission levels were very low against the limit.
4. Margin value = Emission Level – Limit value
5. " * ": Fundamental frequency.

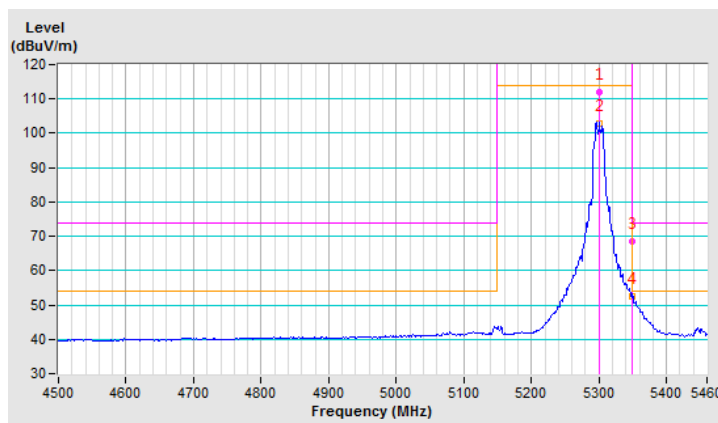

CHANNEL	TX Channel 60	DETECTOR FUNCTION	Peak (PK)
FREQUENCY RANGE	1GHz ~ 40GHz		Average (AV)

ANTENNA POLARITY & TEST DISTANCE: VERTICAL AT 3 M

NO.	FREQ. (MHz)	EMISSION LEVEL (dBuV/m)	LIMIT (dBuV/m)	MARGIN (dB)	ANTENNA HEIGHT (m)	TABLE ANGLE (Degree)	RAW VALUE (dBuV)	CORRECTION FACTOR (dB/m)
1	*5300.00	112.6 PK			1.00 V	286	109.23	3.37
2	*5300.00	103.9 AV			1.00 V	286	100.53	3.37
3	5350.00	68.4 PK	74.0	-5.6	1.00 V	286	64.89	3.51
4	5350.00	53.9 AV	54.0	-0.1	1.00 V	286	50.39	3.51

REMARKS:

1. Emission Level(dBuV/m) = Raw Value(dBuV) + Correction Factor(dB/m)
2. Correction Factor(dB/m) = Antenna Factor(dB/m) + Cable Factor(dB) – Pre-Amplifier Factor(dB)
3. The other emission levels were very low against the limit.
4. Margin value = Emission Level – Limit value
5. " * ": Fundamental frequency.

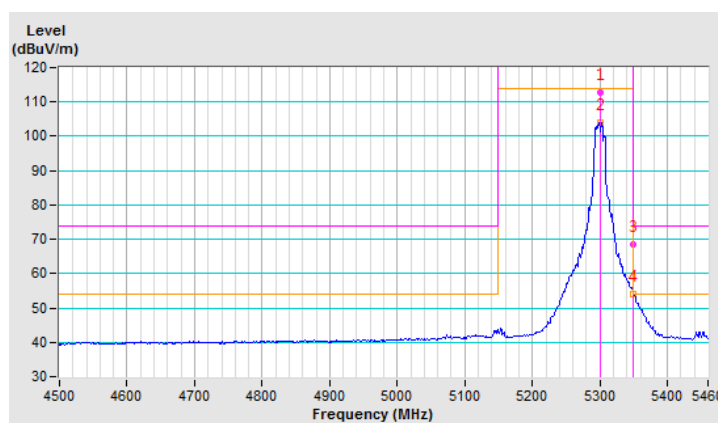

CHANNEL	TX Channel 64	DETECTOR FUNCTION	Peak (PK)
FREQUENCY RANGE	1GHz ~ 40GHz		Average (AV)

ANTENNA POLARITY & TEST DISTANCE: HORIZONTAL AT 3 M

NO.	FREQ. (MHz)	EMISSION LEVEL (dBuV/m)	LIMIT (dBuV/m)	MARGIN (dB)	ANTENNA HEIGHT (m)	TABLE ANGLE (Degree)	RAW VALUE (dBuV)	CORRECTION FACTOR (dB/m)
1	*5320.00	109.4 PK			1.18 H	279	105.97	3.43
2	*5320.00	101.1 AV			1.18 H	279	97.67	3.43
3	5350.00	68.6 PK	74.0	-5.4	1.18 H	279	65.09	3.51
4	5350.00	53.3 AV	54.0	-0.7	1.18 H	279	49.79	3.51

REMARKS:

1. Emission Level(dBuV/m) = Raw Value(dBuV) + Correction Factor(dB/m)
2. Correction Factor(dB/m) = Antenna Factor(dB/m) + Cable Factor(dB) – Pre-Amplifier Factor(dB)
3. The other emission levels were very low against the limit.
4. Margin value = Emission Level – Limit value
5. " * ": Fundamental frequency.

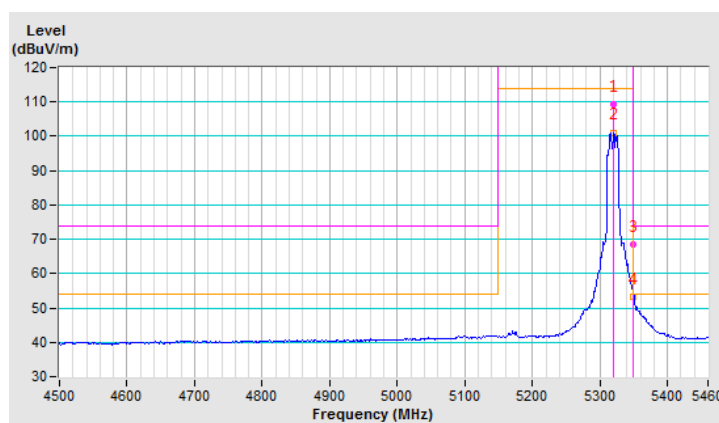

CHANNEL	TX Channel 64	DETECTOR FUNCTION	Peak (PK)
FREQUENCY RANGE	1GHz ~ 40GHz		Average (AV)

ANTENNA POLARITY & TEST DISTANCE: VERTICAL AT 3 M

NO.	FREQ. (MHz)	EMISSION LEVEL (dBuV/m)	LIMIT (dBuV/m)	MARGIN (dB)	ANTENNA HEIGHT (m)	TABLE ANGLE (Degree)	RAW VALUE (dBuV)	CORRECTION FACTOR (dB/m)
1	*5320.00	111.4 PK			1.00 V	288	107.97	3.43
2	*5320.00	101.9 AV			1.00 V	288	98.47	3.43
3	5350.00	69.3 PK	74.0	-4.7	1.00 V	288	65.79	3.51
4	5350.00	53.7 AV	54.0	-0.3	1.00 V	288	50.19	3.51

REMARKS:

1. Emission Level(dBuV/m) = Raw Value(dBuV) + Correction Factor(dB/m)
2. Correction Factor(dB/m) = Antenna Factor(dB/m) + Cable Factor(dB) – Pre-Amplifier Factor(dB)
3. The other emission levels were very low against the limit.
4. Margin value = Emission Level – Limit value
5. " * ": Fundamental frequency.

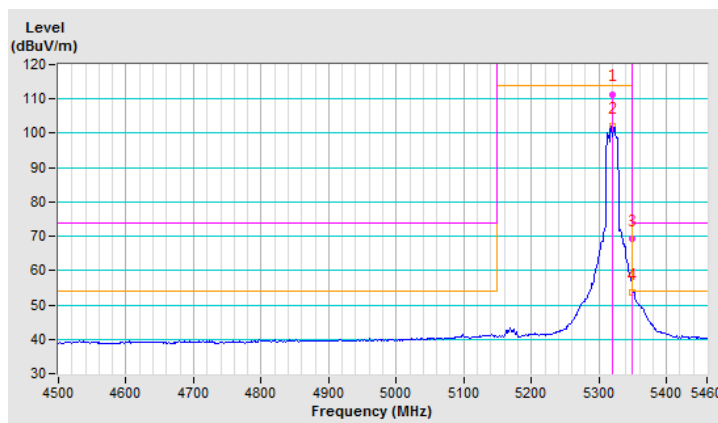

CHANNEL	TX Channel 100	DETECTOR FUNCTION	Peak (PK)
FREQUENCY RANGE	1GHz ~ 40GHz		Average (AV)

ANTENNA POLARITY & TEST DISTANCE: HORIZONTAL AT 3 M

NO.	FREQ. (MHz)	EMISSION LEVEL (dBuV/m)	LIMIT (dBuV/m)	MARGIN (dB)	ANTENNA HEIGHT (m)	TABLE ANGLE (Degree)	RAW VALUE (dBuV)	CORRECTION FACTOR (dB/m)
1	#5470.00	70.5 PK	74.0	-3.5	1.19 H	274	66.74	3.76
2	#5470.00	52.3 AV	54.0	-1.7	1.19 H	274	48.54	3.76
3	*5500.00	107.8 PK			1.19 H	274	104.01	3.79
4	*5500.00	99.8 AV			1.19 H	274	96.01	3.79
5	#5725.00	51.8 PK	74.0	-22.2	1.19 H	274	47.61	4.19
6	#5725.00	40.1 AV	54.0	-13.9	1.19 H	274	35.91	4.19

REMARKS:

1. Emission Level(dBuV/m) = Raw Value(dBuV) + Correction Factor(dB/m)
2. Correction Factor(dB/m) = Antenna Factor(dB/m) + Cable Factor(dB) – Pre-Amplifier Factor(dB)
3. The other emission levels were very low against the limit.
4. Margin value = Emission Level – Limit value
5. " * ": Fundamental frequency.
6. " # ": The radiated frequency is out of the restricted band.

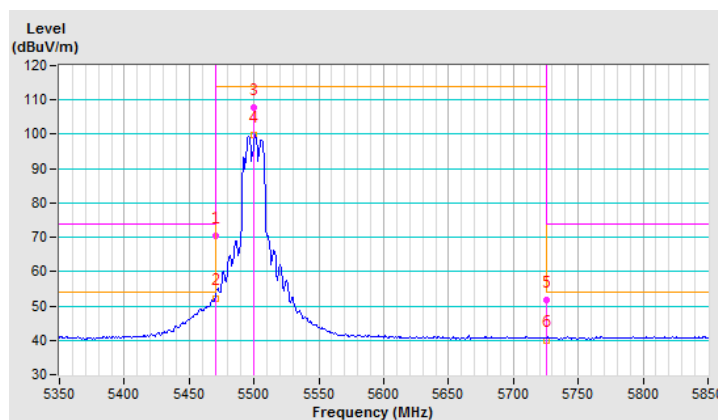

CHANNEL	TX Channel 100	DETECTOR FUNCTION	Peak (PK)
FREQUENCY RANGE	1GHz ~ 40GHz		Average (AV)

ANTENNA POLARITY & TEST DISTANCE: VERTICAL AT 3 M

NO.	FREQ. (MHz)	EMISSION LEVEL (dBuV/m)	LIMIT (dBuV/m)	MARGIN (dB)	ANTENNA HEIGHT (m)	TABLE ANGLE (Degree)	RAW VALUE (dBuV)	CORRECTION FACTOR (dB/m)
1	#5470.00	69.7 PK	74.0	-4.3	1.00 V	301	65.94	3.76
2	#5470.00	53.7 AV	54.0	-0.3	1.00 V	301	49.94	3.76
3	*5500.00	109.2 PK			1.00 V	301	105.41	3.79
4	*5500.00	100.3 AV			1.00 V	301	96.51	3.79
5	#5725.00	52.6 PK	74.0	-21.4	1.00 V	301	48.41	4.19
6	#5725.00	39.6 AV	54.0	-14.4	1.00 V	301	35.41	4.19

REMARKS:

1. Emission Level(dBuV/m) = Raw Value(dBuV) + Correction Factor(dB/m)
2. Correction Factor(dB/m) = Antenna Factor(dB/m) + Cable Factor(dB) – Pre-Amplifier Factor(dB)
3. The other emission levels were very low against the limit.
4. Margin value = Emission Level – Limit value
5. " * ": Fundamental frequency.
6. " # ": The radiated frequency is out of the restricted band.

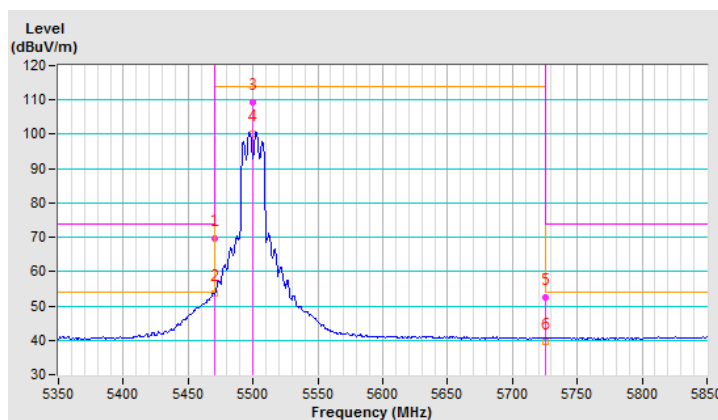

CHANNEL	TX Channel 116	DETECTOR FUNCTION	Peak (PK)
FREQUENCY RANGE	1GHz ~ 40GHz		Average (AV)

ANTENNA POLARITY & TEST DISTANCE: HORIZONTAL AT 3 M

NO.	FREQ. (MHz)	EMISSION LEVEL (dBuV/m)	LIMIT (dBuV/m)	MARGIN (dB)	ANTENNA HEIGHT (m)	TABLE ANGLE (Degree)	RAW VALUE (dBuV)	CORRECTION FACTOR (dB/m)
1	5353.00	55.1 PK	74.0	-18.9	1.24 H	273	51.57	3.53
2	5353.00	44.2 AV	54.0	-9.8	1.24 H	273	40.67	3.53
3	*5580.00	109.5 PK			1.24 H	273	105.59	3.91
4	*5580.00	100.9 AV			1.24 H	273	96.99	3.91
5	#5725.00	51.9 PK	74.0	-22.1	1.24 H	273	47.71	4.19
6	#5725.00	40.5 AV	54.0	-13.5	1.24 H	273	36.31	4.19

REMARKS:

1. Emission Level(dBuV/m) = Raw Value(dBuV) + Correction Factor(dB/m)
2. Correction Factor(dB/m) = Antenna Factor(dB/m) + Cable Factor(dB) – Pre-Amplifier Factor(dB)
3. The other emission levels were very low against the limit.
4. Margin value = Emission Level – Limit value
5. " * ": Fundamental frequency.
6. " # ": The radiated frequency is out of the restricted band.

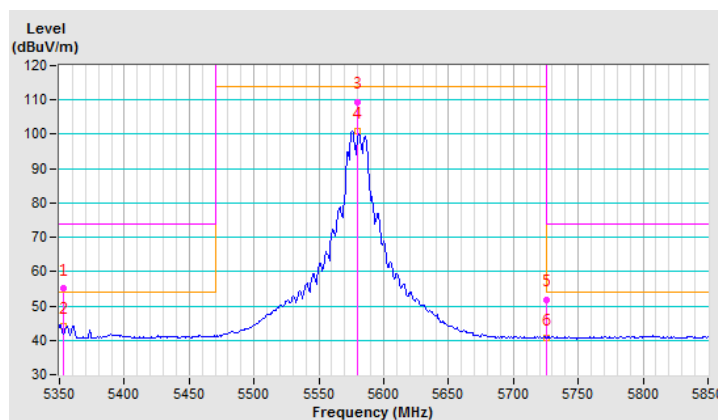

CHANNEL	TX Channel 116	DETECTOR FUNCTION	Peak (PK)
FREQUENCY RANGE	1GHz ~ 40GHz		Average (AV)

ANTENNA POLARITY & TEST DISTANCE: VERTICAL AT 3 M

NO.	FREQ. (MHz)	EMISSION LEVEL (dBuV/m)	LIMIT (dBuV/m)	MARGIN (dB)	ANTENNA HEIGHT (m)	TABLE ANGLE (Degree)	RAW VALUE (dBuV)	CORRECTION FACTOR (dB/m)
1	5353.00	53.6 PK	74.0	-20.4	1.00 V	302	50.07	3.53
2	5353.00	44.6 AV	54.0	-9.4	1.00 V	302	41.07	3.53
3	*5580.00	110.2 PK			1.01 V	302	106.29	3.91
4	*5580.00	101.7 AV			1.01 V	302	97.79	3.91
5	#5725.00	51.3 PK	74.0	-22.7	1.00 V	302	47.11	4.19
6	#5725.00	40.2 AV	54.0	-13.8	1.00 V	302	36.01	4.19

REMARKS:

1. Emission Level(dBuV/m) = Raw Value(dBuV) + Correction Factor(dB/m)
2. Correction Factor(dB/m) = Antenna Factor(dB/m) + Cable Factor(dB) – Pre-Amplifier Factor(dB)
3. The other emission levels were very low against the limit.
4. Margin value = Emission Level – Limit value
5. " * ": Fundamental frequency.
6. " # ": The radiated frequency is out of the restricted band.

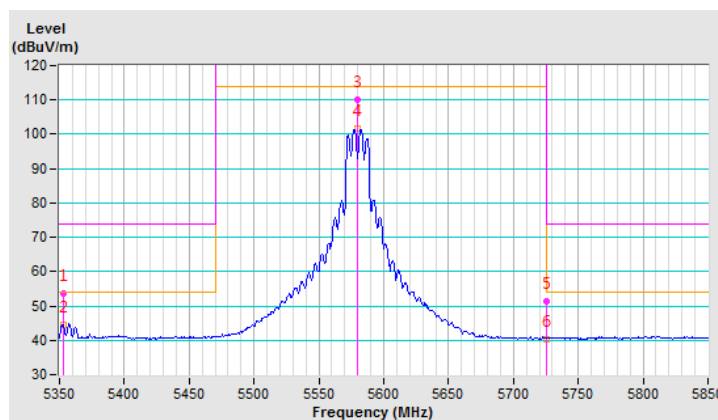

CHANNEL	TX Channel 140	DETECTOR FUNCTION	Peak (PK)
FREQUENCY RANGE	1GHz ~ 40GHz		Average (AV)

ANTENNA POLARITY & TEST DISTANCE: HORIZONTAL AT 3 M

NO.	FREQ. (MHz)	EMISSION LEVEL (dBuV/m)	LIMIT (dBuV/m)	MARGIN (dB)	ANTENNA HEIGHT (m)	TABLE ANGLE (Degree)	RAW VALUE (dBuV)	CORRECTION FACTOR (dB/m)
1	*5700.00	103.6 PK			1.01 H	270	99.41	4.19
2	*5700.00	94.6 AV			1.01 H	270	90.41	4.19
3	#5725.00	65.6 PK	74.0	-8.4	1.01 H	270	61.41	4.19
4	#5725.00	50.8 AV	54.0	-3.2	1.01 H	270	46.61	4.19

REMARKS:

1. Emission Level(dBuV/m) = Raw Value(dBuV) + Correction Factor(dB/m)
2. Correction Factor(dB/m) = Antenna Factor(dB/m) + Cable Factor(dB) – Pre-Amplifier Factor(dB)
3. The other emission levels were very low against the limit.
4. Margin value = Emission Level – Limit value
5. " * ": Fundamental frequency.
6. " # ": The radiated frequency is out of the restricted band.

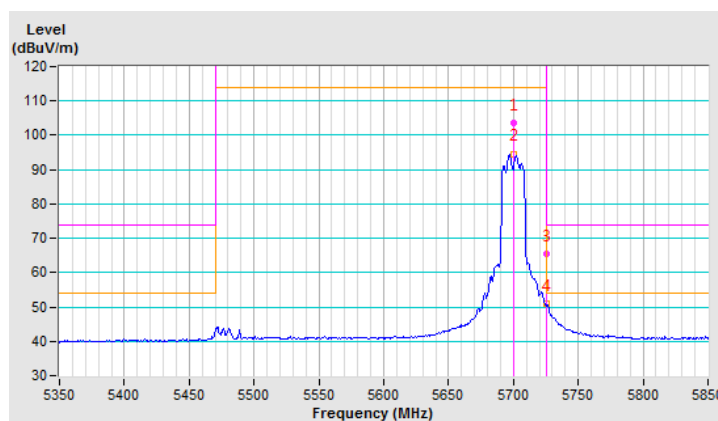

CHANNEL	TX Channel 140	DETECTOR FUNCTION	Peak (PK)
FREQUENCY RANGE	1GHz ~ 40GHz		Average (AV)

ANTENNA POLARITY & TEST DISTANCE: VERTICAL AT 3 M

NO.	FREQ. (MHz)	EMISSION LEVEL (dBuV/m)	LIMIT (dBuV/m)	MARGIN (dB)	ANTENNA HEIGHT (m)	TABLE ANGLE (Degree)	RAW VALUE (dBuV)	CORRECTION FACTOR (dB/m)
1	*5700.00	105.7 PK			1.00 V	335	101.51	4.19
2	*5700.00	97.2 AV			1.00 V	335	93.01	4.19
3	#5725.00	72.6 PK	74.0	-1.4	1.00 V	335	68.41	4.19
4	#5725.00	53.8 AV	54.0	-0.2	1.00 V	335	49.61	4.19

REMARKS:

1. Emission Level(dBuV/m) = Raw Value(dBuV) + Correction Factor(dB/m)
2. Correction Factor(dB/m) = Antenna Factor(dB/m) + Cable Factor(dB) – Pre-Amplifier Factor(dB)
3. The other emission levels were very low against the limit.
4. Margin value = Emission Level – Limit value
5. " * ": Fundamental frequency.
6. " # ": The radiated frequency is out of the restricted band.

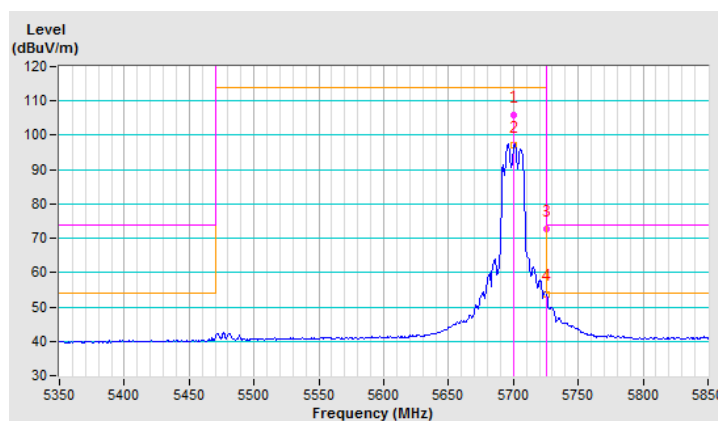

CHANNEL	TX Channel 149	DETECTOR FUNCTION	Peak (PK)
FREQUENCY RANGE	1GHz ~ 40GHz		Average (AV)

ANTENNA POLARITY & TEST DISTANCE: HORIZONTAL AT 3 M

NO.	FREQ. (MHz)	EMISSION LEVEL (dBuV/m)	LIMIT (dBuV/m)	MARGIN (dB)	ANTENNA HEIGHT (m)	TABLE ANGLE (Degree)	RAW VALUE (dBuV)	CORRECTION FACTOR (dB/m)
1	#5715.00	68.4 PK	74.0	-5.6	1.00 H	296	64.21	4.19
2	#5715.00	48.8 AV	54.0	-5.2	1.00 H	296	44.61	4.19
3	#5725.00	74.9 PK	78.2	-3.3	1.00 H	296	70.71	4.19
4	*5745.00	104.1 PK			1.00 H	296	99.91	4.19
5	*5745.00	95.0 AV			1.00 H	296	90.81	4.19

REMARKS:

1. Emission Level(dBuV/m) = Raw Value(dBuV) + Correction Factor(dB/m)
2. Correction Factor(dB/m) = Antenna Factor(dB/m) + Cable Factor(dB) – Pre-Amplifier Factor(dB)
3. The other emission levels were very low against the limit.
4. Margin value = Emission Level – Limit value
5. " * ": Fundamental frequency.
6. " # ": The radiated frequency is out of the restricted band.

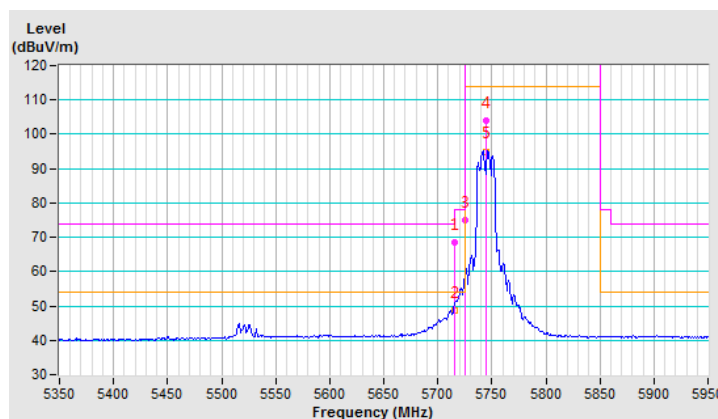

CHANNEL	TX Channel 149	DETECTOR FUNCTION	Peak (PK)
FREQUENCY RANGE	1GHz ~ 40GHz		Average (AV)

ANTENNA POLARITY & TEST DISTANCE: VERTICAL AT 3 M

NO.	FREQ. (MHz)	EMISSION LEVEL (dBuV/m)	LIMIT (dBuV/m)	MARGIN (dB)	ANTENNA HEIGHT (m)	TABLE ANGLE (Degree)	RAW VALUE (dBuV)	CORRECTION FACTOR (dB/m)
1	#5715.00	69.7 PK	74.0	-4.3	1.00 V	335	65.51	4.19
2	#5715.00	53.9 AV	54.0	-0.1	1.00 V	335	49.71	4.19
3	#5725.00	78.0 PK	78.2	-0.2	1.00 V	335	73.81	4.19
4	*5745.00	106.8 PK			1.00 V	335	102.61	4.19
5	*5745.00	98.0 AV			1.00 V	335	93.81	4.19

REMARKS:

1. Emission Level(dBuV/m) = Raw Value(dBuV) + Correction Factor(dB/m)
2. Correction Factor(dB/m) = Antenna Factor(dB/m) + Cable Factor(dB) – Pre-Amplifier Factor(dB)
3. The other emission levels were very low against the limit.
4. Margin value = Emission Level – Limit value
5. " * ": Fundamental frequency.
6. " # ": The radiated frequency is out of the restricted band.

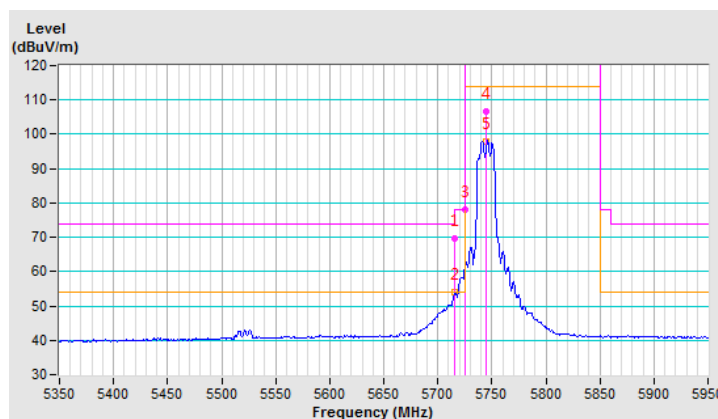

CHANNEL	TX Channel 157	DETECTOR FUNCTION	Peak (PK)
FREQUENCY RANGE	1GHz ~ 40GHz		Average (AV)

ANTENNA POLARITY & TEST DISTANCE: HORIZONTAL AT 3 M

NO.	FREQ. (MHz)	EMISSION LEVEL (dBuV/m)	LIMIT (dBuV/m)	MARGIN (dB)	ANTENNA HEIGHT (m)	TABLE ANGLE (Degree)	RAW VALUE (dBuV)	CORRECTION FACTOR (dB/m)
1	#5715.00	58.7 PK	74.0	-15.3	1.00 H	242	54.51	4.19
2	#5715.00	44.2 AV	54.0	-9.8	1.00 H	242	40.01	4.19
3	#5725.00	61.6 PK	78.2	-16.6	1.00 H	242	57.41	4.19
4	*5785.00	107.1 PK			1.00 H	242	102.92	4.18
5	*5785.00	98.1 AV			1.00 H	242	93.92	4.18
6	#5850.00	62.8 PK	78.2	-15.4	1.00 H	242	58.55	4.25
7	#5860.00	59.4 PK	74.0	-14.6	1.00 H	242	55.14	4.26
8	#5860.00	43.9 AV	54.0	-10.1	1.00 H	242	39.64	4.26

REMARKS:

1. Emission Level(dBuV/m) = Raw Value(dBuV) + Correction Factor(dB/m)
2. Correction Factor(dB/m) = Antenna Factor(dB/m) + Cable Factor(dB) – Pre-Amplifier Factor(dB)
3. The other emission levels were very low against the limit.
4. Margin value = Emission Level – Limit value
5. " * ": Fundamental frequency.
6. " # ": The radiated frequency is out of the restricted band.

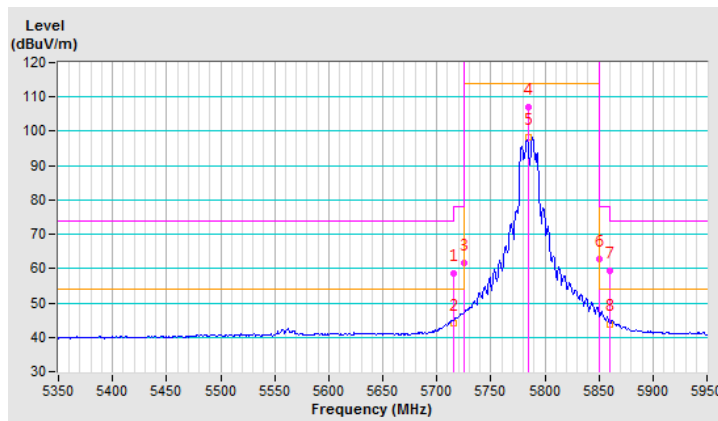

CHANNEL	TX Channel 157	DETECTOR FUNCTION	Peak (PK)
FREQUENCY RANGE	1GHz ~ 40GHz		Average (AV)

ANTENNA POLARITY & TEST DISTANCE: VERTICAL AT 3 M

NO.	FREQ. (MHz)	EMISSION LEVEL (dBuV/m)	LIMIT (dBuV/m)	MARGIN (dB)	ANTENNA HEIGHT (m)	TABLE ANGLE (Degree)	RAW VALUE (dBuV)	CORRECTION FACTOR (dB/m)
1	#5715.00	61.5 PK	74.0	-12.5	1.00 V	336	57.31	4.19
2	#5715.00	47.4 AV	54.0	-6.6	1.00 V	336	43.21	4.19
3	#5725.00	68.1 PK	78.2	-10.1	1.00 V	336	63.91	4.19
4	*5785.00	109.7 PK			1.00 V	336	105.52	4.18
5	*5785.00	101.1 AV			1.00 V	336	96.92	4.18
6	#5850.00	64.2 PK	78.2	-14.0	1.00 V	336	59.95	4.25
7	#5860.00	62.6 PK	74.0	-11.4	1.00 V	336	58.34	4.26
8	#5860.00	46.5 AV	54.0	-7.5	1.00 V	336	42.24	4.26

REMARKS:

1. Emission Level(dBuV/m) = Raw Value(dBuV) + Correction Factor(dB/m)
2. Correction Factor(dB/m) = Antenna Factor(dB/m) + Cable Factor(dB) – Pre-Amplifier Factor(dB)
3. The other emission levels were very low against the limit.
4. Margin value = Emission Level – Limit value
5. " * ": Fundamental frequency.
6. " # ": The radiated frequency is out of the restricted band.

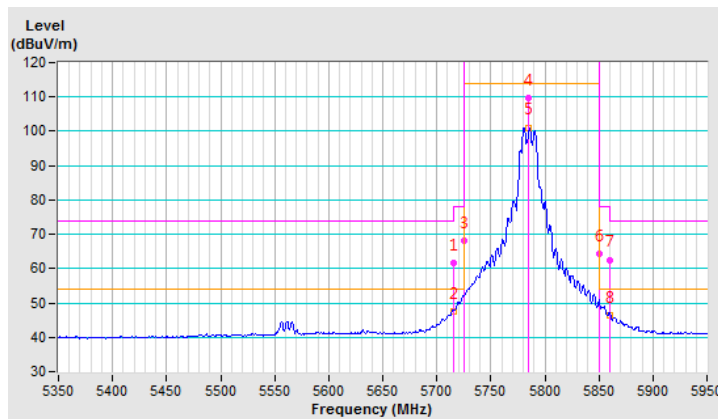

CHANNEL	TX Channel 165	DETECTOR FUNCTION	Peak (PK)
FREQUENCY RANGE	1GHz ~ 40GHz		Average (AV)

ANTENNA POLARITY & TEST DISTANCE: HORIZONTAL AT 3 M

NO.	FREQ. (MHz)	EMISSION LEVEL (dBuV/m)	LIMIT (dBuV/m)	MARGIN (dB)	ANTENNA HEIGHT (m)	TABLE ANGLE (Degree)	RAW VALUE (dBuV)	CORRECTION FACTOR (dB/m)
1	*5825.00	103.8 PK			1.00 H	243	99.58	4.22
2	*5825.00	95.4 AV			1.00 H	243	91.18	4.22
3	#5850.00	69.7 PK	78.2	-8.5	1.00 H	243	65.45	4.25
4	#5860.00	65.5 PK	74.0	-8.5	1.00 H	243	61.24	4.26
5	#5860.00	49.6 AV	54.0	-4.4	1.00 H	243	45.34	4.26

REMARKS:

1. Emission Level(dBuV/m) = Raw Value(dBuV) + Correction Factor(dB/m)
2. Correction Factor(dB/m) = Antenna Factor(dB/m) + Cable Factor(dB) – Pre-Amplifier Factor(dB)
3. The other emission levels were very low against the limit.
4. Margin value = Emission Level – Limit value
5. " * ": Fundamental frequency.
6. " # ": The radiated frequency is out of the restricted band.

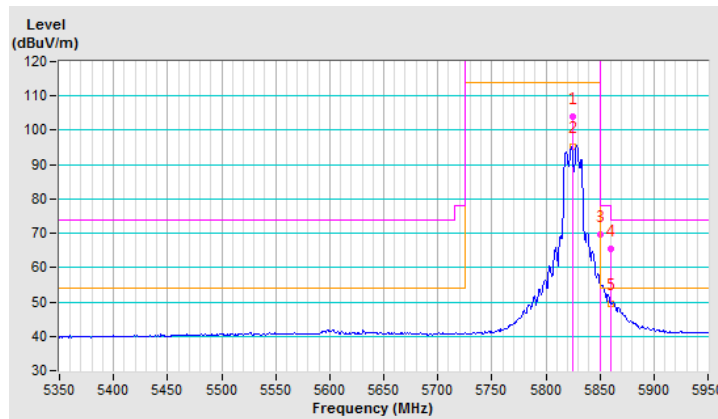

CHANNEL	TX Channel 165	DETECTOR FUNCTION	Peak (PK)
FREQUENCY RANGE	1GHz ~ 40GHz		Average (AV)

ANTENNA POLARITY & TEST DISTANCE: VERTICAL AT 3 M

NO.	FREQ. (MHz)	EMISSION LEVEL (dBuV/m)	LIMIT (dBuV/m)	MARGIN (dB)	ANTENNA HEIGHT (m)	TABLE ANGLE (Degree)	RAW VALUE (dBuV)	CORRECTION FACTOR (dB/m)
1	*5825.00	107.2 PK			1.00 V	335	102.98	4.22
2	*5825.00	98.7 AV			1.00 V	335	94.48	4.22
3	#5850.00	77.6 PK	78.2	-0.6	1.00 V	335	73.35	4.25
4	#5860.00	69.1 PK	74.0	-4.9	1.00 V	335	64.84	4.26
5	#5860.00	53.1 AV	54.0	-0.9	1.00 V	335	48.84	4.26

REMARKS:

1. Emission Level(dBuV/m) = Raw Value(dBuV) + Correction Factor(dB/m)
2. Correction Factor(dB/m) = Antenna Factor(dB/m) + Cable Factor(dB) – Pre-Amplifier Factor(dB)
3. The other emission levels were very low against the limit.
4. Margin value = Emission Level – Limit value
5. " * ": Fundamental frequency.
6. " # ": The radiated frequency is out of the restricted band.

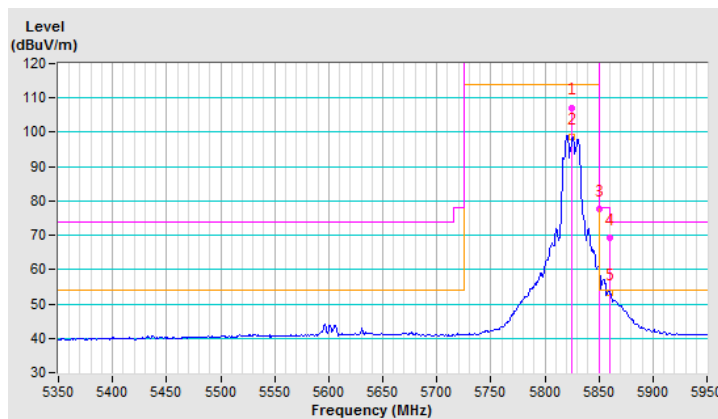

802.11n (20MHz)

CHANNEL	TX Channel 36	DETECTOR FUNCTION	Peak (PK)
FREQUENCY RANGE	1GHz ~ 40GHz		Average (AV)

ANTENNA POLARITY & TEST DISTANCE: HORIZONTAL AT 3 M								
NO.	FREQ. (MHz)	EMISSION LEVEL (dBuV/m)	LIMIT (dBuV/m)	MARGIN (dB)	ANTENNA HEIGHT (m)	TABLE ANGLE (Degree)	RAW VALUE (dBuV)	CORRECTION FACTOR (dB/m)
1	5150.00	67.5 PK	74.0	-6.5	1.00 H	296	64.52	2.98
2	5150.00	51.4 AV	54.0	-2.6	1.00 H	296	48.42	2.98
3	*5180.00	106.8 PK			1.00 H	296	103.74	3.06
4	*5180.00	98.0 AV			1.00 H	296	94.94	3.06

REMARKS:

1. Emission Level(dBuV/m) = Raw Value(dBuV) + Correction Factor(dB/m)
2. Correction Factor(dB/m) = Antenna Factor(dB/m) + Cable Factor(dB) – Pre-Amplifier Factor(dB)
3. The other emission levels were very low against the limit.
4. Margin value = Emission Level – Limit value
5. " * ": Fundamental frequency.

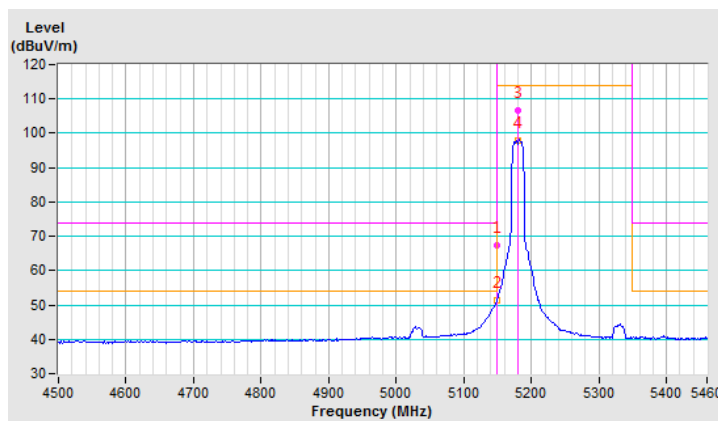

CHANNEL	TX Channel 36	DETECTOR FUNCTION	Peak (PK)
FREQUENCY RANGE	1GHz ~ 40GHz		Average (AV)

ANTENNA POLARITY & TEST DISTANCE: VERTICAL AT 3 M

NO.	FREQ. (MHz)	EMISSION LEVEL (dBuV/m)	LIMIT (dBuV/m)	MARGIN (dB)	ANTENNA HEIGHT (m)	TABLE ANGLE (Degree)	RAW VALUE (dBuV)	CORRECTION FACTOR (dB/m)
1	5150.00	71.2 PK	74.0	-2.8	1.00 V	285	68.22	2.98
2	5150.00	53.8 AV	54.0	-0.2	1.00 V	285	50.82	2.98
3	*5180.00	107.3 PK			1.00 V	285	104.24	3.06
4	*5180.00	98.5 AV			1.00 V	285	95.44	3.06

REMARKS:

1. Emission Level(dBuV/m) = Raw Value(dBuV) + Correction Factor(dB/m)
2. Correction Factor(dB/m) = Antenna Factor(dB/m) + Cable Factor(dB) – Pre-Amplifier Factor(dB)
3. The other emission levels were very low against the limit.
4. Margin value = Emission Level – Limit value
5. " * ": Fundamental frequency.

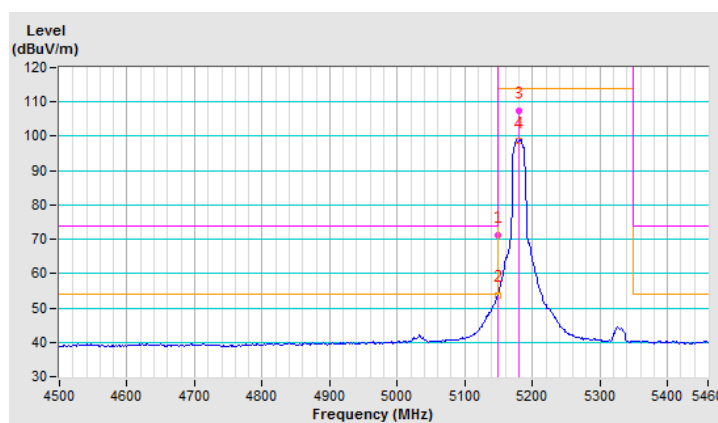

CHANNEL	TX Channel 40	DETECTOR FUNCTION	Peak (PK)
FREQUENCY RANGE	1GHz ~ 40GHz		Average (AV)

ANTENNA POLARITY & TEST DISTANCE: HORIZONTAL AT 3 M

NO.	FREQ. (MHz)	EMISSION LEVEL (dBuV/m)	LIMIT (dBuV/m)	MARGIN (dB)	ANTENNA HEIGHT (m)	TABLE ANGLE (Degree)	RAW VALUE (dBuV)	CORRECTION FACTOR (dB/m)
1	5150.00	64.0 PK	74.0	-10.0	1.00 H	298	61.02	2.98
2	5150.00	51.6 AV	54.0	-2.4	1.00 H	298	48.62	2.98
3	*5200.00	110.2 PK			1.00 H	298	107.10	3.10
4	*5200.00	100.8 AV			1.00 H	298	97.70	3.10

REMARKS:

1. Emission Level(dBuV/m) = Raw Value(dBuV) + Correction Factor(dB/m)
2. Correction Factor(dB/m) = Antenna Factor(dB/m) + Cable Factor(dB) – Pre-Amplifier Factor(dB)
3. The other emission levels were very low against the limit.
4. Margin value = Emission Level – Limit value
5. " * ": Fundamental frequency.

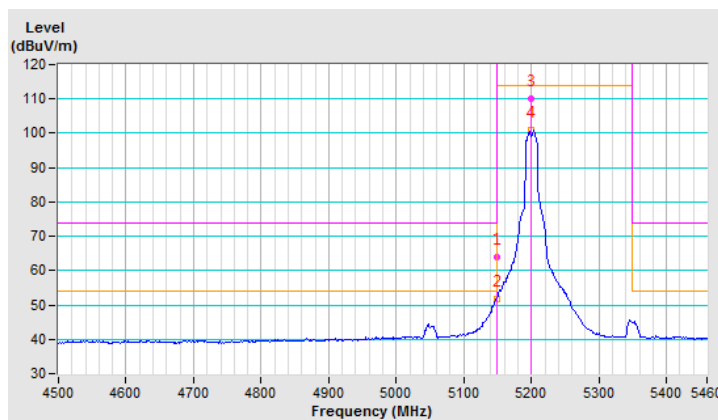

CHANNEL	TX Channel 40	DETECTOR FUNCTION	Peak (PK)
FREQUENCY RANGE	1GHz ~ 40GHz		Average (AV)

ANTENNA POLARITY & TEST DISTANCE: VERTICAL AT 3 M

NO.	FREQ. (MHz)	EMISSION LEVEL (dBuV/m)	LIMIT (dBuV/m)	MARGIN (dB)	ANTENNA HEIGHT (m)	TABLE ANGLE (Degree)	RAW VALUE (dBuV)	CORRECTION FACTOR (dB/m)
1	5150.00	68.2 PK	74.0	-5.8	1.00 V	287	65.22	2.98
2	5150.00	53.0 AV	54.0	-1.0	1.00 V	287	50.02	2.98
3	*5200.00	111.8 PK			1.00 V	287	108.70	3.10
4	*5200.00	102.2 AV			1.00 V	287	99.10	3.10

REMARKS:

1. Emission Level(dBuV/m) = Raw Value(dBuV) + Correction Factor(dB/m)
2. Correction Factor(dB/m) = Antenna Factor(dB/m) + Cable Factor(dB) – Pre-Amplifier Factor(dB)
3. The other emission levels were very low against the limit.
4. Margin value = Emission Level – Limit value
5. " * ": Fundamental frequency.

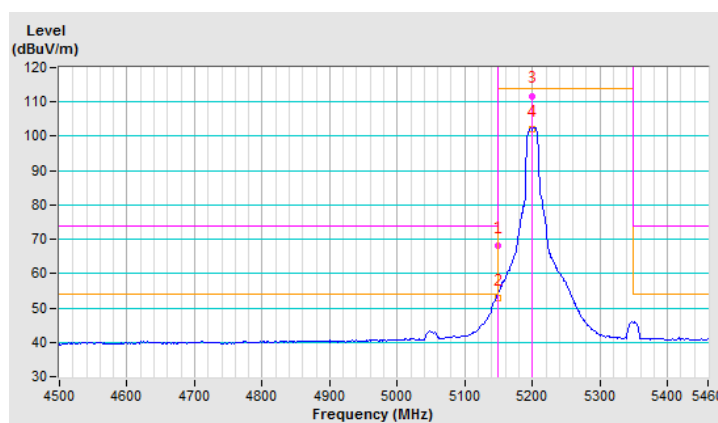

CHANNEL	TX Channel 48	DETECTOR FUNCTION	Peak (PK)
FREQUENCY RANGE	1GHz ~ 40GHz		Average (AV)

ANTENNA POLARITY & TEST DISTANCE: HORIZONTAL AT 3 M

NO.	FREQ. (MHz)	EMISSION LEVEL (dBuV/m)	LIMIT (dBuV/m)	MARGIN (dB)	ANTENNA HEIGHT (m)	TABLE ANGLE (Degree)	RAW VALUE (dBuV)	CORRECTION FACTOR (dB/m)
1	5150.00	56.1 PK	74.0	-17.9	1.03 H	295	53.12	2.98
2	5150.00	44.6 AV	54.0	-9.4	1.03 H	295	41.62	2.98
3	*5240.00	112.8 PK			1.03 H	295	109.59	3.21
4	*5240.00	103.3 AV			1.03 H	295	100.09	3.21
5	5386.00	54.4 PK	74.0	-19.6	1.03 H	295	50.78	3.62
6	5386.00	45.1 AV	54.0	-8.9	1.03 H	295	41.48	3.62

REMARKS:

1. Emission Level(dBuV/m) = Raw Value(dBuV) + Correction Factor(dB/m)
2. Correction Factor(dB/m) = Antenna Factor(dB/m) + Cable Factor(dB) – Pre-Amplifier Factor(dB)
3. The other emission levels were very low against the limit.
4. Margin value = Emission Level – Limit value
5. " * ": Fundamental frequency.

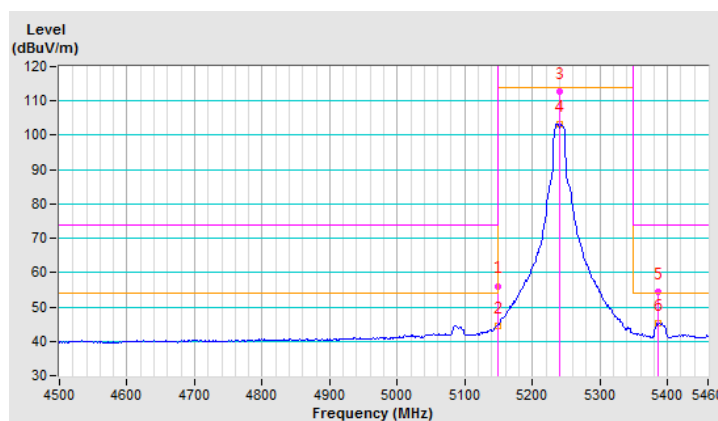

CHANNEL	TX Channel 48	DETECTOR FUNCTION	Peak (PK)
FREQUENCY RANGE	1GHz ~ 40GHz		Average (AV)

ANTENNA POLARITY & TEST DISTANCE: VERTICAL AT 3 M

NO.	FREQ. (MHz)	EMISSION LEVEL (dBuV/m)	LIMIT (dBuV/m)	MARGIN (dB)	ANTENNA HEIGHT (m)	TABLE ANGLE (Degree)	RAW VALUE (dBuV)	CORRECTION FACTOR (dB/m)
1	5150.00	54.8 PK	74.0	-19.2	1.00 V	288	51.82	2.98
2	5150.00	43.8 AV	54.0	-10.2	1.00 V	288	40.82	2.98
3	*5240.00	113.6 PK			1.00 V	288	110.39	3.21
4	*5240.00	104.6 AV			1.00 V	288	101.39	3.21
5	5386.00	54.1 PK	74.0	-19.9	1.00 V	288	50.48	3.62
6	5386.00	44.9 AV	54.0	-9.1	1.00 V	288	41.28	3.62

REMARKS:

1. Emission Level(dBuV/m) = Raw Value(dBuV) + Correction Factor(dB/m)
2. Correction Factor(dB/m) = Antenna Factor(dB/m) + Cable Factor(dB) – Pre-Amplifier Factor(dB)
3. The other emission levels were very low against the limit.
4. Margin value = Emission Level – Limit value
5. " * ": Fundamental frequency.

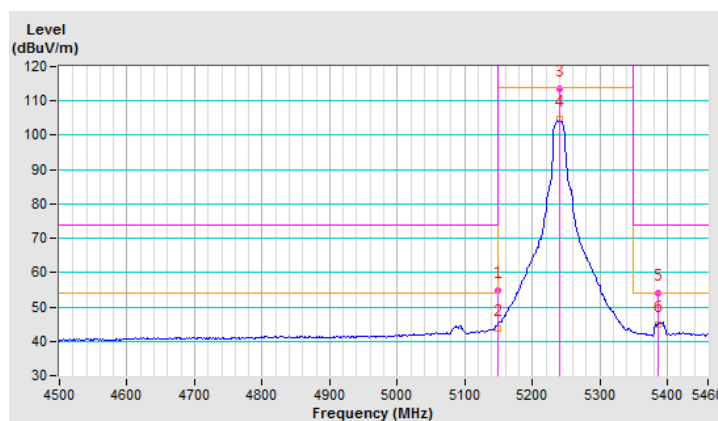

CHANNEL	TX Channel 52	DETECTOR FUNCTION	Peak (PK)
FREQUENCY RANGE	1GHz ~ 40GHz		Average (AV)

ANTENNA POLARITY & TEST DISTANCE: HORIZONTAL AT 3 M

NO.	FREQ. (MHz)	EMISSION LEVEL (dBuV/m)	LIMIT (dBuV/m)	MARGIN (dB)	ANTENNA HEIGHT (m)	TABLE ANGLE (Degree)	RAW VALUE (dBuV)	CORRECTION FACTOR (dB/m)
1	5115.00	53.7 PK	74.0	-20.3	1.00 H	295	50.80	2.90
2	5115.00	43.2 AV	54.0	-10.8	1.00 H	295	40.30	2.90
3	*5260.00	113.2 PK			1.00 H	295	109.94	3.26
4	*5260.00	104.2 AV			1.00 H	295	100.94	3.26
5	5350.00	58.9 PK	74.0	-15.1	1.00 H	295	55.39	3.51
6	5350.00	45.1 AV	54.0	-8.9	1.00 H	295	41.59	3.51

REMARKS:

1. Emission Level(dBuV/m) = Raw Value(dBuV) + Correction Factor(dB/m)
2. Correction Factor(dB/m) = Antenna Factor(dB/m) + Cable Factor(dB) – Pre-Amplifier Factor(dB)
3. The other emission levels were very low against the limit.
4. Margin value = Emission Level – Limit value
5. " * ": Fundamental frequency.

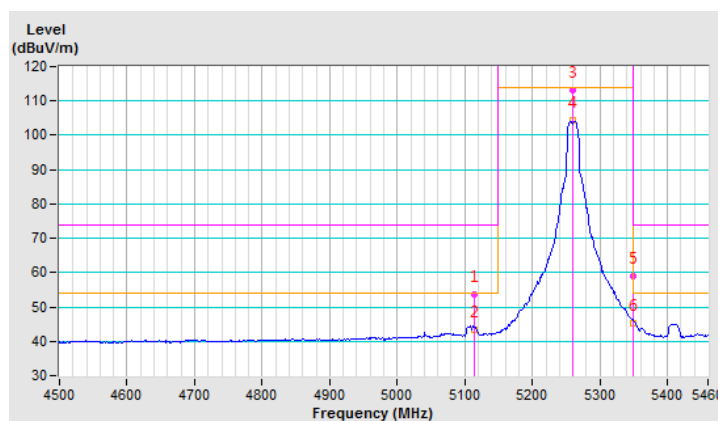

CHANNEL	TX Channel 52	DETECTOR FUNCTION	Peak (PK)
FREQUENCY RANGE	1GHz ~ 40GHz		Average (AV)

ANTENNA POLARITY & TEST DISTANCE: VERTICAL AT 3 M

NO.	FREQ. (MHz)	EMISSION LEVEL (dBuV/m)	LIMIT (dBuV/m)	MARGIN (dB)	ANTENNA HEIGHT (m)	TABLE ANGLE (Degree)	RAW VALUE (dBuV)	CORRECTION FACTOR (dB/m)
1	5115.00	53.6 PK	74.0	-20.4	1.00 V	282	50.70	2.90
2	5115.00	42.8 AV	54.0	-11.2	1.00 V	282	39.90	2.90
3	*5260.00	113.3 PK			1.00 V	282	110.04	3.26
4	*5260.00	103.5 AV			1.00 V	282	100.24	3.26
5	5350.00	60.2 PK	74.0	-13.8	1.00 V	282	56.69	3.51
6	5350.00	44.7 AV	54.0	-9.3	1.00 V	282	41.19	3.51

REMARKS:

1. Emission Level(dBuV/m) = Raw Value(dBuV) + Correction Factor(dB/m)
2. Correction Factor(dB/m) = Antenna Factor(dB/m) + Cable Factor(dB) – Pre-Amplifier Factor(dB)
3. The other emission levels were very low against the limit.
4. Margin value = Emission Level – Limit value
5. " * ": Fundamental frequency.

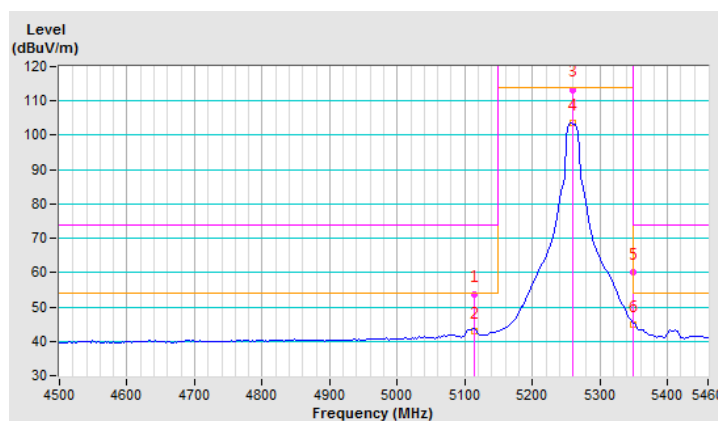

CHANNEL	TX Channel 60	DETECTOR FUNCTION	Peak (PK)
FREQUENCY RANGE	1GHz ~ 40GHz		Average (AV)

ANTENNA POLARITY & TEST DISTANCE: HORIZONTAL AT 3 M

NO.	FREQ. (MHz)	EMISSION LEVEL (dBuV/m)	LIMIT (dBuV/m)	MARGIN (dB)	ANTENNA HEIGHT (m)	TABLE ANGLE (Degree)	RAW VALUE (dBuV)	CORRECTION FACTOR (dB/m)
1	*5300.00	112.0 PK			1.00 H	295	108.63	3.37
2	*5300.00	103.1 AV			1.00 H	295	99.73	3.37
3	5350.00	68.9 PK	74.0	-5.1	1.00 H	295	65.39	3.51
4	5350.00	53.9 AV	54.0	-0.1	1.00 H	295	50.39	3.51

REMARKS:

1. Emission Level(dBuV/m) = Raw Value(dBuV) + Correction Factor(dB/m)
2. Correction Factor(dB/m) = Antenna Factor(dB/m) + Cable Factor(dB) – Pre-Amplifier Factor(dB)
3. The other emission levels were very low against the limit.
4. Margin value = Emission Level – Limit value
5. " * ": Fundamental frequency.

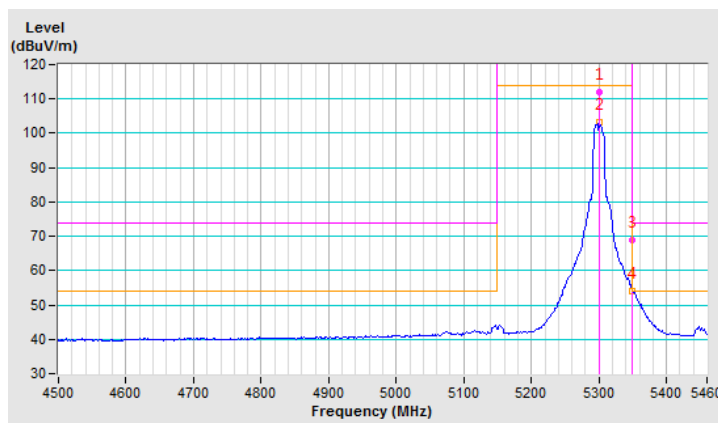

CHANNEL	TX Channel 60	DETECTOR FUNCTION	Peak (PK)
FREQUENCY RANGE	1GHz ~ 40GHz		Average (AV)

ANTENNA POLARITY & TEST DISTANCE: VERTICAL AT 3 M

NO.	FREQ. (MHz)	EMISSION LEVEL (dBuV/m)	LIMIT (dBuV/m)	MARGIN (dB)	ANTENNA HEIGHT (m)	TABLE ANGLE (Degree)	RAW VALUE (dBuV)	CORRECTION FACTOR (dB/m)
1	*5300.00	112.4 PK			1.00 V	302	109.03	3.37
2	*5300.00	102.9 AV			1.00 V	302	99.53	3.37
3	5350.00	66.7 PK	74.0	-7.3	1.00 V	302	63.19	3.51
4	5350.00	53.6 AV	54.0	-0.4	1.00 V	302	50.09	3.51

REMARKS:

1. Emission Level(dBuV/m) = Raw Value(dBuV) + Correction Factor(dB/m)
2. Correction Factor(dB/m) = Antenna Factor(dB/m) + Cable Factor(dB) – Pre-Amplifier Factor(dB)
3. The other emission levels were very low against the limit.
4. Margin value = Emission Level – Limit value
5. " * ": Fundamental frequency.

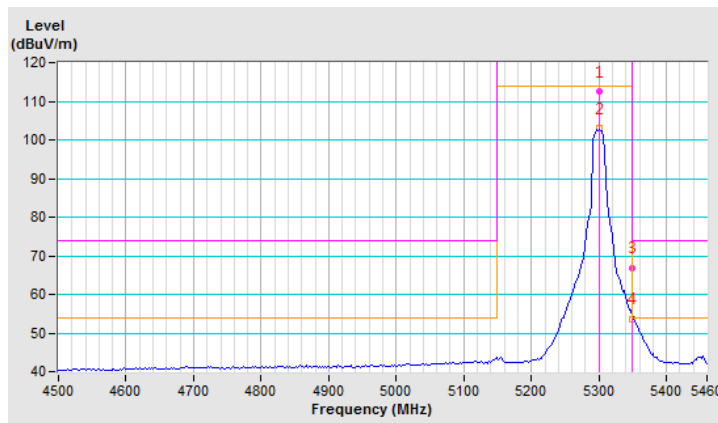

CHANNEL	TX Channel 64	DETECTOR FUNCTION	Peak (PK)
FREQUENCY RANGE	1GHz ~ 40GHz		Average (AV)

ANTENNA POLARITY & TEST DISTANCE: HORIZONTAL AT 3 M

NO.	FREQ. (MHz)	EMISSION LEVEL (dBuV/m)	LIMIT (dBuV/m)	MARGIN (dB)	ANTENNA HEIGHT (m)	TABLE ANGLE (Degree)	RAW VALUE (dBuV)	CORRECTION FACTOR (dB/m)
1	*5320.00	109.2 PK			1.00 H	295	105.77	3.43
2	*5320.00	100.5 AV			1.00 H	295	97.07	3.43
3	5350.00	69.9 PK	74.0	-4.1	1.00 H	295	66.39	3.51
4	5350.00	53.9 AV	54.0	-0.1	1.00 H	295	50.39	3.51

REMARKS:

1. Emission Level(dBuV/m) = Raw Value(dBuV) + Correction Factor(dB/m)
2. Correction Factor(dB/m) = Antenna Factor(dB/m) + Cable Factor(dB) – Pre-Amplifier Factor(dB)
3. The other emission levels were very low against the limit.
4. Margin value = Emission Level – Limit value
5. " * ": Fundamental frequency.

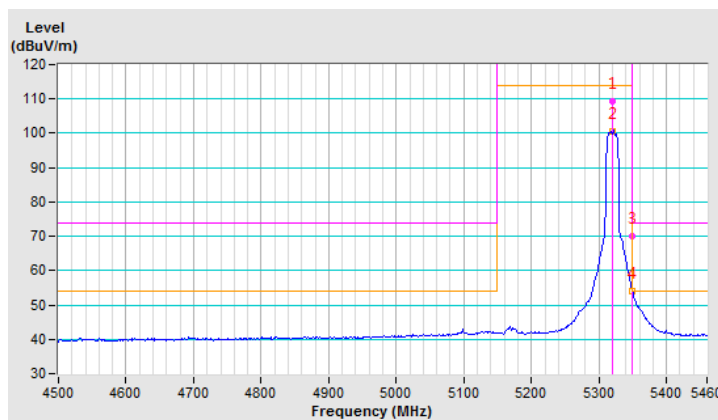

CHANNEL	TX Channel 64	DETECTOR FUNCTION	Peak (PK)
FREQUENCY RANGE	1GHz ~ 40GHz		Average (AV)

ANTENNA POLARITY & TEST DISTANCE: VERTICAL AT 3 M

NO.	FREQ. (MHz)	EMISSION LEVEL (dBuV/m)	LIMIT (dBuV/m)	MARGIN (dB)	ANTENNA HEIGHT (m)	TABLE ANGLE (Degree)	RAW VALUE (dBuV)	CORRECTION FACTOR (dB/m)
1	*5320.00	109.9 PK			1.00 V	299	106.47	3.43
2	*5320.00	100.5 AV			1.00 V	299	97.07	3.43
3	5350.00	67.7 PK	74.0	-6.3	1.00 V	299	64.19	3.51
4	5350.00	52.4 AV	54.0	-1.6	1.00 V	299	48.89	3.51

REMARKS:

1. Emission Level(dBuV/m) = Raw Value(dBuV) + Correction Factor(dB/m)
2. Correction Factor(dB/m) = Antenna Factor(dB/m) + Cable Factor(dB) – Pre-Amplifier Factor(dB)
3. The other emission levels were very low against the limit.
4. Margin value = Emission Level – Limit value
5. " * ": Fundamental frequency.

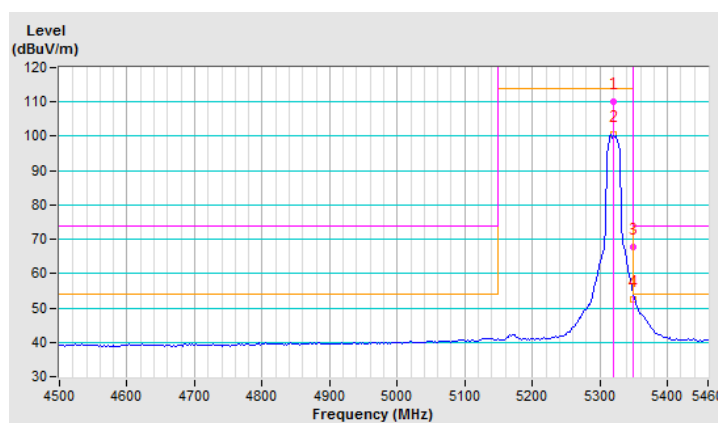

CHANNEL	TX Channel 100	DETECTOR FUNCTION	Peak (PK)
FREQUENCY RANGE	1GHz ~ 40GHz		Average (AV)

ANTENNA POLARITY & TEST DISTANCE: HORIZONTAL AT 3 M

NO.	FREQ. (MHz)	EMISSION LEVEL (dBuV/m)	LIMIT (dBuV/m)	MARGIN (dB)	ANTENNA HEIGHT (m)	TABLE ANGLE (Degree)	RAW VALUE (dBuV)	CORRECTION FACTOR (dB/m)
1	#5470.00	71.6 PK	74.0	-2.4	1.23 H	275	67.84	3.76
2	#5470.00	53.5 AV	54.0	-0.5	1.23 H	275	49.74	3.76
3	*5500.00	109.7 PK			1.23 H	275	105.91	3.79
4	*5500.00	100.5 AV			1.23 H	275	96.71	3.79

REMARKS:

1. Emission Level(dBuV/m) = Raw Value(dBuV) + Correction Factor(dB/m)
2. Correction Factor(dB/m) = Antenna Factor(dB/m) + Cable Factor(dB) – Pre-Amplifier Factor(dB)
3. The other emission levels were very low against the limit.
4. Margin value = Emission Level – Limit value
5. " * ": Fundamental frequency.
6. " # ": The radiated frequency is out of the restricted band.

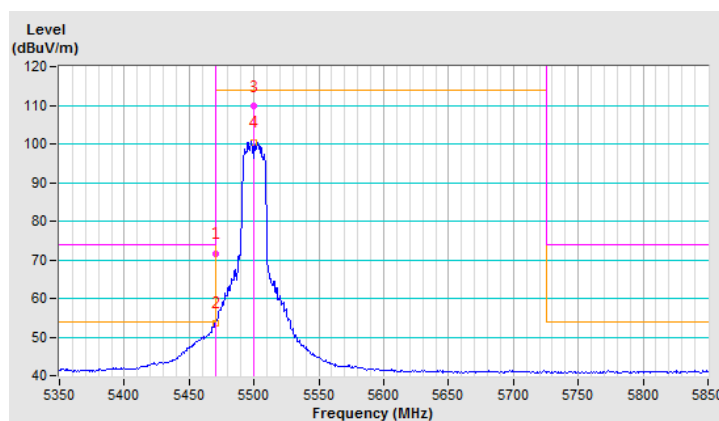

CHANNEL	TX Channel 100	DETECTOR FUNCTION	Peak (PK)
FREQUENCY RANGE	1GHz ~ 40GHz		Average (AV)

ANTENNA POLARITY & TEST DISTANCE: VERTICAL AT 3 M

NO.	FREQ. (MHz)	EMISSION LEVEL (dBuV/m)	LIMIT (dBuV/m)	MARGIN (dB)	ANTENNA HEIGHT (m)	TABLE ANGLE (Degree)	RAW VALUE (dBuV)	CORRECTION FACTOR (dB/m)
1	#5470.00	70.5 PK	74.0	-3.5	1.00 V	307	66.74	3.76
2	#5470.00	53.9 AV	54.0	-0.1	1.00 V	307	50.14	3.76
3	*5500.00	108.0 PK			1.00 V	307	104.21	3.79
4	*5500.00	99.3 AV			1.00 V	307	95.51	3.79

REMARKS:

1. Emission Level(dBuV/m) = Raw Value(dBuV) + Correction Factor(dB/m)
2. Correction Factor(dB/m) = Antenna Factor(dB/m) + Cable Factor(dB) – Pre-Amplifier Factor(dB)
3. The other emission levels were very low against the limit.
4. Margin value = Emission Level – Limit value
5. " * " : Fundamental frequency.
6. " # " : The radiated frequency is out of the restricted band.

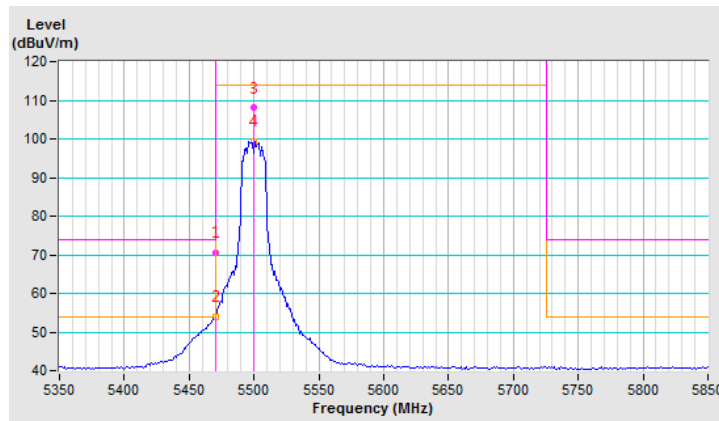

CHANNEL	TX Channel 116	DETECTOR FUNCTION	Peak (PK)
FREQUENCY RANGE	1GHz ~ 40GHz		Average (AV)

ANTENNA POLARITY & TEST DISTANCE: HORIZONTAL AT 3 M

NO.	FREQ. (MHz)	EMISSION LEVEL (dBuV/m)	LIMIT (dBuV/m)	MARGIN (dB)	ANTENNA HEIGHT (m)	TABLE ANGLE (Degree)	RAW VALUE (dBuV)	CORRECTION FACTOR (dB/m)
1	5373.00	55.4 PK	74.0	-18.6	1.23 H	276	51.81	3.59
2	5373.00	45.8 AV	54.0	-8.2	1.23 H	276	42.21	3.59
3	*5580.00	112.1 PK			1.23 H	276	108.19	3.91
4	*5580.00	102.7 AV			1.23 H	276	98.79	3.91
5	#5725.00	52.3 PK	74.0	-21.7	1.23 H	276	48.11	4.19
6	#5725.00	40.8 AV	54.0	-13.2	1.23 H	276	36.61	4.19

REMARKS:

1. Emission Level(dBuV/m) = Raw Value(dBuV) + Correction Factor(dB/m)
2. Correction Factor(dB/m) = Antenna Factor(dB/m) + Cable Factor(dB) – Pre-Amplifier Factor(dB)
3. The other emission levels were very low against the limit.
4. Margin value = Emission Level – Limit value
5. " * ": Fundamental frequency.
6. " # ": The radiated frequency is out of the restricted band.

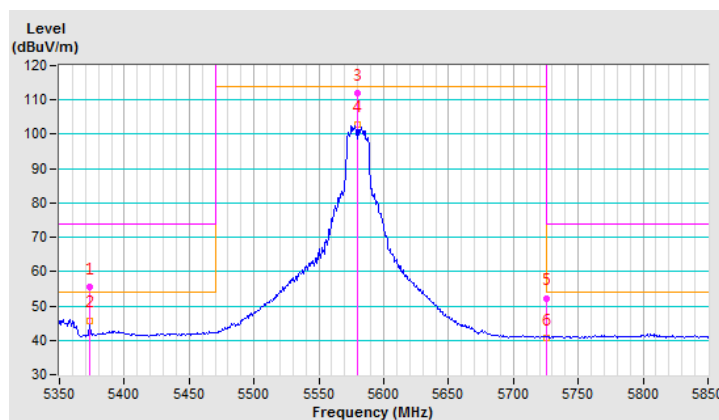

CHANNEL	TX Channel 116	DETECTOR FUNCTION	Peak (PK)
FREQUENCY RANGE	1GHz ~ 40GHz		Average (AV)

ANTENNA POLARITY & TEST DISTANCE: VERTICAL AT 3 M

NO.	FREQ. (MHz)	EMISSION LEVEL (dBuV/m)	LIMIT (dBuV/m)	MARGIN (dB)	ANTENNA HEIGHT (m)	TABLE ANGLE (Degree)	RAW VALUE (dBuV)	CORRECTION FACTOR (dB/m)
1	5373.00	54.1 PK	74.0	-19.9	1.00 V	309	50.51	3.59
2	5373.00	45.0 AV	54.0	-9.0	1.00 V	309	41.41	3.59
3	*5580.00	109.9 PK			1.00 V	309	105.99	3.91
4	*5580.00	101.5 AV			1.00 V	309	97.59	3.91
5	#5725.00	51.9 PK	74.0	-22.1	1.00 V	309	47.71	4.19
6	#5725.00	40.9 AV	54.0	-13.1	1.00 V	309	36.71	4.19

REMARKS:

1. Emission Level(dBuV/m) = Raw Value(dBuV) + Correction Factor(dB/m)
2. Correction Factor(dB/m) = Antenna Factor(dB/m) + Cable Factor(dB) – Pre-Amplifier Factor(dB)
3. The other emission levels were very low against the limit.
4. Margin value = Emission Level – Limit value
5. " * ": Fundamental frequency.
6. " # ": The radiated frequency is out of the restricted band.

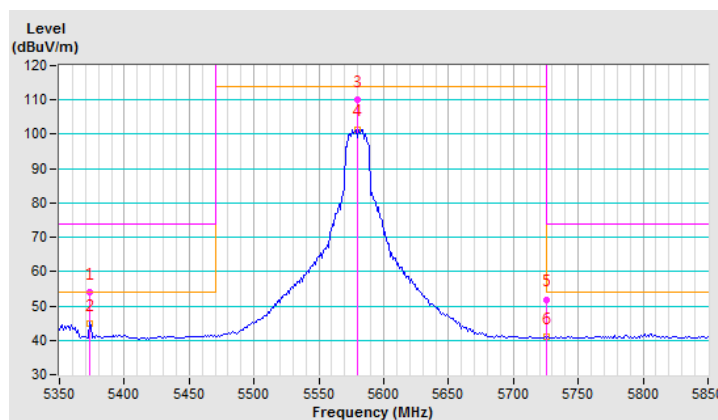

CHANNEL	TX Channel 140	DETECTOR FUNCTION	Peak (PK)
FREQUENCY RANGE	1GHz ~ 40GHz		Average (AV)

ANTENNA POLARITY & TEST DISTANCE: HORIZONTAL AT 3 M

NO.	FREQ. (MHz)	EMISSION LEVEL (dBuV/m)	LIMIT (dBuV/m)	MARGIN (dB)	ANTENNA HEIGHT (m)	TABLE ANGLE (Degree)	RAW VALUE (dBuV)	CORRECTION FACTOR (dB/m)
1	*5700.00	103.7 PK			1.00 H	280	99.51	4.19
2	*5700.00	94.9 AV			1.00 H	280	90.71	4.19
3	#5725.00	66.9 PK	74.0	-7.1	1.00 H	280	62.71	4.19
4	#5725.00	52.4 AV	54.0	-1.6	1.00 H	280	48.21	4.19

REMARKS:

1. Emission Level(dBuV/m) = Raw Value(dBuV) + Correction Factor(dB/m)
2. Correction Factor(dB/m) = Antenna Factor(dB/m) + Cable Factor(dB) – Pre-Amplifier Factor(dB)
3. The other emission levels were very low against the limit.
4. Margin value = Emission Level – Limit value
5. " * ": Fundamental frequency.
6. " # ": The radiated frequency is out of the restricted band.

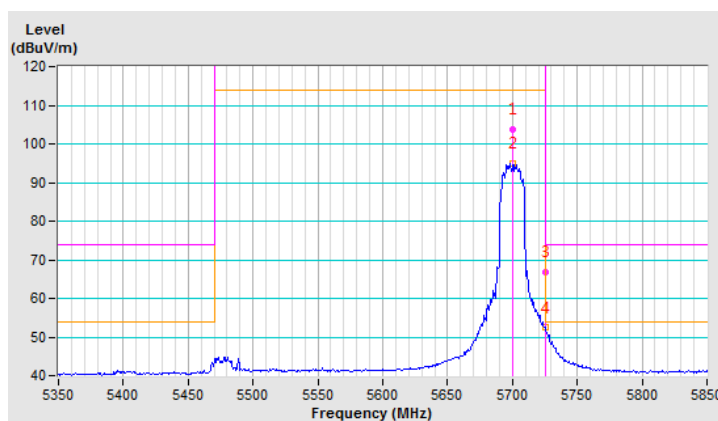

CHANNEL	TX Channel 140	DETECTOR FUNCTION	Peak (PK)
FREQUENCY RANGE	1GHz ~ 40GHz		Average (AV)

ANTENNA POLARITY & TEST DISTANCE: VERTICAL AT 3 M

NO.	FREQ. (MHz)	EMISSION LEVEL (dBuV/m)	LIMIT (dBuV/m)	MARGIN (dB)	ANTENNA HEIGHT (m)	TABLE ANGLE (Degree)	RAW VALUE (dBuV)	CORRECTION FACTOR (dB/m)
1	*5700.00	105.8 PK			1.01 V	310	101.61	4.19
2	*5700.00	95.8 AV			1.01 V	310	91.61	4.19
3	#5725.00	68.0 PK	74.0	-6.0	1.01 V	310	63.81	4.19
4	#5725.00	53.6 AV	54.0	-0.4	1.01 V	310	49.41	4.19

REMARKS:

1. Emission Level(dBuV/m) = Raw Value(dBuV) + Correction Factor(dB/m)
2. Correction Factor(dB/m) = Antenna Factor(dB/m) + Cable Factor(dB) – Pre-Amplifier Factor(dB)
3. The other emission levels were very low against the limit.
4. Margin value = Emission Level – Limit value
5. " * ": Fundamental frequency.
6. " # ": The radiated frequency is out of the restricted band.

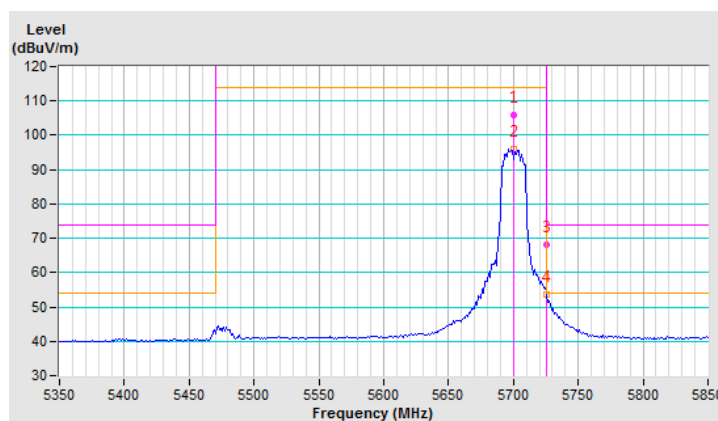

CHANNEL	TX Channel 149	DETECTOR FUNCTION	Peak (PK)
FREQUENCY RANGE	1GHz ~ 40GHz		Average (AV)

ANTENNA POLARITY & TEST DISTANCE: HORIZONTAL AT 3 M

NO.	FREQ. (MHz)	EMISSION LEVEL (dBuV/m)	LIMIT (dBuV/m)	MARGIN (dB)	ANTENNA HEIGHT (m)	TABLE ANGLE (Degree)	RAW VALUE (dBuV)	CORRECTION FACTOR (dB/m)
1	#5715.00	65.9 PK	74.0	-8.1	1.02 H	280	61.71	4.19
2	#5715.00	49.8 AV	54.0	-4.2	1.02 H	280	45.61	4.19
3	#5725.00	74.2 PK	78.2	-4.0	1.02 H	280	70.01	4.19
4	*5745.00	103.5 PK			1.02 H	280	99.31	4.19
5	*5745.00	94.4 AV			1.02 H	280	90.21	4.19

REMARKS:

1. Emission Level(dBuV/m) = Raw Value(dBuV) + Correction Factor(dB/m)
2. Correction Factor(dB/m) = Antenna Factor(dB/m) + Cable Factor(dB) – Pre-Amplifier Factor(dB)
3. The other emission levels were very low against the limit.
4. Margin value = Emission Level – Limit value
5. " * ": Fundamental frequency.
6. " # ": The radiated frequency is out of the restricted band.

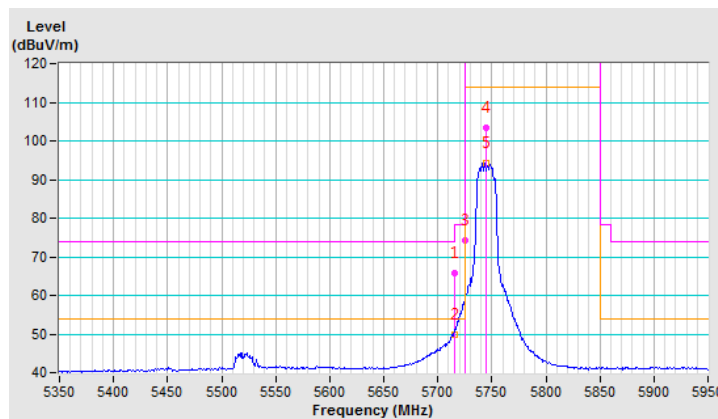

CHANNEL	TX Channel 149	DETECTOR FUNCTION	Peak (PK)
FREQUENCY RANGE	1GHz ~ 40GHz		Average (AV)

ANTENNA POLARITY & TEST DISTANCE: VERTICAL AT 3 M

NO.	FREQ. (MHz)	EMISSION LEVEL (dBuV/m)	LIMIT (dBuV/m)	MARGIN (dB)	ANTENNA HEIGHT (m)	TABLE ANGLE (Degree)	RAW VALUE (dBuV)	CORRECTION FACTOR (dB/m)
1	#5715.00	71.2 PK	74.0	-2.8	1.00 V	336	67.01	4.19
2	#5715.00	53.1 AV	54.0	-0.9	1.00 V	336	48.91	4.19
3	#5725.00	77.5 PK	78.2	-0.7	1.00 V	336	73.31	4.19
4	*5745.00	105.9 PK			1.00 V	336	101.71	4.19
5	*5745.00	97.1 AV			1.00 V	336	92.91	4.19

REMARKS:

1. Emission Level(dBuV/m) = Raw Value(dBuV) + Correction Factor(dB/m)
2. Correction Factor(dB/m) = Antenna Factor(dB/m) + Cable Factor(dB) – Pre-Amplifier Factor(dB)
3. The other emission levels were very low against the limit.
4. Margin value = Emission Level – Limit value
5. " * ": Fundamental frequency.
6. " # ": The radiated frequency is out of the restricted band.

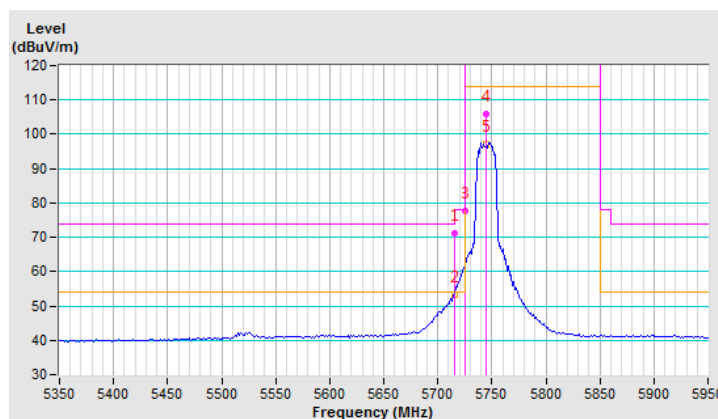

CHANNEL	TX Channel 157	DETECTOR FUNCTION	Peak (PK)
FREQUENCY RANGE	1GHz ~ 40GHz		Average (AV)

ANTENNA POLARITY & TEST DISTANCE: HORIZONTAL AT 3 M

NO.	FREQ. (MHz)	EMISSION LEVEL (dBuV/m)	LIMIT (dBuV/m)	MARGIN (dB)	ANTENNA HEIGHT (m)	TABLE ANGLE (Degree)	RAW VALUE (dBuV)	CORRECTION FACTOR (dB/m)
1	#5715.00	62.9 PK	74.0	-11.1	1.00 H	281	58.71	4.19
2	#5715.00	46.0 AV	54.0	-8.0	1.00 H	281	41.81	4.19
3	#5725.00	63.8 PK	78.2	-14.4	1.00 H	281	59.61	4.19
4	*5785.00	106.5 PK			1.00 H	281	102.32	4.18
5	*5785.00	97.4 AV			1.00 H	281	93.22	4.18
6	#5850.00	60.9 PK	78.2	-17.3	1.00 H	281	56.65	4.25
7	#5860.00	59.1 PK	74.0	-14.9	1.00 H	281	54.84	4.26
8	#5860.00	43.4 AV	54.0	-10.6	1.00 H	281	39.14	4.26

REMARKS:

1. Emission Level(dBuV/m) = Raw Value(dBuV) + Correction Factor(dB/m)
2. Correction Factor(dB/m) = Antenna Factor(dB/m) + Cable Factor(dB) – Pre-Amplifier Factor(dB)
3. The other emission levels were very low against the limit.
4. Margin value = Emission Level – Limit value
5. " * ": Fundamental frequency.
6. " # ": The radiated frequency is out of the restricted band.

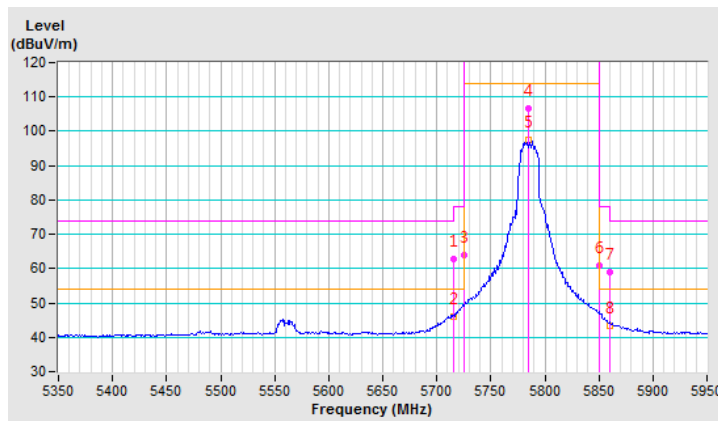

CHANNEL	TX Channel 157	DETECTOR FUNCTION	Peak (PK)
FREQUENCY RANGE	1GHz ~ 40GHz		Average (AV)

ANTENNA POLARITY & TEST DISTANCE: VERTICAL AT 3 M

NO.	FREQ. (MHz)	EMISSION LEVEL (dBuV/m)	LIMIT (dBuV/m)	MARGIN (dB)	ANTENNA HEIGHT (m)	TABLE ANGLE (Degree)	RAW VALUE (dBuV)	CORRECTION FACTOR (dB/m)
1	#5715.00	66.3 PK	74.0	-7.7	1.00 V	334	62.11	4.19
2	#5715.00	48.6 AV	54.0	-5.4	1.00 V	334	44.41	4.19
3	#5725.00	67.4 PK	78.2	-10.8	1.00 V	334	63.21	4.19
4	*5785.00	110.5 PK			1.00 V	334	106.32	4.18
5	*5785.00	101.0 AV			1.00 V	334	96.82	4.18
6	#5850.00	66.8 PK	78.2	-11.4	1.00 V	334	62.55	4.25
7	#5860.00	64.6 PK	74.0	-9.4	1.00 V	334	60.34	4.26
8	#5860.00	47.3 AV	54.0	-6.7	1.00 V	334	43.04	4.26

REMARKS:

1. Emission Level(dBuV/m) = Raw Value(dBuV) + Correction Factor(dB/m)
2. Correction Factor(dB/m) = Antenna Factor(dB/m) + Cable Factor(dB) – Pre-Amplifier Factor(dB)
3. The other emission levels were very low against the limit.
4. Margin value = Emission Level – Limit value
5. " * ": Fundamental frequency.
6. " # ": The radiated frequency is out of the restricted band.

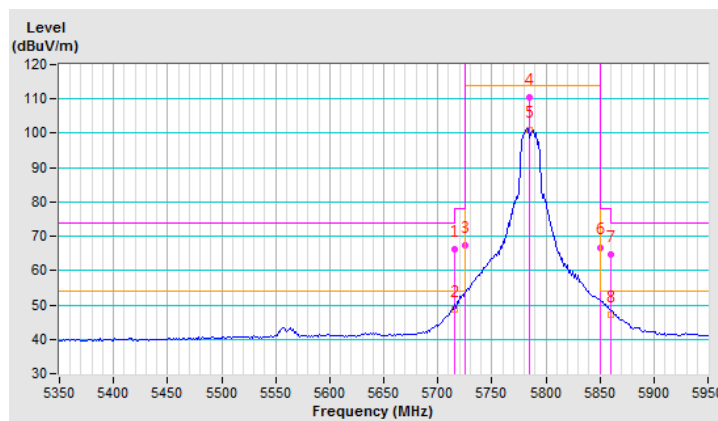

CHANNEL	TX Channel 165	DETECTOR FUNCTION	Peak (PK)
FREQUENCY RANGE	1GHz ~ 40GHz		Average (AV)

ANTENNA POLARITY & TEST DISTANCE: HORIZONTAL AT 3 M

NO.	FREQ. (MHz)	EMISSION LEVEL (dBuV/m)	LIMIT (dBuV/m)	MARGIN (dB)	ANTENNA HEIGHT (m)	TABLE ANGLE (Degree)	RAW VALUE (dBuV)	CORRECTION FACTOR (dB/m)
1	*5825.00	103.6 PK			1.00 H	247	99.38	4.22
2	*5825.00	94.2 AV			1.00 H	247	89.98	4.22
3	#5850.00	70.6 PK	78.2	-7.6	1.00 H	247	66.35	4.25
4	#5860.00	65.2 PK	74.0	-8.8	1.00 H	247	60.94	4.26
5	#5860.00	49.6 AV	54.0	-4.4	1.00 H	247	45.34	4.26

REMARKS:

1. Emission Level(dBuV/m) = Raw Value(dBuV) + Correction Factor(dB/m)
2. Correction Factor(dB/m) = Antenna Factor(dB/m) + Cable Factor(dB) – Pre-Amplifier Factor(dB)
3. The other emission levels were very low against the limit.
4. Margin value = Emission Level – Limit value
5. " * ": Fundamental frequency.
6. " # ": The radiated frequency is out of the restricted band.

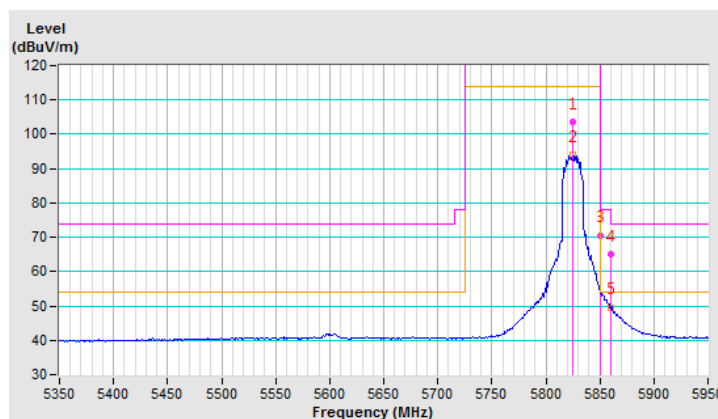

CHANNEL	TX Channel 165	DETECTOR FUNCTION	Peak (PK)
FREQUENCY RANGE	1GHz ~ 40GHz		Average (AV)

ANTENNA POLARITY & TEST DISTANCE: VERTICAL AT 3 M

NO.	FREQ. (MHz)	EMISSION LEVEL (dBuV/m)	LIMIT (dBuV/m)	MARGIN (dB)	ANTENNA HEIGHT (m)	TABLE ANGLE (Degree)	RAW VALUE (dBuV)	CORRECTION FACTOR (dB/m)
1	*5825.00	108.1 PK			1.00 V	344	103.88	4.22
2	*5825.00	98.5 AV			1.00 V	344	94.28	4.22
3	#5850.00	75.2 PK	78.2	-3.0	1.00 V	344	70.95	4.25
4	#5860.00	67.9 PK	74.0	-6.1	1.00 V	344	63.64	4.26
5	#5860.00	53.3 AV	54.0	-0.7	1.00 V	344	49.04	4.26

REMARKS:

1. Emission Level(dBuV/m) = Raw Value(dBuV) + Correction Factor(dB/m)
2. Correction Factor(dB/m) = Antenna Factor(dB/m) + Cable Factor(dB) – Pre-Amplifier Factor(dB)
3. The other emission levels were very low against the limit.
4. Margin value = Emission Level – Limit value
5. " * ": Fundamental frequency.
6. " # ": The radiated frequency is out of the restricted band.

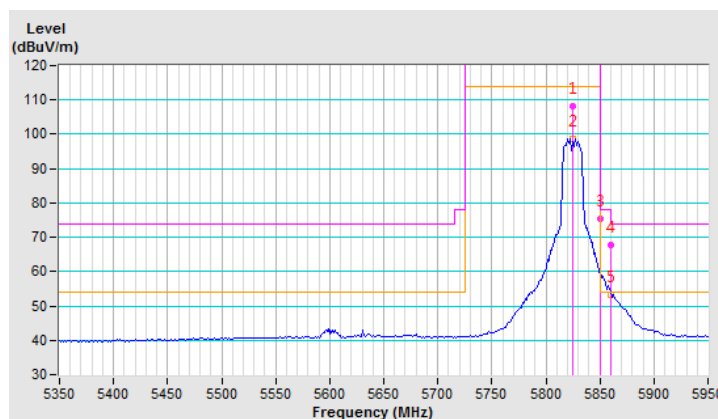

802.11n (40MHz)

CHANNEL	TX Channel 38	DETECTOR FUNCTION	Peak (PK)
FREQUENCY RANGE	1GHz ~ 40GHz		Average (AV)

ANTENNA POLARITY & TEST DISTANCE: HORIZONTAL AT 3 M								
NO.	FREQ. (MHz)	EMISSION LEVEL (dBuV/m)	LIMIT (dBuV/m)	MARGIN (dB)	ANTENNA HEIGHT (m)	TABLE ANGLE (Degree)	RAW VALUE (dBuV)	CORRECTION FACTOR (dB/m)
1	5150.00	59.1 PK	74.0	-14.9	1.00 H	302	56.12	2.98
2	5150.00	48.2 AV	54.0	-5.8	1.00 H	302	45.22	2.98
3	*5190.00	101.7 PK			1.00 H	302	98.63	3.07
4	*5190.00	91.8 AV			1.00 H	302	88.73	3.07
5	5350.00	51.5 PK	74.0	-22.5	1.00 H	302	47.99	3.51
6	5350.00	41.3 AV	54.0	-12.7	1.00 H	302	37.79	3.51

REMARKS:

1. Emission Level(dBuV/m) = Raw Value(dBuV) + Correction Factor(dB/m)
2. Correction Factor(dB/m) = Antenna Factor(dB/m) + Cable Factor(dB) – Pre-Amplifier Factor(dB)
3. The other emission levels were very low against the limit.
4. Margin value = Emission Level – Limit value
5. " * ": Fundamental frequency.

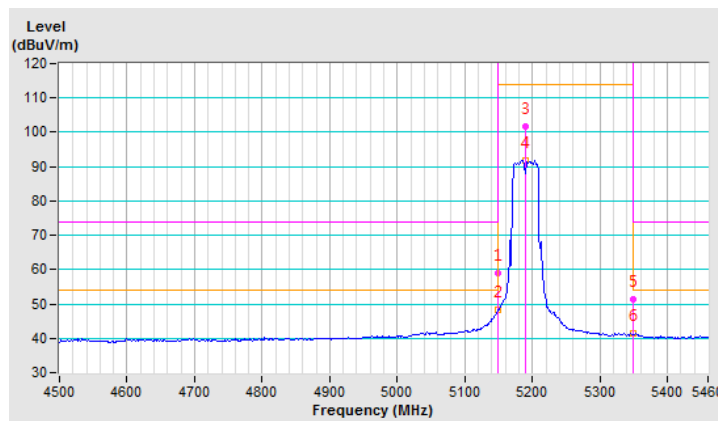

CHANNEL	TX Channel 38	DETECTOR FUNCTION	Peak (PK)
FREQUENCY RANGE	1GHz ~ 40GHz		Average (AV)

ANTENNA POLARITY & TEST DISTANCE: VERTICAL AT 3 M

NO.	FREQ. (MHz)	EMISSION LEVEL (dBuV/m)	LIMIT (dBuV/m)	MARGIN (dB)	ANTENNA HEIGHT (m)	TABLE ANGLE (Degree)	RAW VALUE (dBuV)	CORRECTION FACTOR (dB/m)
1	5150.00	64.9 PK	74.0	-9.1	1.00 V	282	61.92	2.98
2	5150.00	51.9 AV	54.0	-2.1	1.00 V	282	48.92	2.98
3	*5190.00	101.9 PK			1.00 V	282	98.83	3.07
4	*5190.00	92.9 AV			1.00 V	282	89.83	3.07
5	5350.00	51.2 PK	74.0	-22.8	1.00 V	282	47.69	3.51
6	5350.00	40.5 AV	54.0	-13.5	1.00 V	282	36.99	3.51

REMARKS:

1. Emission Level(dBuV/m) = Raw Value(dBuV) + Correction Factor(dB/m)
2. Correction Factor(dB/m) = Antenna Factor(dB/m) + Cable Factor(dB) – Pre-Amplifier Factor(dB)
3. The other emission levels were very low against the limit.
4. Margin value = Emission Level – Limit value
5. " * ": Fundamental frequency.

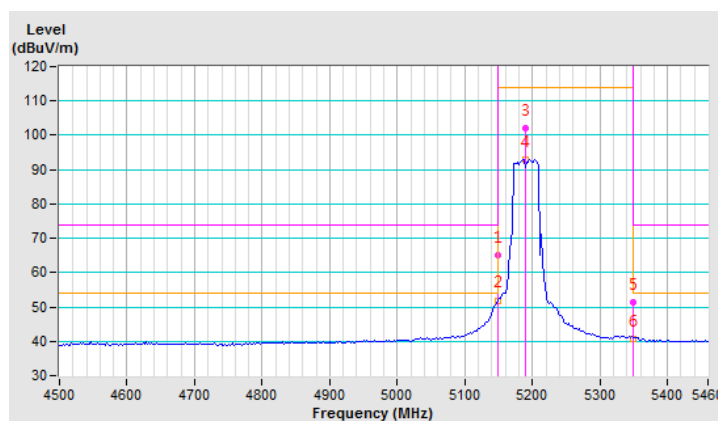

CHANNEL	TX Channel 46	DETECTOR FUNCTION	Peak (PK)
FREQUENCY RANGE	1GHz ~ 40GHz		Average (AV)

ANTENNA POLARITY & TEST DISTANCE: HORIZONTAL AT 3 M

NO.	FREQ. (MHz)	EMISSION LEVEL (dBuV/m)	LIMIT (dBuV/m)	MARGIN (dB)	ANTENNA HEIGHT (m)	TABLE ANGLE (Degree)	RAW VALUE (dBuV)	CORRECTION FACTOR (dB/m)
1	5150.00	62.2 PK	74.0	-11.8	1.00 H	298	59.22	2.98
2	5150.00	51.7 AV	54.0	-2.3	1.00 H	298	48.72	2.98
3	*5230.00	106.1 PK			1.00 H	298	102.92	3.18
4	*5230.00	97.0 AV			1.00 H	298	93.82	3.18
5	5350.00	54.2 PK	74.0	-19.8	1.00 H	298	50.69	3.51
6	5350.00	42.9 AV	54.0	-11.1	1.00 H	298	39.39	3.51

REMARKS:

1. Emission Level(dBuV/m) = Raw Value(dBuV) + Correction Factor(dB/m)
2. Correction Factor(dB/m) = Antenna Factor(dB/m) + Cable Factor(dB) – Pre-Amplifier Factor(dB)
3. The other emission levels were very low against the limit.
4. Margin value = Emission Level – Limit value
5. " * ": Fundamental frequency.

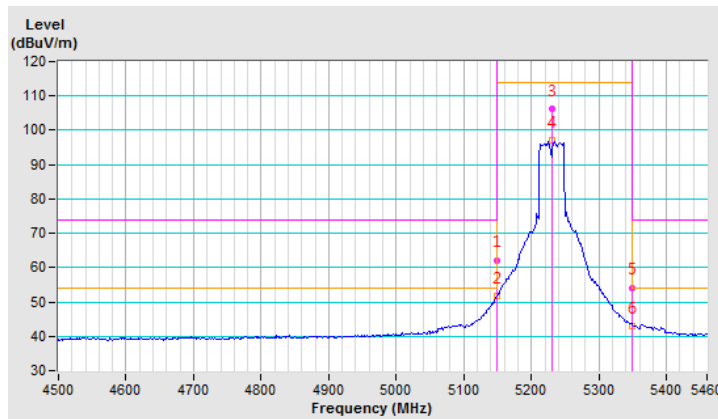

CHANNEL	TX Channel 46	DETECTOR FUNCTION	Peak (PK)
FREQUENCY RANGE	1GHz ~ 40GHz		Average (AV)

ANTENNA POLARITY & TEST DISTANCE: VERTICAL AT 3 M

NO.	FREQ. (MHz)	EMISSION LEVEL (dBuV/m)	LIMIT (dBuV/m)	MARGIN (dB)	ANTENNA HEIGHT (m)	TABLE ANGLE (Degree)	RAW VALUE (dBuV)	CORRECTION FACTOR (dB/m)
1	5150.00	68.0 PK	74.0	-6.0	1.35 V	275	65.02	2.98
2	5150.00	53.4 AV	54.0	-0.6	1.35 V	275	50.42	2.98
3	*5230.00	106.8 PK			1.35 V	275	103.62	3.18
4	*5230.00	97.8 AV			1.35 V	275	94.62	3.18
5	5350.00	56.0 PK	74.0	-18.0	1.35 V	275	52.49	3.51
6	5350.00	44.0 AV	54.0	-10.0	1.35 V	275	40.49	3.51

REMARKS:

1. Emission Level(dBuV/m) = Raw Value(dBuV) + Correction Factor(dB/m)
2. Correction Factor(dB/m) = Antenna Factor(dB/m) + Cable Factor(dB) – Pre-Amplifier Factor(dB)
3. The other emission levels were very low against the limit.
4. Margin value = Emission Level – Limit value
5. " * ": Fundamental frequency.

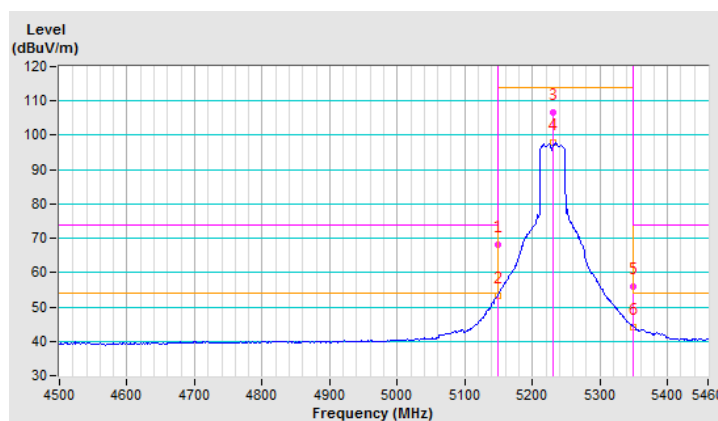

CHANNEL	TX Channel 54	DETECTOR FUNCTION	Peak (PK)
FREQUENCY RANGE	1GHz ~ 40GHz		Average (AV)

ANTENNA POLARITY & TEST DISTANCE: HORIZONTAL AT 3 M

NO.	FREQ. (MHz)	EMISSION LEVEL (dBuV/m)	LIMIT (dBuV/m)	MARGIN (dB)	ANTENNA HEIGHT (m)	TABLE ANGLE (Degree)	RAW VALUE (dBuV)	CORRECTION FACTOR (dB/m)
1	5150.00	54.6 PK	74.0	-19.4	1.00 H	298	51.62	2.98
2	5150.00	43.2 AV	54.0	-10.8	1.00 H	298	40.22	2.98
3	*5270.00	107.1 PK			1.00 H	298	103.81	3.29
4	*5270.00	97.5 AV			1.00 H	298	94.21	3.29
5	5350.00	62.6 PK	74.0	-11.4	1.00 H	298	59.09	3.51
6	5350.00	50.6 AV	54.0	-3.4	1.00 H	298	47.09	3.51

REMARKS:

1. Emission Level(dBuV/m) = Raw Value(dBuV) + Correction Factor(dB/m)
2. Correction Factor(dB/m) = Antenna Factor(dB/m) + Cable Factor(dB) – Pre-Amplifier Factor(dB)
3. The other emission levels were very low against the limit.
4. Margin value = Emission Level – Limit value
5. " * ": Fundamental frequency.

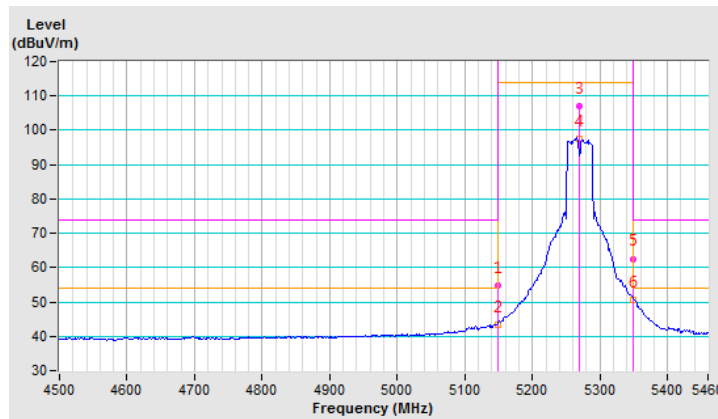

CHANNEL	TX Channel 54	DETECTOR FUNCTION	Peak (PK)
FREQUENCY RANGE	1GHz ~ 40GHz		Average (AV)

ANTENNA POLARITY & TEST DISTANCE: VERTICAL AT 3 M

NO.	FREQ. (MHz)	EMISSION LEVEL (dBuV/m)	LIMIT (dBuV/m)	MARGIN (dB)	ANTENNA HEIGHT (m)	TABLE ANGLE (Degree)	RAW VALUE (dBuV)	CORRECTION FACTOR (dB/m)
1	5150.00	56.1 PK	74.0	-17.9	1.00 V	295	53.12	2.98
2	5150.00	43.7 AV	54.0	-10.3	1.00 V	295	40.72	2.98
3	*5270.00	108.8 PK			1.00 V	295	105.51	3.29
4	*5270.00	99.3 AV			1.00 V	295	96.01	3.29
5	5350.00	66.1 PK	74.0	-7.9	1.00 V	295	62.59	3.51
6	5350.00	53.5 AV	54.0	-0.5	1.00 V	295	49.99	3.51

REMARKS:

1. Emission Level(dBuV/m) = Raw Value(dBuV) + Correction Factor(dB/m)
2. Correction Factor(dB/m) = Antenna Factor(dB/m) + Cable Factor(dB) – Pre-Amplifier Factor(dB)
3. The other emission levels were very low against the limit.
4. Margin value = Emission Level – Limit value
5. " * ": Fundamental frequency.

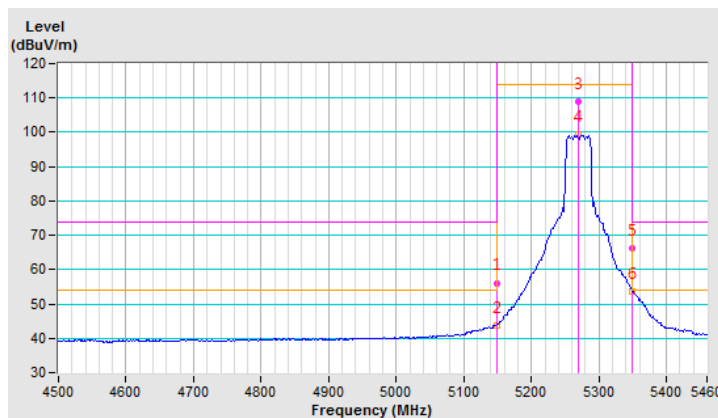

CHANNEL	TX Channel 62	DETECTOR FUNCTION	Peak (PK)
FREQUENCY RANGE	1GHz ~ 40GHz		Average (AV)

ANTENNA POLARITY & TEST DISTANCE: HORIZONTAL AT 3 M

NO.	FREQ. (MHz)	EMISSION LEVEL (dBuV/m)	LIMIT (dBuV/m)	MARGIN (dB)	ANTENNA HEIGHT (m)	TABLE ANGLE (Degree)	RAW VALUE (dBuV)	CORRECTION FACTOR (dB/m)
1	*5310.00	103.8 PK			1.00 H	299	100.40	3.40
2	*5310.00	94.4 AV			1.00 H	299	91.00	3.40
3	5350.00	67.2 PK	74.0	-6.8	1.00 H	299	63.69	3.51
4	5350.00	51.7 AV	54.0	-2.3	1.00 H	299	48.19	3.51

REMARKS:

1. Emission Level(dBuV/m) = Raw Value(dBuV) + Correction Factor(dB/m)
2. Correction Factor(dB/m) = Antenna Factor(dB/m) + Cable Factor(dB) – Pre-Amplifier Factor(dB)
3. The other emission levels were very low against the limit.
4. Margin value = Emission Level – Limit value
5. " * ": Fundamental frequency.

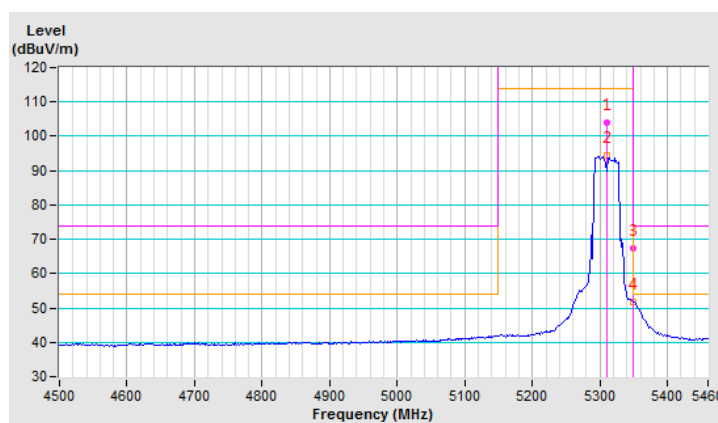

CHANNEL	TX Channel 62	DETECTOR FUNCTION	Peak (PK)
FREQUENCY RANGE	1GHz ~ 40GHz		Average (AV)

ANTENNA POLARITY & TEST DISTANCE: VERTICAL AT 3 M

NO.	FREQ. (MHz)	EMISSION LEVEL (dBuV/m)	LIMIT (dBuV/m)	MARGIN (dB)	ANTENNA HEIGHT (m)	TABLE ANGLE (Degree)	RAW VALUE (dBuV)	CORRECTION FACTOR (dB/m)
1	*5310.00	104.4 PK			1.00 V	296	101.00	3.40
2	*5310.00	95.5 AV			1.00 V	296	92.10	3.40
3	5350.00	70.1 PK	74.0	-3.9	1.00 V	296	66.59	3.51
4	5350.00	53.3 AV	54.0	-0.7	1.00 V	296	49.79	3.51

REMARKS:

1. Emission Level(dBuV/m) = Raw Value(dBuV) + Correction Factor(dB/m)
2. Correction Factor(dB/m) = Antenna Factor(dB/m) + Cable Factor(dB) – Pre-Amplifier Factor(dB)
3. The other emission levels were very low against the limit.
4. Margin value = Emission Level – Limit value
5. " * ": Fundamental frequency.

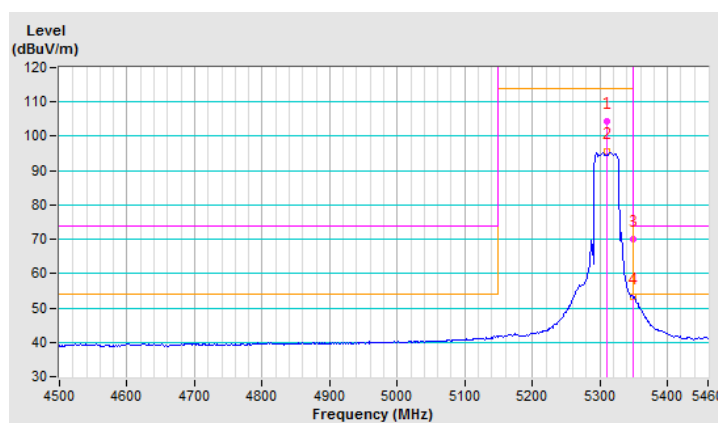

CHANNEL	TX Channel 102	DETECTOR FUNCTION	Peak (PK)
FREQUENCY RANGE	1GHz ~ 40GHz		Average (AV)

ANTENNA POLARITY & TEST DISTANCE: HORIZONTAL AT 3 M

NO.	FREQ. (MHz)	EMISSION LEVEL (dBuV/m)	LIMIT (dBuV/m)	MARGIN (dB)	ANTENNA HEIGHT (m)	TABLE ANGLE (Degree)	RAW VALUE (dBuV)	CORRECTION FACTOR (dB/m)
1	#5470.00	66.2 PK	74.0	-7.8	1.00 H	273	62.44	3.76
2	#5470.00	52.0 AV	54.0	-2.0	1.00 H	273	48.24	3.76
3	*5510.00	102.9 PK			1.00 H	273	99.09	3.81
4	*5510.00	93.5 AV			1.00 H	273	89.69	3.81

REMARKS:

1. Emission Level(dBuV/m) = Raw Value(dBuV) + Correction Factor(dB/m)
2. Correction Factor(dB/m) = Antenna Factor(dB/m) + Cable Factor(dB) – Pre-Amplifier Factor(dB)
3. The other emission levels were very low against the limit.
4. Margin value = Emission Level – Limit value
5. " * ": Fundamental frequency.
6. " # ": The radiated frequency is out of the restricted band.

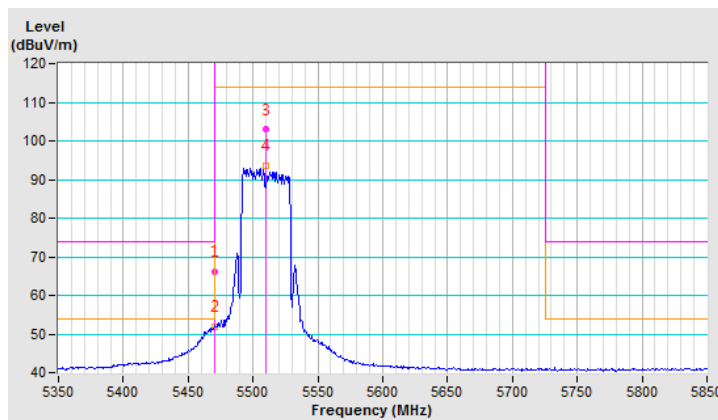

CHANNEL	TX Channel 102	DETECTOR FUNCTION	Peak (PK)
FREQUENCY RANGE	1GHz ~ 40GHz		Average (AV)

ANTENNA POLARITY & TEST DISTANCE: VERTICAL AT 3 M

NO.	FREQ. (MHz)	EMISSION LEVEL (dBuV/m)	LIMIT (dBuV/m)	MARGIN (dB)	ANTENNA HEIGHT (m)	TABLE ANGLE (Degree)	RAW VALUE (dBuV)	CORRECTION FACTOR (dB/m)
1	#5470.00	68.8 PK	74.0	-5.2	1.00 V	306	65.04	3.76
2	#5470.00	53.8 AV	54.0	-0.2	1.00 V	306	50.04	3.76
3	*5510.00	102.7 PK			1.00 V	306	98.89	3.81
4	*5510.00	93.6 AV			1.00 V	306	89.79	3.81

REMARKS:

1. Emission Level(dBuV/m) = Raw Value(dBuV) + Correction Factor(dB/m)
2. Correction Factor(dB/m) = Antenna Factor(dB/m) + Cable Factor(dB) – Pre-Amplifier Factor(dB)
3. The other emission levels were very low against the limit.
4. Margin value = Emission Level – Limit value
5. " * ": Fundamental frequency.
6. " # ": The radiated frequency is out of the restricted band.

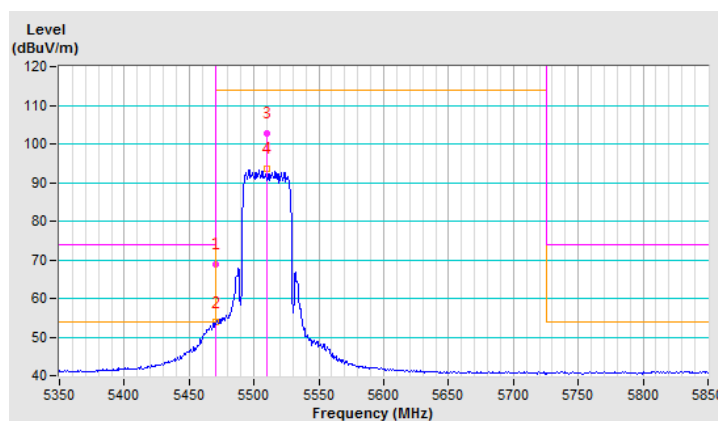

CHANNEL	TX Channel 110	DETECTOR FUNCTION	Peak (PK)
FREQUENCY RANGE	1GHz ~ 40GHz		Average (AV)

ANTENNA POLARITY & TEST DISTANCE: HORIZONTAL AT 3 M

NO.	FREQ. (MHz)	EMISSION LEVEL (dBuV/m)	LIMIT (dBuV/m)	MARGIN (dB)	ANTENNA HEIGHT (m)	TABLE ANGLE (Degree)	RAW VALUE (dBuV)	CORRECTION FACTOR (dB/m)
1	#5470.00	64.9 PK	74.0	-9.1	1.00 H	277	61.14	3.76
2	#5470.00	50.5 AV	54.0	-3.5	1.00 H	277	46.74	3.76
3	*5550.00	106.2 PK			1.00 H	277	102.34	3.86
4	*5550.00	96.9 AV			1.00 H	277	93.04	3.86
5	#5725.00	52.9 PK	74.0	-21.1	1.00 H	277	48.71	4.19
6	#5725.00	40.1 AV	54.0	-13.9	1.00 H	277	35.91	4.19

REMARKS:

1. Emission Level(dBuV/m) = Raw Value(dBuV) + Correction Factor(dB/m)
2. Correction Factor(dB/m) = Antenna Factor(dB/m) + Cable Factor(dB) – Pre-Amplifier Factor(dB)
3. The other emission levels were very low against the limit.
4. Margin value = Emission Level – Limit value
5. " * ": Fundamental frequency.
6. " # ": The radiated frequency is out of the restricted band.

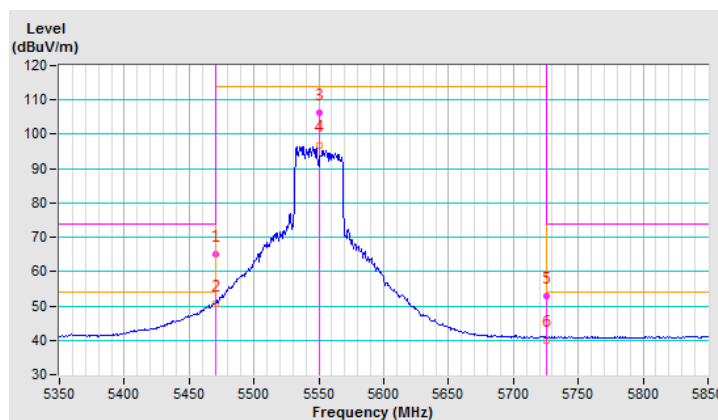

CHANNEL	TX Channel 110	DETECTOR FUNCTION	Peak (PK)
FREQUENCY RANGE	1GHz ~ 40GHz		Average (AV)

ANTENNA POLARITY & TEST DISTANCE: VERTICAL AT 3 M

NO.	FREQ. (MHz)	EMISSION LEVEL (dBuV/m)	LIMIT (dBuV/m)	MARGIN (dB)	ANTENNA HEIGHT (m)	TABLE ANGLE (Degree)	RAW VALUE (dBuV)	CORRECTION FACTOR (dB/m)
1	#5470.00	65.3 PK	74.0	-8.7	1.00 V	302	61.54	3.76
2	#5470.00	53.6 AV	54.0	-0.4	1.00 V	302	49.84	3.76
3	*5550.00	107.5 PK			1.00 V	302	103.64	3.86
4	*5550.00	96.5 AV			1.00 V	302	92.64	3.86
5	#5725.00	51.6 PK	74.0	-22.4	1.00 V	302	47.41	4.19
6	#5725.00	40.2 AV	54.0	-13.8	1.00 V	302	36.01	4.19

REMARKS:

1. Emission Level(dBuV/m) = Raw Value(dBuV) + Correction Factor(dB/m)
2. Correction Factor(dB/m) = Antenna Factor(dB/m) + Cable Factor(dB) – Pre-Amplifier Factor(dB)
3. The other emission levels were very low against the limit.
4. Margin value = Emission Level – Limit value
5. " * ": Fundamental frequency.
6. " # ": The radiated frequency is out of the restricted band.

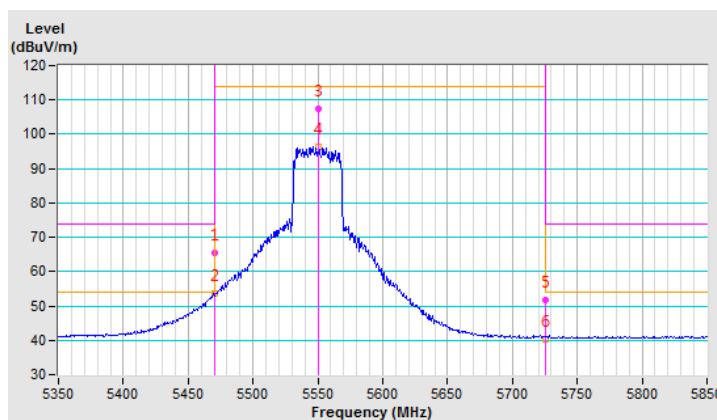

CHANNEL	TX Channel 134	DETECTOR FUNCTION	Peak (PK)
FREQUENCY RANGE	1GHz ~ 40GHz		Average (AV)

ANTENNA POLARITY & TEST DISTANCE: HORIZONTAL AT 3 M

NO.	FREQ. (MHz)	EMISSION LEVEL (dBuV/m)	LIMIT (dBuV/m)	MARGIN (dB)	ANTENNA HEIGHT (m)	TABLE ANGLE (Degree)	RAW VALUE (dBuV)	CORRECTION FACTOR (dB/m)
1	*5670.00	102.3 PK			1.37 H	279	98.19	4.11
2	*5670.00	92.6 AV			1.37 H	279	88.49	4.11
3	#5725.00	63.7 PK	74.0	-10.3	1.37 H	279	59.51	4.19
4	#5725.00	50.9 AV	54.0	-3.1	1.37 H	279	46.71	4.19

REMARKS:

1. Emission Level(dBuV/m) = Raw Value(dBuV) + Correction Factor(dB/m)
2. Correction Factor(dB/m) = Antenna Factor(dB/m) + Cable Factor(dB) – Pre-Amplifier Factor(dB)
3. The other emission levels were very low against the limit.
4. Margin value = Emission Level – Limit value
5. " * ": Fundamental frequency.
6. " # ": The radiated frequency is out of the restricted band.

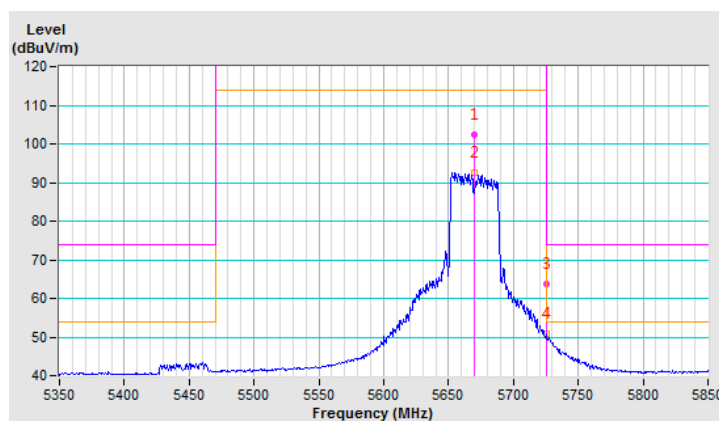

CHANNEL	TX Channel 134	DETECTOR FUNCTION	Peak (PK)
FREQUENCY RANGE	1GHz ~ 40GHz		Average (AV)

ANTENNA POLARITY & TEST DISTANCE: VERTICAL AT 3 M

NO.	FREQ. (MHz)	EMISSION LEVEL (dBuV/m)	LIMIT (dBuV/m)	MARGIN (dB)	ANTENNA HEIGHT (m)	TABLE ANGLE (Degree)	RAW VALUE (dBuV)	CORRECTION FACTOR (dB/m)
1	*5670.00	103.1 PK			1.00 V	316	98.99	4.11
2	*5670.00	93.8 AV			1.00 V	316	89.69	4.11
3	#5725.00	65.9 PK	74.0	-8.1	1.00 V	316	61.71	4.19
4	#5725.00	53.3 AV	54.0	-0.7	1.00 V	316	49.11	4.19

REMARKS:

1. Emission Level(dBuV/m) = Raw Value(dBuV) + Correction Factor(dB/m)
2. Correction Factor(dB/m) = Antenna Factor(dB/m) + Cable Factor(dB) – Pre-Amplifier Factor(dB)
3. The other emission levels were very low against the limit.
4. Margin value = Emission Level – Limit value
5. " * ": Fundamental frequency.
6. " # ": The radiated frequency is out of the restricted band.

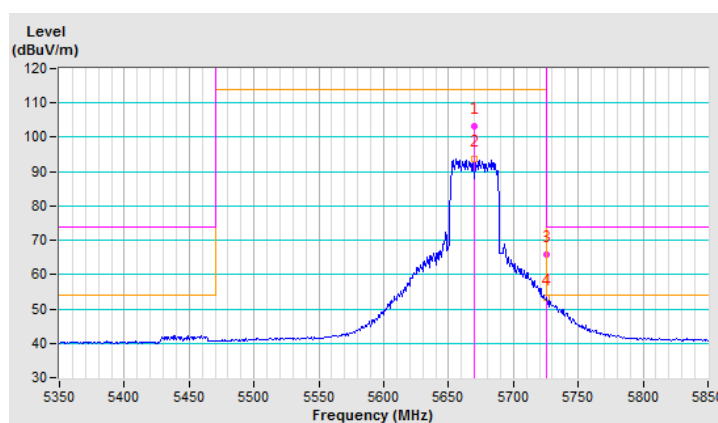

CHANNEL	TX Channel 151	DETECTOR FUNCTION	Peak (PK)
FREQUENCY RANGE	1GHz ~ 40GHz		Average (AV)

ANTENNA POLARITY & TEST DISTANCE: HORIZONTAL AT 3 M

NO.	FREQ. (MHz)	EMISSION LEVEL (dBuV/m)	LIMIT (dBuV/m)	MARGIN (dB)	ANTENNA HEIGHT (m)	TABLE ANGLE (Degree)	RAW VALUE (dBuV)	CORRECTION FACTOR (dB/m)
1	#5715.00	66.6 PK	74.0	-7.4	1.17 H	280	62.41	4.19
2	#5715.00	50.7 AV	54.0	-3.3	1.17 H	280	46.51	4.19
3	#5725.00	73.3 PK	78.2	-4.9	1.17 H	280	69.11	4.19
4	*5755.00	98.5 PK			1.17 H	280	94.32	4.18
5	*5755.00	88.3 AV			1.17 H	280	84.12	4.18

REMARKS:

1. Emission Level(dBuV/m) = Raw Value(dBuV) + Correction Factor(dB/m)
2. Correction Factor(dB/m) = Antenna Factor(dB/m) + Cable Factor(dB) – Pre-Amplifier Factor(dB)
3. The other emission levels were very low against the limit.
4. Margin value = Emission Level – Limit value
5. " * ": Fundamental frequency.
6. " # ": The radiated frequency is out of the restricted band.

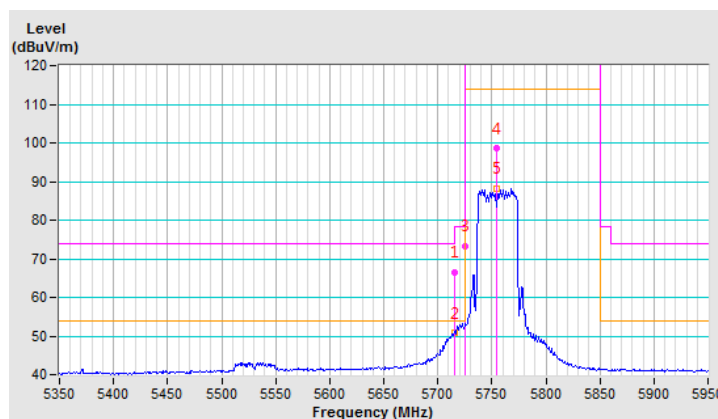

CHANNEL	TX Channel 151	DETECTOR FUNCTION	Peak (PK)
FREQUENCY RANGE	1GHz ~ 40GHz		Average (AV)

ANTENNA POLARITY & TEST DISTANCE: VERTICAL AT 3 M

NO.	FREQ. (MHz)	EMISSION LEVEL (dBuV/m)	LIMIT (dBuV/m)	MARGIN (dB)	ANTENNA HEIGHT (m)	TABLE ANGLE (Degree)	RAW VALUE (dBuV)	CORRECTION FACTOR (dB/m)
1	#5715.00	71.4 PK	74.0	-2.6	1.00 V	342	67.21	4.19
2	#5715.00	53.7 AV	54.0	-0.3	1.00 V	342	49.51	4.19
3	#5725.00	75.2 PK	78.2	-3.0	1.00 V	342	71.01	4.19
4	*5755.00	101.9 PK			1.00 V	342	97.72	4.18
5	*5755.00	91.7 AV			1.00 V	342	87.52	4.18

REMARKS:

1. Emission Level(dBuV/m) = Raw Value(dBuV) + Correction Factor(dB/m)
2. Correction Factor(dB/m) = Antenna Factor(dB/m) + Cable Factor(dB) – Pre-Amplifier Factor(dB)
3. The other emission levels were very low against the limit.
4. Margin value = Emission Level – Limit value
5. " * ": Fundamental frequency.
6. " # ": The radiated frequency is out of the restricted band.

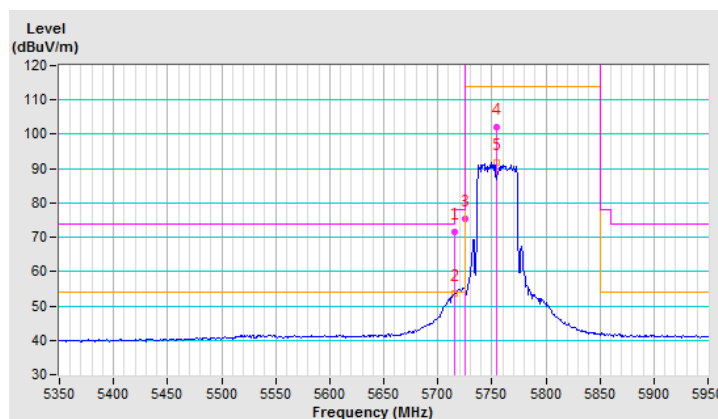

CHANNEL	TX Channel 159	DETECTOR FUNCTION	Peak (PK)
FREQUENCY RANGE	1GHz ~ 40GHz		Average (AV)

ANTENNA POLARITY & TEST DISTANCE: HORIZONTAL AT 3 M

NO.	FREQ. (MHz)	EMISSION LEVEL (dBuV/m)	LIMIT (dBuV/m)	MARGIN (dB)	ANTENNA HEIGHT (m)	TABLE ANGLE (Degree)	RAW VALUE (dBuV)	CORRECTION FACTOR (dB/m)
1	*5795.00	100.6 PK			1.16 H	281	96.41	4.19
2	*5795.00	91.1 AV			1.16 H	281	86.91	4.19
3	#5850.00	64.8 PK	78.2	-13.4	1.16 H	281	60.55	4.25
4	#5860.00	61.0 PK	74.0	-13.0	1.16 H	281	56.74	4.26
5	#5860.00	48.7 AV	54.0	-5.3	1.16 H	281	44.44	4.26

REMARKS:

1. Emission Level(dBuV/m) = Raw Value(dBuV) + Correction Factor(dB/m)
2. Correction Factor(dB/m) = Antenna Factor(dB/m) + Cable Factor(dB) – Pre-Amplifier Factor(dB)
3. The other emission levels were very low against the limit.
4. Margin value = Emission Level – Limit value
5. " * ": Fundamental frequency.
6. " # ": The radiated frequency is out of the restricted band.

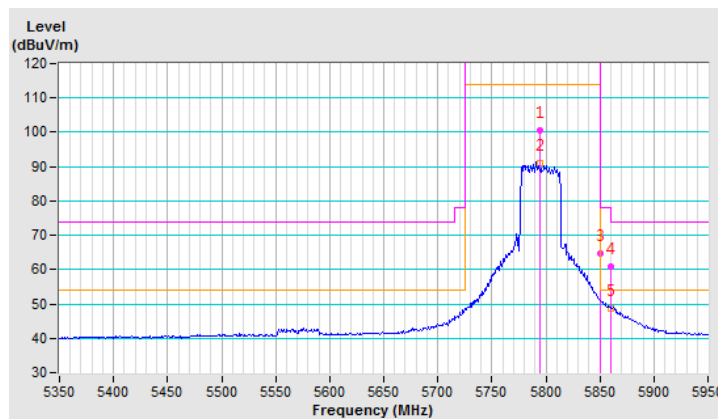

CHANNEL	TX Channel 159	DETECTOR FUNCTION	Peak (PK)
FREQUENCY RANGE	1GHz ~ 40GHz		Average (AV)

ANTENNA POLARITY & TEST DISTANCE: VERTICAL AT 3 M

NO.	FREQ. (MHz)	EMISSION LEVEL (dBuV/m)	LIMIT (dBuV/m)	MARGIN (dB)	ANTENNA HEIGHT (m)	TABLE ANGLE (Degree)	RAW VALUE (dBuV)	CORRECTION FACTOR (dB/m)
1	*5795.00	103.4 PK			1.00 V	342	99.21	4.19
2	*5795.00	94.5 AV			1.00 V	342	90.31	4.19
3	#5850.00	68.2 PK	78.2	-10.0	1.00 V	342	63.95	4.25
4	#5860.00	65.7 PK	74.0	-8.3	1.00 V	342	61.44	4.26
5	#5860.00	53.3 AV	54.0	-0.7	1.00 V	342	49.04	4.26

REMARKS:

1. Emission Level(dBuV/m) = Raw Value(dBuV) + Correction Factor(dB/m)
2. Correction Factor(dB/m) = Antenna Factor(dB/m) + Cable Factor(dB) – Pre-Amplifier Factor(dB)
3. The other emission levels were very low against the limit.
4. Margin value = Emission Level – Limit value
5. " * ": Fundamental frequency.
6. " # ": The radiated frequency is out of the restricted band.

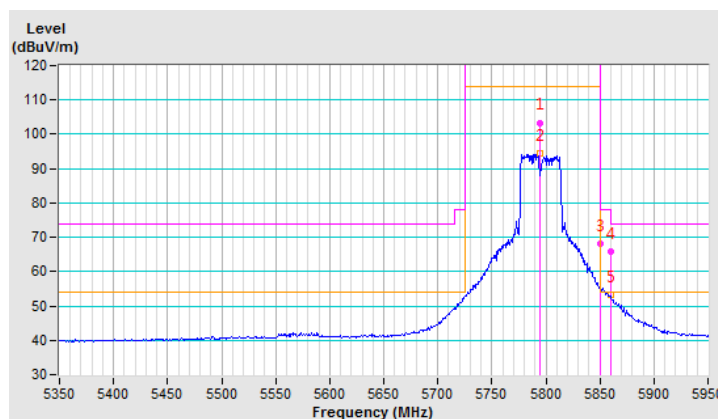

4.1.8 Test Results (Spurious emission)
Above 1GHz Data:
1TX
Antenna 1
802.11a

CHANNEL	TX Channel 36	DETECTOR FUNCTION	Peak (PK)
FREQUENCY RANGE	1GHz ~ 40GHz		Average (AV)

ANTENNA POLARITY & TEST DISTANCE: HORIZONTAL AT 3 M

NO.	FREQ. (MHz)	EMISSION LEVEL (dBuV/m)	LIMIT (dBuV/m)	MARGIN (dB)	ANTENNA HEIGHT (m)	TABLE ANGLE (Degree)	RAW VALUE (dBuV)	CORRECTION FACTOR (dB/m)
1	#10360.00	49.2 PK	74.0	-24.8	1.07 H	23	35.55	13.65
2	#10360.00	35.7 AV	54.0	-18.3	1.07 H	23	22.05	13.65
3	15540.00	50.7 PK	74.0	-23.3	1.37 H	175	35.02	15.68
4	15540.00	39.8 AV	54.0	-14.2	1.37 H	175	24.12	15.68

ANTENNA POLARITY & TEST DISTANCE: VERTICAL AT 3 M

NO.	FREQ. (MHz)	EMISSION LEVEL (dBuV/m)	LIMIT (dBuV/m)	MARGIN (dB)	ANTENNA HEIGHT (m)	TABLE ANGLE (Degree)	RAW VALUE (dBuV)	CORRECTION FACTOR (dB/m)
1	#10360.00	49.7 PK	74.0	-24.3	1.09 V	322	36.05	13.65
2	#10360.00	36.8 AV	54.0	-17.2	1.09 V	322	23.15	13.65
3	15540.00	50.4 PK	74.0	-23.6	1.23 V	14	34.72	15.68
4	15540.00	39.5 AV	54.0	-14.5	1.23 V	14	23.82	15.68

REMARKS:

1. Emission Level(dBuV/m) = Raw Value(dBuV) + Correction Factor(dB/m)
2. Correction Factor(dB/m) = Antenna Factor(dB/m) + Cable Factor(dB) – Pre-Amplifier Factor(dB)
3. The other emission levels were very low against the limit.
4. Margin value = Emission Level – Limit value
5. " # ": The radiated frequency is out of the restricted band.



CHANNEL	TX Channel 40	DETECTOR FUNCTION	Peak (PK)
FREQUENCY RANGE	1GHz ~ 40GHz		Average (AV)

ANTENNA POLARITY & TEST DISTANCE: HORIZONTAL AT 3 M

NO.	FREQ. (MHz)	EMISSION LEVEL (dBuV/m)	LIMIT (dBuV/m)	MARGIN (dB)	ANTENNA HEIGHT (m)	TABLE ANGLE (Degree)	RAW VALUE (dBuV)	CORRECTION FACTOR (dB/m)
1	#10400.00	50.7 PK	74.0	-23.3	1.04 H	34	37.04	13.66
2	#10400.00	38.5 AV	54.0	-15.5	1.04 H	34	24.84	13.66
3	15600.00	50.8 PK	74.0	-23.2	1.40 H	145	35.14	15.66
4	15600.00	40.0 AV	54.0	-14.0	1.40 H	145	24.34	15.66

ANTENNA POLARITY & TEST DISTANCE: VERTICAL AT 3 M

NO.	FREQ. (MHz)	EMISSION LEVEL (dBuV/m)	LIMIT (dBuV/m)	MARGIN (dB)	ANTENNA HEIGHT (m)	TABLE ANGLE (Degree)	RAW VALUE (dBuV)	CORRECTION FACTOR (dB/m)
1	#10400.00	52.2 PK	74.0	-21.8	1.10 V	339	38.54	13.66
2	#10400.00	40.3 AV	54.0	-13.7	1.10 V	339	26.64	13.66
3	15600.00	50.6 PK	74.0	-23.4	1.17 V	2	34.94	15.66
4	15600.00	40.1 AV	54.0	-13.9	1.17 V	2	24.44	15.66

REMARKS:

1. Emission Level(dBuV/m) = Raw Value(dBuV) + Correction Factor(dB/m)
2. Correction Factor(dB/m) = Antenna Factor(dB/m) + Cable Factor(dB) – Pre-Amplifier Factor(dB)
3. The other emission levels were very low against the limit.
4. Margin value = Emission Level – Limit value
5. "#": The radiated frequency is out of the restricted band.



CHANNEL	TX Channel 48	DETECTOR FUNCTION	Peak (PK)
FREQUENCY RANGE	1GHz ~ 40GHz		Average (AV)

ANTENNA POLARITY & TEST DISTANCE: HORIZONTAL AT 3 M

NO.	FREQ. (MHz)	EMISSION LEVEL (dBuV/m)	LIMIT (dBuV/m)	MARGIN (dB)	ANTENNA HEIGHT (m)	TABLE ANGLE (Degree)	RAW VALUE (dBuV)	CORRECTION FACTOR (dB/m)
1	#10480.00	52.8 PK	74.0	-21.2	1.10 H	20	38.79	14.01
2	#10480.00	39.8 AV	54.0	-14.2	1.10 H	20	25.79	14.01
3	15720.00	51.2 PK	74.0	-22.8	1.38 H	163	35.77	15.43
4	15720.00	39.8 AV	54.0	-14.2	1.38 H	163	24.37	15.43

ANTENNA POLARITY & TEST DISTANCE: VERTICAL AT 3 M

NO.	FREQ. (MHz)	EMISSION LEVEL (dBuV/m)	LIMIT (dBuV/m)	MARGIN (dB)	ANTENNA HEIGHT (m)	TABLE ANGLE (Degree)	RAW VALUE (dBuV)	CORRECTION FACTOR (dB/m)
1	#10480.00	55.0 PK	74.0	-19.0	1.04 V	308	40.99	14.01
2	#10480.00	42.1 AV	54.0	-11.9	1.04 V	308	28.09	14.01
3	15720.00	50.3 PK	74.0	-23.7	1.19 V	14	34.87	15.43
4	15720.00	40.0 AV	54.0	-14.0	1.19 V	14	24.57	15.43

REMARKS:

1. Emission Level(dBuV/m) = Raw Value(dBuV) + Correction Factor(dB/m)
2. Correction Factor(dB/m) = Antenna Factor(dB/m) + Cable Factor(dB) – Pre-Amplifier Factor(dB)
3. The other emission levels were very low against the limit.
4. Margin value = Emission Level – Limit value
5. " # ": The radiated frequency is out of the restricted band.



CHANNEL	TX Channel 52	DETECTOR FUNCTION	Peak (PK)
FREQUENCY RANGE	1GHz ~ 40GHz		Average (AV)

ANTENNA POLARITY & TEST DISTANCE: HORIZONTAL AT 3 M

NO.	FREQ. (MHz)	EMISSION LEVEL (dBuV/m)	LIMIT (dBuV/m)	MARGIN (dB)	ANTENNA HEIGHT (m)	TABLE ANGLE (Degree)	RAW VALUE (dBuV)	CORRECTION FACTOR (dB/m)
1	#10520.00	52.7 PK	74.0	-21.3	1.08 H	0	38.56	14.14
2	#10520.00	39.9 AV	54.0	-14.1	1.08 H	0	25.76	14.14
3	15780.00	51.2 PK	74.0	-22.8	1.40 H	161	36.05	15.15
4	15780.00	39.7 AV	54.0	-14.3	1.40 H	161	24.55	15.15

ANTENNA POLARITY & TEST DISTANCE: VERTICAL AT 3 M

NO.	FREQ. (MHz)	EMISSION LEVEL (dBuV/m)	LIMIT (dBuV/m)	MARGIN (dB)	ANTENNA HEIGHT (m)	TABLE ANGLE (Degree)	RAW VALUE (dBuV)	CORRECTION FACTOR (dB/m)
1	#10520.00	55.3 PK	74.0	-18.7	1.05 V	318	41.16	14.14
2	#10520.00	42.2 AV	54.0	-11.8	1.05 V	318	28.06	14.14
3	15780.00	50.5 PK	74.0	-23.5	1.14 V	2	35.35	15.15
4	15780.00	39.9 AV	54.0	-14.1	1.14 V	2	24.75	15.15

REMARKS:

1. Emission Level(dBuV/m) = Raw Value(dBuV) + Correction Factor(dB/m)
2. Correction Factor(dB/m) = Antenna Factor(dB/m) + Cable Factor(dB) – Pre-Amplifier Factor(dB)
3. The other emission levels were very low against the limit.
4. Margin value = Emission Level – Limit value
5. "#": The radiated frequency is out of the restricted band.



CHANNEL	TX Channel 60	DETECTOR FUNCTION	Peak (PK)
FREQUENCY RANGE	1GHz ~ 40GHz		Average (AV)

ANTENNA POLARITY & TEST DISTANCE: HORIZONTAL AT 3 M

NO.	FREQ. (MHz)	EMISSION LEVEL (dBuV/m)	LIMIT (dBuV/m)	MARGIN (dB)	ANTENNA HEIGHT (m)	TABLE ANGLE (Degree)	RAW VALUE (dBuV)	CORRECTION FACTOR (dB/m)
1	10600.00	50.6 PK	74.0	-23.4	1.08 H	35	36.30	14.30
2	10600.00	38.5 AV	54.0	-15.5	1.08 H	35	24.20	14.30
3	15900.00	50.9 PK	74.0	-23.1	1.42 H	136	35.83	15.07
4	15900.00	40.1 AV	54.0	-13.9	1.42 H	136	25.03	15.07

ANTENNA POLARITY & TEST DISTANCE: VERTICAL AT 3 M

NO.	FREQ. (MHz)	EMISSION LEVEL (dBuV/m)	LIMIT (dBuV/m)	MARGIN (dB)	ANTENNA HEIGHT (m)	TABLE ANGLE (Degree)	RAW VALUE (dBuV)	CORRECTION FACTOR (dB/m)
1	10600.00	52.6 PK	74.0	-21.4	1.07 V	339	38.30	14.30
2	10600.00	40.2 AV	54.0	-13.8	1.07 V	339	25.90	14.30
3	15900.00	50.3 PK	74.0	-23.7	1.16 V	0	35.23	15.07
4	15900.00	39.5 AV	54.0	-14.5	1.16 V	0	24.43	15.07

REMARKS:

1. Emission Level(dBuV/m) = Raw Value(dBuV) + Correction Factor(dB/m)
2. Correction Factor(dB/m) = Antenna Factor(dB/m) + Cable Factor(dB) – Pre-Amplifier Factor(dB)
3. The other emission levels were very low against the limit.
4. Margin value = Emission Level – Limit value



CHANNEL	TX Channel 64	DETECTOR FUNCTION	Peak (PK)
FREQUENCY RANGE	1GHz ~ 40GHz		Average (AV)

ANTENNA POLARITY & TEST DISTANCE: HORIZONTAL AT 3 M

NO.	FREQ. (MHz)	EMISSION LEVEL (dBuV/m)	LIMIT (dBuV/m)	MARGIN (dB)	ANTENNA HEIGHT (m)	TABLE ANGLE (Degree)	RAW VALUE (dBuV)	CORRECTION FACTOR (dB/m)
1	10640.00	48.8 PK	74.0	-25.2	1.07 H	9	34.44	14.36
2	10640.00	35.4 AV	54.0	-18.6	1.07 H	9	21.04	14.36
3	15960.00	50.5 PK	74.0	-23.5	1.40 H	159	35.42	15.08
4	15960.00	39.5 AV	54.0	-14.5	1.40 H	159	24.42	15.08

ANTENNA POLARITY & TEST DISTANCE: VERTICAL AT 3 M

NO.	FREQ. (MHz)	EMISSION LEVEL (dBuV/m)	LIMIT (dBuV/m)	MARGIN (dB)	ANTENNA HEIGHT (m)	TABLE ANGLE (Degree)	RAW VALUE (dBuV)	CORRECTION FACTOR (dB/m)
1	10640.00	49.8 PK	74.0	-24.2	1.00 V	320	35.44	14.36
2	10640.00	36.6 AV	54.0	-17.4	1.00 V	320	22.24	14.36
3	15960.00	50.5 PK	74.0	-23.5	1.20 V	10	35.42	15.08
4	15960.00	39.8 AV	54.0	-14.2	1.20 V	10	24.72	15.08

REMARKS:

1. Emission Level(dBuV/m) = Raw Value(dBuV) + Correction Factor(dB/m)
2. Correction Factor(dB/m) = Antenna Factor(dB/m) + Cable Factor(dB) – Pre-Amplifier Factor(dB)
3. The other emission levels were very low against the limit.
4. Margin value = Emission Level – Limit value



CHANNEL	TX Channel 100	DETECTOR FUNCTION	Peak (PK)
FREQUENCY RANGE	1GHz ~ 40GHz		Average (AV)

ANTENNA POLARITY & TEST DISTANCE: HORIZONTAL AT 3 M

NO.	FREQ. (MHz)	EMISSION LEVEL (dBuV/m)	LIMIT (dBuV/m)	MARGIN (dB)	ANTENNA HEIGHT (m)	TABLE ANGLE (Degree)	RAW VALUE (dBuV)	CORRECTION FACTOR (dB/m)
1	11000.00	48.6 PK	74.0	-25.4	1.07 H	34	33.43	15.17
2	11000.00	35.5 AV	54.0	-18.5	1.07 H	34	20.33	15.17
3	#16500.00	50.4 PK	74.0	-23.6	1.45 H	141	33.04	17.36
4	#16500.00	39.5 AV	54.0	-14.5	1.45 H	141	22.14	17.36

ANTENNA POLARITY & TEST DISTANCE: VERTICAL AT 3 M

NO.	FREQ. (MHz)	EMISSION LEVEL (dBuV/m)	LIMIT (dBuV/m)	MARGIN (dB)	ANTENNA HEIGHT (m)	TABLE ANGLE (Degree)	RAW VALUE (dBuV)	CORRECTION FACTOR (dB/m)
1	11000.00	49.4 PK	74.0	-24.6	1.00 V	318	34.23	15.17
2	11000.00	36.2 AV	54.0	-17.8	1.00 V	318	21.03	15.17
3	#16500.00	50.4 PK	74.0	-23.6	1.24 V	0	33.04	17.36
4	#16500.00	39.8 AV	54.0	-14.2	1.24 V	0	22.44	17.36

REMARKS:

1. Emission Level(dBuV/m) = Raw Value(dBuV) + Correction Factor(dB/m)
2. Correction Factor(dB/m) = Antenna Factor(dB/m) + Cable Factor(dB) – Pre-Amplifier Factor(dB)
3. The other emission levels were very low against the limit.
4. Margin value = Emission Level – Limit value
5. " # ": The radiated frequency is out of the restricted band.



CHANNEL	TX Channel 116	DETECTOR FUNCTION	Peak (PK)
FREQUENCY RANGE	1GHz ~ 40GHz		Average (AV)

ANTENNA POLARITY & TEST DISTANCE: HORIZONTAL AT 3 M

NO.	FREQ. (MHz)	EMISSION LEVEL (dBuV/m)	LIMIT (dBuV/m)	MARGIN (dB)	ANTENNA HEIGHT (m)	TABLE ANGLE (Degree)	RAW VALUE (dBuV)	CORRECTION FACTOR (dB/m)
1	11160.00	54.5 PK	74.0	-19.5	1.00 H	32	39.28	15.22
2	11160.00	41.6 AV	54.0	-12.4	1.00 H	32	26.38	15.22
3	#16740.00	50.4 PK	74.0	-23.6	1.37 H	163	32.07	18.33
4	#16740.00	39.1 AV	54.0	-14.9	1.37 H	163	20.77	18.33

ANTENNA POLARITY & TEST DISTANCE: VERTICAL AT 3 M

NO.	FREQ. (MHz)	EMISSION LEVEL (dBuV/m)	LIMIT (dBuV/m)	MARGIN (dB)	ANTENNA HEIGHT (m)	TABLE ANGLE (Degree)	RAW VALUE (dBuV)	CORRECTION FACTOR (dB/m)
1	11160.00	54.1 PK	74.0	-19.9	1.07 V	297	38.88	15.22
2	11160.00	41.1 AV	54.0	-12.9	1.07 V	297	25.88	15.22
3	#16740.00	50.3 PK	74.0	-23.7	1.22 V	18	31.97	18.33
4	#16740.00	40.0 AV	54.0	-14.0	1.22 V	18	21.67	18.33

REMARKS:

1. Emission Level(dBuV/m) = Raw Value(dBuV) + Correction Factor(dB/m)
2. Correction Factor(dB/m) = Antenna Factor(dB/m) + Cable Factor(dB) – Pre-Amplifier Factor(dB)
3. The other emission levels were very low against the limit.
4. Margin value = Emission Level – Limit value
5. " # ": The radiated frequency is out of the restricted band.



CHANNEL	TX Channel 140	DETECTOR FUNCTION	Peak (PK)
FREQUENCY RANGE	1GHz ~ 40GHz		Average (AV)

ANTENNA POLARITY & TEST DISTANCE: HORIZONTAL AT 3 M

NO.	FREQ. (MHz)	EMISSION LEVEL (dBuV/m)	LIMIT (dBuV/m)	MARGIN (dB)	ANTENNA HEIGHT (m)	TABLE ANGLE (Degree)	RAW VALUE (dBuV)	CORRECTION FACTOR (dB/m)
1	11400.00	50.9 PK	74.0	-23.1	1.06 H	32	35.45	15.45
2	11400.00	38.6 AV	54.0	-15.4	1.06 H	32	23.15	15.45
3	#17100.00	51.0 PK	74.0	-23.0	1.45 H	146	30.94	20.06
4	#17100.00	40.0 AV	54.0	-14.0	1.45 H	146	19.94	20.06

ANTENNA POLARITY & TEST DISTANCE: VERTICAL AT 3 M

NO.	FREQ. (MHz)	EMISSION LEVEL (dBuV/m)	LIMIT (dBuV/m)	MARGIN (dB)	ANTENNA HEIGHT (m)	TABLE ANGLE (Degree)	RAW VALUE (dBuV)	CORRECTION FACTOR (dB/m)
1	11400.00	51.9 PK	74.0	-22.1	1.12 V	326	36.45	15.45
2	11400.00	39.7 AV	54.0	-14.3	1.12 V	326	24.25	15.45
3	#17100.00	50.2 PK	74.0	-23.8	1.14 V	0	30.14	20.06
4	#17100.00	39.8 AV	54.0	-14.2	1.14 V	0	19.74	20.06

REMARKS:

1. Emission Level(dBuV/m) = Raw Value(dBuV) + Correction Factor(dB/m)
2. Correction Factor(dB/m) = Antenna Factor(dB/m) + Cable Factor(dB) – Pre-Amplifier Factor(dB)
3. The other emission levels were very low against the limit.
4. Margin value = Emission Level – Limit value
5. " # ": The radiated frequency is out of the restricted band.



CHANNEL	TX Channel 149	DETECTOR FUNCTION	Peak (PK)
FREQUENCY RANGE	1GHz ~ 40GHz		Average (AV)

ANTENNA POLARITY & TEST DISTANCE: HORIZONTAL AT 3 M

NO.	FREQ. (MHz)	EMISSION LEVEL (dBuV/m)	LIMIT (dBuV/m)	MARGIN (dB)	ANTENNA HEIGHT (m)	TABLE ANGLE (Degree)	RAW VALUE (dBuV)	CORRECTION FACTOR (dB/m)
1	11490.00	50.4 PK	74.0	-23.6	1.08 H	38	35.23	15.17
2	11490.00	38.1 AV	54.0	-15.9	1.08 H	38	22.93	15.17
3	#17235.00	51.0 PK	74.0	-23.0	1.40 H	164	31.10	19.90
4	#17235.00	40.0 AV	54.0	-14.0	1.40 H	164	20.10	19.90

ANTENNA POLARITY & TEST DISTANCE: VERTICAL AT 3 M

NO.	FREQ. (MHz)	EMISSION LEVEL (dBuV/m)	LIMIT (dBuV/m)	MARGIN (dB)	ANTENNA HEIGHT (m)	TABLE ANGLE (Degree)	RAW VALUE (dBuV)	CORRECTION FACTOR (dB/m)
1	11490.00	52.1 PK	74.0	-21.9	1.05 V	337	36.93	15.17
2	11490.00	39.8 AV	54.0	-14.2	1.05 V	337	24.63	15.17
3	#17235.00	50.7 PK	74.0	-23.3	1.18 V	14	30.80	19.90
4	#17235.00	40.1 AV	54.0	-13.9	1.18 V	14	20.20	19.90

REMARKS:

1. Emission Level(dBuV/m) = Raw Value(dBuV) + Correction Factor(dB/m)
2. Correction Factor(dB/m) = Antenna Factor(dB/m) + Cable Factor(dB) – Pre-Amplifier Factor(dB)
3. The other emission levels were very low against the limit.
4. Margin value = Emission Level – Limit value
5. " # ": The radiated frequency is out of the restricted band.



CHANNEL	TX Channel 157	DETECTOR FUNCTION	Peak (PK)
FREQUENCY RANGE	1GHz ~ 40GHz		Average (AV)

ANTENNA POLARITY & TEST DISTANCE: HORIZONTAL AT 3 M

NO.	FREQ. (MHz)	EMISSION LEVEL (dBuV/m)	LIMIT (dBuV/m)	MARGIN (dB)	ANTENNA HEIGHT (m)	TABLE ANGLE (Degree)	RAW VALUE (dBuV)	CORRECTION FACTOR (dB/m)
1	11570.00	55.1 PK	74.0	-18.9	1.08 H	30	39.98	15.12
2	11570.00	41.9 AV	54.0	-12.1	1.08 H	30	26.78	15.12
3	#17355.00	50.7 PK	74.0	-23.3	1.37 H	182	30.26	20.44
4	#17355.00	39.7 AV	54.0	-14.3	1.37 H	182	19.26	20.44

ANTENNA POLARITY & TEST DISTANCE: VERTICAL AT 3 M

NO.	FREQ. (MHz)	EMISSION LEVEL (dBuV/m)	LIMIT (dBuV/m)	MARGIN (dB)	ANTENNA HEIGHT (m)	TABLE ANGLE (Degree)	RAW VALUE (dBuV)	CORRECTION FACTOR (dB/m)
1	11570.00	54.9 PK	74.0	-19.1	1.08 V	311	39.78	15.12
2	11570.00	42.0 AV	54.0	-12.0	1.08 V	311	26.88	15.12
3	#17355.00	50.9 PK	74.0	-23.1	1.23 V	2	30.46	20.44
4	#17355.00	40.2 AV	54.0	-13.8	1.23 V	2	19.76	20.44

REMARKS:

1. Emission Level(dBuV/m) = Raw Value(dBuV) + Correction Factor(dB/m)
2. Correction Factor(dB/m) = Antenna Factor(dB/m) + Cable Factor(dB) – Pre-Amplifier Factor(dB)
3. The other emission levels were very low against the limit.
4. Margin value = Emission Level – Limit value
5. " # ": The radiated frequency is out of the restricted band.



CHANNEL	TX Channel 165	DETECTOR FUNCTION	Peak (PK)
FREQUENCY RANGE	1GHz ~ 40GHz		Average (AV)

ANTENNA POLARITY & TEST DISTANCE: HORIZONTAL AT 3 M

NO.	FREQ. (MHz)	EMISSION LEVEL (dBuV/m)	LIMIT (dBuV/m)	MARGIN (dB)	ANTENNA HEIGHT (m)	TABLE ANGLE (Degree)	RAW VALUE (dBuV)	CORRECTION FACTOR (dB/m)
1	11650.00	53.0 PK	74.0	-21.0	1.07 H	15	38.00	15.00
2	11650.00	39.8 AV	54.0	-14.2	1.07 H	15	24.80	15.00
3	#17475.00	51.3 PK	74.0	-22.7	1.42 H	157	30.19	21.11
4	#17475.00	39.9 AV	54.0	-14.1	1.42 H	157	18.79	21.11

ANTENNA POLARITY & TEST DISTANCE: VERTICAL AT 3 M

NO.	FREQ. (MHz)	EMISSION LEVEL (dBuV/m)	LIMIT (dBuV/m)	MARGIN (dB)	ANTENNA HEIGHT (m)	TABLE ANGLE (Degree)	RAW VALUE (dBuV)	CORRECTION FACTOR (dB/m)
1	11650.00	53.2 PK	74.0	-20.8	1.10 V	320	38.20	15.00
2	11650.00	40.5 AV	54.0	-13.5	1.10 V	320	25.50	15.00
3	#17475.00	50.8 PK	74.0	-23.2	1.21 V	0	29.69	21.11
4	#17475.00	40.2 AV	54.0	-13.8	1.21 V	0	19.09	21.11

REMARKS:

1. Emission Level(dBuV/m) = Raw Value(dBuV) + Correction Factor(dB/m)
2. Correction Factor(dB/m) = Antenna Factor(dB/m) + Cable Factor(dB) – Pre-Amplifier Factor(dB)
3. The other emission levels were very low against the limit.
4. Margin value = Emission Level – Limit value
5. " # ": The radiated frequency is out of the restricted band.

802.11n (20MHz)

CHANNEL	TX Channel 36	DETECTOR FUNCTION	Peak (PK)
FREQUENCY RANGE	1GHz ~ 40GHz		Average (AV)

ANTENNA POLARITY & TEST DISTANCE: HORIZONTAL AT 3 M

NO.	FREQ. (MHz)	EMISSION LEVEL (dBuV/m)	LIMIT (dBuV/m)	MARGIN (dB)	ANTENNA HEIGHT (m)	TABLE ANGLE (Degree)	RAW VALUE (dBuV)	CORRECTION FACTOR (dB/m)
1	#10360.00	48.4 PK	74.0	-25.6	1.14 H	26	34.75	13.65
2	#10360.00	35.3 AV	54.0	-18.7	1.14 H	26	21.65	13.65
3	15540.00	50.7 PK	74.0	-23.3	1.42 H	142	35.02	15.68
4	15540.00	39.9 AV	54.0	-14.1	1.42 H	142	24.22	15.68

ANTENNA POLARITY & TEST DISTANCE: VERTICAL AT 3 M

NO.	FREQ. (MHz)	EMISSION LEVEL (dBuV/m)	LIMIT (dBuV/m)	MARGIN (dB)	ANTENNA HEIGHT (m)	TABLE ANGLE (Degree)	RAW VALUE (dBuV)	CORRECTION FACTOR (dB/m)
1	#10360.00	49.5 PK	74.0	-24.5	1.00 V	317	35.85	13.65
2	#10360.00	36.4 AV	54.0	-17.6	1.00 V	317	22.75	13.65
3	15540.00	50.1 PK	74.0	-23.9	1.17 V	10	34.42	15.68
4	15540.00	39.7 AV	54.0	-14.3	1.17 V	10	24.02	15.68

REMARKS:

1. Emission Level(dBuV/m) = Raw Value(dBuV) + Correction Factor(dB/m)
2. Correction Factor(dB/m) = Antenna Factor(dB/m) + Cable Factor(dB) – Pre-Amplifier Factor(dB)
3. The other emission levels were very low against the limit.
4. Margin value = Emission Level – Limit value
5. " # ": The radiated frequency is out of the restricted band.



CHANNEL	TX Channel 40	DETECTOR FUNCTION	Peak (PK)
FREQUENCY RANGE	1GHz ~ 40GHz		Average (AV)

ANTENNA POLARITY & TEST DISTANCE: HORIZONTAL AT 3 M

NO.	FREQ. (MHz)	EMISSION LEVEL (dBuV/m)	LIMIT (dBuV/m)	MARGIN (dB)	ANTENNA HEIGHT (m)	TABLE ANGLE (Degree)	RAW VALUE (dBuV)	CORRECTION FACTOR (dB/m)
1	#10400.00	50.1 PK	74.0	-23.9	1.06 H	8	36.44	13.66
2	#10400.00	38.1 AV	54.0	-15.9	1.06 H	8	24.44	13.66
3	15600.00	50.9 PK	74.0	-23.1	1.43 H	154	35.24	15.66
4	15600.00	39.9 AV	54.0	-14.1	1.43 H	154	24.24	15.66

ANTENNA POLARITY & TEST DISTANCE: VERTICAL AT 3 M

NO.	FREQ. (MHz)	EMISSION LEVEL (dBuV/m)	LIMIT (dBuV/m)	MARGIN (dB)	ANTENNA HEIGHT (m)	TABLE ANGLE (Degree)	RAW VALUE (dBuV)	CORRECTION FACTOR (dB/m)
1	#10400.00	52.3 PK	74.0	-21.7	1.12 V	313	38.64	13.66
2	#10400.00	40.1 AV	54.0	-13.9	1.12 V	313	26.44	13.66
3	15600.00	50.5 PK	74.0	-23.5	1.23 V	9	34.84	15.66
4	15600.00	39.6 AV	54.0	-14.4	1.23 V	9	23.94	15.66

REMARKS:

1. Emission Level(dBuV/m) = Raw Value(dBuV) + Correction Factor(dB/m)
2. Correction Factor(dB/m) = Antenna Factor(dB/m) + Cable Factor(dB) – Pre-Amplifier Factor(dB)
3. The other emission levels were very low against the limit.
4. Margin value = Emission Level – Limit value
5. "#": The radiated frequency is out of the restricted band.



CHANNEL	TX Channel 48	DETECTOR FUNCTION	Peak (PK)
FREQUENCY RANGE	1GHz ~ 40GHz		Average (AV)

ANTENNA POLARITY & TEST DISTANCE: HORIZONTAL AT 3 M

NO.	FREQ. (MHz)	EMISSION LEVEL (dBuV/m)	LIMIT (dBuV/m)	MARGIN (dB)	ANTENNA HEIGHT (m)	TABLE ANGLE (Degree)	RAW VALUE (dBuV)	CORRECTION FACTOR (dB/m)
1	#10480.00	53.2 PK	74.0	-20.8	1.05 H	7	39.19	14.01
2	#10480.00	40.1 AV	54.0	-13.9	1.05 H	7	26.09	14.01
3	15720.00	51.1 PK	74.0	-22.9	1.40 H	162	35.67	15.43
4	15720.00	39.8 AV	54.0	-14.2	1.40 H	162	24.37	15.43

ANTENNA POLARITY & TEST DISTANCE: VERTICAL AT 3 M

NO.	FREQ. (MHz)	EMISSION LEVEL (dBuV/m)	LIMIT (dBuV/m)	MARGIN (dB)	ANTENNA HEIGHT (m)	TABLE ANGLE (Degree)	RAW VALUE (dBuV)	CORRECTION FACTOR (dB/m)
1	#10480.00	54.2 PK	74.0	-19.8	1.03 V	296	40.19	14.01
2	#10480.00	41.4 AV	54.0	-12.6	1.03 V	296	27.39	14.01
3	15720.00	50.8 PK	74.0	-23.2	1.19 V	0	35.37	15.43
4	15720.00	40.0 AV	54.0	-14.0	1.19 V	0	24.57	15.43

REMARKS:

1. Emission Level(dBuV/m) = Raw Value(dBuV) + Correction Factor(dB/m)
2. Correction Factor(dB/m) = Antenna Factor(dB/m) + Cable Factor(dB) – Pre-Amplifier Factor(dB)
3. The other emission levels were very low against the limit.
4. Margin value = Emission Level – Limit value
5. " # ": The radiated frequency is out of the restricted band.



CHANNEL	TX Channel 52	DETECTOR FUNCTION	Peak (PK)
FREQUENCY RANGE	1GHz ~ 40GHz		Average (AV)

ANTENNA POLARITY & TEST DISTANCE: HORIZONTAL AT 3 M

NO.	FREQ. (MHz)	EMISSION LEVEL (dBuV/m)	LIMIT (dBuV/m)	MARGIN (dB)	ANTENNA HEIGHT (m)	TABLE ANGLE (Degree)	RAW VALUE (dBuV)	CORRECTION FACTOR (dB/m)
1	#10520.00	52.7 PK	74.0	-21.3	1.09 H	23	38.56	14.14
2	#10520.00	39.9 AV	54.0	-14.1	1.09 H	23	25.76	14.14
3	15780.00	51.3 PK	74.0	-22.7	1.40 H	149	36.15	15.15
4	15780.00	40.0 AV	54.0	-14.0	1.40 H	149	24.85	15.15

ANTENNA POLARITY & TEST DISTANCE: VERTICAL AT 3 M

NO.	FREQ. (MHz)	EMISSION LEVEL (dBuV/m)	LIMIT (dBuV/m)	MARGIN (dB)	ANTENNA HEIGHT (m)	TABLE ANGLE (Degree)	RAW VALUE (dBuV)	CORRECTION FACTOR (dB/m)
1	#10520.00	54.9 PK	74.0	-19.1	1.11 V	295	40.76	14.14
2	#10520.00	41.8 AV	54.0	-12.2	1.11 V	295	27.66	14.14
3	15780.00	50.1 PK	74.0	-23.9	1.17 V	0	34.95	15.15
4	15780.00	39.7 AV	54.0	-14.3	1.17 V	0	24.55	15.15

REMARKS:

1. Emission Level(dBuV/m) = Raw Value(dBuV) + Correction Factor(dB/m)
2. Correction Factor(dB/m) = Antenna Factor(dB/m) + Cable Factor(dB) – Pre-Amplifier Factor(dB)
3. The other emission levels were very low against the limit.
4. Margin value = Emission Level – Limit value
5. "#": The radiated frequency is out of the restricted band.

CHANNEL	TX Channel 60	DETECTOR FUNCTION	Peak (PK)
FREQUENCY RANGE	1GHz ~ 40GHz		Average (AV)

ANTENNA POLARITY & TEST DISTANCE: HORIZONTAL AT 3 M

NO.	FREQ. (MHz)	EMISSION LEVEL (dBuV/m)	LIMIT (dBuV/m)	MARGIN (dB)	ANTENNA HEIGHT (m)	TABLE ANGLE (Degree)	RAW VALUE (dBuV)	CORRECTION FACTOR (dB/m)
1	10600.00	50.3 PK	74.0	-23.7	1.03 H	32	36.00	14.30
2	10600.00	38.2 AV	54.0	-15.8	1.03 H	32	23.90	14.30
3	15900.00	50.5 PK	74.0	-23.5	1.41 H	156	35.43	15.07
4	15900.00	39.6 AV	54.0	-14.4	1.41 H	156	24.53	15.07

ANTENNA POLARITY & TEST DISTANCE: VERTICAL AT 3 M

NO.	FREQ. (MHz)	EMISSION LEVEL (dBuV/m)	LIMIT (dBuV/m)	MARGIN (dB)	ANTENNA HEIGHT (m)	TABLE ANGLE (Degree)	RAW VALUE (dBuV)	CORRECTION FACTOR (dB/m)
1	10600.00	52.5 PK	74.0	-21.5	1.08 V	315	38.20	14.30
2	10600.00	40.3 AV	54.0	-13.7	1.08 V	315	26.00	14.30
3	15900.00	50.3 PK	74.0	-23.7	1.16 V	0	35.23	15.07
4	15900.00	39.9 AV	54.0	-14.1	1.16 V	0	24.83	15.07

REMARKS:

1. Emission Level(dBuV/m) = Raw Value(dBuV) + Correction Factor(dB/m)
2. Correction Factor(dB/m) = Antenna Factor(dB/m) + Cable Factor(dB) – Pre-Amplifier Factor(dB)
3. The other emission levels were very low against the limit.
4. Margin value = Emission Level – Limit value



CHANNEL	TX Channel 64	DETECTOR FUNCTION	Peak (PK)
FREQUENCY RANGE	1GHz ~ 40GHz		Average (AV)

ANTENNA POLARITY & TEST DISTANCE: HORIZONTAL AT 3 M

NO.	FREQ. (MHz)	EMISSION LEVEL (dBuV/m)	LIMIT (dBuV/m)	MARGIN (dB)	ANTENNA HEIGHT (m)	TABLE ANGLE (Degree)	RAW VALUE (dBuV)	CORRECTION FACTOR (dB/m)
1	10640.00	48.1 PK	74.0	-25.9	1.07 H	7	33.74	14.36
2	10640.00	35.1 AV	54.0	-18.9	1.07 H	7	20.74	14.36
3	15960.00	49.9 PK	74.0	-24.1	1.40 H	151	34.82	15.08
4	15960.00	39.2 AV	54.0	-14.8	1.40 H	151	24.12	15.08

ANTENNA POLARITY & TEST DISTANCE: VERTICAL AT 3 M

NO.	FREQ. (MHz)	EMISSION LEVEL (dBuV/m)	LIMIT (dBuV/m)	MARGIN (dB)	ANTENNA HEIGHT (m)	TABLE ANGLE (Degree)	RAW VALUE (dBuV)	CORRECTION FACTOR (dB/m)
1	10640.00	49.1 PK	74.0	-24.9	1.07 V	316	34.74	14.36
2	10640.00	36.1 AV	54.0	-17.9	1.07 V	316	21.74	14.36
3	15960.00	50.5 PK	74.0	-23.5	1.25 V	8	35.42	15.08
4	15960.00	39.9 AV	54.0	-14.1	1.25 V	8	24.82	15.08

REMARKS:

1. Emission Level(dBuV/m) = Raw Value(dBuV) + Correction Factor(dB/m)
2. Correction Factor(dB/m) = Antenna Factor(dB/m) + Cable Factor(dB) – Pre-Amplifier Factor(dB)
3. The other emission levels were very low against the limit.
4. Margin value = Emission Level – Limit value



CHANNEL	TX Channel 100	DETECTOR FUNCTION	Peak (PK)
FREQUENCY RANGE	1GHz ~ 40GHz		Average (AV)

ANTENNA POLARITY & TEST DISTANCE: HORIZONTAL AT 3 M

NO.	FREQ. (MHz)	EMISSION LEVEL (dBuV/m)	LIMIT (dBuV/m)	MARGIN (dB)	ANTENNA HEIGHT (m)	TABLE ANGLE (Degree)	RAW VALUE (dBuV)	CORRECTION FACTOR (dB/m)
1	11000.00	50.6 PK	74.0	-23.4	1.13 H	22	35.43	15.17
2	11000.00	37.2 AV	54.0	-16.8	1.13 H	22	22.03	15.17
3	#16500.00	50.8 PK	74.0	-23.2	1.43 H	150	33.44	17.36
4	#16500.00	39.9 AV	54.0	-14.1	1.43 H	150	22.54	17.36

ANTENNA POLARITY & TEST DISTANCE: VERTICAL AT 3 M

NO.	FREQ. (MHz)	EMISSION LEVEL (dBuV/m)	LIMIT (dBuV/m)	MARGIN (dB)	ANTENNA HEIGHT (m)	TABLE ANGLE (Degree)	RAW VALUE (dBuV)	CORRECTION FACTOR (dB/m)
1	11000.00	49.7 PK	74.0	-24.3	1.01 V	312	34.53	15.17
2	11000.00	36.4 AV	54.0	-17.6	1.01 V	312	21.23	15.17
3	#16500.00	50.1 PK	74.0	-23.9	1.22 V	14	32.74	17.36
4	#16500.00	39.5 AV	54.0	-14.5	1.22 V	14	22.14	17.36

REMARKS:

1. Emission Level(dBuV/m) = Raw Value(dBuV) + Correction Factor(dB/m)
2. Correction Factor(dB/m) = Antenna Factor(dB/m) + Cable Factor(dB) – Pre-Amplifier Factor(dB)
3. The other emission levels were very low against the limit.
4. Margin value = Emission Level – Limit value
5. " # ": The radiated frequency is out of the restricted band.



CHANNEL	TX Channel 116	DETECTOR FUNCTION	Peak (PK)
FREQUENCY RANGE	1GHz ~ 40GHz		Average (AV)

ANTENNA POLARITY & TEST DISTANCE: HORIZONTAL AT 3 M

NO.	FREQ. (MHz)	EMISSION LEVEL (dBuV/m)	LIMIT (dBuV/m)	MARGIN (dB)	ANTENNA HEIGHT (m)	TABLE ANGLE (Degree)	RAW VALUE (dBuV)	CORRECTION FACTOR (dB/m)
1	11160.00	55.2 PK	74.0	-18.8	1.02 H	23	39.98	15.22
2	11160.00	42.1 AV	54.0	-11.9	1.02 H	23	26.88	15.22
3	#16740.00	50.5 PK	74.0	-23.5	1.39 H	167	32.17	18.33
4	#16740.00	39.3 AV	54.0	-14.7	1.39 H	167	20.97	18.33

ANTENNA POLARITY & TEST DISTANCE: VERTICAL AT 3 M

NO.	FREQ. (MHz)	EMISSION LEVEL (dBuV/m)	LIMIT (dBuV/m)	MARGIN (dB)	ANTENNA HEIGHT (m)	TABLE ANGLE (Degree)	RAW VALUE (dBuV)	CORRECTION FACTOR (dB/m)
1	11160.00	54.8 PK	74.0	-19.2	1.00 V	300	39.58	15.22
2	11160.00	41.7 AV	54.0	-12.3	1.00 V	300	26.48	15.22
3	#16740.00	50.2 PK	74.0	-23.8	1.24 V	7	31.87	18.33
4	#16740.00	39.9 AV	54.0	-14.1	1.24 V	7	21.57	18.33

REMARKS:

1. Emission Level(dBuV/m) = Raw Value(dBuV) + Correction Factor(dB/m)
2. Correction Factor(dB/m) = Antenna Factor(dB/m) + Cable Factor(dB) – Pre-Amplifier Factor(dB)
3. The other emission levels were very low against the limit.
4. Margin value = Emission Level – Limit value
5. " # ": The radiated frequency is out of the restricted band.



CHANNEL	TX Channel 140	DETECTOR FUNCTION	Peak (PK)
FREQUENCY RANGE	1GHz ~ 40GHz		Average (AV)

ANTENNA POLARITY & TEST DISTANCE: HORIZONTAL AT 3 M

NO.	FREQ. (MHz)	EMISSION LEVEL (dBuV/m)	LIMIT (dBuV/m)	MARGIN (dB)	ANTENNA HEIGHT (m)	TABLE ANGLE (Degree)	RAW VALUE (dBuV)	CORRECTION FACTOR (dB/m)
1	11400.00	50.5 PK	74.0	-23.5	1.11 H	23	35.05	15.45
2	11400.00	38.3 AV	54.0	-15.7	1.11 H	23	22.85	15.45
3	#17100.00	50.7 PK	74.0	-23.3	1.46 H	136	30.64	20.06
4	#17100.00	39.8 AV	54.0	-14.2	1.46 H	136	19.74	20.06

ANTENNA POLARITY & TEST DISTANCE: VERTICAL AT 3 M

NO.	FREQ. (MHz)	EMISSION LEVEL (dBuV/m)	LIMIT (dBuV/m)	MARGIN (dB)	ANTENNA HEIGHT (m)	TABLE ANGLE (Degree)	RAW VALUE (dBuV)	CORRECTION FACTOR (dB/m)
1	11400.00	52.1 PK	74.0	-21.9	1.04 V	326	36.65	15.45
2	11400.00	39.8 AV	54.0	-14.2	1.04 V	326	24.35	15.45
3	#17100.00	49.8 PK	74.0	-24.2	1.18 V	14	29.74	20.06
4	#17100.00	39.3 AV	54.0	-14.7	1.18 V	14	19.24	20.06

REMARKS:

1. Emission Level(dBuV/m) = Raw Value(dBuV) + Correction Factor(dB/m)
2. Correction Factor(dB/m) = Antenna Factor(dB/m) + Cable Factor(dB) – Pre-Amplifier Factor(dB)
3. The other emission levels were very low against the limit.
4. Margin value = Emission Level – Limit value
5. " # ": The radiated frequency is out of the restricted band.



CHANNEL	TX Channel 149	DETECTOR FUNCTION	Peak (PK)
FREQUENCY RANGE	1GHz ~ 40GHz		Average (AV)

ANTENNA POLARITY & TEST DISTANCE: HORIZONTAL AT 3 M

NO.	FREQ. (MHz)	EMISSION LEVEL (dBuV/m)	LIMIT (dBuV/m)	MARGIN (dB)	ANTENNA HEIGHT (m)	TABLE ANGLE (Degree)	RAW VALUE (dBuV)	CORRECTION FACTOR (dB/m)
1	11490.00	50.5 PK	74.0	-23.5	1.14 H	26	35.33	15.17
2	11490.00	38.1 AV	54.0	-15.9	1.14 H	26	22.93	15.17
3	#17235.00	51.4 PK	74.0	-22.6	1.46 H	153	31.50	19.90
4	#17235.00	40.2 AV	54.0	-13.8	1.46 H	153	20.30	19.90

ANTENNA POLARITY & TEST DISTANCE: VERTICAL AT 3 M

NO.	FREQ. (MHz)	EMISSION LEVEL (dBuV/m)	LIMIT (dBuV/m)	MARGIN (dB)	ANTENNA HEIGHT (m)	TABLE ANGLE (Degree)	RAW VALUE (dBuV)	CORRECTION FACTOR (dB/m)
1	11490.00	52.1 PK	74.0	-21.9	1.10 V	324	36.93	15.17
2	11490.00	39.9 AV	54.0	-14.1	1.10 V	324	24.73	15.17
3	#17235.00	50.4 PK	74.0	-23.6	1.19 V	0	30.50	19.90
4	#17235.00	39.7 AV	54.0	-14.3	1.19 V	0	19.80	19.90

REMARKS:

1. Emission Level(dBuV/m) = Raw Value(dBuV) + Correction Factor(dB/m)
2. Correction Factor(dB/m) = Antenna Factor(dB/m) + Cable Factor(dB) – Pre-Amplifier Factor(dB)
3. The other emission levels were very low against the limit.
4. Margin value = Emission Level – Limit value
5. " # ": The radiated frequency is out of the restricted band.



CHANNEL	TX Channel 157	DETECTOR FUNCTION	Peak (PK)
FREQUENCY RANGE	1GHz ~ 40GHz		Average (AV)

ANTENNA POLARITY & TEST DISTANCE: HORIZONTAL AT 3 M

NO.	FREQ. (MHz)	EMISSION LEVEL (dBuV/m)	LIMIT (dBuV/m)	MARGIN (dB)	ANTENNA HEIGHT (m)	TABLE ANGLE (Degree)	RAW VALUE (dBuV)	CORRECTION FACTOR (dB/m)
1	11570.00	53.3 PK	74.0	-20.7	1.04 H	17	38.18	15.12
2	11570.00	40.2 AV	54.0	-13.8	1.04 H	17	25.08	15.12
3	#17355.00	51.2 PK	74.0	-22.8	1.39 H	177	30.76	20.44
4	#17355.00	39.7 AV	54.0	-14.3	1.39 H	177	19.26	20.44

ANTENNA POLARITY & TEST DISTANCE: VERTICAL AT 3 M

NO.	FREQ. (MHz)	EMISSION LEVEL (dBuV/m)	LIMIT (dBuV/m)	MARGIN (dB)	ANTENNA HEIGHT (m)	TABLE ANGLE (Degree)	RAW VALUE (dBuV)	CORRECTION FACTOR (dB/m)
1	11570.00	55.0 PK	74.0	-19.0	1.09 V	308	39.88	15.12
2	11570.00	42.0 AV	54.0	-12.0	1.09 V	308	26.88	15.12
3	#17355.00	50.3 PK	74.0	-23.7	1.18 V	6	29.86	20.44
4	#17355.00	39.6 AV	54.0	-14.4	1.18 V	6	19.16	20.44

REMARKS:

1. Emission Level(dBuV/m) = Raw Value(dBuV) + Correction Factor(dB/m)
2. Correction Factor(dB/m) = Antenna Factor(dB/m) + Cable Factor(dB) – Pre-Amplifier Factor(dB)
3. The other emission levels were very low against the limit.
4. Margin value = Emission Level – Limit value
5. " # ": The radiated frequency is out of the restricted band.



CHANNEL	TX Channel 165	DETECTOR FUNCTION	Peak (PK)
FREQUENCY RANGE	1GHz ~ 40GHz		Average (AV)

ANTENNA POLARITY & TEST DISTANCE: HORIZONTAL AT 3 M

NO.	FREQ. (MHz)	EMISSION LEVEL (dBuV/m)	LIMIT (dBuV/m)	MARGIN (dB)	ANTENNA HEIGHT (m)	TABLE ANGLE (Degree)	RAW VALUE (dBuV)	CORRECTION FACTOR (dB/m)
1	11650.00	53.2 PK	74.0	-20.8	1.00 H	0	38.20	15.00
2	11650.00	40.2 AV	54.0	-13.8	1.00 H	0	25.20	15.00
3	#17475.00	50.9 PK	74.0	-23.1	1.36 H	153	29.79	21.11
4	#17475.00	39.4 AV	54.0	-14.6	1.36 H	153	18.29	21.11

ANTENNA POLARITY & TEST DISTANCE: VERTICAL AT 3 M

NO.	FREQ. (MHz)	EMISSION LEVEL (dBuV/m)	LIMIT (dBuV/m)	MARGIN (dB)	ANTENNA HEIGHT (m)	TABLE ANGLE (Degree)	RAW VALUE (dBuV)	CORRECTION FACTOR (dB/m)
1	11650.00	54.7 PK	74.0	-19.3	1.00 V	323	39.70	15.00
2	11650.00	41.4 AV	54.0	-12.6	1.00 V	323	26.40	15.00
3	#17475.00	50.6 PK	74.0	-23.4	1.15 V	14	29.49	21.11
4	#17475.00	40.0 AV	54.0	-14.0	1.15 V	14	18.89	21.11

REMARKS:

1. Emission Level(dBuV/m) = Raw Value(dBuV) + Correction Factor(dB/m)
2. Correction Factor(dB/m) = Antenna Factor(dB/m) + Cable Factor(dB) – Pre-Amplifier Factor(dB)
3. The other emission levels were very low against the limit.
4. Margin value = Emission Level – Limit value
5. "#": The radiated frequency is out of the restricted band.

802.11n (40MHz)

CHANNEL	TX Channel 38	DETECTOR FUNCTION	Peak (PK)
FREQUENCY RANGE	1GHz ~ 40GHz		Average (AV)

ANTENNA POLARITY & TEST DISTANCE: HORIZONTAL AT 3 M

NO.	FREQ. (MHz)	EMISSION LEVEL (dBuV/m)	LIMIT (dBuV/m)	MARGIN (dB)	ANTENNA HEIGHT (m)	TABLE ANGLE (Degree)	RAW VALUE (dBuV)	CORRECTION FACTOR (dB/m)
1	#10380.00	48.8 PK	74.0	-25.2	1.12 H	34	35.14	13.66
2	#10380.00	35.7 AV	54.0	-18.3	1.12 H	34	22.04	13.66
3	15570.00	50.5 PK	74.0	-23.5	1.37 H	136	34.83	15.67
4	15570.00	39.5 AV	54.0	-14.5	1.37 H	136	23.83	15.67

ANTENNA POLARITY & TEST DISTANCE: VERTICAL AT 3 M

NO.	FREQ. (MHz)	EMISSION LEVEL (dBuV/m)	LIMIT (dBuV/m)	MARGIN (dB)	ANTENNA HEIGHT (m)	TABLE ANGLE (Degree)	RAW VALUE (dBuV)	CORRECTION FACTOR (dB/m)
1	#10380.00	49.5 PK	74.0	-24.5	1.01 V	304	35.84	13.66
2	#10380.00	36.3 AV	54.0	-17.7	1.01 V	304	22.64	13.66
3	15570.00	50.6 PK	74.0	-23.4	1.24 V	0	34.93	15.67
4	15570.00	39.9 AV	54.0	-14.1	1.24 V	0	24.23	15.67

REMARKS:

1. Emission Level(dBuV/m) = Raw Value(dBuV) + Correction Factor(dB/m)
2. Correction Factor(dB/m) = Antenna Factor(dB/m) + Cable Factor(dB) – Pre-Amplifier Factor(dB)
3. The other emission levels were very low against the limit.
4. Margin value = Emission Level – Limit value
5. " # ": The radiated frequency is out of the restricted band.



CHANNEL	TX Channel 46	DETECTOR FUNCTION	Peak (PK)
FREQUENCY RANGE	1GHz ~ 40GHz		Average (AV)

ANTENNA POLARITY & TEST DISTANCE: HORIZONTAL AT 3 M

NO.	FREQ. (MHz)	EMISSION LEVEL (dBuV/m)	LIMIT (dBuV/m)	MARGIN (dB)	ANTENNA HEIGHT (m)	TABLE ANGLE (Degree)	RAW VALUE (dBuV)	CORRECTION FACTOR (dB/m)
1	#10460.00	49.0 PK	74.0	-25.0	1.14 H	15	35.08	13.92
2	#10460.00	35.7 AV	54.0	-18.3	1.14 H	15	21.78	13.92
3	15690.00	50.3 PK	74.0	-23.7	1.37 H	147	34.76	15.54
4	15690.00	39.4 AV	54.0	-14.6	1.37 H	147	23.86	15.54

ANTENNA POLARITY & TEST DISTANCE: VERTICAL AT 3 M

NO.	FREQ. (MHz)	EMISSION LEVEL (dBuV/m)	LIMIT (dBuV/m)	MARGIN (dB)	ANTENNA HEIGHT (m)	TABLE ANGLE (Degree)	RAW VALUE (dBuV)	CORRECTION FACTOR (dB/m)
1	#10460.00	49.9 PK	74.0	-24.1	1.08 V	309	35.98	13.92
2	#10460.00	36.6 AV	54.0	-17.4	1.08 V	309	22.68	13.92
3	15690.00	50.2 PK	74.0	-23.8	1.24 V	21	34.66	15.54
4	15690.00	39.4 AV	54.0	-14.6	1.24 V	21	23.86	15.54

REMARKS:

1. Emission Level(dBuV/m) = Raw Value(dBuV) + Correction Factor(dB/m)
2. Correction Factor(dB/m) = Antenna Factor(dB/m) + Cable Factor(dB) – Pre-Amplifier Factor(dB)
3. The other emission levels were very low against the limit.
4. Margin value = Emission Level – Limit value
5. "#": The radiated frequency is out of the restricted band.



CHANNEL	TX Channel 54	DETECTOR FUNCTION	Peak (PK)
FREQUENCY RANGE	1GHz ~ 40GHz		Average (AV)

ANTENNA POLARITY & TEST DISTANCE: HORIZONTAL AT 3 M

NO.	FREQ. (MHz)	EMISSION LEVEL (dBuV/m)	LIMIT (dBuV/m)	MARGIN (dB)	ANTENNA HEIGHT (m)	TABLE ANGLE (Degree)	RAW VALUE (dBuV)	CORRECTION FACTOR (dB/m)
1	#10540.00	48.1 PK	74.0	-25.9	1.08 H	22	33.92	14.18
2	#10540.00	35.2 AV	54.0	-18.8	1.08 H	22	21.02	14.18
3	15810.00	50.8 PK	74.0	-23.2	1.41 H	142	35.75	15.05
4	15810.00	39.9 AV	54.0	-14.1	1.41 H	142	24.85	15.05

ANTENNA POLARITY & TEST DISTANCE: VERTICAL AT 3 M

NO.	FREQ. (MHz)	EMISSION LEVEL (dBuV/m)	LIMIT (dBuV/m)	MARGIN (dB)	ANTENNA HEIGHT (m)	TABLE ANGLE (Degree)	RAW VALUE (dBuV)	CORRECTION FACTOR (dB/m)
1	#10540.00	49.7 PK	74.0	-24.3	1.00 V	312	35.52	14.18
2	#10540.00	36.6 AV	54.0	-17.4	1.00 V	312	22.42	14.18
3	15810.00	50.5 PK	74.0	-23.5	1.25 V	15	35.45	15.05
4	15810.00	40.2 AV	54.0	-13.8	1.25 V	15	25.15	15.05

REMARKS:

1. Emission Level(dBuV/m) = Raw Value(dBuV) + Correction Factor(dB/m)
2. Correction Factor(dB/m) = Antenna Factor(dB/m) + Cable Factor(dB) – Pre-Amplifier Factor(dB)
3. The other emission levels were very low against the limit.
4. Margin value = Emission Level – Limit value
5. "#": The radiated frequency is out of the restricted band.



CHANNEL	TX Channel 62	DETECTOR FUNCTION	Peak (PK)
FREQUENCY RANGE	1GHz ~ 40GHz		Average (AV)

ANTENNA POLARITY & TEST DISTANCE: HORIZONTAL AT 3 M

NO.	FREQ. (MHz)	EMISSION LEVEL (dBuV/m)	LIMIT (dBuV/m)	MARGIN (dB)	ANTENNA HEIGHT (m)	TABLE ANGLE (Degree)	RAW VALUE (dBuV)	CORRECTION FACTOR (dB/m)
1	10620.00	48.0 PK	74.0	-26.0	1.09 H	35	33.67	14.33
2	10620.00	35.1 AV	54.0	-18.9	1.09 H	35	20.77	14.33
3	15930.00	51.0 PK	74.0	-23.0	1.38 H	135	35.92	15.08
4	15930.00	39.9 AV	54.0	-14.1	1.38 H	135	24.82	15.08

ANTENNA POLARITY & TEST DISTANCE: VERTICAL AT 3 M

NO.	FREQ. (MHz)	EMISSION LEVEL (dBuV/m)	LIMIT (dBuV/m)	MARGIN (dB)	ANTENNA HEIGHT (m)	TABLE ANGLE (Degree)	RAW VALUE (dBuV)	CORRECTION FACTOR (dB/m)
1	10620.00	49.2 PK	74.0	-24.8	1.05 V	313	34.87	14.33
2	10620.00	35.9 AV	54.0	-18.1	1.05 V	313	21.57	14.33
3	15930.00	49.6 PK	74.0	-24.4	1.27 V	0	34.52	15.08
4	15930.00	39.3 AV	54.0	-14.7	1.27 V	0	24.22	15.08

REMARKS:

1. Emission Level(dBuV/m) = Raw Value(dBuV) + Correction Factor(dB/m)
2. Correction Factor(dB/m) = Antenna Factor(dB/m) + Cable Factor(dB) – Pre-Amplifier Factor(dB)
3. The other emission levels were very low against the limit.
4. Margin value = Emission Level – Limit value



CHANNEL	TX Channel 102	DETECTOR FUNCTION	Peak (PK)
FREQUENCY RANGE	1GHz ~ 40GHz		Average (AV)

ANTENNA POLARITY & TEST DISTANCE: HORIZONTAL AT 3 M

NO.	FREQ. (MHz)	EMISSION LEVEL (dBuV/m)	LIMIT (dBuV/m)	MARGIN (dB)	ANTENNA HEIGHT (m)	TABLE ANGLE (Degree)	RAW VALUE (dBuV)	CORRECTION FACTOR (dB/m)
1	11020.00	49.8 PK	74.0	-24.2	1.12 H	9	34.63	15.17
2	11020.00	36.7 AV	54.0	-17.3	1.12 H	9	21.53	15.17
3	#16530.00	50.5 PK	74.0	-23.5	1.42 H	133	33.03	17.47
4	#16530.00	39.3 AV	54.0	-14.7	1.42 H	133	21.83	17.47

ANTENNA POLARITY & TEST DISTANCE: VERTICAL AT 3 M

NO.	FREQ. (MHz)	EMISSION LEVEL (dBuV/m)	LIMIT (dBuV/m)	MARGIN (dB)	ANTENNA HEIGHT (m)	TABLE ANGLE (Degree)	RAW VALUE (dBuV)	CORRECTION FACTOR (dB/m)
1	11020.00	49.2 PK	74.0	-24.8	1.06 V	310	34.03	15.17
2	11020.00	36.0 AV	54.0	-18.0	1.06 V	310	20.83	15.17
3	#16530.00	50.3 PK	74.0	-23.7	1.24 V	0	32.83	17.47
4	#16530.00	39.5 AV	54.0	-14.5	1.24 V	0	22.03	17.47

REMARKS:

1. Emission Level(dBuV/m) = Raw Value(dBuV) + Correction Factor(dB/m)
2. Correction Factor(dB/m) = Antenna Factor(dB/m) + Cable Factor(dB) – Pre-Amplifier Factor(dB)
3. The other emission levels were very low against the limit.
4. Margin value = Emission Level – Limit value
5. " # ": The radiated frequency is out of the restricted band.



CHANNEL	TX Channel 110	DETECTOR FUNCTION	Peak (PK)
FREQUENCY RANGE	1GHz ~ 40GHz		Average (AV)

ANTENNA POLARITY & TEST DISTANCE: HORIZONTAL AT 3 M

NO.	FREQ. (MHz)	EMISSION LEVEL (dBuV/m)	LIMIT (dBuV/m)	MARGIN (dB)	ANTENNA HEIGHT (m)	TABLE ANGLE (Degree)	RAW VALUE (dBuV)	CORRECTION FACTOR (dB/m)
1	11100.00	48.9 PK	74.0	-25.1	1.06 H	39	33.73	15.17
2	11100.00	35.8 AV	54.0	-18.2	1.06 H	39	20.63	15.17
3	#16650.00	50.3 PK	74.0	-23.7	1.45 H	152	32.26	18.04
4	#16650.00	39.6 AV	54.0	-14.4	1.45 H	152	21.56	18.04

ANTENNA POLARITY & TEST DISTANCE: VERTICAL AT 3 M

NO.	FREQ. (MHz)	EMISSION LEVEL (dBuV/m)	LIMIT (dBuV/m)	MARGIN (dB)	ANTENNA HEIGHT (m)	TABLE ANGLE (Degree)	RAW VALUE (dBuV)	CORRECTION FACTOR (dB/m)
1	11100.00	49.2 PK	74.0	-24.8	1.07 V	307	34.03	15.17
2	11100.00	36.1 AV	54.0	-17.9	1.07 V	307	20.93	15.17
3	#16650.00	50.0 PK	74.0	-24.0	1.25 V	4	31.96	18.04
4	#16650.00	39.4 AV	54.0	-14.6	1.25 V	4	21.36	18.04

REMARKS:

1. Emission Level(dBuV/m) = Raw Value(dBuV) + Correction Factor(dB/m)
2. Correction Factor(dB/m) = Antenna Factor(dB/m) + Cable Factor(dB) – Pre-Amplifier Factor(dB)
3. The other emission levels were very low against the limit.
4. Margin value = Emission Level – Limit value
5. "#": The radiated frequency is out of the restricted band.



CHANNEL	TX Channel 134	DETECTOR FUNCTION	Peak (PK)
FREQUENCY RANGE	1GHz ~ 40GHz		Average (AV)

ANTENNA POLARITY & TEST DISTANCE: HORIZONTAL AT 3 M

NO.	FREQ. (MHz)	EMISSION LEVEL (dBuV/m)	LIMIT (dBuV/m)	MARGIN (dB)	ANTENNA HEIGHT (m)	TABLE ANGLE (Degree)	RAW VALUE (dBuV)	CORRECTION FACTOR (dB/m)
1	11340.00	50.4 PK	74.0	-23.6	1.09 H	38	35.11	15.29
2	11340.00	37.1 AV	54.0	-16.9	1.09 H	38	21.81	15.29
3	#17010.00	49.9 PK	74.0	-24.1	1.35 H	157	29.97	19.93
4	#17010.00	39.1 AV	54.0	-14.9	1.35 H	157	19.17	19.93

ANTENNA POLARITY & TEST DISTANCE: VERTICAL AT 3 M

NO.	FREQ. (MHz)	EMISSION LEVEL (dBuV/m)	LIMIT (dBuV/m)	MARGIN (dB)	ANTENNA HEIGHT (m)	TABLE ANGLE (Degree)	RAW VALUE (dBuV)	CORRECTION FACTOR (dB/m)
1	11340.00	50.2 PK	74.0	-23.8	1.04 V	292	34.91	15.29
2	11340.00	36.9 AV	54.0	-17.1	1.04 V	292	21.61	15.29
3	#17010.00	51.0 PK	74.0	-23.0	1.25 V	10	31.07	19.93
4	#17010.00	40.3 AV	54.0	-13.7	1.25 V	10	20.37	19.93

REMARKS:

1. Emission Level(dBuV/m) = Raw Value(dBuV) + Correction Factor(dB/m)
2. Correction Factor(dB/m) = Antenna Factor(dB/m) + Cable Factor(dB) – Pre-Amplifier Factor(dB)
3. The other emission levels were very low against the limit.
4. Margin value = Emission Level – Limit value
5. " # ": The radiated frequency is out of the restricted band.



CHANNEL	TX Channel 151	DETECTOR FUNCTION	Peak (PK)
FREQUENCY RANGE	1GHz ~ 40GHz		Average (AV)

ANTENNA POLARITY & TEST DISTANCE: HORIZONTAL AT 3 M

NO.	FREQ. (MHz)	EMISSION LEVEL (dBuV/m)	LIMIT (dBuV/m)	MARGIN (dB)	ANTENNA HEIGHT (m)	TABLE ANGLE (Degree)	RAW VALUE (dBuV)	CORRECTION FACTOR (dB/m)
1	11510.00	48.9 PK	74.0	-25.1	1.14 H	33	33.76	15.14
2	11510.00	35.8 AV	54.0	-18.2	1.14 H	33	20.66	15.14
3	#17265.00	50.9 PK	74.0	-23.1	1.45 H	147	30.91	19.99
4	#17265.00	39.8 AV	54.0	-14.2	1.45 H	147	19.81	19.99

ANTENNA POLARITY & TEST DISTANCE: VERTICAL AT 3 M

NO.	FREQ. (MHz)	EMISSION LEVEL (dBuV/m)	LIMIT (dBuV/m)	MARGIN (dB)	ANTENNA HEIGHT (m)	TABLE ANGLE (Degree)	RAW VALUE (dBuV)	CORRECTION FACTOR (dB/m)
1	11510.00	49.5 PK	74.0	-24.5	1.02 V	299	34.36	15.14
2	11510.00	36.5 AV	54.0	-17.5	1.02 V	299	21.36	15.14
3	#17265.00	50.6 PK	74.0	-23.4	1.17 V	0	30.61	19.99
4	#17265.00	40.1 AV	54.0	-13.9	1.17 V	0	20.11	19.99

REMARKS:

1. Emission Level(dBuV/m) = Raw Value(dBuV) + Correction Factor(dB/m)
2. Correction Factor(dB/m) = Antenna Factor(dB/m) + Cable Factor(dB) – Pre-Amplifier Factor(dB)
3. The other emission levels were very low against the limit.
4. Margin value = Emission Level – Limit value
5. " # ": The radiated frequency is out of the restricted band.



CHANNEL	TX Channel 159	DETECTOR FUNCTION	Peak (PK)
FREQUENCY RANGE	1GHz ~ 40GHz		Average (AV)

ANTENNA POLARITY & TEST DISTANCE: HORIZONTAL AT 3 M

NO.	FREQ. (MHz)	EMISSION LEVEL (dBuV/m)	LIMIT (dBuV/m)	MARGIN (dB)	ANTENNA HEIGHT (m)	TABLE ANGLE (Degree)	RAW VALUE (dBuV)	CORRECTION FACTOR (dB/m)
1	11590.00	49.1 PK	74.0	-24.9	1.04 H	19	33.99	15.11
2	11590.00	36.0 AV	54.0	-18.0	1.04 H	19	20.89	15.11
3	#17385.00	50.6 PK	74.0	-23.4	1.37 H	151	29.98	20.62
4	#17385.00	39.5 AV	54.0	-14.5	1.37 H	151	18.88	20.62

ANTENNA POLARITY & TEST DISTANCE: VERTICAL AT 3 M

NO.	FREQ. (MHz)	EMISSION LEVEL (dBuV/m)	LIMIT (dBuV/m)	MARGIN (dB)	ANTENNA HEIGHT (m)	TABLE ANGLE (Degree)	RAW VALUE (dBuV)	CORRECTION FACTOR (dB/m)
1	11590.00	48.9 PK	74.0	-25.1	1.07 V	312	33.79	15.11
2	11590.00	36.1 AV	54.0	-17.9	1.07 V	312	20.99	15.11
3	#17385.00	50.3 PK	74.0	-23.7	1.21 V	0	29.68	20.62
4	#17385.00	39.8 AV	54.0	-14.2	1.21 V	0	19.18	20.62

REMARKS:

1. Emission Level(dBuV/m) = Raw Value(dBuV) + Correction Factor(dB/m)
2. Correction Factor(dB/m) = Antenna Factor(dB/m) + Cable Factor(dB) – Pre-Amplifier Factor(dB)
3. The other emission levels were very low against the limit.
4. Margin value = Emission Level – Limit value
5. " # ": The radiated frequency is out of the restricted band.

Antenna 2

802.11a

CHANNEL	TX Channel 36	DETECTOR FUNCTION	Peak (PK)
FREQUENCY RANGE	1GHz ~ 40GHz		Average (AV)

ANTENNA POLARITY & TEST DISTANCE: HORIZONTAL AT 3 M

NO.	FREQ. (MHz)	EMISSION LEVEL (dBuV/m)	LIMIT (dBuV/m)	MARGIN (dB)	ANTENNA HEIGHT (m)	TABLE ANGLE (Degree)	RAW VALUE (dBuV)	CORRECTION FACTOR (dB/m)
1	#10360.00	47.3 PK	74.0	-26.7	1.47 H	222	33.65	13.65
2	#10360.00	35.8 AV	54.0	-18.2	1.47 H	222	22.15	13.65
3	15540.00	51.5 PK	74.0	-22.5	2.22 H	232	35.82	15.68
4	15540.00	41.2 AV	54.0	-12.8	2.22 H	232	25.52	15.68

ANTENNA POLARITY & TEST DISTANCE: VERTICAL AT 3 M

NO.	FREQ. (MHz)	EMISSION LEVEL (dBuV/m)	LIMIT (dBuV/m)	MARGIN (dB)	ANTENNA HEIGHT (m)	TABLE ANGLE (Degree)	RAW VALUE (dBuV)	CORRECTION FACTOR (dB/m)
1	#10360.00	47.2 PK	74.0	-26.8	1.34 V	195	33.55	13.65
2	#10360.00	34.8 AV	54.0	-19.2	1.34 V	195	21.15	13.65
3	15540.00	51.2 PK	74.0	-22.8	2.17 V	254	35.52	15.68
4	15540.00	39.3 AV	54.0	-14.7	2.17 V	254	23.62	15.68

REMARKS:

1. Emission Level(dBuV/m) = Raw Value(dBuV) + Correction Factor(dB/m)
2. Correction Factor(dB/m) = Antenna Factor(dB/m) + Cable Factor(dB) – Pre-Amplifier Factor(dB)
3. The other emission levels were very low against the limit.
4. Margin value = Emission Level – Limit value
5. "#": The radiated frequency is out of the restricted band.



CHANNEL	TX Channel 40	DETECTOR FUNCTION	Peak (PK)
FREQUENCY RANGE	1GHz ~ 40GHz		Average (AV)

ANTENNA POLARITY & TEST DISTANCE: HORIZONTAL AT 3 M

NO.	FREQ. (MHz)	EMISSION LEVEL (dBuV/m)	LIMIT (dBuV/m)	MARGIN (dB)	ANTENNA HEIGHT (m)	TABLE ANGLE (Degree)	RAW VALUE (dBuV)	CORRECTION FACTOR (dB/m)
1	#10400.00	48.0 PK	74.0	-26.0	1.43 H	222	34.34	13.66
2	#10400.00	36.3 AV	54.0	-17.7	1.43 H	222	22.64	13.66
3	15600.00	51.5 PK	74.0	-22.5	2.27 H	248	35.84	15.66
4	15600.00	41.6 AV	54.0	-12.4	2.27 H	248	25.94	15.66

ANTENNA POLARITY & TEST DISTANCE: VERTICAL AT 3 M

NO.	FREQ. (MHz)	EMISSION LEVEL (dBuV/m)	LIMIT (dBuV/m)	MARGIN (dB)	ANTENNA HEIGHT (m)	TABLE ANGLE (Degree)	RAW VALUE (dBuV)	CORRECTION FACTOR (dB/m)
1	#10400.00	50.3 PK	74.0	-23.7	2.17 V	313	36.64	13.66
2	#10400.00	36.0 AV	54.0	-18.0	2.17 V	313	22.34	13.66
3	15600.00	56.5 PK	74.0	-17.5	1.93 V	34	40.84	15.66
4	15600.00	41.6 AV	54.0	-12.4	1.93 V	34	25.94	15.66

REMARKS:

1. Emission Level(dBuV/m) = Raw Value(dBuV) + Correction Factor(dB/m)
2. Correction Factor(dB/m) = Antenna Factor(dB/m) + Cable Factor(dB) – Pre-Amplifier Factor(dB)
3. The other emission levels were very low against the limit.
4. Margin value = Emission Level – Limit value
5. "#": The radiated frequency is out of the restricted band.



CHANNEL	TX Channel 48	DETECTOR FUNCTION	Peak (PK)
FREQUENCY RANGE	1GHz ~ 40GHz		Average (AV)

ANTENNA POLARITY & TEST DISTANCE: HORIZONTAL AT 3 M

NO.	FREQ. (MHz)	EMISSION LEVEL (dBuV/m)	LIMIT (dBuV/m)	MARGIN (dB)	ANTENNA HEIGHT (m)	TABLE ANGLE (Degree)	RAW VALUE (dBuV)	CORRECTION FACTOR (dB/m)
1	#10480.00	47.4 PK	74.0	-26.6	1.46 H	231	33.39	14.01
2	#10480.00	35.4 AV	54.0	-18.6	1.46 H	231	21.39	14.01
3	15720.00	52.3 PK	74.0	-21.7	2.24 H	244	36.87	15.43
4	15720.00	42.1 AV	54.0	-11.9	2.24 H	244	26.67	15.43

ANTENNA POLARITY & TEST DISTANCE: VERTICAL AT 3 M

NO.	FREQ. (MHz)	EMISSION LEVEL (dBuV/m)	LIMIT (dBuV/m)	MARGIN (dB)	ANTENNA HEIGHT (m)	TABLE ANGLE (Degree)	RAW VALUE (dBuV)	CORRECTION FACTOR (dB/m)
1	#10480.00	50.0 PK	74.0	-24.0	2.09 V	333	35.99	14.01
2	#10480.00	35.8 AV	54.0	-18.2	2.09 V	333	21.79	14.01
3	15720.00	56.3 PK	74.0	-17.7	1.97 V	32	40.87	15.43
4	15720.00	41.7 AV	54.0	-12.3	1.97 V	32	26.27	15.43

REMARKS:

1. Emission Level(dBuV/m) = Raw Value(dBuV) + Correction Factor(dB/m)
2. Correction Factor(dB/m) = Antenna Factor(dB/m) + Cable Factor(dB) – Pre-Amplifier Factor(dB)
3. The other emission levels were very low against the limit.
4. Margin value = Emission Level – Limit value
5. " # ": The radiated frequency is out of the restricted band.



CHANNEL	TX Channel 52	DETECTOR FUNCTION	Peak (PK)
FREQUENCY RANGE	1GHz ~ 40GHz		Average (AV)

ANTENNA POLARITY & TEST DISTANCE: HORIZONTAL AT 3 M

NO.	FREQ. (MHz)	EMISSION LEVEL (dBuV/m)	LIMIT (dBuV/m)	MARGIN (dB)	ANTENNA HEIGHT (m)	TABLE ANGLE (Degree)	RAW VALUE (dBuV)	CORRECTION FACTOR (dB/m)
1	#10520.00	46.9 PK	74.0	-27.1	1.44 H	205	32.76	14.14
2	#10520.00	35.4 AV	54.0	-18.6	1.44 H	205	21.26	14.14
3	15780.00	51.5 PK	74.0	-22.5	2.24 H	255	36.35	15.15
4	15780.00	41.3 AV	54.0	-12.7	2.24 H	255	26.15	15.15

ANTENNA POLARITY & TEST DISTANCE: VERTICAL AT 3 M

NO.	FREQ. (MHz)	EMISSION LEVEL (dBuV/m)	LIMIT (dBuV/m)	MARGIN (dB)	ANTENNA HEIGHT (m)	TABLE ANGLE (Degree)	RAW VALUE (dBuV)	CORRECTION FACTOR (dB/m)
1	#10520.00	49.9 PK	74.0	-24.1	2.17 V	328	35.76	14.14
2	#10520.00	35.4 AV	54.0	-18.6	2.17 V	328	21.26	14.14
3	15780.00	56.6 PK	74.0	-17.4	2.03 V	21	41.45	15.15
4	15780.00	41.9 AV	54.0	-12.1	2.03 V	21	26.75	15.15

REMARKS:

1. Emission Level(dBuV/m) = Raw Value(dBuV) + Correction Factor(dB/m)
2. Correction Factor(dB/m) = Antenna Factor(dB/m) + Cable Factor(dB) – Pre-Amplifier Factor(dB)
3. The other emission levels were very low against the limit.
4. Margin value = Emission Level – Limit value
5. "#": The radiated frequency is out of the restricted band.

CHANNEL	TX Channel 60	DETECTOR FUNCTION	Peak (PK)
FREQUENCY RANGE	1GHz ~ 40GHz		Average (AV)

ANTENNA POLARITY & TEST DISTANCE: HORIZONTAL AT 3 M

NO.	FREQ. (MHz)	EMISSION LEVEL (dBuV/m)	LIMIT (dBuV/m)	MARGIN (dB)	ANTENNA HEIGHT (m)	TABLE ANGLE (Degree)	RAW VALUE (dBuV)	CORRECTION FACTOR (dB/m)
1	10600.00	47.6 PK	74.0	-26.4	1.38 H	217	33.30	14.30
2	10600.00	36.1 AV	54.0	-17.9	1.38 H	217	21.80	14.30
3	15900.00	51.5 PK	74.0	-22.5	2.30 H	240	36.43	15.07
4	15900.00	41.3 AV	54.0	-12.7	2.30 H	240	26.23	15.07

ANTENNA POLARITY & TEST DISTANCE: VERTICAL AT 3 M

NO.	FREQ. (MHz)	EMISSION LEVEL (dBuV/m)	LIMIT (dBuV/m)	MARGIN (dB)	ANTENNA HEIGHT (m)	TABLE ANGLE (Degree)	RAW VALUE (dBuV)	CORRECTION FACTOR (dB/m)
1	10600.00	49.3 PK	74.0	-24.7	2.17 V	330	35.00	14.30
2	10600.00	35.3 AV	54.0	-18.7	2.17 V	330	21.00	14.30
3	15900.00	56.0 PK	74.0	-18.0	2.04 V	27	40.93	15.07
4	15900.00	41.1 AV	54.0	-12.9	2.04 V	27	26.03	15.07

REMARKS:

1. Emission Level(dBuV/m) = Raw Value(dBuV) + Correction Factor(dB/m)
2. Correction Factor(dB/m) = Antenna Factor(dB/m) + Cable Factor(dB) – Pre-Amplifier Factor(dB)
3. The other emission levels were very low against the limit.
4. Margin value = Emission Level – Limit value



CHANNEL	TX Channel 64	DETECTOR FUNCTION	Peak (PK)
FREQUENCY RANGE	1GHz ~ 40GHz		Average (AV)

ANTENNA POLARITY & TEST DISTANCE: HORIZONTAL AT 3 M

NO.	FREQ. (MHz)	EMISSION LEVEL (dBuV/m)	LIMIT (dBuV/m)	MARGIN (dB)	ANTENNA HEIGHT (m)	TABLE ANGLE (Degree)	RAW VALUE (dBuV)	CORRECTION FACTOR (dB/m)
1	10640.00	46.8 PK	74.0	-27.2	1.49 H	229	32.44	14.36
2	10640.00	35.4 AV	54.0	-18.6	1.49 H	229	21.04	14.36
3	15960.00	51.3 PK	74.0	-22.7	2.27 H	218	36.22	15.08
4	15960.00	40.8 AV	54.0	-13.2	2.27 H	218	25.72	15.08

ANTENNA POLARITY & TEST DISTANCE: VERTICAL AT 3 M

NO.	FREQ. (MHz)	EMISSION LEVEL (dBuV/m)	LIMIT (dBuV/m)	MARGIN (dB)	ANTENNA HEIGHT (m)	TABLE ANGLE (Degree)	RAW VALUE (dBuV)	CORRECTION FACTOR (dB/m)
1	10640.00	49.9 PK	74.0	-24.1	2.10 V	339	35.54	14.36
2	10640.00	35.5 AV	54.0	-18.5	2.10 V	339	21.14	14.36
3	15960.00	56.3 PK	74.0	-17.7	2.03 V	25	41.22	15.08
4	15960.00	41.4 AV	54.0	-12.6	2.03 V	25	26.32	15.08

REMARKS:

1. Emission Level(dBuV/m) = Raw Value(dBuV) + Correction Factor(dB/m)
2. Correction Factor(dB/m) = Antenna Factor(dB/m) + Cable Factor(dB) – Pre-Amplifier Factor(dB)
3. The other emission levels were very low against the limit.
4. Margin value = Emission Level – Limit value



CHANNEL	TX Channel 100	DETECTOR FUNCTION	Peak (PK)
FREQUENCY RANGE	1GHz ~ 40GHz		Average (AV)

ANTENNA POLARITY & TEST DISTANCE: HORIZONTAL AT 3 M

NO.	FREQ. (MHz)	EMISSION LEVEL (dBuV/m)	LIMIT (dBuV/m)	MARGIN (dB)	ANTENNA HEIGHT (m)	TABLE ANGLE (Degree)	RAW VALUE (dBuV)	CORRECTION FACTOR (dB/m)
1	11000.00	47.8 PK	74.0	-26.2	1.52 H	236	32.63	15.17
2	11000.00	36.2 AV	54.0	-17.8	1.52 H	236	21.03	15.17
3	#16500.00	51.5 PK	74.0	-22.5	2.28 H	237	34.14	17.36
4	#16500.00	41.4 AV	54.0	-12.6	2.28 H	237	24.04	17.36

ANTENNA POLARITY & TEST DISTANCE: VERTICAL AT 3 M

NO.	FREQ. (MHz)	EMISSION LEVEL (dBuV/m)	LIMIT (dBuV/m)	MARGIN (dB)	ANTENNA HEIGHT (m)	TABLE ANGLE (Degree)	RAW VALUE (dBuV)	CORRECTION FACTOR (dB/m)
1	11000.00	50.1 PK	74.0	-23.9	2.08 V	324	34.93	15.17
2	11000.00	35.8 AV	54.0	-18.2	2.08 V	324	20.63	15.17
3	#16500.00	56.1 PK	74.0	-17.9	1.94 V	42	38.74	17.36
4	#16500.00	41.1 AV	54.0	-12.9	1.94 V	42	23.74	17.36

REMARKS:

1. Emission Level(dBuV/m) = Raw Value(dBuV) + Correction Factor(dB/m)
2. Correction Factor(dB/m) = Antenna Factor(dB/m) + Cable Factor(dB) – Pre-Amplifier Factor(dB)
3. The other emission levels were very low against the limit.
4. Margin value = Emission Level – Limit value
5. " # ": The radiated frequency is out of the restricted band.



CHANNEL	TX Channel 116	DETECTOR FUNCTION	Peak (PK)
FREQUENCY RANGE	1GHz ~ 40GHz		Average (AV)

ANTENNA POLARITY & TEST DISTANCE: HORIZONTAL AT 3 M

NO.	FREQ. (MHz)	EMISSION LEVEL (dBuV/m)	LIMIT (dBuV/m)	MARGIN (dB)	ANTENNA HEIGHT (m)	TABLE ANGLE (Degree)	RAW VALUE (dBuV)	CORRECTION FACTOR (dB/m)
1	11160.00	47.6 PK	74.0	-26.4	1.43 H	224	32.38	15.22
2	11160.00	36.2 AV	54.0	-17.8	1.43 H	224	20.98	15.22
3	#16740.00	51.4 PK	74.0	-22.6	2.29 H	244	33.07	18.33
4	#16740.00	41.3 AV	54.0	-12.7	2.29 H	244	22.97	18.33

ANTENNA POLARITY & TEST DISTANCE: VERTICAL AT 3 M

NO.	FREQ. (MHz)	EMISSION LEVEL (dBuV/m)	LIMIT (dBuV/m)	MARGIN (dB)	ANTENNA HEIGHT (m)	TABLE ANGLE (Degree)	RAW VALUE (dBuV)	CORRECTION FACTOR (dB/m)
1	11160.00	50.4 PK	74.0	-23.6	2.15 V	309	35.18	15.22
2	11160.00	35.9 AV	54.0	-18.1	2.15 V	309	20.68	15.22
3	#16740.00	55.9 PK	74.0	-18.1	1.97 V	38	37.57	18.33
4	#16740.00	41.3 AV	54.0	-12.7	1.97 V	38	22.97	18.33

REMARKS:

1. Emission Level(dBuV/m) = Raw Value(dBuV) + Correction Factor(dB/m)
2. Correction Factor(dB/m) = Antenna Factor(dB/m) + Cable Factor(dB) – Pre-Amplifier Factor(dB)
3. The other emission levels were very low against the limit.
4. Margin value = Emission Level – Limit value
5. " # ": The radiated frequency is out of the restricted band.



CHANNEL	TX Channel 140	DETECTOR FUNCTION	Peak (PK)
FREQUENCY RANGE	1GHz ~ 40GHz		Average (AV)

ANTENNA POLARITY & TEST DISTANCE: HORIZONTAL AT 3 M

NO.	FREQ. (MHz)	EMISSION LEVEL (dBuV/m)	LIMIT (dBuV/m)	MARGIN (dB)	ANTENNA HEIGHT (m)	TABLE ANGLE (Degree)	RAW VALUE (dBuV)	CORRECTION FACTOR (dB/m)
1	11400.00	47.7 PK	74.0	-26.3	1.53 H	214	32.25	15.45
2	11400.00	35.9 AV	54.0	-18.1	1.53 H	214	20.45	15.45
3	#17100.00	51.0 PK	74.0	-23.0	2.19 H	231	30.94	20.06
4	#17100.00	40.8 AV	54.0	-13.2	2.19 H	231	20.74	20.06

ANTENNA POLARITY & TEST DISTANCE: VERTICAL AT 3 M

NO.	FREQ. (MHz)	EMISSION LEVEL (dBuV/m)	LIMIT (dBuV/m)	MARGIN (dB)	ANTENNA HEIGHT (m)	TABLE ANGLE (Degree)	RAW VALUE (dBuV)	CORRECTION FACTOR (dB/m)
1	11400.00	50.2 PK	74.0	-23.8	2.17 V	323	34.75	15.45
2	11400.00	35.7 AV	54.0	-18.3	2.17 V	323	20.25	15.45
3	#17100.00	55.8 PK	74.0	-18.2	1.93 V	39	35.74	20.06
4	#17100.00	41.1 AV	54.0	-12.9	1.93 V	39	21.04	20.06

REMARKS:

1. Emission Level(dBuV/m) = Raw Value(dBuV) + Correction Factor(dB/m)
2. Correction Factor(dB/m) = Antenna Factor(dB/m) + Cable Factor(dB) – Pre-Amplifier Factor(dB)
3. The other emission levels were very low against the limit.
4. Margin value = Emission Level – Limit value
5. " # ": The radiated frequency is out of the restricted band.



CHANNEL	TX Channel 149	DETECTOR FUNCTION	Peak (PK)
FREQUENCY RANGE	1GHz ~ 40GHz		Average (AV)

ANTENNA POLARITY & TEST DISTANCE: HORIZONTAL AT 3 M

NO.	FREQ. (MHz)	EMISSION LEVEL (dBuV/m)	LIMIT (dBuV/m)	MARGIN (dB)	ANTENNA HEIGHT (m)	TABLE ANGLE (Degree)	RAW VALUE (dBuV)	CORRECTION FACTOR (dB/m)
1	11490.00	47.7 PK	74.0	-26.3	1.42 H	236	32.53	15.17
2	11490.00	36.0 AV	54.0	-18.0	1.42 H	236	20.83	15.17
3	#17235.00	51.6 PK	74.0	-22.4	2.16 H	244	31.70	19.90
4	#17235.00	41.4 AV	54.0	-12.6	2.16 H	244	21.50	19.90

ANTENNA POLARITY & TEST DISTANCE: VERTICAL AT 3 M

NO.	FREQ. (MHz)	EMISSION LEVEL (dBuV/m)	LIMIT (dBuV/m)	MARGIN (dB)	ANTENNA HEIGHT (m)	TABLE ANGLE (Degree)	RAW VALUE (dBuV)	CORRECTION FACTOR (dB/m)
1	11490.00	46.4 PK	74.0	-27.6	1.34 V	203	31.23	15.17
2	11490.00	34.2 AV	54.0	-19.8	1.34 V	203	19.03	15.17
3	#17235.00	51.3 PK	74.0	-22.7	2.27 V	267	31.40	19.90
4	#17235.00	39.4 AV	54.0	-14.6	2.27 V	267	19.50	19.90

REMARKS:

1. Emission Level(dBuV/m) = Raw Value(dBuV) + Correction Factor(dB/m)
2. Correction Factor(dB/m) = Antenna Factor(dB/m) + Cable Factor(dB) – Pre-Amplifier Factor(dB)
3. The other emission levels were very low against the limit.
4. Margin value = Emission Level – Limit value
5. " # ": The radiated frequency is out of the restricted band.



CHANNEL	TX Channel 157	DETECTOR FUNCTION	Peak (PK)
FREQUENCY RANGE	1GHz ~ 40GHz		Average (AV)

ANTENNA POLARITY & TEST DISTANCE: HORIZONTAL AT 3 M

NO.	FREQ. (MHz)	EMISSION LEVEL (dBuV/m)	LIMIT (dBuV/m)	MARGIN (dB)	ANTENNA HEIGHT (m)	TABLE ANGLE (Degree)	RAW VALUE (dBuV)	CORRECTION FACTOR (dB/m)
1	11570.00	47.7 PK	74.0	-26.3	1.46 H	218	32.58	15.12
2	11570.00	35.7 AV	54.0	-18.3	1.46 H	218	20.58	15.12
3	#17355.00	51.8 PK	74.0	-22.2	2.20 H	249	31.36	20.44
4	#17355.00	41.8 AV	54.0	-12.2	2.20 H	249	21.36	20.44

ANTENNA POLARITY & TEST DISTANCE: VERTICAL AT 3 M

NO.	FREQ. (MHz)	EMISSION LEVEL (dBuV/m)	LIMIT (dBuV/m)	MARGIN (dB)	ANTENNA HEIGHT (m)	TABLE ANGLE (Degree)	RAW VALUE (dBuV)	CORRECTION FACTOR (dB/m)
1	11570.00	49.5 PK	74.0	-24.5	2.18 V	339	34.38	15.12
2	11570.00	35.3 AV	54.0	-18.7	2.18 V	339	20.18	15.12
3	#17355.00	56.6 PK	74.0	-17.4	1.94 V	47	36.16	20.44
4	#17355.00	41.7 AV	54.0	-12.3	1.94 V	47	21.26	20.44

REMARKS:

1. Emission Level(dBuV/m) = Raw Value(dBuV) + Correction Factor(dB/m)
2. Correction Factor(dB/m) = Antenna Factor(dB/m) + Cable Factor(dB) – Pre-Amplifier Factor(dB)
3. The other emission levels were very low against the limit.
4. Margin value = Emission Level – Limit value
5. " # ": The radiated frequency is out of the restricted band.



CHANNEL	TX Channel 165	DETECTOR FUNCTION	Peak (PK)
FREQUENCY RANGE	1GHz ~ 40GHz		Average (AV)

ANTENNA POLARITY & TEST DISTANCE: HORIZONTAL AT 3 M

NO.	FREQ. (MHz)	EMISSION LEVEL (dBuV/m)	LIMIT (dBuV/m)	MARGIN (dB)	ANTENNA HEIGHT (m)	TABLE ANGLE (Degree)	RAW VALUE (dBuV)	CORRECTION FACTOR (dB/m)
1	11650.00	47.9 PK	74.0	-26.1	1.47 H	218	32.90	15.00
2	11650.00	35.3 AV	54.0	-18.7	1.47 H	218	20.30	15.00
3	#17475.00	51.8 PK	74.0	-22.2	2.24 H	260	30.69	21.11
4	#17475.00	41.7 AV	54.0	-12.3	2.24 H	260	20.59	21.11

ANTENNA POLARITY & TEST DISTANCE: VERTICAL AT 3 M

NO.	FREQ. (MHz)	EMISSION LEVEL (dBuV/m)	LIMIT (dBuV/m)	MARGIN (dB)	ANTENNA HEIGHT (m)	TABLE ANGLE (Degree)	RAW VALUE (dBuV)	CORRECTION FACTOR (dB/m)
1	11650.00	49.1 PK	74.0	-24.9	2.19 V	327	34.10	15.00
2	11650.00	35.2 AV	54.0	-18.8	2.19 V	327	20.20	15.00
3	#17475.00	56.5 PK	74.0	-17.5	2.05 V	34	35.39	21.11
4	#17475.00	41.5 AV	54.0	-12.5	2.05 V	34	20.39	21.11

REMARKS:

1. Emission Level(dBuV/m) = Raw Value(dBuV) + Correction Factor(dB/m)
2. Correction Factor(dB/m) = Antenna Factor(dB/m) + Cable Factor(dB) – Pre-Amplifier Factor(dB)
3. The other emission levels were very low against the limit.
4. Margin value = Emission Level – Limit value
5. " # ": The radiated frequency is out of the restricted band.



802.11n (20MHz)

CHANNEL	TX Channel 36	DETECTOR FUNCTION	Peak (PK)
FREQUENCY RANGE	1GHz ~ 40GHz		Average (AV)

ANTENNA POLARITY & TEST DISTANCE: HORIZONTAL AT 3 M

NO.	FREQ. (MHz)	EMISSION LEVEL (dBuV/m)	LIMIT (dBuV/m)	MARGIN (dB)	ANTENNA HEIGHT (m)	TABLE ANGLE (Degree)	RAW VALUE (dBuV)	CORRECTION FACTOR (dB/m)
1	#10360.00	47.4 PK	74.0	-26.6	1.52 H	220	33.75	13.65
2	#10360.00	35.8 AV	54.0	-18.2	1.52 H	220	22.15	13.65
3	15540.00	51.6 PK	74.0	-22.4	2.19 H	216	35.92	15.68
4	15540.00	41.4 AV	54.0	-12.6	2.19 H	216	25.72	15.68

ANTENNA POLARITY & TEST DISTANCE: VERTICAL AT 3 M

NO.	FREQ. (MHz)	EMISSION LEVEL (dBuV/m)	LIMIT (dBuV/m)	MARGIN (dB)	ANTENNA HEIGHT (m)	TABLE ANGLE (Degree)	RAW VALUE (dBuV)	CORRECTION FACTOR (dB/m)
1	#10360.00	49.7 PK	74.0	-24.3	2.11 V	335	36.05	13.65
2	#10360.00	35.6 AV	54.0	-18.4	2.11 V	335	21.95	13.65
3	15540.00	56.2 PK	74.0	-17.8	1.93 V	25	40.52	15.68
4	15540.00	41.5 AV	54.0	-12.5	1.93 V	25	25.82	15.68

REMARKS:

1. Emission Level(dBuV/m) = Raw Value(dBuV) + Correction Factor(dB/m)
2. Correction Factor(dB/m) = Antenna Factor(dB/m) + Cable Factor(dB) – Pre-Amplifier Factor(dB)
3. The other emission levels were very low against the limit.
4. Margin value = Emission Level – Limit value
5. " # ": The radiated frequency is out of the restricted band.



CHANNEL	TX Channel 40	DETECTOR FUNCTION	Peak (PK)
FREQUENCY RANGE	1GHz ~ 40GHz		Average (AV)

ANTENNA POLARITY & TEST DISTANCE: HORIZONTAL AT 3 M

NO.	FREQ. (MHz)	EMISSION LEVEL (dBuV/m)	LIMIT (dBuV/m)	MARGIN (dB)	ANTENNA HEIGHT (m)	TABLE ANGLE (Degree)	RAW VALUE (dBuV)	CORRECTION FACTOR (dB/m)
1	#10400.00	47.8 PK	74.0	-26.2	1.42 H	204	34.14	13.66
2	#10400.00	35.3 AV	54.0	-18.7	1.42 H	204	21.64	13.66
3	15600.00	51.8 PK	74.0	-22.2	2.20 H	243	36.14	15.66
4	15600.00	42.0 AV	54.0	-12.0	2.20 H	243	26.34	15.66

ANTENNA POLARITY & TEST DISTANCE: VERTICAL AT 3 M

NO.	FREQ. (MHz)	EMISSION LEVEL (dBuV/m)	LIMIT (dBuV/m)	MARGIN (dB)	ANTENNA HEIGHT (m)	TABLE ANGLE (Degree)	RAW VALUE (dBuV)	CORRECTION FACTOR (dB/m)
1	#10400.00	50.1 PK	74.0	-23.9	2.09 V	335	36.44	13.66
2	#10400.00	36.0 AV	54.0	-18.0	2.09 V	335	22.34	13.66
3	15600.00	55.8 PK	74.0	-18.2	1.99 V	24	40.14	15.66
4	15600.00	41.2 AV	54.0	-12.8	1.99 V	24	25.54	15.66

REMARKS:

1. Emission Level(dBuV/m) = Raw Value(dBuV) + Correction Factor(dB/m)
2. Correction Factor(dB/m) = Antenna Factor(dB/m) + Cable Factor(dB) – Pre-Amplifier Factor(dB)
3. The other emission levels were very low against the limit.
4. Margin value = Emission Level – Limit value
5. " # ": The radiated frequency is out of the restricted band.



CHANNEL	TX Channel 48	DETECTOR FUNCTION	Peak (PK)
FREQUENCY RANGE	1GHz ~ 40GHz		Average (AV)

ANTENNA POLARITY & TEST DISTANCE: HORIZONTAL AT 3 M

NO.	FREQ. (MHz)	EMISSION LEVEL (dBuV/m)	LIMIT (dBuV/m)	MARGIN (dB)	ANTENNA HEIGHT (m)	TABLE ANGLE (Degree)	RAW VALUE (dBuV)	CORRECTION FACTOR (dB/m)
1	#10480.00	47.9 PK	74.0	-26.1	1.41 H	225	33.89	14.01
2	#10480.00	36.2 AV	54.0	-17.8	1.41 H	225	22.19	14.01
3	15720.00	50.9 PK	74.0	-23.1	2.28 H	257	35.47	15.43
4	15720.00	41.1 AV	54.0	-12.9	2.28 H	257	25.67	15.43

ANTENNA POLARITY & TEST DISTANCE: VERTICAL AT 3 M

NO.	FREQ. (MHz)	EMISSION LEVEL (dBuV/m)	LIMIT (dBuV/m)	MARGIN (dB)	ANTENNA HEIGHT (m)	TABLE ANGLE (Degree)	RAW VALUE (dBuV)	CORRECTION FACTOR (dB/m)
1	#10480.00	50.0 PK	74.0	-24.0	2.10 V	323	35.99	14.01
2	#10480.00	35.9 AV	54.0	-18.1	2.10 V	323	21.89	14.01
3	15720.00	55.8 PK	74.0	-18.2	1.97 V	42	40.37	15.43
4	15720.00	41.0 AV	54.0	-13.0	1.97 V	42	25.57	15.43

REMARKS:

1. Emission Level(dBuV/m) = Raw Value(dBuV) + Correction Factor(dB/m)
2. Correction Factor(dB/m) = Antenna Factor(dB/m) + Cable Factor(dB) – Pre-Amplifier Factor(dB)
3. The other emission levels were very low against the limit.
4. Margin value = Emission Level – Limit value
5. "#": The radiated frequency is out of the restricted band.



CHANNEL	TX Channel 52	DETECTOR FUNCTION	Peak (PK)
FREQUENCY RANGE	1GHz ~ 40GHz		Average (AV)

ANTENNA POLARITY & TEST DISTANCE: HORIZONTAL AT 3 M

NO.	FREQ. (MHz)	EMISSION LEVEL (dBuV/m)	LIMIT (dBuV/m)	MARGIN (dB)	ANTENNA HEIGHT (m)	TABLE ANGLE (Degree)	RAW VALUE (dBuV)	CORRECTION FACTOR (dB/m)
1	#10520.00	48.2 PK	74.0	-25.8	1.41 H	227	34.06	14.14
2	#10520.00	36.3 AV	54.0	-17.7	1.41 H	227	22.16	14.14
3	15780.00	51.7 PK	74.0	-22.3	2.29 H	238	36.55	15.15
4	15780.00	42.0 AV	54.0	-12.0	2.29 H	238	26.85	15.15

ANTENNA POLARITY & TEST DISTANCE: VERTICAL AT 3 M

NO.	FREQ. (MHz)	EMISSION LEVEL (dBuV/m)	LIMIT (dBuV/m)	MARGIN (dB)	ANTENNA HEIGHT (m)	TABLE ANGLE (Degree)	RAW VALUE (dBuV)	CORRECTION FACTOR (dB/m)
1	#10520.00	50.1 PK	74.0	-23.9	2.19 V	332	35.96	14.14
2	#10520.00	35.7 AV	54.0	-18.3	2.19 V	332	21.56	14.14
3	15780.00	56.6 PK	74.0	-17.4	1.95 V	26	41.45	15.15
4	15780.00	41.6 AV	54.0	-12.4	1.95 V	26	26.45	15.15

REMARKS:

1. Emission Level(dBuV/m) = Raw Value(dBuV) + Correction Factor(dB/m)
2. Correction Factor(dB/m) = Antenna Factor(dB/m) + Cable Factor(dB) – Pre-Amplifier Factor(dB)
3. The other emission levels were very low against the limit.
4. Margin value = Emission Level – Limit value
5. "#": The radiated frequency is out of the restricted band.



CHANNEL	TX Channel 60	DETECTOR FUNCTION	Peak (PK)
FREQUENCY RANGE	1GHz ~ 40GHz		Average (AV)

ANTENNA POLARITY & TEST DISTANCE: HORIZONTAL AT 3 M

NO.	FREQ. (MHz)	EMISSION LEVEL (dBuV/m)	LIMIT (dBuV/m)	MARGIN (dB)	ANTENNA HEIGHT (m)	TABLE ANGLE (Degree)	RAW VALUE (dBuV)	CORRECTION FACTOR (dB/m)
1	10600.00	47.0 PK	74.0	-27.0	1.47 H	223	32.70	14.30
2	10600.00	35.5 AV	54.0	-18.5	1.47 H	223	21.20	14.30
3	15900.00	51.5 PK	74.0	-22.5	2.25 H	256	36.43	15.07
4	15900.00	41.6 AV	54.0	-12.4	2.25 H	256	26.53	15.07

ANTENNA POLARITY & TEST DISTANCE: VERTICAL AT 3 M

NO.	FREQ. (MHz)	EMISSION LEVEL (dBuV/m)	LIMIT (dBuV/m)	MARGIN (dB)	ANTENNA HEIGHT (m)	TABLE ANGLE (Degree)	RAW VALUE (dBuV)	CORRECTION FACTOR (dB/m)
1	10600.00	49.6 PK	74.0	-24.4	2.16 V	337	35.30	14.30
2	10600.00	35.3 AV	54.0	-18.7	2.16 V	337	21.00	14.30
3	15900.00	56.6 PK	74.0	-17.4	1.99 V	22	41.53	15.07
4	15900.00	42.0 AV	54.0	-12.0	1.99 V	22	26.93	15.07

REMARKS:

1. Emission Level(dBuV/m) = Raw Value(dBuV) + Correction Factor(dB/m)
2. Correction Factor(dB/m) = Antenna Factor(dB/m) + Cable Factor(dB) – Pre-Amplifier Factor(dB)
3. The other emission levels were very low against the limit.
4. Margin value = Emission Level – Limit value



CHANNEL	TX Channel 64	DETECTOR FUNCTION	Peak (PK)
FREQUENCY RANGE	1GHz ~ 40GHz		Average (AV)

ANTENNA POLARITY & TEST DISTANCE: HORIZONTAL AT 3 M

NO.	FREQ. (MHz)	EMISSION LEVEL (dBuV/m)	LIMIT (dBuV/m)	MARGIN (dB)	ANTENNA HEIGHT (m)	TABLE ANGLE (Degree)	RAW VALUE (dBuV)	CORRECTION FACTOR (dB/m)
1	10640.00	47.2 PK	74.0	-26.8	1.52 H	235	32.84	14.36
2	10640.00	35.8 AV	54.0	-18.2	1.52 H	235	21.44	14.36
3	15960.00	50.9 PK	74.0	-23.1	2.17 H	247	35.82	15.08
4	15960.00	40.7 AV	54.0	-13.3	2.17 H	247	25.62	15.08

ANTENNA POLARITY & TEST DISTANCE: VERTICAL AT 3 M

NO.	FREQ. (MHz)	EMISSION LEVEL (dBuV/m)	LIMIT (dBuV/m)	MARGIN (dB)	ANTENNA HEIGHT (m)	TABLE ANGLE (Degree)	RAW VALUE (dBuV)	CORRECTION FACTOR (dB/m)
1	10640.00	50.2 PK	74.0	-23.8	2.13 V	318	35.84	14.36
2	10640.00	35.8 AV	54.0	-18.2	2.13 V	318	21.44	14.36
3	15960.00	56.0 PK	74.0	-18.0	2.04 V	45	40.92	15.08
4	15960.00	41.2 AV	54.0	-12.8	2.04 V	45	26.12	15.08

REMARKS:

1. Emission Level(dBuV/m) = Raw Value(dBuV) + Correction Factor(dB/m)
2. Correction Factor(dB/m) = Antenna Factor(dB/m) + Cable Factor(dB) – Pre-Amplifier Factor(dB)
3. The other emission levels were very low against the limit.
4. Margin value = Emission Level – Limit value



CHANNEL	TX Channel 100	DETECTOR FUNCTION	Peak (PK)
FREQUENCY RANGE	1GHz ~ 40GHz		Average (AV)

ANTENNA POLARITY & TEST DISTANCE: HORIZONTAL AT 3 M

NO.	FREQ. (MHz)	EMISSION LEVEL (dBuV/m)	LIMIT (dBuV/m)	MARGIN (dB)	ANTENNA HEIGHT (m)	TABLE ANGLE (Degree)	RAW VALUE (dBuV)	CORRECTION FACTOR (dB/m)
1	11000.00	47.3 PK	74.0	-26.7	1.47 H	236	32.13	15.17
2	11000.00	35.8 AV	54.0	-18.2	1.47 H	236	20.63	15.17
3	#16500.00	50.8 PK	74.0	-23.2	2.18 H	221	33.44	17.36
4	#16500.00	40.8 AV	54.0	-13.2	2.18 H	221	23.44	17.36

ANTENNA POLARITY & TEST DISTANCE: VERTICAL AT 3 M

NO.	FREQ. (MHz)	EMISSION LEVEL (dBuV/m)	LIMIT (dBuV/m)	MARGIN (dB)	ANTENNA HEIGHT (m)	TABLE ANGLE (Degree)	RAW VALUE (dBuV)	CORRECTION FACTOR (dB/m)
1	11000.00	50.2 PK	74.0	-23.8	2.12 V	310	35.03	15.17
2	11000.00	35.8 AV	54.0	-18.2	2.12 V	310	20.63	15.17
3	#16500.00	56.6 PK	74.0	-17.4	2.04 V	34	39.24	17.36
4	#16500.00	41.8 AV	54.0	-12.2	2.04 V	34	24.44	17.36

REMARKS:

1. Emission Level(dBuV/m) = Raw Value(dBuV) + Correction Factor(dB/m)
2. Correction Factor(dB/m) = Antenna Factor(dB/m) + Cable Factor(dB) – Pre-Amplifier Factor(dB)
3. The other emission levels were very low against the limit.
4. Margin value = Emission Level – Limit value
5. " # ": The radiated frequency is out of the restricted band.



CHANNEL	TX Channel 116	DETECTOR FUNCTION	Peak (PK)
FREQUENCY RANGE	1GHz ~ 40GHz		Average (AV)

ANTENNA POLARITY & TEST DISTANCE: HORIZONTAL AT 3 M

NO.	FREQ. (MHz)	EMISSION LEVEL (dBuV/m)	LIMIT (dBuV/m)	MARGIN (dB)	ANTENNA HEIGHT (m)	TABLE ANGLE (Degree)	RAW VALUE (dBuV)	CORRECTION FACTOR (dB/m)
1	11160.00	47.0 PK	74.0	-27.0	1.42 H	205	31.78	15.22
2	11160.00	35.3 AV	54.0	-18.7	1.42 H	205	20.08	15.22
3	#16740.00	51.3 PK	74.0	-22.7	2.23 H	259	32.97	18.33
4	#16740.00	41.6 AV	54.0	-12.4	2.23 H	259	23.27	18.33

ANTENNA POLARITY & TEST DISTANCE: VERTICAL AT 3 M

NO.	FREQ. (MHz)	EMISSION LEVEL (dBuV/m)	LIMIT (dBuV/m)	MARGIN (dB)	ANTENNA HEIGHT (m)	TABLE ANGLE (Degree)	RAW VALUE (dBuV)	CORRECTION FACTOR (dB/m)
1	11160.00	50.1 PK	74.0	-23.9	2.16 V	331	34.88	15.22
2	11160.00	36.0 AV	54.0	-18.0	2.16 V	331	20.78	15.22
3	#16740.00	56.6 PK	74.0	-17.4	2.00 V	25	38.27	18.33
4	#16740.00	41.5 AV	54.0	-12.5	2.00 V	25	23.17	18.33

REMARKS:

1. Emission Level(dBuV/m) = Raw Value(dBuV) + Correction Factor(dB/m)
2. Correction Factor(dB/m) = Antenna Factor(dB/m) + Cable Factor(dB) – Pre-Amplifier Factor(dB)
3. The other emission levels were very low against the limit.
4. Margin value = Emission Level – Limit value
5. " # ": The radiated frequency is out of the restricted band.



CHANNEL	TX Channel 140	DETECTOR FUNCTION	Peak (PK)
FREQUENCY RANGE	1GHz ~ 40GHz		Average (AV)

ANTENNA POLARITY & TEST DISTANCE: HORIZONTAL AT 3 M

NO.	FREQ. (MHz)	EMISSION LEVEL (dBuV/m)	LIMIT (dBuV/m)	MARGIN (dB)	ANTENNA HEIGHT (m)	TABLE ANGLE (Degree)	RAW VALUE (dBuV)	CORRECTION FACTOR (dB/m)
1	11400.00	46.9 PK	74.0	-27.1	1.43 H	228	31.45	15.45
2	11400.00	35.6 AV	54.0	-18.4	1.43 H	228	20.15	15.45
3	#17100.00	51.9 PK	74.0	-22.1	2.19 H	242	31.84	20.06
4	#17100.00	41.4 AV	54.0	-12.6	2.19 H	242	21.34	20.06

ANTENNA POLARITY & TEST DISTANCE: VERTICAL AT 3 M

NO.	FREQ. (MHz)	EMISSION LEVEL (dBuV/m)	LIMIT (dBuV/m)	MARGIN (dB)	ANTENNA HEIGHT (m)	TABLE ANGLE (Degree)	RAW VALUE (dBuV)	CORRECTION FACTOR (dB/m)
1	11400.00	50.2 PK	74.0	-23.8	2.18 V	340	34.75	15.45
2	11400.00	35.9 AV	54.0	-18.1	2.18 V	340	20.45	15.45
3	#17100.00	56.5 PK	74.0	-17.5	1.94 V	20	36.44	20.06
4	#17100.00	41.5 AV	54.0	-12.5	1.94 V	20	21.44	20.06

REMARKS:

1. Emission Level(dBuV/m) = Raw Value(dBuV) + Correction Factor(dB/m)
2. Correction Factor(dB/m) = Antenna Factor(dB/m) + Cable Factor(dB) – Pre-Amplifier Factor(dB)
3. The other emission levels were very low against the limit.
4. Margin value = Emission Level – Limit value
5. " # ": The radiated frequency is out of the restricted band.



CHANNEL	TX Channel 149	DETECTOR FUNCTION	Peak (PK)
FREQUENCY RANGE	1GHz ~ 40GHz		Average (AV)

ANTENNA POLARITY & TEST DISTANCE: HORIZONTAL AT 3 M

NO.	FREQ. (MHz)	EMISSION LEVEL (dBuV/m)	LIMIT (dBuV/m)	MARGIN (dB)	ANTENNA HEIGHT (m)	TABLE ANGLE (Degree)	RAW VALUE (dBuV)	CORRECTION FACTOR (dB/m)
1	11490.00	47.3 PK	74.0	-26.7	1.52 H	208	32.13	15.17
2	11490.00	35.5 AV	54.0	-18.5	1.52 H	208	20.33	15.17
3	#17235.00	51.8 PK	74.0	-22.2	2.25 H	241	31.90	19.90
4	#17235.00	41.7 AV	54.0	-12.3	2.25 H	241	21.80	19.90

ANTENNA POLARITY & TEST DISTANCE: VERTICAL AT 3 M

NO.	FREQ. (MHz)	EMISSION LEVEL (dBuV/m)	LIMIT (dBuV/m)	MARGIN (dB)	ANTENNA HEIGHT (m)	TABLE ANGLE (Degree)	RAW VALUE (dBuV)	CORRECTION FACTOR (dB/m)
1	11490.00	49.7 PK	74.0	-24.3	2.12 V	327	34.53	15.17
2	11490.00	35.4 AV	54.0	-18.6	2.12 V	327	20.23	15.17
3	#17235.00	55.5 PK	74.0	-18.5	2.01 V	20	35.60	19.90
4	#17235.00	41.0 AV	54.0	-13.0	2.01 V	20	21.10	19.90

REMARKS:

1. Emission Level(dBuV/m) = Raw Value(dBuV) + Correction Factor(dB/m)
2. Correction Factor(dB/m) = Antenna Factor(dB/m) + Cable Factor(dB) – Pre-Amplifier Factor(dB)
3. The other emission levels were very low against the limit.
4. Margin value = Emission Level – Limit value
5. " # ": The radiated frequency is out of the restricted band.



CHANNEL	TX Channel 157	DETECTOR FUNCTION	Peak (PK)
FREQUENCY RANGE	1GHz ~ 40GHz		Average (AV)

ANTENNA POLARITY & TEST DISTANCE: HORIZONTAL AT 3 M

NO.	FREQ. (MHz)	EMISSION LEVEL (dBuV/m)	LIMIT (dBuV/m)	MARGIN (dB)	ANTENNA HEIGHT (m)	TABLE ANGLE (Degree)	RAW VALUE (dBuV)	CORRECTION FACTOR (dB/m)
1	11570.00	47.4 PK	74.0	-26.6	1.42 H	232	32.28	15.12
2	11570.00	36.0 AV	54.0	-18.0	1.42 H	232	20.88	15.12
3	#17355.00	51.2 PK	74.0	-22.8	2.30 H	240	30.76	20.44
4	#17355.00	41.1 AV	54.0	-12.9	2.30 H	240	20.66	20.44

ANTENNA POLARITY & TEST DISTANCE: VERTICAL AT 3 M

NO.	FREQ. (MHz)	EMISSION LEVEL (dBuV/m)	LIMIT (dBuV/m)	MARGIN (dB)	ANTENNA HEIGHT (m)	TABLE ANGLE (Degree)	RAW VALUE (dBuV)	CORRECTION FACTOR (dB/m)
1	11570.00	49.7 PK	74.0	-24.3	2.16 V	337	34.58	15.12
2	11570.00	35.3 AV	54.0	-18.7	2.16 V	337	20.18	15.12
3	#17355.00	56.3 PK	74.0	-17.7	2.00 V	26	35.86	20.44
4	#17355.00	41.8 AV	54.0	-12.2	2.00 V	26	21.36	20.44

REMARKS:

1. Emission Level(dBuV/m) = Raw Value(dBuV) + Correction Factor(dB/m)
2. Correction Factor(dB/m) = Antenna Factor(dB/m) + Cable Factor(dB) – Pre-Amplifier Factor(dB)
3. The other emission levels were very low against the limit.
4. Margin value = Emission Level – Limit value
5. " # ": The radiated frequency is out of the restricted band.



CHANNEL	TX Channel 165	DETECTOR FUNCTION	Peak (PK)
FREQUENCY RANGE	1GHz ~ 40GHz		Average (AV)

ANTENNA POLARITY & TEST DISTANCE: HORIZONTAL AT 3 M

NO.	FREQ. (MHz)	EMISSION LEVEL (dBuV/m)	LIMIT (dBuV/m)	MARGIN (dB)	ANTENNA HEIGHT (m)	TABLE ANGLE (Degree)	RAW VALUE (dBuV)	CORRECTION FACTOR (dB/m)
1	11650.00	47.6 PK	74.0	-26.4	1.47 H	231	32.60	15.00
2	11650.00	35.9 AV	54.0	-18.1	1.47 H	231	20.90	15.00
3	#17475.00	51.9 PK	74.0	-22.1	2.26 H	240	30.79	21.11
4	#17475.00	41.7 AV	54.0	-12.3	2.26 H	240	20.59	21.11

ANTENNA POLARITY & TEST DISTANCE: VERTICAL AT 3 M

NO.	FREQ. (MHz)	EMISSION LEVEL (dBuV/m)	LIMIT (dBuV/m)	MARGIN (dB)	ANTENNA HEIGHT (m)	TABLE ANGLE (Degree)	RAW VALUE (dBuV)	CORRECTION FACTOR (dB/m)
1	11650.00	49.9 PK	74.0	-24.1	2.12 V	313	34.90	15.00
2	11650.00	35.6 AV	54.0	-18.4	2.12 V	313	20.60	15.00
3	#17475.00	56.7 PK	74.0	-17.3	2.01 V	36	35.59	21.11
4	#17475.00	41.8 AV	54.0	-12.2	2.01 V	36	20.69	21.11

REMARKS:

1. Emission Level(dBuV/m) = Raw Value(dBuV) + Correction Factor(dB/m)
2. Correction Factor(dB/m) = Antenna Factor(dB/m) + Cable Factor(dB) – Pre-Amplifier Factor(dB)
3. The other emission levels were very low against the limit.
4. Margin value = Emission Level – Limit value
5. " # ": The radiated frequency is out of the restricted band.

802.11n (40MHz)

CHANNEL	TX Channel 38	DETECTOR FUNCTION	Peak (PK)
FREQUENCY RANGE	1GHz ~ 40GHz		Average (AV)

ANTENNA POLARITY & TEST DISTANCE: HORIZONTAL AT 3 M

NO.	FREQ. (MHz)	EMISSION LEVEL (dBuV/m)	LIMIT (dBuV/m)	MARGIN (dB)	ANTENNA HEIGHT (m)	TABLE ANGLE (Degree)	RAW VALUE (dBuV)	CORRECTION FACTOR (dB/m)
1	#10380.00	49.2 PK	74.0	-24.8	1.03 H	328	35.54	13.66
2	#10380.00	36.4 AV	54.0	-17.6	1.03 H	328	22.74	13.66
3	15570.00	50.4 PK	74.0	-23.6	1.17 H	14	34.73	15.67
4	15570.00	40.2 AV	54.0	-13.8	1.17 H	14	24.53	15.67

ANTENNA POLARITY & TEST DISTANCE: VERTICAL AT 3 M

NO.	FREQ. (MHz)	EMISSION LEVEL (dBuV/m)	LIMIT (dBuV/m)	MARGIN (dB)	ANTENNA HEIGHT (m)	TABLE ANGLE (Degree)	RAW VALUE (dBuV)	CORRECTION FACTOR (dB/m)
1	#10380.00	48.6 PK	74.0	-25.4	1.05 V	33	34.94	13.66
2	#10380.00	35.7 AV	54.0	-18.3	1.05 V	33	22.04	13.66
3	15570.00	50.9 PK	74.0	-23.1	1.38 V	138	35.23	15.67
4	15570.00	39.9 AV	54.0	-14.1	1.38 V	138	24.23	15.67

REMARKS:

1. Emission Level(dBuV/m) = Raw Value(dBuV) + Correction Factor(dB/m)
2. Correction Factor(dB/m) = Antenna Factor(dB/m) + Cable Factor(dB) – Pre-Amplifier Factor(dB)
3. The other emission levels were very low against the limit.
4. Margin value = Emission Level – Limit value
5. " # ": The radiated frequency is out of the restricted band.



CHANNEL	TX Channel 46	DETECTOR FUNCTION	Peak (PK)
FREQUENCY RANGE	1GHz ~ 40GHz		Average (AV)

ANTENNA POLARITY & TEST DISTANCE: HORIZONTAL AT 3 M

NO.	FREQ. (MHz)	EMISSION LEVEL (dBuV/m)	LIMIT (dBuV/m)	MARGIN (dB)	ANTENNA HEIGHT (m)	TABLE ANGLE (Degree)	RAW VALUE (dBuV)	CORRECTION FACTOR (dB/m)
1	#10460.00	49.2 PK	74.0	-24.8	1.05 H	314	35.28	13.92
2	#10460.00	36.3 AV	54.0	-17.7	1.05 H	314	22.38	13.92
3	15690.00	49.9 PK	74.0	-24.1	1.17 H	1	34.36	15.54
4	15690.00	39.4 AV	54.0	-14.6	1.17 H	1	23.86	15.54

ANTENNA POLARITY & TEST DISTANCE: VERTICAL AT 3 M

NO.	FREQ. (MHz)	EMISSION LEVEL (dBuV/m)	LIMIT (dBuV/m)	MARGIN (dB)	ANTENNA HEIGHT (m)	TABLE ANGLE (Degree)	RAW VALUE (dBuV)	CORRECTION FACTOR (dB/m)
1	#10460.00	48.4 PK	74.0	-25.6	1.00 V	30	34.48	13.92
2	#10460.00	35.5 AV	54.0	-18.5	1.00 V	30	21.58	13.92
3	15690.00	50.9 PK	74.0	-23.1	1.40 V	150	35.36	15.54
4	15690.00	39.7 AV	54.0	-14.3	1.40 V	150	24.16	15.54

REMARKS:

1. Emission Level(dBuV/m) = Raw Value(dBuV) + Correction Factor(dB/m)
2. Correction Factor(dB/m) = Antenna Factor(dB/m) + Cable Factor(dB) – Pre-Amplifier Factor(dB)
3. The other emission levels were very low against the limit.
4. Margin value = Emission Level – Limit value
5. "#": The radiated frequency is out of the restricted band.



CHANNEL	TX Channel 54	DETECTOR FUNCTION	Peak (PK)
FREQUENCY RANGE	1GHz ~ 40GHz		Average (AV)

ANTENNA POLARITY & TEST DISTANCE: HORIZONTAL AT 3 M

NO.	FREQ. (MHz)	EMISSION LEVEL (dBuV/m)	LIMIT (dBuV/m)	MARGIN (dB)	ANTENNA HEIGHT (m)	TABLE ANGLE (Degree)	RAW VALUE (dBuV)	CORRECTION FACTOR (dB/m)
1	#10540.00	48.7 PK	74.0	-25.3	1.08 H	326	34.52	14.18
2	#10540.00	35.7 AV	54.0	-18.3	1.08 H	326	21.52	14.18
3	15810.00	50.1 PK	74.0	-23.9	1.17 H	0	35.05	15.05
4	15810.00	39.7 AV	54.0	-14.3	1.17 H	0	24.65	15.05

ANTENNA POLARITY & TEST DISTANCE: VERTICAL AT 3 M

NO.	FREQ. (MHz)	EMISSION LEVEL (dBuV/m)	LIMIT (dBuV/m)	MARGIN (dB)	ANTENNA HEIGHT (m)	TABLE ANGLE (Degree)	RAW VALUE (dBuV)	CORRECTION FACTOR (dB/m)
1	#10540.00	49.3 PK	74.0	-24.7	1.02 V	20	35.12	14.18
2	#10540.00	36.1 AV	54.0	-17.9	1.02 V	20	21.92	14.18
3	15810.00	50.6 PK	74.0	-23.4	1.32 V	160	35.55	15.05
4	15810.00	39.6 AV	54.0	-14.4	1.32 V	160	24.55	15.05

REMARKS:

1. Emission Level(dBuV/m) = Raw Value(dBuV) + Correction Factor(dB/m)
2. Correction Factor(dB/m) = Antenna Factor(dB/m) + Cable Factor(dB) – Pre-Amplifier Factor(dB)
3. The other emission levels were very low against the limit.
4. Margin value = Emission Level – Limit value
5. "#": The radiated frequency is out of the restricted band.



CHANNEL	TX Channel 62	DETECTOR FUNCTION	Peak (PK)
FREQUENCY RANGE	1GHz ~ 40GHz		Average (AV)

ANTENNA POLARITY & TEST DISTANCE: HORIZONTAL AT 3 M

NO.	FREQ. (MHz)	EMISSION LEVEL (dBuV/m)	LIMIT (dBuV/m)	MARGIN (dB)	ANTENNA HEIGHT (m)	TABLE ANGLE (Degree)	RAW VALUE (dBuV)	CORRECTION FACTOR (dB/m)
1	10620.00	49.1 PK	74.0	-24.9	1.07 H	320	34.77	14.33
2	10620.00	36.1 AV	54.0	-17.9	1.07 H	320	21.77	14.33
3	15930.00	49.9 PK	74.0	-24.1	1.18 H	14	34.82	15.08
4	15930.00	39.6 AV	54.0	-14.4	1.18 H	14	24.52	15.08

ANTENNA POLARITY & TEST DISTANCE: VERTICAL AT 3 M

NO.	FREQ. (MHz)	EMISSION LEVEL (dBuV/m)	LIMIT (dBuV/m)	MARGIN (dB)	ANTENNA HEIGHT (m)	TABLE ANGLE (Degree)	RAW VALUE (dBuV)	CORRECTION FACTOR (dB/m)
1	10620.00	49.2 PK	74.0	-24.8	1.09 V	6	34.87	14.33
2	10620.00	36.2 AV	54.0	-17.8	1.09 V	6	21.87	14.33
3	15930.00	50.3 PK	74.0	-23.7	1.31 V	151	35.22	15.08
4	15930.00	39.3 AV	54.0	-14.7	1.31 V	151	24.22	15.08

REMARKS:

1. Emission Level(dBuV/m) = Raw Value(dBuV) + Correction Factor(dB/m)
2. Correction Factor(dB/m) = Antenna Factor(dB/m) + Cable Factor(dB) – Pre-Amplifier Factor(dB)
3. The other emission levels were very low against the limit.
4. Margin value = Emission Level – Limit value



CHANNEL	TX Channel 102	DETECTOR FUNCTION	Peak (PK)
FREQUENCY RANGE	1GHz ~ 40GHz		Average (AV)

ANTENNA POLARITY & TEST DISTANCE: HORIZONTAL AT 3 M

NO.	FREQ. (MHz)	EMISSION LEVEL (dBuV/m)	LIMIT (dBuV/m)	MARGIN (dB)	ANTENNA HEIGHT (m)	TABLE ANGLE (Degree)	RAW VALUE (dBuV)	CORRECTION FACTOR (dB/m)
1	11020.00	49.2 PK	74.0	-24.8	1.02 H	296	34.03	15.17
2	11020.00	36.4 AV	54.0	-17.6	1.02 H	296	21.23	15.17
3	#16530.00	50.7 PK	74.0	-23.3	1.15 H	12	33.23	17.47
4	#16530.00	40.1 AV	54.0	-13.9	1.15 H	12	22.63	17.47

ANTENNA POLARITY & TEST DISTANCE: VERTICAL AT 3 M

NO.	FREQ. (MHz)	EMISSION LEVEL (dBuV/m)	LIMIT (dBuV/m)	MARGIN (dB)	ANTENNA HEIGHT (m)	TABLE ANGLE (Degree)	RAW VALUE (dBuV)	CORRECTION FACTOR (dB/m)
1	11020.00	48.8 PK	74.0	-25.2	1.08 V	24	33.63	15.17
2	11020.00	35.6 AV	54.0	-18.4	1.08 V	24	20.43	15.17
3	#16530.00	50.3 PK	74.0	-23.7	1.31 V	165	32.83	17.47
4	#16530.00	39.2 AV	54.0	-14.8	1.31 V	165	21.73	17.47

REMARKS:

1. Emission Level(dBuV/m) = Raw Value(dBuV) + Correction Factor(dB/m)
2. Correction Factor(dB/m) = Antenna Factor(dB/m) + Cable Factor(dB) – Pre-Amplifier Factor(dB)
3. The other emission levels were very low against the limit.
4. Margin value = Emission Level – Limit value
5. " # ": The radiated frequency is out of the restricted band.



CHANNEL	TX Channel 110	DETECTOR FUNCTION	Peak (PK)
FREQUENCY RANGE	1GHz ~ 40GHz		Average (AV)

ANTENNA POLARITY & TEST DISTANCE: HORIZONTAL AT 3 M

NO.	FREQ. (MHz)	EMISSION LEVEL (dBuV/m)	LIMIT (dBuV/m)	MARGIN (dB)	ANTENNA HEIGHT (m)	TABLE ANGLE (Degree)	RAW VALUE (dBuV)	CORRECTION FACTOR (dB/m)
1	11100.00	48.4 PK	74.0	-25.6	1.06 H	328	33.23	15.17
2	11100.00	35.8 AV	54.0	-18.2	1.06 H	328	20.63	15.17
3	#16650.00	50.7 PK	74.0	-23.3	1.26 H	0	32.66	18.04
4	#16650.00	40.1 AV	54.0	-13.9	1.26 H	0	22.06	18.04

ANTENNA POLARITY & TEST DISTANCE: VERTICAL AT 3 M

NO.	FREQ. (MHz)	EMISSION LEVEL (dBuV/m)	LIMIT (dBuV/m)	MARGIN (dB)	ANTENNA HEIGHT (m)	TABLE ANGLE (Degree)	RAW VALUE (dBuV)	CORRECTION FACTOR (dB/m)
1	11100.00	49.4 PK	74.0	-24.6	1.10 V	15	34.23	15.17
2	11100.00	36.1 AV	54.0	-17.9	1.10 V	15	20.93	15.17
3	#16650.00	50.9 PK	74.0	-23.1	1.32 V	154	32.86	18.04
4	#16650.00	39.9 AV	54.0	-14.1	1.32 V	154	21.86	18.04

REMARKS:

1. Emission Level(dBuV/m) = Raw Value(dBuV) + Correction Factor(dB/m)
2. Correction Factor(dB/m) = Antenna Factor(dB/m) + Cable Factor(dB) – Pre-Amplifier Factor(dB)
3. The other emission levels were very low against the limit.
4. Margin value = Emission Level – Limit value
5. " # ": The radiated frequency is out of the restricted band.



CHANNEL	TX Channel 134	DETECTOR FUNCTION	Peak (PK)
FREQUENCY RANGE	1GHz ~ 40GHz		Average (AV)

ANTENNA POLARITY & TEST DISTANCE: HORIZONTAL AT 3 M

NO.	FREQ. (MHz)	EMISSION LEVEL (dBuV/m)	LIMIT (dBuV/m)	MARGIN (dB)	ANTENNA HEIGHT (m)	TABLE ANGLE (Degree)	RAW VALUE (dBuV)	CORRECTION FACTOR (dB/m)
1	11340.00	48.8 PK	74.0	-25.2	1.04 H	305	33.51	15.29
2	11340.00	35.7 AV	54.0	-18.3	1.04 H	305	20.41	15.29
3	#17010.00	50.3 PK	74.0	-23.7	1.17 H	12	30.37	19.93
4	#17010.00	39.5 AV	54.0	-14.5	1.17 H	12	19.57	19.93

ANTENNA POLARITY & TEST DISTANCE: VERTICAL AT 3 M

NO.	FREQ. (MHz)	EMISSION LEVEL (dBuV/m)	LIMIT (dBuV/m)	MARGIN (dB)	ANTENNA HEIGHT (m)	TABLE ANGLE (Degree)	RAW VALUE (dBuV)	CORRECTION FACTOR (dB/m)
1	11340.00	48.9 PK	74.0	-25.1	1.08 V	19	33.61	15.29
2	11340.00	35.8 AV	54.0	-18.2	1.08 V	19	20.51	15.29
3	#17010.00	50.8 PK	74.0	-23.2	1.41 V	144	30.87	19.93
4	#17010.00	39.5 AV	54.0	-14.5	1.41 V	144	19.57	19.93

REMARKS:

1. Emission Level(dBuV/m) = Raw Value(dBuV) + Correction Factor(dB/m)
2. Correction Factor(dB/m) = Antenna Factor(dB/m) + Cable Factor(dB) – Pre-Amplifier Factor(dB)
3. The other emission levels were very low against the limit.
4. Margin value = Emission Level – Limit value
5. " # ": The radiated frequency is out of the restricted band.



CHANNEL	TX Channel 151	DETECTOR FUNCTION	Peak (PK)
FREQUENCY RANGE	1GHz ~ 40GHz		Average (AV)

ANTENNA POLARITY & TEST DISTANCE: HORIZONTAL AT 3 M

NO.	FREQ. (MHz)	EMISSION LEVEL (dBuV/m)	LIMIT (dBuV/m)	MARGIN (dB)	ANTENNA HEIGHT (m)	TABLE ANGLE (Degree)	RAW VALUE (dBuV)	CORRECTION FACTOR (dB/m)
1	11510.00	49.3 PK	74.0	-24.7	1.12 H	308	34.16	15.14
2	11510.00	36.4 AV	54.0	-17.6	1.12 H	308	21.26	15.14
3	#17265.00	50.1 PK	74.0	-23.9	1.20 H	0	30.11	19.99
4	#17265.00	39.9 AV	54.0	-14.1	1.20 H	0	19.91	19.99

ANTENNA POLARITY & TEST DISTANCE: VERTICAL AT 3 M

NO.	FREQ. (MHz)	EMISSION LEVEL (dBuV/m)	LIMIT (dBuV/m)	MARGIN (dB)	ANTENNA HEIGHT (m)	TABLE ANGLE (Degree)	RAW VALUE (dBuV)	CORRECTION FACTOR (dB/m)
1	11510.00	49.2 PK	74.0	-24.8	1.03 V	12	34.06	15.14
2	11510.00	35.9 AV	54.0	-18.1	1.03 V	12	20.76	15.14
3	#17265.00	50.8 PK	74.0	-23.2	1.39 V	159	30.81	19.99
4	#17265.00	39.4 AV	54.0	-14.6	1.39 V	159	19.41	19.99

REMARKS:

1. Emission Level(dBuV/m) = Raw Value(dBuV) + Correction Factor(dB/m)
2. Correction Factor(dB/m) = Antenna Factor(dB/m) + Cable Factor(dB) – Pre-Amplifier Factor(dB)
3. The other emission levels were very low against the limit.
4. Margin value = Emission Level – Limit value
5. " # ": The radiated frequency is out of the restricted band.



CHANNEL	TX Channel 159	DETECTOR FUNCTION	Peak (PK)
FREQUENCY RANGE	1GHz ~ 40GHz		Average (AV)

ANTENNA POLARITY & TEST DISTANCE: HORIZONTAL AT 3 M

NO.	FREQ. (MHz)	EMISSION LEVEL (dBuV/m)	LIMIT (dBuV/m)	MARGIN (dB)	ANTENNA HEIGHT (m)	TABLE ANGLE (Degree)	RAW VALUE (dBuV)	CORRECTION FACTOR (dB/m)
1	11590.00	48.8 PK	74.0	-25.2	1.03 H	305	33.69	15.11
2	11590.00	36.2 AV	54.0	-17.8	1.03 H	305	21.09	15.11
3	#17385.00	50.1 PK	74.0	-23.9	1.27 H	3	29.48	20.62
4	#17385.00	39.6 AV	54.0	-14.4	1.27 H	3	18.98	20.62

ANTENNA POLARITY & TEST DISTANCE: VERTICAL AT 3 M

NO.	FREQ. (MHz)	EMISSION LEVEL (dBuV/m)	LIMIT (dBuV/m)	MARGIN (dB)	ANTENNA HEIGHT (m)	TABLE ANGLE (Degree)	RAW VALUE (dBuV)	CORRECTION FACTOR (dB/m)
1	11590.00	48.9 PK	74.0	-25.1	1.08 V	35	33.79	15.11
2	11590.00	35.8 AV	54.0	-18.2	1.08 V	35	20.69	15.11
3	#17385.00	50.7 PK	74.0	-23.3	1.38 V	158	30.08	20.62
4	#17385.00	39.8 AV	54.0	-14.2	1.38 V	158	19.18	20.62

REMARKS:

1. Emission Level(dBuV/m) = Raw Value(dBuV) + Correction Factor(dB/m)
2. Correction Factor(dB/m) = Antenna Factor(dB/m) + Cable Factor(dB) – Pre-Amplifier Factor(dB)
3. The other emission levels were very low against the limit.
4. Margin value = Emission Level – Limit value
5. " # ": The radiated frequency is out of the restricted band.



2TX

802.11a

CHANNEL	TX Channel 36	DETECTOR FUNCTION	Peak (PK)
FREQUENCY RANGE	1GHz ~ 40GHz		Average (AV)

ANTENNA POLARITY & TEST DISTANCE: HORIZONTAL AT 3 M

NO.	FREQ. (MHz)	EMISSION LEVEL (dBuV/m)	LIMIT (dBuV/m)	MARGIN (dB)	ANTENNA HEIGHT (m)	TABLE ANGLE (Degree)	RAW VALUE (dBuV)	CORRECTION FACTOR (dB/m)
1	#10360.00	49.4 PK	74.0	-24.6	2.29 H	247	35.75	13.65
2	#10360.00	35.8 AV	54.0	-18.2	2.29 H	247	22.15	13.65
3	15540.00	55.1 PK	74.0	-18.9	1.80 H	41	39.42	15.68
4	15540.00	41.5 AV	54.0	-12.5	1.80 H	41	25.82	15.68

ANTENNA POLARITY & TEST DISTANCE: VERTICAL AT 3 M

NO.	FREQ. (MHz)	EMISSION LEVEL (dBuV/m)	LIMIT (dBuV/m)	MARGIN (dB)	ANTENNA HEIGHT (m)	TABLE ANGLE (Degree)	RAW VALUE (dBuV)	CORRECTION FACTOR (dB/m)
1	#10360.00	49.7 PK	74.0	-24.3	1.07 V	301	36.05	13.65
2	#10360.00	36.3 AV	54.0	-17.7	1.07 V	301	22.65	13.65
3	15540.00	50.4 PK	74.0	-23.6	1.23 V	14	34.72	15.68
4	15540.00	39.7 AV	54.0	-14.3	1.23 V	14	24.02	15.68

REMARKS:

1. Emission Level(dBuV/m) = Raw Value(dBuV) + Correction Factor(dB/m)
2. Correction Factor(dB/m) = Antenna Factor(dB/m) + Cable Factor(dB) – Pre-Amplifier Factor(dB)
3. The other emission levels were very low against the limit.
4. Margin value = Emission Level – Limit value
5. " # ": The radiated frequency is out of the restricted band.



CHANNEL	TX Channel 40	DETECTOR FUNCTION	Peak (PK)
FREQUENCY RANGE	1GHz ~ 40GHz		Average (AV)

ANTENNA POLARITY & TEST DISTANCE: HORIZONTAL AT 3 M

NO.	FREQ. (MHz)	EMISSION LEVEL (dBuV/m)	LIMIT (dBuV/m)	MARGIN (dB)	ANTENNA HEIGHT (m)	TABLE ANGLE (Degree)	RAW VALUE (dBuV)	CORRECTION FACTOR (dB/m)
1	#10400.00	49.2 PK	74.0	-24.8	2.23 H	242	35.54	13.66
2	#10400.00	35.6 AV	54.0	-18.4	2.23 H	242	21.94	13.66
3	15600.00	55.1 PK	74.0	-18.9	1.77 H	22	39.44	15.66
4	15600.00	41.6 AV	54.0	-12.4	1.77 H	22	25.94	15.66

ANTENNA POLARITY & TEST DISTANCE: VERTICAL AT 3 M

NO.	FREQ. (MHz)	EMISSION LEVEL (dBuV/m)	LIMIT (dBuV/m)	MARGIN (dB)	ANTENNA HEIGHT (m)	TABLE ANGLE (Degree)	RAW VALUE (dBuV)	CORRECTION FACTOR (dB/m)
1	#10400.00	49.1 PK	74.0	-24.9	1.09 V	316	35.44	13.66
2	#10400.00	36.0 AV	54.0	-18.0	1.09 V	316	22.34	13.66
3	15600.00	50.1 PK	74.0	-23.9	1.19 V	0	34.44	15.66
4	15600.00	39.5 AV	54.0	-14.5	1.19 V	0	23.84	15.66

REMARKS:

1. Emission Level(dBuV/m) = Raw Value(dBuV) + Correction Factor(dB/m)
2. Correction Factor(dB/m) = Antenna Factor(dB/m) + Cable Factor(dB) – Pre-Amplifier Factor(dB)
3. The other emission levels were very low against the limit.
4. Margin value = Emission Level – Limit value
5. "#": The radiated frequency is out of the restricted band.



CHANNEL	TX Channel 48	DETECTOR FUNCTION	Peak (PK)
FREQUENCY RANGE	1GHz ~ 40GHz		Average (AV)

ANTENNA POLARITY & TEST DISTANCE: HORIZONTAL AT 3 M

NO.	FREQ. (MHz)	EMISSION LEVEL (dBuV/m)	LIMIT (dBuV/m)	MARGIN (dB)	ANTENNA HEIGHT (m)	TABLE ANGLE (Degree)	RAW VALUE (dBuV)	CORRECTION FACTOR (dB/m)
1	#10480.00	49.4 PK	74.0	-24.6	2.21 H	255	35.39	14.01
2	#10480.00	35.7 AV	54.0	-18.3	2.21 H	255	21.69	14.01
3	15720.00	54.7 PK	74.0	-19.3	1.77 H	44	39.27	15.43
4	15720.00	41.3 AV	54.0	-12.7	1.77 H	44	25.87	15.43

ANTENNA POLARITY & TEST DISTANCE: VERTICAL AT 3 M

NO.	FREQ. (MHz)	EMISSION LEVEL (dBuV/m)	LIMIT (dBuV/m)	MARGIN (dB)	ANTENNA HEIGHT (m)	TABLE ANGLE (Degree)	RAW VALUE (dBuV)	CORRECTION FACTOR (dB/m)
1	#10480.00	50.0 PK	74.0	-24.0	1.09 V	313	35.99	14.01
2	#10480.00	36.4 AV	54.0	-17.6	1.09 V	313	22.39	14.01
3	15720.00	50.5 PK	74.0	-23.5	1.27 V	12	35.07	15.43
4	15720.00	40.1 AV	54.0	-13.9	1.27 V	12	24.67	15.43

REMARKS:

1. Emission Level(dBuV/m) = Raw Value(dBuV) + Correction Factor(dB/m)
2. Correction Factor(dB/m) = Antenna Factor(dB/m) + Cable Factor(dB) – Pre-Amplifier Factor(dB)
3. The other emission levels were very low against the limit.
4. Margin value = Emission Level – Limit value
5. "#": The radiated frequency is out of the restricted band.



CHANNEL	TX Channel 52	DETECTOR FUNCTION	Peak (PK)
FREQUENCY RANGE	1GHz ~ 40GHz		Average (AV)

ANTENNA POLARITY & TEST DISTANCE: HORIZONTAL AT 3 M

NO.	FREQ. (MHz)	EMISSION LEVEL (dBuV/m)	LIMIT (dBuV/m)	MARGIN (dB)	ANTENNA HEIGHT (m)	TABLE ANGLE (Degree)	RAW VALUE (dBuV)	CORRECTION FACTOR (dB/m)
1	#10520.00	48.7 PK	74.0	-25.3	2.26 H	272	34.56	14.14
2	#10520.00	35.4 AV	54.0	-18.6	2.26 H	272	21.26	14.14
3	15780.00	55.1 PK	74.0	-18.9	1.85 H	23	39.95	15.15
4	15780.00	41.4 AV	54.0	-12.6	1.85 H	23	26.25	15.15

ANTENNA POLARITY & TEST DISTANCE: VERTICAL AT 3 M

NO.	FREQ. (MHz)	EMISSION LEVEL (dBuV/m)	LIMIT (dBuV/m)	MARGIN (dB)	ANTENNA HEIGHT (m)	TABLE ANGLE (Degree)	RAW VALUE (dBuV)	CORRECTION FACTOR (dB/m)
1	#10520.00	49.6 PK	74.0	-24.4	1.03 V	313	35.46	14.14
2	#10520.00	35.9 AV	54.0	-18.1	1.03 V	313	21.76	14.14
3	15780.00	50.0 PK	74.0	-24.0	1.21 V	15	34.85	15.15
4	15780.00	39.4 AV	54.0	-14.6	1.21 V	15	24.25	15.15

REMARKS:

1. Emission Level(dBuV/m) = Raw Value(dBuV) + Correction Factor(dB/m)
2. Correction Factor(dB/m) = Antenna Factor(dB/m) + Cable Factor(dB) – Pre-Amplifier Factor(dB)
3. The other emission levels were very low against the limit.
4. Margin value = Emission Level – Limit value
5. "#": The radiated frequency is out of the restricted band.



CHANNEL	TX Channel 60	DETECTOR FUNCTION	Peak (PK)
FREQUENCY RANGE	1GHz ~ 40GHz		Average (AV)

ANTENNA POLARITY & TEST DISTANCE: HORIZONTAL AT 3 M

NO.	FREQ. (MHz)	EMISSION LEVEL (dBuV/m)	LIMIT (dBuV/m)	MARGIN (dB)	ANTENNA HEIGHT (m)	TABLE ANGLE (Degree)	RAW VALUE (dBuV)	CORRECTION FACTOR (dB/m)
1	10600.00	48.7 PK	74.0	-25.3	2.25 H	250	34.40	14.30
2	10600.00	35.2 AV	54.0	-18.8	2.25 H	250	20.90	14.30
3	15900.00	55.5 PK	74.0	-18.5	1.84 H	34	40.43	15.07
4	15900.00	41.9 AV	54.0	-12.1	1.84 H	34	26.83	15.07

ANTENNA POLARITY & TEST DISTANCE: VERTICAL AT 3 M

NO.	FREQ. (MHz)	EMISSION LEVEL (dBuV/m)	LIMIT (dBuV/m)	MARGIN (dB)	ANTENNA HEIGHT (m)	TABLE ANGLE (Degree)	RAW VALUE (dBuV)	CORRECTION FACTOR (dB/m)
1	10600.00	49.8 PK	74.0	-24.2	1.10 V	295	35.50	14.30
2	10600.00	36.5 AV	54.0	-17.5	1.10 V	295	22.20	14.30
3	15900.00	50.0 PK	74.0	-24.0	1.19 V	26	34.93	15.07
4	15900.00	39.4 AV	54.0	-14.6	1.19 V	26	24.33	15.07

REMARKS:

1. Emission Level(dBuV/m) = Raw Value(dBuV) + Correction Factor(dB/m)
2. Correction Factor(dB/m) = Antenna Factor(dB/m) + Cable Factor(dB) – Pre-Amplifier Factor(dB)
3. The other emission levels were very low against the limit.
4. Margin value = Emission Level – Limit value



CHANNEL	TX Channel 64	DETECTOR FUNCTION	Peak (PK)
FREQUENCY RANGE	1GHz ~ 40GHz		Average (AV)

ANTENNA POLARITY & TEST DISTANCE: HORIZONTAL AT 3 M

NO.	FREQ. (MHz)	EMISSION LEVEL (dBuV/m)	LIMIT (dBuV/m)	MARGIN (dB)	ANTENNA HEIGHT (m)	TABLE ANGLE (Degree)	RAW VALUE (dBuV)	CORRECTION FACTOR (dB/m)
1	10640.00	49.5 PK	74.0	-24.5	2.25 H	245	35.14	14.36
2	10640.00	35.6 AV	54.0	-18.4	2.25 H	245	21.24	14.36
3	15960.00	55.3 PK	74.0	-18.7	1.77 H	18	40.22	15.08
4	15960.00	41.4 AV	54.0	-12.6	1.77 H	18	26.32	15.08

ANTENNA POLARITY & TEST DISTANCE: VERTICAL AT 3 M

NO.	FREQ. (MHz)	EMISSION LEVEL (dBuV/m)	LIMIT (dBuV/m)	MARGIN (dB)	ANTENNA HEIGHT (m)	TABLE ANGLE (Degree)	RAW VALUE (dBuV)	CORRECTION FACTOR (dB/m)
1	10640.00	49.4 PK	74.0	-24.6	1.05 V	290	35.04	14.36
2	10640.00	36.3 AV	54.0	-17.7	1.05 V	290	21.94	14.36
3	15960.00	50.5 PK	74.0	-23.5	1.21 V	7	35.42	15.08
4	15960.00	40.1 AV	54.0	-13.9	1.21 V	7	25.02	15.08

REMARKS:

1. Emission Level(dBuV/m) = Raw Value(dBuV) + Correction Factor(dB/m)
2. Correction Factor(dB/m) = Antenna Factor(dB/m) + Cable Factor(dB) – Pre-Amplifier Factor(dB)
3. The other emission levels were very low against the limit.
4. Margin value = Emission Level – Limit value



CHANNEL	TX Channel 100	DETECTOR FUNCTION	Peak (PK)
FREQUENCY RANGE	1GHz ~ 40GHz		Average (AV)

ANTENNA POLARITY & TEST DISTANCE: HORIZONTAL AT 3 M

NO.	FREQ. (MHz)	EMISSION LEVEL (dBuV/m)	LIMIT (dBuV/m)	MARGIN (dB)	ANTENNA HEIGHT (m)	TABLE ANGLE (Degree)	RAW VALUE (dBuV)	CORRECTION FACTOR (dB/m)
1	11000.00	49.6 PK	74.0	-24.4	2.29 H	243	34.43	15.17
2	11000.00	35.9 AV	54.0	-18.1	2.29 H	243	20.73	15.17
3	#16500.00	55.3 PK	74.0	-18.7	1.76 H	27	37.94	17.36
4	#16500.00	41.7 AV	54.0	-12.3	1.76 H	27	24.34	17.36

ANTENNA POLARITY & TEST DISTANCE: VERTICAL AT 3 M

NO.	FREQ. (MHz)	EMISSION LEVEL (dBuV/m)	LIMIT (dBuV/m)	MARGIN (dB)	ANTENNA HEIGHT (m)	TABLE ANGLE (Degree)	RAW VALUE (dBuV)	CORRECTION FACTOR (dB/m)
1	11000.00	50.0 PK	74.0	-24.0	1.08 V	295	34.83	15.17
2	11000.00	36.9 AV	54.0	-17.1	1.08 V	295	21.73	15.17
3	#16500.00	49.8 PK	74.0	-24.2	1.15 V	11	32.44	17.36
4	#16500.00	39.5 AV	54.0	-14.5	1.15 V	11	22.14	17.36

REMARKS:

1. Emission Level(dBuV/m) = Raw Value(dBuV) + Correction Factor(dB/m)
2. Correction Factor(dB/m) = Antenna Factor(dB/m) + Cable Factor(dB) – Pre-Amplifier Factor(dB)
3. The other emission levels were very low against the limit.
4. Margin value = Emission Level – Limit value
5. " # ": The radiated frequency is out of the restricted band.



CHANNEL	TX Channel 116	DETECTOR FUNCTION	Peak (PK)
FREQUENCY RANGE	1GHz ~ 40GHz		Average (AV)

ANTENNA POLARITY & TEST DISTANCE: HORIZONTAL AT 3 M

NO.	FREQ. (MHz)	EMISSION LEVEL (dBuV/m)	LIMIT (dBuV/m)	MARGIN (dB)	ANTENNA HEIGHT (m)	TABLE ANGLE (Degree)	RAW VALUE (dBuV)	CORRECTION FACTOR (dB/m)
1	11160.00	49.0 PK	74.0	-25.0	2.26 H	260	33.78	15.22
2	11160.00	35.6 AV	54.0	-18.4	2.26 H	260	20.38	15.22
3	#16740.00	55.6 PK	74.0	-18.4	1.80 H	44	37.27	18.33
4	#16740.00	41.9 AV	54.0	-12.1	1.80 H	44	23.57	18.33

ANTENNA POLARITY & TEST DISTANCE: VERTICAL AT 3 M

NO.	FREQ. (MHz)	EMISSION LEVEL (dBuV/m)	LIMIT (dBuV/m)	MARGIN (dB)	ANTENNA HEIGHT (m)	TABLE ANGLE (Degree)	RAW VALUE (dBuV)	CORRECTION FACTOR (dB/m)
1	11160.00	49.3 PK	74.0	-24.7	1.06 V	292	34.08	15.22
2	11160.00	36.1 AV	54.0	-17.9	1.06 V	292	20.88	15.22
3	#16740.00	50.5 PK	74.0	-23.5	1.24 V	15	32.17	18.33
4	#16740.00	39.6 AV	54.0	-14.4	1.24 V	15	21.27	18.33

REMARKS:

1. Emission Level(dBuV/m) = Raw Value(dBuV) + Correction Factor(dB/m)
2. Correction Factor(dB/m) = Antenna Factor(dB/m) + Cable Factor(dB) – Pre-Amplifier Factor(dB)
3. The other emission levels were very low against the limit.
4. Margin value = Emission Level – Limit value
5. " # ": The radiated frequency is out of the restricted band.



CHANNEL	TX Channel 140	DETECTOR FUNCTION	Peak (PK)
FREQUENCY RANGE	1GHz ~ 40GHz		Average (AV)

ANTENNA POLARITY & TEST DISTANCE: HORIZONTAL AT 3 M

NO.	FREQ. (MHz)	EMISSION LEVEL (dBuV/m)	LIMIT (dBuV/m)	MARGIN (dB)	ANTENNA HEIGHT (m)	TABLE ANGLE (Degree)	RAW VALUE (dBuV)	CORRECTION FACTOR (dB/m)
1	11400.00	49.4 PK	74.0	-24.6	2.25 H	250	33.95	15.45
2	11400.00	35.6 AV	54.0	-18.4	2.25 H	250	20.15	15.45
3	#17100.00	55.5 PK	74.0	-18.5	1.84 H	45	35.44	20.06
4	#17100.00	42.0 AV	54.0	-12.0	1.84 H	45	21.94	20.06

ANTENNA POLARITY & TEST DISTANCE: VERTICAL AT 3 M

NO.	FREQ. (MHz)	EMISSION LEVEL (dBuV/m)	LIMIT (dBuV/m)	MARGIN (dB)	ANTENNA HEIGHT (m)	TABLE ANGLE (Degree)	RAW VALUE (dBuV)	CORRECTION FACTOR (dB/m)
1	11400.00	49.4 PK	74.0	-24.6	1.04 V	301	33.95	15.45
2	11400.00	36.6 AV	54.0	-17.4	1.04 V	301	21.15	15.45
3	#17100.00	50.7 PK	74.0	-23.3	1.26 V	9	30.64	20.06
4	#17100.00	40.2 AV	54.0	-13.8	1.26 V	9	20.14	20.06

REMARKS:

1. Emission Level(dBuV/m) = Raw Value(dBuV) + Correction Factor(dB/m)
2. Correction Factor(dB/m) = Antenna Factor(dB/m) + Cable Factor(dB) – Pre-Amplifier Factor(dB)
3. The other emission levels were very low against the limit.
4. Margin value = Emission Level – Limit value
5. " # ": The radiated frequency is out of the restricted band.



CHANNEL	TX Channel 149	DETECTOR FUNCTION	Peak (PK)
FREQUENCY RANGE	1GHz ~ 40GHz		Average (AV)

ANTENNA POLARITY & TEST DISTANCE: HORIZONTAL AT 3 M

NO.	FREQ. (MHz)	EMISSION LEVEL (dBuV/m)	LIMIT (dBuV/m)	MARGIN (dB)	ANTENNA HEIGHT (m)	TABLE ANGLE (Degree)	RAW VALUE (dBuV)	CORRECTION FACTOR (dB/m)
1	11490.00	49.0 PK	74.0	-25.0	2.23 H	255	33.83	15.17
2	11490.00	35.3 AV	54.0	-18.7	2.23 H	255	20.13	15.17
3	#17235.00	54.8 PK	74.0	-19.2	1.80 H	38	34.90	19.90
4	#17235.00	41.2 AV	54.0	-12.8	1.80 H	38	21.30	19.90

ANTENNA POLARITY & TEST DISTANCE: VERTICAL AT 3 M

NO.	FREQ. (MHz)	EMISSION LEVEL (dBuV/m)	LIMIT (dBuV/m)	MARGIN (dB)	ANTENNA HEIGHT (m)	TABLE ANGLE (Degree)	RAW VALUE (dBuV)	CORRECTION FACTOR (dB/m)
1	11490.00	49.5 PK	74.0	-24.5	1.01 V	291	34.33	15.17
2	11490.00	36.3 AV	54.0	-17.7	1.01 V	291	21.13	15.17
3	#17235.00	50.5 PK	74.0	-23.5	1.17 V	16	30.60	19.90
4	#17235.00	39.6 AV	54.0	-14.4	1.17 V	16	19.70	19.90

REMARKS:

1. Emission Level(dBuV/m) = Raw Value(dBuV) + Correction Factor(dB/m)
2. Correction Factor(dB/m) = Antenna Factor(dB/m) + Cable Factor(dB) – Pre-Amplifier Factor(dB)
3. The other emission levels were very low against the limit.
4. Margin value = Emission Level – Limit value
5. " # ": The radiated frequency is out of the restricted band.



CHANNEL	TX Channel 157	DETECTOR FUNCTION	Peak (PK)
FREQUENCY RANGE	1GHz ~ 40GHz		Average (AV)

ANTENNA POLARITY & TEST DISTANCE: HORIZONTAL AT 3 M

NO.	FREQ. (MHz)	EMISSION LEVEL (dBuV/m)	LIMIT (dBuV/m)	MARGIN (dB)	ANTENNA HEIGHT (m)	TABLE ANGLE (Degree)	RAW VALUE (dBuV)	CORRECTION FACTOR (dB/m)
1	11570.00	48.6 PK	74.0	-25.4	2.26 H	262	33.48	15.12
2	11570.00	35.2 AV	54.0	-18.8	2.26 H	262	20.08	15.12
3	#17355.00	56.0 PK	74.0	-18.0	1.81 H	30	35.56	20.44
4	#17355.00	42.1 AV	54.0	-11.9	1.81 H	30	21.66	20.44

ANTENNA POLARITY & TEST DISTANCE: VERTICAL AT 3 M

NO.	FREQ. (MHz)	EMISSION LEVEL (dBuV/m)	LIMIT (dBuV/m)	MARGIN (dB)	ANTENNA HEIGHT (m)	TABLE ANGLE (Degree)	RAW VALUE (dBuV)	CORRECTION FACTOR (dB/m)
1	11570.00	50.1 PK	74.0	-23.9	1.09 V	309	34.98	15.12
2	11570.00	36.7 AV	54.0	-17.3	1.09 V	309	21.58	15.12
3	#17355.00	50.5 PK	74.0	-23.5	1.20 V	27	30.06	20.44
4	#17355.00	39.9 AV	54.0	-14.1	1.20 V	27	19.46	20.44

REMARKS:

1. Emission Level(dBuV/m) = Raw Value(dBuV) + Correction Factor(dB/m)
2. Correction Factor(dB/m) = Antenna Factor(dB/m) + Cable Factor(dB) – Pre-Amplifier Factor(dB)
3. The other emission levels were very low against the limit.
4. Margin value = Emission Level – Limit value
5. " # ": The radiated frequency is out of the restricted band.



CHANNEL	TX Channel 165	DETECTOR FUNCTION	Peak (PK)
FREQUENCY RANGE	1GHz ~ 40GHz		Average (AV)

ANTENNA POLARITY & TEST DISTANCE: HORIZONTAL AT 3 M

NO.	FREQ. (MHz)	EMISSION LEVEL (dBuV/m)	LIMIT (dBuV/m)	MARGIN (dB)	ANTENNA HEIGHT (m)	TABLE ANGLE (Degree)	RAW VALUE (dBuV)	CORRECTION FACTOR (dB/m)
1	11650.00	49.4 PK	74.0	-24.6	2.30 H	268	34.40	15.00
2	11650.00	35.6 AV	54.0	-18.4	2.30 H	268	20.60	15.00
3	#17475.00	55.5 PK	74.0	-18.5	1.84 H	35	34.39	21.11
4	#17475.00	41.5 AV	54.0	-12.5	1.84 H	35	20.39	21.11

ANTENNA POLARITY & TEST DISTANCE: VERTICAL AT 3 M

NO.	FREQ. (MHz)	EMISSION LEVEL (dBuV/m)	LIMIT (dBuV/m)	MARGIN (dB)	ANTENNA HEIGHT (m)	TABLE ANGLE (Degree)	RAW VALUE (dBuV)	CORRECTION FACTOR (dB/m)
1	11650.00	49.7 PK	74.0	-24.3	1.05 V	300	34.70	15.00
2	11650.00	36.0 AV	54.0	-18.0	1.05 V	300	21.00	15.00
3	#17475.00	50.1 PK	74.0	-23.9	1.27 V	21	28.99	21.11
4	#17475.00	39.2 AV	54.0	-14.8	1.27 V	21	18.09	21.11

REMARKS:

1. Emission Level(dBuV/m) = Raw Value(dBuV) + Correction Factor(dB/m)
2. Correction Factor(dB/m) = Antenna Factor(dB/m) + Cable Factor(dB) – Pre-Amplifier Factor(dB)
3. The other emission levels were very low against the limit.
4. Margin value = Emission Level – Limit value
5. " # ": The radiated frequency is out of the restricted band.

802.11n (20MHz)

CHANNEL	TX Channel 36	DETECTOR FUNCTION	Peak (PK)
FREQUENCY RANGE	1GHz ~ 40GHz		Average (AV)

ANTENNA POLARITY & TEST DISTANCE: HORIZONTAL AT 3 M

NO.	FREQ. (MHz)	EMISSION LEVEL (dBuV/m)	LIMIT (dBuV/m)	MARGIN (dB)	ANTENNA HEIGHT (m)	TABLE ANGLE (Degree)	RAW VALUE (dBuV)	CORRECTION FACTOR (dB/m)
1	#10360.00	48.7 PK	74.0	-25.3	2.27 H	251	35.05	13.65
2	#10360.00	35.1 AV	54.0	-18.9	2.27 H	251	21.45	13.65
3	15540.00	55.4 PK	74.0	-18.6	1.81 H	40	39.72	15.68
4	15540.00	41.7 AV	54.0	-12.3	1.81 H	40	26.02	15.68

ANTENNA POLARITY & TEST DISTANCE: VERTICAL AT 3 M

NO.	FREQ. (MHz)	EMISSION LEVEL (dBuV/m)	LIMIT (dBuV/m)	MARGIN (dB)	ANTENNA HEIGHT (m)	TABLE ANGLE (Degree)	RAW VALUE (dBuV)	CORRECTION FACTOR (dB/m)
1	#10360.00	49.1 PK	74.0	-24.9	1.09 V	298	35.45	13.65
2	#10360.00	36.0 AV	54.0	-18.0	1.09 V	298	22.35	13.65
3	15540.00	50.0 PK	74.0	-24.0	1.16 V	1	34.32	15.68
4	15540.00	39.7 AV	54.0	-14.3	1.16 V	1	24.02	15.68

REMARKS:

1. Emission Level(dBuV/m) = Raw Value(dBuV) + Correction Factor(dB/m)
2. Correction Factor(dB/m) = Antenna Factor(dB/m) + Cable Factor(dB) – Pre-Amplifier Factor(dB)
3. The other emission levels were very low against the limit.
4. Margin value = Emission Level – Limit value
5. " # ": The radiated frequency is out of the restricted band.



CHANNEL	TX Channel 40	DETECTOR FUNCTION	Peak (PK)
FREQUENCY RANGE	1GHz ~ 40GHz		Average (AV)

ANTENNA POLARITY & TEST DISTANCE: HORIZONTAL AT 3 M

NO.	FREQ. (MHz)	EMISSION LEVEL (dBuV/m)	LIMIT (dBuV/m)	MARGIN (dB)	ANTENNA HEIGHT (m)	TABLE ANGLE (Degree)	RAW VALUE (dBuV)	CORRECTION FACTOR (dB/m)
1	#10400.00	48.6 PK	74.0	-25.4	2.20 H	260	34.94	13.66
2	#10400.00	35.3 AV	54.0	-18.7	2.20 H	260	21.64	13.66
3	15600.00	54.9 PK	74.0	-19.1	1.78 H	35	39.24	15.66
4	15600.00	41.4 AV	54.0	-12.6	1.78 H	35	25.74	15.66

ANTENNA POLARITY & TEST DISTANCE: VERTICAL AT 3 M

NO.	FREQ. (MHz)	EMISSION LEVEL (dBuV/m)	LIMIT (dBuV/m)	MARGIN (dB)	ANTENNA HEIGHT (m)	TABLE ANGLE (Degree)	RAW VALUE (dBuV)	CORRECTION FACTOR (dB/m)
1	#10400.00	50.3 PK	74.0	-23.7	1.13 V	315	36.64	13.66
2	#10400.00	36.7 AV	54.0	-17.3	1.13 V	315	23.04	13.66
3	15600.00	50.5 PK	74.0	-23.5	1.20 V	9	34.84	15.66
4	15600.00	39.5 AV	54.0	-14.5	1.20 V	9	23.84	15.66

REMARKS:

1. Emission Level(dBuV/m) = Raw Value(dBuV) + Correction Factor(dB/m)
2. Correction Factor(dB/m) = Antenna Factor(dB/m) + Cable Factor(dB) – Pre-Amplifier Factor(dB)
3. The other emission levels were very low against the limit.
4. Margin value = Emission Level – Limit value
5. "#": The radiated frequency is out of the restricted band.



CHANNEL	TX Channel 48	DETECTOR FUNCTION	Peak (PK)
FREQUENCY RANGE	1GHz ~ 40GHz		Average (AV)

ANTENNA POLARITY & TEST DISTANCE: HORIZONTAL AT 3 M

NO.	FREQ. (MHz)	EMISSION LEVEL (dBuV/m)	LIMIT (dBuV/m)	MARGIN (dB)	ANTENNA HEIGHT (m)	TABLE ANGLE (Degree)	RAW VALUE (dBuV)	CORRECTION FACTOR (dB/m)
1	#10480.00	49.3 PK	74.0	-24.7	2.21 H	267	35.29	14.01
2	#10480.00	35.6 AV	54.0	-18.4	2.21 H	267	21.59	14.01
3	15720.00	55.4 PK	74.0	-18.6	1.82 H	33	39.97	15.43
4	15720.00	41.9 AV	54.0	-12.1	1.82 H	33	26.47	15.43

ANTENNA POLARITY & TEST DISTANCE: VERTICAL AT 3 M

NO.	FREQ. (MHz)	EMISSION LEVEL (dBuV/m)	LIMIT (dBuV/m)	MARGIN (dB)	ANTENNA HEIGHT (m)	TABLE ANGLE (Degree)	RAW VALUE (dBuV)	CORRECTION FACTOR (dB/m)
1	#10480.00	49.6 PK	74.0	-24.4	1.02 V	300	35.59	14.01
2	#10480.00	36.2 AV	54.0	-17.8	1.02 V	300	22.19	14.01
3	15720.00	50.1 PK	74.0	-23.9	1.18 V	23	34.67	15.43
4	15720.00	39.3 AV	54.0	-14.7	1.18 V	23	23.87	15.43

REMARKS:

1. Emission Level(dBuV/m) = Raw Value(dBuV) + Correction Factor(dB/m)
2. Correction Factor(dB/m) = Antenna Factor(dB/m) + Cable Factor(dB) – Pre-Amplifier Factor(dB)
3. The other emission levels were very low against the limit.
4. Margin value = Emission Level – Limit value
5. "#": The radiated frequency is out of the restricted band.



CHANNEL	TX Channel 52	DETECTOR FUNCTION	Peak (PK)
FREQUENCY RANGE	1GHz ~ 40GHz		Average (AV)

ANTENNA POLARITY & TEST DISTANCE: HORIZONTAL AT 3 M

NO.	FREQ. (MHz)	EMISSION LEVEL (dBuV/m)	LIMIT (dBuV/m)	MARGIN (dB)	ANTENNA HEIGHT (m)	TABLE ANGLE (Degree)	RAW VALUE (dBuV)	CORRECTION FACTOR (dB/m)
1	#10520.00	48.6 PK	74.0	-25.4	2.30 H	257	34.46	14.14
2	#10520.00	35.3 AV	54.0	-18.7	2.30 H	257	21.16	14.14
3	15780.00	54.9 PK	74.0	-19.1	1.74 H	32	39.75	15.15
4	15780.00	41.3 AV	54.0	-12.7	1.74 H	32	26.15	15.15

ANTENNA POLARITY & TEST DISTANCE: VERTICAL AT 3 M

NO.	FREQ. (MHz)	EMISSION LEVEL (dBuV/m)	LIMIT (dBuV/m)	MARGIN (dB)	ANTENNA HEIGHT (m)	TABLE ANGLE (Degree)	RAW VALUE (dBuV)	CORRECTION FACTOR (dB/m)
1	#10520.00	49.8 PK	74.0	-24.2	1.07 V	287	35.66	14.14
2	#10520.00	36.6 AV	54.0	-17.4	1.07 V	287	22.46	14.14
3	15780.00	50.8 PK	74.0	-23.2	1.20 V	13	35.65	15.15
4	15780.00	40.1 AV	54.0	-13.9	1.20 V	13	24.95	15.15

REMARKS:

1. Emission Level(dBuV/m) = Raw Value(dBuV) + Correction Factor(dB/m)
2. Correction Factor(dB/m) = Antenna Factor(dB/m) + Cable Factor(dB) – Pre-Amplifier Factor(dB)
3. The other emission levels were very low against the limit.
4. Margin value = Emission Level – Limit value
5. "#": The radiated frequency is out of the restricted band.



CHANNEL	TX Channel 60	DETECTOR FUNCTION	Peak (PK)
FREQUENCY RANGE	1GHz ~ 40GHz		Average (AV)

ANTENNA POLARITY & TEST DISTANCE: HORIZONTAL AT 3 M

NO.	FREQ. (MHz)	EMISSION LEVEL (dBuV/m)	LIMIT (dBuV/m)	MARGIN (dB)	ANTENNA HEIGHT (m)	TABLE ANGLE (Degree)	RAW VALUE (dBuV)	CORRECTION FACTOR (dB/m)
1	10600.00	49.0 PK	74.0	-25.0	2.32 H	261	34.70	14.30
2	10600.00	35.7 AV	54.0	-18.3	2.32 H	261	21.40	14.30
3	15900.00	55.4 PK	74.0	-18.6	1.83 H	31	40.33	15.07
4	15900.00	41.9 AV	54.0	-12.1	1.83 H	31	26.83	15.07

ANTENNA POLARITY & TEST DISTANCE: VERTICAL AT 3 M

NO.	FREQ. (MHz)	EMISSION LEVEL (dBuV/m)	LIMIT (dBuV/m)	MARGIN (dB)	ANTENNA HEIGHT (m)	TABLE ANGLE (Degree)	RAW VALUE (dBuV)	CORRECTION FACTOR (dB/m)
1	10600.00	49.6 PK	74.0	-24.4	1.06 V	314	35.30	14.30
2	10600.00	35.9 AV	54.0	-18.1	1.06 V	314	21.60	14.30
3	15900.00	50.1 PK	74.0	-23.9	1.18 V	3	35.03	15.07
4	15900.00	39.6 AV	54.0	-14.4	1.18 V	3	24.53	15.07

REMARKS:

1. Emission Level(dBuV/m) = Raw Value(dBuV) + Correction Factor(dB/m)
2. Correction Factor(dB/m) = Antenna Factor(dB/m) + Cable Factor(dB) – Pre-Amplifier Factor(dB)
3. The other emission levels were very low against the limit.
4. Margin value = Emission Level – Limit value



CHANNEL	TX Channel 64	DETECTOR FUNCTION	Peak (PK)
FREQUENCY RANGE	1GHz ~ 40GHz		Average (AV)

ANTENNA POLARITY & TEST DISTANCE: HORIZONTAL AT 3 M

NO.	FREQ. (MHz)	EMISSION LEVEL (dBuV/m)	LIMIT (dBuV/m)	MARGIN (dB)	ANTENNA HEIGHT (m)	TABLE ANGLE (Degree)	RAW VALUE (dBuV)	CORRECTION FACTOR (dB/m)
1	10640.00	48.8 PK	74.0	-25.2	2.25 H	253	34.44	14.36
2	10640.00	35.0 AV	54.0	-19.0	2.25 H	253	20.64	14.36
3	15960.00	54.8 PK	74.0	-19.2	1.83 H	45	39.72	15.08
4	15960.00	41.3 AV	54.0	-12.7	1.83 H	45	26.22	15.08

ANTENNA POLARITY & TEST DISTANCE: VERTICAL AT 3 M

NO.	FREQ. (MHz)	EMISSION LEVEL (dBuV/m)	LIMIT (dBuV/m)	MARGIN (dB)	ANTENNA HEIGHT (m)	TABLE ANGLE (Degree)	RAW VALUE (dBuV)	CORRECTION FACTOR (dB/m)
1	10640.00	49.1 PK	74.0	-24.9	1.00 V	321	34.74	14.36
2	10640.00	36.1 AV	54.0	-17.9	1.00 V	321	21.74	14.36
3	15960.00	50.1 PK	74.0	-23.9	1.16 V	6	35.02	15.08
4	15960.00	39.7 AV	54.0	-14.3	1.16 V	6	24.62	15.08

REMARKS:

1. Emission Level(dBuV/m) = Raw Value(dBuV) + Correction Factor(dB/m)
2. Correction Factor(dB/m) = Antenna Factor(dB/m) + Cable Factor(dB) – Pre-Amplifier Factor(dB)
3. The other emission levels were very low against the limit.
4. Margin value = Emission Level – Limit value



CHANNEL	TX Channel 100	DETECTOR FUNCTION	Peak (PK)
FREQUENCY RANGE	1GHz ~ 40GHz		Average (AV)

ANTENNA POLARITY & TEST DISTANCE: HORIZONTAL AT 3 M

NO.	FREQ. (MHz)	EMISSION LEVEL (dBuV/m)	LIMIT (dBuV/m)	MARGIN (dB)	ANTENNA HEIGHT (m)	TABLE ANGLE (Degree)	RAW VALUE (dBuV)	CORRECTION FACTOR (dB/m)
1	11000.00	49.5 PK	74.0	-24.5	2.29 H	269	34.33	15.17
2	11000.00	35.7 AV	54.0	-18.3	2.29 H	269	20.53	15.17
3	#16500.00	55.0 PK	74.0	-19.0	1.81 H	24	37.64	17.36
4	#16500.00	41.5 AV	54.0	-12.5	1.81 H	24	24.14	17.36

ANTENNA POLARITY & TEST DISTANCE: VERTICAL AT 3 M

NO.	FREQ. (MHz)	EMISSION LEVEL (dBuV/m)	LIMIT (dBuV/m)	MARGIN (dB)	ANTENNA HEIGHT (m)	TABLE ANGLE (Degree)	RAW VALUE (dBuV)	CORRECTION FACTOR (dB/m)
1	11000.00	49.5 PK	74.0	-24.5	1.00 V	295	34.33	15.17
2	11000.00	36.2 AV	54.0	-17.8	1.00 V	295	21.03	15.17
3	#16500.00	50.9 PK	74.0	-23.1	1.16 V	0	33.54	17.36
4	#16500.00	40.3 AV	54.0	-13.7	1.16 V	0	22.94	17.36

REMARKS:

1. Emission Level(dBuV/m) = Raw Value(dBuV) + Correction Factor(dB/m)
2. Correction Factor(dB/m) = Antenna Factor(dB/m) + Cable Factor(dB) – Pre-Amplifier Factor(dB)
3. The other emission levels were very low against the limit.
4. Margin value = Emission Level – Limit value
5. " # ": The radiated frequency is out of the restricted band.



CHANNEL	TX Channel 116	DETECTOR FUNCTION	Peak (PK)
FREQUENCY RANGE	1GHz ~ 40GHz		Average (AV)

ANTENNA POLARITY & TEST DISTANCE: HORIZONTAL AT 3 M

NO.	FREQ. (MHz)	EMISSION LEVEL (dBuV/m)	LIMIT (dBuV/m)	MARGIN (dB)	ANTENNA HEIGHT (m)	TABLE ANGLE (Degree)	RAW VALUE (dBuV)	CORRECTION FACTOR (dB/m)
1	11160.00	49.5 PK	74.0	-24.5	2.30 H	264	34.28	15.22
2	11160.00	35.6 AV	54.0	-18.4	2.30 H	264	20.38	15.22
3	#16740.00	55.4 PK	74.0	-18.6	1.80 H	40	37.07	18.33
4	#16740.00	42.0 AV	54.0	-12.0	1.80 H	40	23.67	18.33

ANTENNA POLARITY & TEST DISTANCE: VERTICAL AT 3 M

NO.	FREQ. (MHz)	EMISSION LEVEL (dBuV/m)	LIMIT (dBuV/m)	MARGIN (dB)	ANTENNA HEIGHT (m)	TABLE ANGLE (Degree)	RAW VALUE (dBuV)	CORRECTION FACTOR (dB/m)
1	11160.00	49.3 PK	74.0	-24.7	1.06 V	295	34.08	15.22
2	11160.00	36.2 AV	54.0	-17.8	1.06 V	295	20.98	15.22
3	#16740.00	50.3 PK	74.0	-23.7	1.24 V	17	31.97	18.33
4	#16740.00	39.8 AV	54.0	-14.2	1.24 V	17	21.47	18.33

REMARKS:

1. Emission Level(dBuV/m) = Raw Value(dBuV) + Correction Factor(dB/m)
2. Correction Factor(dB/m) = Antenna Factor(dB/m) + Cable Factor(dB) – Pre-Amplifier Factor(dB)
3. The other emission levels were very low against the limit.
4. Margin value = Emission Level – Limit value
5. " # ": The radiated frequency is out of the restricted band.



CHANNEL	TX Channel 140	DETECTOR FUNCTION	Peak (PK)
FREQUENCY RANGE	1GHz ~ 40GHz		Average (AV)

ANTENNA POLARITY & TEST DISTANCE: HORIZONTAL AT 3 M

NO.	FREQ. (MHz)	EMISSION LEVEL (dBuV/m)	LIMIT (dBuV/m)	MARGIN (dB)	ANTENNA HEIGHT (m)	TABLE ANGLE (Degree)	RAW VALUE (dBuV)	CORRECTION FACTOR (dB/m)
1	11400.00	49.3 PK	74.0	-24.7	2.34 H	276	33.85	15.45
2	11400.00	35.7 AV	54.0	-18.3	2.34 H	276	20.25	15.45
3	#17100.00	54.9 PK	74.0	-19.1	1.84 H	26	34.84	20.06
4	#17100.00	41.2 AV	54.0	-12.8	1.84 H	26	21.14	20.06

ANTENNA POLARITY & TEST DISTANCE: VERTICAL AT 3 M

NO.	FREQ. (MHz)	EMISSION LEVEL (dBuV/m)	LIMIT (dBuV/m)	MARGIN (dB)	ANTENNA HEIGHT (m)	TABLE ANGLE (Degree)	RAW VALUE (dBuV)	CORRECTION FACTOR (dB/m)
1	11400.00	50.0 PK	74.0	-24.0	1.09 V	299	34.55	15.45
2	11400.00	36.8 AV	54.0	-17.2	1.09 V	299	21.35	15.45
3	#17100.00	50.2 PK	74.0	-23.8	1.26 V	13	30.14	20.06
4	#17100.00	39.7 AV	54.0	-14.3	1.26 V	13	19.64	20.06

REMARKS:

1. Emission Level(dBuV/m) = Raw Value(dBuV) + Correction Factor(dB/m)
2. Correction Factor(dB/m) = Antenna Factor(dB/m) + Cable Factor(dB) – Pre-Amplifier Factor(dB)
3. The other emission levels were very low against the limit.
4. Margin value = Emission Level – Limit value
5. " # ": The radiated frequency is out of the restricted band.



CHANNEL	TX Channel 149	DETECTOR FUNCTION	Peak (PK)
FREQUENCY RANGE	1GHz ~ 40GHz		Average (AV)

ANTENNA POLARITY & TEST DISTANCE: HORIZONTAL AT 3 M

NO.	FREQ. (MHz)	EMISSION LEVEL (dBuV/m)	LIMIT (dBuV/m)	MARGIN (dB)	ANTENNA HEIGHT (m)	TABLE ANGLE (Degree)	RAW VALUE (dBuV)	CORRECTION FACTOR (dB/m)
1	11490.00	49.1 PK	74.0	-24.9	2.25 H	281	33.93	15.17
2	11490.00	35.4 AV	54.0	-18.6	2.25 H	281	20.23	15.17
3	#17235.00	55.4 PK	74.0	-18.6	1.86 H	9	35.50	19.90
4	#17235.00	41.6 AV	54.0	-12.4	1.86 H	9	21.70	19.90

ANTENNA POLARITY & TEST DISTANCE: VERTICAL AT 3 M

NO.	FREQ. (MHz)	EMISSION LEVEL (dBuV/m)	LIMIT (dBuV/m)	MARGIN (dB)	ANTENNA HEIGHT (m)	TABLE ANGLE (Degree)	RAW VALUE (dBuV)	CORRECTION FACTOR (dB/m)
1	11490.00	49.0 PK	74.0	-25.0	1.00 V	296	33.83	15.17
2	11490.00	36.0 AV	54.0	-18.0	1.00 V	296	20.83	15.17
3	#17235.00	50.0 PK	74.0	-24.0	1.17 V	10	30.10	19.90
4	#17235.00	39.4 AV	54.0	-14.6	1.17 V	10	19.50	19.90

REMARKS:

1. Emission Level(dBuV/m) = Raw Value(dBuV) + Correction Factor(dB/m)
2. Correction Factor(dB/m) = Antenna Factor(dB/m) + Cable Factor(dB) – Pre-Amplifier Factor(dB)
3. The other emission levels were very low against the limit.
4. Margin value = Emission Level – Limit value
5. " # ": The radiated frequency is out of the restricted band.



CHANNEL	TX Channel 157	DETECTOR FUNCTION	Peak (PK)
FREQUENCY RANGE	1GHz ~ 40GHz		Average (AV)

ANTENNA POLARITY & TEST DISTANCE: HORIZONTAL AT 3 M

NO.	FREQ. (MHz)	EMISSION LEVEL (dBuV/m)	LIMIT (dBuV/m)	MARGIN (dB)	ANTENNA HEIGHT (m)	TABLE ANGLE (Degree)	RAW VALUE (dBuV)	CORRECTION FACTOR (dB/m)
1	11570.00	49.2 PK	74.0	-24.8	2.23 H	283	34.08	15.12
2	11570.00	35.3 AV	54.0	-18.7	2.23 H	283	20.18	15.12
3	#17355.00	54.7 PK	74.0	-19.3	1.83 H	19	34.26	20.44
4	#17355.00	41.2 AV	54.0	-12.8	1.83 H	19	20.76	20.44

ANTENNA POLARITY & TEST DISTANCE: VERTICAL AT 3 M

NO.	FREQ. (MHz)	EMISSION LEVEL (dBuV/m)	LIMIT (dBuV/m)	MARGIN (dB)	ANTENNA HEIGHT (m)	TABLE ANGLE (Degree)	RAW VALUE (dBuV)	CORRECTION FACTOR (dB/m)
1	11570.00	49.9 PK	74.0	-24.1	1.09 V	303	34.78	15.12
2	11570.00	36.4 AV	54.0	-17.6	1.09 V	303	21.28	15.12
3	#17355.00	50.1 PK	74.0	-23.9	1.21 V	13	29.66	20.44
4	#17355.00	39.2 AV	54.0	-14.8	1.21 V	13	18.76	20.44

REMARKS:

1. Emission Level(dBuV/m) = Raw Value(dBuV) + Correction Factor(dB/m)
2. Correction Factor(dB/m) = Antenna Factor(dB/m) + Cable Factor(dB) – Pre-Amplifier Factor(dB)
3. The other emission levels were very low against the limit.
4. Margin value = Emission Level – Limit value
5. " # ": The radiated frequency is out of the restricted band.



CHANNEL	TX Channel 165	DETECTOR FUNCTION	Peak (PK)
FREQUENCY RANGE	1GHz ~ 40GHz		Average (AV)

ANTENNA POLARITY & TEST DISTANCE: HORIZONTAL AT 3 M

NO.	FREQ. (MHz)	EMISSION LEVEL (dBuV/m)	LIMIT (dBuV/m)	MARGIN (dB)	ANTENNA HEIGHT (m)	TABLE ANGLE (Degree)	RAW VALUE (dBuV)	CORRECTION FACTOR (dB/m)
1	11650.00	49.7 PK	74.0	-24.3	2.34 H	256	34.70	15.00
2	11650.00	35.7 AV	54.0	-18.3	2.34 H	256	20.70	15.00
3	#17475.00	55.5 PK	74.0	-18.5	1.76 H	36	34.39	21.11
4	#17475.00	42.0 AV	54.0	-12.0	1.76 H	36	20.89	21.11

ANTENNA POLARITY & TEST DISTANCE: VERTICAL AT 3 M

NO.	FREQ. (MHz)	EMISSION LEVEL (dBuV/m)	LIMIT (dBuV/m)	MARGIN (dB)	ANTENNA HEIGHT (m)	TABLE ANGLE (Degree)	RAW VALUE (dBuV)	CORRECTION FACTOR (dB/m)
1	11650.00	49.2 PK	74.0	-24.8	1.01 V	316	34.20	15.00
2	11650.00	35.8 AV	54.0	-18.2	1.01 V	316	20.80	15.00
3	#17475.00	50.0 PK	74.0	-24.0	1.19 V	1	28.89	21.11
4	#17475.00	39.4 AV	54.0	-14.6	1.19 V	1	18.29	21.11

REMARKS:

1. Emission Level(dBuV/m) = Raw Value(dBuV) + Correction Factor(dB/m)
2. Correction Factor(dB/m) = Antenna Factor(dB/m) + Cable Factor(dB) – Pre-Amplifier Factor(dB)
3. The other emission levels were very low against the limit.
4. Margin value = Emission Level – Limit value
5. " # ": The radiated frequency is out of the restricted band.

802.11n (40MHz)

CHANNEL	TX Channel 38	DETECTOR FUNCTION	Peak (PK)
FREQUENCY RANGE	1GHz ~ 40GHz		Average (AV)

ANTENNA POLARITY & TEST DISTANCE: HORIZONTAL AT 3 M

NO.	FREQ. (MHz)	EMISSION LEVEL (dBuV/m)	LIMIT (dBuV/m)	MARGIN (dB)	ANTENNA HEIGHT (m)	TABLE ANGLE (Degree)	RAW VALUE (dBuV)	CORRECTION FACTOR (dB/m)
1	#10380.00	49.4 PK	74.0	-24.6	2.23 H	266	35.74	13.66
2	#10380.00	35.4 AV	54.0	-18.6	2.23 H	266	21.74	13.66
3	15570.00	55.0 PK	74.0	-19.0	1.86 H	17	39.33	15.67
4	15570.00	41.8 AV	54.0	-12.2	1.86 H	17	26.13	15.67

ANTENNA POLARITY & TEST DISTANCE: VERTICAL AT 3 M

NO.	FREQ. (MHz)	EMISSION LEVEL (dBuV/m)	LIMIT (dBuV/m)	MARGIN (dB)	ANTENNA HEIGHT (m)	TABLE ANGLE (Degree)	RAW VALUE (dBuV)	CORRECTION FACTOR (dB/m)
1	#10380.00	50.1 PK	74.0	-23.9	1.09 V	316	36.44	13.66
2	#10380.00	36.7 AV	54.0	-17.3	1.09 V	316	23.04	13.66
3	15570.00	50.4 PK	74.0	-23.6	1.16 V	8	34.73	15.67
4	15570.00	39.8 AV	54.0	-14.2	1.16 V	8	24.13	15.67

REMARKS:

1. Emission Level(dBuV/m) = Raw Value(dBuV) + Correction Factor(dB/m)
2. Correction Factor(dB/m) = Antenna Factor(dB/m) + Cable Factor(dB) – Pre-Amplifier Factor(dB)
3. The other emission levels were very low against the limit.
4. Margin value = Emission Level – Limit value
5. " # ": The radiated frequency is out of the restricted band.



CHANNEL	TX Channel 46	DETECTOR FUNCTION	Peak (PK)
FREQUENCY RANGE	1GHz ~ 40GHz		Average (AV)

ANTENNA POLARITY & TEST DISTANCE: HORIZONTAL AT 3 M

NO.	FREQ. (MHz)	EMISSION LEVEL (dBuV/m)	LIMIT (dBuV/m)	MARGIN (dB)	ANTENNA HEIGHT (m)	TABLE ANGLE (Degree)	RAW VALUE (dBuV)	CORRECTION FACTOR (dB/m)
1	#10460.00	49.7 PK	74.0	-24.3	2.30 H	280	35.78	13.92
2	#10460.00	36.0 AV	54.0	-18.0	2.30 H	280	22.08	13.92
3	15690.00	55.6 PK	74.0	-18.4	1.76 H	16	40.06	15.54
4	15690.00	42.0 AV	54.0	-12.0	1.76 H	16	26.46	15.54

ANTENNA POLARITY & TEST DISTANCE: VERTICAL AT 3 M

NO.	FREQ. (MHz)	EMISSION LEVEL (dBuV/m)	LIMIT (dBuV/m)	MARGIN (dB)	ANTENNA HEIGHT (m)	TABLE ANGLE (Degree)	RAW VALUE (dBuV)	CORRECTION FACTOR (dB/m)
1	#10460.00	49.9 PK	74.0	-24.1	1.01 V	320	35.98	13.92
2	#10460.00	36.6 AV	54.0	-17.4	1.01 V	320	22.68	13.92
3	15690.00	49.9 PK	74.0	-24.1	1.21 V	20	34.36	15.54
4	15690.00	39.3 AV	54.0	-14.7	1.21 V	20	23.76	15.54

REMARKS:

1. Emission Level(dBuV/m) = Raw Value(dBuV) + Correction Factor(dB/m)
2. Correction Factor(dB/m) = Antenna Factor(dB/m) + Cable Factor(dB) – Pre-Amplifier Factor(dB)
3. The other emission levels were very low against the limit.
4. Margin value = Emission Level – Limit value
5. " # ": The radiated frequency is out of the restricted band.



CHANNEL	TX Channel 54	DETECTOR FUNCTION	Peak (PK)
FREQUENCY RANGE	1GHz ~ 40GHz		Average (AV)

ANTENNA POLARITY & TEST DISTANCE: HORIZONTAL AT 3 M

NO.	FREQ. (MHz)	EMISSION LEVEL (dBuV/m)	LIMIT (dBuV/m)	MARGIN (dB)	ANTENNA HEIGHT (m)	TABLE ANGLE (Degree)	RAW VALUE (dBuV)	CORRECTION FACTOR (dB/m)
1	#10540.00	49.7 PK	74.0	-24.3	2.32 H	282	35.52	14.18
2	#10540.00	36.1 AV	54.0	-17.9	2.32 H	282	21.92	14.18
3	15810.00	54.6 PK	74.0	-19.4	1.81 H	15	39.55	15.05
4	15810.00	41.2 AV	54.0	-12.8	1.81 H	15	26.15	15.05

ANTENNA POLARITY & TEST DISTANCE: VERTICAL AT 3 M

NO.	FREQ. (MHz)	EMISSION LEVEL (dBuV/m)	LIMIT (dBuV/m)	MARGIN (dB)	ANTENNA HEIGHT (m)	TABLE ANGLE (Degree)	RAW VALUE (dBuV)	CORRECTION FACTOR (dB/m)
1	#10540.00	49.1 PK	74.0	-24.9	1.04 V	315	34.92	14.18
2	#10540.00	36.0 AV	54.0	-18.0	1.04 V	315	21.82	14.18
3	15810.00	50.3 PK	74.0	-23.7	1.23 V	6	35.25	15.05
4	15810.00	39.8 AV	54.0	-14.2	1.23 V	6	24.75	15.05

REMARKS:

1. Emission Level(dBuV/m) = Raw Value(dBuV) + Correction Factor(dB/m)
2. Correction Factor(dB/m) = Antenna Factor(dB/m) + Cable Factor(dB) – Pre-Amplifier Factor(dB)
3. The other emission levels were very low against the limit.
4. Margin value = Emission Level – Limit value
5. "#": The radiated frequency is out of the restricted band.



CHANNEL	TX Channel 62	DETECTOR FUNCTION	Peak (PK)
FREQUENCY RANGE	1GHz ~ 40GHz		Average (AV)

ANTENNA POLARITY & TEST DISTANCE: HORIZONTAL AT 3 M

NO.	FREQ. (MHz)	EMISSION LEVEL (dBuV/m)	LIMIT (dBuV/m)	MARGIN (dB)	ANTENNA HEIGHT (m)	TABLE ANGLE (Degree)	RAW VALUE (dBuV)	CORRECTION FACTOR (dB/m)
1	10620.00	49.1 PK	74.0	-24.9	2.29 H	262	34.77	14.33
2	10620.00	35.2 AV	54.0	-18.8	2.29 H	262	20.87	14.33
3	15930.00	55.3 PK	74.0	-18.7	1.83 H	18	40.22	15.08
4	15930.00	41.9 AV	54.0	-12.1	1.83 H	18	26.82	15.08

ANTENNA POLARITY & TEST DISTANCE: VERTICAL AT 3 M

NO.	FREQ. (MHz)	EMISSION LEVEL (dBuV/m)	LIMIT (dBuV/m)	MARGIN (dB)	ANTENNA HEIGHT (m)	TABLE ANGLE (Degree)	RAW VALUE (dBuV)	CORRECTION FACTOR (dB/m)
1	10620.00	49.6 PK	74.0	-24.4	1.08 V	312	35.27	14.33
2	10620.00	36.4 AV	54.0	-17.6	1.08 V	312	22.07	14.33
3	15930.00	50.3 PK	74.0	-23.7	1.18 V	18	35.22	15.08
4	15930.00	39.6 AV	54.0	-14.4	1.18 V	18	24.52	15.08

REMARKS:

1. Emission Level(dBuV/m) = Raw Value(dBuV) + Correction Factor(dB/m)
2. Correction Factor(dB/m) = Antenna Factor(dB/m) + Cable Factor(dB) – Pre-Amplifier Factor(dB)
3. The other emission levels were very low against the limit.
4. Margin value = Emission Level – Limit value



CHANNEL	TX Channel 102	DETECTOR FUNCTION	Peak (PK)
FREQUENCY RANGE	1GHz ~ 40GHz		Average (AV)

ANTENNA POLARITY & TEST DISTANCE: HORIZONTAL AT 3 M

NO.	FREQ. (MHz)	EMISSION LEVEL (dBuV/m)	LIMIT (dBuV/m)	MARGIN (dB)	ANTENNA HEIGHT (m)	TABLE ANGLE (Degree)	RAW VALUE (dBuV)	CORRECTION FACTOR (dB/m)
1	11020.00	49.8 PK	74.0	-24.2	2.29 H	266	34.63	15.17
2	11020.00	35.9 AV	54.0	-18.1	2.29 H	266	20.73	15.17
3	#16530.00	55.2 PK	74.0	-18.8	1.79 H	24	37.73	17.47
4	#16530.00	41.4 AV	54.0	-12.6	1.79 H	24	23.93	17.47

ANTENNA POLARITY & TEST DISTANCE: VERTICAL AT 3 M

NO.	FREQ. (MHz)	EMISSION LEVEL (dBuV/m)	LIMIT (dBuV/m)	MARGIN (dB)	ANTENNA HEIGHT (m)	TABLE ANGLE (Degree)	RAW VALUE (dBuV)	CORRECTION FACTOR (dB/m)
1	11020.00	49.1 PK	74.0	-24.9	1.02 V	295	33.93	15.17
2	11020.00	36.1 AV	54.0	-17.9	1.02 V	295	20.93	15.17
3	#16530.00	50.5 PK	74.0	-23.5	1.20 V	11	33.03	17.47
4	#16530.00	39.8 AV	54.0	-14.2	1.20 V	11	22.33	17.47

REMARKS:

1. Emission Level(dBuV/m) = Raw Value(dBuV) + Correction Factor(dB/m)
2. Correction Factor(dB/m) = Antenna Factor(dB/m) + Cable Factor(dB) – Pre-Amplifier Factor(dB)
3. The other emission levels were very low against the limit.
4. Margin value = Emission Level – Limit value
5. " # ": The radiated frequency is out of the restricted band.



CHANNEL	TX Channel 110	DETECTOR FUNCTION	Peak (PK)
FREQUENCY RANGE	1GHz ~ 40GHz		Average (AV)

ANTENNA POLARITY & TEST DISTANCE: HORIZONTAL AT 3 M

NO.	FREQ. (MHz)	EMISSION LEVEL (dBuV/m)	LIMIT (dBuV/m)	MARGIN (dB)	ANTENNA HEIGHT (m)	TABLE ANGLE (Degree)	RAW VALUE (dBuV)	CORRECTION FACTOR (dB/m)
1	11100.00	49.9 PK	74.0	-24.1	2.34 H	267	34.73	15.17
2	11100.00	36.0 AV	54.0	-18.0	2.34 H	267	20.83	15.17
3	#16650.00	55.3 PK	74.0	-18.7	1.76 H	26	37.26	18.04
4	#16650.00	41.9 AV	54.0	-12.1	1.76 H	26	23.86	18.04

ANTENNA POLARITY & TEST DISTANCE: VERTICAL AT 3 M

NO.	FREQ. (MHz)	EMISSION LEVEL (dBuV/m)	LIMIT (dBuV/m)	MARGIN (dB)	ANTENNA HEIGHT (m)	TABLE ANGLE (Degree)	RAW VALUE (dBuV)	CORRECTION FACTOR (dB/m)
1	11100.00	49.5 PK	74.0	-24.5	1.04 V	314	34.33	15.17
2	11100.00	36.4 AV	54.0	-17.6	1.04 V	314	21.23	15.17
3	#16650.00	49.7 PK	74.0	-24.3	1.21 V	8	31.66	18.04
4	#16650.00	39.3 AV	54.0	-14.7	1.21 V	8	21.26	18.04

REMARKS:

1. Emission Level(dBuV/m) = Raw Value(dBuV) + Correction Factor(dB/m)
2. Correction Factor(dB/m) = Antenna Factor(dB/m) + Cable Factor(dB) – Pre-Amplifier Factor(dB)
3. The other emission levels were very low against the limit.
4. Margin value = Emission Level – Limit value
5. " # ": The radiated frequency is out of the restricted band.



CHANNEL	TX Channel 134	DETECTOR FUNCTION	Peak (PK)
FREQUENCY RANGE	1GHz ~ 40GHz		Average (AV)

ANTENNA POLARITY & TEST DISTANCE: HORIZONTAL AT 3 M

NO.	FREQ. (MHz)	EMISSION LEVEL (dBuV/m)	LIMIT (dBuV/m)	MARGIN (dB)	ANTENNA HEIGHT (m)	TABLE ANGLE (Degree)	RAW VALUE (dBuV)	CORRECTION FACTOR (dB/m)
1	11340.00	49.5 PK	74.0	-24.5	2.24 H	256	34.21	15.29
2	11340.00	35.5 AV	54.0	-18.5	2.24 H	256	20.21	15.29
3	#17010.00	54.9 PK	74.0	-19.1	1.78 H	16	34.97	19.93
4	#17010.00	41.2 AV	54.0	-12.8	1.78 H	16	21.27	19.93

ANTENNA POLARITY & TEST DISTANCE: VERTICAL AT 3 M

NO.	FREQ. (MHz)	EMISSION LEVEL (dBuV/m)	LIMIT (dBuV/m)	MARGIN (dB)	ANTENNA HEIGHT (m)	TABLE ANGLE (Degree)	RAW VALUE (dBuV)	CORRECTION FACTOR (dB/m)
1	11340.00	49.9 PK	74.0	-24.1	1.02 V	309	34.61	15.29
2	11340.00	36.7 AV	54.0	-17.3	1.02 V	309	21.41	15.29
3	#17010.00	50.4 PK	74.0	-23.6	1.23 V	12	30.47	19.93
4	#17010.00	39.7 AV	54.0	-14.3	1.23 V	12	19.77	19.93

REMARKS:

1. Emission Level(dBuV/m) = Raw Value(dBuV) + Correction Factor(dB/m)
2. Correction Factor(dB/m) = Antenna Factor(dB/m) + Cable Factor(dB) – Pre-Amplifier Factor(dB)
3. The other emission levels were very low against the limit.
4. Margin value = Emission Level – Limit value
5. " # ": The radiated frequency is out of the restricted band.



CHANNEL	TX Channel 151	DETECTOR FUNCTION	Peak (PK)
FREQUENCY RANGE	1GHz ~ 40GHz		Average (AV)

ANTENNA POLARITY & TEST DISTANCE: HORIZONTAL AT 3 M

NO.	FREQ. (MHz)	EMISSION LEVEL (dBuV/m)	LIMIT (dBuV/m)	MARGIN (dB)	ANTENNA HEIGHT (m)	TABLE ANGLE (Degree)	RAW VALUE (dBuV)	CORRECTION FACTOR (dB/m)
1	11510.00	49.2 PK	74.0	-24.8	2.28 H	271	34.06	15.14
2	11510.00	35.5 AV	54.0	-18.5	2.28 H	271	20.36	15.14
3	#17265.00	54.4 PK	74.0	-19.6	1.84 H	10	34.41	19.99
4	#17265.00	41.1 AV	54.0	-12.9	1.84 H	10	21.11	19.99

ANTENNA POLARITY & TEST DISTANCE: VERTICAL AT 3 M

NO.	FREQ. (MHz)	EMISSION LEVEL (dBuV/m)	LIMIT (dBuV/m)	MARGIN (dB)	ANTENNA HEIGHT (m)	TABLE ANGLE (Degree)	RAW VALUE (dBuV)	CORRECTION FACTOR (dB/m)
1	11510.00	49.9 PK	74.0	-24.1	1.09 V	299	34.76	15.14
2	11510.00	36.8 AV	54.0	-17.2	1.09 V	299	21.66	15.14
3	#17265.00	50.1 PK	74.0	-23.9	1.25 V	0	30.11	19.99
4	#17265.00	39.7 AV	54.0	-14.3	1.25 V	0	19.71	19.99

REMARKS:

1. Emission Level(dBuV/m) = Raw Value(dBuV) + Correction Factor(dB/m)
2. Correction Factor(dB/m) = Antenna Factor(dB/m) + Cable Factor(dB) – Pre-Amplifier Factor(dB)
3. The other emission levels were very low against the limit.
4. Margin value = Emission Level – Limit value
5. " # ": The radiated frequency is out of the restricted band.



CHANNEL	TX Channel 159	DETECTOR FUNCTION	Peak (PK)
FREQUENCY RANGE	1GHz ~ 40GHz		Average (AV)

ANTENNA POLARITY & TEST DISTANCE: HORIZONTAL AT 3 M

NO.	FREQ. (MHz)	EMISSION LEVEL (dBuV/m)	LIMIT (dBuV/m)	MARGIN (dB)	ANTENNA HEIGHT (m)	TABLE ANGLE (Degree)	RAW VALUE (dBuV)	CORRECTION FACTOR (dB/m)
1	11590.00	49.1 PK	74.0	-24.9	2.34 H	284	33.99	15.11
2	11590.00	35.4 AV	54.0	-18.6	2.34 H	284	20.29	15.11
3	#17385.00	54.5 PK	74.0	-19.5	1.84 H	34	33.88	20.62
4	#17385.00	41.2 AV	54.0	-12.8	1.84 H	34	20.58	20.62

ANTENNA POLARITY & TEST DISTANCE: VERTICAL AT 3 M

NO.	FREQ. (MHz)	EMISSION LEVEL (dBuV/m)	LIMIT (dBuV/m)	MARGIN (dB)	ANTENNA HEIGHT (m)	TABLE ANGLE (Degree)	RAW VALUE (dBuV)	CORRECTION FACTOR (dB/m)
1	11590.00	49.9 PK	74.0	-24.1	1.02 V	300	34.79	15.11
2	11590.00	36.7 AV	54.0	-17.3	1.02 V	300	21.59	15.11
3	#17385.00	50.6 PK	74.0	-23.4	1.20 V	0	29.98	20.62
4	#17385.00	40.0 AV	54.0	-14.0	1.20 V	0	19.38	20.62

REMARKS:

1. Emission Level(dBuV/m) = Raw Value(dBuV) + Correction Factor(dB/m)
2. Correction Factor(dB/m) = Antenna Factor(dB/m) + Cable Factor(dB) – Pre-Amplifier Factor(dB)
3. The other emission levels were very low against the limit.
4. Margin value = Emission Level – Limit value
5. " # ": The radiated frequency is out of the restricted band.

Below 1GHz Data:
802.11a

CHANNEL	TX Channel 52	DETECTOR FUNCTION	Quasi-Peak (QP)
FREQUENCY RANGE	30MHz ~ 1GHz		

ANTENNA POLARITY & TEST DISTANCE: HORIZONTAL AT 3 M

NO.	FREQ. (MHz)	EMISSION LEVEL (dBuV/m)	LIMIT (dBuV/m)	MARGIN (dB)	ANTENNA HEIGHT (m)	TABLE ANGLE (Degree)	RAW VALUE (dBuV)	CORRECTION FACTOR (dB/m)
1	47.24	30.1 QP	40.0	-10.0	1.00 H	226	29.13	0.92
2	150.01	33.4 QP	43.5	-10.1	1.00 H	96	32.40	0.96
3	250.00	42.7 QP	46.0	-3.3	1.00 H	299	42.87	-0.17
4	350.00	32.2 QP	46.0	-13.8	1.00 H	89	29.45	2.78
5	391.49	38.3 QP	46.0	-7.7	1.00 H	160	34.37	3.89
6	883.53	36.9 QP	46.0	-9.1	1.00 H	261	23.99	12.87

ANTENNA POLARITY & TEST DISTANCE: VERTICAL AT 3 M

NO.	FREQ. (MHz)	EMISSION LEVEL (dBuV/m)	LIMIT (dBuV/m)	MARGIN (dB)	ANTENNA HEIGHT (m)	TABLE ANGLE (Degree)	RAW VALUE (dBuV)	CORRECTION FACTOR (dB/m)
1	32.59	36.7 QP	40.0	-3.4	1.00 V	84	37.03	-0.38
2	38.14	30.9 QP	40.0	-9.1	1.00 V	78	30.67	0.21
3	49.81	33.0 QP	40.0	-7.0	1.00 V	210	32.02	1.02
4	66.91	31.9 QP	40.0	-8.1	1.00 V	128	32.39	-0.45
5	250.00	35.3 QP	46.0	-10.8	1.00 V	359	35.42	-0.17
6	391.52	34.9 QP	46.0	-11.1	1.00 V	316	31.03	3.89

REMARKS:

1. Emission Level(dBuV/m) = Raw Value(dBuV) + Correction Factor(dB/m)
2. Correction Factor(dB/m) = Antenna Factor(dB/m) + Cable Factor(dB) – Pre-Amplifier Factor(dB)
3. The other emission levels were very low against the limit.
4. Margin value = Emission Level – Limit value

4.2 Conducted Emission Measurement

4.2.1 Limits of Conducted Emission Measurement

Frequency (MHz)	Conducted Limit (dBuV)	
	Quasi-peak	Average
0.15 - 0.5	66 - 56	56 - 46
0.50 - 5.0	56	46
5.0 - 30.0	60	50

Note: 1. The lower limit shall apply at the transition frequencies.

2. The limit decreases in line with the logarithm of the frequency in the range of 0.15 to 0.50MHz.

4.2.2 Test Instruments

DESCRIPTION & MANUFACTURER	MODEL NO.	SERIAL NO.	CALIBRATED DATE	CALIBRATED UNTIL
Test Receiver R&S	ESCS 30	847124/029	Oct. 23, 2015	Oct. 22, 2016
Line-Impedance Stabilization Network (for EUT) R&S	ESH3-Z5	848773/004	Oct. 28, 2015	Oct. 27, 2016
RF Cable	5D-FB	COACAB-002	Mar. 04, 2016	Mar. 03, 2017
Software BVADT	BVADT_Cond_ V7.3.7.3	NA	NA	NA

Note:

1. The calibration interval of the above test instruments are 12 months and the calibrations are traceable to NML/ROC and NIST/USA.
2. The test was performed in Shielded Room No. 1.
3. Tested Date: Apr. 29, 2016

4.2.3 Test Procedure

- The EUT was placed 0.4 meters from the conducting wall of the shielded room with EUT being connected to the power mains through a line impedance stabilization network (LISN). Other support units were connected to the power mains through another LISN. The two LISNs provide 50 ohm/ 50uH of coupling impedance for the measuring instrument.
- Both lines of the power mains connected to the EUT were checked for maximum conducted interference.
- The frequency range from 150kHz to 30MHz was searched. Emission levels under (Limit - 20dB) was not recorded.

NOTE: All modes of operation were investigated and the worst-case emissions are reported.

4.2.4 Deviation from Test Standard

No deviation.

4.2.5 Test Setup

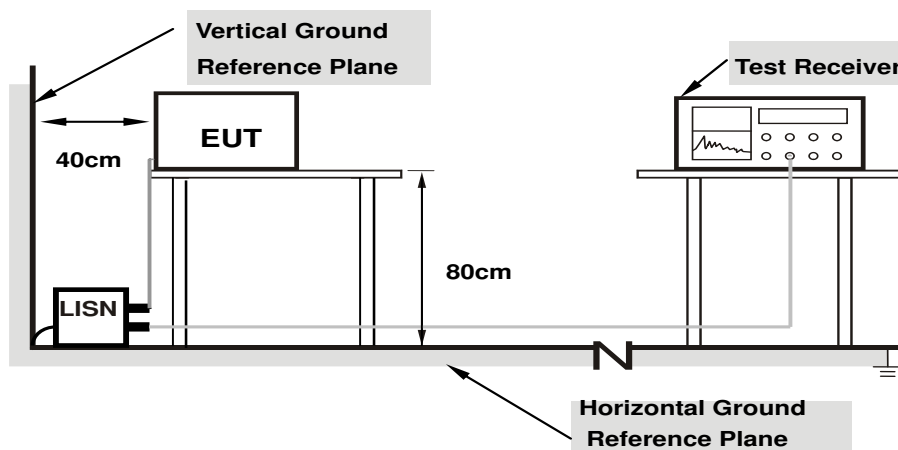

Note: 1.Support units were connected to second LISN.

For the actual test configuration, please refer to the attached file (Test Setup Photo).

4.2.6 EUT Operating Condition

Same as 4.1.6.

4.2.7 Test Results

Frequency Range	150kHz ~ 30MHz	Detector Function & Resolution Bandwidth	Quasi-Peak (QP) / Average (AV), 9kHz
Input Power	120Vac, 60Hz	Environmental Conditions	25°C, 64%RH
Tested by	Anderson chen		

Phase Of Power : Line (L)										
No	Frequency (MHz)	Correction Factor (dB)	Reading Value (dBuV)		Emission Level (dBuV)		Limit (dBuV)		Margin (dB)	
			Q.P.	AV.	Q.P.	AV.	Q.P.	AV.	Q.P.	AV.
1	0.15000	10.34	41.61	25.93	51.95	36.27	66.00	56.00	-14.05	-19.73
2	0.16562	10.32	39.57	25.70	49.89	36.02	65.18	55.18	-15.28	-19.15
3	0.29063	10.31	33.13	20.94	43.44	31.25	60.51	50.51	-17.06	-19.25
4	3.87500	10.60	18.08	10.74	28.68	21.34	56.00	46.00	-27.32	-24.66
5	17.37891	11.52	15.24	10.48	26.76	22.00	60.00	50.00	-33.24	-28.00
6	24.00000	11.79	15.87	13.68	27.66	25.47	60.00	50.00	-32.34	-24.53

Remarks:

1. Q.P. and AV. are abbreviations of quasi-peak and average individually.
2. The emission levels of other frequencies were very low against the limit.
3. Margin value = Emission level – Limit value
4. Correction factor = Insertion loss + Cable loss
5. Emission Level = Correction Factor + Reading Value

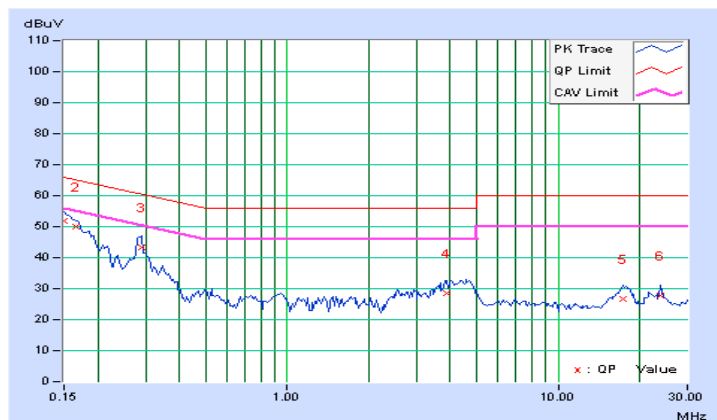

Frequency Range	150kHz ~ 30MHz	Detector Function & Resolution Bandwidth	Quasi-Peak (QP) / Average (AV), 9kHz
Input Power	120Vac, 60Hz	Environmental Conditions	25°C, 64%RH
Tested by	Anderson chen		

Phase Of Power : Neutral (N)										
No	Frequency (MHz)	Correction Factor (dB)	Reading Value (dBUV)		Emission Level (dBUV)		Limit (dBUV)		Margin (dB)	
			Q.P.	AV.	Q.P.	AV.	Q.P.	AV.	Q.P.	AV.
1	0.15000	10.32	41.80	24.99	52.12	35.31	66.00	56.00	-13.88	-20.69
2	0.15781	10.31	38.59	21.15	48.90	31.46	65.58	55.58	-16.68	-24.12
3	0.28672	10.30	35.23	28.46	45.53	38.76	60.62	50.62	-15.09	-11.86
4	2.98828	10.46	21.30	15.11	31.76	25.57	56.00	46.00	-24.24	-20.43
5	4.09375	10.58	23.37	17.13	33.95	27.71	56.00	46.00	-22.05	-18.29
6	21.55469	11.47	12.81	7.87	24.28	19.34	60.00	50.00	-35.72	-30.66

Remarks:

1. Q.P. and AV. are abbreviations of quasi-peak and average individually.
2. The emission levels of other frequencies were very low against the limit.
3. Margin value = Emission level – Limit value
4. Correction factor = Insertion loss + Cable loss
5. Emission Level = Correction Factor + Reading Value

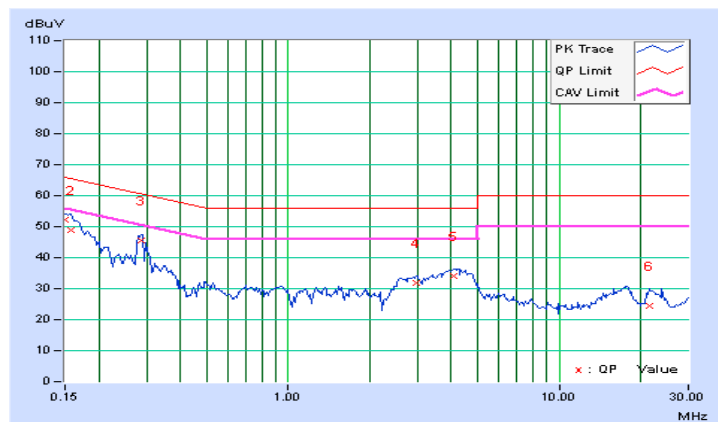

4.3 Transmit Power Measurement

4.3.1 Limits of Transmit Power Measurement

Operation Band	EUT Category		LIMIT
U-NII-1		Outdoor Access Point	1 Watt (30 dBm) (Max. e.i.r.p \leq 125mW(21 dBm) at any elevation angle above 30 degrees as measured from the horizon)
		Fixed point-to-point Access Point	1 Watt (30 dBm)
		Indoor Access Point	1 Watt (30 dBm)
	√	Mobile and Portable client device	250mW (24 dBm)
U-NII-2A		√	250mW (24 dBm) or 11 dBm+10 log B*
U-NII-2C		√	250mW (24 dBm) or 11 dBm+10 log B*
U-NII-3		√	1 Watt (30 dBm)

*B is the 26 dB emission bandwidth in megahertz

Per KDB 662911 Method of conducted output power measurement on IEEE 802.11 devices,

Array Gain = 0 dB (i.e., no array gain) for $N_{ANT} \leq 4$;

Array Gain = 0 dB (i.e., no array gain) for channel widths ≥ 40 MHz for any N_{ANT} ;

Array Gain = $5 \log(N_{ANT}/N_{SS})$ dB or 3 dB, whichever is less for 20-MHz channel widths with $N_{ANT} \geq 5$.

For power measurements on all other devices: Array Gain = $10 \log(N_{ANT}/N_{SS})$ dB.

4.3.2 Test Setup

FOR POWER OUTPUT MEASUREMENT

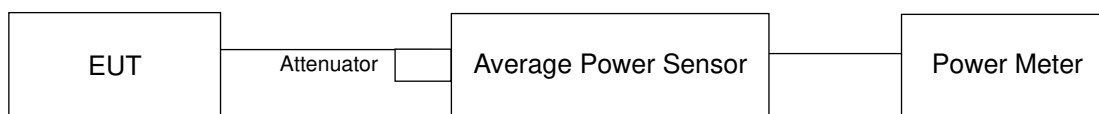

FOR 26dB OCCUPIED BANDWIDTH

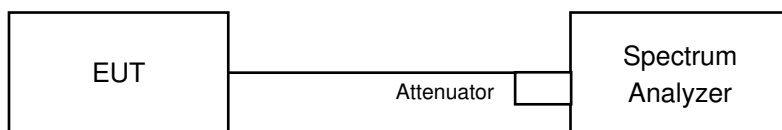

4.3.3 Test Instruments

DESCRIPTION & MANUFACTURER	MODEL NO.	SERIAL NO.	CALIBRATED DATE	CALIBRATED UNTIL
SPECTRUM ANALYZER R&S	FSP 40	100036	Jan. 27, 2016	Jan. 26, 2017
Power meter Anritsu	ML2495A	0824006	May 25, 2015	May 24, 2016
Power sensor Anritsu	MA2411B	0738172	May 25, 2015	May 24, 2016

Note:

1. The calibration interval of the above test instruments is 12 months and the calibrations are traceable to NML/ROC and NIST/USA.
2. The test was performed in 966 Chamber No. 3.
3. The FCC Site Registration No. is 147459
4. The CANADA Site Registration No. is 20331-1
5. Tested Date: Apr. 29, 2016

4.3.4 Test Procedure

FOR AVERAGE POWER MEASUREMENT

Method PM is used to perform output power measurement, trigger and gating function of wide band power meter is enabled to measure max output power of TX on burst. Duty factor is not added to measured value.

FOR 26dB OCCUPIED BANDWIDTH

1. Set RBW = approximately 1% of the emission bandwidth.
2. Set the VBW > RBW.
3. Detector = Peak.
4. Trace mode = max hold.
5. Measure the maximum width of the emission that is 26 dB down from the peak of the emission. Compare this with the RBW setting of the analyzer. Readjust RBW and repeat measurement as needed until the RBW/EBW ratio is approximately 1%.

4.3.5 Deviation from Test Standard

No deviation.

4.3.6 EUT Operating Condition

The software provided by client to enable the EUT under transmission condition continuously at lowest, middle and highest channel frequencies individually.



A D T

4.3.7 Test Result

POWER OUTPUT:

1TX

Antenna 1

802.11a

Chan.	Chan. Freq. (MHz)	Average Power (mW)	Average Power (dBm)	Limit (dBm)	Pass / Fail
36	5180	48.084	16.82	24	Pass
40	5200	88.105	19.45	24	Pass
48	5240	125.026	20.97	24	Pass
52	5260	122.18	20.87	24	Pass
60	5300	112.202	20.50	24	Pass
64	5320	63.241	18.01	24	Pass
100	5500	55.208	17.42	24	Pass
116	5580	91.622	19.62	24	Pass
140	5700	55.719	17.46	24	Pass
149	5745	55.59	17.45	30	Pass
157	5785	93.972	19.73	30	Pass
165	5825	78.886	18.97	30	Pass

26dB OCCUPIED BANDWIDTH

Channel	Frequency (MHz)	26dBc Bandwidth (MHz)
36	5180	25.08
40	5200	36.67
48	5240	31.33
52	5260	38.35
60	5300	40.09
64	5320	38.57
100	5500	35.94
116	5580	38.20
140	5700	33.04

Note: For U-NII-2A, U-NII-2C Band output power limitation is determined based on 26dBc bandwidth

Power Limit = 11dBm + 10logB < U-NII-2A, U-NII-2C >			
Channel Number	Freq.(MHz)	Min. B(MHz)	Determined Conducted Limit (dBm)
52	5260	38.35	26.83 > 24
60	5300	40.09	27.03 > 24
64	5320	38.57	26.86 > 24
100	5500	35.94	26.55 > 24
116	5580	38.20	26.82 > 24
140	5700	33.04	26.19 > 24

**802.11n (20MHz)**

Chan.	Chan. Freq. (MHz)	Average Power (mW)	Average Power (dBm)	Limit (dBm)	Pass / Fail
36	5180	52.24	17.18	24	Pass
40	5200	83.753	19.23	24	Pass
48	5240	119.95	20.79	24	Pass
52	5260	122.462	20.88	24	Pass
60	5300	90.573	19.57	24	Pass
64	5320	51.404	17.11	24	Pass
100	5500	52.481	17.20	24	Pass
116	5580	84.918	19.29	24	Pass
140	5700	54.075	17.33	24	Pass
149	5745	54.576	17.37	30	Pass
157	5785	94.624	19.76	30	Pass
165	5825	79.068	18.98	30	Pass

26dB OCCUPIED BANDWIDTH

Channel	Frequency (MHz)	26dBc Bandwidth (MHz)
36	5180	26.10
40	5200	28.69
48	5240	29.21
52	5260	30.26
60	5300	32.84
64	5320	33.22
100	5500	25.85
116	5580	33.51
140	5700	34.13

Note: For U-NII-2A, U-NII-2C Band output power limitation is determined based on 26dBc bandwidth

Power Limit = 11dBm + 10logB < U-NII-2A, U-NII-2C >			
Channel Number	Freq.(MHz)	Min. B(MHz)	Determined Conducted Limit (dBm)
52	5260	30.26	25.8 > 24
60	5300	32.84	26.16 > 24
64	5320	33.22	26.21 > 24
100	5500	25.85	25.12 > 24
116	5580	33.51	26.25 > 24
140	5700	34.13	26.33 > 24

**802.11n (40MHz)**

Chan.	Chan. Freq. (MHz)	Average Power (mW)	Average Power (dBm)	Limit (dBm)	Pass / Fail
38	5190	30.479	14.84	24	Pass
46	5230	83.368	19.21	24	Pass
54	5270	85.901	19.34	24	Pass
62	5310	30.69	14.87	24	Pass
102	5510	25.823	14.12	24	Pass
110	5550	66.527	18.23	24	Pass
134	5670	64.714	18.11	24	Pass
151	5755	38.548	15.86	30	Pass
159	5795	64.863	18.12	30	Pass

26dB OCCUPIED BANDWIDTH

Channel	Frequency (MHz)	26dBc Bandwidth (MHz)
38	5190	46.42
46	5230	81.72
54	5270	90.12
62	5310	89.86
102	5510	84.47
110	5550	78.55
134	5670	84.07

Note: For U-NII-2A, U-NII-2C Band output power limitation is determined based on 26dBc bandwidth

Power Limit = 11dBm + 10logB < U-NII-2A, U-NII-2C >			
Channel Number	Freq.(MHz)	Min. B(MHz)	Determined Conducted Limit (dBm)
54	5270	90.12	30.54 > 24
62	5310	89.86	30.53 > 24
102	5510	84.47	30.26 > 24
110	5550	78.55	29.95 > 24
134	5670	84.07	30.24 > 24

Spectrum Plot of Worst Value

802.11a / CH36

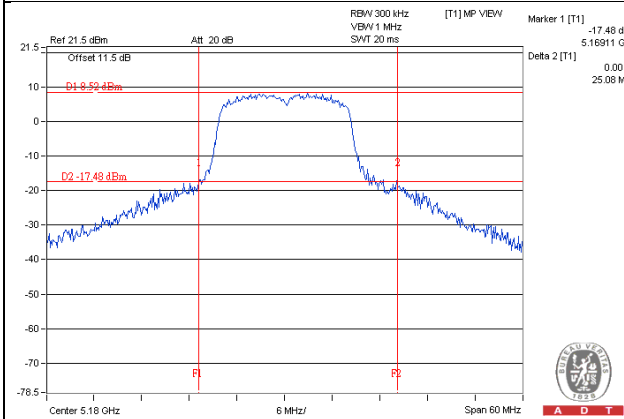

802.11n (20MHz) / CH100

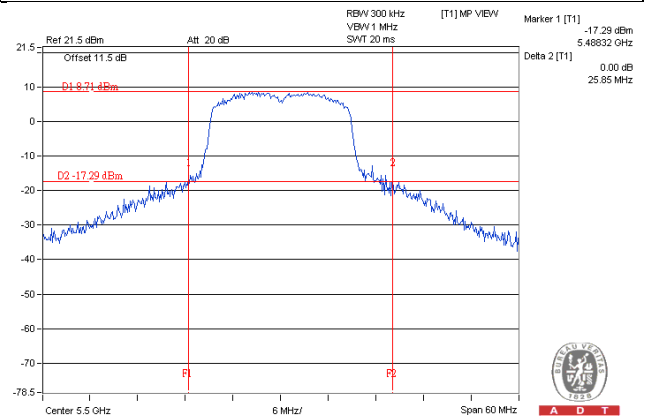

802.11n (40MHz) / CH38

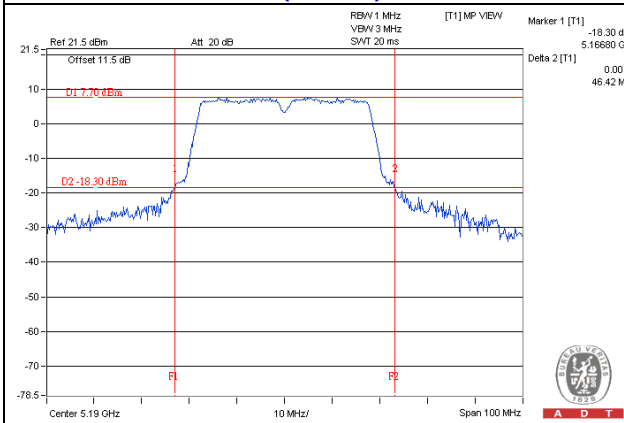

**Antenna 2****802.11a**

Chan.	Chan. Freq. (MHz)	Average Power (mW)	Average Power (dBm)	Limit (dBm)	Pass / Fail
36	5180	57.016	17.56	24	Pass
40	5200	97.499	19.89	24	Pass
48	5240	108.143	20.34	24	Pass
52	5260	110.662	20.44	24	Pass
60	5300	99.083	19.96	24	Pass
64	5320	62.373	17.95	24	Pass
100	5500	55.847	17.47	24	Pass
116	5580	73.451	18.66	24	Pass
140	5700	33.497	15.25	24	Pass
149	5745	42.954	16.33	30	Pass
157	5785	66.222	18.21	30	Pass
165	5825	54.2	17.34	30	Pass

26dB OCCUPIED BANDWIDTH

Channel	Frequency (MHz)	26dBc Bandwidth (MHz)
36	5180	36.77
40	5200	40.11
48	5240	38.22
52	5260	38.68
60	5300	36.67
64	5320	28.16
100	5500	34.27
116	5580	31.63
140	5700	20.48

Note: For U-NII-2A, U-NII-2C Band output power limitation is determined based on 26dBc bandwidth

Power Limit = 11dBm + 10logB < U-NII-2A, U-NII-2C >			
Channel Number	Freq.(MHz)	Min. B(MHz)	Determined Conducted Limit (dBm)
52	5260	38.68	26.87 > 24
60	5300	36.67	26.64 > 24
64	5320	28.16	25.49 > 24
100	5500	34.27	26.34 > 24
116	5580	31.63	26 > 24
140	5700	20.48	24.11 > 24



802.11n (20MHz)

Chan.	Chan. Freq. (MHz)	Average Power (mW)	Average Power (dBm)	Limit (dBm)	Pass / Fail
36	5180	64.863	18.12	24	Pass
40	5200	97.051	19.87	24	Pass
48	5240	105.925	20.25	24	Pass
52	5260	108.643	20.36	24	Pass
60	5300	97.051	19.87	24	Pass
64	5320	58.21	17.65	24	Pass
100	5500	61.518	17.89	24	Pass
116	5580	72.277	18.59	24	Pass
140	5700	35.81	15.54	24	Pass
149	5745	41.976	16.23	30	Pass
157	5785	67.92	18.32	30	Pass
165	5825	56.885	17.55	30	Pass

26dB OCCUPIED BANDWIDTH

Channel	Frequency (MHz)	26dBc Bandwidth (MHz)
36	5180	39.03
40	5200	35.15
48	5240	33.87
52	5260	28.56
60	5300	30.89
64	5320	21.07
100	5500	22.84
116	5580	25.09
140	5700	23.54

Note: For U-NII-2A, U-NII-2C Band output power limitation is determined based on 26dBc bandwidth

Power Limit = 11dBm + 10logB < U-NII-2A, U-NII-2C >			
Channel Number	Freq.(MHz)	Min. B(MHz)	Determined Conducted Limit (dBm)
52	5260	28.56	25.55 > 24
60	5300	30.89	25.89 > 24
64	5320	21.07	24.23 > 24
100	5500	22.84	24.58 > 24
116	5580	25.09	24.99 > 24
140	5700	23.54	24.71 > 24



802.11n (40MHz)

Chan.	Chan. Freq. (MHz)	Average Power (mW)	Average Power (dBm)	Limit (dBm)	Pass / Fail
38	5190	38.107	15.81	24	Pass
46	5230	86.099	19.35	24	Pass
54	5270	79.068	18.98	24	Pass
62	5310	28.642	14.57	24	Pass
102	5510	29.04	14.63	24	Pass
110	5550	61.518	17.89	24	Pass
134	5670	36.141	15.58	24	Pass
151	5755	24.434	13.88	30	Pass
159	5795	46.238	16.65	30	Pass

26dB OCCUPIED BANDWIDTH

Channel	Frequency (MHz)	26dBc Bandwidth (MHz)
38	5190	83.49
46	5230	75.97
54	5270	78.31
62	5310	58.66
102	5510	68.14
110	5550	59.48
134	5670	90.04

Note: For U-NII-2A, U-NII-2C Band output power limitation is determined based on 26dBc bandwidth

Power Limit = 11dBm + 10logB < U-NII-2A, U-NII-2C >			
Channel Number	Freq.(MHz)	Min. B(MHz)	Determined Conducted Limit (dBm)
54	5270	78.31	29.93 > 24
62	5310	58.66	28.68 > 24
102	5510	68.14	29.33 > 24
110	5550	59.48	28.74 > 24
134	5670	90.04	30.54 > 24

Spectrum Plot of Worst Value

802.11a / CH140

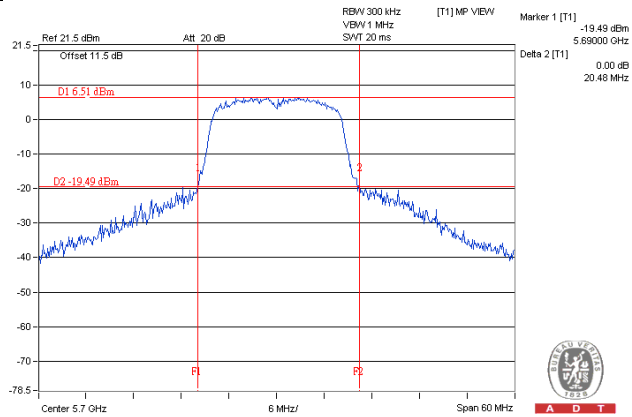

802.11n (20MHz) / CH64

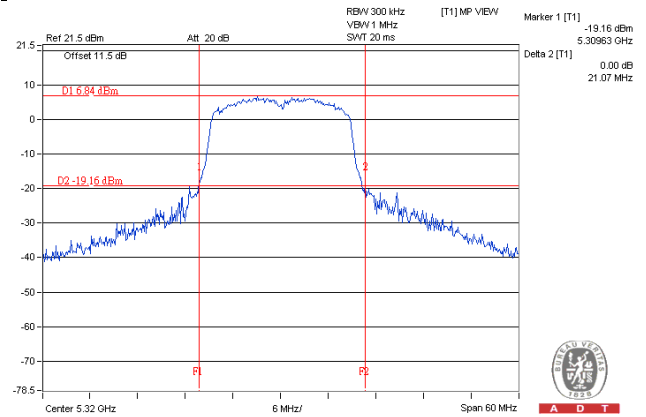

802.11n (40MHz) / CH62

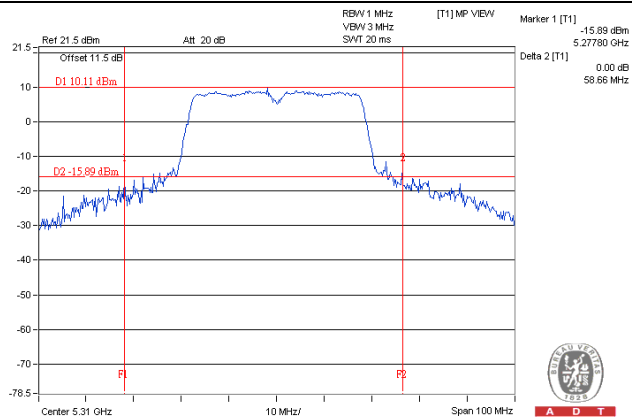

**2TX****CDD Mode****802.11a**

Chan.	Chan. Freq. (MHz)	Average Power (dBm)		Total Power (mW)	Total Power (dBm)	Limit (dBm)	Pass / Fail
		Chain 0	Chain 1				
36	5180	16.34	15.11	75.487	18.78	24	Pass
40	5200	19.52	18.25	156.37	21.94	24	Pass
48	5240	20.85	20.31	229.018	23.60	24	Pass
52	5260	20.96	20.12	227.54	23.57	24	Pass
60	5300	19.14	18.21	148.257	21.71	24	Pass
64	5320	16.54	15.58	81.223	19.10	24	Pass
100	5500	16.11	15.32	74.873	18.74	24	Pass
116	5580	19.45	18.38	156.97	21.96	24	Pass
140	5700	15.13	13.78	56.462	17.52	24	Pass
149	5745	16.33	14.31	69.931	18.45	30	Pass
157	5785	19.33	18.11	150.418	21.77	30	Pass
165	5825	17.35	16.02	94.319	19.75	30	Pass

26dB OCCUPIED BANDWIDTH

Channel	Frequency (MHz)	26dBc Bandwidth (MHz)	
		Chain 0	Chain 1
36	5180	33.62	33.87
40	5200	37.76	39.41
48	5240	38.41	34.47
52	5260	39.07	40.36
60	5300	40.66	36.86
64	5320	31.27	29.37
100	5500	38.97	31.74
116	5580	41.66	35.34
140	5700	32.58	22.07

Note: For U-NII-2A, U-NII-2C Band output power limitation is determined based on 26dBc bandwidth

Power Limit = 11dBm + 10logB < U-NII-2A, U-NII-2C >			
Channel Number	Freq.(MHz)	Min. B(MHz)	Determined Conducted Limit (dBm)
52	5260	39.07	26.91 > 24
60	5300	36.86	26.66 > 24
64	5320	29.37	25.67 > 24
100	5500	31.74	26.01 > 24
116	5580	35.34	26.48 > 24
140	5700	22.07	24.43 > 24

802.11n (20MHz)

Chan.	Chan. Freq. (MHz)	Average Power (dBm)		Total Power (mW)	Total Power (dBm)	Limit (dBm)	Pass / Fail
		Chain 0	Chain 1				
36	5180	16.59	15.11	78.038	18.92	24	Pass
40	5200	19.24	18.04	147.626	21.69	24	Pass
48	5240	20.89	20.11	225.309	23.53	24	Pass
52	5260	20.59	19.86	211.379	23.25	24	Pass
60	5300	19.11	18.14	146.633	21.66	24	Pass
64	5320	16.87	15.58	84.782	19.28	24	Pass
100	5500	15.58	14.77	66.133	18.20	24	Pass
116	5580	19.42	18.24	154.179	21.88	24	Pass
10	5700	15.20	13.78	56.991	17.56	24	Pass
49	5745	16.35	14.52	71.466	18.54	30	Pass
157	5785	19.10	17.86	142.377	21.53	30	Pass
165	5825	17.73	15.40	93.967	19.73	30	Pass

26dB OCCUPIED BANDWIDTH

Channel	Frequency (MHz)	26dBc Bandwidth (MHz)	
		Chain 0	Chain 1
36	5180	28.26	31.83
40	5200	34.82	38.93
48	5240	36.41	31.55
52	5260	36.52	34.12
60	5300	35.98	27.35
64	5320	31.29	24.86
100	5500	33.64	23.00
116	5580	36.38	26.31
140	5700	31.54	21.24

Note: For U-NII-2A, U-NII-2C Band output power limitation is determined based on 26dBc bandwidth

Power Limit = 11dBm + 10logB < U-NII-2A, U-NII-2C >			
Channel Number	Freq.(MHz)	Min. B(MHz)	Determined Conducted Limit (dBm)
52	5260	34.12	26.33 > 24
60	5300	27.35	25.36 > 24
64	5320	24.86	24.95 > 24
100	5500	23.00	24.61 > 24
116	5580	26.31	25.2 > 24
140	5700	21.24	24.27 > 24

802.11n (40MHz)

Chan.	Chan. Freq. (MHz)	Average Power (dBm)		Total Power (mW)	Total Power (dBm)	Limit (dBm)	Pass / Fail
		Chain 0	Chain 1				
38	5190	13.02	11.67	34.734	15.41	24	Pass
46	5230	17.99	16.85	111.368	20.47	24	Pass
54	5270	18.12	16.75	112.178	20.50	24	Pass
62	5310	13.39	12.24	38.576	15.86	24	Pass
102	5510	12.99	11.21	33.12	15.20	24	Pass
110	5550	14.86	15.11	63.054	18.00	24	Pass
134	5670	15.62	13.94	61.249	17.87	24	Pass
151	5755	14.08	12.16	42.03	16.24	30	Pass
159	5795	16.98	15.19	82.925	19.19	30	Pass

26dB OCCUPIED BANDWIDTH

Channel	Frequency (MHz)	26dBc Bandwidth (MHz)	
		Chain 0	Chain 1
38	5190	38.66	38.27
46	5230	39.19	41.55
54	5270	57.64	40.49
62	5310	38.75	38.34
102	5510	38.69	38.52
110	5550	51.68	38.70
134	5670	55.04	38.70

Note: For U-NII-2A, U-NII-2C Band output power limitation is determined based on 26dBc bandwidth

Power Limit = 11dBm + 10logB < U-NII-2A, U-NII-2C >			
Channel Number	Freq.(MHz)	Min. B(MHz)	Determined Conducted Limit (dBm)
54	5270	87.50	30.42 > 24
62	5310	48.28	27.83 > 24
102	5510	56.66	28.53 > 24
110	5550	75.84	29.79 > 24
134	5670	70.08	29.45 > 24

Spectrum Plot of Worst Value

802.11a_Chain 1 / CH140

802.11n (20MHz)_Chain 1 / CH140

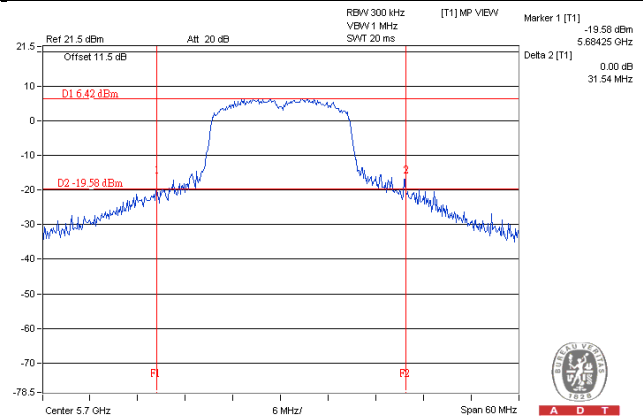
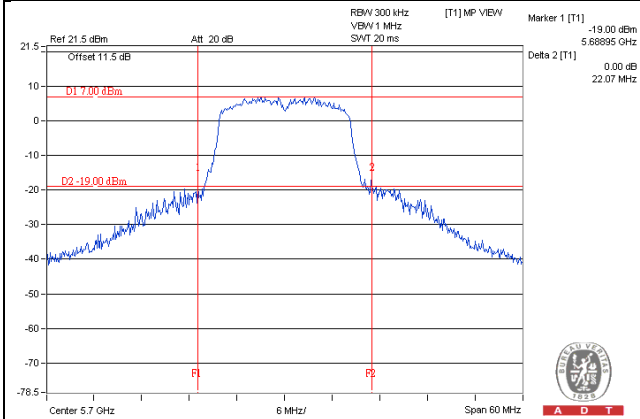

802.11n (40MHz)_Chain 1 / CH38

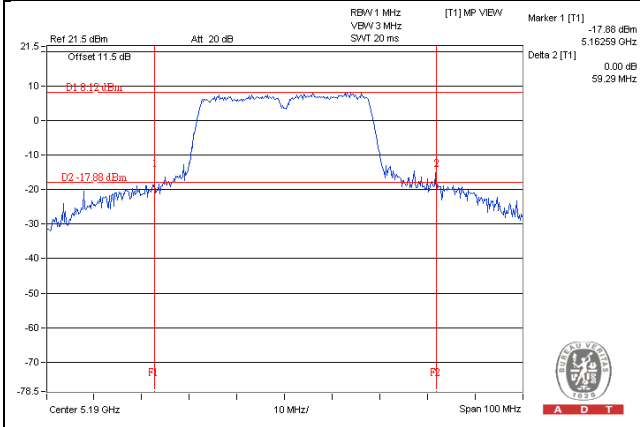

4.4 Peak Power Spectral Density Measurement

4.4.1 Limits of Peak Power Spectral Density Measurement

Operation Band	EUT Category		LIMIT
U-NII-1		Outdoor Access Point	17dBm/ MHz
		Fixed point-to-point Access Point	
		Indoor Access Point	
	√	Mobile and Portable client device	11dBm/ MHz
U-NII-2A	√		11dBm/ MHz
U-NII-2C	√		11dBm/ MHz
U-NII-3	√		30dBm/ 500kHz

4.4.2 Test Setup

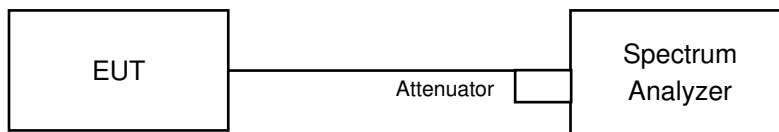

4.4.3 Test Instruments

Refer to section 4.3.3 to get information of above instrument.

4.4.4 Test Procedure

802.11a, 802.11n (20MHz), 802.11n (40MHz)

For U-NII-1, U-NII-2A, U-NII-2C band:

Using method SA-1

1. Set span to encompass the entire emission bandwidth (EBW) of the signal.
2. Set RBW = 1 MHz, Set VBW \geq 3 MHz, Detector = RMS
3. Sweep time = auto, trigger set to "free run".
4. Trace average at least 100 traces in power averaging mode.
5. Record the max value

For U-NII-3:

1. Set span to encompass the entire emission bandwidth (EBW) of the signal.
2. Set RBW = 300 kHz, Set VBW \geq 1 MHz, Detector = RMS
3. Use the peak marker function to determine the maximum power level in any 300 kHz band segment within the fundamental EBW.
4. Scale the observed power level to an equivalent value in 500 kHz by adjusting (reducing) the measured power by a bandwidth correction factor (BWCF) where $BWCF = 10\log(500 \text{ kHz}/300\text{kHz})$
5. Sweep time = auto, trigger set to "free run".
6. Trace average at least 100 traces in power averaging mode.
7. Record the max value and add $10 \log (1/\text{duty cycle})$

4.4.5 Deviation from Test Standard

No deviation.

4.4.6 EUT Operating Condition

Same as Item 4.3.6.

4.4.7 Test Results
 For U-NII-1, U-NII-2A, U-NII-2C

1TX

Antenna 1

802.11a

Chan.	Chan. Freq. (MHz)	PSD (dBm/MHz)	MAX. Limit (dBm/MHz)	Pass / Fail
36	5180	3.26	11	Pass
40	5200	5.89	11	Pass
48	5240	4.39	11	Pass
52	5260	5.97	11	Pass
60	5300	6.30	11	Pass
64	5320	6.02	11	Pass
100	5500	6.12	11	Pass
116	5580	5.83	11	Pass
140	5700	2.88	11	Pass

802.11n (20MHz)

Chan.	Chan. Freq. (MHz)	PSD (dBm/MHz)	MAX. Limit (dBm/MHz)	Pass / Fail
36	5180	2.78	11	Pass
40	5200	3.53	11	Pass
48	5240	3.61	11	Pass
52	5260	3.70	11	Pass
60	5300	4.11	11	Pass
64	5320	4.30	11	Pass
100	5500	3.83	11	Pass
116	5580	3.53	11	Pass
140	5700	2.57	11	Pass

802.11n (40MHz)

Chan.	Chan. Freq. (MHz)	PSD (dBm/MHz)	MAX. Limit (dBm/MHz)	Pass / Fail
38	5190	-3.40	11	Pass
46	5230	-0.21	11	Pass
54	5270	0.31	11	Pass
62	5310	-0.48	11	Pass
102	5510	0.28	11	Pass
110	5550	0.39	11	Pass
134	5670	-1.01	11	Pass

Spectrum Plot of Worst Value

802.11a / CH60

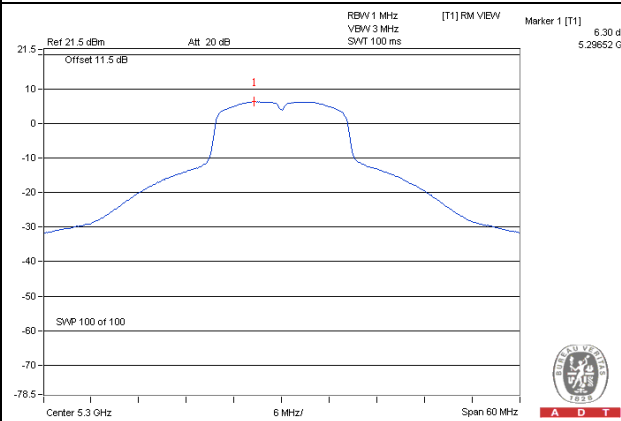

802.11n (20MHz) / CH64

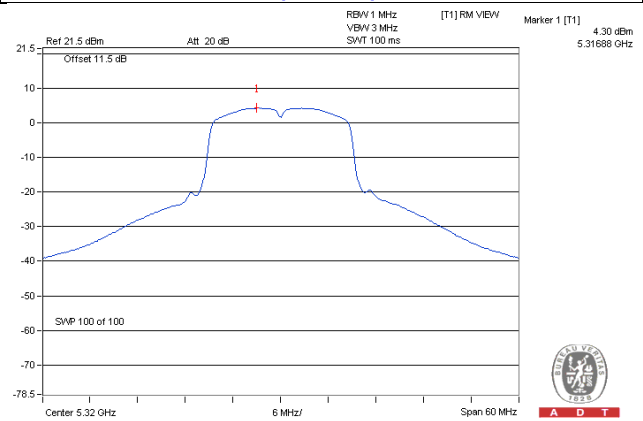

802.11n (40MHz) / CH110

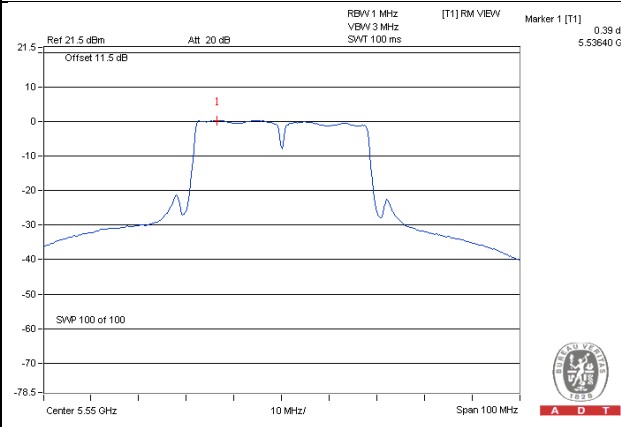

2TX
CDD Mode
802.11a

Chan.	Chan. Freq. (MHz)	PSD (dBm/MHz)		Total Power Density (dBm/MHz)	MAX. Limit (dBm/MHz)	Pass / Fail
		Chain 0	Chain 1			
36	5180	2.98	2.39	5.71	10.99	Pass
40	5200	5.15	5.20	8.19	10.99	Pass
48	5240	4.62	3.97	7.32	10.99	Pass
52	5260	6.06	5.68	8.88	10.58	Pass
60	5300	5.71	5.37	8.55	10.58	Pass
64	5320	3.72	3.61	6.68	10.58	Pass
100	5500	4.83	3.30	7.14	10.37	Pass
116	5580	4.89	3.78	7.38	10.37	Pass
140	5700	1.86	1.36	4.63	10.37	Pass

- Note:** 1. Method a) of power density measurement of KDB 662911 is using for calculating total power density. Total power density is summing entire spectra across corresponding frequency bins on the various outputs by computer.
2. For 5180~5240MHz: Directional gain = $10 \log[(10^{G1/20} + 10^{G2/20})^2 / 2] = 6.01\text{dBi} > 6\text{dBi}$, so the power density limit shall be reduced to $11-(6.01-6) = 10.99\text{dBm}$.
3. For 5260~5320MHz: Directional gain = $10 \log[(10^{G1/20} + 10^{G2/20})^2 / 2] = 6.42\text{dBi} > 6\text{dBi}$, so the power density limit shall be reduced to $11-(6.42-6) = 10.58\text{dBm}$.
4. For 5500~5700MHz: Directional gain = $10 \log[(10^{G1/20} + 10^{G2/20})^2 / 2] = 6.63\text{dBi} > 6\text{dBi}$, so the power density limit shall be reduced to $11-(6.63-6) = 10.37\text{dBm}$.

802.11n (20MHz)

Chan.	Chan. Freq. (MHz)	PSD (dBm/MHz)		Total Power Density (dBm/MHz)	MAX. Limit (dBm/MHz)	Pass / Fail
		Chain 0	Chain 1			
36	5180	2.86	2.02	5.47	10.99	Pass
40	5200	3.98	3.62	6.81	10.99	Pass
48	5240	3.84	3.31	6.59	10.99	Pass
52	5260	3.97	3.43	6.72	10.58	Pass
60	5300	4.00	3.29	6.67	10.58	Pass
64	5320	3.49	3.26	6.39	10.58	Pass
100	5500	3.19	1.46	5.42	10.37	Pass
116	5580	2.52	1.55	5.07	10.37	Pass
140	5700	1.52	0.63	4.11	10.37	Pass

- Note:**
- Method a) of power density measurement of KDB 662911 is using for calculating total power density. Total power density is summing entire spectra across corresponding frequency bins on the various outputs by computer.
 - For 5180~5240MHz: Directional gain = $10 \log[(10^{G1/20} + 10^{G2/20})^2 / 2] = 6.01\text{dBi} > 6\text{dBi}$, so the power density limit shall be reduced to $11-(6.01-6) = 10.99\text{dBm}$.
 - For 5260~5320MHz: Directional gain = $10 \log[(10^{G1/20} + 10^{G2/20})^2 / 2] = 6.42\text{dBi} > 6\text{dBi}$, so the power density limit shall be reduced to $11-(6.42-6) = 10.58\text{dBm}$.
 - For 5500~5700MHz: Directional gain = $10 \log[(10^{G1/20} + 10^{G2/20})^2 / 2] = 6.63\text{dBi} > 6\text{dBi}$, so the power density limit shall be reduced to $11-(6.63-6) = 10.37\text{dBm}$.

802.11n (40MHz)

Chan.	Chan. Freq. (MHz)	PSD (dBm/MHz)		Total Power Density (dBm/MHz)	MAX. Limit (dBm/MHz)	Pass / Fail
		Chain 0	Chain 1			
38	5190	-3.79	-3.47	-0.62	10.99	Pass
46	5230	0.25	-0.58	2.87	10.99	Pass
54	5270	0.32	0.09	3.22	10.58	Pass
62	5310	-2.14	-2.49	0.70	10.58	Pass
102	5510	-2.12	-3.66	0.19	10.37	Pass
110	5550	-0.54	-2.04	1.78	10.37	Pass
134	5670	-1.12	-1.75	1.59	10.37	Pass

- Note:**
- Method a) of power density measurement of KDB 662911 is using for calculating total power density. Total power density is summing entire spectra across corresponding frequency bins on the various outputs by computer.
 - For 5180~5240MHz: Directional gain = $10 \log[(10^{G1/20} + 10^{G2/20})^2 / 2] = 6.01\text{dBi} > 6\text{dBi}$, so the power density limit shall be reduced to $11-(6.01-6) = 10.99\text{dBm}$.
 - For 5260~5320MHz: Directional gain = $10 \log[(10^{G1/20} + 10^{G2/20})^2 / 2] = 6.42\text{dBi} > 6\text{dBi}$, so the power density limit shall be reduced to $11-(6.42-6) = 10.58\text{dBm}$.
 - For 5500~5700MHz: Directional gain = $10 \log[(10^{G1/20} + 10^{G2/20})^2 / 2] = 6.63\text{dBi} > 6\text{dBi}$, so the power density limit shall be reduced to $11-(6.63-6) = 10.37\text{dBm}$.

Spectrum Plot of Worst Value

802.11a_Chain 0 / CH52

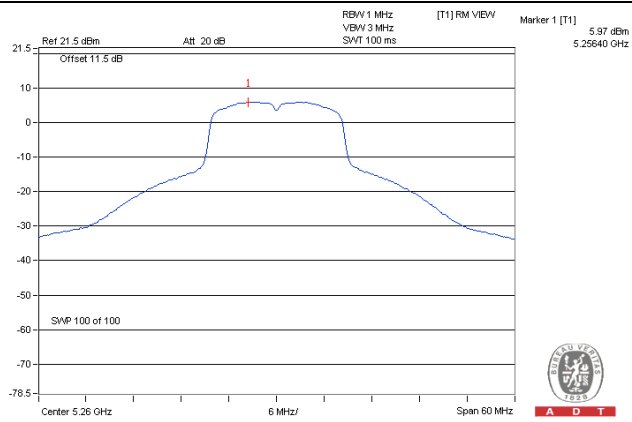

802.11n (20MHz)_Chain 0 / CH60

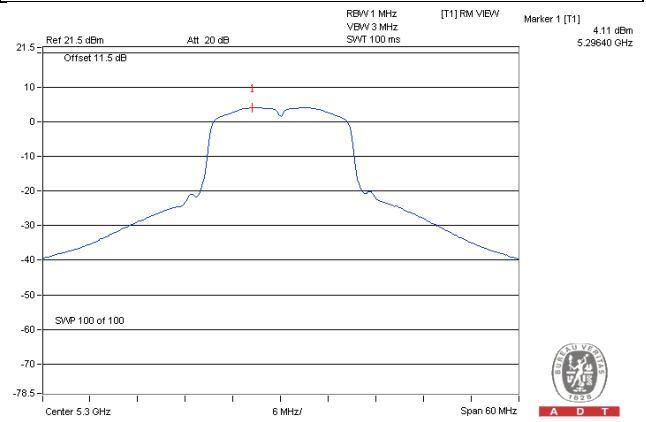

802.11n (40MHz)_Chain 0 / CH54

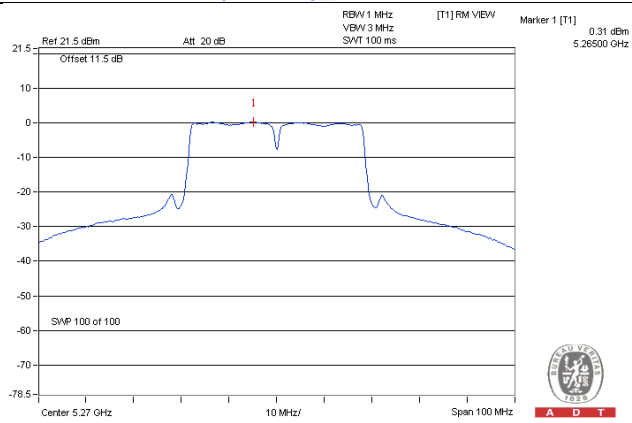

For U-NII-3:

1TX

Antenna 1

802.11a

Chan.	Chan. Freq. (MHz)	PSD (dBm/300kHz)	PSD (dBm/500kHz)	Limit (dBm/500kHz)	Pass /Fail
149	5745	-7.00	-4.78	30	Pass
157	5785	-2.64	-0.42	30	Pass
165	5825	-4.14	-1.92	30	Pass

802.11n (20MHz)

Chan.	Chan. Freq. (MHz)	PSD (dBm/300kHz)	PSD (dBm/500kHz)	Limit (dBm/500kHz)	Pass /Fail
149	5745	-6.75	-4.53	30	Pass
157	5785	-5.08	-2.86	30	Pass
165	5825	-4.47	-2.25	30	Pass

802.11n (40MHz)

Chan.	Chan. Freq. (MHz)	PSD (dBm/300kHz)	PSD (dBm/500kHz)	Limit (dBm/500kHz)	Pass /Fail
151	5755	-12.04	-9.82	30	Pass
159	5795	-8.70	-6.48	30	Pass

Spectrum Plot of Worst Value

802.11a / CH157

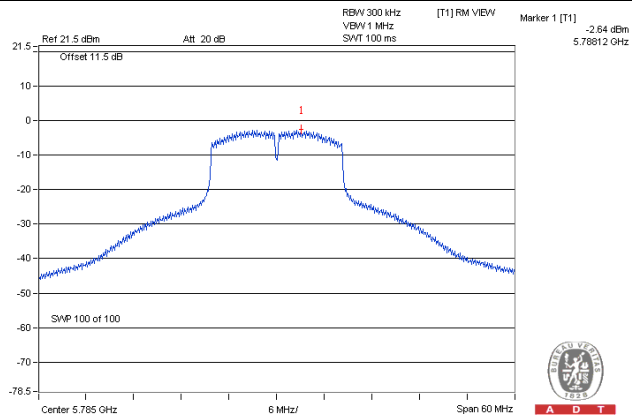

802.11n (20MHz) / CH165

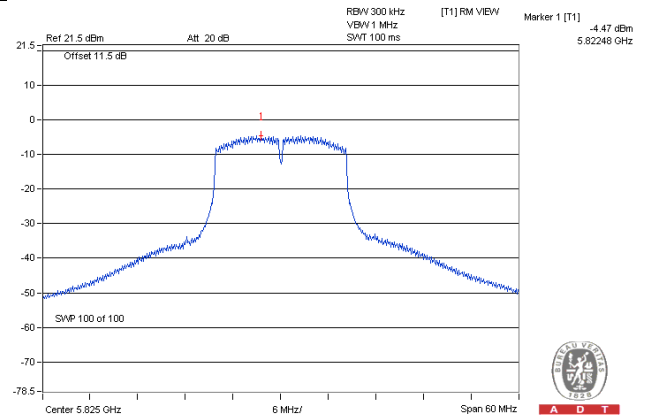

802.11n (40MHz) / CH159

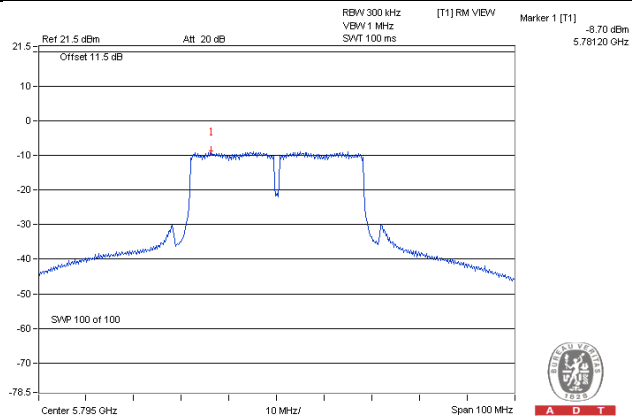

2TX Mode

CDD Mode

802.11a

TX chain	Channel	Freq. (MHz)	PSD (dBm/300k Hz)	PSD (dBm/500k Hz)	10 log (N=2) dB	Total PSD (dBm/500k Hz)	Limit (dBm/500k Hz)	Pass /Fail
0	149	5745	-6.18	-3.96	3.01	-0.95	30	Pass
	157	5785	-3.16	-0.94	3.01	2.07	30	Pass
	165	5825	-4.73	-2.51	3.01	0.50	30	Pass
1	149	5745	-6.65	-4.43	3.01	-1.42	30	Pass
	157	5785	-3.63	-1.41	3.01	1.60	30	Pass
	165	5825	-4.61	-2.39	3.01	0.62	30	Pass

Note: 1. Directional gain = $10 \log[(10^{G1/20} + 10^{G2/20})^2 / 2] = 5.71\text{dBi} < 6\text{dBi}$, so the power density limit shall not be reduced.

802.11n (20MHz)

TX chain	Channel	Freq. (MHz)	PSD (dBm/300k Hz)	PSD (dBm/500k Hz)	10 log (N=2) dB	Total PSD (dBm/500k Hz)	Limit (dBm/500k Hz)	Pass /Fail
0	149	5745	-7.02	-4.80	3.01	-1.79	30	Pass
	157	5785	-5.32	-3.10	3.01	-0.09	30	Pass
	165	5825	-5.66	-3.44	3.01	-0.43	30	Pass
1	149	5745	-6.95	-4.73	3.01	-1.72	30	Pass
	157	5785	-5.43	-3.21	3.01	-0.20	30	Pass
	165	5825	-5.18	-2.96	3.01	0.05	30	Pass

Note: 1. Directional gain = $10 \log[(10^{G1/20} + 10^{G2/20})^2 / 2] = 5.71\text{dBi} < 6\text{dBi}$, so the power density limit shall not be reduced.

802.11n (40MHz)

TX chain	Channel	Freq. (MHz)	PSD (dBm/300k Hz)	PSD (dBm/500k Hz)	10 log (N=2) dB	Total PSD (dBm/500k Hz)	Limit (dBm/500k Hz)	Pass /Fail
0	151	5755	-12.09	-9.87	3.01	-6.86	30	Pass
	159	5795	-9.19	-6.97	3.01	-3.96	30	Pass
1	151	5745	-12.39	-10.17	3.01	-7.16	30	Pass
	159	5785	-9.09	-6.87	3.01	-3.86	30	Pass

Note: 1. Directional gain = $10 \log[(10^{G1/20} + 10^{G2/20})^2 / 2] = 5.71\text{dBi} < 6\text{dBi}$, so the power density limit shall not be reduced.

Spectrum Plot of Worst Value

802.11a_Chain 0 / CH157

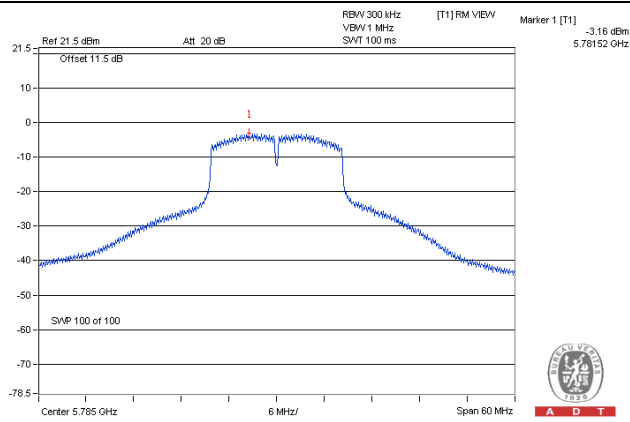

802.11n (20MHz)_Chain 1 / CH165

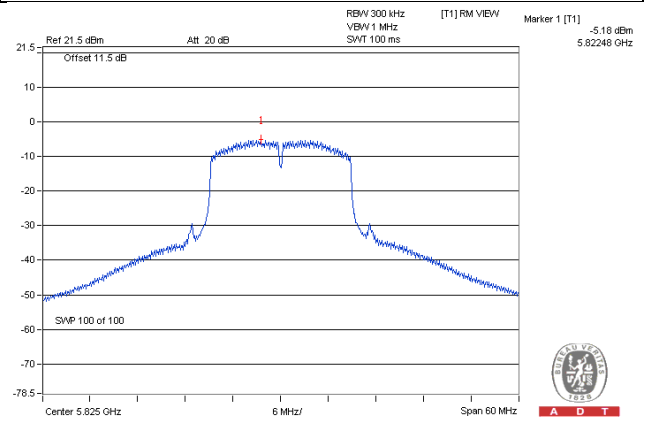

802.11n (40MHz)_Chain 1 / CH159

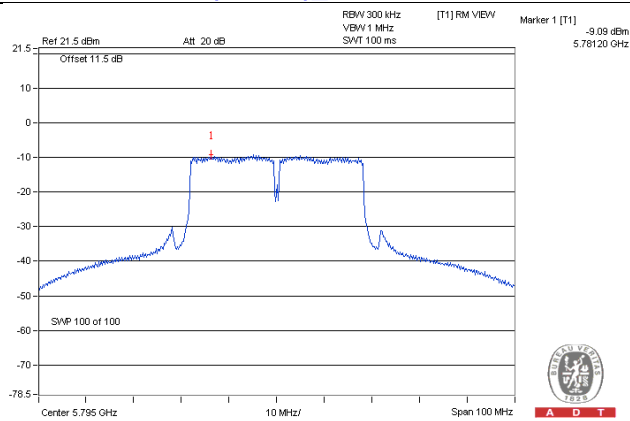

4.5 Frequency Stability Measurement

4.5.1 Limits of Frequency Stability Measurement

The frequency of the carrier signal shall be maintained within band of operation

4.5.2 Test Setup

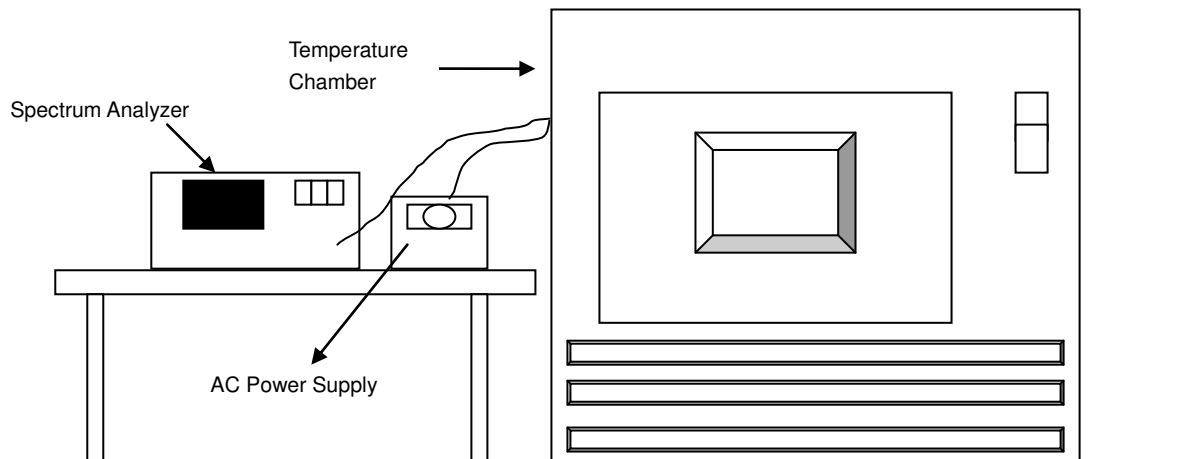

4.5.3 Test Instruments

Refer to section 4.1.2 to get information of above instrument.

4.5.4 Test Procedure

- The EUT was placed inside the environmental test chamber and powered by nominal AC voltage.
- Turn the EUT on and couple its output to a spectrum analyzer.
- Turn the EUT off and set the chamber to the highest temperature specified.
- Allow sufficient time (approximately 30 min) for the temperature of the chamber to stabilize, turn the EUT on and measure the operating frequency after 2, 5, and 10 minutes.
- Repeat step 2 and 3 with the temperature chamber set to the lowest temperature.
- The test chamber was allowed to stabilize at +20 degree C for a minimum of 30 minutes. The supply voltage was then adjusted on the EUT from 85% to 115% and the frequency record.

4.5.5 Deviation from Test Standard

No deviation.

4.5.6 EUT Operating Condition

Set the EUT transmit at un-modulation mode to test frequency stability.

4.5.7 Test Results

FREQUENCY STABILITY VERSUS TEMP.									
OPERATING FREQUENCY: 5180MHz									
TEMP. (°C)	POWER SUPPLY (Vac)	0 MINUTE		2 MINUTE		5 MINUTE		10 MINUTE	
		Measured Frequency (MHz)	Frequency Drift (%)	Measured Frequency (MHz)	Frequency Drift (%)	Measured Frequency (MHz)	Frequency Drift (%)	Measured Frequency (MHz)	Frequency Drift (%)
50	120	5179.9967	-0.00006	5179.9968	-0.00006	5179.9947	-0.00010	5179.9944	-0.00011
40	120	5179.9846	-0.00030	5179.9849	-0.00029	5179.983	-0.00033	5179.9803	-0.00038
30	120	5180.015	0.00029	5180.0131	0.00025	5180.0115	0.00022	5180.0133	0.00026
20	120	5180.0106	0.00020	5180.0082	0.00016	5180.0077	0.00015	5180.0087	0.00017
10	120	5180.0063	0.00012	5180.0044	0.00008	5180.0061	0.00012	5180.0065	0.00013
0	120	5180.0249	0.00048	5180.024	0.00046	5180.0279	0.00054	5180.0277	0.00053
-10	120	5180.0087	0.00017	5180.0087	0.00017	5180.0086	0.00017	5180.0098	0.00019
-20	120	5179.9839	-0.00031	5179.9847	-0.00030	5179.9831	-0.00033	5179.982	-0.00035
-30	120	5180.0155	0.00030	5180.0134	0.00026	5180.0156	0.00030	5180.0149	0.00029

FREQUENCY STABILITY VERSUS VOLTAGE									
OPERATING FREQUENCY: 5180MHz									
TEMP. (°C)	POWER SUPPLY (Vac)	0 MINUTE		2 MINUTE		5 MINUTE		10 MINUTE	
		Measured Frequency (MHz)	Frequency Drift (%)	Measured Frequency (MHz)	Frequency Drift (%)	Measured Frequency (MHz)	Frequency Drift (%)	Measured Frequency (MHz)	Frequency Drift (%)
20	138	5180.0106	0.00020	5180.0074	0.00014	5180.007	0.00014	5180.009	0.00017
	120	5180.0106	0.00020	5180.0082	0.00016	5180.0077	0.00015	5180.0087	0.00017
	102	5180.0105	0.00020	5180.0078	0.00015	5180.0072	0.00014	5180.0081	0.00016

4.6 6dB Bandwidth Measurement

4.6.1 Limits of 6dB Bandwidth Measurement

The minimum of 6dB Bandwidth Measurement is 0.5MHz.

4.6.2 Test Setup

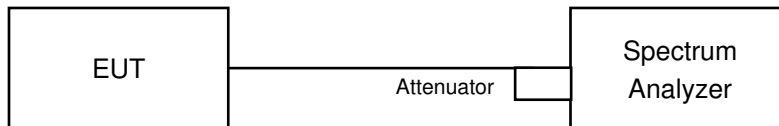

4.6.3 Test Instruments

Refer to section 4.3.3 to get information of above instrument.

4.6.4 Test Procedure

MEASUREMENT PROCEDURE REF

- a. Set resolution bandwidth (RBW) = 100kHz
- b. Set the video bandwidth (VBW) $\geq 3 \times$ RBW, Detector = Peak.
- c. Trace mode = max hold.
- d. Sweep = auto couple.
- e. Measure the maximum width of the emission that is constrained by the frequencies associated with the two amplitude points (upper and lower) that are attenuated by 6 dB relative to the maximum level measured in the fundamental emission

4.6.5 Deviation from Test Standard

No deviation.

4.6.6 EUT Operating Condition

The software provided by client to enable the EUT under transmission condition continuously at lowest, middle and highest channel frequencies individually.

4.6.7 Test Results

1TX Mode**802.11a**

Channel	Frequency (MHz)	6dB Bandwidth (MHz)	Minimum Limit (MHz)	Pass / Fail
149	5745	15.84	0.5	Pass
157	5785	15.35	0.5	Pass
165	5825	15.83	0.5	Pass

802.11n (20MHz)

Channel	Frequency (MHz)	6dB Bandwidth (MHz)	Minimum Limit (MHz)	Pass / Fail
149	5745	15.39	0.5	Pass
157	5785	15.19	0.5	Pass
165	5825	15.48	0.5	Pass

802.11n (40MHz)

Channel	Frequency (MHz)	6dB Bandwidth (MHz)	Minimum Limit (MHz)	Pass / Fail
151	5745	36.43	0.5	Pass
159	5785	36.44	0.5	Pass

Spectrum Plot of Worst Value

802.11a / CH157

802.11n (20MHz) / CH157

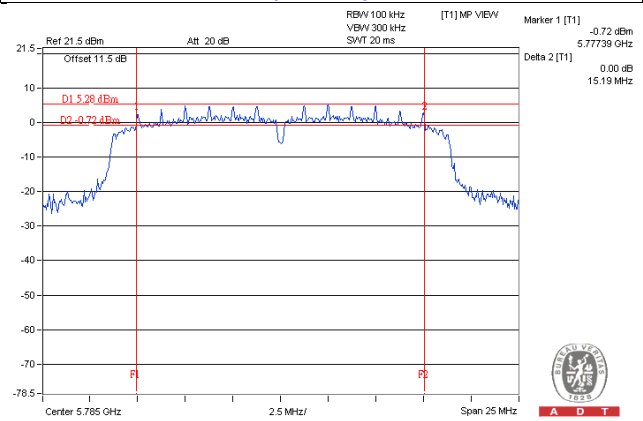
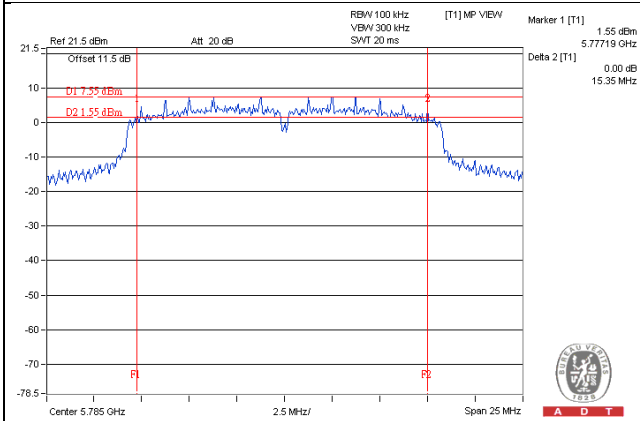

802.11n (40MHz) / CH151

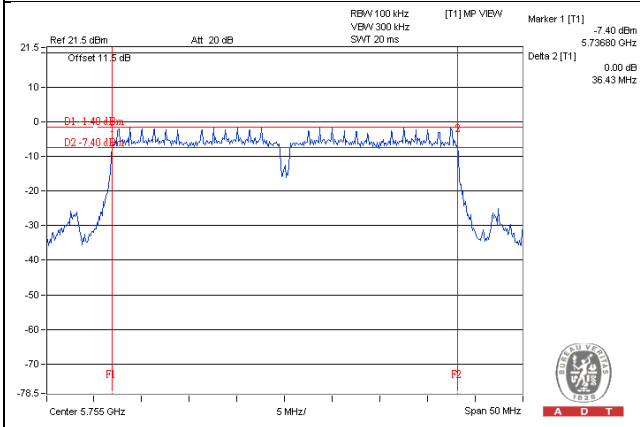

**2TX Mode****CDD Mode****802.11a**

Channel	Frequency (MHz)	6dB Bandwidth (MHz)		Minimum Limit (MHz)	Pass / Fail
		Chain 0	Chain 1		
149	5745	15.72	15.78	0.5	Pass
157	5785	15.17	15.14	0.5	Pass
165	5825	15.34	15.41	0.5	Pass

802.11n (20MHz)

Channel	Frequency (MHz)	6dB Bandwidth (MHz)		Minimum Limit (MHz)	Pass / Fail
		Chain 0	Chain 1		
149	5745	15.38	16.36	0.5	Pass
157	5785	15.46	16.29	0.5	Pass
165	5825	15.61	16.05	0.5	Pass

802.11n (40MHz)

Channel	Frequency (MHz)	6dB Bandwidth (MHz)		Minimum Limit (MHz)	Pass / Fail
		Chain 0	Chain 1		
151	5755	36.23	36.45	0.5	Pass
159	5795	36.33	36.43	0.5	Pass

Spectrum Plot of Worst Value

802.11a_Chain 1 / CH157

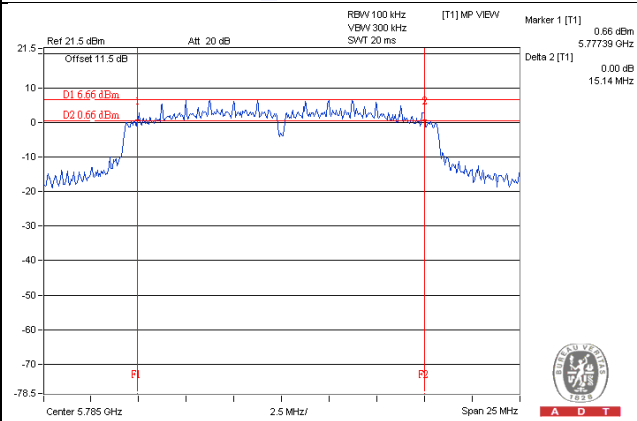

802.11n (20MHz)_Chain 0 / CH149

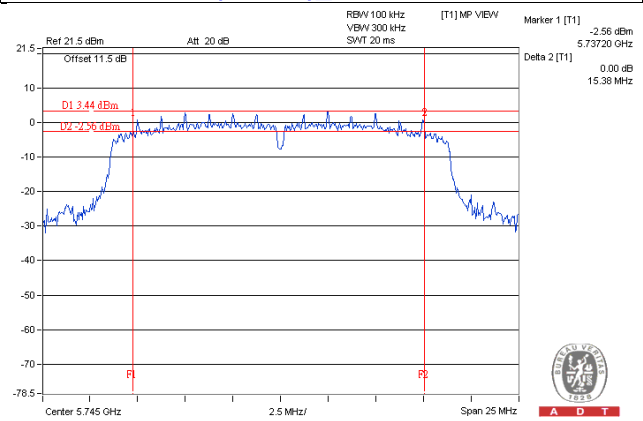

802.11n (40MHz)_Chain 0 / CH151

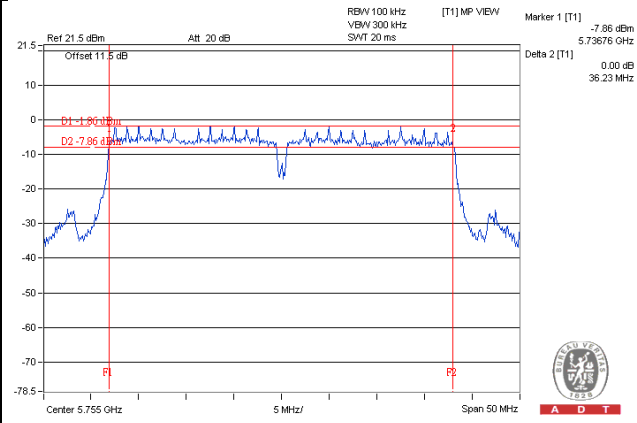

5 Pictures of Test Arrangements

Please refer to the attached file (Test Setup Photo).



A D T

Appendix – Information on the Testing Laboratories

We, Bureau Veritas Consumer Products Services (H.K.) Ltd., Taoyuan Branch, were founded in 1988 to provide our best service in EMC, Radio, Telecom and Safety consultation. Our laboratories are accredited and approved according to ISO/IEC 17025.

If you have any comments, please feel free to contact us at the following:

Linko EMC/RF Lab

Tel: 886-2-26052180

Fax: 886-2-26051924

Hsin Chu EMC/RF/Telecom Lab

Tel: 886-3-6668565

Fax: 886-3-6668323

Hwa Ya EMC/RF/Safety Lab

Tel: 886-3-3183232

Fax: 886-3-3270892

Email: service.adt@tw.bureauveritas.com**Web Site:** www.bureauveritas-adt.com

The address and road map of all our labs can be found in our web site also.

--- END ---