

EMC Test Report

Application for Grant of Equipment Authorization

FCC Part 15 Subpart C

Model: LC61-100

APPLICANT: Technicolor Connected Home USA LLC
101 W. 103rd St
Indianapolis, IN 46290

TEST SITE(S): National Technical Systems - Silicon Valley
41039 Boyce Road.
Fremont, CA. 94538-2435

IC SITE REGISTRATION #: 2845B-5

REPORT DATE: November 13, 2015

REISSUE DATE: February 16, 2016

FINAL TEST DATES: October 29, November 2, 3 and 4, 2015

TOTAL NUMBER OF PAGES: 54

PROGRAM MGR /
TECHNICAL REVIEWER:

QUALITY ASSURANCE DELEGATE /
FINAL REPORT PREPARER:

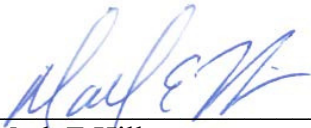

Mark E Hill
Staff Engineer



David Guidotti
Senior Technical Writer



National Technical Systems - Silicon Valley is accredited by the A2LA, certificate number 0214.26, to perform the test(s) listed in this report, except where noted otherwise. This report and the information contained herein represent the results of testing test articles identified and selected by the client performed to specifications and/or procedures selected by the client. National Technical Systems (NTS) makes no representations, expressed or implied, that such testing is adequate (or inadequate) to demonstrate efficiency, performance, reliability, or any other characteristic of the articles being tested, or similar products. This report should not be relied upon as an endorsement or certification by NTS of the equipment tested, nor does it represent any statement whatsoever as to its merchantability or fitness of the test article, or similar products, for a particular purpose. This report shall not be reproduced except in full



REVISION HISTORY

Rev#	Date	Comments	Modified By
-	November 13, 2015	First release	
1.0	February 16, 2016	Clarified modulation used. Updated references to spurious emissions limit. Clarified the spurious emissions below 1GHz	MEH

TABLE OF CONTENTS

REVISION HISTORY	2
TABLE OF CONTENTS	3
SCOPE	4
OBJECTIVE	4
STATEMENT OF COMPLIANCE	5
DEVIATIONS FROM THE STANDARDS	5
TEST RESULTS SUMMARY	6
DIGITAL TRANSMISSION SYSTEMS (2400 – 2483.5MHZ)	6
GENERAL REQUIREMENTS APPLICABLE TO ALL BANDS	6
MEASUREMENT UNCERTAINTIES	7
EQUIPMENT UNDER TEST (EUT) DETAILS	8
GENERAL.....	8
ANTENNA SYSTEM	8
ENCLOSURE.....	8
MODIFICATIONS	8
SUPPORT EQUIPMENT	8
EUT INTERFACE PORTS	9
EUT OPERATION	9
TEST SITE	10
GENERAL INFORMATION	10
CONDUCTED EMISSIONS CONSIDERATIONS	10
RADIATED EMISSIONS CONSIDERATIONS	10
MEASUREMENT INSTRUMENTATION	11
RECEIVER SYSTEM	11
INSTRUMENT CONTROL COMPUTER	11
LINE IMPEDANCE STABILIZATION NETWORK (LISN).....	11
FILTERS/ATTENUATORS	12
ANTENNAS.....	12
ANTENNA MAST AND EQUIPMENT TURNTABLE	12
INSTRUMENT CALIBRATION.....	12
TEST PROCEDURES	13
EUT AND CABLE PLACEMENT	13
CONDUCTED EMISSIONS.....	13
RADIATED EMISSIONS	13
CONDUCTED EMISSIONS FROM ANTENNA PORT	17
BANDWIDTH MEASUREMENTS	17
SPECIFICATION LIMITS AND SAMPLE CALCULATIONS	18
CONDUCTED EMISSIONS SPECIFICATION LIMITS: FCC 15.207; FCC 15.107(A), RSS GEN	18
GENERAL TRANSMITTER RADIATED EMISSIONS SPECIFICATION LIMITS	19
OUTPUT POWER LIMITS – DIGITAL TRANSMISSION SYSTEMS	19
TRANSMIT MODE SPURIOUS RADIATED EMISSIONS LIMITS – FHSS AND DTS SYSTEMS.....	19
SAMPLE CALCULATIONS - CONDUCTED EMISSIONS	19
SAMPLE CALCULATIONS - RADIATED EMISSIONS.....	20
SAMPLE CALCULATIONS - FIELD STRENGTH TO EIRP CONVERSION.....	21
APPENDIX A TEST EQUIPMENT CALIBRATION DATA	22
APPENDIX B TEST DATA	23
END OF REPORT	54

SCOPE

An electromagnetic emissions test has been performed on the Technicolor Connected Home USA LLC model LC61-100, pursuant to the following rules:

FCC Part 15 Subpart C

Conducted and radiated emissions data has been collected, reduced, and analyzed within this report in accordance with measurement guidelines set forth in the following reference standards and as outlined in National Technical Systems - Silicon Valley test procedures:

ANSI C63.10-2013

FCC DTS Measurement Guidance KDB558074

The intentional radiator above has been tested in a simulated typical installation to demonstrate compliance with the relevant Industry Canada performance and procedural standards.

Final system data was gathered in a mode that tended to maximize emissions by varying orientation of EUT, orientation of power and I/O cabling, antenna search height, and antenna polarization.

Every practical effort was made to perform an impartial test using appropriate test equipment of known calibration. All pertinent factors have been applied to reach the determination of compliance.

OBJECTIVE

The primary objective of the manufacturer is compliance with the regulations outlined in the previous section.

Prior to marketing in the USA, all unlicensed transmitters and transceivers require certification. Receive-only devices operating between 30 MHz and 960 MHz are subject to either certification or a manufacturer's declaration of conformity, with all other receive-only devices exempt from the technical requirements.

Certification is a procedure where the manufacturer submits test data and technical information to a certification body and receives a certificate or grant of equipment authorization upon successful completion of the certification body's review of the submitted documents. Once the equipment authorization has been obtained, the label indicating compliance must be attached to all identical units, which are subsequently manufactured.

Maintenance of compliance is the responsibility of the manufacturer. Any modification of the product which may result in increased emissions should be checked to ensure compliance has been maintained (i.e., printed circuit board layout changes, different line filter, different power supply, harnessing or I/O cable changes, etc.).

STATEMENT OF COMPLIANCE

The tested sample of Technicolor Connected Home USA LLC model LC61-100 complied with the requirements of the following regulations:

FCC Part 15 Subpart C

Maintenance of compliance is the responsibility of the manufacturer. Any modifications to the product should be assessed to determine their potential impact on the compliance status of the device with respect to the standards detailed in this test report.

The test results recorded herein are based on a single type test of Technicolor Connected Home USA LLC model LC61-100 and therefore apply only to the tested sample. The sample was selected and prepared by Rodolfo Rascon of Technicolor Connected Home USA LLC.

DEVIATIONS FROM THE STANDARDS

No deviations were made from the published requirements listed in the scope of this report.

TEST RESULTS SUMMARY

DIGITAL TRANSMISSION SYSTEMS (2400 – 2483.5MHz)

FCC Rule Part	RSS Rule Part	Description	Measured Value / Comments	Limit / Requirement	Result
15.247(a)	-	Digital Modulation	Systems uses OQPSK modulation	System must utilize a digital transmission technology	Complies
15.247 (a) (2)	-	6dB Bandwidth	1.6 MHz	>500kHz	Complies
15.247 (b) (3)	-	Output Power (multipoint systems)	4.0 dBm (2.5 mW) EIRP = 5 mW <small>Note 1</small>	1Watt, EIRP limited to 4 Watts.	Complies
15.247(e)	-	Power Spectral Density	-11.3 dBm/3kHz	8dBm/3kHz	Complies
15.247(d) / 15.209	-	Spurious Emissions 30MHz – 25 GHz	46.7 dBμV/m @ 4851.0 MHz (-7.3 dB)	15.209 in restricted bands, all others < -20dBc	Complies
Note 1: EIRP calculated using antenna gain of 3.0 dBi for the highest EIRP system.					

GENERAL REQUIREMENTS APPLICABLE TO ALL BANDS

FCC Rule Part	RSS Rule part	Description	Measured Value / Comments	Limit / Requirement	Result (margin)
15.203	-	RF Connector	Antennas are integral to the internal PCB	Unique or integral antenna required	Complies
15.207	RSS GEN Table 3	AC Conducted Emissions	49.6 dBμV @ 0.151 MHz (-16.3 dB)	Refer to page 18	Complies
15.247 (b) (5) / 15.407 (f)	RSS 102	RF Exposure Requirements	Refer to SAR Exclusion Calculations	Refer to OET 65, FCC Part 1 and RSS 102	Complies

MEASUREMENT UNCERTAINTIES

ISO/IEC 17025 requires that an estimate of the measurement uncertainties associated with the emissions test results be included in the report. The measurement uncertainties given below are based on a 95% confidence level and were calculated in accordance with UKAS document LAB 34.

Measurement Type	Measurement Unit	Frequency Range	Expanded Uncertainty
RF power, conducted (power meter)	dBm	25 to 7000 MHz	± 0.52 dB
RF power, conducted (Spectrum analyzer)	dBm	25 to 7000 MHz	± 0.7 dB
Conducted emission of transmitter	dBm	25 to 26500 MHz	± 0.7 dB
Conducted emission of receiver	dBm	25 to 26500 MHz	± 0.7 dB
Radiated emission (substitution method)	dBm	25 to 26500 MHz	± 2.5 dB
Radiated emission (field strength)	dB μ V/m	25 to 1000 MHz	± 3.6 dB
		1000 to 40000 MHz	± 6.0 dB
Conducted Emissions (AC Power)	dB μ V	0.15 to 30 MHz	± 2.4 dB

EQUIPMENT UNDER TEST (EUT) DETAILS

GENERAL

The Technicolor Connected Home USA LLC model LC61-100 is a high definition set top box, with MoCA 2.0 and RF4CE. Since the EUT would be placed on a tabletop during operation, the EUT was treated as tabletop equipment during testing to simulate the end-user environment. The electrical rating of the EUT is 100-240V, 50/60Hz, 0.5 Amps.

The sample was received on October 29, 2015 and tested on October 29, November 2, 3 and 4, 2015. The EUT consisted of the following component(s):

Company	Model	Description	Serial Number	FCC ID
Technicolor	LC61-100	DIRECTV Home Client	T31XA405T4062 (radio sample)	-
DIRECTV	EPS12W0-16	AC/DC Adapter	14186015G9F35274 (radio sample)	-

ANTENNA SYSTEM

The EUT uses two pcb trace antennas, 3dBi gain, configured for transmit diversity.

ENCLOSURE

The EUT enclosure is primarily constructed of plastic. It measures approximately 15 cm wide by 9.5 cm deep by 3 cm high.

MODIFICATIONS

No modifications were made to the EUT during the time the product was at NTS Silicon Valley.

SUPPORT EQUIPMENT

The following equipment was used as local support equipment for testing:

Company	Model	Description	Serial Number	FCC ID
JVC	EM39FT	TV	TA1SEI042503850	-
ACER	S242ML	Monitor	MMLR9AA00240305 C5C8537	-

The following equipment was used as remote support equipment for testing:

Company	Model	Description	Serial Number	FCC ID
Technicolor	LH44	DVR STB	T30LA5DR110104	-
DIRECTV	EPS44R3-16	AC/DC Adapter	DD44C1506A8021	-
Seagate	SRD00F1	SSD	NA70907P	-

EUT INTERFACE PORTS

The I/O cabling configuration during testing was as follows:

Port		Cable(s)		
From	To	Description	Shielded/Unshielded	Length(m)
Network	DVR STB - SAT IN	COAX	Shielded	20
HDMI	Monitor	Multiconductor	Shielded	2
A/V Out	TV	Multiconductor	Shielded	2
USB	Not Connected*	-	-	-
Digital Audio (optical)	Not Connected	-	-	-
Power In	AC/DC Adapter	Multiconductor (w/molded ferrite at EUT)	Shielded	1.8
AC/DC Adapter	AC Mains	2wire	Unshielded	1.7

* - Manufacturer stated that the USB port is not supported at this time.

EUT OPERATION

During testing, the EUT was configured to transmit a modulated signal on the noted channel at the maximum power setting.

TEST SITE**GENERAL INFORMATION**

Final test measurements were taken at the test sites listed below. Pursuant to section 2.948 of the FCC's Rules and section 3.3 of RSP-100, construction, calibration, and equipment data has been filed with the Commission and with industry Canada.

Site	Designation / Registration Numbers		Location
	FCC	Canada	
Chamber 5	US0027	2845B-5	41039 Boyce Road Fremont, CA 94538-2435

ANSI C63.4 recommends that ambient noise at the test site be at least 6 dB below the allowable limits. Ambient levels are below this requirement. The test site(s) contain separate areas for radiated and conducted emissions testing. Considerable engineering effort has been expended to ensure that the facilities conform to all pertinent requirements of ANSI C63.4.

CONDUCTED EMISSIONS CONSIDERATIONS

Conducted emissions testing is performed in conformance with ANSI C63.10. Measurements are made with the EUT connected to the public power network through a nominal, standardized RF impedance, which is provided by a line impedance stabilization network, known as a LISN. A LISN is inserted in series with each current-carrying conductor in the EUT power cord.

RADIATED EMISSIONS CONSIDERATIONS

The FCC has determined that radiation measurements made in a shielded enclosure are not suitable for determining levels of radiated emissions. Radiated measurements are performed in an open field environment or in a semi-anechoic chamber. The test sites are maintained free of conductive objects within the CISPR defined elliptical area incorporated in ANSI C63.4 guidelines and meet the Normalized Site Attenuation (NSA) requirements of ANSI C63.4.

MEASUREMENT INSTRUMENTATION

RECEIVER SYSTEM

An EMI receiver as specified in CISPR 16-1-1 is used for emissions measurements. The receivers used can measure over the frequency range of 9 kHz up to 2000 MHz. These receivers allow both ease of measurement and high accuracy to be achieved. The receivers have Peak, Average, and CISPR (Quasi-peak) detectors built into their design so no external adapters are necessary. The receiver automatically sets the required bandwidth for the CISPR detector used during measurements. If the repetition frequency of the signal being measured is below 20Hz, peak measurements are made in lieu of Quasi-Peak measurements.

For measurements above the frequency range of the receivers, a spectrum analyzer is utilized because it provides visibility of the entire spectrum along with the precision and versatility required to support engineering analysis. Average measurements above 1000MHz are performed on the spectrum analyzer using the linear-average method with a resolution bandwidth of 1 MHz and a video bandwidth of 10 Hz, unless the signal is pulsed in which case the average (or video) bandwidth of the measuring instrument is reduced to onset of pulse desensitization and then increased.

INSTRUMENT CONTROL COMPUTER

The receivers utilize either a Rohde & Schwarz EZM Spectrum Monitor/Controller or contain an internal Spectrum Monitor/Controller to view and convert the receiver measurements to the field strength at an antenna or voltage developed at the LISN measurement port, which is then compared directly with the appropriate specification limit. This provides faster, more accurate readings by performing the conversions described under Sample Calculations within the Test Procedures section of this report. Results are printed in a graphic and/or tabular format, as appropriate. A personal computer is used to record all measurements made with the receivers. The software used for radiated and conducted emissions measurements is NTS EMI Test Software (rev 2.10)

The Spectrum Monitor provides a visual display of the signal being measured. In addition, the controller or a personal computer run automated data collection programs which control the receivers. This provides added accuracy since all site correction factors, such as cable loss and antenna factors are added automatically.

LINE IMPEDANCE STABILIZATION NETWORK (LISN)

Line conducted measurements utilize a fifty microhenry Line Impedance Stabilization Network as the monitoring point. The LISN used also contains a 250 uH CISPR adapter. This network provides for calibrated radio frequency noise measurements by the design of the internal low pass and high pass filters on the EUT and measurement ports, respectively.

FILTERS/ATTENUATORS

External filters and precision attenuators are often connected between the receiving antenna or LISN and the receiver. This eliminates saturation effects and non-linear operation due to high amplitude transient events.

ANTENNAS

A loop antenna is used below 30 MHz. For the measurement range 30 MHz to 1000 MHz either a combination of a biconical antenna and a log periodic or a bi-log antenna is used. Above 1000 MHz, horn antennas are used. The antenna calibration factors to convert the received voltage to an electric field strength are included with appropriate cable loss and amplifier gain factors to determine an overall site factor, which is then programmed into the test receivers or incorporated into the test software.

ANTENNA MAST AND EQUIPMENT TURNTABLE

The antennas used to measure the radiated electric field strength are mounted on a non-conductive antenna mast equipped with a motor-drive to vary the antenna height. Measurements below 30 MHz are made with the loop antenna at a fixed height of 1m above the ground plane.

ANSI C63.10 specifies that the test height above ground for table mounted devices shall be 80 centimeters for measurements below 1GHz and 1.5m for measurements above 1GHz. Floor mounted equipment shall be placed on the ground plane if the device is normally used on a conductive floor or separated from the ground plane by insulating material from 3 to 12 mm if the device is normally used on a non-conductive floor as specified in ANSI C63.4. During radiated measurements, the EUT is positioned on a motorized turntable in conformance with this requirement.

INSTRUMENT CALIBRATION

All test equipment is regularly checked to ensure that performance is maintained in accordance with the manufacturer's specifications. All antennas are calibrated at regular intervals with respect to tuned half-wave dipoles. An exhibit of this report contains the list of test equipment used and calibration information.

TEST PROCEDURES

EUT AND CABLE PLACEMENT

The regulations require that interconnecting cables be connected to the available ports of the unit and that the placement of the unit and the attached cables simulate the worst case orientation that can be expected from a typical installation, so far as practicable. To this end, the position of the unit and associated cabling is varied within the guidelines of ANSI C63.10, and the worst-case orientation is used for final measurements.

CONDUCTED EMISSIONS

Conducted emissions are measured at the plug end of the power cord supplied with the EUT. Excess power cord length is wrapped in a bundle between 30 and 40 centimeters in length near the center of the cord. Preliminary measurements are made to determine the highest amplitude emission relative to the specification limit for all the modes of operation. Placement of system components and varying of cable positions are performed in each mode. A final peak mode scan is then performed in the position and mode for which the highest emission was noted on all current carrying conductors of the power cord.

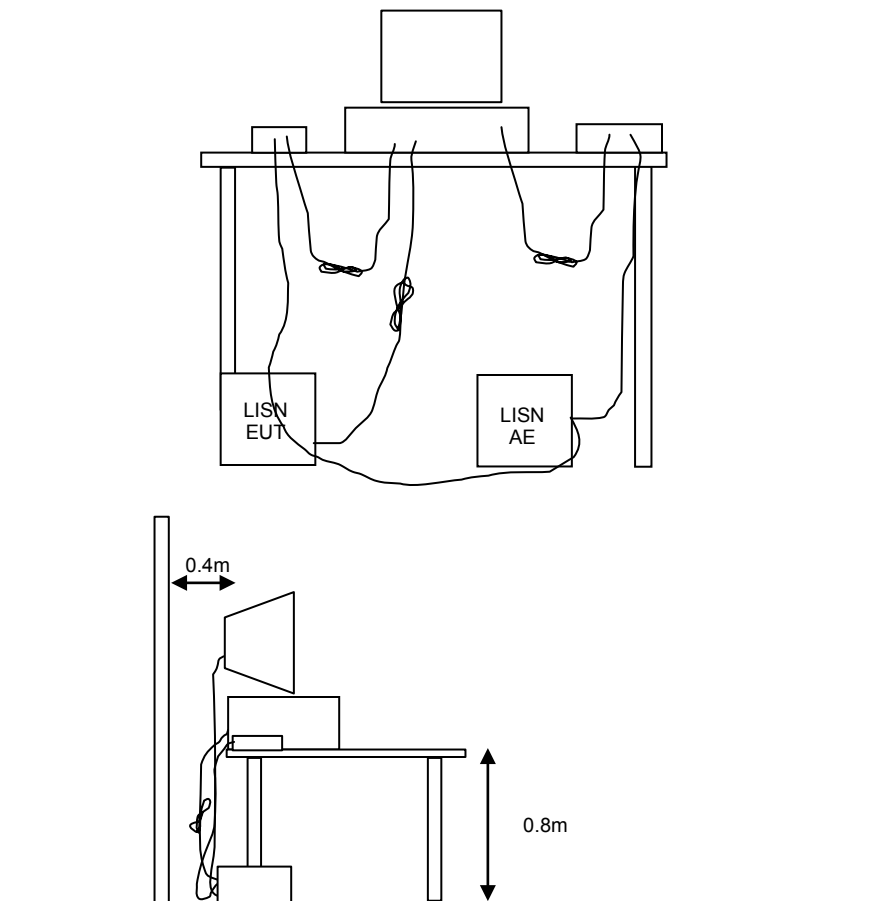

Figure 1 Typical Conducted Emissions Test Configuration

RADIATED EMISSIONS

A preliminary scan of the radiated emissions is performed in which all significant EUT frequencies are identified with the system in a nominal configuration. At least two scans are performed, one scan for each antenna polarization (horizontal and vertical; loop parallel and perpendicular to the EUT). During the preliminary scans, the EUT is rotated through 360°, the antenna height is varied (for measurements above 30 MHz) and cable positions are varied to determine the highest emission relative to the limit. Preliminary scans may be performed in a fully anechoic chamber for the purposes of identifying the frequencies of the highest emissions from the EUT.

A speaker is provided in the receiver to aid in discriminating between EUT and ambient emissions. Other methods used during the preliminary scan for EUT emissions involve scanning with near field magnetic loops, monitoring I/O cables with RF current clamps, and cycling power to the EUT.

Final maximization is a phase in which the highest amplitude emissions identified in the spectral search are viewed while the EUT azimuth angle is varied from 0 to 360 degrees relative to the receiving antenna. The azimuth, which results in the highest emission is then maintained while varying the antenna height from one to four meters (for measurements above 30 MHz, measurements below 30 MHz are made with the loop antenna at a fixed height of 1m). The result is the identification of the highest amplitude for each of the highest peaks. Each recorded level is corrected in the receiver using appropriate factors for cables, connectors, antennas, and preamplifier gain.

When testing above 18 GHz, the receive antenna is located at 1 meter from the EUT and the antenna height is restricted to a maximum of 2.5 meters.

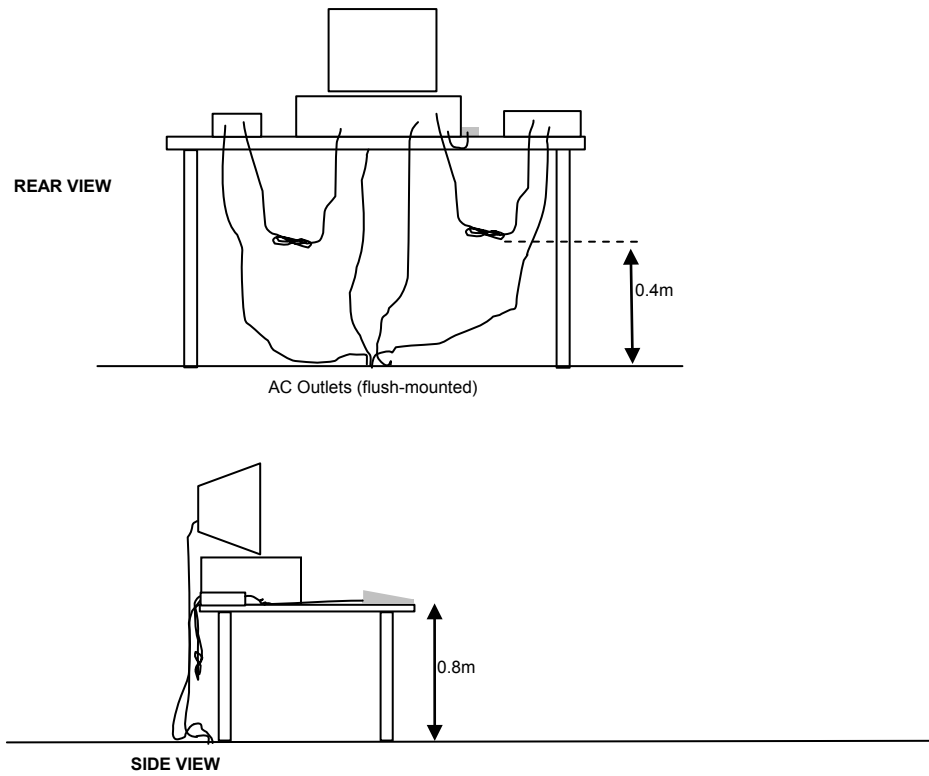

Typical Test Configuration for Radiated Field Strength Measurements

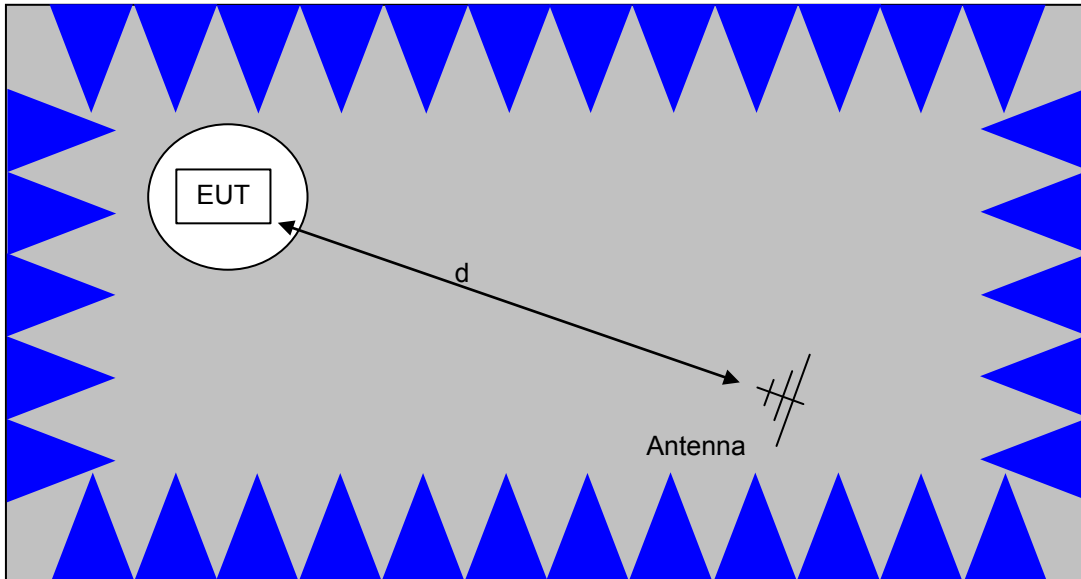

The anechoic materials on the walls and ceiling ensure compliance with the normalized site attenuation requirements of CISPR 16 / CISPR 22 / ANSI C63.4 for an alternate test site at the measurement distances used.

Floor-standing equipment is placed on the floor with insulating supports between the unit and the ground plane.

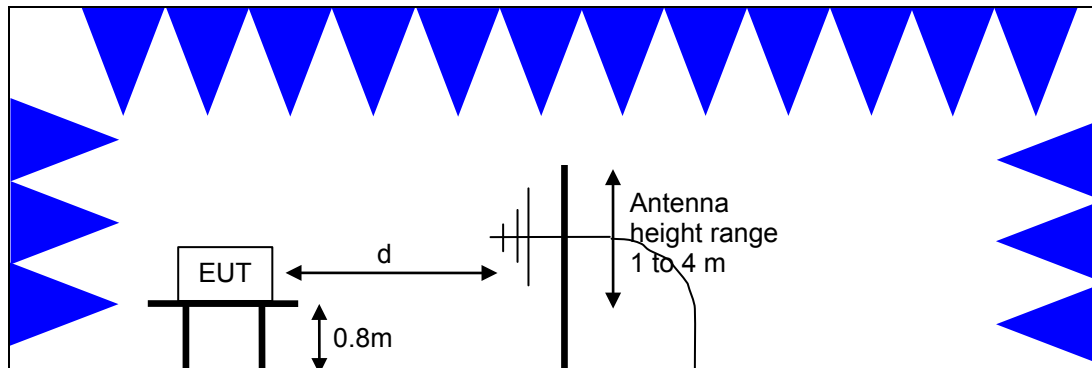

Test Configuration for Radiated Field Strength Measurements
Semi-Anechoic Chamber, Plan and Side Views

CONDUCTED EMISSIONS FROM ANTENNA PORT

Direct measurements of power, bandwidth and power spectral density are performed, where possible, with the antenna port of the EUT connected to either the power meter or spectrum analyzer via a suitable attenuator and/or filter. These are used to ensure that the front end of the measurement instrument is not overloaded by the fundamental transmission.

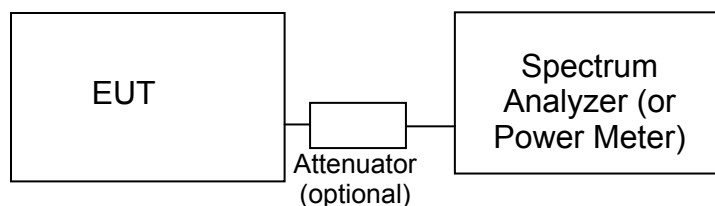
Test Configuration for Antenna Port Measurements

Measurement bandwidths (video and resolution) are set in accordance with the relevant standards and NTS Silicon Valley's test procedures for the type of radio being tested. When power measurements are made using a resolution bandwidth less than the signal bandwidth the power is calculated by summing the power across the signal bandwidth using either the analyzer channel power function or by capturing the trace data and calculating the power using software. In both cases the summed power is corrected to account for the equivalent noise bandwidth (ENBW) of the resolution bandwidth used.

If power averaging is used (typically for certain digital modulation techniques), the EUT is configured to transmit continuously. Power averaging is performed using either the built-in function of the analyzer or, if the analyzer does not feature power averaging, using external software. In both cases the average power is calculated over a number of sweeps (typically 100). When the EUT cannot be configured to continuously transmit then either the analyzer is configured to perform a gated sweep to ensure that the power is averaged over periods that the device is transmitting or power averaging is disabled and a max-hold feature is used.

If a power meter is used to make output power measurements the sensor head type (peak or average) is stated in the test data table.

BANDWIDTH MEASUREMENTS

The 6dB, 20dB, 26dB and/or 99% signal bandwidth are measured using the bandwidths recommended by ANSI C63.10 and RSS GEN.

SPECIFICATION LIMITS AND SAMPLE CALCULATIONS

The limits for conducted emissions are given in units of microvolts, and the limits for radiated emissions are given in units of microvolts per meter at a specified test distance. Data is measured in the logarithmic form of decibels relative to one microvolt, or dB microvolts (dBuV). For radiated emissions, the measured data is converted to the field strength at the antenna in dB microvolts per meter (dBuV/m). The results are then converted to the linear forms of uV and uV/m for comparison to published specifications.

For reference, converting the specification limits from linear to decibel form is accomplished by taking the base ten logarithm, then multiplying by 20. These limits in both linear and logarithmic form are as follows:

CONDUCTED EMISSIONS SPECIFICATION LIMITS: FCC 15.207; FCC 15.107(a), RSS GEN

The table below shows the limits for the emissions on the AC power line from an intentional radiator and a receiver.

Frequency (MHz)	Average Limit (dBuV)	Quasi Peak Limit (dBuV)
0.150 to 0.500	Linear decrease on logarithmic frequency axis between 56.0 and 46.0	Linear decrease on logarithmic frequency axis between 66.0 and 56.0
0.500 to 5.000	46.0	56.0
5.000 to 30.000	50.0	60.0

GENERAL TRANSMITTER RADIATED EMISSIONS SPECIFICATION LIMITS

The table below shows the limits for the spurious emissions from transmitters that fall in restricted bands¹.

Frequency Range (MHz)	Limit (uV/m)	Limit (dBuV/m @ 3m)
0.009-0.490	2400/F _{KHz} @ 300m	67.6-20*log ₁₀ (F _{KHz}) @ 300m
0.490-1.705	24000/F _{KHz} @ 30m	87.6-20*log ₁₀ (F _{KHz}) @ 30m
1.705 to 30	30 @ 30m	29.5 @ 30m
30 to 88	100 @ 3m	40 @ 3m
88 to 216	150 @ 3m	43.5 @ 3m
216 to 960	200 @ 3m	46.0 @ 3m
Above 960	500 @ 3m	54.0 @ 3m

OUTPUT POWER LIMITS – DIGITAL TRANSMISSION SYSTEMS

The table below shows the limits for output power and output power density.

Operating Frequency (MHz)	Output Power	Power Spectral Density
2400 – 2483.5	1 Watt (30 dBm)	8 dBm/3kHz

The maximum permitted output power is reduced by 1dB for every dB the antenna gain exceeds 6dBi. Fixed point-to-point applications using the 5725 – 5850 MHz band are not subject to this restriction.

TRANSMIT MODE SPURIOUS RADIATED EMISSIONS LIMITS – FHSS and DTS SYSTEMS

The limits for unwanted (spurious) emissions from the transmitter falling in the restricted bands are those specified in the general limits sections of FCC Part 15 and RSS GEN. All other unwanted (spurious) emissions shall be at least 20dB below the level of the highest in-band signal level (30dB if the power is measured using the sample detector/power averaging method).

SAMPLE CALCULATIONS - CONDUCTED EMISSIONS

Receiver readings are compared directly to the conducted emissions specification limit (decibel form) as follows:

$$R_r - S = M$$

where:

R_r = Receiver Reading in dBuV

S = Specification Limit in dBuV

M = Margin to Specification in +/- dB

¹ The restricted bands are detailed in FCC 15.205, RSS-GEN Table 3

SAMPLE CALCULATIONS - RADIATED EMISSIONS

Receiver readings are compared directly to the specification limit (decibel form). The receiver internally corrects for cable loss, preamplifier gain, and antenna factor. The calculations are in the reverse direction of the actual signal flow, thus cable loss is added and the amplifier gain is subtracted. The Antenna Factor converts the voltage at the antenna coaxial connector to the field strength at the antenna elements.

A distance factor, when used for electric field measurements above 30MHz, is calculated by using the following formula:

$$F_d = 20 * \text{LOG}_{10} (D_m/D_s)$$

where:

$$F_d = \text{Distance Factor in dB}$$

$$D_m = \text{Measurement Distance in meters}$$

$$D_s = \text{Specification Distance in meters}$$

For electric field measurements below 30MHz the extrapolation factor is either determined by making measurements at multiple distances or a theoretical value is calculated using the formula:

$$F_d = 40 * \text{LOG}_{10} (D_m/D_s)$$

Measurement Distance is the distance at which the measurements were taken and Specification Distance is the distance at which the specification limits are based. The antenna factor converts the voltage at the antenna coaxial connector to the field strength at the antenna elements.

The margin of a given emission peak relative to the limit is calculated as follows:

$$R_c = R_r + F_d$$

and

$$M = R_c - L_s$$

where:

$$R_r = \text{Receiver Reading in dBuV/m}$$

$$F_d = \text{Distance Factor in dB}$$

$$R_c = \text{Corrected Reading in dBuV/m}$$

$$L_s = \text{Specification Limit in dBuV/m}$$

$$M = \text{Margin in dB Relative to Spec}$$

SAMPLE CALCULATIONS - FIELD STRENGTH TO EIRP CONVERSION

Where the radiated electric field strength is expressed in terms of the equivalent isotropic radiated power (eirp), or where a field strength measurement of output power is made in lieu of a direct measurement, the following formula is used to convert between eirp and field strength at a distance of d (meters) from the equipment under test:

$$E = \frac{1000000 \sqrt{30 P}}{d} \quad \text{microvolts per meter}$$

where P is the eirp (Watts)

For a measurement at 3m the conversion from a logarithmic value for field strength (dBuV/m) to an eirp power (dBm) is -95.3dB.

Appendix A Test Equipment Calibration Data

<u>Manufacturer</u>	<u>Description</u>	<u>Model</u>	<u>Asset #</u>	<u>Calibrated</u>	<u>Cal Due</u>
Duty Cycle, 29-Oct-15					
Agilent Technologies	PSA, Spectrum Analyzer, (installed options, 111, 115, 123, 1DS, B7J, HXX,	E4446A	2139	6/22/2015	6/22/2016
Spurious Emission and Fundamental Measurements, 1000 - 12,000 MHz, 02-Nov-15					
EMCO	Antenna, Horn, 1-18 GHz	3115	786	12/20/2013	12/20/2015
Micro-Tronics	Band Reject Filter, 2400-2500 MHz	BRM50702-02	1683	7/13/2015	7/13/2016
Hewlett Packard	Microwave Preamplifier, 1-26.5GHz	8449B	2199	10/9/2015	10/9/2016
Hewlett Packard	SpecAn 9 kHz - 40 GHz, (SA40) Purple	8564E (84125C)	2415	3/7/2015	3/7/2016
Rohde & Schwarz	EMI Test Receiver, 20 Hz-40 GHz	ESIB40 (1088.7490.40)	2493	1/23/2015	1/23/2016
Conducted Emissions - AC Power Ports 15.207, 04-Nov-15					
NTS	NTS EMI Software (rev 2.10)	N/A	0		N/A
EMCO	LISN, 10 kHz-100 MHz	3825/2	1292	7/24/2015	7/24/2016
EMCO	LISN, 10 kHz-100 MHz	3825/2	1293	6/2/2015	6/2/2016
Rohde & Schwarz	Pulse Limiter	ESH3 Z2	1594	5/14/2015	5/14/2016
Rohde & Schwarz	EMI Test Receiver, 20 Hz-40 GHz	ESIB40 (1088.7490.40)	2493	1/23/2015	1/23/2016
Radiated Spurious Emissions, 30 - 1,000 MHz, 04-Nov-15					
Sunol Sciences	Biconilog, 30-3000 MHz	JB3	1548	9/17/2014	9/17/2016
Micro-Tronics	Band Reject Filter, 2400-2500 MHz	BRM50702-02	1683	7/13/2015	7/13/2016
Com-Power	Preamplifier, 30-1000 MHz	PA-103A	2359	12/22/2014	12/22/2015
Rohde & Schwarz	EMI Test Receiver, 20 Hz-40 GHz	ESIB40 (1088.7490.40)	2493	1/23/2015	1/23/2016
Radiated Emissions, 1000 - 12,000 MHz, 04-Nov-15					
EMCO	Antenna, Horn, 1-18 GHz	3115	786	12/20/2013	12/20/2015
Hewlett Packard	Microwave Preamplifier, 1-26.5GHz	8449B	2199	10/9/2015	10/9/2016
Micro-Tronics	Band Reject Filter, 2400-2500 MHz	BRM50702-02	2249	9/16/2015	9/16/2016
Hewlett Packard	SpecAn 9 kHz - 40 GHz, (SA40) Purple	8564E (84125C)	2415	3/7/2015	3/7/2016



Appendix B Test Data

T99784 Pages 24 – 53



EMC Test Data

Client:	Technicolor Connected Home	Job Number:	JD99775
Product	LC61-100	T-Log Number:	T99784
System Configuration:		Project Manager:	Christine Krebill
Contact:	Rodolfo Rascon	Project Coordinator:	
Emissions Standard(s):	FCC 15.B / 15.247	Class:	B
Immunity Standard(s):	-	Environment:	-

EMC Test Data

For The

Technicolor Connected Home

Product

LC61-100

Date of Last Test: 11/2/2015

Client: Technicolor Connected Home	Job Number: JD99775
Model: LC61-100	T-Log Number: T99784
	Project Manager: Christine Krebill
Contact: Rodolfo Rascon	Project Coordinator: -
Standard: FCC 15.B / 15.247	Class: N/A

Duty Cycle

Date of Test: 10/29/2015
 Test Engineer: Mark Hill
 Test Location: FT Lab#4a

Duty cycle measurements performed on the worse case data rate for power.

Notes: Measurements taken with maximum RBW/VBW settings allowed.

Mode	Data Rate	Duty Cycle (x)	Constant DC?	T (ms)	Pwr Cor Factor*	Lin Volt Cor Factor**	Min VBW for FS (Hz)
RF4CE	-	100.00	Yes	N/A	0	0	10

* Correction factor when using RMS/Power averaging - $10 \cdot \log(1/x)$

** Correction factor when using linear voltage average - $20 \cdot \log(1/x)$

T = Minimum transmission duration

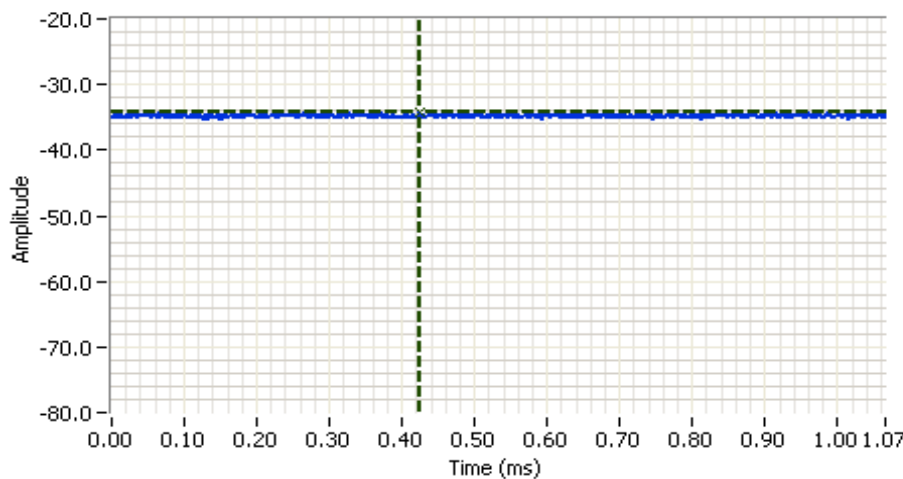

Analyzer Settings
 Agilent Technologies, E4446A
 CF: 2450.000 MHz
 SPAN: 0.000 MHz
 RB: 10.000 MHz
 VB: 50.000 MHz
 Detector: PK (CISPR)
 Attn: 20 DB
 RL Offset: 0.0 DB
 Sweep Time: 1.1ms
 Ref Lvl: 1.0 DBM

Comments
 Technicolor
 LC-61
 Duty Cycle

Cursor 1 0.4245 -34.2

0.0000 0.0



EMC Test Data

Client:	Technicolor Connected Home	Job Number:	JD99775
Model:	LC61-100	T-Log Number:	T99784
Contact:	Rodolfo Rascon	Project Manager:	Christine Krebill
Standard:	FCC 15.B / 15.247	Project Coordinator:	-
		Class:	N/A

RSS-247 and FCC 15.247 (DTS) Radiated Spurious Emissions

Test Specific Details

Objective: The objective of this test session is to perform final qualification testing of the EUT with respect to the specification listed above.

General Test Configuration

The EUT and all local support equipment were located on the turntable for radiated spurious emissions testing. For radiated emissions testing the measurement antenna was located 3 meters from the EUT, unless otherwise noted.

Ambient Conditions:

Temperature: 21.6 °C
Rel. Humidity: 38 %

Summary of Results - Device Operating in the 2400-2483.5 MHz Band

Run #	Mode	Channel	Target Power	Power Setting	Test Performed	Limit	Result / Margin
1	RF4CE	2425MHz	3	3	Restricted Band Edge (2390 MHz)	FCC Part 15.209 / 15.247(c)	35.1 dBµV/m @ 2385.1 MHz (-18.9 dB)
	RF4CE	2475MHz	3	3	Restricted Band Edge (2483.5 MHz)	FCC Part 15.209 / 15.247(c)	42.7 dBµV/m @ 2484.0 MHz (-11.3 dB)

Modifications Made During Testing

No modifications were made to the EUT during testing

Deviations From The Standard

No deviations were made from the requirements of the standard.

Sample Notes

Sample S/N:
Driver:
Antenna: Internal

Client:	Technicolor Connected Home	Job Number:	JD99775
Model:	LC61-100	T-Log Number:	T99784
		Project Manager:	Christine Krebill
Contact:	Rodolfo Rascon	Project Coordinator:	-
Standard:	FCC 15.B / 15.247	Class:	N/A

Procedure Comments:

Measurements performed in accordance with FCC KDB 558074

Peak measurements performed with: RBW=1MHz, VBW=3MHz, peak detector, max hold, auto sweep time

Unless otherwise stated/noted, emission has a duty cycle $\geq 98\%$ and was measured using RBW=1MHz, VBW=10Hz, peak detector, linear average mode, auto sweep time, max hold.

Mode	Data Rate	Duty Cycle (x)	Constant DC?	T (ms)	Pwr Cor Factor*	Lin Volt Cor Factor**	Min VBW for FS (Hz)
RF4CE	-	100.00	Yes	N/A	0	0	10

Measurement Specific Notes:

Note 1:	Emission in non-restricted band, but limit of 15.209 used.
Note 2:	Emission in non-restricted band, the limit was set 30dB below the level of the fundamental and measured in 100kHz.
Note 3:	Emission has a duty cycle $\geq 98\%$, average measurement performed: RBW=1MHz, VBW=3MHz, RMS, Power averaging, auto sweep, trace average 100 traces
Note 4:	Emission has constant duty cycle $< 98\%$, average measurement performed: RBW=1MHz, VBW> $> 1/T$ but not less than 10Hz, peak detector, linear averaging, auto sweep, trace average 100 traces, measurement corrected by Linear voltage correction factor
Note 5:	Emission has constant duty cycle $< 98\%$, average measurement performed: RBW=1MHz, VBW=3MHz, RMS, Power averaging, auto sweep, trace average 100 traces, measurement corrected by Pwr correction factor
Note 6:	Emission has non constant duty cycle $< 98\%$, average measurement performed: RBW=1MHz, VBW> $> 1/T$, peak detector, linear average mode, sweep time auto, max hold. Max hold for $50 \cdot (1/DC)$ traces
Note 7:	Emission has non constant duty cycle $< 98\%$, average measurement performed: RBW=1MHz, VBW> $> 1/T$, RMS detector, sweep time auto, max hold. Max hold for $50 \cdot (1/DC)$ traces
Note 8:	Plots of the average and peak bandedge do not account for any duty cycle correction. Refer to the tabular results for final measurements.



EMC Test Data

Client: Technicolor Connected Home	Job Number: JD99775
Model: LC61-100	T-Log Number: T99784
	Project Manager: Christine Krebill
Contact: Rodolfo Rascon	Project Coordinator: -
Standard: FCC 15.B / 15.247	Class: N/A

Run #1: Radiated Bandedge Measurements

Date of Test: 11/2/2015 0:00 Config. Used: 1
 Test Engineer: Rafael Varelas Config Change: None
 Test Location: FT Chamber #5 EUT Voltage: 120V/60Hz

Channel: 2425MHz Mode: RF4CE
 Tx Chain: Ant 1 Data Rate: -

Band Edge Signal Field Strength - Direct measurement of field strength

Frequency	Level	Pol	15.209 / 15.247		Detector	Azimuth	Height	Comments
MHz	dB μ V/m	v/h	Limit	Margin	Pk/QP/Avg	degrees	meters	
2385.110	35.1	V	54.0	-18.9	AVG	304	1.0	POS; RB 1 MHz; VB: 10 Hz
2351.840	45.4	V	74.0	-28.6	PK	304	1.0	POS; RB 1 MHz; VB: 3 MHz
2351.920	33.9	H	54.0	-20.1	AVG	213	2.2	POS; RB 1 MHz; VB: 10 Hz
2351.200	45.1	H	74.0	-28.9	PK	213	2.2	POS; RB 1 MHz; VB: 3 MHz

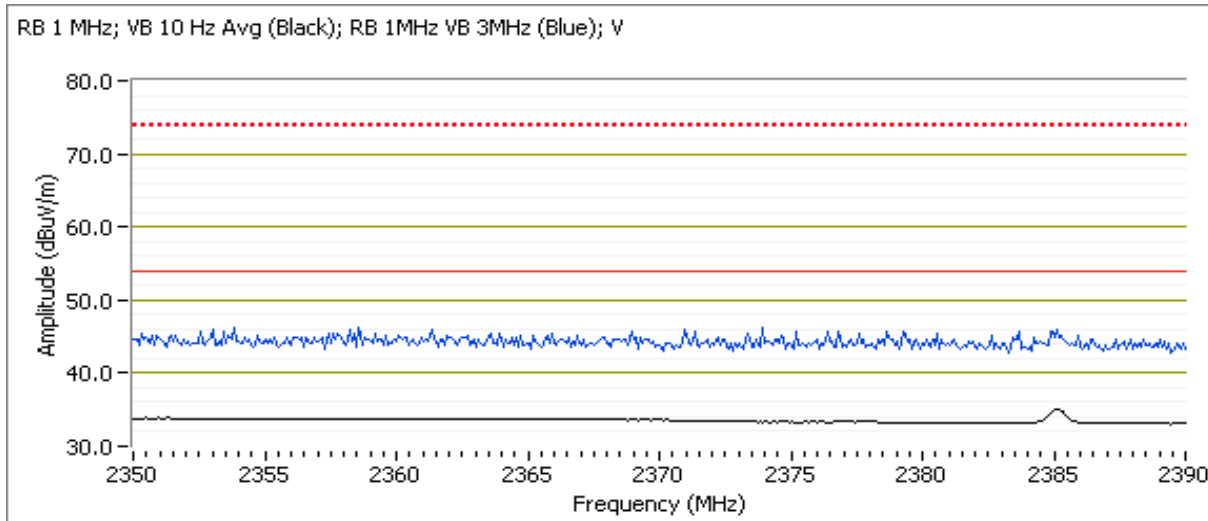



EMC Test Data

Client: Technicolor Connected Home	Job Number: JD99775
Model: LC61-100	T-Log Number: T99784
Contact: Rodolfo Rascon	Project Manager: Christine Krebill
Standard: FCC 15.B / 15.247	Project Coordinator: -
	Class: N/A

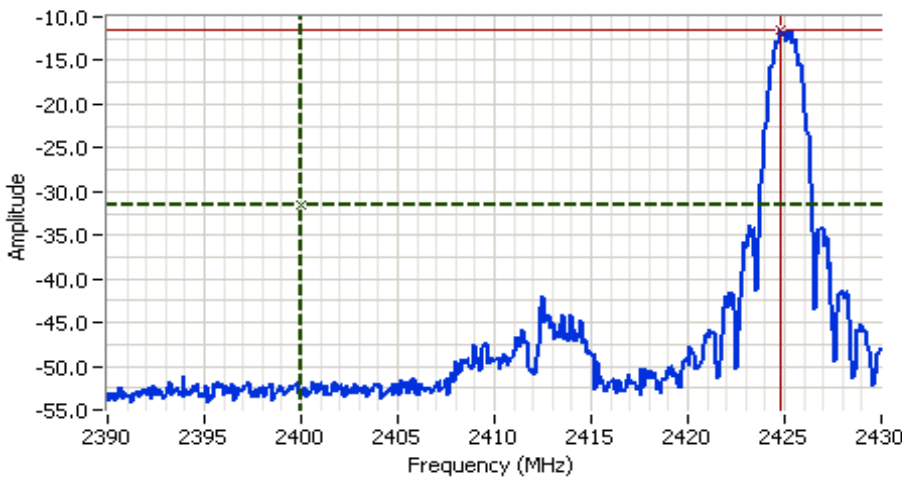

Analyzer Settings
Rohde&Schwarz, ESI
CF: 2410.000 MHz
SPAN: 40.000 MHz
RB: 100 kHz
VB: 300 kHz
Detector: POS
Attn: 0 DB
RL Offset: 32.1 DB
Sweep Time: 10.0ms
Ref Lvl: -0.3 DBM

Comments
-20dBc at 2400 MHz

Cursor 1	2400.0000	-31.5	
Cursor 2	2424.7896	-11.5	

Delta Freq. 24.790
Delta Amplitude 20.0





EMC Test Data

Client: Technicolor Connected Home	Job Number: JD99775
Model: LC61-100	T-Log Number: T99784
Contact: Rodolfo Rascon	Project Manager: Christine Krebill
Standard: FCC 15.B / 15.247	Project Coordinator: -
	Class: N/A

Channel: 2475MHz Mode: RF4CE
 Tx Chain: Ant 1 Data Rate: -

Band Edge Signal Field Strength - Direct measurement of field strength

Frequency MHz	Level dB μ V/m	Pol v/h	15.209 / 15.247		Detector Pk/QP/Avg	Azimuth degrees	Height meters	Comments
			Limit	Margin				
2483.960	42.7	H	54.0	-11.3	AVG	48	1.0	POS; RB 1 MHz; VB: 10 Hz
2483.700	51.9	H	74.0	-22.1	PK	48	1.0	POS; RB 1 MHz; VB: 3 MHz
2484.030	39.2	V	54.0	-14.8	AVG	219	1.0	POS; RB 1 MHz; VB: 10 Hz
2483.800	49.5	V	74.0	-24.5	PK	219	1.0	POS; RB 1 MHz; VB: 3 MHz

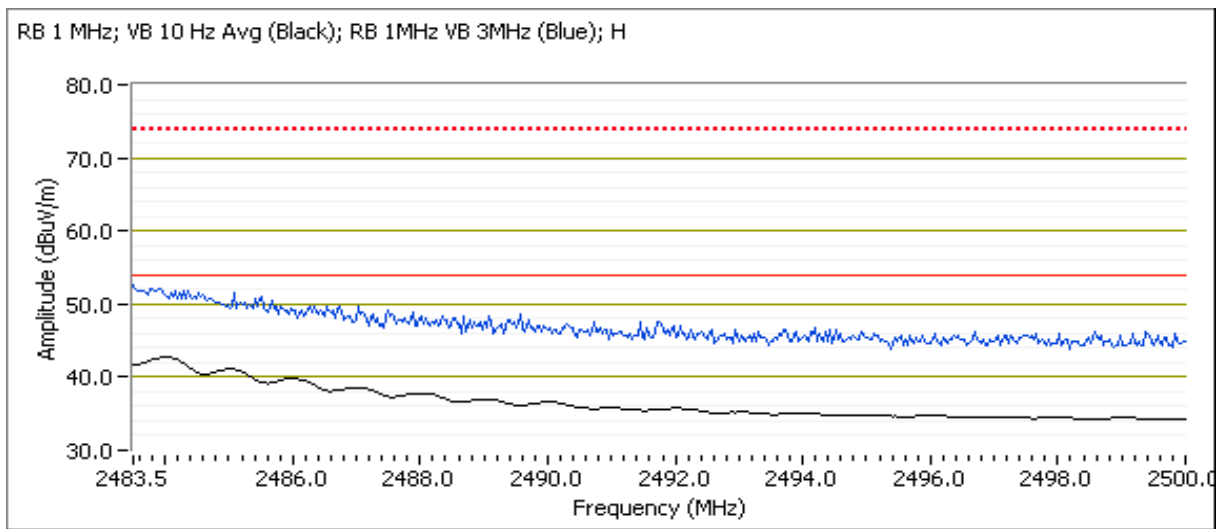



EMC Test Data

Client:	Technicolor Connected Home	Job Number:	JD99775
Model:	LC61-100	T-Log Number:	T99784
Contact:	Rodolfo Rascon	Project Manager:	Christine Krebill
Standard:	FCC 15.B / 15.247	Project Coordinator:	-
		Class:	N/A

RSS-247 and FCC 15.247 (DTS) Radiated Spurious Emissions

Test Specific Details

Objective: The objective of this test session is to perform final qualification testing of the EUT with respect to the specification listed above.

General Test Configuration

The EUT and all local support equipment were located on the turntable for radiated spurious emissions testing.

For radiated emissions testing the measurement antenna was located 3 meters from the EUT, unless otherwise noted.

Ambient Conditions:

Temperature: 21.6 °C
Rel. Humidity: 38 %

Summary of Results - Device Operating in the 2400-2483.5 MHz Band

Run #	Mode	Channel	Target Power	Power Setting	Test Performed	Limit	Result / Margin
1	RF4CE	2425MHz	3	3	Radiated Emissions, 1 - 25 GHz	FCC Part 15.209 / 15.247(c)	46.7 dBµV/m @ 4851.0 MHz (-7.3 dB)
	RF4CE	2450MHz	3	3	Radiated Emissions, 1 - 25 GHz	FCC Part 15.209 / 15.247(c)	43.5 dBµV/m @ 4799.9 MHz (-10.5 dB)
	RF4CE	2475MHz	3	3	Radiated Emissions, 1 - 25 GHz	FCC Part 15.209 / 15.247(c)	44.7 dBµV/m @ 4799.9 MHz (-9.3 dB)

Modifications Made During Testing

No modifications were made to the EUT during testing

Deviations From The Standard

No deviations were made from the requirements of the standard.

Sample Notes

Sample S/N:

Driver:

Antenna: Internal

Client:	Technicolor Connected Home	Job Number:	JD99775
Model:	LC61-100	T-Log Number:	T99784
		Project Manager:	Christine Krebill
Contact:	Rodolfo Rascon	Project Coordinator:	-
Standard:	FCC 15.B / 15.247	Class:	N/A

Procedure Comments:

Measurements performed in accordance with FCC KDB 558074

Peak measurements performed with: RBW=1MHz, VBW=3MHz, peak detector, max hold, auto sweep time

Unless otherwise stated/noted, emission has duty cycle $\geq 98\%$ and was measured using RBW=1MHz, VBW=10Hz, peak detector, linear average mode, auto sweep time, max hold.

2.4GHz band reject filter used

Mode	Data Rate	Duty Cycle (x)	Constant DC?	T (ms)	Pwr Cor Factor*	Lin Volt Cor Factor**	Min VBW for FS (Hz)
RF4CE	-	100.00	Yes	N/A	0	0	10

Measurement Specific Notes:

Note 1:	Emission in non-restricted band, but limit of 15.209 used.
Note 2:	Emission in non-restricted band, the limit was set 30dB below the level of the fundamental and measured in 100kHz.
Note 3:	Emission has a duty cycle $\geq 98\%$, average measurement performed: RBW=1MHz, VBW=3MHz, RMS, Power averaging, auto sweep, trace average 100 traces
Note 4:	Emission has constant duty cycle $< 98\%$, average measurement performed: RBW=1MHz, VBW $> 1/T$ but not less than 10Hz, peak detector, linear averaging, auto sweep, trace average 100 traces, measurement corrected by Linear voltage correction factor
Note 5:	Emission has constant duty cycle $< 98\%$, average measurement performed: RBW=1MHz, VBW=3MHz, RMS, Power averaging, auto sweep, trace average 100 traces, measurement corrected by Pwr correction factor
Note 6:	Emission has non constant duty cycle $< 98\%$, average measurement performed: RBW=1MHz, VBW $> 1/T$, peak detector, linear average mode, sweep time auto, max hold. Max hold for $50 \cdot (1/DC)$ traces
Note 7:	Emission has non constant duty cycle $< 98\%$, average measurement performed: RBW=1MHz, VBW $> 1/T$, RMS detector, sweep time auto, max hold. Max hold for $50 \cdot (1/DC)$ traces



EMC Test Data

Client: Technicolor Connected Home	Job Number: JD99775
Model: LC61-100	T-Log Number: T99784
Contact: Rodolfo Rascon	Project Manager: Christine Krebill
Standard: FCC 15.B / 15.247	Project Coordinator: -
	Class: N/A

Run #1: Radiated Spurious Emissions, 1,000 - 25000 MHz. Operating Mode: RF4CE
 Date of Test: 11/2/2015 0:00 Config. Used: 1
 Test Engineer: Rafael Varelas Config Change: None
 Test Location: FT Chamber #5 EUT Voltage: 120V/60Hz

Run #1a: Low Channel

Channel: 2425MHz Mode: RF4CE
 Tx Chain: Ant 1 Data Rate: -

Fundamental Signal Field Strength: peak value measured in 100kHz

Frequency	Level	Pol	15.209 / 15.247		Detector	Azimuth	Height	Comments
MHz	dB μ V/m	v/h	Limit	Margin	Pk/QP/Avg	degrees	meters	
2425.050	93.4	V	-	-	AVG	208	1.8	POS; RB 1 MHz; VB: 10 Hz
2424.490	97.3	V	-	-	PK	208	1.8	POS; RB 1 MHz; VB: 3 MHz
2425.270	92.7	V	-	-	PK	208	1.8	POS; RB 100 kHz; VB: 300 kHz
2425.060	96.2	H	-	-	AVG	30	1.5	POS; RB 1 MHz; VB: 10 Hz
2425.510	100.0	H	-	-	PK	30	1.5	POS; RB 1 MHz; VB: 3 MHz
2424.910	95.4	H	-	-	PK	30	1.5	POS; RB 100 kHz; VB: 300 kHz

Fundamental emission level @ 3m in 100kHz RBW:	95.4 dB μ V/m	
Limit for emissions outside of restricted bands:	75.4 dB μ V/m	Limit is -20dBc (Peak power measurement)
Limit for emissions outside of restricted bands:	65.4 dB μ V/m	Limit is -30dBc (UNII power measurement)

Spurious Emissions

Frequency	Level	Pol	15.209 / 15.247		Detector	Azimuth	Height	Comments
MHz	dB μ V/m	v/h	Limit	Margin	Pk/QP/Avg	degrees	meters	
4850.980	46.7	V	54.0	-7.3	AVG	29	1.9	RB 1 MHz;VB 10 Hz;Peak
4799.980	44.6	V	54.0	-9.4	AVG	24	1.3	RB 1 MHz;VB 10 Hz;Peak
1017.270	34.8	V	54.0	-19.2	AVG	213	1.0	RB 1 MHz;VB 10 Hz;Peak
4850.970	53.5	V	74.0	-20.5	PK	29	1.9	RB 1 MHz;VB 3 MHz;Peak
4800.050	49.5	V	74.0	-24.5	PK	24	1.3	RB 1 MHz;VB 3 MHz;Peak
1016.890	48.6	V	74.0	-25.4	PK	213	1.0	RB 1 MHz;VB 3 MHz;Peak

Note: Scans made between 12 - 25 GHz with the measurement antenna moved around the card and its antennas 20-50cm from the device indicated there were no significant emissions in this frequency range

Client: Technicolor Connected Home	Job Number: JD99775
Model: LC61-100	T-Log Number: T99784
	Project Manager: Christine Krebill
Contact: Rodolfo Rascon	Project Coordinator: -
Standard: FCC 15.B / 15.247	Class: N/A

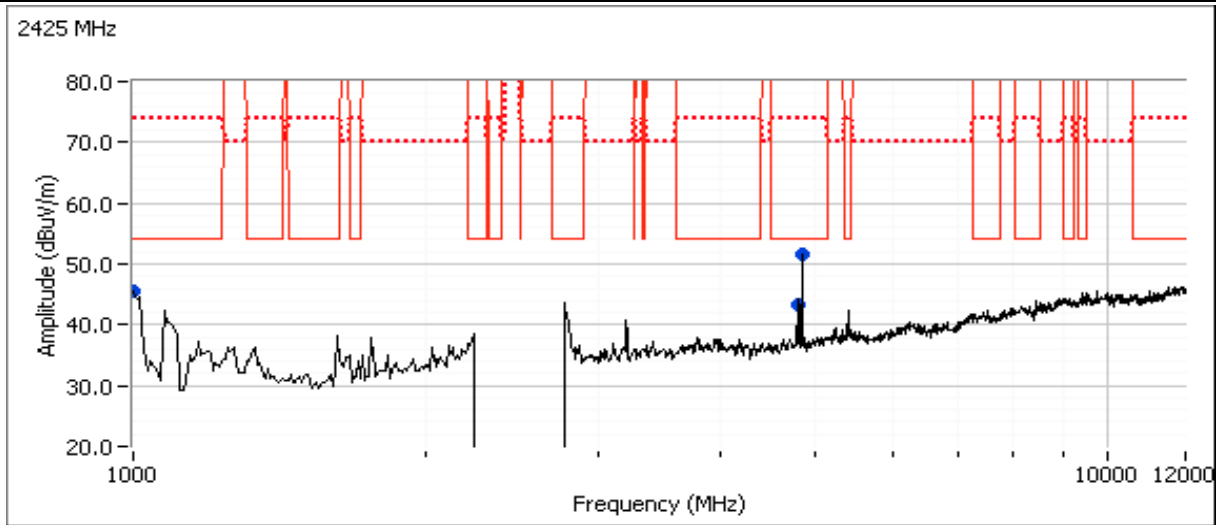



EMC Test Data

Client: Technicolor Connected Home	Job Number: JD99775
Model: LC61-100	T-Log Number: T99784
	Project Manager: Christine Krebill
Contact: Rodolfo Rascon	Project Coordinator: -
Standard: FCC 15.B / 15.247	Class: N/A

Run #1b: Center Channel

Channel: 2450MHz Mode: RF4CE
 Tx Chain: Main Data Rate: -

Fundamental Signal Field Strength: peak value measured in 100kHz

Frequency	Level	Pol	15.209 / 15.247		Detector	Azimuth	Height	Comments
MHz	dB μ V/m	v/h	Limit	Margin	Pk/QP/Avg	degrees	meters	
Ant #1								
2450.060	92.2	V	-	-	AVG	211	1.5	POS; RB 1 MHz; VB: 10 Hz
2449.510	96.1	V	-	-	PK	211	1.5	POS; RB 1 MHz; VB: 3 MHz
2450.120	91.6	V	-	-	PK	211	1.5	POS; RB 100 kHz; VB: 300 kHz
2450.060	96.8	H	-	-	AVG	25	1.4	POS; RB 1 MHz; VB: 10 Hz
2449.480	100.7	H	-	-	PK	25	1.4	POS; RB 1 MHz; VB: 3 MHz
2450.090	95.1	H	-	-	PK	25	1.4	POS; RB 100 kHz; VB: 300 kHz
Ant #2								
2450.050	92.4	V	-	-	AVG	216	1.2	POS; RB 1 MHz; VB: 10 Hz
2449.480	96.2	V	-	-	PK	216	1.2	POS; RB 1 MHz; VB: 3 MHz
2449.730	91.6	V	-	-	PK	216	1.2	POS; RB 100 kHz; VB: 300 kHz
2450.040	92.0	H	-	-	AVG	278	1.2	POS; RB 1 MHz; VB: 10 Hz
2449.470	95.8	H	-	-	PK	278	1.2	POS; RB 1 MHz; VB: 3 MHz
2449.740	91.4	H	-	-	PK	278	1.2	POS; RB 100 kHz; VB: 300 kHz

Fundamental emission level @ 3m in 100kHz RBW:	95.1 dB μ V/m	
Limit for emissions outside of restricted bands:	75.1 dB μ V/m	Limit is -20dBc (Peak power measurement)
Limit for emissions outside of restricted bands:	65.1 dB μ V/m	Limit is -30dBc (UNII power measurement)

Spurious Emissions

Frequency	Level	Pol	15.209 / 15.247		Detector	Azimuth	Height	Comments
MHz	dB μ V/m	v/h	Limit	Margin	Pk/QP/Avg	degrees	meters	
4799.920	43.5	V	54.0	-10.5	AVG	46	1.0	RB 1 MHz;VB 10 Hz;Peak
4900.980	39.8	V	54.0	-14.2	AVG	296	2.0	RB 1 MHz;VB 10 Hz;Peak
1003.300	33.3	H	54.0	-20.7	AVG	90	1.4	RB 1 MHz;VB 10 Hz;Peak
4901.190	48.3	V	74.0	-25.7	PK	296	2.0	RB 1 MHz;VB 3 MHz;Peak
4799.890	48.1	V	74.0	-25.9	PK	46	1.0	RB 1 MHz;VB 3 MHz;Peak
1002.780	47.5	H	74.0	-26.5	PK	90	1.4	RB 1 MHz;VB 3 MHz;Peak

Note: Scans made between 12 - 25 GHz with the measurement antenna moved around the card and its antennas 20-50cm from the device indicated there were no significant emissions in this frequency range

Client: Technicolor Connected Home	Job Number: JD99775
Model: LC61-100	T-Log Number: T99784
	Project Manager: Christine Krebill
Contact: Rodolfo Rascon	Project Coordinator: -
Standard: FCC 15.B / 15.247	Class: N/A

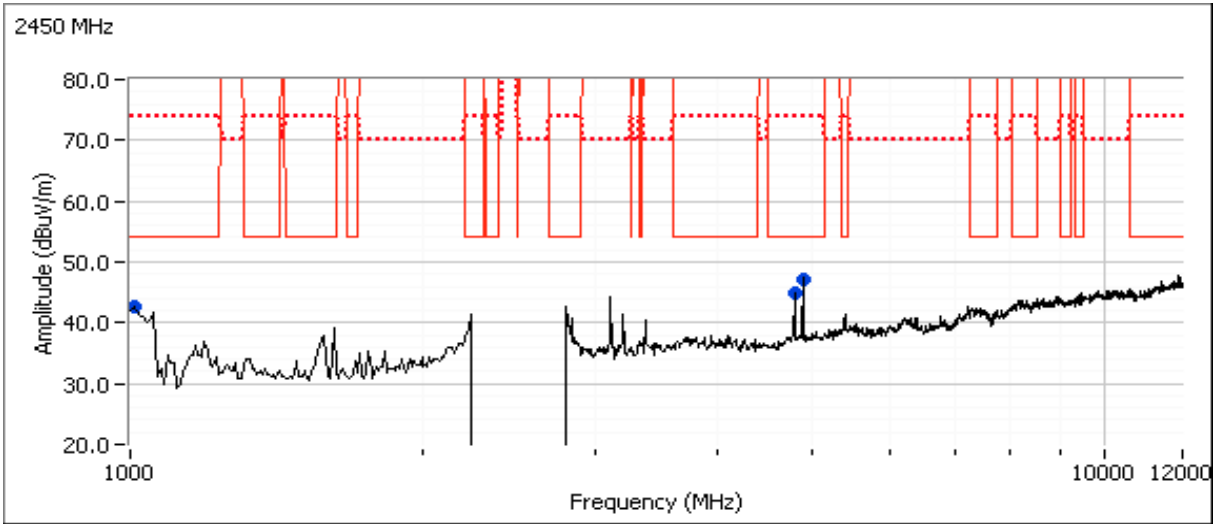



EMC Test Data

Client:	Technicolor Connected Home	Job Number:	JD99775
Model:	LC61-100	T-Log Number:	T99784
Contact:	Rodolfo Rascon	Project Manager:	Christine Krebill
Standard:	FCC 15.B / 15.247	Project Coordinator:	-
		Class:	N/A

Run #1c: High Channel

Channel: 2475MHz Mode: RF4CE
 Tx Chain: Ant 1 Data Rate: -

Fundamental Signal Field Strength: peak value measured in 100kHz

Frequency	Level	Pol	15.209 / 15.247		Detector	Azimuth	Height	Comments
MHz	dB μ V/m	v/h	Limit	Margin	Pk/QP/Avg	degrees	meters	
2475.050	91.4	V	-	-	AVG	209	2.2	POS; RB 1 MHz; VB: 10 Hz
2474.470	95.2	V	-	-	PK	209	2.2	POS; RB 1 MHz; VB: 3 MHz
2475.100	89.7	V	-	-	PK	209	2.2	POS; RB 100 kHz; VB: 300 kHz
2475.050	96.7	H	-	-	AVG	40	1.4	POS; RB 1 MHz; VB: 10 Hz
2474.500	100.3	H	-	-	PK	40	1.4	POS; RB 1 MHz; VB: 3 MHz
2475.270	96.0	H	-	-	PK	40	1.4	POS; RB 100 kHz; VB: 300 kHz

Fundamental emission level @ 3m in 100kHz RBW :	96.0 dB μ V/m	
Limit for emissions outside of restricted bands:	76.0 dB μ V/m	Limit is -20dBc (Peak power measurement)
Limit for emissions outside of restricted bands:	66.0 dB μ V/m	Limit is -30dBc (UNII power measurement)

Spurious Emissions

Frequency	Level	Pol	15.209 / 15.247		Detector	Azimuth	Height	Comments
MHz	dB μ V/m	v/h	Limit	Margin	Pk/QP/Avg	degrees	meters	
4799.940	44.7	V	54.0	-9.3	AVG	35	1.1	RB 1 MHz;VB 10 Hz;Peak
4950.990	42.0	H	54.0	-12.0	AVG	274	2.3	RB 1 MHz;VB 10 Hz;Peak
1052.020	50.3	H	74.0	-23.7	PK	193	2.3	RB 1 MHz;VB 3 MHz;Peak
4800.000	49.9	V	74.0	-24.1	PK	35	1.1	RB 1 MHz;VB 3 MHz;Peak
4948.990	49.9	H	74.0	-24.1	PK	274	2.3	RB 1 MHz;VB 3 MHz;Peak
1053.020	29.3	H	54.0	-24.7	AVG	193	2.3	RB 1 MHz;VB 10 Hz;Peak

Note: Scans made between 12 - 25 GHz with the measurement antenna moved around the card and its antennas 20-50cm from the device indicated there were no significant emissions in this frequency range

Client: Technicolor Connected Home	Job Number: JD99775
Model: LC61-100	T-Log Number: T99784
	Project Manager: Christine Krebill
Contact: Rodolfo Rascon	Project Coordinator: -
Standard: FCC 15.B / 15.247	Class: N/A

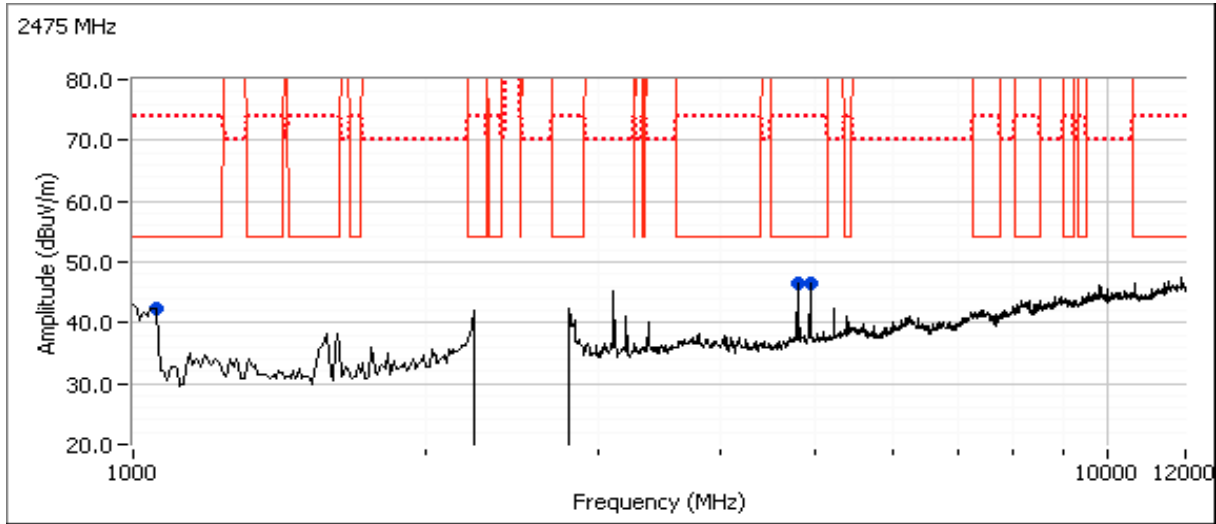



EMC Test Data

Client:	Technicolor Connected Home	Job Number:	JD99775
Model:	LC61-100	T-Log Number:	T99784
Contact:	Rodolfo Rascon	Project Manager:	Christine Krebill
Standard:	FCC 15.B / 15.247	Project Coordinator:	-
		Class:	N/A

RSS-247 and FCC 15.247 (DTS) Radiated Spurious Emissions

Test Specific Details

Objective: The objective of this test session is to perform final qualification testing of the EUT with respect to the specification listed above.

General Test Configuration

The EUT and all local support equipment were located on the turntable for radiated spurious emissions testing.

For radiated emissions testing the measurement antenna was located 3 meters from the EUT, unless otherwise noted.

Ambient Conditions:

Temperature: 22 °C
Rel. Humidity: 33 %

Summary of Results - Device Operating in the 2400-2483.5 MHz Band

Run #	Mode	Channel	Target Power	Power Setting	Test Performed	Limit	Result / Margin
1	RF4CE	2450MHz	3	3	Radiated Emissions, 30 -1000 MHz	FCC Part 15.209 / 15.247(c)	35.2 dBµV/m @ 135.01 MHz (-8.3 dB)

Note - As no emissions observed below 1GHz were from the radio operation, no further testing was performed.

Modifications Made During Testing

No modifications were made to the EUT during testing

Deviations From The Standard

No deviations were made from the requirements of the standard.

Sample Notes

Sample S/N:

Driver:

Antenna: internal

Procedure Comments:

Measurements performed in accordance with FCC KDB 558074

2.4GHz band reject filter used



EMC Test Data

Client: Technicolor Connected Home	Job Number: JD99775
Model: LC61-100	T-Log Number: T99784
	Project Manager: Christine Krebill
Contact: Rodolfo Rascon	Project Coordinator: -
Standard: FCC 15.B / 15.247	Class: N/A

Mode	Data Rate	Duty Cycle (x)	Constant DC?	T (ms)	Pwr Cor Factor*	Lin Volt Cor Factor**	Min VBW for FS (Hz)
RF4CE	-	100.00	Yes	N/A	0	0	10

Measurement Specific Notes:

Note 1:	Emission in non-restricted band, but limit of 15.209 used.
Note 2:	Emission in non-restricted band, the limit was set 30dB below the level of the fundamental and measured in 100kHz.



EMC Test Data

Client: Technicolor Connected Home	Job Number: JD99775
Model: LC61-100	T-Log Number: T99784
	Project Manager: Christine Krebill
Contact: Rodolfo Rascon	Project Coordinator: -
Standard: FCC 15.B / 15.247	Class: N/A

Run #1: Radiated Spurious Emissions, 30 - 1000 MHz. Operating Mode: RF4CE

Date of Test: 11/4/2015 0:00
 Test Engineer: John Caizzi
 Test Location: Chamber 5

Config. Used: 1
 Config Change: none
 EUT Voltage: 120V / 60Hz

Channel: 2450MHz Mode: RF4CE
 Tx Chain: 1 Data Rate: -

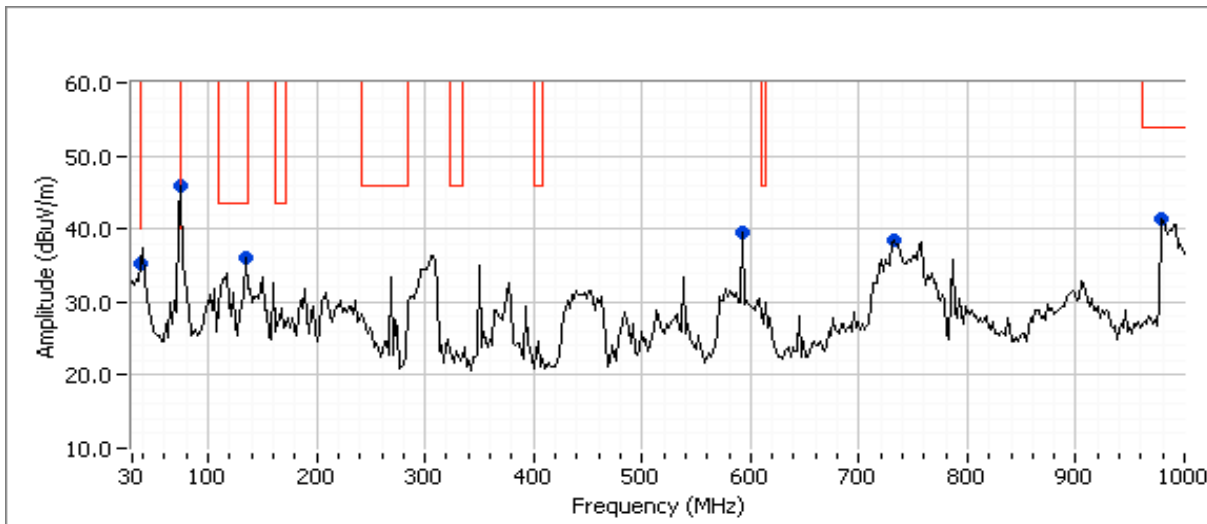

Preliminary peak readings captured during pre-scan

Frequency MHz	Level dB μ V/m	Pol v/h	15.209 / 15.247		Detector Pk/QP/Avg	Azimuth degrees	Height meters	Comments
			Limit	Margin				
73.349	45.8	V	40.0	5.8	Peak	189	1.0	
38.045	35.3	V	40.0	-4.7	Peak	157	1.0	
135.006	36.0	V	43.5	-7.5	Peak	262	1.0	
979.511	41.4	H	54.0	-12.6	Peak	78	1.5	
590.629	39.5	H	100.0	-60.5	Peak	281	1.5	
733.570	38.5	H	100.0	-61.5	Peak	173	1.0	



EMC Test Data

Client:	Technicolor Connected Home	Job Number:	JD99775
Model:	LC61-100	T-Log Number:	T99784
		Project Manager:	Christine Krebill
Contact:	Rodolfo Rascon	Project Coordinator:	-
Standard:	FCC 15.B / 15.247	Class:	N/A

Final quasi-peak readings

Frequency MHz	Level dB μ V/m	Pol v/h	15.209 / 15.247		Detector Pk/QP/Avg	Azimuth degrees	Height meters	Comments
			Limit	Margin				
590.629	39.1	H	75.1	-36.0	QP	285	1.41	Note 1
135.006	35.2	V	43.5	-8.3	QP	283	1.00	
73.349	43.0	V	-	-	QP	174	1.00	Note 1
733.570	35.2	H	75.1	-39.9	QP	169	1.00	Note 1
38.045	26.3	V	40.0	-13.7	QP	160	1.00	
979.511	38.0	H	54.0	-16.0	QP	109	1.51	

Note 1: Video signal from support TV, not from radio.



EMC Test Data

Client:	Technicolor Connected Home	Job Number:	JD99775
Model:	LC61-100	T-Log Number:	T99784
		Project Manager:	Christine Krebill
Contact:	Rodolfo Rascon	Project Coordinator:	-
Standard:	FCC 15.B / 15.247	Class:	N/A

RSS-247 and FCC 15.247 (DTS) Antenna Port Measurements Power, PSD, Bandwidth and Spurious Emissions

Test Specific Details

Objective: The objective of this test session is to perform final qualification testing of the EUT with respect to the specification listed above.

Date of Test: 11/2/2015
 Test Engineer: Rafael Varelas
 Test Location: FT Chamber #5

Config. Used: 1
 Config Change: None
 EUT Voltage: 120V/60Hz

General Test Configuration

The EUT does not provide an RF connector. All measurements performed radiated. For power and PSD measurements, the field strength was maximized at a distance of 3m.

All measurements have been corrected to allow for the external attenuators used.

Ambient Conditions:

Temperature: 21.6 °C
 Rel. Humidity: 38 %

Summary of Results

Run #	Pwr setting	Avg Pwr	Test Performed	Limit	Pass / Fail	Result / Margin
1	-	-	Output Power	15.247(b)	Pass	4.0 dBm (2.5mW)
2	-	-	Power spectral Density (PSD)	15.247(d)	Pass	-14.3 dBm/3kHz
3	-	-	Minimum 6dB Bandwidth	15.247(a)	Pass	1.6 MHz
3	-	-	99% Bandwidth	RSS GEN	-	2.4 MHz

Modifications Made During Testing

No modifications were made to the EUT during testing

Deviations From The Standard

No deviations were made from the requirements of the standard.



EMC Test Data

Client:	Technicolor Connected Home	Job Number:	JD99775
Model:	LC61-100	T-Log Number:	T99784
		Project Manager:	Christine Krebill
Contact:	Rodolfo Rascon	Project Coordinator:	-
Standard:	FCC 15.B / 15.247	Class:	N/A

Procedure Comments:

Measurements performed in accordance with FCC KDB 558074

Mode	Data Rate	Duty Cycle (x)	Constant DC?	T (ms)	Pwr Cor Factor*	Lin Volt Cor Factor**	Min VBW for FS (Hz)
RF4CE	-	100.00	Yes	N/A	0	0	10

Sample Notes

Sample S/N:

Driver:

Notes

The EUT has a fixed antenna, without provisions for a connector for test purposes. All measurements performed radiated

Client: Technicolor Connected Home	Job Number: JD99775
Model: LC61-100	T-Log Number: T99784
	Project Manager: Christine Krebill
Contact: Rodolfo Rascon	Project Coordinator: -
Standard: FCC 15.B / 15.247	Class: N/A

Run #1: Output Power

Power Setting ²	Frequency (MHz)	EIRP ¹		Antenna Gain (dBi)	Output Power		Result	
		dBm	W		(dBm) ¹	mW		
3	2425	6.8	0.005	3.0	3.8	2.4	Pass	Ant 1
3	2450	6.7	0.005	3.0	3.7	2.3	Pass	Ant 1
3	2450	2.9	0.002	3.0	-0.1	1.0	Pass	Ant 2
3	2475	7.0	0.005	3.0	4.0	2.5	Pass	Ant 1

- Note 1: Output power measured using a peak power meter, spurious limit is **-20dBc**.
- Note 2: Power setting - the software power setting used during testing, included for reference only.

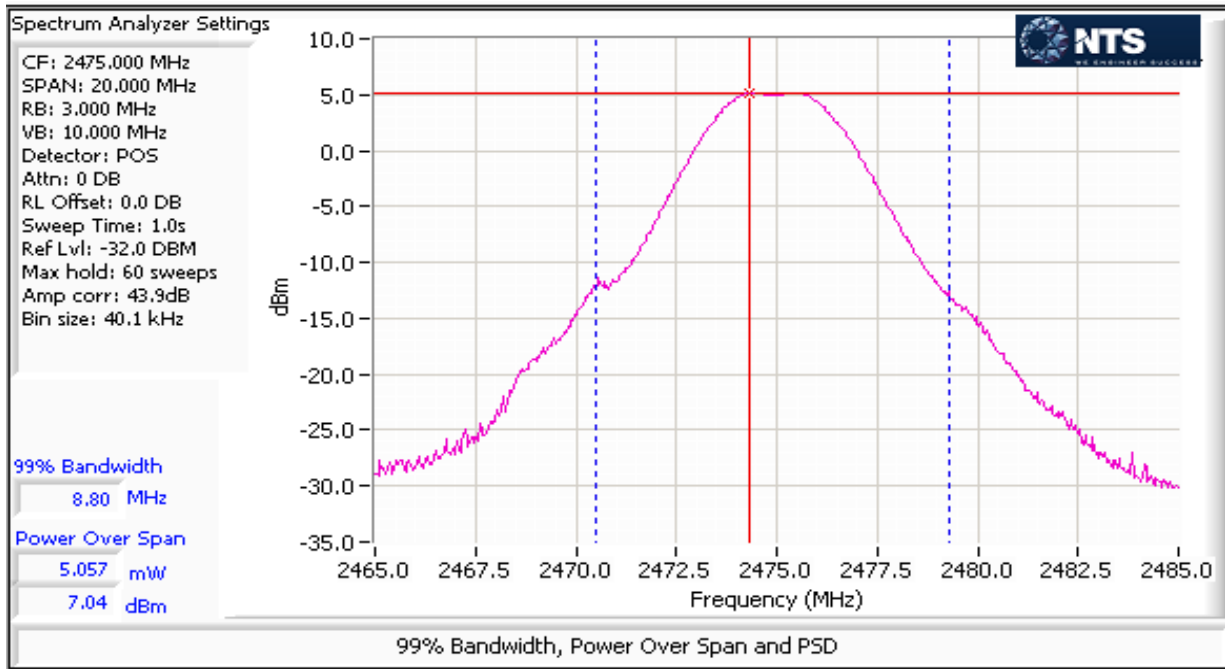

Client: Technicolor Connected Home	Job Number: JD99775
Model: LC61-100	T-Log Number: T99784
	Project Manager: Christine Krebill
Contact: Rodolfo Rascon	Project Coordinator: -
Standard: FCC 15.B / 15.247	Class: N/A

Run #2: Power spectral Density

Power Setting	Frequency (MHz)	PSD (eirp)	Antenna Gain (dBi)	PSD	Limit dBm/3kHz	Result
		(dBm/3kHz) ^{Note 1}		(dBm/3kHz) ^{Note 1}		
3	2425	-13.0	3.0	-16.0	8.0	Pass
3	2450	-11.5	3.0	-14.5	8.0	Pass
3	2475	-11.3	3.0	-14.3	8.0	Pass

Note 1: Power spectral density measured radiated using RB=3 kHz, VB=10kHz, analyzer with peak detector and with a sweep time set to ensure a dwell time of at least 1 second per 3kHz. The measurement is made at the frequency of PPSD determined from preliminary scans using RB=3kHz using multiple sweeps at a faster rate over the 6dB bandwidth of the signal. Final PSD calculated from the measured eirp value.

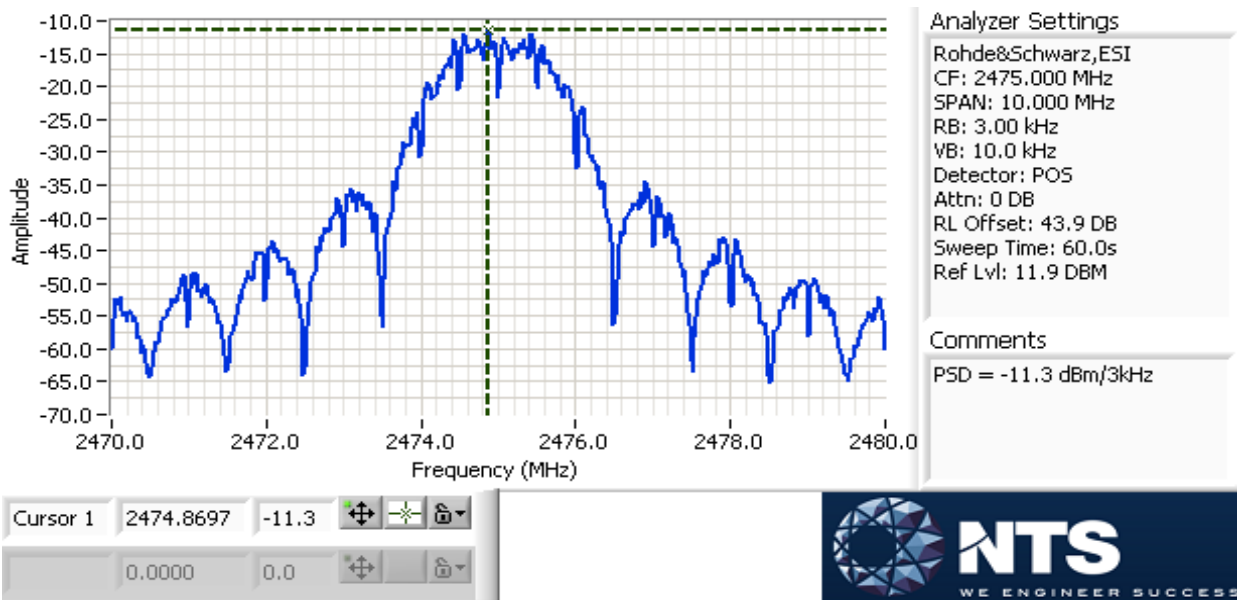



EMC Test Data

Client: Technicolor Connected Home	Job Number: JD99775
Model: LC61-100	T-Log Number: T99784
Contact: Rodolfo Rascon	Project Manager: Christine Krebill
Standard: FCC 15.B / 15.247	Project Coordinator: -
	Class: N/A

Run #3: Signal Bandwidth

Mode: **RF4CE**

Power Setting	Frequency (MHz)	Bandwidth (MHz)		RBW Setting (kHz)	
		6dB	99%	6dB	99%
3	2425	1.6	2.4	100	30
3	2450	1.6	2.4	100	30
3	2475	1.6	2.4	100	30

Note 1: DTS BW: RBW=100kHz, VBW ≥ 3*RBW, peak detector, max hold, auto sweep time, Span 2-5 times measured BW.
 99% BW: RBW=1-5% of 99%BW, VBW ≥ 3*RBW, peak detector, max hold, auto sweep time. Span 1.5-5 times OBW.

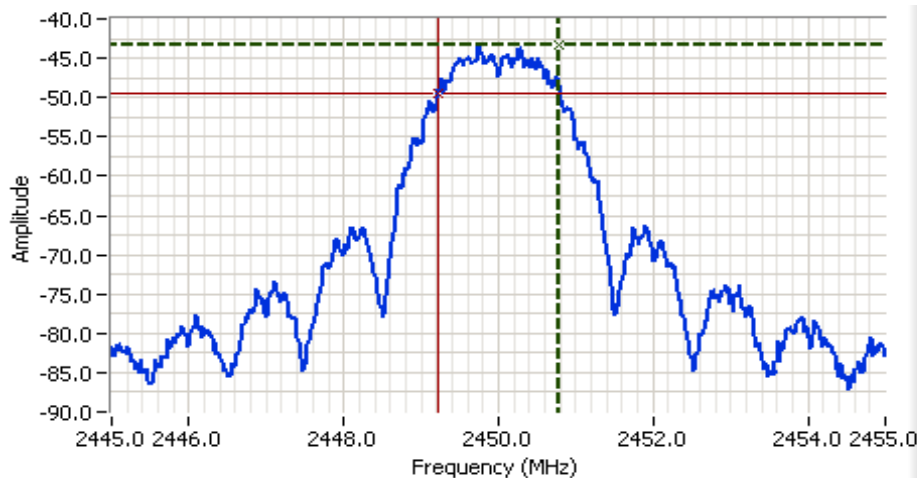

Analyzer Settings

Rohde&Schwarz, ESI
 CF: 2450.000 MHz
 SPAN: 10.000 MHz
 RB: 100 kHz
 VB: 300 kHz
 Detector: POS
 Attn: 0 DB
 RL Offset: 0.0 DB
 Sweep Time: 5.0ms
 Ref Lvl: -35.0 DBM

Comments

6dB BW: 1.563 MHz

Cursor 1	2450.7916	-43.4	Delta Freq.	1.563
Cursor 2	2449.2285	-49.4	Delta Amplitude	6.0





EMC Test Data

Client: Technicolor Connected Home	Job Number: JD99775
Model: LC61-100	T-Log Number: T99784
Contact: Rodolfo Rascon	Project Manager: Christine Krebill
Standard: FCC 15.B / 15.247	Project Coordinator: -
	Class: N/A

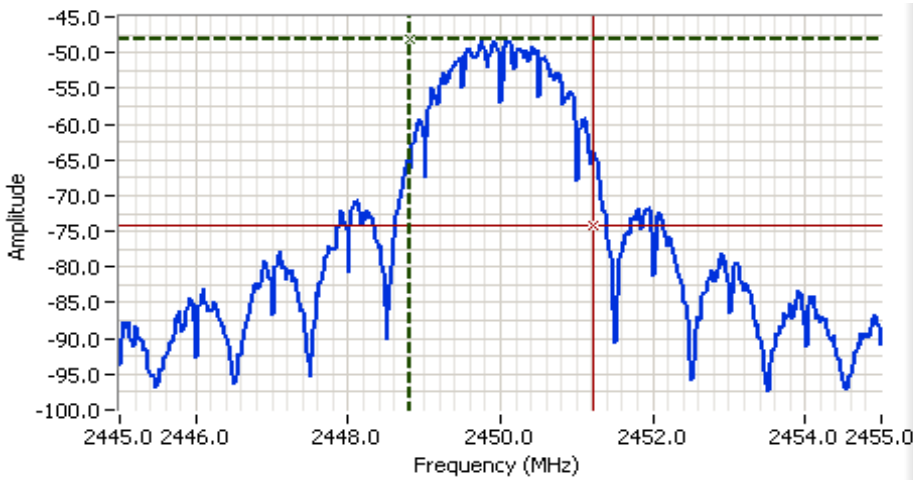

Analyzer Settings
Rohde&Schwarz, ESI
CF: 2450.000 MHz
SPAN: 10.000 MHz
RB: 30.0 kHz
VB: 100 kHz
Detector: POS
Attn: 0 DB
RL Offset: 0.0 DB
Sweep Time: 28.0ms
Ref Lvl: -35.0 DBM

Comments
99% BW: 2.400 MHz

Cursor 1	2448.8200	-48.1	
Cursor 2	2451.2200	-74.1	

Delta Freq.	2.400
Delta Amplitude	26.0





EMC Test Data

Client:	Technicolor Connected Home	Job Number:	JD99775
Model:	LC61-100	T-Log Number:	T99784
		Project Manager:	Christine Krebill
Contact:	Rodolfo Rascon	Project Coordinator:	-
Standard:	FCC 15.B / 15.247	Class:	B

Conducted Emissions

(NTS Silicon Valley, Fremont Facility, Semi-Anechoic Chamber)

Test Specific Details

Objective: The objective of this test session is to perform final qualification testing of the EUT with respect to the specification listed above.

Date of Test: 10/4/2015	Config. Used: 1
Test Engineer: John Caizzi	Config Change: none
Test Location: Chamber 5	EUT Voltage: 120V / 60Hz

General Test Configuration

For tabletop equipment, the EUT was located on a wooden table inside the semi-anechoic chamber, 40 cm from a vertical coupling plane and 80cm from the LISN. A second LISN was used for all local support equipment. Remote support equipment was located outside of the semi-anechoic chamber. Any cables running to remote support equipment were routed through metal conduit and passed through a ferrite clamp upon exiting the chamber.

Ambient Conditions:

Temperature:	22 °C
Rel. Humidity:	33 %

Summary of Results

Run #	Test Performed	Limit	Result	Margin
2	CE, AC Power, 120V/60Hz	FCC 15.207	Pass	49.6 dBµV @ 0.151 MHz (-16.3 dB)

Modifications Made During Testing

No modifications were made to the EUT during testing

Deviations From The Standard

No deviations were made from the requirements of the standard.

Note

Radio configured for continuous transmit on center channel (2450MHz) at maximum power

Client: Technicolor Connected Home	Job Number: JD99775
Model: LC61-100	T-Log Number: T99784
	Project Manager: Christine Krebill
Contact: Rodolfo Rascon	Project Coordinator: -
Standard: FCC 15.B / 15.247	Class: B

Run #2: AC Power Port Conducted Emissions, 0.15 - 30MHz, 120V/60Hz

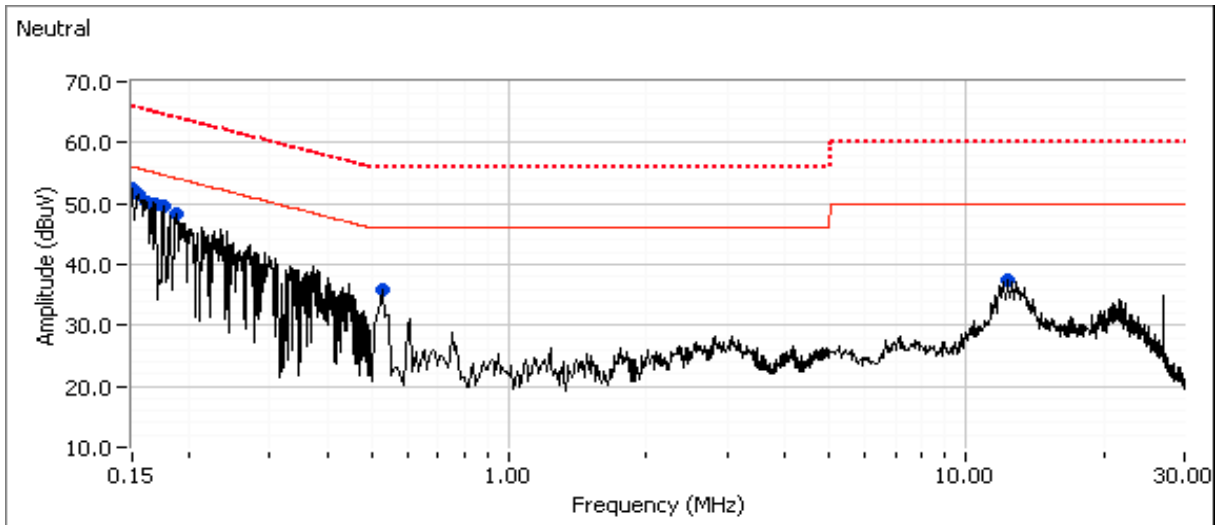
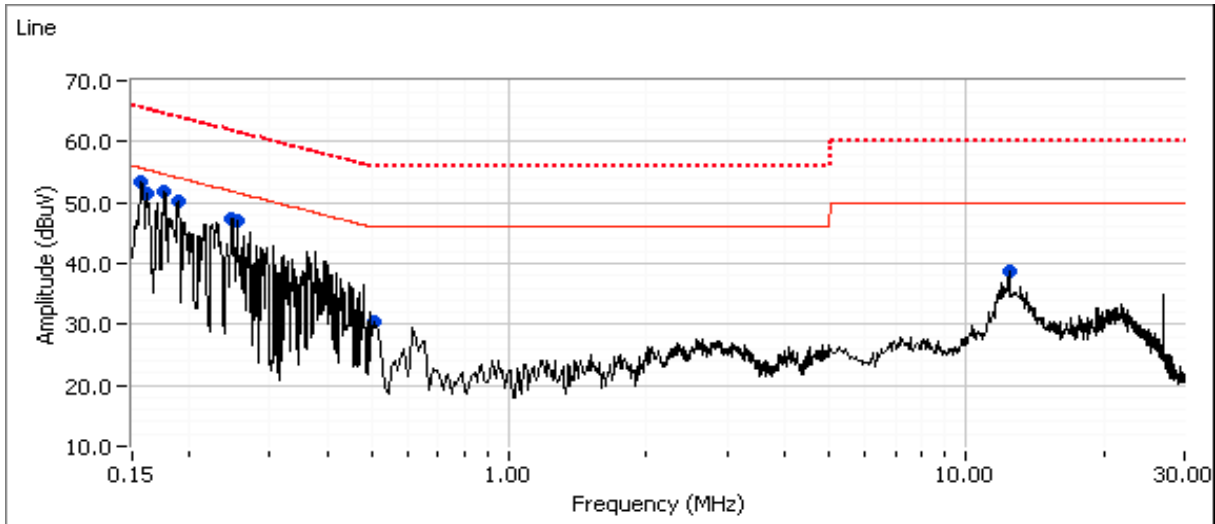



EMC Test Data

Client: Technicolor Connected Home	Job Number: JD99775
Model: LC61-100	T-Log Number: T99784
	Project Manager: Christine Krebill
Contact: Rodolfo Rascon	Project Coordinator: -
Standard: FCC 15.B / 15.247	Class: B

Preliminary peak readings captured during pre-scan (peak readings vs. average limit)

Frequency MHz	Level dB μ V	AC Line	15.207		Detector QP/Ave	Comments
			Limit	Margin		
0.153	53.4	Line	55.6	-2.2	Peak	
0.177	51.9	Line	54.6	-2.7	Peak	
0.162	51.6	Line	55.4	-3.8	Peak	
0.189	50.2	Line	54.1	-3.9	Peak	
0.242	47.5	Line	51.8	-4.3	Peak	
0.254	47.0	Line	51.6	-4.6	Peak	
12.415	38.6	Line	50.0	-11.4	Peak	
0.509	30.3	Line	46.0	-15.7	Peak	
0.151	52.5	Neutral	56.0	-3.5	Peak	
0.156	51.5	Neutral	55.7	-4.2	Peak	
0.160	50.3	Neutral	55.4	-5.1	Peak	
0.168	49.9	Neutral	55.0	-5.1	Peak	
0.175	49.7	Neutral	54.7	-5.0	Peak	
0.187	48.2	Neutral	54.2	-6.0	Peak	
0.527	36.0	Neutral	46.0	-10.0	Peak	
12.315	37.6	Neutral	50.0	-12.4	Peak	



EMC Test Data

Client: Technicolor Connected Home	Job Number: JD99775
Model: LC61-100	T-Log Number: T99784
	Project Manager: Christine Krebill
Contact: Rodolfo Rascon	Project Coordinator: -
Standard: FCC 15.B / 15.247	Class: B

Final quasi-peak and average readings

Frequency MHz	Level dB μ V	AC Line	15.207		Detector QP/Ave	Comments
			Limit	Margin		
0.153	24.5	Line	55.8	-31.3	AVG	
0.153	49.2	Line	65.8	-16.6	QP	
0.162	21.6	Line	55.4	-33.8	AVG	
0.162	47.8	Line	65.4	-17.6	QP	
0.176	24.0	Line	54.7	-30.7	AVG	
0.176	47.2	Line	64.7	-17.5	QP	
0.189	19.5	Line	54.1	-34.6	AVG	
0.189	45.0	Line	64.1	-19.1	QP	
0.242	36.9	Line	62.0	-25.1	QP	
0.242	14.9	Line	52.0	-37.1	AVG	
0.254	41.2	Line	61.6	-20.4	QP	
0.254	14.5	Line	51.6	-37.1	AVG	
0.151	49.6	Neutral	65.9	-16.3	QP	
0.151	24.0	Neutral	55.9	-31.9	AVG	
0.156	49.2	Neutral	65.7	-16.5	QP	
0.156	23.1	Neutral	55.7	-32.6	AVG	
0.160	48.6	Neutral	65.5	-16.9	QP	
0.160	23.2	Neutral	55.5	-32.3	AVG	
0.168	48.2	Neutral	65.1	-16.9	QP	
0.168	20.1	Neutral	55.1	-35.0	AVG	
0.175	47.5	Neutral	64.7	-17.2	QP	
0.175	22.7	Neutral	54.7	-32.0	AVG	
0.187	46.3	Neutral	64.2	-17.9	QP	
0.187	18.4	Neutral	54.2	-35.8	AVG	



EMC Test Data

Client: Technicolor Connected Home	Job Number: JD99775
Model: LC61-100	T-Log Number: T99784
	Project Manager: Christine Krebill
Contact: Rodolfo Rascon	Project Coordinator: -
Standard: FCC 15.B / 15.247	Class: N/A

SAR Exclusion

Test Specific Details

Objective: The objective of this test session is to perform final qualification testing of the EUT with respect to the specification listed above.

Date of Test: 11/11/2015
 Test Engineer: Mark Hill

General Test Configuration

For the FCC SAR Exclusion:

$$[(\text{max. power of channel, including tune-up tolerance, mW}) / (\text{min. test separation distance, mm})] * [\sqrt{F(\text{GHz})}]$$

For IC SAR Exclusion:

Refer to RSS 102, Issue 5, Section 2.51, Table 1

Summary of Results

Device complies with FCC SAR Exclusion requirements at 5cm separation:	Yes
--	-----

FCC SAR Exclusion Calculation

Freq. MHz	EUT Power		Cable Loss Loss dB	Ant Gain dBi	Power at Ant dBm	EIRP mW	Separation Distance (mm)	SAR Exclusion Calc.	SAR Exclusion Limit
	dBm	mW*							
2450	4.0	2.5	0	3	4.0	5.01	5.0	0.79	3.0

Note - output power represents the worse case including production tolerances

End of Report

This page is intentionally blank and marks the last page of this test report.