

TEST REPORT

CERTIFICATE OF CONFORMITY

Standard: 47 CFR FCC Part 15, Subpart E (Section 15.407)
Report No.: RFCGJR-WTW-P23010147A
FCC ID: G95EWM322T
Product: Wireless Access Point
Brand: technicolor
Test Model: EWM322TTCH2
Variant Model: EGM322TTCH2, EWM322Tabcn, EGM322Tabcn (refer to item 3.1 for more details)
Received Date: 2023/2/13
Test Date: 2023/2/15 ~ 2023/3/16
Issued Date: 2023/7/25

Applicant: Vantiva USA LLC
Address: 4855 Peachtree Industrial Blvd. Suite 200 Norcross, Georgia 30092.
Issued By: Bureau Veritas Consumer Products Services (H.K.) Ltd., Taoyuan Branch
Lin Kou Laboratories
Lab Address: No. 47-2, 14th Ling, Chia Pau Vil., Lin Kou Dist., New Taipei City, Taiwan
Test Location: No. 19, Hwa Ya 2nd Rd., Wen Hwa Vil., Kewi Shan Dist., Taoyuan City 33383, Taiwan

FCC Registration / 788550 / TW0003
Designation Number:

Approved by: Jeremy Lin, **Date:** 2023/7/25
Jeremy Lin / Project Engineer

This test report consists of 106 pages in total. It may be duplicated completely for legal use with the approval of the applicant. It should not be reproduced except in full, without the written approval of our laboratory. The test results in the report only apply to the tested sample. The test results in this report are traceable to the national or international standards.

Prepared by : Vera Huang / Specialist



This report is governed by, and incorporates by reference, the Conditions of Testing as posted at the date of issuance of this report at <http://www.bureauveritas.com/home/about-us/our-business/cps/about-us/terms-conditions/> and is intended for your exclusive use. Any copying or replication of this report to or for any other person or entity, or use of our name or trademark, is permitted only with our prior written permission. This report sets forth our findings solely with respect to the test samples identified herein. The results set forth in this report are not indicative or representative of the quality or characteristics of the lot from which a test sample was taken or any similar or identical product unless specifically and expressly noted. Our report includes all of the tests requested by you and the results thereof based upon the information that you provided to us. Measurement uncertainty is only provided upon request for accredited tests. Statements of conformity are based on simple acceptance criteria without taking measurement uncertainty into account, unless otherwise requested in writing. You have 60 days from date of issuance of this report to notify us of any material error or omission caused by our negligence or if you require measurement uncertainty; provided, however, that such notice shall be in writing and shall specifically address the issue you wish to raise. A failure to raise such issue within the prescribed time shall constitute your unqualified acceptance of the completeness of this report, the tests conducted and the correctness of the report contents.

Table of Contents

Release Control Record	4
1 Certificate	5
2 Summary of Test Results	6
2.1 Measurement Uncertainty	6
2.2 Supplementary Information	6
3 General Information	7
3.1 General Description of EUT	7
3.2 Antenna Description of EUT	9
3.3 Channel List	10
3.4 Power Setting	11
3.5 Test Mode Applicability and Tested Channel Detail	12
3.6 Duty Cycle of Test Signal	13
3.7 Test Program Used and Operation Descriptions	15
3.8 Connection Diagram of EUT and Peripheral Devices	15
3.9 Configuration of Peripheral Devices and Cable Connections	15
4 Test Instruments	16
4.1 26 dB Bandwidth	16
4.2 RF Output Power	16
4.3 Power Spectral Density	16
4.4 6 dB Bandwidth	16
4.5 Occupied Bandwidth	16
4.6 Frequency Stability	17
4.7 AC Power Conducted Emissions	17
4.8 Unwanted Emissions below 1 GHz	18
4.9 Unwanted Emissions above 1 GHz	19
5 Limits of Test Items	20
5.1 26 dB Bandwidth	20
5.2 RF Output Power	20
5.3 Power Spectral Density	20
5.4 6 dB Bandwidth	20
5.5 Occupied Bandwidth	20
5.6 Frequency Stability	21
5.7 AC Power Conducted Emissions	21
5.8 Unwanted Emissions below 1 GHz	21
5.9 Unwanted Emissions above 1 GHz	22
6 Test Arrangements	23
6.1 26 dB Bandwidth	23
6.1.1 Test Setup	23
6.1.2 Test Procedure	23
6.2 RF Output Power	24
6.2.1 Test Setup	24
6.2.2 Test Procedure	24
6.3 Power Spectral Density	25
6.3.1 Test Setup	25
6.3.2 Test Procedure	25
6.4 6 dB Bandwidth	25
6.4.1 Test Setup	25
6.4.2 Test Procedure	25
6.5 Occupied Bandwidth	26
6.5.1 Test Setup	26
6.5.2 Test Procedure	26
6.6 Frequency Stability	26
6.6.1 Test Setup	26
6.6.2 Test Procedure	26



6.7	AC Power Conducted Emissions	27
6.7.1	Test Setup	27
6.7.2	Test Procedure	27
6.8	Unwanted Emissions below 1 GHz	28
6.8.1	Test Setup	28
6.8.2	Test Procedure	29
6.9	Unwanted Emissions above 1 GHz	30
6.9.1	Test Setup	30
6.9.2	Test Procedure	30
7	Test Results of Test Item	31
7.1	26 dB Bandwidth	31
7.2	RF Output Power	36
7.3	Power Spectral Density	54
7.4	6 dB Bandwidth	60
7.5	Occupied Bandwidth	62
7.6	Frequency Stability	65
7.7	AC Power Conducted Emissions	66
7.8	Unwanted Emissions below 1 GHz	68
7.9	Unwanted Emissions above 1 GHz	70
8	Pictures of Test Arrangements	105
9	Information of the Testing Laboratories	106



Release Control Record

Issue No.	Description	Date Issued
RFCGJR-WTW-P23010147A	Original Release	2023/7/25

1 Certificate

Product: Wireless Access Point

Brand: technicolor

Test Model: EWM322TTCH2

Variant Model: EGM322TTCH2, EWM322Tabcn, EGM322Tabcn (refer to item 3.1 for more details)

Sample Status: Engineering sample

Applicant: Vantiva USA LLC

Test Date: 2023/2/15 ~ 2023/3/16

Standard: 47 CFR FCC Part 15, Subpart E (Section 15.407)

Measurement ANSI C63.10-2013

procedure: KDB 789033 D02 General UNII Test Procedure New Rules v02r01

KDB 662911 D01 Multiple Transmitter Output v02r01

The above equipment has been tested by **Bureau Veritas Consumer Products Services (H.K.) Ltd., Taoyuan Branch**, and found compliance with the requirement of the above standards. The test record, data evaluation & Equipment Under Test (EUT) configurations represented herein are true and accurate accounts of the measurements of the sample's RF characteristics under the conditions specified in this report.

2 Summary of Test Results

47 CFR FCC Part 15, Subpart E (Section 15.407)			
Clause	Test Item	Result	Remark
15.407(a)(2)	26 dB Bandwidth	Pass	For U-NII-2A U-NII-2C Band output power limitation is determined based on 26dBc bandwidth.
15.407(a)(1) 15.407(a)(2) 15.407(a)(3)	RF Output Power	Pass	Meet the requirement of limit.
15.407(a)(1) 15.407(a)(2) 15.407(a)(3)	Power Spectral Density	Pass	Meet the requirement of limit.
15.407(e)	6 dB Bandwidth	Pass	Meet the requirement of limit. (U-NII-3 Band only)
---	Occupied Bandwidth	-	Reference only.
15.407(g)	Frequency Stability	Pass	Meet the requirement of limit.
15.407(b)(9)	AC Power Conducted Emissions	Pass	Minimum passing margin is -17.62 dB at 24.57800 MHz
15.407(b)(9)	Unwanted Emissions below 1 GHz	Pass	Minimum passing margin is -1.6 dB at 40.67 MHz
15.407(b) (1/10) 15.407(b) (2/10) 15.407(b) (3/10) 15.407(b) (4(i)/10)	Unwanted Emissions above 1 GHz	Pass	Minimum passing margin is -0.5 dB at 5350.00, 5352.00 MHz
15.203	Antenna Requirement	Pass	Antenna connector is ipex(MHF) not a standard connector.

Note: Determining compliance based on the results of the compliance measurement, not taking into account measurement instrumentation uncertainty.

2.1 Measurement Uncertainty

Where relevant, the following measurement uncertainty levels have been estimated for tests performed on the EUT as specified in CISPR 16-4-2:

Measurement	Specification	Expanded Uncertainty (k=2) (±)
Occupied Bandwidth	-	491.896 Hz
AC Power Conducted Emissions	9 kHz ~ 30 MHz	2.99 dB
Unwanted Emissions below 1 GHz	9 kHz ~ 30 MHz	3.59 dB
	30 MHz ~ 1 GHz	3.6 dB
Unwanted Emissions above 1 GHz	1 GHz ~ 18 GHz	2.29 dB
	18 GHz ~ 40 GHz	2.29 dB

The other instruments specified are routine verified to remain within the calibrated levels, no measurement uncertainty is required to be calculated.

2.2 Supplementary Information

There is not any deviation from the test standards for the test method, and no modifications required for compliance.

3 General Information

3.1 General Description of EUT

Product	Wireless Access Point
Brand	technicolor
Test Model	EWM322TTCH2
Variant Model	EGM322TTCH2, EWM322Tabcn, EGM322Tabcn
Model Difference	Refer to note
Status of EUT	Engineering sample
Power Supply Rating	Refer to Note
Modulation Type	64QAM, 16QAM, QPSK, BPSK for OFDM 256QAM for OFDM in 11ac mode 1024QAM for OFDMA in 11ax HE mode
Modulation Technology	OFDM, OFDMA
Transfer Rate	802.11a: 54/48/36/24/18/12/9/6Mbps 802.11n: up to 600Mbps 802.11ac: up to 3466.7Mbps 802.11ax: up to 4803.9Mbps
Operating Frequency	5250 ~ 5320 MHz, 5500 ~ 5720 MHz
Number of Channel	5250 ~ 5320 MHz: 802.11a, 802.11n (HT20), 802.11ac (VHT20), 802.11ax (HE20): 4 802.11n (HT40), 802.11ac (VHT40), 802.11ax (HE40): 2 802.11ac (VHT80), 802.11ax (HE80): 1 802.11ac (VHT160), 802.11ax (HE160): 1 5500 ~ 5720 MHz: 802.11a, 802.11n (HT20), 802.11ac (VHT20), 802.11ax (HE20): 12 802.11n (HT40), 802.11ac (VHT40), 802.11ax (HE40): 6 802.11ac (VHT80), 802.11ax (HE80): 3 802.11ac (VHT160), 802.11ax (HE160): 1
Output Power	CDD mode: 5250 ~ 5320 MHz: 245.569 mW (23.90 dBm) 5500 ~ 5720 MHz: 243.08 mW (23.86 dBm) Beamforming mode: 5250 ~ 5320 MHz: 245.569 mW (23.90 dBm) 5500 ~ 5720 MHz: 228.551 mW (23.59 dBm)
EUT Category	Indoor Access Point

Note:

1. This report is issued as a supplementary report to BV CPS report no. RFCGJR-WTW-P23010147-3. The difference compared with original report is listed as below.
 - Add 5250 ~ 5320 MHz and 5500 ~ 5720 MHz by software
 - Add variant model
2. All models are listed as below. (New added is marked in gray)

Brand	Model	Difference
technicolor	EWM322TTCH2	for marketing purpose
	EGM322TTCH2	
	EWM322Tabcn	
	EGM322Tabcn	

Variable	Range of variable	Content
abc	Each character cab be a-z or A-Z	For marketing purpose only (customer abbreviation)
n	1-4 or blank	For marketing purpose only (sales territory)

3. The EUT uses following accessories.

AC Adapter 1			
Brand	Model	Part Number	Specification
Honor	ADS-42FI-12 12042EPCU-L	6322120A	AC Input : 100-120V, 50/60Hz DC Output : 12V, 3.5A DC Output Cable : 1.8m Plug : US

4. The above EUT information is declared by manufacturer and for more detailed features description, please refer to the manufacturer's specifications or user's manual.

3.2 Antenna Description of EUT

1. The antenna information is listed as below.

Antenna NO.	RF Chain NO.	Brand	Model	Antenna Net Gain(dBi)	Frequency range	Antenna Type	Connector Type
DB1	5G core0	Technicolor	EWM322T/EWA322T	5.61	5.15~5.25GHz	Dipole	ipex(MHF)
				4.91	5.25~5.35GHz	Dipole	ipex(MHF)
				5.45	5.47~5.725GHz	Dipole	ipex(MHF)
				5.47	5.725~5.85GHz	Dipole	ipex(MHF)
DB2	5G core1	Technicolor	EWM322T/EWA322T	5.96	5.15~5.25GHz	Dipole	ipex(MHF)
				5.77	5.25~5.35GHz	Dipole	ipex(MHF)
				5.91	5.47~5.725GHz	Dipole	ipex(MHF)
				5.53	5.725~5.85GHz	Dipole	ipex(MHF)
DB3	5G core2	Technicolor	EWM322T/EWA322T	4.21	5.15~5.25GHz	Dipole	ipex(MHF)
				4.21	5.25~5.35GHz	Dipole	ipex(MHF)
				4.81	5.47~5.725GHz	Dipole	ipex(MHF)
				4.80	5.725~5.85GHz	Dipole	ipex(MHF)
DB4	5G core3	Technicolor	EWM322T/EWA322T	3.96	5.15~5.25GHz	Dipole	ipex(MHF)
				4.18	5.25~5.35GHz	Dipole	ipex(MHF)
				4.06	5.47~5.725GHz	Dipole	ipex(MHF)
				3.86	5.725~5.85GHz	Dipole	ipex(MHF)

Directional Gain (dBi)	Frequency range
6.11	5.15~5.25GHz
6.08	5.25~5.35GHz
6.39	5.47~5.725GHz
6.48	5.725~5.85GHz

* The detailed antenna information, please refer to the Test report-Antenna Spec.pdf.

2. The EUT incorporates a MIMO function:

5 GHz Band		
Modulation Mode	TX & RX Configuration	
802.11a	4TX	4TX
802.11n (HT20)	4TX	4TX
802.11n (HT40)	4TX	4TX
802.11ac (VHT20)	4TX	4TX
802.11ac (VHT40)	4TX	4TX
802.11ac (VHT80)	4TX	4TX
802.11ac (VHT160)	4TX	4TX
802.11ax (HE20)	4TX	4TX
802.11ax (HE40)	4TX	4TX
802.11ax (HE80)	4TX	4TX
802.11ax (HE160)	4TX	4TX

Note:

- All of modulation mode support beamforming function except 802.11a modulation mode.
- The EUT support Beamforming and CDD mode, therefore both mode were investigated and the worst case scenario was identified. The worst case data were presented in test report.
- The EUT not support partial RU.

3.3 Channel List

For 5250 ~ 5320 MHz

4 channels are provided for 802.11a, 802.11n (HT20), 802.11ac (VHT20), 802.11ax (HE20):

Channel	Frequency	Channel	Frequency
52	5260 MHz	60	5300 MHz
56	5280 MHz	64	5320 MHz

2 channels are provided for 802.11n (HT40), 802.11ac (VHT40), 802.11ax (HE40):

Channel	Frequency	Channel	Frequency
54	5270 MHz	62	5310 MHz

1 channels are provided for 802.11ac (VHT80), 802.11ax (HE80):

Channel	Frequency
58	5290 MHz

1 channels are provided for 802.11ac (VHT160), 802.11ax (HE160):

Channel	Frequency
50	5250 MHz

For 5500 ~ 5720 MHz

12 channels are provided for 802.11a, 802.11n (HT20), 802.11ac (VHT20), 802.11ax (HE20):

Channel	Frequency	Channel	Frequency
100	5500 MHz	124	5620 MHz
104	5520 MHz	128	5640 MHz
108	5540 MHz	132	5660 MHz
112	5560 MHz	136	5680 MHz
116	5580 MHz	140	5700 MHz
120	5600 MHz	144	5720 MHz

6 channels are provided for 802.11n (HT40), 802.11ac (VHT40), 802.11ax (HE40):

Channel	Frequency	Channel	Frequency
102	5510 MHz	126	5630 MHz
110	5550 MHz	134	5670 MHz
118	5590 MHz	142	5710 MHz

3 channels are provided for 802.11ac (VHT80), 802.11ax (HE80):

Channel	Frequency	Channel	Frequency
106	5530 MHz	138	5690 MHz
122	5610 MHz		

1 channels are provided for 802.11ac (VHT160), 802.11ax (HE160):

Channel	Frequency
114	5570 MHz

3.4 Power Setting

Power Setting (CDD Mode)														
Channel	802.11a	802.11n (HT20)	802.11ac (VHT20)	802.11ax (HE20)	Channel	802.11n (HT40)	802.11ac (VHT40)	802.11ax (HE40)	Channel	802.11ac (VHT80)	802.11ax (HE80)	Channel	802.11ac (VHT160)	802.11ax (HE160)
52	67	68	68	68	54	70	70	70	58	70	70	50	67	67
60	67	68	68	68	62	70	70	70	106	70	70	114	63	63
64	70	70	70	70	102	72	72	72	122	68	68			
100	71	71	71	71	110	70	70	70	138	68	68			
116	70	69	69	69	134	67	67	67						
140	70	62	62	62	142	72	72	72						
144	70	69	69	69										

Power Setting (Beamforming Mode)														
Channel	802.11n (HT20)	802.11ac (VHT20)	802.11ax (HE20)	Channel	802.11n (HT40)	802.11ac (VHT40)	802.11ax (HE40)	Channel	802.11ac (VHT80)	802.11ax (HE80)	Channel	802.11ac (VHT160)	802.11ax (HE160)	
52	68	68	68	54	70	70	70	58	70	70	50	67	67	
60	68	68	68	62	70	70	70	106	69	69	114	63	63	
64	70	70	70	102	71	71	71	122	67	67				
100	70	70	70	110	69	69	69	138	68	68				
116	68	68	68	134	67	67	67							
140	62	62	62	142	72	72	72							
144	69	69	69											

3.5 Test Mode Applicability and Tested Channel Detail

Pre-Scan:	The EUT is designed to be positioned on the X-plane only.
-----------	---

Following channel(s) was (were) selected for the final test as listed below:

Test Item	Mode	Signal Mode	Tested Channel	Modulation	Data Rate Parameter
Power Spectral Density / 26 dB Bandwidth / Occupied Bandwidth	802.11a	CDD	52, 60, 64, 100, 116, 140, 144	BPSK	6Mb/s
	802.11ax (HE20)	CDD	52, 60, 64, 100, 116, 140, 144	BPSK	MCS0
	802.11ax (HE40)	CDD	54, 62, 102, 110, 134, 142	BPSK	MCS0
	802.11ax (HE80)	CDD	58, 106, 122, 138	BPSK	MCS0
	802.11ax (HE160)	CDD	50, 114	BPSK	MCS0
6 dB Bandwidth	802.11a	CDD	144	BPSK	6Mb/s
	802.11ax (HE20)	CDD	144	BPSK	MCS0
	802.11ax (HE40)	CDD	142	BPSK	MCS0
	802.11ax (HE80)	CDD	138	BPSK	MCS0
RF Output Power	802.11a	CDD	52, 60, 64, 100, 116, 140, 144	BPSK	6Mb/s
	802.11n (HT20)	CDD & Beamforming	52, 60, 64, 100, 116, 140, 144	BPSK	MCS0
	802.11n (HT40)	CDD & Beamforming	54, 62, 102, 110, 134, 142	BPSK	MCS0
	802.11ac (VHT20)	CDD & Beamforming	52, 60, 64, 100, 116, 140, 144	BPSK	MCS0
	802.11ac (VHT40)	CDD & Beamforming	54, 62, 102, 110, 134, 142	BPSK	MCS0
	802.11ac (VHT80)	CDD & Beamforming	58, 106, 122, 138	BPSK	MCS0
	802.11ac (VHT160)	CDD & Beamforming	50, 114	BPSK	MCS0
	802.11ax (HE20)	CDD & Beamforming	52, 60, 64, 100, 116, 140, 144	BPSK	MCS0
	802.11ax (HE40)	CDD & Beamforming	54, 62, 102, 110, 134, 142	BPSK	MCS0
	802.11ax (HE80)	CDD & Beamforming	58, 106, 122, 138	BPSK	MCS0
	802.11ax (HE160)	CDD & Beamforming	50, 114	BPSK	MCS0
Frequency Stability	802.11a	-	52	un-modulation	-
AC Power Conducted Emissions	802.11ax (HE40)	CDD	142	BPSK	MCS0
Unwanted Emissions below 1 GHz	802.11ax (HE40)	CDD	142	BPSK	MCS0
Unwanted Emissions above 1 GHz	802.11a	CDD	52, 60, 64, 100, 116, 140, 144	BPSK	6Mb/s
	802.11ax (HE20)	CDD	52, 60, 64, 100, 116, 140, 144	BPSK	MCS0
	802.11ax (HE40)	CDD	54, 62, 102, 110, 134, 142	BPSK	MCS0
	802.11ax (HE80)	CDD	58, 106, 122, 138	BPSK	MCS0
	802.11ax (HE160)	CDD	50, 114	BPSK	MCS0

3.6 Duty Cycle of Test Signal

802.11a: Duty cycle = 3.02 ms / 3.03 ms x 100% = 99.7%

802.11ax (HE20): Duty cycle = 3.32 ms / 3.33 ms x 100% = 99.7%

802.11ax (HE40): Duty cycle = 3.32 ms / 3.33 ms x 100% = 99.7%

802.11ax (HE80): Duty cycle = 3.18 ms / 3.19 ms x 100% = 99.7%

802.11ax (HE160): Duty cycle = 3.01 ms / 3.02 ms x 100% = 99.7%

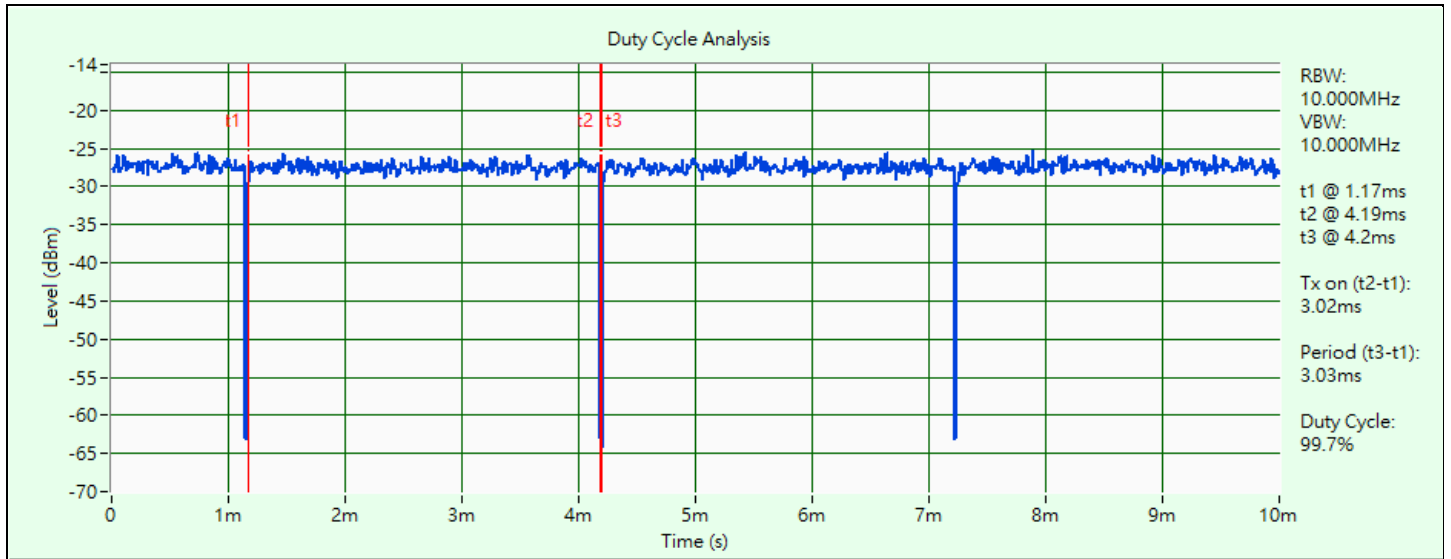

802.11a

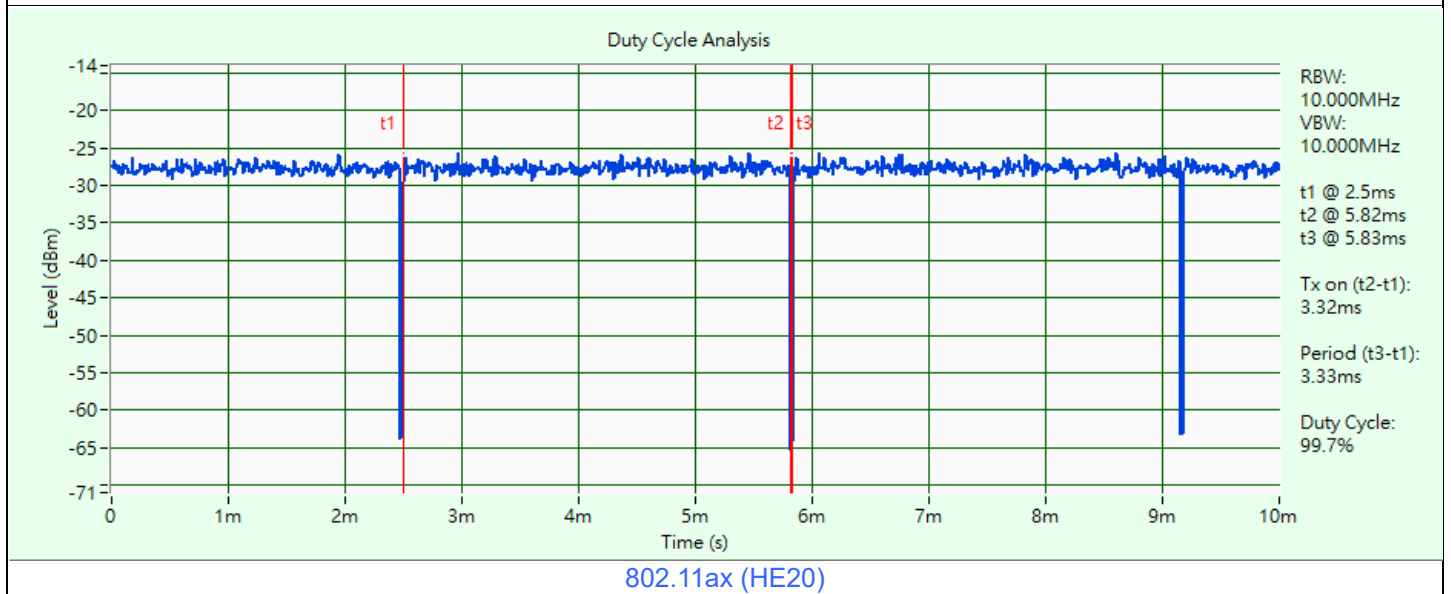

802.11ax (HE20)

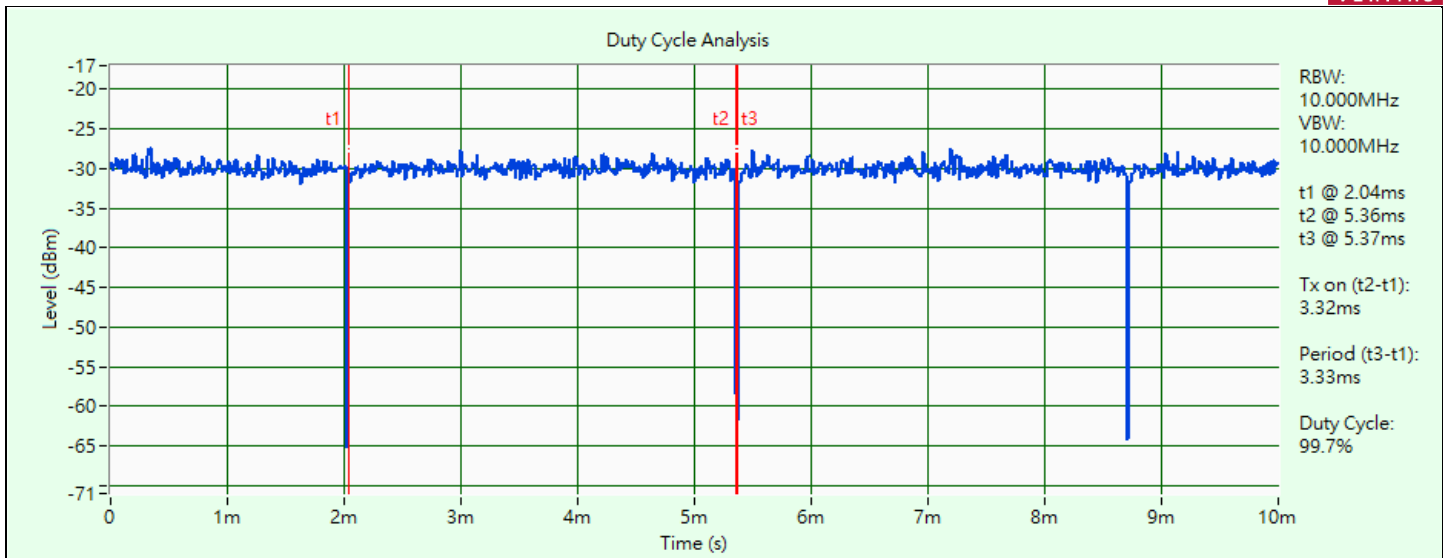

802.11ax (HE40)

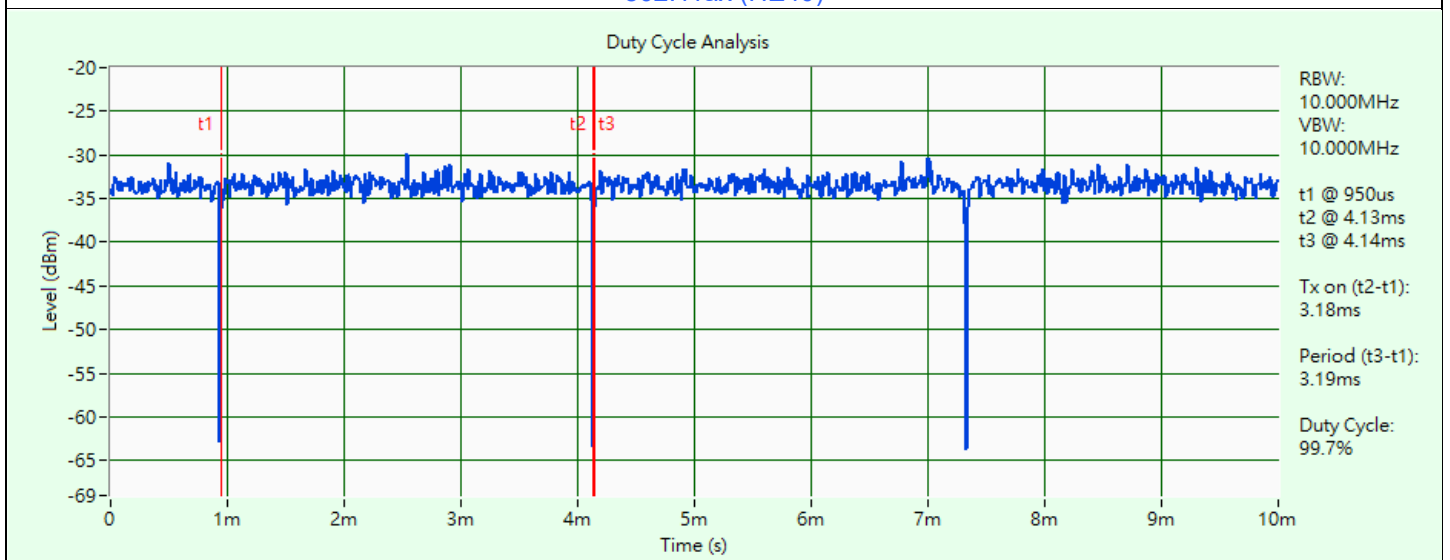

802.11ax (HE80)

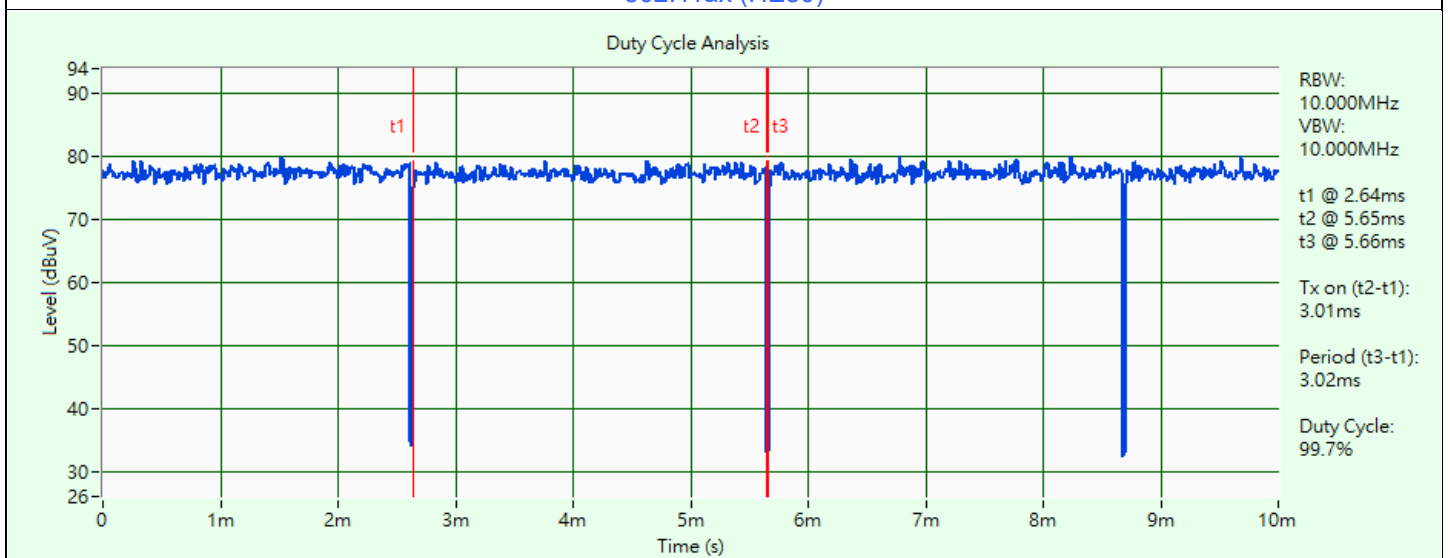

802.11ax (HE160)

3.7 Test Program Used and Operation Descriptions

Controlling software MTOOL_3.2.1.5 has been activated to set the EUT under transmission condition continuously at specific channel frequency.

3.8 Connection Diagram of EUT and Peripheral Devices

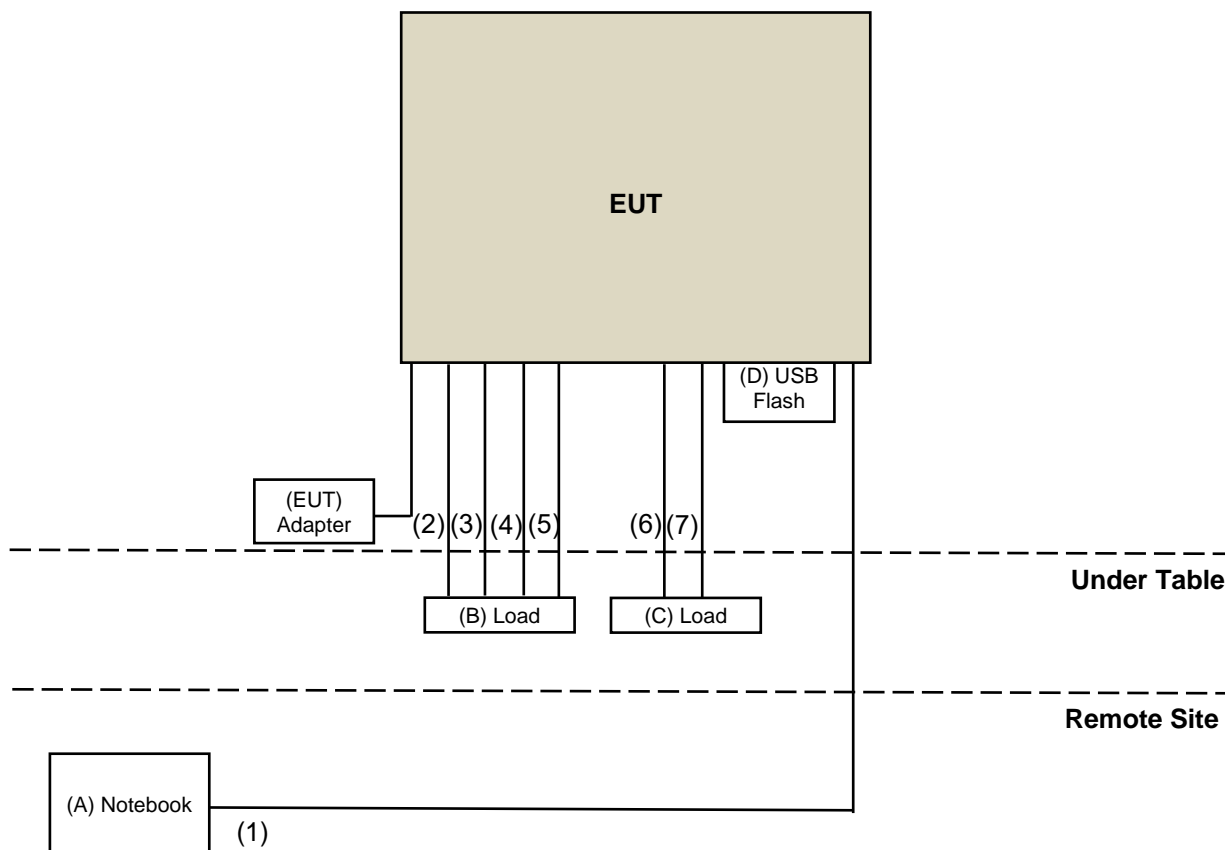

3.9 Configuration of Peripheral Devices and Cable Connections

ID	Product	Brand	Model No.	Serial No.	FCC ID	Remarks
A	Notebook	DELL	E6420	D3T96R1	N/A	Provided by Lab
B	Load	N/A	N/A	N/A	N/A	Provided by Lab
C	Load	N/A	N/A	N/A	N/A	Provided by Lab
D	FLASH	sandisk	SDDDC3-032G	N/A	N/A	Provided by Lab

ID	Cable Descriptions	Qty.	Length (m)	Shielding (Yes/No)	Cores (Qty.)	Remarks
1	LAN Cable	1	6	N	N	Provided by Lab
2	LAN Cable	1	1.5	N	N	Provided by Lab
3	LAN Cable	1	1.5	N	N	Provided by Lab
4	LAN Cable	1	1.5	N	N	Provided by Lab
5	LAN Cable	1	1.5	N	N	Provided by Lab
6	Tel. Cable	1	1.5	N	N	Provided by Lab
7	Tel. Cable	1	1.5	N	N	Provided by Lab

4 Test Instruments

The calibration interval of the all test instruments are 12 months and the calibrations are traceable to NML/ROC and NIST/USA.

4.1 26 dB Bandwidth

Description Manufacturer	Model No.	Serial No.	Calibrated Date	Calibrated Until
Signal and spectrum analyzer R&S	FSV3044	101105	2023/2/22	2024/2/21
Software BV	ADT_RF Test Software V6.6.5.4	N/A	N/A	N/A

Notes:

1. The test was performed in Oven room.
2. Tested Date: 2023/3/15 ~ 2023/3/16

4.2 RF Output Power

Description Manufacturer	Model No.	Serial No.	Calibrated Date	Calibrated Until
Signal and spectrum analyzer R&S	FSV3044	101105	2023/2/22	2024/2/21
Software BV	ADT_RF Test Software V6.6.5.4	N/A	N/A	N/A
USB Wideband Power Sensor KEYSIGHT	U2021XA	MY55050005/MY55190004/ MY55190007/MY55210005	2022/7/13	2023/7/12

Notes:

1. The test was performed in Oven room.
2. Tested Date: 2023/3/15 ~ 2023/3/16

4.3 Power Spectral Density

Refer to section 4.1 to get information of the instruments.

4.4 6 dB Bandwidth

Refer to section 4.1 to get information of the instruments.

4.5 Occupied Bandwidth

Refer to section 4.1 to get information of the instruments.

4.6 Frequency Stability

Description Manufacturer	Model No.	Serial No.	Calibrated Date	Calibrated Until
AC power supply JIN YIH Technology	6905S	1720444	N/A	N/A
Digital Multimeter Fluke	87-III	70360742	2022/6/23	2023/6/22
Signal and spectrum analyzer R&S	FSV3044	101105	2023/2/22	2024/2/21
Software BV	ADT_RF Test Software V6.6.5.4	N/A	N/A	N/A
Temperature & Humidity Chamber TERCHY	HRM-120RF	931022	2022/12/27	2023/12/26

Notes:

1. The test was performed in Oven room.
2. Tested Date: 2023/3/15 ~ 2023/3/16

4.7 AC Power Conducted Emissions

Description Manufacturer	Model No.	Serial No.	Calibrated Date	Calibrated Until
LISN R&S	ESH3-Z5	100311	2022/9/12	2023/9/11
LISN ROHDE & SCHWARZ	ENV216	101826	2022/3/14	2023/3/13
RF Coaxial Cable WOKEN	5D-FB	Cable-cond1-01	2023/1/7	2024/1/6
Software BVADT	BVADT_Cond_ V7.3.7.4	N/A	N/A	N/A
Test Receiver Rohde&Schwarz	ESCI	100613	2022/12/5	2023/12/4
V-LISN Schwarzbeck	NNBL 8226-2	8226-142	2022/8/31	2023/8/30

Notes:

1. The test was performed in HY - Conduction 1.
2. Tested Date: 2023/2/20

4.8 Unwanted Emissions below 1 GHz

Description Manufacturer	Model No.	Serial No.	Calibrated Date	Calibrated Until
Antenna Tower & Turn BV ADT	AT100	AT93021705	N/A	N/A
Bi_Log Antenna Schwarbeck	VULB9168	9168-160	2022/10/20	2023/10/19
Loop Antenna EMCI	EM-6879	269	2022/9/19	2023/9/18
Loop Antenna TESEQ	HLA 6121	45745	2022/7/27	2023/7/26
Pre-amplifier EMCI	EMC001340	980201	2022/9/23	2023/9/22
Preamplifier Agilent	8447D	2944A10638	2022/5/14	2023/5/13
RF Coaxial Cable EMCI	5D-NM-BM	140903+140902	2023/1/7	2024/1/6
RF Coaxial Cable WOKEN	8D-FB	Cable-CH9-01	2022/5/14	2023/5/13
Software BV ADT	ADT_Radiated_ V7.6.15.9.5	N/A	N/A	N/A
Spectrum Analyzer R&S	FSW43	101867	2022/12/30	2023/12/29
Test Receiver KEYSIGHT	N9038A	MY55420137	2022/4/27	2023/4/26
Turn Table BV ADT	TT100	TT93021705	N/A	N/A
Turn Table Controller BV ADT	SC100	SC93021705	N/A	N/A

Notes:

1. The test was performed in HY - 966 chamber 4.
2. Tested Date: 2023/2/17

4.9 Unwanted Emissions above 1 GHz

Description Manufacturer	Model No.	Serial No.	Calibrated Date	Calibrated Until
Antenna Tower & Turn BV ADT	AT100	AT93021705	N/A	N/A
Boresight antenna tower fixture BV	BAF-02	5	N/A	N/A
Horn Antenna Schwarzbeck	9120D	9120D-1169	2022/11/13	2023/11/12
	BBHA 9170	9170-480	2022/11/13	2023/11/12
		BBHA9170243	2022/11/13	2023/11/12
Pre-Amplifier EMCI	EMC 184045	980116	2022/10/1	2023/9/30
Preamplifier Agilent	8449B	3008A02367	2023/2/15	2024/2/14
RF Coaxial Cable EMCI	EMC102-KM-KM-600	150928	2022/7/9	2023/7/8
	EMC102-KM-KM-3000	150929	2022/7/9	2023/7/8
RF Coaxial Cable HUBER+SUHNER	SUCOFLEX 104	CABLE-CH9-(250795/4)	2023/1/7	2024/1/6
RF Coaxial Cable HUBER+SUHNER&EMCI	SUCOFLEX 104& EMC104-SM-SM8000	CABLE-CH9-02 (248780+171006)	2023/1/7	2024/1/6
RF FLITER MICRO-TRONICS	BRM17690	004	2023/1/11	2024/1/10
	BRM50716	060	2023/1/11	2024/1/10
Software BV ADT	ADT_Radiated_ V7.6.15.9.5	N/A	N/A	N/A
Spectrum Analyzer R&S	FSW43	101867	2022/12/30	2023/12/29
Test Receiver KEYSIGHT	N9038A	MY55420137	2022/4/27	2023/4/26
Turn Table BV ADT	TT100	TT93021705	N/A	N/A
Turn Table Controller BV ADT	SC100	SC93021705	N/A	N/A

Notes:

1. The test was performed in HY - 966 chamber 4.
2. Tested Date: 2023/2/15

5 Limits of Test Items

5.1 26 dB Bandwidth

The results are for reference only.

5.2 RF Output Power

Operation Band	EUT Category	Limit
U-NII-1	Outdoor Access Point	1 Watt (30 dBm) (Max. e.i.r.p \leq 125mW(21 dBm) at any elevation angle above 30 degrees as measured from the horizon)
	Fixed point-to-point Access Point	1 Watt (30 dBm)
	Indoor Access Point	1 Watt (30 dBm)
	Mobile and Portable client device	250mW (24 dBm)

Operation Band	Limit
U-NII-2A	250 mW (24 dBm) or 11 dBm+10 log B*
U-NII-2C	250 mW (24 dBm) or 11 dBm+10 log B*
U-NII-3	1 Watt (30 dBm)

*B is the 26 dB emission bandwidth in megahertz

Per KDB 662911 D01 Multiple Transmitter Output Method of conducted output power measurement on IEEE 802.11 devices,

Array Gain = 0 dB (i.e., no array gain) for $N_{ANT} \leq 4$;

Array Gain = 0 dB (i.e., no array gain) for channel widths ≥ 40 MHz for any N_{ANT} ;

Array Gain = 5 log(N_{ANT}/N_{SS}) dB or 3 dB, whichever is less, for 20-MHz channel widths with $N_{ANT} \geq 5$.

For power measurements on all other devices: Array Gain = 10 log(N_{ANT}/N_{SS}) dB.

5.3 Power Spectral Density

Operation Band	EUT Category	Limit
U-NII-1	Outdoor Access Point	17 dBm/MHz
	Fixed point-to-point Access Point	
	Indoor Access Point	
	Mobile and Portable client device	11 dBm/MHz

Operation Band	Limit
U-NII-2A	11 dBm/MHz
U-NII-2C	11 dBm/MHz
U-NII-3	30 dBm/500 kHz

5.4 6 dB Bandwidth

Within the 5.725-5.850 GHz band, the minimum 6 dB bandwidth of U-NII devices shall be at least 500 kHz.

5.5 Occupied Bandwidth

The results are for reference only.

5.6 Frequency Stability

The frequency of the carrier signal shall be maintained within band of operation.

5.7 AC Power Conducted Emissions

Frequency (MHz)	Conducted Limit (dBuV)	
	Quasi-peak	Average
0.15 - 0.5	66 - 56	56 - 46
0.50 - 5.0	56	46
5.0 - 30.0	60	50

Notes:

1. The lower limit shall apply at the transition frequencies.
2. The limit decreases in line with the logarithm of the frequency in the range of 0.15 to 0.50 MHz.

5.8 Unwanted Emissions below 1 GHz

Radiated emissions which fall in the restricted bands must comply with the radiated emission limits specified as below table.

Frequencies (MHz)	Field Strength (microvolts/meter)	Measurement Distance (meters)
0.009 ~ 0.490	2400/F(kHz)	300
0.490 ~ 1.705	24000/F(kHz)	30
1.705 ~ 30.0	30	30
30 ~ 88	100	3
88 ~ 216	150	3
216 ~ 960	200	3
Above 960	500	3

Notes:

1. The lower limit shall apply at the transition frequencies.
2. Emission level (dBuV/m) = 20 log Emission level (uV/m).

5.9 Unwanted Emissions above 1 GHz

Radiated emissions which fall in the restricted bands must comply with the radiated emission limits specified as below table.

Frequencies (MHz)	Field Strength (microvolts/meter)	Measurement Distance (meters)
Above 960	500	3

Notes:

1. The lower limit shall apply at the transition frequencies.
2. Emission level (dBuV/m) = 20 log Emission level (uV/m).
3. For frequencies above 1000 MHz, the field strength limits are based on average detector, however, the peak field strength of any emission shall not exceed the maximum permitted average limits, specified above by more than 20 dB under any condition of modulation.

Limits of unwanted emission out of the restricted bands

Applicable To	Limit	
789033 D02 General UNII Test Procedure New Rules v02r01	Field Strength at 3 m	
	PK: 74 (dBμV/m)	AV: 54 (dBμV/m)

For transmitters operating in the 5.15-5.25 GHz band:

Applicable To	EIRP Limit	Equivalent Field Strength at 3 m
15.407(b)(1)	PK: -27 (dBm/MHz)	PK: 68.2 (dBμV/m)

For transmitters operating in the 5.25-5.35 GHz band:

Applicable To	EIRP Limit	Equivalent Field Strength at 3 m
15.407(b)(2)	PK: -27 (dBm/MHz)	PK: 68.2 (dBμV/m)

For transmitters operating in the 5.47-5.725 GHz band:

Applicable To	EIRP Limit	Equivalent Field Strength at 3 m
15.407(b)(3)	PK: -27 (dBm/MHz)	PK: 68.2 (dBμV/m)

For transmitters operating in the 5.725-5.850 GHz band:

Applicable To	EIRP Limit	Equivalent Field Strength at 3 m
15.407(b)(4)(i)	PK: -27 (dBm/MHz) ^{*1}	PK: 68.2 (dBμV/m) ^{*1}
	PK: 10 (dBm/MHz) ^{*2}	PK: 105.2 (dBμV/m) ^{*2}
	PK: 15.6 (dBm/MHz) ^{*3}	PK: 110.8 (dBμV/m) ^{*3}
	PK: 27 (dBm/MHz) ^{*4}	PK: 122.2 (dBμV/m) ^{*4}

^{*1} beyond 75 MHz or more above of the band edge.

^{*2} below the band edge increasing linearly to 10 dBm/MHz at 25 MHz above.

^{*3} below the band edge increasing linearly to a level of 15.6 dBm/MHz at 5 MHz above.

^{*4} from 5 MHz above or below the band edge increasing linearly to a level of 27 dBm/MHz at the band edge.

Note: The following formula is used to convert the equipment isotropic radiated power (eirp) to field strength:

$$E = \frac{1000000\sqrt{30P}}{3} \mu\text{V/m, where P is the eirp (Watts).}$$

6 Test Arrangements

6.1 26 dB Bandwidth

6.1.1 Test Setup

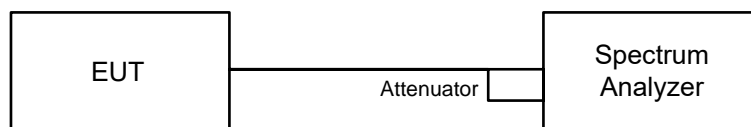

6.1.2 Test Procedure

- a. Set RBW = approximately 1% of the emission bandwidth.
- b. Set the VBW > RBW.
- c. Detector = Peak.
- d. Trace mode = max hold.
- e. Measure the maximum width of the emission that is 26 dB down from the peak of the emission. Compare this with the RBW setting of the analyzer. Readjust RBW and repeat measurement as needed until the RBW/EBW ratio is approximately 1%.

6.2 RF Output Power

6.2.1 Test Setup

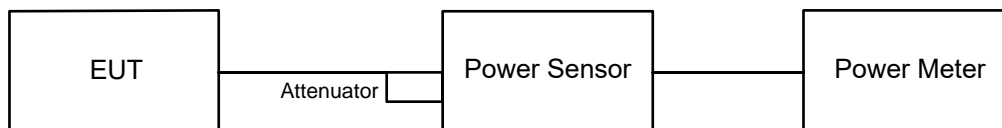

For channel straddling:

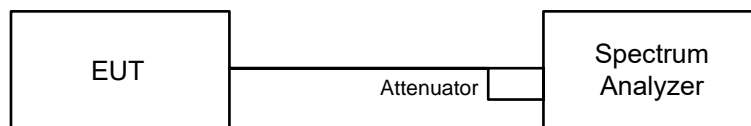

6.2.2 Test Procedure

Method PM is used to perform output power measurement, trigger and gating function of wide band power meter is enabled to measure max output power of TX on burst and set the detector to average. Duty factor is not added to measured value.

For channel straddling:

Method SA-1

- a. Set span to encompass the entire emission bandwidth (EBW) of the signal.
- b. Set RBW = 1 MHz, Set VBW \geq 3 MHz, Detector = RMS
- c. Sweep points \geq $[2 \times \text{span} / \text{RBW}]$. (This gives bin-to-bin spacing \leq RBW / 2, so that narrowband signals are not lost between frequency bins.)
- d. Sweep time = auto, trigger set to "free run".
- e. Trace average at least 100 traces in power averaging mode.
- f. Record the max value

Note: When measuring straddle channel power, use compute power by integrating the spectrum across the 26 dB EBW or 99% OBW of the signal using the instrument's band power measurement function, with band limits set equal to the EBW or OBW band edges. If the instrument does not have a band power function, then sum the spectrum levels (in power units) at 1 MHz intervals extending across the 26 dB EBW or 99% OBW of the spectrum.

6.3 Power Spectral Density

6.3.1 Test Setup

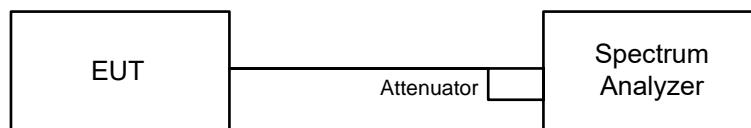

6.3.2 Test Procedure

For specified measurement bandwidth 1 MHz:

Method SA-1

- Set span to encompass the entire emission bandwidth (EBW) of the signal.
- Set RBW = 1 MHz, Set VBW \geq 3 MHz, Detector = RMS
- Sweep points \geq $[2 \times \text{span} / \text{RBW}]$. (This gives bin-to-bin spacing \leq RBW / 2, so that narrowband signals are not lost between frequency bins.)
- Sweep time = auto, trigger set to "free run".
- Trace average at least 100 traces in power averaging mode.
- Record the max value

For specified measurement bandwidth 500 kHz:

Method SA-1

- Set span to encompass the entire emission bandwidth (EBW) of the signal.
- Set RBW = 300 kHz, Set VBW \geq 1 MHz, Detector = RMS
- Scale the observed power level to an equivalent value in 500 kHz by adjusting (increasing) the measured power by a bandwidth correction factor (BWCF) where $\text{BWCF} = 10\log(500 \text{ kHz}/300 \text{ kHz})$
- Sweep points \geq $[2 \times \text{span} / \text{RBW}]$. (This gives bin-to-bin spacing \leq RBW / 2, so that narrowband signals are not lost between frequency bins.)
- Sweep time = auto, trigger set to "free run".
- Trace average at least 100 traces in power averaging mode.
- Record the max value

6.4 6 dB Bandwidth

6.4.1 Test Setup

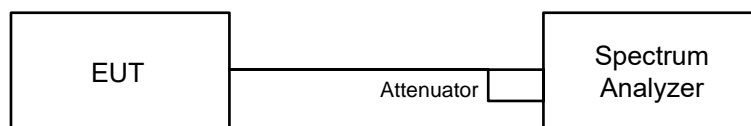

6.4.2 Test Procedure

- Set resolution bandwidth (RBW) = 100 kHz.
- Set the video bandwidth (VBW) \geq 3 x RBW, Detector = Peak.
- Trace mode = max hold.
- Sweep = auto couple.
- Measure the maximum width of the emission that is constrained by the frequencies associated with the two amplitude points (upper and lower) that are attenuated by 6 dB relative to the maximum level measured in the fundamental emission.

6.5 Occupied Bandwidth

6.5.1 Test Setup

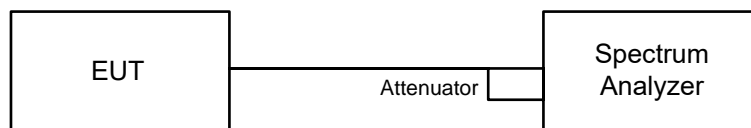

6.5.2 Test Procedure

The transmitter output was connected to the spectrum analyzer through an attenuator. The bandwidth of the fundamental frequency was measured by spectrum analyzer with resolution bandwidth in the range of 1% to 5% of the anticipated emission bandwidth, and a video bandwidth at least 3x the resolution bandwidth and set the detector to Sampling. The width of a frequency band such that, below the lower and above the upper frequency limits, the mean powers emitted are each equal to a specified percentage 0.5% of the total mean power of a given emission.

6.6 Frequency Stability

6.6.1 Test Setup

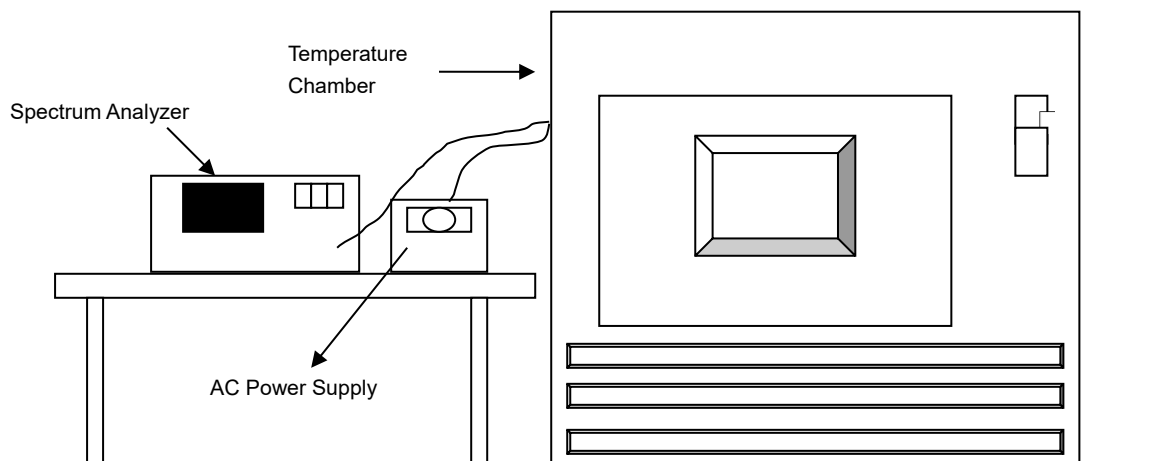

6.6.2 Test Procedure

- The EUT was placed inside the environmental test chamber and powered by nominal AC voltage.
- Turn the EUT on and couple its output to a spectrum analyzer.
- Turn the EUT off and set the chamber to the highest temperature specified.
- Allow sufficient time (approximately 30 min) for the temperature of the chamber to stabilize, turn the EUT on and measure the operating frequency after 2, 5, and 10 Minutes.
- Repeat step (d) with the temperature chamber set to the next desired temperature until measurements down to the lowest specified temperature have been completed.
- The test chamber was allowed to stabilize at +20 degree C for a minimum of 30 Minutes. The supply voltage was then adjusted on the EUT from 85% to 115% and the frequency record.

6.7 AC Power Conducted Emissions

6.7.1 Test Setup

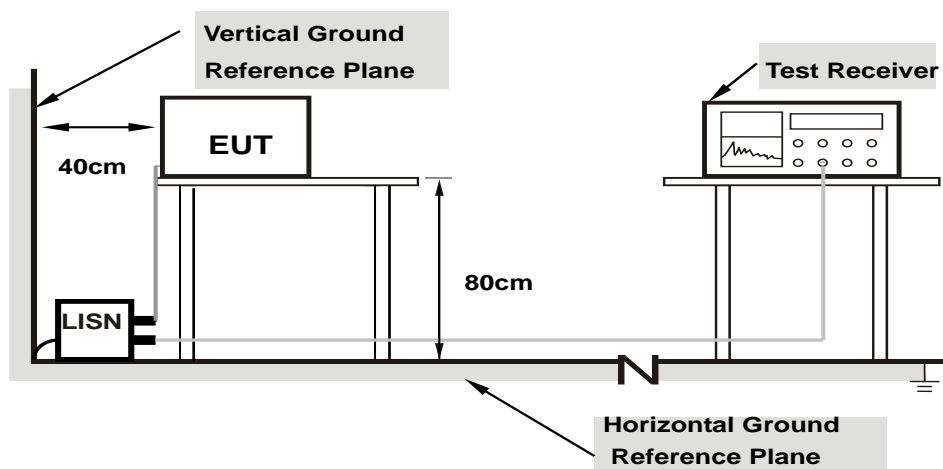

Note: 1.Support units were connected to second LISN.

For the actual test configuration, please refer to the attached file (Test Setup Photo).

6.7.2 Test Procedure

- The EUT was placed on a 0.8 meter to the top of table and placed 0.4 meters from the conducting wall of the shielded room with EUT being connected to the power mains through a line impedance stabilization network (LISN). Other support units were connected to the power mains through another LISN. The two LISNs provide 50 ohm/ 50 uH of coupling impedance for the measuring instrument.
- Both lines of the power mains connected to the EUT were checked for maximum conducted interference.
- The frequency range from 150 kHz to 30 MHz was searched. Emission levels under (Limit – 20 dB) was not recorded.

Note: The resolution bandwidth and video bandwidth of test receiver is 9 kHz for quasi-peak detection (QP) and average detection (AV) at frequency 0.15 MHz-30 MHz.

6.8 Unwanted Emissions below 1 GHz

6.8.1 Test Setup

For Radiated emission below 30 MHz

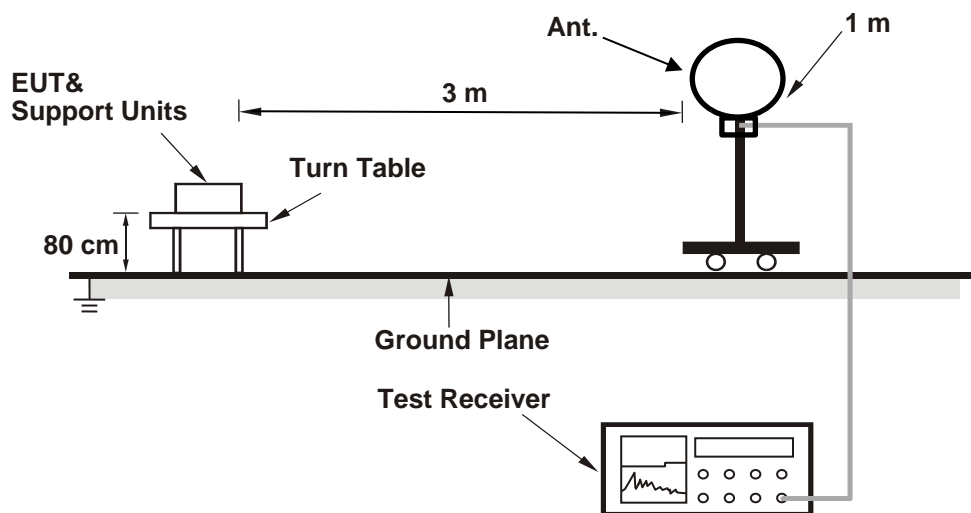

For Radiated emission above 30 MHz

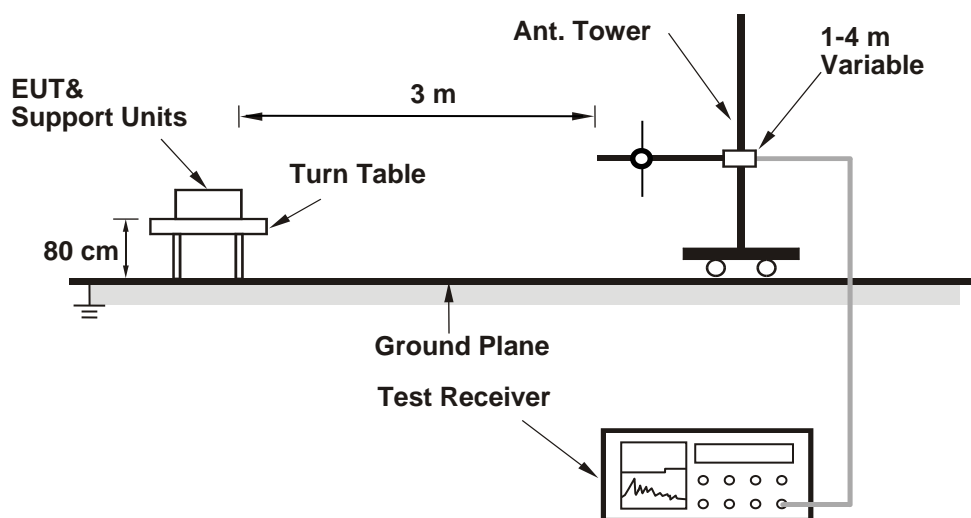

For the actual test configuration, please refer to the attached file (Test Setup Photo).

6.8.2 Test Procedure

For Radiated emission below 30 MHz

- a. The EUT was placed on the top of a rotating table 0.8 meters above the ground at 3 meter chamber room for test. The table was rotated 360 degrees to determine the position of the highest radiation.
- b. The EUT was set 3 meters away from the interference-receiving antenna, which was mounted on the top of a variable-height antenna tower.
- c. Parallel, perpendicular, and ground-parallel orientations of the antenna are set to make the measurement.
- d. For each suspected emission, the EUT was arranged to its worst case and the rotatable table was turned from 0 degrees to 360 degrees to find the maximum reading.
- e. The test-receiver system was set to Quasi-Peak Detect Function and Specified Bandwidth with Maximum Hold Mode, except for the frequency band (9 kHz to 90 kHz and 110 kHz to 490 kHz) set to average detect function and peak detect function.

Notes:

1. The resolution bandwidth and video bandwidth of test receiver/spectrum analyzer is 200 Hz at frequency below 150 kHz.
2. The resolution bandwidth and video bandwidth of test receiver/spectrum analyzer is 9 kHz or 10 kHz at frequency (150 kHz to 30 MHz).
3. All modes of operation were investigated and the worst-case emissions are reported.

For Radiated emission above 30 MHz

- a. The EUT was placed on the top of a rotating table 0.8 meters above the ground at 3 meter chamber room for test. The table was rotated 360 degrees to determine the position of the highest radiation.
- b. The EUT was set 3 meters away from the interference-receiving antenna, which was mounted on the top of a variable-height antenna tower.
- c. The height of antenna is varied from one meter to four meters above the ground to determine the maximum value of the field strength. Both horizontal and vertical polarizations of the antenna are set to make the measurement.
- d. For each suspected emission, the EUT was arranged to its worst case and then the antenna was tuned to heights from 1 meter to 4 meters and the rotatable table was turned from 0 degrees to 360 degrees to find the maximum reading.
- e. The test-receiver system was set to quasi-peak detect function and specified bandwidth with maximum hold mode when the test frequency is below 1 GHz.

Notes:

1. The resolution bandwidth and video bandwidth of test receiver/spectrum analyzer is 120 kHz for Quasi-peak detection (QP) at frequency below 1 GHz.
2. All modes of operation were investigated and the worst-case emissions are reported.

6.9 Unwanted Emissions above 1 GHz

6.9.1 Test Setup

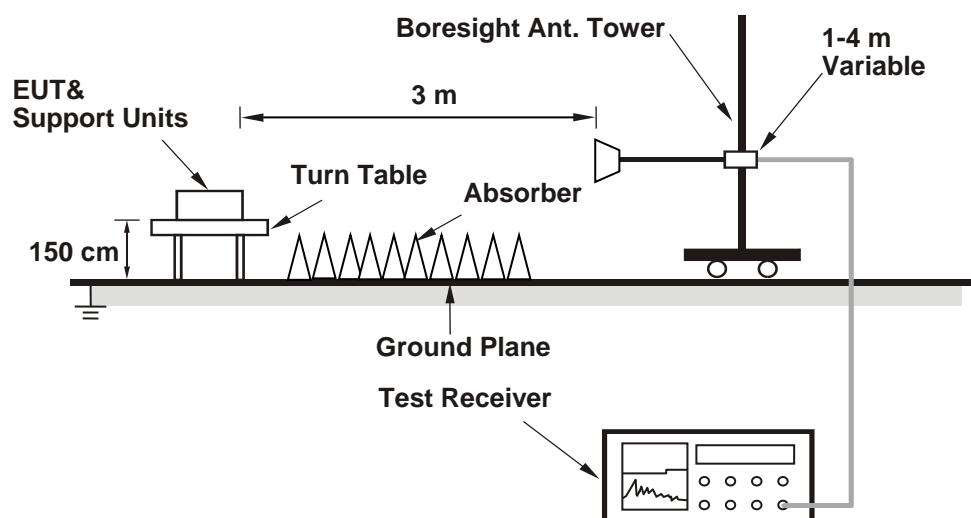

For the actual test configuration, please refer to the attached file (Test Setup Photo).

6.9.2 Test Procedure

- The EUT was placed on the top of a rotating table 1.5 meters above the ground at 3 meter chamber room for test. The table was rotated 360 degrees to determine the position of the highest radiation.
- The EUT was set 3 meters away from the interference-receiving antenna, which was mounted on the top of a variable-height antenna tower.
- The height of antenna is varied from one meter to four meters above the ground to determine the maximum value of the field strength. Both horizontal and vertical polarizations of the antenna are set to make the measurement.
- For each suspected emission, the EUT was arranged to its worst case and then the antenna was tuned to heights from 1 meter to 4 meters and the rotatable table was turned from 0 degrees to 360 degrees to find the maximum reading.
- The test-receiver system was set to peak and average detects function and specified bandwidth with maximum hold mode when the test frequency is above 1 GHz. If the peak reading value also meets average limit, measurement with the average detector is unnecessary.

Notes:

- The resolution bandwidth of test receiver/spectrum analyzer is 1 MHz and the video bandwidth is 3 MHz for Peak detection (PK) and Average detection (AV) at frequency above 1 GHz.
- For fundamental and harmonic signal measurement, the resolution bandwidth of test receiver/spectrum analyzer is 1 MHz and the video bandwidth is $\geq 1/T$ (Duty cycle $< 98\%$) or 10 Hz (Duty cycle $\geq 98\%$) for Average detection (AV) at frequency above 1 GHz.
- All modes of operation were investigated and the worst-case emissions are reported.

7 Test Results of Test Item

7.1 26 dB Bandwidth

Input Power:	120 Vac, 60 Hz	Environmental Conditions:	25°C, 60% RH	Tested By:	Gary Lin / Wayne Lin
--------------	----------------	---------------------------	--------------	------------	----------------------

802.11a

Channel	Frequency (MHz)	26 dB Bandwidth (MHz)			
		Chain 0	Chain 1	Chain 2	Chain 3
52	5260	21.65	21.65	21.64	21.50
60	5300	21.98	21.58	21.69	21.51
64	5320	22.47	22.60	22.12	22.04
100	5500	22.84	23.21	22.87	22.52
116	5580	21.61	21.07	21.45	21.64
140	5700	21.56	21.00	21.54	21.35
144 (U-NII-2C)	5720	15.62	15.85	15.74	15.88
144 (U-NII-3)	5720	5.77	5.77	5.77	5.82

Determined Output Power Limit			
Channel Number	Freq.(MHz)	Min. B(MHz)	Determined Conducted Power Limit (dBm)
52	5260	21.50	24.32 > 24
60	5300	21.51	24.32 > 24
64	5320	22.04	24.43 > 24
100	5500	22.52	24.52 > 24
116	5580	21.07	24.23 > 24
140	5700	21.00	24.22 > 24
144 (U-NII-2C)	5720	15.62	22.93 < 24

Note: For U-NII-2A, U-NII-2C Band output power limitation is determined based on 26dBc bandwidth.

802.11ax (HE20)

Channel	Frequency (MHz)	26 dB Bandwidth (MHz)			
		Chain 0	Chain 1	Chain 2	Chain 3
52	5260	21.81	21.80	21.89	21.99
60	5300	22.11	22.01	21.92	21.74
64	5320	23.86	22.28	24.21	23.55
100	5500	24.04	24.82	26.29	26.85
116	5580	21.94	22.01	21.82	21.94
140	5700	21.99	21.91	21.84	21.86
144 (U-NII-2C)	5720	16.02	15.93	15.94	15.98
144 (U-NII-3)	5720	6.01	5.94	5.98	5.95

Determined Output Power Limit			
Channel Number	Freq.(MHz)	Min. B(MHz)	Determined Conducted Power Limit (dBm)
52	5260	21.80	24.38 > 24
60	5300	21.74	24.37 > 24
64	5320	22.28	24.47 > 24
100	5500	24.04	24.8 > 24
116	5580	21.82	24.38 > 24
140	5700	21.84	24.39 > 24
144 (U-NII-2C)	5720	15.93	23.02 < 24

Note: For U-NII-2A, U-NII-2C Band output power limitation is determined based on 26dBc bandwidth.

802.11ax (HE40)

Channel	Frequency (MHz)	26 dB Bandwidth (MHz)			
		Chain 0	Chain 1	Chain 2	Chain 3
54	5270	41.81	41.92	41.71	42.14
62	5310	50.15	49.59	55.05	43.94
102	5510	48.09	47.84	53.83	43.13
110	5550	41.87	41.77	41.89	41.58
134	5670	41.73	41.87	41.77	41.86
142 (U-NII-2C)	5710	35.91	35.92	35.77	36.03
142 (U-NII-3)	5710	5.95	5.82	5.84	5.93

Determined Output Power Limit			
Channel Number	Freq.(MHz)	Min. B(MHz)	Determined Conducted Power Limit (dBm)
54	5270	41.71	27.2 > 24
62	5310	43.94	27.42 > 24
102	5510	43.13	27.34 > 24
110	5550	41.58	27.18 > 24
134	5670	41.73	27.2 > 24
142 (U-NII-2C)	5710	35.77	26.53 > 24

Note: For U-NII-2A, U-NII-2C Band output power limitation is determined based on 26dBc bandwidth.

802.11ax (HE80)

Channel	Frequency (MHz)	26 dB Bandwidth (MHz)			
		Chain 0	Chain 1	Chain 2	Chain 3
58	5290	84.94	84.85	85.69	90.43
106	5530	85.35	85.24	85.75	83.73
122	5610	83.05	82.70	82.97	82.73
138 (U-NII-2C)	5690	76.39	76.45	76.52	76.66
138 (U-NII-3)	5690	6.48	6.46	6.47	6.52

Determined Output Power Limit			
Channel Number	Freq.(MHz)	Min. B(MHz)	Determined Conducted Power Limit (dBm)
58	5290	84.85	30.28 > 24
106	5530	83.73	30.22 > 24
122	5610	82.70	30.17 > 24
138 (U-NII-2C)	5690	76.39	29.83 > 24

Note: For U-NII-2A, U-NII-2C Band output power limitation is determined based on 26dBc bandwidth.

802.11ax (HE160)

Channel	Frequency (MHz)	26 dB Bandwidth (MHz)			
		Chain 0	Chain 1	Chain 2	Chain 3
50 (U-NII-1)	5250	84.13	83.67	83.86	83.90
50 (U-NII-2A)	5250	84.78	84.87	84.70	84.63
114	5570	168.67	168.18	168.26	169.52

Determined Output Power Limit			
Channel Number	Freq.(MHz)	Min. B(MHz)	Determined Conducted Power Limit (dBm)
50 (U-NII-2A)	5250	84.63	30.27 > 24
114	5570	168.18	33.25 > 24

Note: For U-NII-2A, U-NII-2C Band output power limitation is determined based on 26dBc bandwidth.



Spectrum Plot of Minimum Value

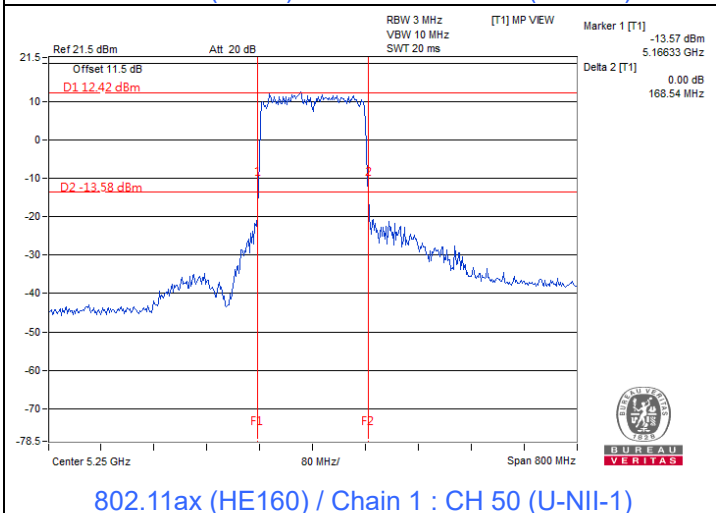
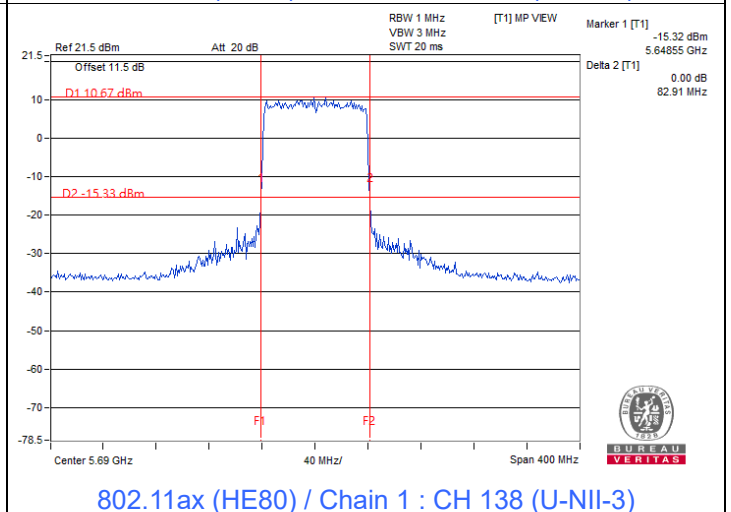
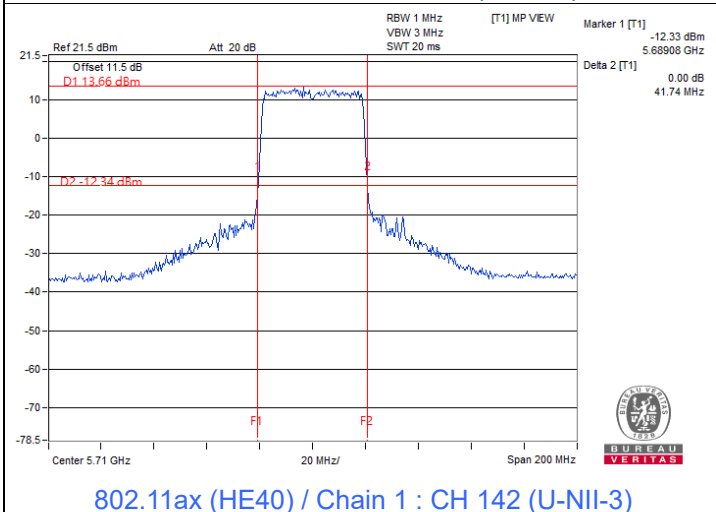
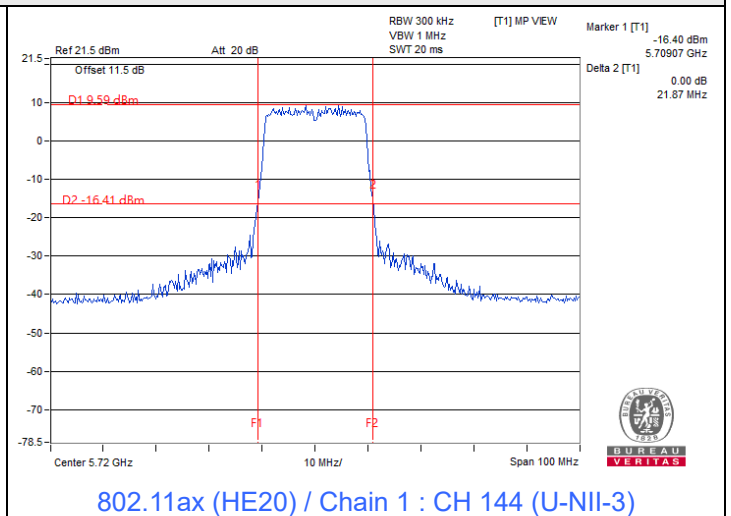
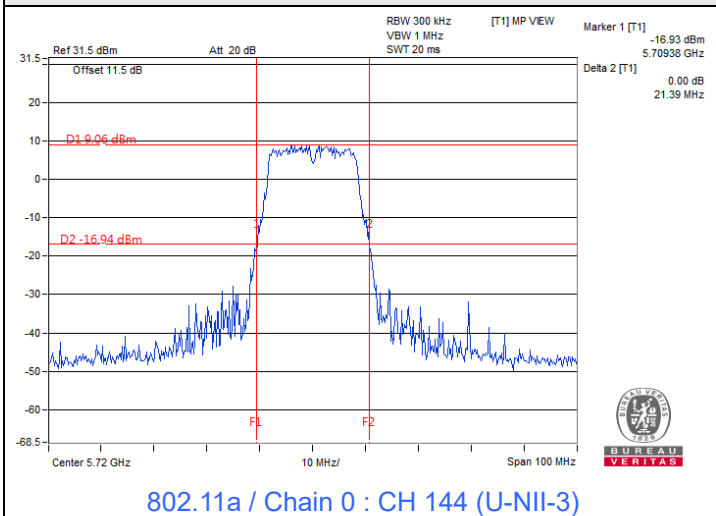

Notes:

1. For U-NII-2C straddle channel = 5725 MHz - Marker 1
2. For U-NII-3 straddle channel = Marker 1 + Delta 2 - 5725 MHz
3. For U-NII-1 straddle channel = 5250 MHz - Marker 1
4. For U-NII-2A straddle channel = Marker 1 + Delta 2 - 5250 MHz

7.2 RF Output Power

Input Power:	120 Vac, 60 Hz	Environmental Conditions:	25°C, 60% RH	Tested By:	Gary Lin / Wayne Lin
--------------	----------------	---------------------------	--------------	------------	----------------------

802.11a CDD

Chan.	Chan. Freq. (MHz)	Average Power (dBm)				Total Power (mW)	Total Power (dBm)	Power Limit (dBm)	Test Result
		Chain 0	Chain 1	Chain 2	Chain 3				
52	5260	17.51	17.82	17.45	17.89	234.006	23.69	24	Pass
60	5300	17.34	17.68	17.44	17.85	229.23	23.60	24	Pass
64	5320	17.48	17.68	17.45	17.83	230.854	23.63	24	Pass
100	5500	17.36	17.55	17.46	17.84	227.868	23.58	24	Pass
116	5580	17.84	17.75	17.83	17.65	239.264	23.79	24	Pass
140	5700	17.51	17.53	17.52	17.55	226.367	23.55	24	Pass
*144 (U-NII-2C)	5720	16.29	16.42	16.41	16.24	172.238	22.36	22.93	Pass
*144 (U-NII-3)	5720	10.17	10.09	10.05	10.07	40.887	16.12	30	Pass

Notes:

- * : Test was performed in accordance with measurement follow FCC KDB 789033 UNII test procedure Method SA-1 and use spectrum analyzer test.
- Directional gain is the maximum gain of antennas.
- For U-NII-2A, the directional gain is 5.77 dBi < 6 dBi, so the output power limit shall not be reduced.
- For U-NII-2C, the directional gain is 5.91 dBi < 6 dBi, so the output power limit shall not be reduced.
- For U-NII-3, the directional gain is 5.53 dBi < 6 dBi, so the output power limit shall not be reduced.

802.11n (HT20) CDD

Chan.	Chan. Freq. (MHz)	Average Power (dBm)				Total Power (mW)	Total Power (dBm)	Power Limit (dBm)	Test Result
		Chain 0	Chain 1	Chain 2	Chain 3				
52	5260	17.78	17.75	17.79	18.01	242.904	23.85	24	Pass
60	5300	17.62	17.86	17.49	17.93	237.096	23.75	24	Pass
64	5320	17.58	17.52	17.40	17.96	231.245	23.64	24	Pass
100	5500	17.68	17.48	17.45	17.72	229.336	23.60	24	Pass
116	5580	17.95	17.70	17.94	17.50	239.722	23.80	24	Pass
140	5700	15.82	16.01	15.84	15.79	154.399	21.89	24	Pass
*144 (U-NII-2C)	5720	16.01	15.82	16.02	16.04	158.27	21.99	23.02	Pass
*144 (U-NII-3)	5720	11.05	10.67	10.53	10.81	47.751	16.79	30	Pass

Notes:

- * : Test was performed in accordance with measurement follow FCC KDB 789033 UNII test procedure Method SA-1 and use spectrum analyzer test.
- Directional gain is the maximum gain of antennas.
- For U-NII-2A, the directional gain is 5.77 dBi < 6 dBi, so the output power limit shall not be reduced.
- For U-NII-2C, the directional gain is 5.91 dBi < 6 dBi, so the output power limit shall not be reduced.
- For U-NII-3, the directional gain is 5.53 dBi < 6 dBi, so the output power limit shall not be reduced.

802.11n (HT40) CDD

Chan.	Chan. Freq. (MHz)	Average Power (dBm)				Total Power (mW)	Total Power (dBm)	Power Limit (dBm)	Test Result
		Chain 0	Chain 1	Chain 2	Chain 3				
54	5270	17.83	17.90	17.84	17.35	237.472	23.76	24	Pass
62	5310	17.73	17.72	17.70	17.05	228.032	23.58	24	Pass
102	5510	17.36	17.95	17.83	17.62	235.307	23.72	24	Pass
110	5550	17.48	17.93	17.80	17.50	234.553	23.70	24	Pass
134	5670	16.80	16.71	16.84	16.45	187.207	22.72	24	Pass
*142 (U-NII-2C)	5710	16.96	16.97	17.05	16.80	197.995	22.97	24	Pass
*142 (U-NII-3)	5710	7.93	7.67	7.41	7.33	22.972	13.61	30	Pass

Notes:

- * : Test was performed in accordance with measurement follow FCC KDB 789033 UNII test procedure Method SA-1 and use spectrum analyzer test.
- Directional gain is the maximum gain of antennas.
- For U-NII-2A, the maximum gain is 5.77 dBi < 6 dBi, so the output power limit shall not be reduced.
- For U-NII-2C, the maximum gain is 5.91 dBi < 6 dBi, so the output power limit shall not be reduced.
- For U-NII-3, the maximum gain is 5.53 dBi < 6 dBi, so the output power limit shall not be reduced.

802.11ac (VHT20) CDD

Chan.	Chan. Freq. (MHz)	Average Power (dBm)				Total Power (mW)	Total Power (dBm)	Power Limit (dBm)	Test Result
		Chain 0	Chain 1	Chain 2	Chain 3				
52	5260	17.80	17.78	17.82	18.03	244.302	23.88	24	Pass
60	5300	17.66	17.89	17.55	18.01	239.989	23.80	24	Pass
64	5320	17.61	17.54	17.42	17.98	232.445	23.66	24	Pass
100	5500	17.69	17.50	17.46	17.74	230.131	23.62	24	Pass
116	5580	17.96	17.72	17.96	17.52	240.684	23.81	24	Pass
140	5700	15.83	16.02	15.86	15.82	155.019	21.90	24	Pass
*144 (U-NII-2C)	5720	16.03	15.85	16.04	16.07	159.183	22.02	23.02	Pass
*144 (U-NII-3)	5720	11.08	10.70	10.55	10.83	48.028	16.81	30	Pass

Notes:

- * : Test was performed in accordance with measurement follow FCC KDB 789033 UNII test procedure Method SA-1 and use spectrum analyzer test.
- Directional gain is the maximum gain of antennas.
- For U-NII-2A, the directional gain is 5.77 dBi < 6 dBi, so the output power limit shall not be reduced.
- For U-NII-2C, the directional gain is 5.91 dBi < 6 dBi, so the output power limit shall not be reduced.
- For U-NII-3, the directional gain is 5.53 dBi < 6 dBi, so the output power limit shall not be reduced.

802.11ac (VHT40) CDD

Chan.	Chan. Freq. (MHz)	Average Power (dBm)				Total Power (mW)	Total Power (dBm)	Power Limit (dBm)	Test Result
		Chain 0	Chain 1	Chain 2	Chain 3				
54	5270	17.91	17.95	17.94	17.40	241.359	23.83	24	Pass
62	5310	17.80	17.78	17.72	17.11	230.796	23.63	24	Pass
102	5510	17.41	18.00	17.87	17.66	237.756	23.76	24	Pass
110	5550	17.51	17.96	17.85	17.53	236.459	23.74	24	Pass
134	5670	16.83	16.74	16.90	16.49	188.945	22.76	24	Pass
*142 (U-NII-2C)	5710	17.01	17.00	17.09	16.84	199.827	23.01	24	Pass
*142 (U-NII-3)	5710	7.96	7.70	7.45	7.36	23.144	13.64	30	Pass

Notes:

- * : Test was performed in accordance with measurement follow FCC KDB 789033 UNII test procedure Method SA-1 and use spectrum analyzer test.
- Directional gain is the maximum gain of antennas.
- For U-NII-2A, the maximum gain is 5.77 dBi < 6 dBi, so the output power limit shall not be reduced.
- For U-NII-2C, the maximum gain is 5.91 dBi < 6 dBi, so the output power limit shall not be reduced.
- For U-NII-3, the maximum gain is 5.53 dBi < 6 dBi, so the output power limit shall not be reduced.

802.11ac (VHT80) CDD

Chan.	Chan. Freq. (MHz)	Average Power (dBm)				Total Power (mW)	Total Power (dBm)	Power Limit (dBm)	Test Result
		Chain 0	Chain 1	Chain 2	Chain 3				
58	5290	17.58	17.81	17.81	17.82	238.603	23.78	24	Pass
106	5530	17.70	17.52	17.63	17.56	230.337	23.62	24	Pass
122	5610	17.82	17.92	17.54	17.93	241.32	23.83	24	Pass
*138 (U-NII-2C)	5690	16.90	17.24	17.11	17.23	206.193	23.14	24	Pass
*138 (U-NII-3)	5690	4.25	4.20	4.12	3.87	10.311	10.13	30	Pass

Notes:

- * : Test was performed in accordance with measurement follow FCC KDB 789033 UNII test procedure Method SA-1 and use spectrum analyzer test.
- Directional gain is the maximum gain of antennas.
- For U-NII-2A, the maximum gain is 5.77 dBi < 6 dBi, so the output power limit shall not be reduced.
- For U-NII-2C, the maximum gain is 5.91 dBi < 6 dBi, so the output power limit shall not be reduced.
- For U-NII-3, the maximum gain is 5.53 dBi < 6 dBi, so the output power limit shall not be reduced.

802.11ac (VHT160) CDD

Chan.	Chan. Freq. (MHz)	Average Power (dBm)				Total Power (mW)	Total Power (dBm)	Power Limit (dBm)	Test Result
		Chain 0	Chain 1	Chain 2	Chain 3				
*50 (U-NII-1)	5250	14.28	14.32	13.77	13.93	102.372	20.10	30	Pass
*50 (U-NII-2A)	5250	14.35	14.46	13.94	14.21	106.29	20.26	24	Pass
114	5570	16.31	15.98	16.14	16.13	164.519	22.16	24	Pass

Notes:

- * : Test was performed in accordance with measurement follow FCC KDB 789033 UNII test procedure Method SA-1 and use spectrum analyzer test.
- Directional gain is the maximum gain of antennas.
- For U-NII-1, the maximum gain is 5.96 dBi < 6 dBi, so the output power limit shall not be reduced.
- For U-NII-2A, the maximum gain is 5.77 dBi < 6 dBi, so the output power limit shall not be reduced.
- For U-NII-2C, the maximum gain is 5.91 dBi < 6 dBi, so the output power limit shall not be reduced.

802.11ax (HE20) CDD

Chan.	Chan. Freq. (MHz)	Average Power (dBm)				Total Power (mW)	Total Power (dBm)	Power Limit (dBm)	Test Result
		Chain 0	Chain 1	Chain 2	Chain 3				
52	5260	17.83	17.80	17.84	18.05	245.569	23.90	24	Pass
60	5300	17.68	17.92	17.57	18.03	241.239	23.82	24	Pass
64	5320	17.62	17.56	17.45	18.01	233.658	23.69	24	Pass
100	5500	17.71	17.52	17.48	17.76	231.193	23.64	24	Pass
116	5580	18.01	17.75	18.02	17.55	243.08	23.86	24	Pass
140	5700	15.86	16.04	15.89	15.84	155.913	21.93	24	Pass
*144 (U-NII-2C)	5720	16.07	15.89	16.07	16.10	160.468	22.05	23.02	Pass
*144 (U-NII-3)	5720	11.12	10.72	10.57	10.86	48.338	16.84	30	Pass

Notes:

- * : Test was performed in accordance with measurement follow FCC KDB 789033 UNII test procedure Method SA-1 and use spectrum analyzer test.
- Directional gain is the maximum gain of antennas.
- For U-NII-2A, the directional gain is 5.77 dBi < 6 dBi, so the output power limit shall not be reduced.
- For U-NII-2C, the directional gain is 5.91 dBi < 6 dBi, so the output power limit shall not be reduced.
- For U-NII-3, the directional gain is 5.53 dBi < 6 dBi, so the output power limit shall not be reduced.

802.11ax (HE40) CDD

Chan.	Chan. Freq. (MHz)	Average Power (dBm)				Total Power (mW)	Total Power (dBm)	Power Limit (dBm)	Test Result
		Chain 0	Chain 1	Chain 2	Chain 3				
54	5270	17.95	18.01	17.98	17.42	243.628	23.87	24	Pass
62	5310	17.84	17.83	17.76	17.14	232.951	23.67	24	Pass
102	5510	17.45	18.02	17.92	17.69	239.67	23.80	24	Pass
110	5550	17.54	18.01	17.89	17.58	238.793	23.78	24	Pass
134	5670	16.89	16.77	16.93	16.52	190.591	22.80	24	Pass
*142 (U-NII-2C)	5710	17.05	17.04	17.14	16.87	201.683	23.05	24	Pass
*142 (U-NII-3)	5710	8.00	7.73	7.50	7.41	23.37	13.69	30	Pass

Notes:

- * : Test was performed in accordance with measurement follow FCC KDB 789033 UNII test procedure Method SA-1 and use spectrum analyzer test.
- Directional gain is the maximum gain of antennas.
- For U-NII-2A, the maximum gain is 5.77 dBi < 6 dBi, so the output power limit shall not be reduced.
- For U-NII-2C, the maximum gain is 5.91 dBi < 6 dBi, so the output power limit shall not be reduced.
- For U-NII-3, the maximum gain is 5.53 dBi < 6 dBi, so the output power limit shall not be reduced.

802.11ax (HE80) CDD

Chan.	Chan. Freq. (MHz)	Average Power (dBm)				Total Power (mW)	Total Power (dBm)	Power Limit (dBm)	Test Result
		Chain 0	Chain 1	Chain 2	Chain 3				
58	5290	17.62	17.84	17.83	17.84	240.11	23.80	24	Pass
106	5530	17.74	17.56	17.66	17.58	232.07	23.66	24	Pass
122	5610	17.86	17.94	17.56	17.96	242.858	23.85	24	Pass
*138 (U-NII-2C)	5690	16.93	17.28	17.15	17.25	207.742	23.18	24	Pass
*138 (U-NII-3)	5690	4.29	4.22	4.15	3.90	10.383	10.16	30	Pass

Notes:

- * : Test was performed in accordance with measurement follow FCC KDB 789033 UNII test procedure Method SA-1 and use spectrum analyzer test.
- Directional gain is the maximum gain of antennas.
- For U-NII-2A, the maximum gain is 5.77 dBi < 6 dBi, so the output power limit shall not be reduced.
- For U-NII-2C, the maximum gain is 5.91 dBi < 6 dBi, so the output power limit shall not be reduced.
- For U-NII-3, the maximum gain is 5.53 dBi < 6 dBi, so the output power limit shall not be reduced.

802.11ax (HE160) CDD

Chan.	Chan. Freq. (MHz)	Average Power (dBm)				Total Power (mW)	Total Power (dBm)	Power Limit (dBm)	Test Result
		Chain 0	Chain 1	Chain 2	Chain 3				
*50 (U-NII-1)	5250	14.31	14.35	13.81	13.96	103.137	20.13	30	Pass
*50 (U-NII-2A)	5250	14.39	14.51	13.96	14.24	107.162	20.30	24	Pass
114	5570	16.34	16.01	16.17	16.15	165.565	22.19	24	Pass

Notes:

- * : Test was performed in accordance with measurement follow FCC KDB 789033 UNII test procedure Method SA-1 and use spectrum analyzer test.
- Directional gain is the maximum gain of antennas.
- For U-NII-1, the maximum gain is 5.96 dBi < 6 dBi, so the output power limit shall not be reduced.
- For U-NII-2A, the maximum gain is 5.77 dBi < 6 dBi, so the output power limit shall not be reduced.
- For U-NII-2C, the maximum gain is 5.91 dBi < 6 dBi, so the output power limit shall not be reduced.

802.11n (HT20) Beamforming

Chan.	Chan. Freq. (MHz)	Average Power (dBm)				Total Power (mW)	Total Power (dBm)	Power Limit (dBm)	Test Result
		Chain 0	Chain 1	Chain 2	Chain 3				
52	5260	17.78	17.75	17.79	18.01	242.904	23.85	23.92	Pass
60	5300	17.62	17.86	17.49	17.93	237.096	23.75	23.92	Pass
64	5320	17.58	17.52	17.40	17.96	231.245	23.64	23.92	Pass
100	5500	17.41	17.19	17.15	17.40	214.275	23.31	23.61	Pass
116	5580	17.68	17.43	17.68	17.23	225.407	23.53	23.61	Pass
140	5700	15.82	16.01	15.84	15.79	154.399	21.89	23.61	Pass
*144 (U-NII-2C)	5720	16.01	15.82	16.02	16.04	158.27	21.99	22.63	Pass
*144 (U-NII-3)	5720	11.05	10.67	10.53	10.81	47.751	16.79	29.98	Pass

Notes:

- * : Test was performed in accordance with measurement follow FCC KDB 789033 UNII test procedure Method SA-1 and use spectrum analyzer test.
- Directional gain is the measured value according to KDB 662911 D03 Method of MIMO Antenna Gain Measurement.
- For U-NII-2A, the directional gain is 6.08 dBi > 6 dBi, so the output power limit shall be reduced to [Determined Conducted Power Limit-(6.08-6)].
- For U-NII-2C, the directional gain is 6.39 dBi > 6 dBi, so the output power limit shall be reduced to [Determined Conducted Power Limit-(6.39-6)].
- For U-NII-3, the directional gain is 6.48 dBi > 6 dBi, so the output power limit shall be reduced to 30-(6.02-6) = 29.98 dBm.

802.11n (HT40) Beamforming

Chan.	Chan. Freq. (MHz)	Average Power (dBm)				Total Power (mW)	Total Power (dBm)	Power Limit (dBm)	Test Result
		Chain 0	Chain 1	Chain 2	Chain 3				
54	5270	17.83	17.90	17.84	17.35	237.472	23.76	23.92	Pass
62	5310	17.73	17.72	17.70	17.05	228.032	23.58	23.92	Pass
102	5510	17.18	17.72	17.60	17.39	223.767	23.50	23.61	Pass
110	5550	17.25	17.68	17.61	17.29	222.959	23.48	23.61	Pass
134	5670	16.80	16.71	16.84	16.45	187.207	22.72	23.61	Pass
*142 (U-NII-2C)	5710	16.96	16.97	17.05	16.80	197.995	22.97	23.61	Pass
*142 (U-NII-3)	5710	7.93	7.67	7.41	7.33	22.972	13.61	29.98	Pass

Notes:

- * : Test was performed in accordance with measurement follow FCC KDB 789033 UNII test procedure Method SA-1 and use spectrum analyzer test.
- Directional gain is the measured value according to KDB 662911 D03 Method of MIMO Antenna Gain Measurement.
- For U-NII-2A, the directional gain is 6.08 dBi > 6 dBi, so the output power limit shall be reduced to [Determined Conducted Power Limit-(6.08-6)].
- For U-NII-2C, the directional gain is 6.39 dBi > 6 dBi, so the output power limit shall be reduced to [Determined Conducted Power Limit-(6.39-6)].
- For U-NII-3, the directional gain is 6.48 dBi > 6 dBi, so the output power limit shall be reduced to 30-(6.02-6) = 29.98 dBm.

802.11ac (VHT20) Beamforming

Chan.	Chan. Freq. (MHz)	Average Power (dBm)				Total Power (mW)	Total Power (dBm)	Power Limit (dBm)	Test Result
		Chain 0	Chain 1	Chain 2	Chain 3				
52	5260	17.80	17.78	17.82	18.03	244.302	23.88	23.92	Pass
60	5300	17.66	17.89	17.55	18.01	239.989	23.80	23.92	Pass
64	5320	17.61	17.54	17.42	17.98	232.445	23.66	23.92	Pass
100	5500	17.43	17.22	17.18	17.42	215.505	23.33	23.61	Pass
116	5580	17.72	17.45	17.71	17.26	226.978	23.56	23.61	Pass
140	5700	15.83	16.02	15.86	15.82	155.019	21.90	23.61	Pass
*144 (U-NII-2C)	5720	16.03	15.85	16.04	16.07	159.183	22.02	22.63	Pass
*144 (U-NII-3)	5720	11.08	10.70	10.55	10.83	48.028	16.81	29.98	Pass

Notes:

- * : Test was performed in accordance with measurement follow FCC KDB 789033 UNII test procedure Method SA-1 and use spectrum analyzer test.
- Directional gain is the measured value according to KDB 662911 D03 Method of MIMO Antenna Gain Measurement.
- For U-NII-2A, the directional gain is 6.08 dBi > 6 dBi, so the output power limit shall be reduced to [Determined Conducted Power Limit-(6.08-6)].
- For U-NII-2C, the directional gain is 6.39 dBi > 6 dBi, so the output power limit shall be reduced to [Determined Conducted Power Limit-(6.39-6)].
- For U-NII-3, the directional gain is 6.48 dBi > 6 dBi, so the output power limit shall be reduced to 30-(6.02-6) = 29.98 dBm.

802.11ac (VHT40) Beamforming

Chan.	Chan. Freq. (MHz)	Average Power (dBm)				Total Power (mW)	Total Power (dBm)	Power Limit (dBm)	Test Result
		Chain 0	Chain 1	Chain 2	Chain 3				
54	5270	17.91	17.95	17.94	17.40	241.359	23.83	23.92	Pass
62	5310	17.80	17.78	17.72	17.11	230.796	23.63	23.92	Pass
102	5510	17.20	17.75	17.62	17.43	225.192	23.53	23.61	Pass
110	5550	17.29	17.72	17.64	17.31	224.639	23.51	23.61	Pass
134	5670	16.83	16.74	16.90	16.49	188.945	22.76	23.61	Pass
*142 (U-NII-2C)	5710	17.01	17.00	17.09	16.84	199.827	23.01	23.61	Pass
*142 (U-NII-3)	5710	7.96	7.70	7.45	7.36	23.144	13.64	29.98	Pass

Notes:

- * : Test was performed in accordance with measurement follow FCC KDB 789033 UNII test procedure Method SA-1 and use spectrum analyzer test.
- Directional gain is the measured value according to KDB 662911 D03 Method of MIMO Antenna Gain Measurement.
- For U-NII-2A, the directional gain is 6.08 dBi > 6 dBi, so the output power limit shall be reduced to [Determined Conducted Power Limit-(6.08-6)].
- For U-NII-2C, the directional gain is 6.39 dBi > 6 dBi, so the output power limit shall be reduced to [Determined Conducted Power Limit-(6.39-6)].
- For U-NII-3, the directional gain is 6.48 dBi > 6 dBi, so the output power limit shall be reduced to 30-(6.02-6) = 29.98 dBm.

802.11ac (VHT80) Beamforming

Chan.	Chan. Freq. (MHz)	Average Power (dBm)				Total Power (mW)	Total Power (dBm)	Power Limit (dBm)	Test Result
		Chain 0	Chain 1	Chain 2	Chain 3				
58	5290	17.58	17.81	17.81	17.82	238.603	23.78	23.92	Pass
106	5530	17.48	17.30	17.40	17.31	218.46	23.39	23.61	Pass
122	5610	17.56	17.64	17.26	17.66	226.648	23.55	23.61	Pass
*138 (U-NII-2C)	5690	16.90	17.24	17.11	17.23	206.193	23.14	23.61	Pass
*138 (U-NII-3)	5690	4.25	4.20	4.12	3.87	10.311	10.13	29.98	Pass

Notes:

- * : Test was performed in accordance with measurement follow FCC KDB 789033 UNII test procedure Method SA-1 and use spectrum analyzer test.
- Directional gain is the measured value according to KDB 662911 D03 Method of MIMO Antenna Gain Measurement.
- For U-NII-2A, the directional gain is 6.08 dBi > 6 dBi, so the output power limit shall be reduced to [Determined Conducted Power Limit-(6.08-6)].
- For U-NII-2C, the directional gain is 6.39 dBi > 6 dBi, so the output power limit shall be reduced to [Determined Conducted Power Limit-(6.39-6)].
- For U-NII-3, the directional gain is 6.48 dBi > 6 dBi, so the output power limit shall be reduced to 30-(6.02-6) = 29.98 dBm.

802.11ac (VHT160) Beamforming

Chan.	Chan. Freq. (MHz)	Average Power (dBm)				Total Power (mW)	Total Power (dBm)	Power Limit (dBm)	Test Result
		Chain 0	Chain 1	Chain 2	Chain 3				
*50 (U-NII-1)	5250	14.28	14.32	13.77	13.93	102.372	20.10	30	Pass
*50 (U-NII-2A)	5250	14.35	14.46	13.94	14.21	106.29	20.26	23.92	Pass
114	5570	16.31	15.98	16.14	16.13	164.519	22.16	23.61	Pass

Notes:

- * : Test was performed in accordance with measurement follow FCC KDB 789033 UNII test procedure Method SA-1 and use spectrum analyzer test.
- Directional gain is the measured value according to KDB 662911 D03 Method of MIMO Antenna Gain Measurement.
- For U-NII-1, the directional gain is 5.96 dBi < 6 dBi, so the output power limit shall not be reduced.
- For U-NII-2A, the directional gain is 6.08 dBi > 6 dBi, so the output power limit shall be reduced to [Determined Conducted Power Limit-(6.08-6)].
- For U-NII-2C, the directional gain is 6.39 dBi > 6 dBi, so the output power limit shall be reduced to [Determined Conducted Power Limit-(6.39-6)].

802.11ax (HE20) Beamforming

Chan.	Chan. Freq. (MHz)	Average Power (dBm)				Total Power (mW)	Total Power (dBm)	Power Limit (dBm)	Test Result
		Chain 0	Chain 1	Chain 2	Chain 3				
52	5260	17.83	17.80	17.84	18.05	245.569	23.90	23.92	Pass
60	5300	17.68	17.92	17.57	18.03	241.239	23.82	23.92	Pass
64	5320	17.62	17.56	17.45	18.01	233.658	23.69	23.92	Pass
100	5500	17.47	17.24	17.21	17.48	217.391	23.37	23.61	Pass
116	5580	17.74	17.48	17.75	17.29	228.551	23.59	23.61	Pass
140	5700	15.86	16.04	15.89	15.84	155.913	21.93	23.61	Pass
*144 (U-NII-2C)	5720	16.07	15.89	16.07	16.10	160.468	22.05	22.63	Pass
*144 (U-NII-3)	5720	11.12	10.72	10.57	10.86	48.338	16.84	29.98	Pass

Notes:

- * : Test was performed in accordance with measurement follow FCC KDB 789033 UNII test procedure Method SA-1 and use spectrum analyzer test.
- Directional gain is the measured value according to KDB 662911 D03 Method of MIMO Antenna Gain Measurement.
- For U-NII-2A, the directional gain is 6.08 dBi > 6 dBi, so the output power limit shall be reduced to [Determined Conducted Power Limit-(6.08-6)].
- For U-NII-2C, the directional gain is 6.39 dBi > 6 dBi, so the output power limit shall be reduced to [Determined Conducted Power Limit-(6.39-6)].
- For U-NII-3, the directional gain is 6.48 dBi > 6 dBi, so the output power limit shall be reduced to 30-(6.02-6) = 29.98 dBm.

802.11ax (HE40) Beamforming

Chan.	Chan. Freq. (MHz)	Average Power (dBm)				Total Power (mW)	Total Power (dBm)	Power Limit (dBm)	Test Result
		Chain 0	Chain 1	Chain 2	Chain 3				
54	5270	17.95	18.01	17.98	17.42	243.628	23.87	23.92	Pass
62	5310	17.84	17.83	17.76	17.14	232.951	23.67	23.92	Pass
102	5510	17.22	17.78	17.66	17.47	226.894	23.56	23.61	Pass
110	5550	17.32	17.75	17.67	17.34	226.196	23.54	23.61	Pass
134	5670	16.89	16.77	16.93	16.52	190.591	22.80	23.61	Pass
*142 (U-NII-2C)	5710	17.05	17.04	17.14	16.87	201.683	23.05	23.61	Pass
*142 (U-NII-3)	5710	8.00	7.73	7.50	7.41	23.37	13.69	29.98	Pass

Notes:

- * : Test was performed in accordance with measurement follow FCC KDB 789033 UNII test procedure Method SA-1 and use spectrum analyzer test.
- Directional gain is the measured value according to KDB 662911 D03 Method of MIMO Antenna Gain Measurement.
- For U-NII-2A, the directional gain is 6.08 dBi > 6 dBi, so the output power limit shall be reduced to [Determined Conducted Power Limit-(6.08-6)].
- For U-NII-2C, the directional gain is 6.39 dBi > 6 dBi, so the output power limit shall be reduced to [Determined Conducted Power Limit-(6.39-6)].
- For U-NII-3, the directional gain is 6.48 dBi > 6 dBi, so the output power limit shall be reduced to 30-(6.02-6) = 29.98 dBm.

802.11ax (HE80) Beamforming

Chan.	Chan. Freq. (MHz)	Average Power (dBm)				Total Power (mW)	Total Power (dBm)	Power Limit (dBm)	Test Result
		Chain 0	Chain 1	Chain 2	Chain 3				
58	5290	17.62	17.84	17.83	17.84	240.11	23.80	23.92	Pass
106	5530	17.51	17.33	17.42	17.35	219.972	23.42	23.61	Pass
122	5610	17.60	17.66	17.30	17.69	228.341	23.59	23.61	Pass
*138 (U-NII-2C)	5690	16.93	17.28	17.15	17.25	207.742	23.18	23.61	Pass
*138 (U-NII-3)	5690	4.29	4.22	4.15	3.90	10.383	10.16	29.98	Pass

Notes:

- * : Test was performed in accordance with measurement follow FCC KDB 789033 UNII test procedure Method SA-1 and use spectrum analyzer test.
- Directional gain is the measured value according to KDB 662911 D03 Method of MIMO Antenna Gain Measurement.
- For U-NII-2A, the directional gain is 6.08 dBi > 6 dBi, so the output power limit shall be reduced to [Determined Conducted Power Limit-(6.08-6)].
- For U-NII-2C, the directional gain is 6.39 dBi > 6 dBi, so the output power limit shall be reduced to [Determined Conducted Power Limit-(6.39-6)].
- For U-NII-3, the directional gain is 6.48 dBi > 6 dBi, so the output power limit shall be reduced to 30-(6.02-6) = 29.98 dBm.

802.11ax (HE160) Beamforming

Chan.	Chan. Freq. (MHz)	Average Power (dBm)				Total Power (mW)	Total Power (dBm)	Power Limit (dBm)	Test Result
		Chain 0	Chain 1	Chain 2	Chain 3				
*50 (U-NII-1)	5250	14.31	14.35	13.81	13.96	103.137	20.13	30	Pass
*50 (U-NII-2A)	5250	14.39	14.51	13.96	14.24	107.162	20.30	23.92	Pass
114	5570	16.34	16.01	16.17	16.15	165.565	22.19	23.61	Pass

Notes:

- * : Test was performed in accordance with measurement follow FCC KDB 789033 UNII test procedure Method SA-1 and use spectrum analyzer test.
- Directional gain is the measured value according to KDB 662911 D03 Method of MIMO Antenna Gain Measurement.
- For U-NII-1, the directional gain is 5.96 dBi < 6 dBi, so the output power limit shall not be reduced.
- For U-NII-2A, the directional gain is 6.08 dBi > 6 dBi, so the output power limit shall be reduced to [Determined Conducted Power Limit-(6.08-6)].
- For U-NII-2C, the directional gain is 6.39 dBi > 6 dBi, so the output power limit shall be reduced to [Determined Conducted Power Limit-(6.39-6)].



Spectrum Plot for channel straddling

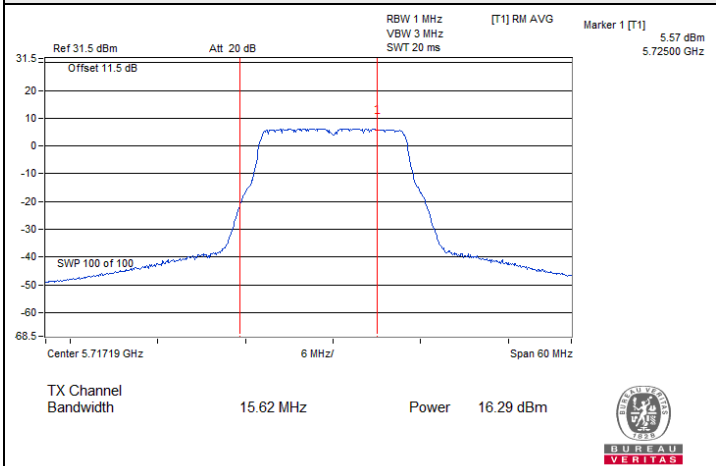

802.11a / Chain 0 : CH 144 (U-NII-2C)

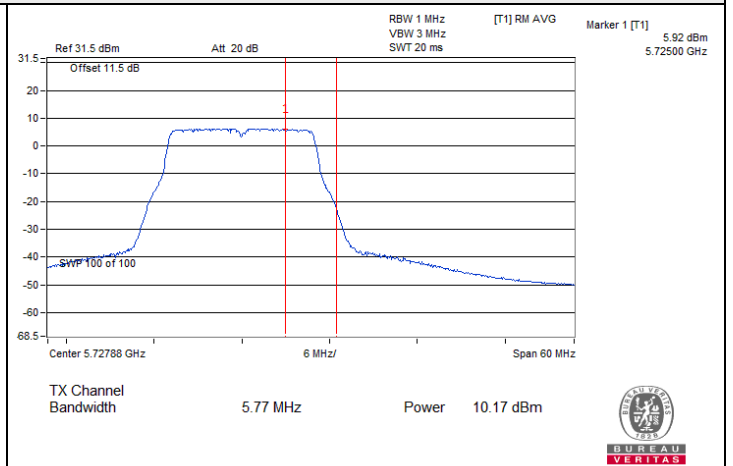

802.11a / Chain 0 : CH 144 (U-NII-3)

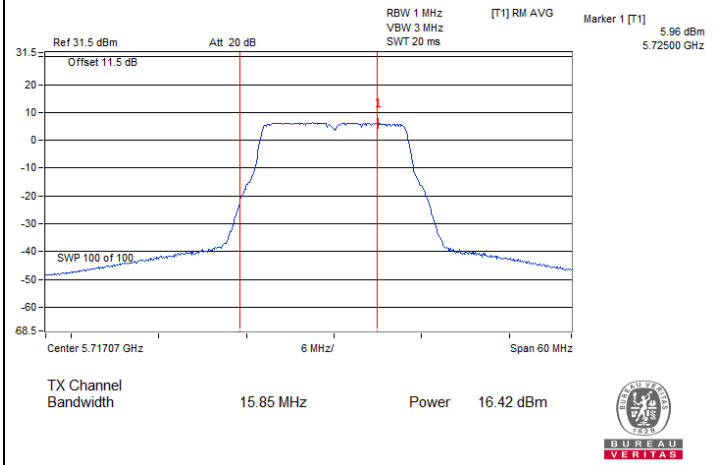

802.11a / Chain 1 : CH 144 (U-NII-2C)

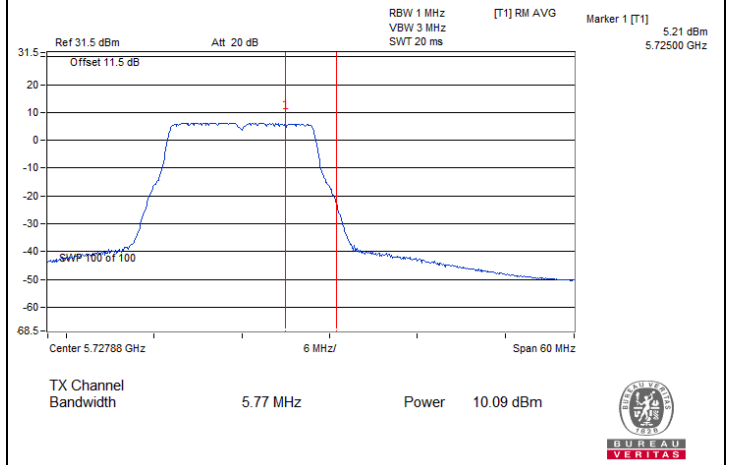

802.11a / Chain 1 : CH 144 (U-NII-3)

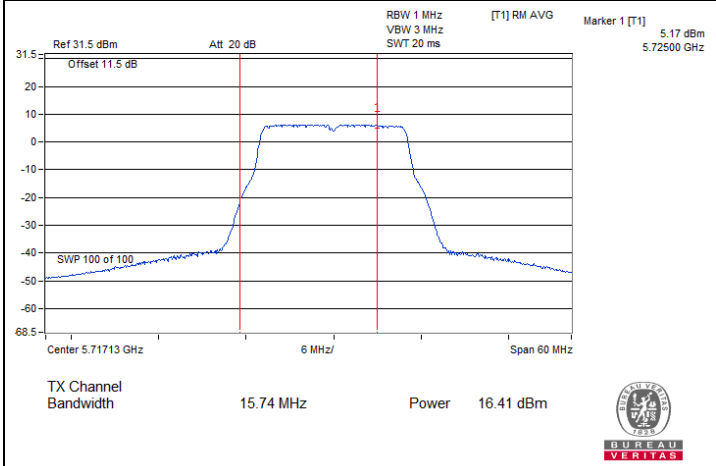

802.11a / Chain 2 : CH 144 (U-NII-2C)

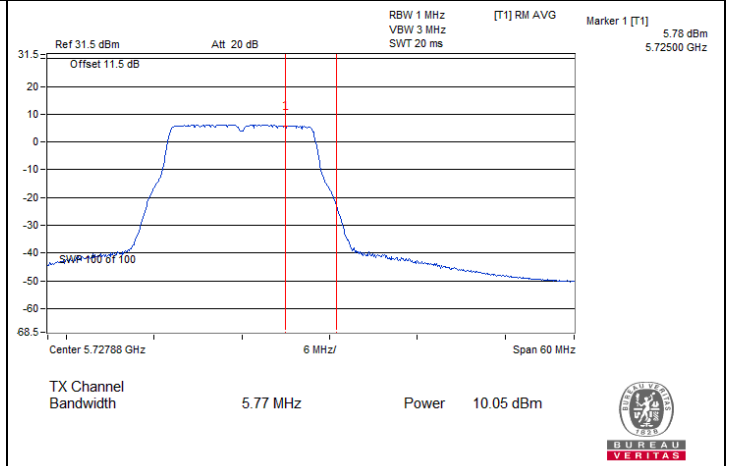

802.11a / Chain 2 : CH 144 (U-NII-3)



Spectrum Plot for channel straddling

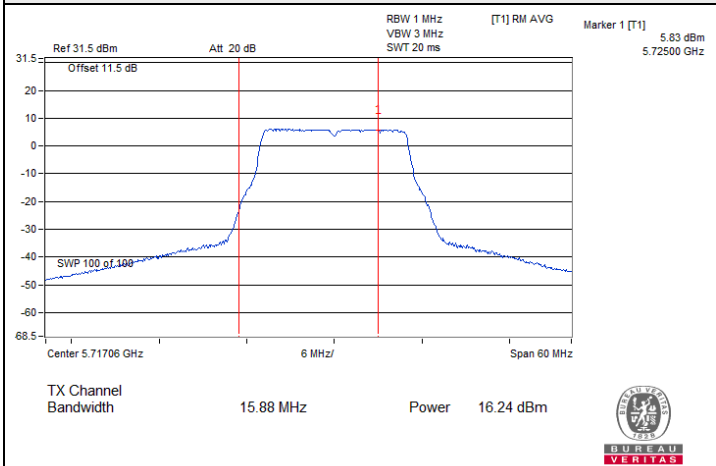

802.11a / Chain 3 : CH 144 (U-NII-2C)

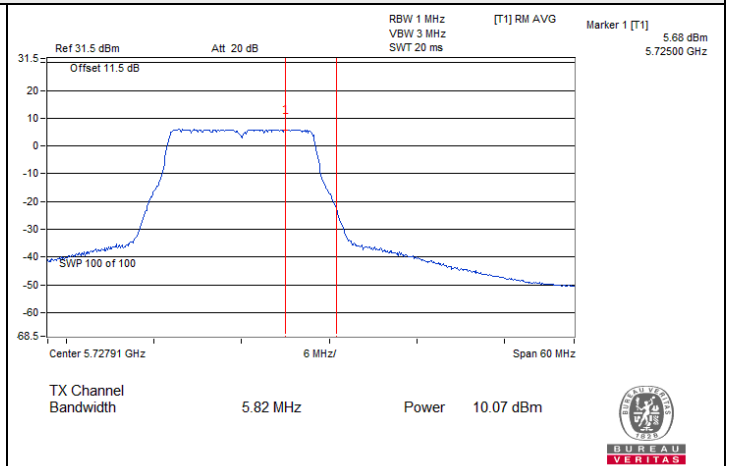

802.11a / Chain 3 : CH 144 (U-NII-3)

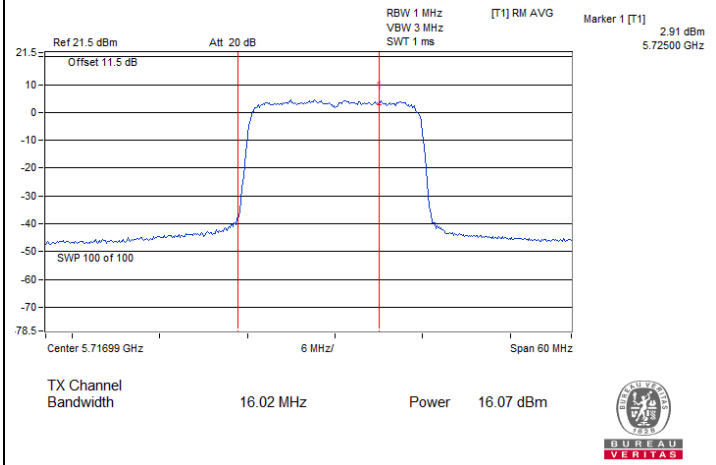

802.11ax (HE20) / Chain 0 : CH 144 (U-NII-2C)

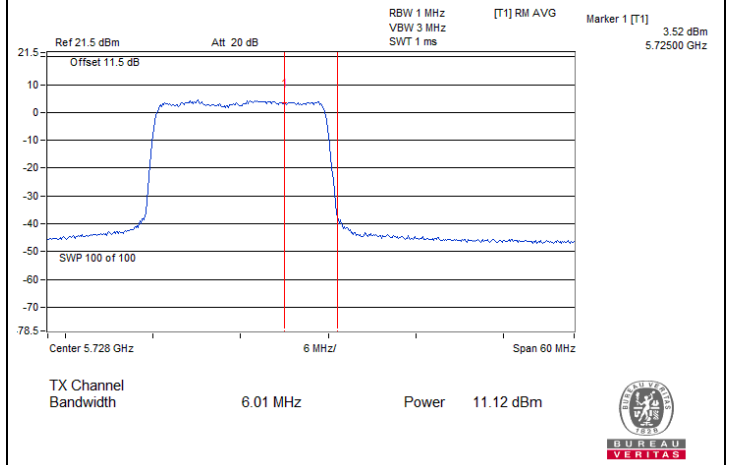

802.11ax (HE20) / Chain 0 : CH 144 (U-NII-3)

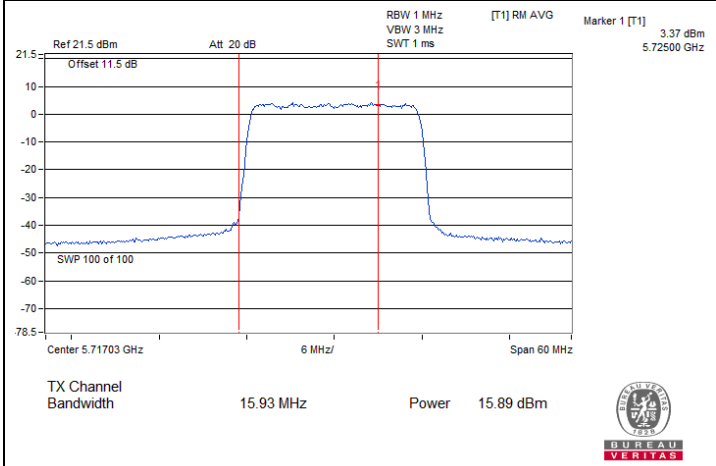

802.11ax (HE20) / Chain 1 : CH 144 (U-NII-2C)

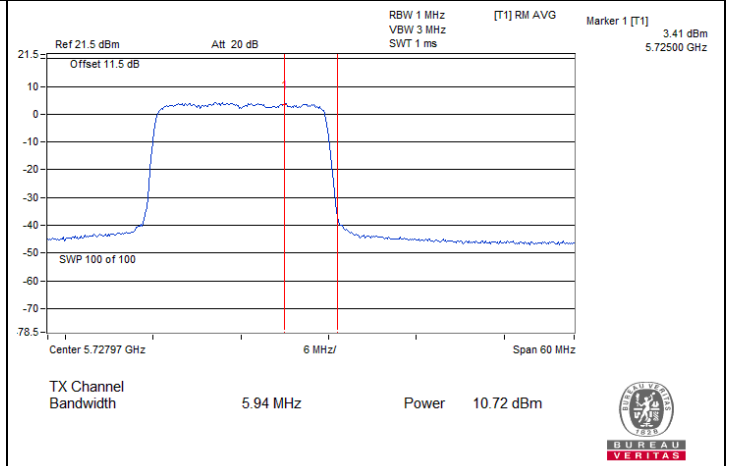

802.11ax (HE20) / Chain 1 : CH 144 (U-NII-3)



Spectrum Plot for channel straddling

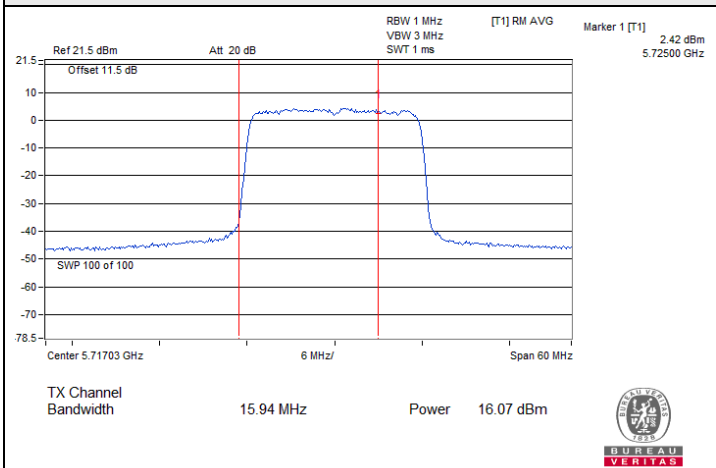

802.11ax (HE20) / Chain 2 : CH 144 (U-NII-2C)

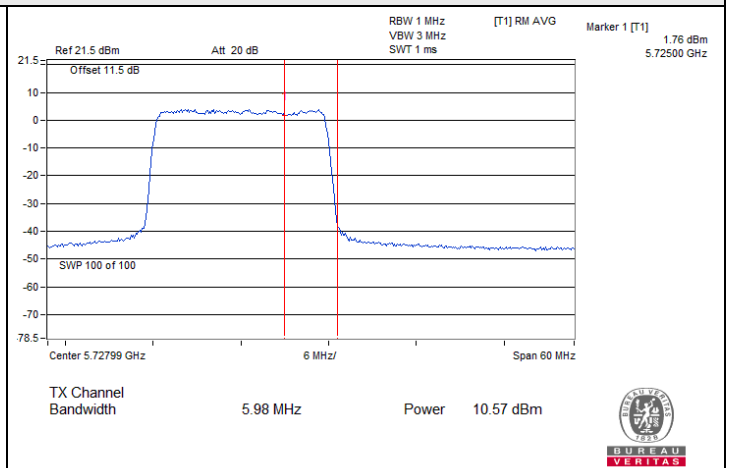

802.11ax (HE20) / Chain 2 : CH 144 (U-NII-3)

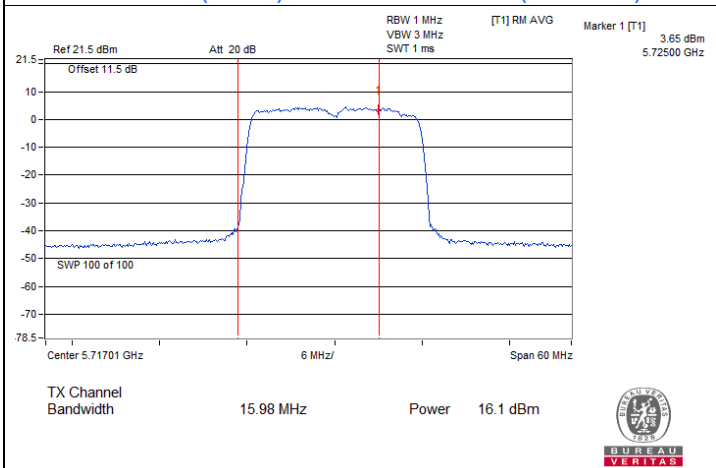

802.11ax (HE20) / Chain 3 : CH 144 (U-NII-2C)

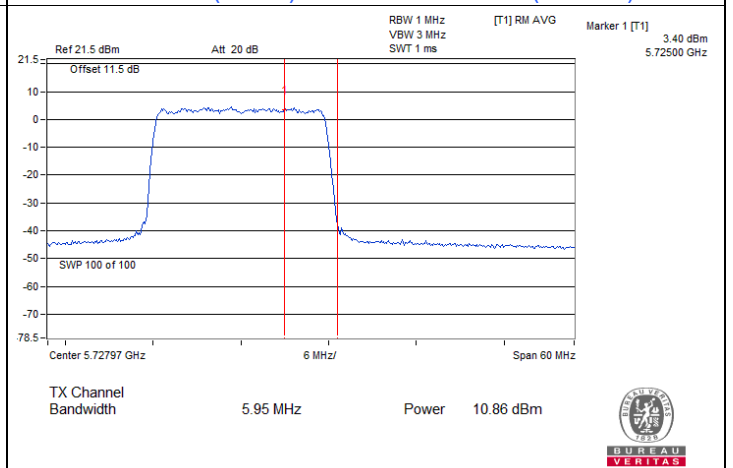

802.11ax (HE20) / Chain 3 : CH 144 (U-NII-3)

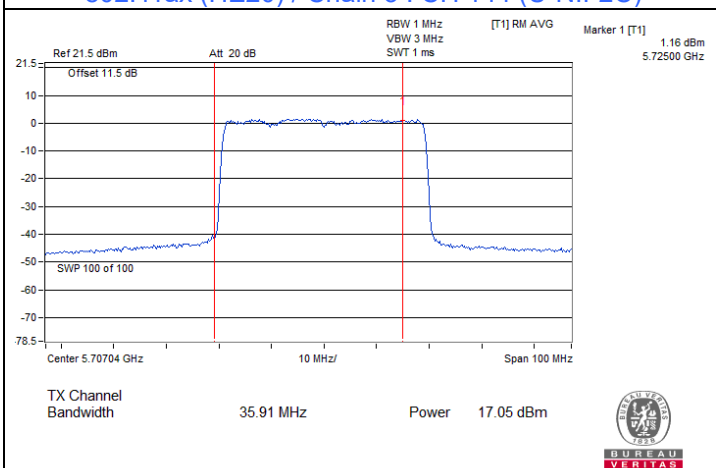

802.11ax (HE40) / Chain 0 : CH 142 (U-NII-2C)

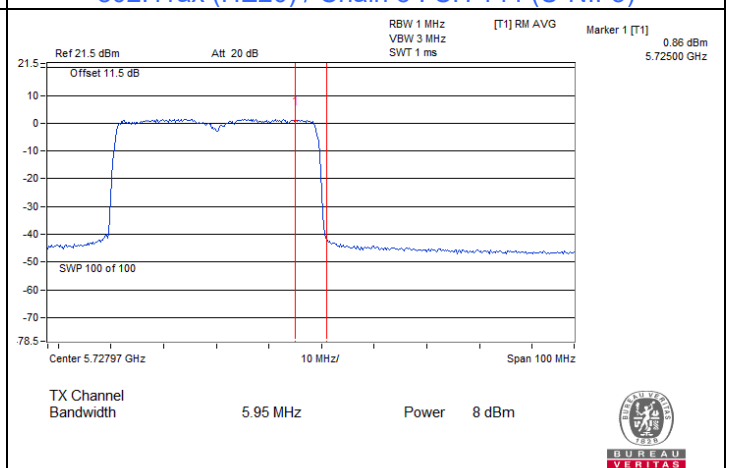

802.11ax (HE40) / Chain 0 : CH 142 (U-NII-3)



Spectrum Plot for channel straddling

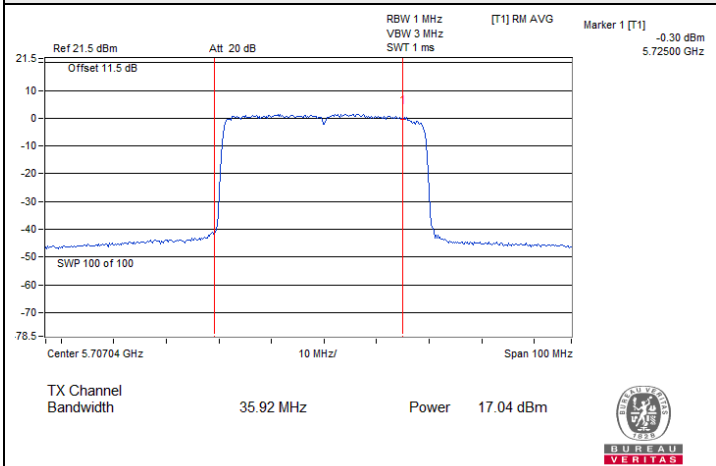

802.11ax (HE40) / Chain 1 : CH 142 (U-NII-2C)

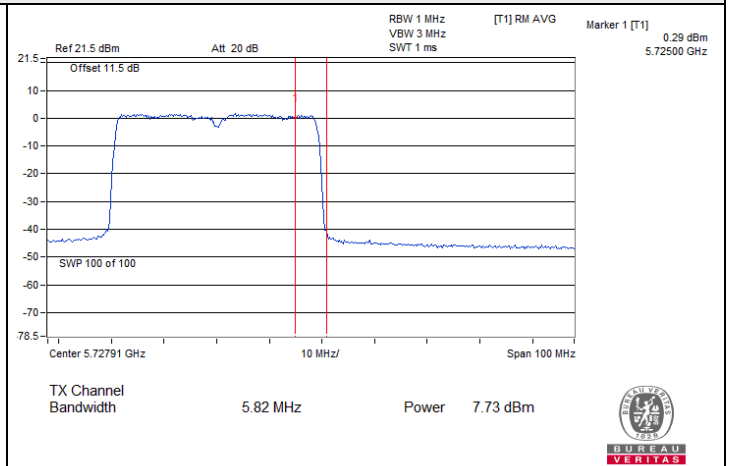

802.11ax (HE40) / Chain 1 : CH 142 (U-NII-3)

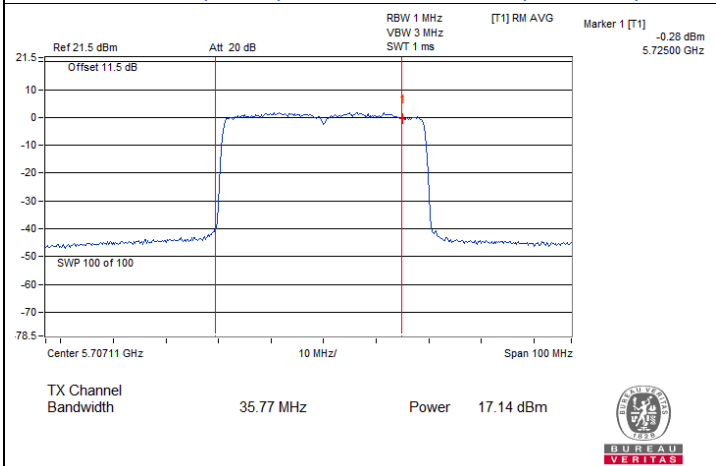

802.11ax (HE40) / Chain 2 : CH 142 (U-NII-2C)

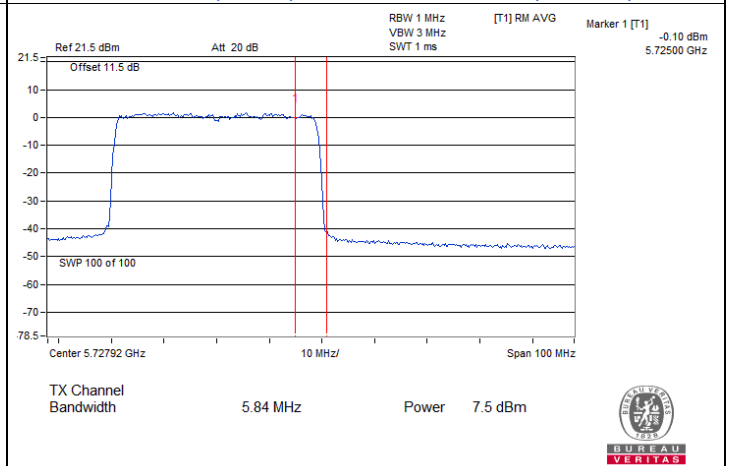

802.11ax (HE40) / Chain 2 : CH 142 (U-NII-3)

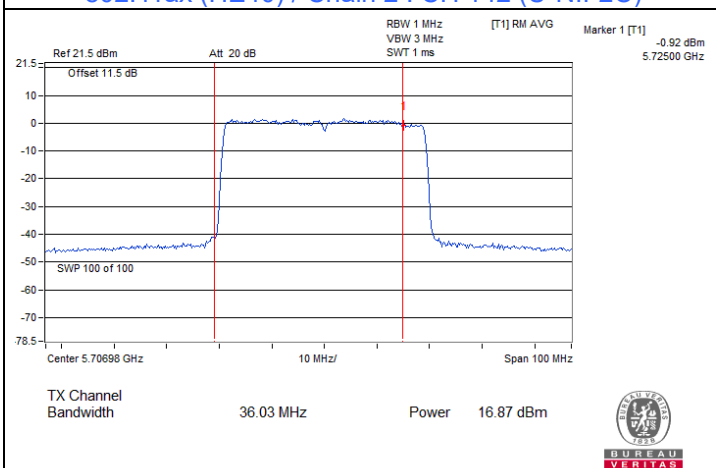

802.11ax (HE40) / Chain 3 : CH 142 (U-NII-2C)

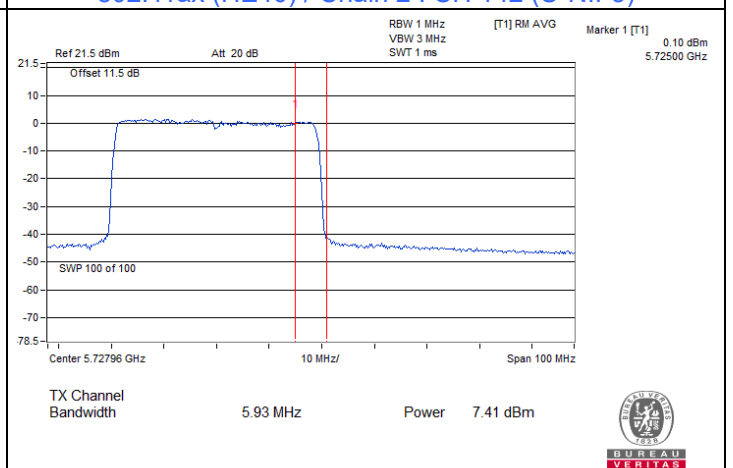

802.11ax (HE40) / Chain 3 : CH 142 (U-NII-3)



Spectrum Plot for channel straddling

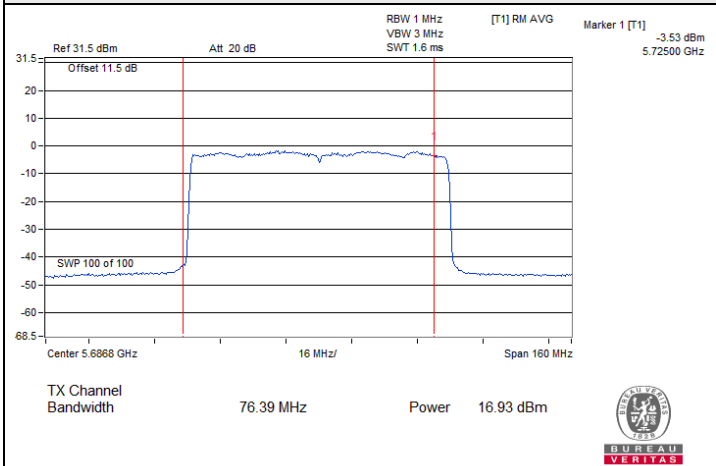

802.11ax (HE80) / Chain 0 : CH 138 (U-NII-2C)

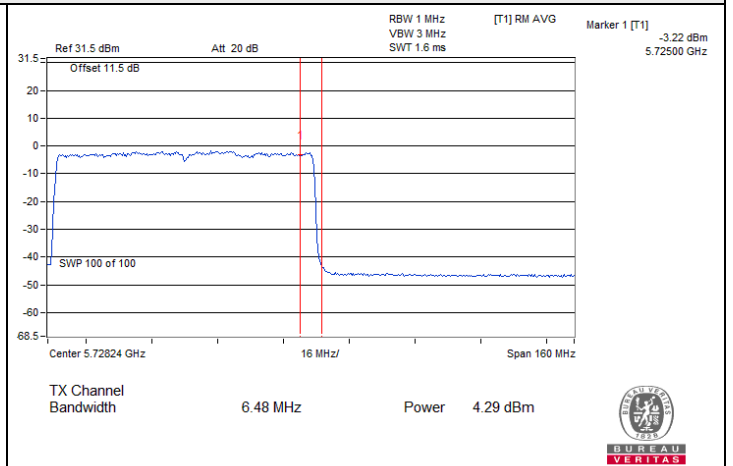

802.11ax (HE80) / Chain 0 : CH 138 (U-NII-3)

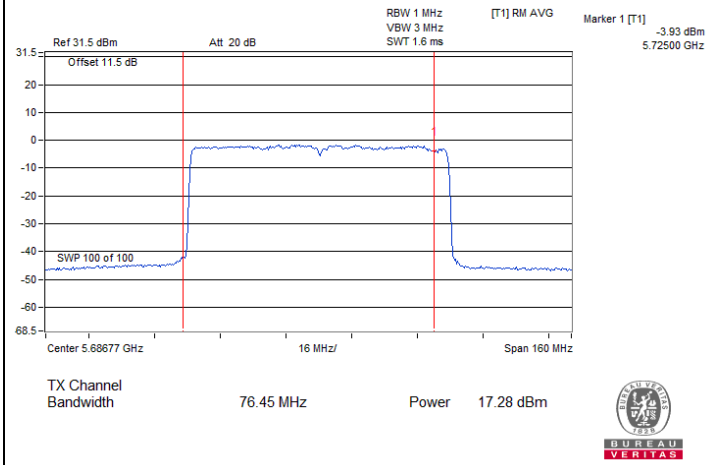

802.11ax (HE80) / Chain 1 : CH 138 (U-NII-2C)

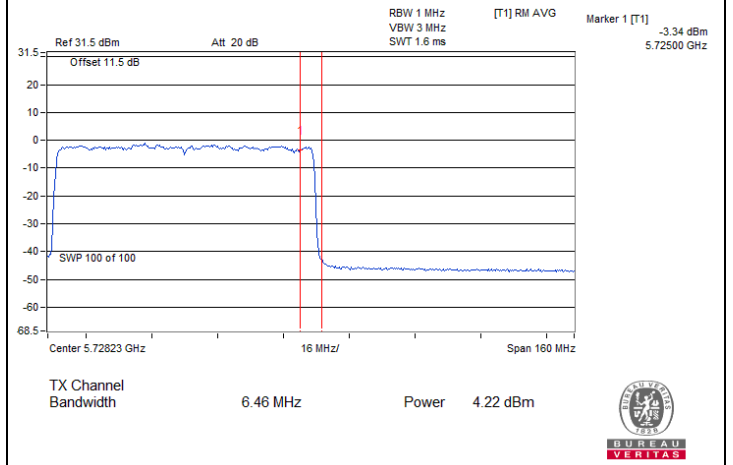

802.11ax (HE80) / Chain 1 : CH 138 (U-NII-3)

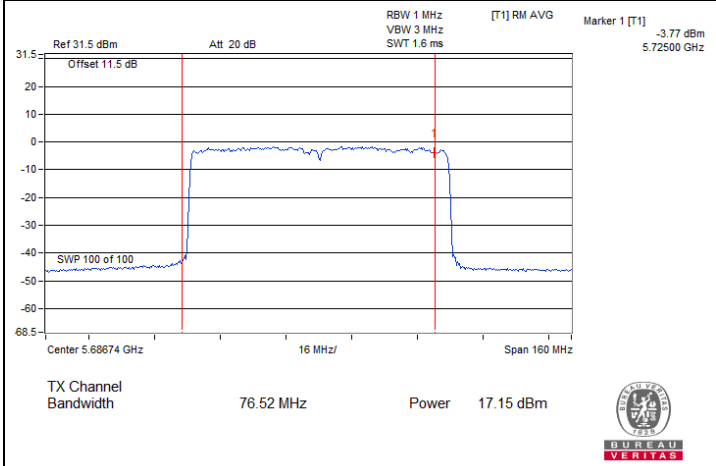

802.11ax (HE80) / Chain 2 : CH 138 (U-NII-2C)

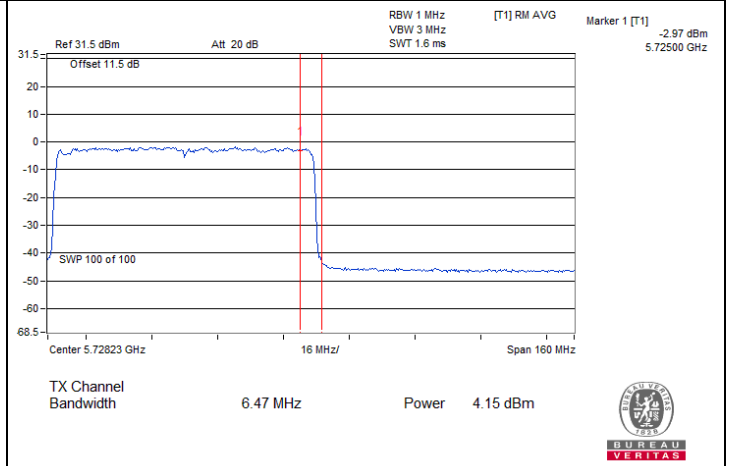

802.11ax (HE80) / Chain 2 : CH 138 (U-NII-3)



Spectrum Plot for channel straddling

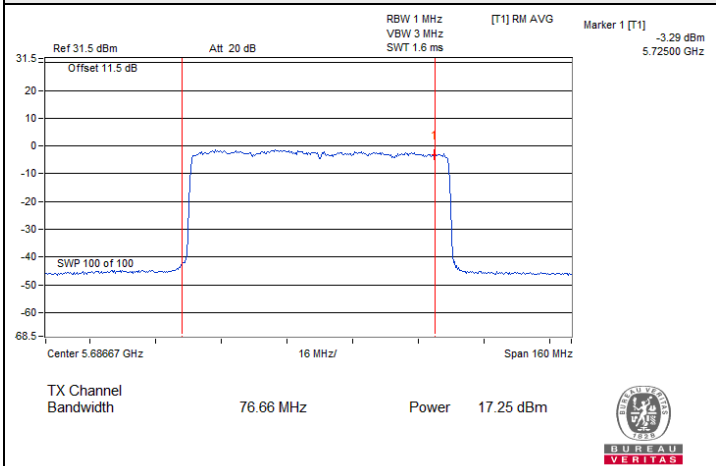

802.11ax (HE80) / Chain 3 : CH 138 (U-NII-2C)

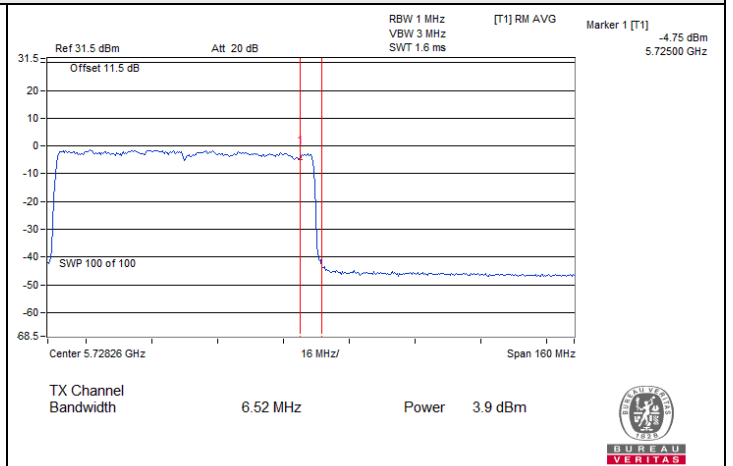

802.11ax (HE80) / Chain 3 : CH 138 (U-NII-3)

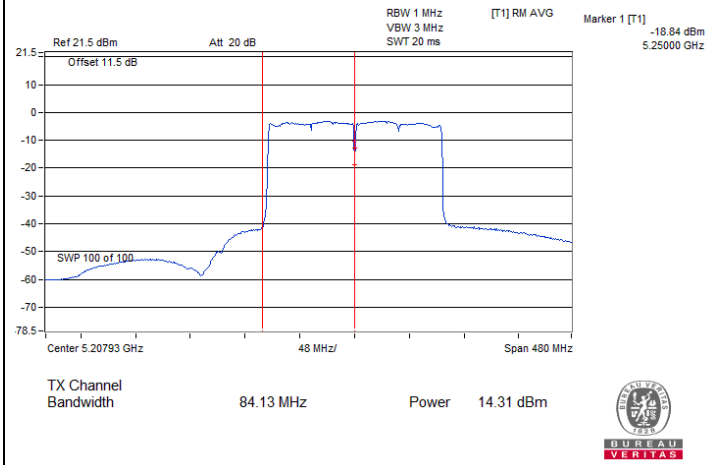

802.11ax (HE160) / Chain 0 : CH 50 (U-NII-1)

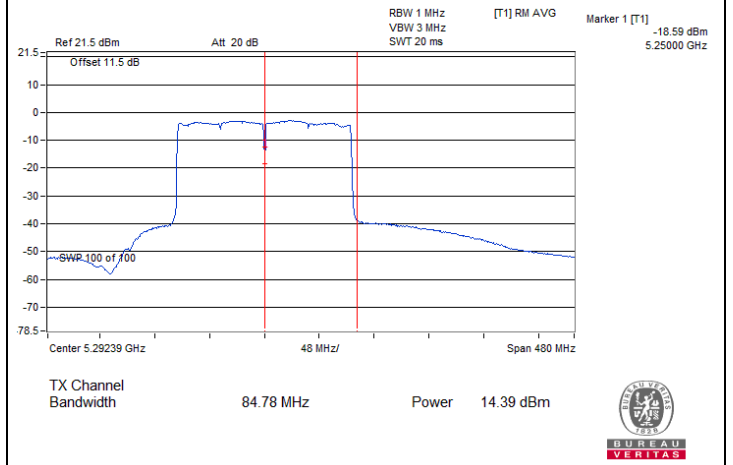

802.11ax (HE160) / Chain 0 : CH 50 (U-NII-2A)

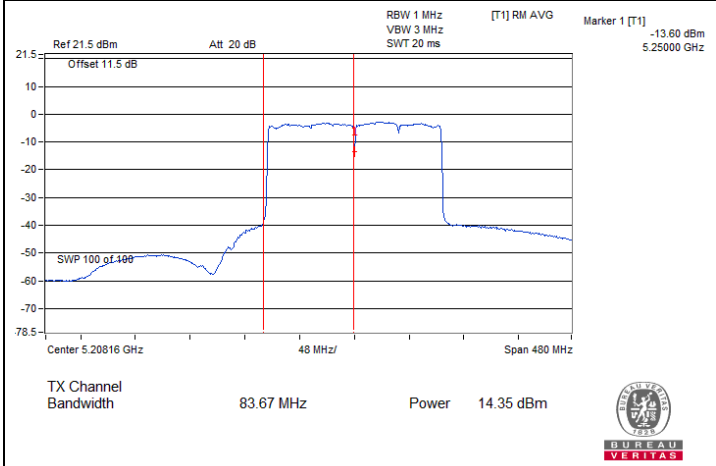

802.11ax (HE160) / Chain 1 : CH 50 (U-NII-1)

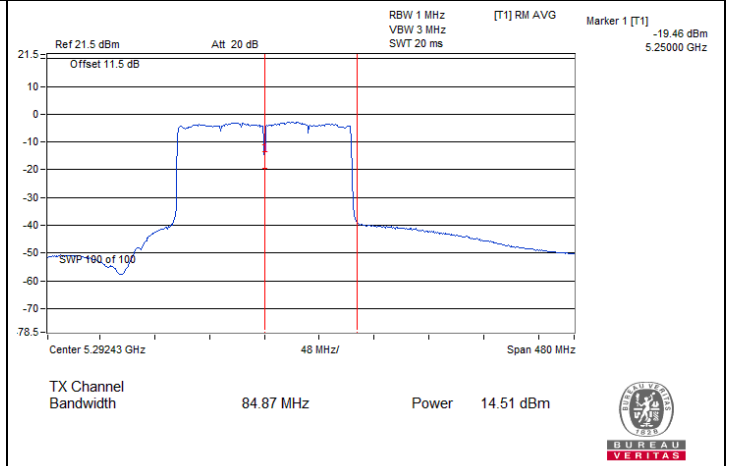

802.11ax (HE160) / Chain 1 : CH 50 (U-NII-2A)



Spectrum Plot for channel straddling

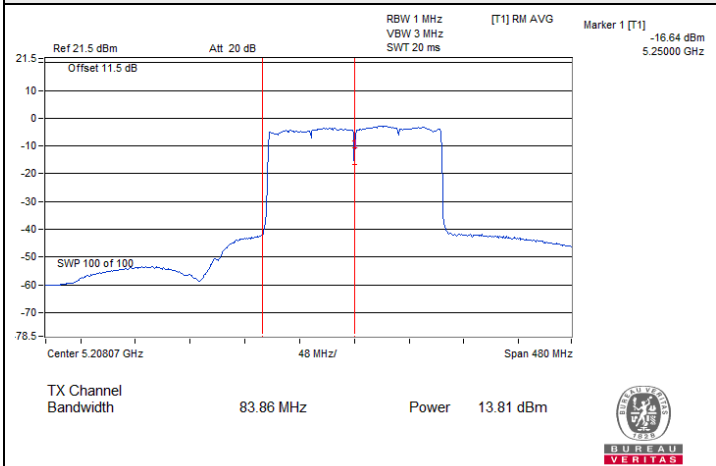

802.11ax (HE160) / Chain 2 : CH 50 (U-NII-1)

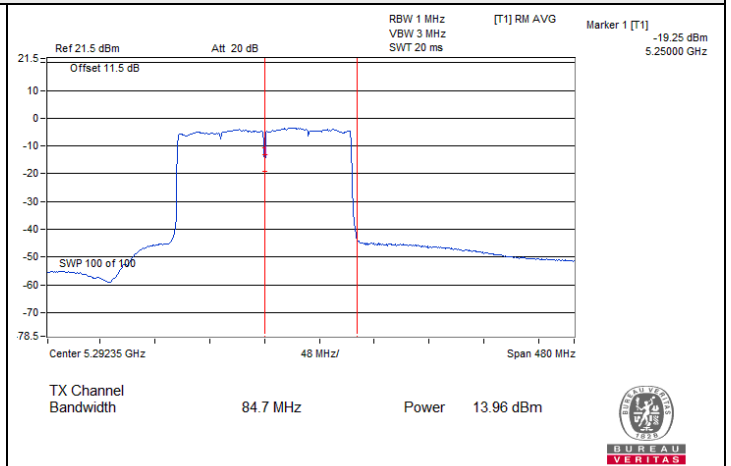

802.11ax (HE160) / Chain 2 : CH 50 (U-NII-2A)

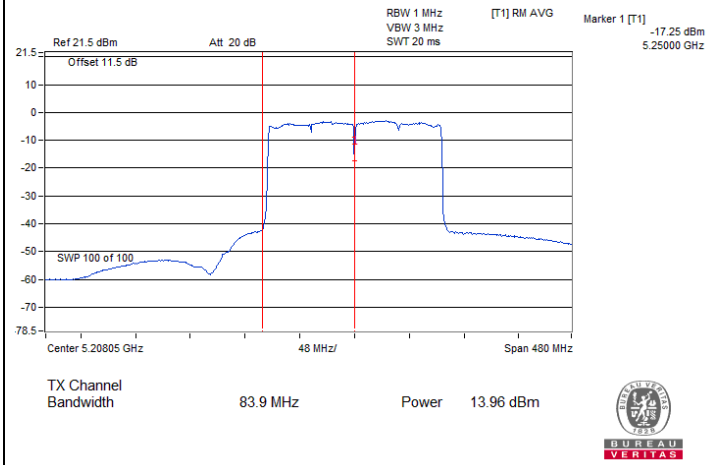

802.11ax (HE160) / Chain 3 : CH 50 (U-NII-1)

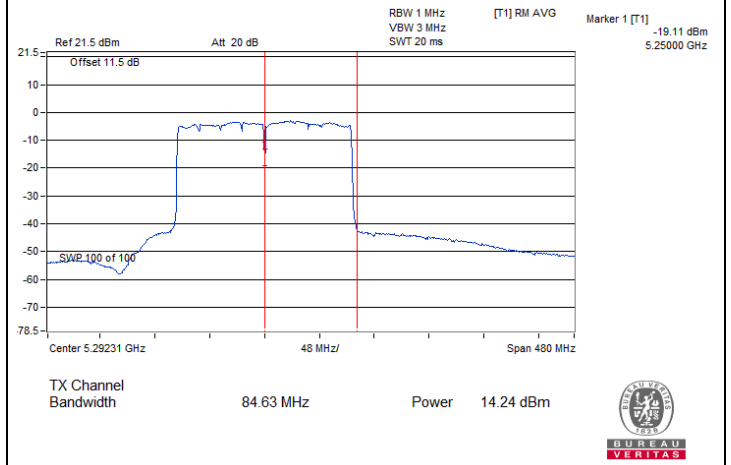

802.11ax (HE160) / Chain 3 : CH 50 (U-NII-2A)

7.3 Power Spectral Density

Input Power:	120 Vac, 60 Hz	Environmental Conditions:	25°C, 60% RH	Tested By:	Gary Lin / Wayne Lin
--------------	----------------	---------------------------	--------------	------------	----------------------

802.11a

Chan.	Chan. Freq. (MHz)	PSD (dBm/MHz)				Total PSD (dBm/MHz)	Max. PSD Limit (dBm/MHz)	Test Result
		Chain 0	Chain 1	Chain 2	Chain 3			
52	5260	3.72	4.09	3.69	4.01	9.90	10.92	Pass
60	5300	3.56	3.89	3.69	4.04	9.82	10.92	Pass
64	5320	3.76	3.92	3.59	4.06	9.86	10.92	Pass
100	5500	3.61	3.82	3.71	4.12	9.84	10.61	Pass
116	5580	4.16	4.02	3.95	3.91	10.03	10.61	Pass
140	5700	3.80	3.82	3.76	3.69	9.79	10.61	Pass
144 (U-NII-2C)	5720	3.86	3.81	3.87	3.76	9.85	10.61	Pass

Notes:

- Method E) 2) a) of power density measurement of KDB 662911 is using for calculating total power density. Total power density is summing entire spectra across corresponding frequency bins on the various outputs by computer.
- Directional gain is the measured value according to KDB 662911 D03 Method of MIMO Antenna Gain Measurement.
- For U-NII-2A, the directional gain is 6.08 dBi > 6 dBi, so the power density limit shall be reduced to 11-(6.08-6) = 10.92 dBm/MHz.
- For U-NII-2C, the directional gain is 6.39 dBi > 6 dBi, so the power density limit shall be reduced to 11-(6.39-6) = 10.61 dBm/MHz.

802.11ax (HE20)

Chan.	Chan. Freq. (MHz)	PSD (dBm/MHz)				Total PSD (dBm/MHz)	Max. PSD Limit (dBm/MHz)	Test Result
		Chain 0	Chain 1	Chain 2	Chain 3			
52	5260	4.13	3.87	3.93	4.31	10.08	10.92	Pass
60	5300	3.96	4.17	3.65	4.15	10.01	10.92	Pass
64	5320	3.77	3.64	3.55	4.23	9.83	10.92	Pass
100	5500	3.89	3.68	3.65	3.96	9.82	10.61	Pass
116	5580	4.19	3.94	4.23	3.70	10.04	10.61	Pass
140	5700	1.94	2.30	2.03	1.98	8.09	10.61	Pass
144 (U-NII-2C)	5720	3.84	3.52	3.75	3.75	9.74	10.61	Pass

Notes:

- Method E) 2) a) of power density measurement of KDB 662911 is using for calculating total power density. Total power density is summing entire spectra across corresponding frequency bins on the various outputs by computer.
- Directional gain is the measured value according to KDB 662911 D03 Method of MIMO Antenna Gain Measurement.
- For U-NII-2A, the directional gain is 6.08 dBi > 6 dBi, so the power density limit shall be reduced to 11-(6.08-6) = 10.92 dBm/MHz.
- For U-NII-2C, the directional gain is 6.39 dBi > 6 dBi, so the power density limit shall be reduced to 11-(6.39-6) = 10.61 dBm/MHz.

802.11ax (HE40)

Chan.	Chan. Freq. (MHz)	PSD (dBm/MHz)				Total PSD (dBm/MHz)	Max. PSD Limit (dBm/MHz)	Test Result
		Chain 0	Chain 1	Chain 2	Chain 3			
54	5270	1.17	1.27	1.08	0.49	7.03	10.92	Pass
62	5310	0.99	1.00	0.94	0.29	6.84	10.92	Pass
102	5510	0.65	1.24	1.12	0.86	6.99	10.61	Pass
110	5550	0.79	1.20	1.05	0.85	7.00	10.61	Pass
134	5670	-0.01	0.03	0.15	-0.26	6.00	10.61	Pass
142 (U-NII-2C)	5710	1.09	1.11	1.19	1.05	7.13	10.61	Pass

Notes:

1. Method E) 2) a) of power density measurement of KDB 662911 is using for calculating total power density. Total power density is summing entire spectra across corresponding frequency bins on the various outputs by computer.
2. Directional gain is the measured value according to KDB 662911 D03 Method of MIMO Antenna Gain Measurement.
3. For U-NII-2A, the directional gain is 6.08 dBi > 6 dBi, so the power density limit shall be reduced to $11-(6.08-6) = 10.92$ dBm/MHz.
4. For U-NII-2C, the directional gain is 6.39 dBi > 6 dBi, so the power density limit shall be reduced to $11-(6.39-6) = 10.61$ dBm/MHz.

802.11ax (HE80)

Chan.	Chan. Freq. (MHz)	PSD (dBm/MHz)				Total PSD (dBm/MHz)	Max. PSD Limit (dBm/MHz)	Test Result
		Chain 0	Chain 1	Chain 2	Chain 3			
58	5290	-2.13	-1.94	-1.95	-2.06	4.00	10.92	Pass
106	5530	-2.12	-2.24	-2.08	-2.20	3.86	10.61	Pass
122	5610	-1.93	-1.81	-2.25	-1.83	4.07	10.61	Pass
138 (U-NII-2C)	5690	-2.38	-2.10	-2.06	-1.92	3.91	10.61	Pass

Notes:

1. Method E) 2) a) of power density measurement of KDB 662911 is using for calculating total power density. Total power density is summing entire spectra across corresponding frequency bins on the various outputs by computer.
2. Directional gain is the measured value according to KDB 662911 D03 Method of MIMO Antenna Gain Measurement.
3. For U-NII-2A, the directional gain is 6.08 dBi > 6 dBi, so the power density limit shall be reduced to $11-(6.08-6) = 10.92$ dBm/MHz.
4. For U-NII-2C, the directional gain is 6.39 dBi > 6 dBi, so the power density limit shall be reduced to $11-(6.39-6) = 10.61$ dBm/MHz.

802.11ax (HE160)

Chan.	Chan. Freq. (MHz)	PSD (dBm/MHz)				Total PSD (dBm/MHz)	Max. PSD Limit (dBm/MHz)	Test Result
		Chain 0	Chain 1	Chain 2	Chain 3			
50 (U-NII-1)	5250	-5.19	-5.38	-6.21	-6.12	0.32	17	Pass
50 (U-NII-2A)	5250	-4.89	-5.16	-5.48	-5.51	0.77	10.92	Pass
114	5570	-6.37	-6.64	-6.43	-6.53	-0.47	10.61	Pass

Notes:

- Method E) 2) a) of power density measurement of KDB 662911 is using for calculating total power density. Total power density is summing entire spectra across corresponding frequency bins on the various outputs by computer.
- Directional gain is the measured value according to KDB 662911 D03 Method of MIMO Antenna Gain Measurement.
- For U-NII-1, the directional gain is 5.96 dBi < 6dBi, so the power density limit shall not be reduced.
- For U-NII-2A, the directional gain is 6.08 dBi > 6 dBi, so the power density limit shall be reduced to $11-(6.08-6) = 10.92$ dBm/MHz.
- For U-NII-2C, the directional gain is 6.39 dBi > 6 dBi, so the power density limit shall be reduced to $11-(6.39-6) = 10.61$ dBm/MHz.

802.11a

Chan.	Chan. Freq. (MHz)	PSD (dBm/300kHz)				Total PSD (dBm/300kHz)	Total PSD (dBm/500kHz)	PSD Limit (dBm/500kHz)	Test Result
		Chain 0	Chain 1	Chain 2	Chain 3				
144 (U-NII-3)	5720	-3.71	-3.67	-3.84	-3.55	2.33	4.55	29.98	Pass

Notes:

- Method E) 2) b) Measure and sum spectral maxima across the outputs of KDB 662911 is using for calculating total power density.
- Directional gain is the measured value according to KDB 662911 D03 Method of MIMO Antenna Gain Measurement.
- For U-NII-3, the directional gain is 6.48 dBi > 6 dBi, so the power density limit shall be reduced to $30-(6.02-6) = 29.98$ dBm/500kHz.

802.11ax (HE20)

Chan.	Chan. Freq. (MHz)	PSD (dBm/300kHz)				Total PSD (dBm/300kHz)	Total PSD (dBm/500kHz)	PSD Limit (dBm/500kHz)	Test Result
		Chain 0	Chain 1	Chain 2	Chain 3				
144 (U-NII-3)	5720	-6.70	-7.45	-7.10	-7.87	-1.24	0.98	29.98	Pass

Notes:

- Method E) 2) b) Measure and sum spectral maxima across the outputs of KDB 662911 is using for calculating total power density.
- Directional gain is the measured value according to KDB 662911 D03 Method of MIMO Antenna Gain Measurement.
- For U-NII-3, the directional gain is 6.48 dBi > 6 dBi, so the power density limit shall be reduced to $30-(6.02-6) = 29.98$ dBm/500kHz.

802.11ax (HE40)

Chan.	Chan. Freq. (MHz)	PSD (dBm/300kHz)				Total PSD (dBm/300kHz)	Total PSD (dBm/500kHz)	PSD Limit (dBm/500kHz)	Test Result
		Chain 0	Chain 1	Chain 2	Chain 3				
142 (U-NII-3)	5710	-9.46	-10.08	-9.90	-9.89	-3.81	-1.59	29.98	Pass

Notes:

1. Method E) 2) b) Measure and sum spectral maxima across the outputs of KDB 662911 is using for calculating total power density.
2. Directional gain is the measured value according to KDB 662911 D03 Method of MIMO Antenna Gain Measurement.
3. For U-NII-3, the directional gain is 6.48 dBi > 6 dBi, so the power density limit shall be reduced to $30-(6.02-6) = 29.98$ dBm/500kHz.

802.11ax (HE80)

Chan.	Chan. Freq. (MHz)	PSD (dBm/300kHz)				Total PSD (dBm/300kHz)	Total PSD (dBm/500kHz)	PSD Limit (dBm/500kHz)	Test Result
		Chain 0	Chain 1	Chain 2	Chain 3				
138 (U-NII-3)	5690	-12.94	-13.06	-13.63	-13.79	-7.32	-5.10	29.98	Pass

Notes:

1. Method E) 2) b) Measure and sum spectral maxima across the outputs of KDB 662911 is using for calculating total power density.
2. Directional gain is the measured value according to KDB 662911 D03 Method of MIMO Antenna Gain Measurement.
3. For U-NII-3, the directional gain is 6.48 dBi > 6 dBi, so the power density limit shall be reduced to $30-(6.02-6) = 29.98$ dBm/500kHz.



Spectrum Plot of Maximum Value

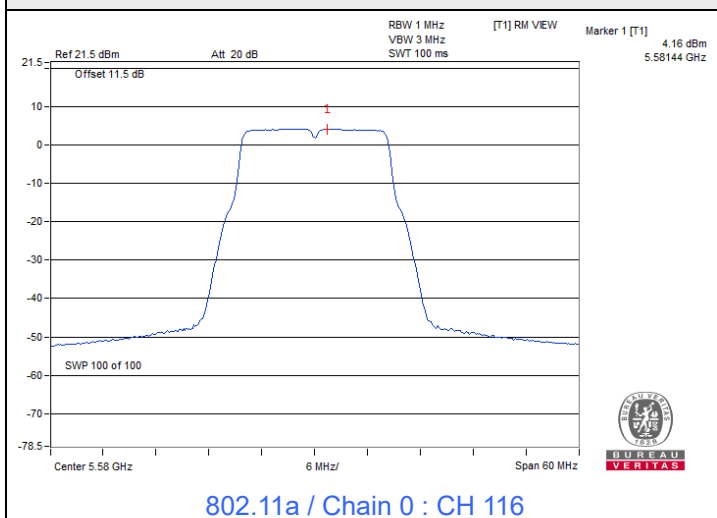

802.11a / Chain 0 : CH 116

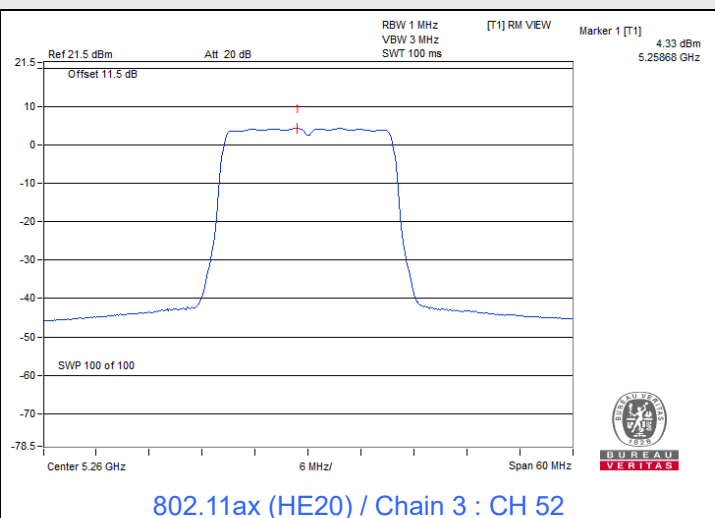

802.11ax (HE20) / Chain 3 : CH 52

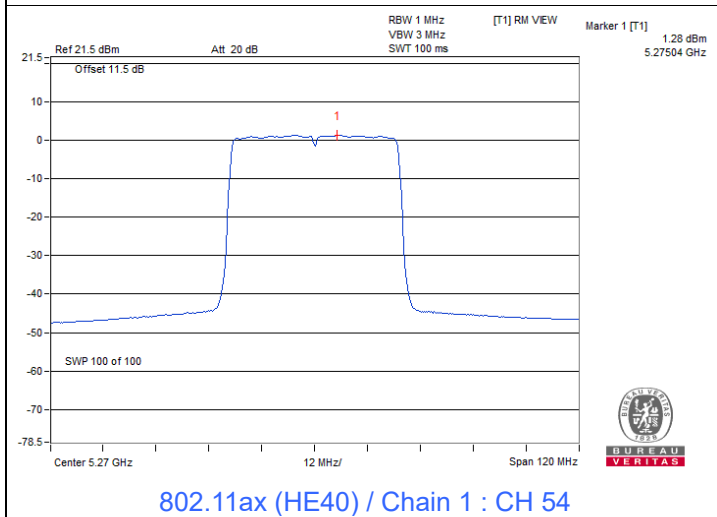

802.11ax (HE40) / Chain 1 : CH 54

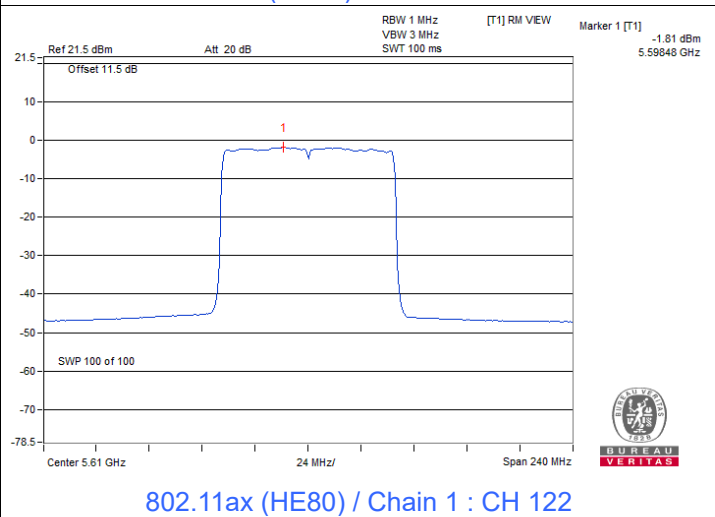

802.11ax (HE80) / Chain 1 : CH 122

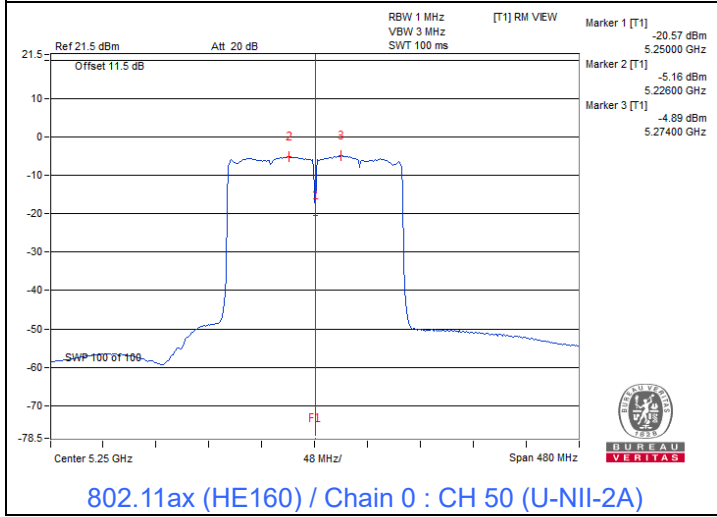

802.11ax (HE160) / Chain 0 : CH 50 (U-NII-2A)

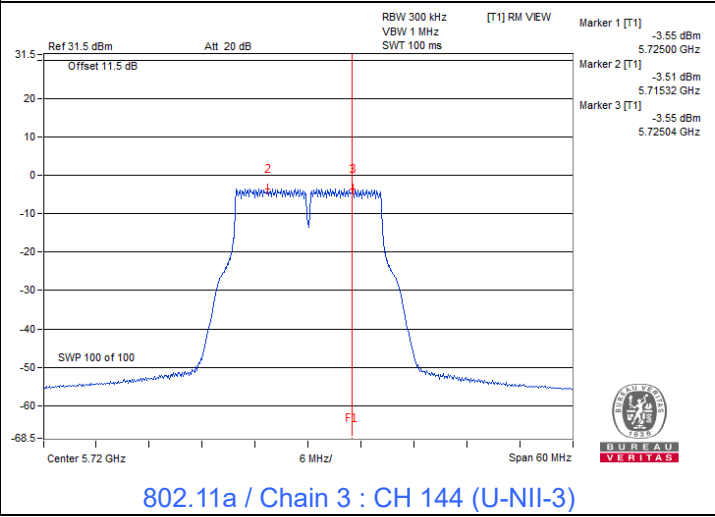

802.11a / Chain 3 : CH 144 (U-NII-3)

Spectrum Plot of Maximum Value

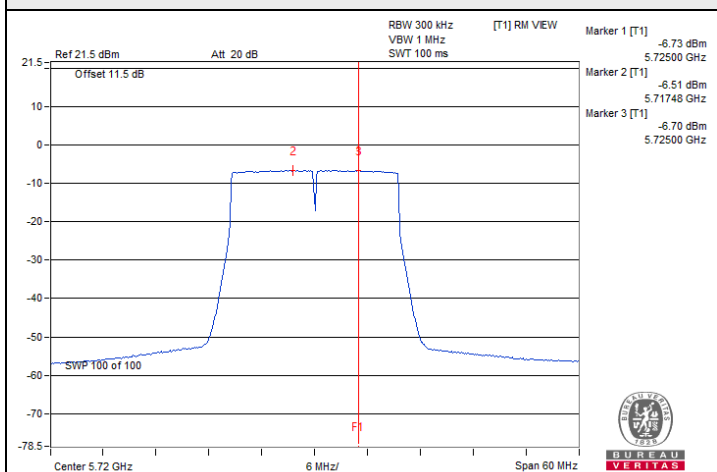

802.11ax (HE20) / Chain 0 : CH 144 (U-NII-3)

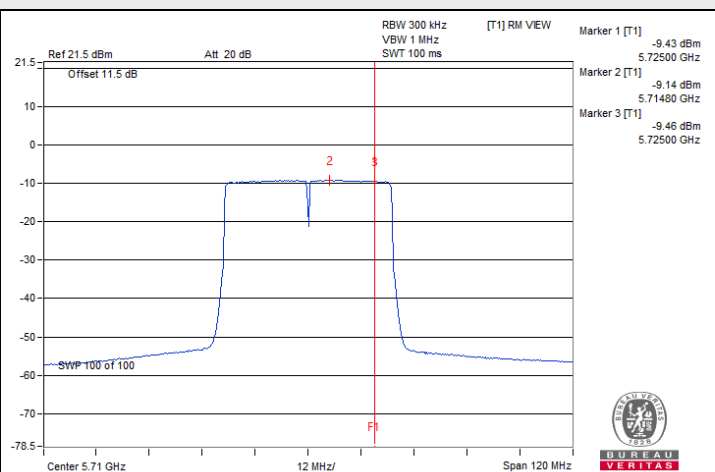

802.11ax (HE40) / Chain 0 : CH 142 (U-NII-3)

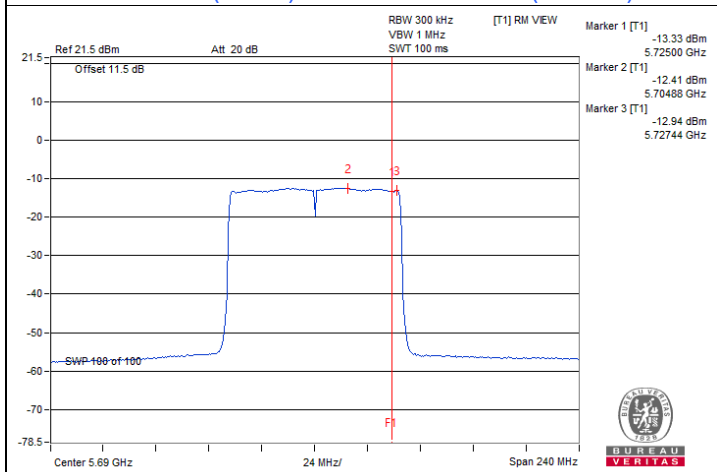

802.11ax (HE80) / Chain 0 : CH 138 (U-NII-3)

7.4 6 dB Bandwidth

Input Power:	120 Vac, 60 Hz	Environmental Conditions:	25°C, 60% RH	Tested By:	Gary Lin / Wayne Lin
--------------	----------------	---------------------------	--------------	------------	----------------------

802.11a

Channel	Frequency (MHz)	6 dB Bandwidth (MHz)				Minimum Limit (MHz)	Test Result
		Chain 0	Chain 1	Chain 2	Chain 3		
144 (U-NII-3)	5720	3.21	3.21	3.20	3.21	0.5	Pass

802.11ax (HE20)

Channel	Frequency (MHz)	6 dB Bandwidth (MHz)				Minimum Limit (MHz)	Test Result
		Chain 0	Chain 1	Chain 2	Chain 3		
144 (U-NII-3)	5720	4.54	4.49	4.50	4.48	0.5	Pass

802.11ax (HE40)

Channel	Frequency (MHz)	6 dB Bandwidth (MHz)				Minimum Limit (MHz)	Test Result
		Chain 0	Chain 1	Chain 2	Chain 3		
142 (U-NII-3)	5710	4.06	3.97	4.00	4.01	0.5	Pass

802.11ax (HE80)

Channel	Frequency (MHz)	6 dB Bandwidth (MHz)				Minimum Limit (MHz)	Test Result
		Chain 0	Chain 1	Chain 2	Chain 3		
138 (U-NII-3)	5690	4.03	3.90	3.93	3.88	0.5	Pass



Spectrum Plot of Minimum Value

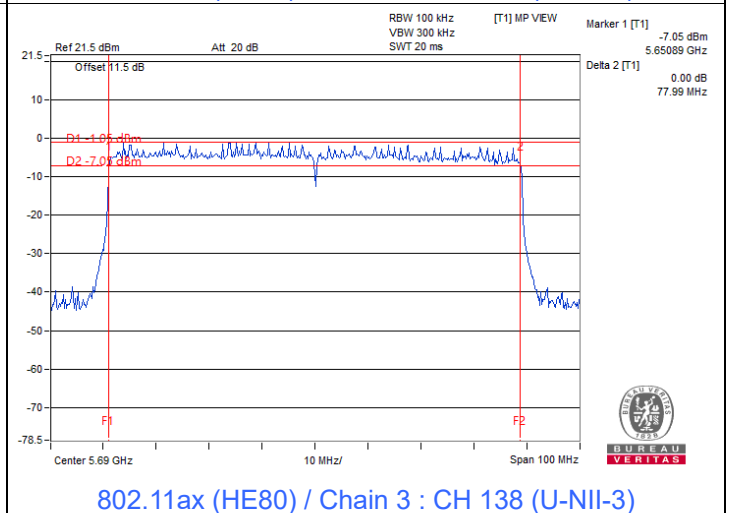
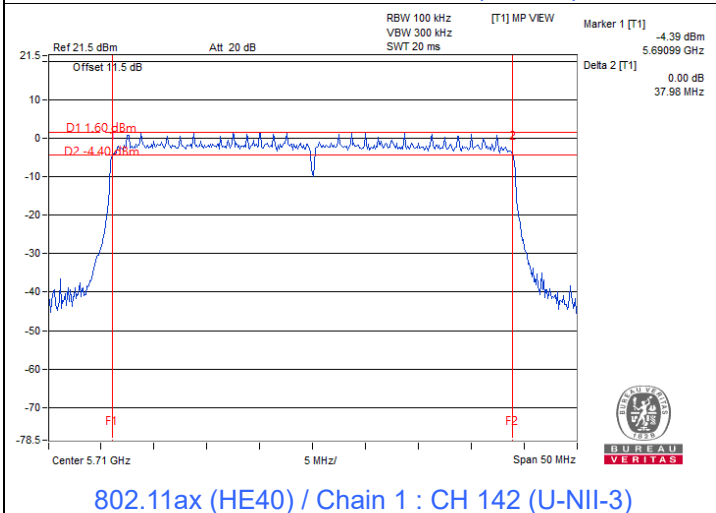
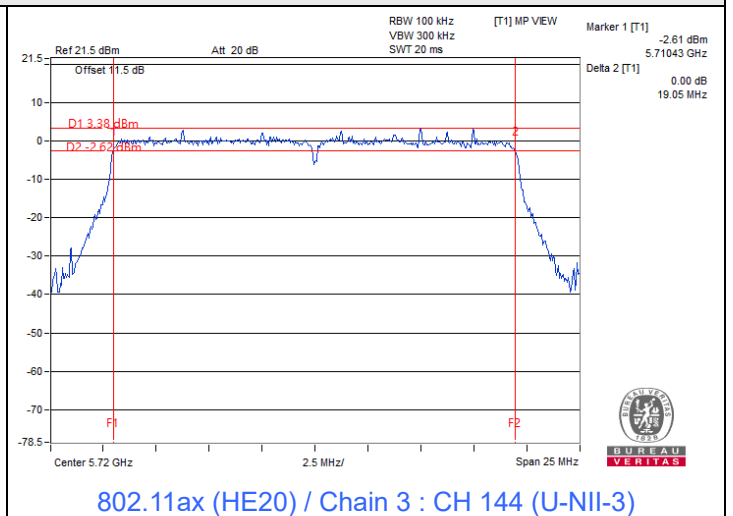
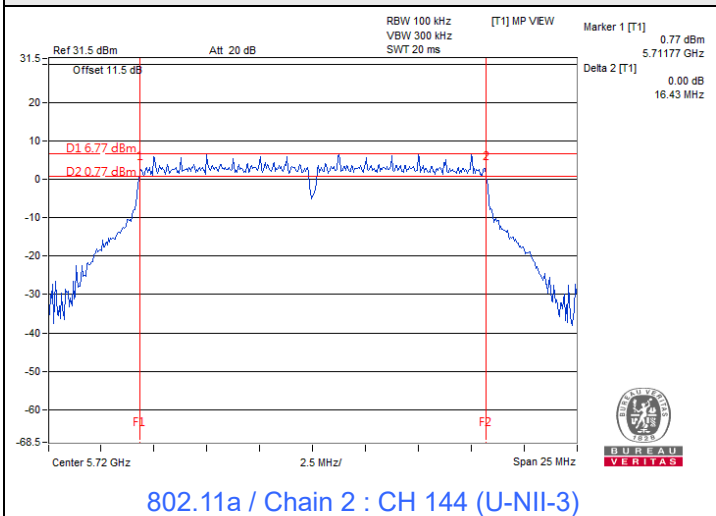

Note: For U-NII-3 straddle channel = Marker 1 + Delta 2 - 5725 MHz

7.5 Occupied Bandwidth

Input Power:	120 Vac, 60 Hz	Environmental Conditions:	25°C, 60% RH	Tested By:	Gary Lin / Wayne Lin
--------------	----------------	---------------------------	--------------	------------	----------------------

802.11a

Channel	Frequency (MHz)	Occupied Bandwidth (MHz)			
		Chain 0	Chain 1	Chain 2	Chain 3
52	5260	16.92	16.80	16.92	16.92
60	5300	16.92	17.04	16.92	16.80
64	5320	17.28	17.04	17.16	17.04
100	5500	17.16	17.16	17.04	16.92
116	5580	17.04	16.92	16.92	16.92
140	5700	16.92	16.92	17.04	16.92
144 (U-NII-2C)	5720	13.52	13.64	13.52	13.52
144 (U-NII-3)	5720	3.40	3.52	3.40	3.40

802.11ax (HE20)

Channel	Frequency (MHz)	Occupied Bandwidth (MHz)			
		Chain 0	Chain 1	Chain 2	Chain 3
52	5260	19.20	19.20	19.20	19.08
60	5300	19.20	19.20	19.08	19.32
64	5320	19.20	19.32	19.20	19.32
100	5500	19.32	19.32	19.44	19.32
116	5580	19.20	19.08	19.20	19.20
140	5700	19.08	19.08	19.20	19.08
144 (U-NII-2C)	5720	14.60	14.60	14.60	14.72
144 (U-NII-3)	5720	4.48	4.60	4.48	4.48

802.11ax (HE40)

Channel	Frequency (MHz)	Occupied Bandwidth (MHz)			
		Chain 0	Chain 1	Chain 2	Chain 3
54	5270	37.92	37.92	37.92	37.92
62	5310	38.16	38.40	38.16	38.16
102	5510	38.16	38.16	38.16	38.40
110	5550	37.92	37.92	37.92	38.16
134	5670	37.92	37.92	37.92	37.92
142 (U-NII-2C)	5710	33.96	34.20	34.20	34.20
142 (U-NII-3)	5710	3.96	3.96	3.96	3.96

802.11ax (HE80)

Channel	Frequency (MHz)	Occupied Bandwidth (MHz)			
		Chain 0	Chain 1	Chain 2	Chain 3
58	5290	77.76	77.28	77.28	77.76
106	5530	77.28	77.76	77.76	77.76
122	5610	77.76	77.28	77.76	77.28
138 (U-NII-2C)	5690	73.61	73.88	73.88	73.88
138 (U-NII-3)	5690	3.61	3.88	3.40	3.40

802.11ax (HE160)

Channel	Frequency (MHz)	Occupied Bandwidth (MHz)			
		Chain 0	Chain 1	Chain 2	Chain 3
50 (U-NII-1)	5250	78.72	79.68	78.72	78.72
50 (U-NII-2A)	5250	77.76	77.76	78.72	77.76
114	5570	157.44	156.48	157.44	156.48



Spectrum Plot of Maximum Value

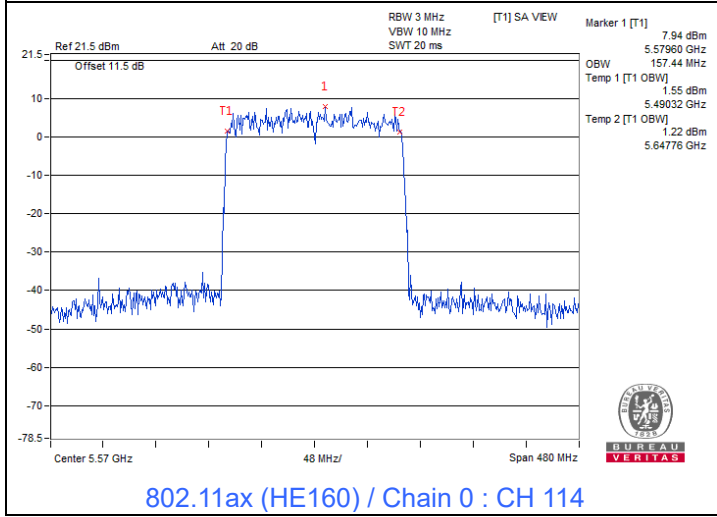
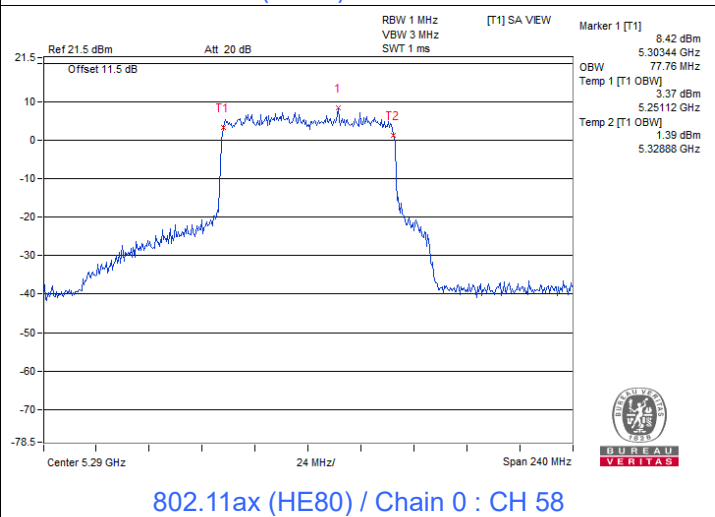
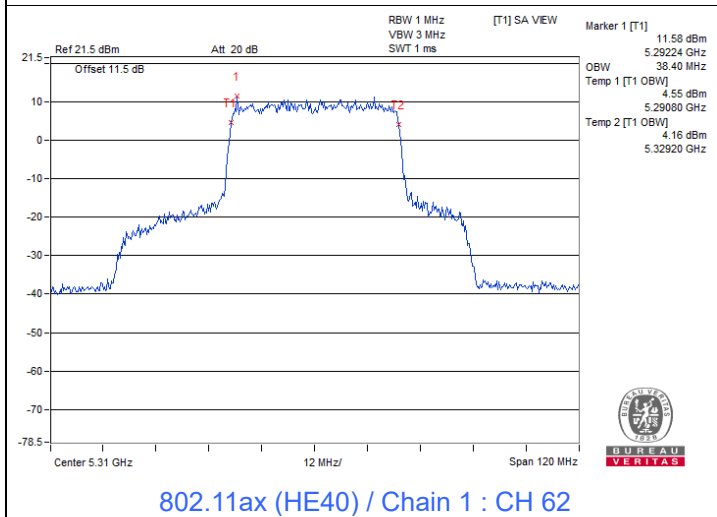
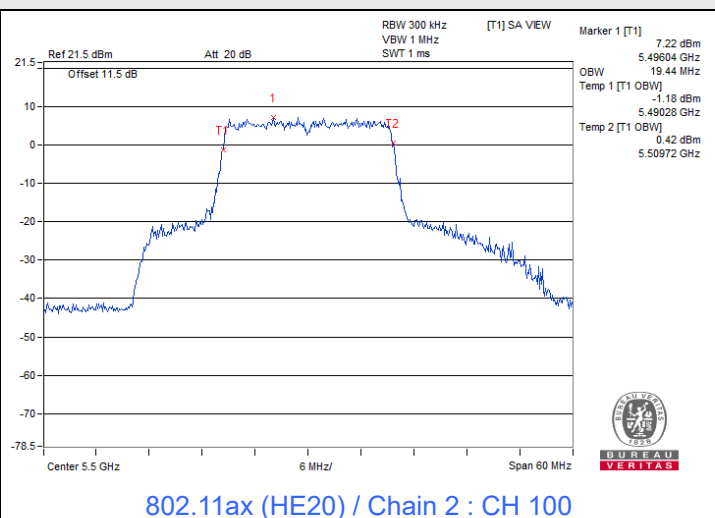
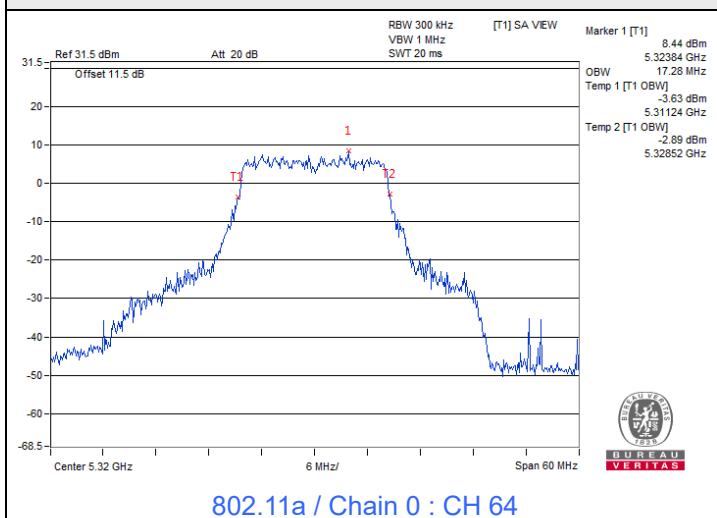

7.6 Frequency Stability

Input Power:	120 Vac, 60 Hz	Environmental Conditions:	25°C, 60% RH	Tested By:	Gary Lin / Wayne Lin
--------------	----------------	---------------------------	--------------	------------	----------------------

802.11a

Frequency Stability Versus Temperature									
Operating Frequency: 5260 MHz									
Temp. (°C)	Power Supply (Vac)	0 Minute		2 Minutes		5 Minutes		10 Minutes	
		Measured Frequency (MHz)	Test Result	Measured Frequency (MHz)	Test Result	Measured Frequency (MHz)	Test Result	Measured Frequency (MHz)	Test Result
50	120	5259.9806	Pass	5259.9846	Pass	5259.9828	Pass	5259.9843	Pass
40	120	5259.9767	Pass	5259.9788	Pass	5259.977	Pass	5259.9784	Pass
30	120	5260.006	Pass	5260.0087	Pass	5260.0071	Pass	5260.0042	Pass
20	120	5259.9919	Pass	5259.9898	Pass	5259.9895	Pass	5259.9913	Pass
10	120	5260.0002	Pass	5260.0014	Pass	5260.0007	Pass	5260.001	Pass
0	120	5260.0062	Pass	5260.0095	Pass	5260.0081	Pass	5260.0087	Pass
-10	120	5260.0127	Pass	5260.0092	Pass	5260.0118	Pass	5260.0101	Pass
-20	120	5259.9978	Pass	5259.9946	Pass	5259.9965	Pass	5259.9956	Pass
-30	120	5260.0031	Pass	5260.001	Pass	5259.999	Pass	5259.9995	Pass

Frequency Stability Versus Voltage									
Operating Frequency: 5260 MHz									
Temp. (°C)	Power Supply (Vac)	0 Minute		2 Minutes		5 Minutes		10 Minutes	
		Measured Frequency (MHz)	Test Result	Measured Frequency (MHz)	Test Result	Measured Frequency (MHz)	Test Result	Measured Frequency (MHz)	Test Result
20	138	5259.9889	Pass	5259.9845	Pass	5259.9846	Pass	5259.9895	Pass
	120	5259.9919	Pass	5259.9898	Pass	5259.9895	Pass	5259.9913	Pass
	102	5259.985	Pass	5259.9843	Pass	5259.985	Pass	5259.9828	Pass

7.7 AC Power Conducted Emissions

RF Mode	802.11ax (HE40)	Channel	CH 142 : 5710 MHz
Frequency Range	150kHz ~ 30MHz	Detector Function & Resolution Bandwidth	Quasi-Peak (QP) / Average (AV), 9 kHz
Input Power	120 Vac, 60 Hz	Environmental Conditions	23°C, 67% RH
Tested By	Adair Peng		

Phase Of Power : Line (L)										
No	Frequency (MHz)	Correction Factor (dB)	Reading Value (dBuV)		Emission Level (dBuV)		Limit (dBuV)		Margin (dB)	
			Q.P.	AV.	Q.P.	AV.	Q.P.	AV.	Q.P.	AV.
1	0.15000	9.68	30.22	21.95	39.90	31.63	66.00	56.00	-26.10	-24.37
2	0.17000	9.70	31.20	17.13	40.90	26.83	64.96	54.96	-24.06	-28.13
3	0.19780	9.72	26.82	12.72	36.54	22.44	63.70	53.70	-27.16	-31.26
4	0.65400	9.84	22.55	15.52	32.39	25.36	56.00	46.00	-23.61	-20.64
5	10.66200	10.05	23.10	16.36	33.15	26.41	60.00	50.00	-26.85	-23.59
6	24.57800	10.23	23.18	22.15	33.41	32.38	60.00	50.00	-26.59	-17.62

Remarks:

1. Q.P. and AV. are abbreviations of quasi-peak and average individually.
2. The emission levels of other frequencies were very low against the limit.
3. Margin value = Emission level – Limit value
4. Correction factor = Insertion loss + Cable loss
5. Emission Level = Correction Factor + Reading Value

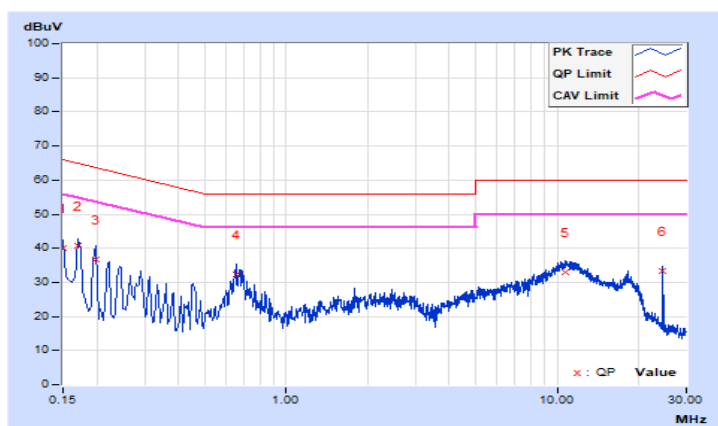

RF Mode	802.11ax (HE40)	Channel	CH 142 : 5710 MHz
Frequency Range	150kHz ~ 30MHz	Detector Function & Resolution Bandwidth	Quasi-Peak (QP) / Average (AV), 9 kHz
Input Power	120 Vac, 60 Hz	Environmental Conditions	23°C, 67% RH
Tested By	Adair Peng		

Phase Of Power : Neutral (N)										
No	Frequency (MHz)	Correction Factor (dB)	Reading Value (dBuV)		Emission Level (dBuV)		Limit (dBuV)		Margin (dB)	
			Q.P.	AV.	Q.P.	AV.	Q.P.	AV.	Q.P.	AV.
1	0.16535	9.69	33.67	19.10	43.36	28.79	65.19	55.19	-21.83	-26.40
2	0.19000	9.71	29.80	14.91	39.51	24.62	64.04	54.04	-24.53	-29.42
3	0.26200	9.74	19.92	10.86	29.66	20.60	61.37	51.37	-31.71	-30.77
4	0.65000	9.81	18.33	13.62	28.14	23.43	56.00	46.00	-27.86	-22.57
5	10.66600	10.09	22.45	15.67	32.54	25.76	60.00	50.00	-27.46	-24.24
6	24.57800	10.21	22.33	22.15	32.54	32.36	60.00	50.00	-27.46	-17.64

Remarks:

1. Q.P. and AV. are abbreviations of quasi-peak and average individually.
2. The emission levels of other frequencies were very low against the limit.
3. Margin value = Emission level – Limit value
4. Correction factor = Insertion loss + Cable loss
5. Emission Level = Correction Factor + Reading Value

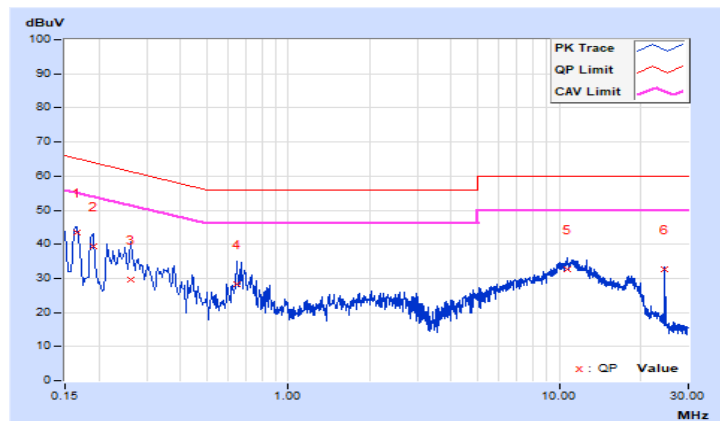

7.8 Unwanted Emissions below 1 GHz

RF Mode	802.11ax (HE40)	Channel	CH 142 : 5710 MHz
Frequency Range	9 kHz ~ 1 GHz	Detector Function & Bandwidth	(QP) RB = 120kHz
Input Power	120 Vac, 60 Hz	Environmental Conditions	23°C, 67% RH
Tested By	Adair Peng		

Antenna Polarity & Test Distance : Horizontal at 3 m								
No	Frequency (MHz)	Emission Level (dBuV/m)	Limit (dBuV/m)	Margin (dB)	Antenna Height (m)	Table Angle (Degree)	Raw Value (dBuV)	Correction Factor (dB/m)
1	40.67	38.4 QP	40.0	-1.6	1.01 H	54	47.9	-9.5
2	73.65	34.2 QP	40.0	-5.8	2.00 H	333	46.1	-11.9
3	135.73	37.9 QP	43.5	-5.6	2.00 H	6	47.4	-9.5
4	171.62	38.9 QP	43.5	-4.6	1.51 H	104	48.0	-9.1
5	211.39	38.2 QP	43.5	-5.3	1.51 H	80	49.3	-11.1
6	424.79	33.2 QP	46.0	-12.8	2.00 H	21	37.1	-3.9

Remarks:

1. Emission Level(dBuV/m) = Raw Value(dBuV) + Correction Factor(dB/m)
2. Correction Factor(dB/m) = Antenna Factor(dB/m) + Cable Factor(dB) – Pre-Amplifier Factor(dB)
3. Margin value = Emission Level – Limit value
4. The other emission levels were very low against the limit of frequency range 30 MHz ~ 1 GHz.
5. The emission levels were very low against the limit of frequency range 9 kHz ~ 30 MHz: the amplitude of spurious emissions attenuated more than 20 dB below the permissible value to be report.

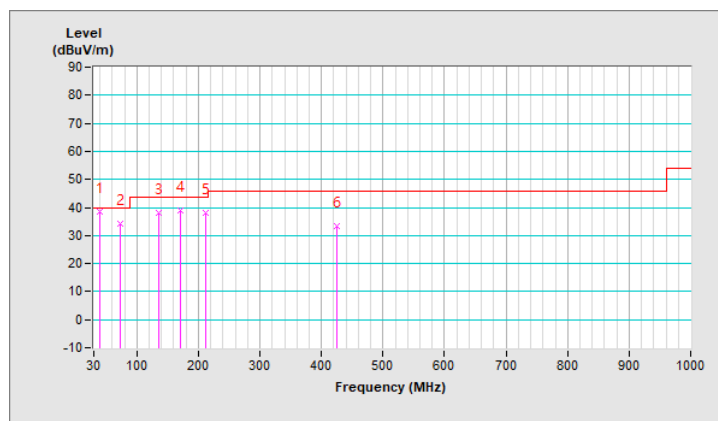

RF Mode	802.11ax (HE40)	Channel	CH 142 : 5710 MHz
Frequency Range	9 kHz ~ 1 GHz	Detector Function & Bandwidth	(QP) RB = 120kHz
Input Power	120 Vac, 60 Hz	Environmental Conditions	23°C, 67% RH
Tested By	Adair Peng		

Antenna Polarity & Test Distance : Vertical at 3 m								
No	Frequency (MHz)	Emission Level (dBuV/m)	Limit (dBuV/m)	Margin (dB)	Antenna Height (m)	Table Angle (Degree)	Raw Value (dBuV)	Correction Factor (dB/m)
1	57.16	31.6 QP	40.0	-8.4	1.00 V	3	41.0	-9.4
2	73.65	37.0 QP	40.0	-3.0	1.99 V	6	48.9	-11.9
3	135.73	31.7 QP	43.5	-11.8	1.00 V	352	41.2	-9.5
4	171.62	34.9 QP	43.5	-8.6	1.99 V	229	44.0	-9.1
5	211.39	33.5 QP	43.5	-10.0	1.99 V	95	44.6	-11.1
6	618.79	31.7 QP	46.0	-14.3	1.00 V	34	31.6	0.1

Remarks:

1. Emission Level(dBuV/m) = Raw Value(dBuV) + Correction Factor(dB/m)
2. Correction Factor(dB/m) = Antenna Factor(dB/m) + Cable Factor(dB) – Pre-Amplifier Factor(dB)
3. Margin value = Emission Level – Limit value
4. The other emission levels were very low against the limit of frequency range 30 MHz ~ 1 GHz.
5. The emission levels were very low against the limit of frequency range 9 kHz ~ 30 MHz: the amplitude of spurious emissions attenuated more than 20 dB below the permissible value to be report.

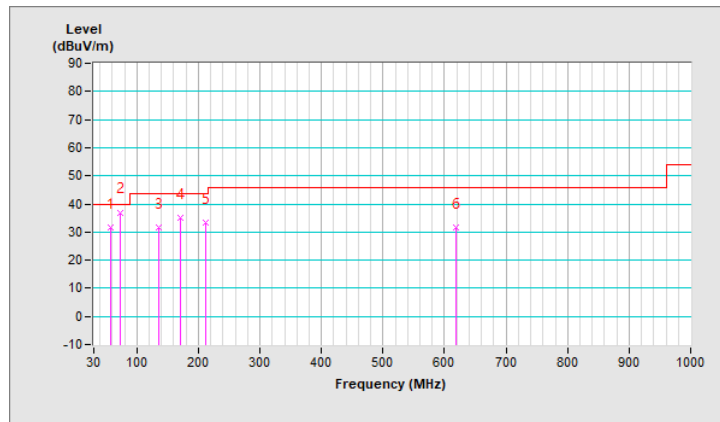

7.9 Unwanted Emissions above 1 GHz

RF Mode	802.11a	Channel	CH 52 : 5260 MHz
Frequency Range	1 GHz ~ 40 GHz	Detector Function & Bandwidth	(PK) RB = 1 MHz, VB = 3 MHz (AV) RB = 1 MHz, VB = 10 Hz
Input Power	120 Vac, 60 Hz	Environmental Conditions	20.9°C, 76.8% RH
Tested By	Rex Wang/Adair Peng		

Antenna Polarity & Test Distance : Horizontal at 3 m								
No	Frequency (MHz)	Emission Level (dBuV/m)	Limit (dBuV/m)	Margin (dB)	Antenna Height (m)	Table Angle (Degree)	Raw Value (dBuV)	Correction Factor (dB/m)
1	5150.00	61.7 PK	74.0	-12.3	3.91 H	98	40.8	20.9
2	5150.00	48.5 AV	54.0	-5.5	3.91 H	98	27.6	20.9
3	*5260.00	121.2 PK			3.91 H	98	80.4	40.8
4	*5260.00	111.5 AV			3.91 H	98	70.7	40.8
5	5458.80	64.0 PK	74.0	-10.0	3.91 H	98	42.4	21.6
6	5458.80	51.6 AV	54.0	-2.4	3.91 H	98	30.0	21.6
7	#10520.00	64.1 PK	68.2	-4.1	3.83 H	112	38.9	25.2
Antenna Polarity & Test Distance : Vertical at 3 m								
No	Frequency (MHz)	Emission Level (dBuV/m)	Limit (dBuV/m)	Margin (dB)	Antenna Height (m)	Table Angle (Degree)	Raw Value (dBuV)	Correction Factor (dB/m)
1	5000.00	61.4 PK	74.0	-12.6	2.68 V	233	41.0	20.4
2	5000.00	48.5 AV	54.0	-5.5	2.68 V	233	28.1	20.4
3	*5260.00	121.3 PK			2.68 V	233	80.5	40.8
4	*5260.00	112.0 AV			2.68 V	233	71.2	40.8
5	5454.60	64.1 PK	74.0	-9.9	2.68 V	233	42.5	21.6
6	5454.60	51.7 AV	54.0	-2.3	2.68 V	233	30.1	21.6
7	#10520.00	64.3 PK	68.2	-3.9	3.02 V	294	39.1	25.2

Remarks:

1. Emission Level(dBuV/m) = Raw Value(dBuV) + Correction Factor(dB/m)
2. Correction Factor(dB/m) = Antenna Factor(dB/m) + Cable Factor(dB) – Pre-Amplifier Factor(dB)
3. Margin value = Emission Level – Limit value
4. The other emission levels were very low against the limit.
5. " * " : Fundamental frequency, the limit was restricted at the RF Output Power.
6. " # " : The radiated frequency is out of the restricted band.



RF Mode	802.11a	Channel	CH 60 : 5300 MHz
Frequency Range	1 GHz ~ 40 GHz	Detector Function & Bandwidth	(PK) RB = 1 MHz, VB = 3 MHz (AV) RB = 1 MHz, VB = 10 Hz
Input Power	120 Vac, 60 Hz	Environmental Conditions	20.9°C, 76.8% RH
Tested By	Rex Wang/Adair Peng		

Antenna Polarity & Test Distance : Horizontal at 3 m

No	Frequency (MHz)	Emission Level (dBuV/m)	Limit (dBuV/m)	Margin (dB)	Antenna Height (m)	Table Angle (Degree)	Raw Value (dBuV)	Correction Factor (dB/m)
1	5150.00	59.9 PK	74.0	-14.1	3.93 H	102	39.0	20.9
2	5150.00	48.1 AV	54.0	-5.9	3.93 H	102	27.2	20.9
3	*5300.00	121.4 PK			3.93 H	102	80.6	40.8
4	*5300.00	111.3 AV			3.93 H	102	70.5	40.8
5	5350.00	64.0 PK	74.0	-10.0	3.93 H	102	43.0	21.0
6	5350.00	50.7 AV	54.0	-3.3	3.93 H	102	29.7	21.0
7	10600.00	63.9 PK	74.0	-10.1	3.96 H	114	38.5	25.4
8	10600.00	49.5 AV	54.0	-4.5	3.96 H	114	24.1	25.4

Antenna Polarity & Test Distance : Vertical at 3 m

No	Frequency (MHz)	Emission Level (dBuV/m)	Limit (dBuV/m)	Margin (dB)	Antenna Height (m)	Table Angle (Degree)	Raw Value (dBuV)	Correction Factor (dB/m)
1	5000.00	60.2 PK	74.0	-13.8	2.68 V	233	39.8	20.4
2	5000.00	48.3 AV	54.0	-5.7	2.68 V	233	27.9	20.4
3	*5300.00	121.8 PK			2.68 V	233	81.0	40.8
4	*5300.00	111.9 AV			2.68 V	233	71.1	40.8
5	5350.00	66.4 PK	74.0	-7.6	2.68 V	233	45.4	21.0
6	5350.00	50.4 AV	54.0	-3.6	2.68 V	233	29.4	21.0
7	10600.00	64.2 PK	74.0	-9.8	2.97 V	288	38.8	25.4
8	10600.00	49.7 AV	54.0	-4.3	2.97 V	288	24.3	25.4

Remarks:

1. Emission Level(dBuV/m) = Raw Value(dBuV) + Correction Factor(dB/m)
2. Correction Factor(dB/m) = Antenna Factor(dB/m) + Cable Factor(dB) – Pre-Amplifier Factor(dB)
3. Margin value = Emission Level – Limit value
4. The other emission levels were very low against the limit.
5. " * " : Fundamental frequency, the limit was restricted at the RF Output Power.

RF Mode	802.11a	Channel	CH 64 : 5320 MHz
Frequency Range	1 GHz ~ 40 GHz	Detector Function & Bandwidth	(PK) RB = 1 MHz, VB = 3 MHz (AV) RB = 1 MHz, VB = 10 Hz
Input Power	120 Vac, 60 Hz	Environmental Conditions	20.9°C, 76.8% RH
Tested By	Rex Wang/Adair Peng		

Antenna Polarity & Test Distance : Horizontal at 3 m								
No	Frequency (MHz)	Emission Level (dBuV/m)	Limit (dBuV/m)	Margin (dB)	Antenna Height (m)	Table Angle (Degree)	Raw Value (dBuV)	Correction Factor (dB/m)
1	*5320.00	119.6 PK			3.68 H	116	78.7	40.9
2	*5320.00	109.9 AV			3.68 H	116	69.0	40.9
3	5395.00	63.6 PK	74.0	-10.4	3.68 H	116	42.3	21.3
4	5395.00	51.9 AV	54.0	-2.1	3.68 H	116	30.6	21.3
5	10640.00	64.3 PK	74.0	-9.7	3.84 H	110	38.5	25.8
6	10640.00	49.6 AV	54.0	-4.4	3.84 H	110	23.8	25.8
Antenna Polarity & Test Distance : Vertical at 3 m								
No	Frequency (MHz)	Emission Level (dBuV/m)	Limit (dBuV/m)	Margin (dB)	Antenna Height (m)	Table Angle (Degree)	Raw Value (dBuV)	Correction Factor (dB/m)
1	*5320.00	121.0 PK			2.54 V	234	80.1	40.9
2	*5320.00	111.6 AV			2.54 V	234	70.7	40.9
3	5396.00	64.6 PK	74.0	-9.4	2.54 V	234	43.3	21.3
4	5396.00	52.8 AV	54.0	-1.2	2.54 V	234	31.5	21.3
5	10640.00	64.6 PK	74.0	-9.4	3.00 V	292	38.8	25.8
6	10640.00	49.8 AV	54.0	-4.2	3.00 V	292	24.0	25.8

Remarks:

1. Emission Level(dBuV/m) = Raw Value(dBuV) + Correction Factor(dB/m)
2. Correction Factor(dB/m) = Antenna Factor(dB/m) + Cable Factor(dB) – Pre-Amplifier Factor(dB)
3. Margin value = Emission Level – Limit value
4. The other emission levels were very low against the limit.
5. " * ": Fundamental frequency, the limit was restricted at the RF Output Power.

RF Mode	802.11a	Channel	CH 100 : 5500 MHz
Frequency Range	1 GHz ~ 40 GHz	Detector Function & Bandwidth	(PK) RB = 1 MHz, VB = 3 MHz (AV) RB = 1 MHz, VB = 10 Hz
Input Power	120 Vac, 60 Hz	Environmental Conditions	20.9°C, 76.8% RH
Tested By	Rex Wang/Adair Peng		

Antenna Polarity & Test Distance : Horizontal at 3 m								
No	Frequency (MHz)	Emission Level (dBuV/m)	Limit (dBuV/m)	Margin (dB)	Antenna Height (m)	Table Angle (Degree)	Raw Value (dBuV)	Correction Factor (dB/m)
1	5460.00	63.6 PK	74.0	-10.4	3.67 H	103	42.0	21.6
2	5460.00	51.0 AV	54.0	-3.0	3.67 H	103	29.4	21.6
3	#5470.00	65.7 PK	68.2	-2.5	3.67 H	103	44.1	21.6
4	*5500.00	119.6 PK			3.67 H	103	78.1	41.5
5	*5500.00	110.2 AV			3.67 H	103	68.7	41.5
6	11000.00	64.9 PK	74.0	-9.1	3.94 H	116	38.8	26.1
7	11000.00	49.7 AV	54.0	-4.3	3.94 H	116	23.6	26.1
Antenna Polarity & Test Distance : Vertical at 3 m								
No	Frequency (MHz)	Emission Level (dBuV/m)	Limit (dBuV/m)	Margin (dB)	Antenna Height (m)	Table Angle (Degree)	Raw Value (dBuV)	Correction Factor (dB/m)
1	5460.00	64.4 PK	74.0	-9.6	2.30 V	232	42.8	21.6
2	5460.00	51.7 AV	54.0	-2.3	2.30 V	232	30.1	21.6
3	#5470.00	66.4 PK	68.2	-1.8	2.30 V	232	44.8	21.6
4	*5500.00	119.7 PK			2.30 V	232	78.2	41.5
5	*5500.00	110.5 AV			2.30 V	232	69.0	41.5
6	11000.00	65.3 PK	74.0	-8.7	2.96 V	288	39.2	26.1
7	11000.00	49.9 AV	54.0	-4.1	2.96 V	288	23.8	26.1

Remarks:

1. Emission Level(dBuV/m) = Raw Value(dBuV) + Correction Factor(dB/m)
2. Correction Factor(dB/m) = Antenna Factor(dB/m) + Cable Factor(dB) – Pre-Amplifier Factor(dB)
3. Margin value = Emission Level – Limit value
4. The other emission levels were very low against the limit.
5. " * ": Fundamental frequency, the limit was restricted at the RF Output Power.
6. " # ": The radiated frequency is out of the restricted band.



RF Mode	802.11a	Channel	CH 116 : 5580 MHz
Frequency Range	1 GHz ~ 40 GHz	Detector Function & Bandwidth	(PK) RB = 1 MHz, VB = 3 MHz (AV) RB = 1 MHz, VB = 10 Hz
Input Power	120 Vac, 60 Hz	Environmental Conditions	20.9°C, 76.8% RH
Tested By	Rex Wang/Adair Peng		

Antenna Polarity & Test Distance : Horizontal at 3 m								
No	Frequency (MHz)	Emission Level (dBuV/m)	Limit (dBuV/m)	Margin (dB)	Antenna Height (m)	Table Angle (Degree)	Raw Value (dBuV)	Correction Factor (dB/m)
1	*5580.00	119.4 PK			3.33 H	99	77.8	41.6
2	*5580.00	110.4 AV			3.33 H	99	68.8	41.6
3	11160.00	64.4 PK	74.0	-9.6	3.90 H	115	38.5	25.9
4	11160.00	49.0 AV	54.0	-5.0	3.90 H	115	23.1	25.9
Antenna Polarity & Test Distance : Vertical at 3 m								
No	Frequency (MHz)	Emission Level (dBuV/m)	Limit (dBuV/m)	Margin (dB)	Antenna Height (m)	Table Angle (Degree)	Raw Value (dBuV)	Correction Factor (dB/m)
1	*5580.00	120.2 PK			2.29 V	228	78.6	41.6
2	*5580.00	110.6 AV			2.29 V	228	69.0	41.6
3	11160.00	64.8 PK	74.0	-9.2	3.06 V	287	38.9	25.9
4	11160.00	49.4 AV	54.0	-4.6	3.06 V	287	23.5	25.9

Remarks:

1. Emission Level(dBuV/m) = Raw Value(dBuV) + Correction Factor(dB/m)
2. Correction Factor(dB/m) = Antenna Factor(dB/m) + Cable Factor(dB) – Pre-Amplifier Factor(dB)
3. Margin value = Emission Level – Limit value
4. The other emission levels were very low against the limit.
5. " * " : Fundamental frequency, the limit was restricted at the RF Output Power.



RF Mode	802.11a	Channel	CH 140 : 5700 MHz
Frequency Range	1 GHz ~ 40 GHz	Detector Function & Bandwidth	(PK) RB = 1 MHz, VB = 3 MHz (AV) RB = 1 MHz, VB = 10 Hz
Input Power	120 Vac, 60 Hz	Environmental Conditions	20.9°C, 76.8% RH
Tested By	Rex Wang/Adair Peng		

Antenna Polarity & Test Distance : Horizontal at 3 m

No	Frequency (MHz)	Emission Level (dBuV/m)	Limit (dBuV/m)	Margin (dB)	Antenna Height (m)	Table Angle (Degree)	Raw Value (dBuV)	Correction Factor (dB/m)
1	*5700.00	116.9 PK			3.13 H	101	75.2	41.7
2	*5700.00	106.3 AV			3.13 H	101	64.6	41.7
3	#5725.00	67.1 PK	68.2	-1.1	3.13 H	101	45.0	22.1
4	11400.00	66.0 PK	74.0	-8.0	3.85 H	117	38.6	27.4
5	11400.00	49.6 AV	54.0	-4.4	3.85 H	117	22.2	27.4

Antenna Polarity & Test Distance : Vertical at 3 m

No	Frequency (MHz)	Emission Level (dBuV/m)	Limit (dBuV/m)	Margin (dB)	Antenna Height (m)	Table Angle (Degree)	Raw Value (dBuV)	Correction Factor (dB/m)
1	*5700.00	117.3 PK			2.90 V	220	75.6	41.7
2	*5700.00	108.1 AV			2.90 V	220	66.4	41.7
3	#5725.00	67.2 PK	68.2	-1.0	2.90 V	220	45.1	22.1
4	11400.00	66.5 PK	74.0	-7.5	3.04 V	286	39.1	27.4
5	11400.00	50.0 AV	54.0	-4.0	3.04 V	286	22.6	27.4

Remarks:

1. Emission Level(dBuV/m) = Raw Value(dBuV) + Correction Factor(dB/m)
2. Correction Factor(dB/m) = Antenna Factor(dB/m) + Cable Factor(dB) – Pre-Amplifier Factor(dB)
3. Margin value = Emission Level – Limit value
4. The other emission levels were very low against the limit.
5. " * " : Fundamental frequency, the limit was restricted at the RF Output Power.
6. " # " : The radiated frequency is out of the restricted band.



RF Mode	802.11a	Channel	CH 144 : 5720 MHz
Frequency Range	1 GHz ~ 40 GHz	Detector Function & Bandwidth	(PK) RB = 1 MHz, VB = 3 MHz (AV) RB = 1 MHz, VB = 10 Hz
Input Power	120 Vac, 60 Hz	Environmental Conditions	20.9°C, 76.8% RH
Tested By	Rex Wang/Adair Peng		

Antenna Polarity & Test Distance : Horizontal at 3 m

No	Frequency (MHz)	Emission Level (dBuV/m)	Limit (dBuV/m)	Margin (dB)	Antenna Height (m)	Table Angle (Degree)	Raw Value (dBuV)	Correction Factor (dB/m)
1	#5470.00	61.2 PK	68.2	-7.0	2.77 H	100	39.6	21.6
2	*5720.00	119.3 PK			2.77 H	100	77.4	41.9
3	*5720.00	109.9 AV			2.77 H	100	68.0	41.9
4	#5850.00	61.8 PK	68.2	-6.4	2.77 H	100	39.2	22.6
5	11440.00	65.8 PK	74.0	-8.2	3.86 H	112	38.5	27.3
6	11440.00	49.7 AV	54.0	-4.3	3.86 H	112	22.4	27.3

Antenna Polarity & Test Distance : Vertical at 3 m

No	Frequency (MHz)	Emission Level (dBuV/m)	Limit (dBuV/m)	Margin (dB)	Antenna Height (m)	Table Angle (Degree)	Raw Value (dBuV)	Correction Factor (dB/m)
1	#5470.00	61.9 PK	68.2	-6.3	3.05 V	221	40.3	21.6
2	*5720.00	121.1 PK			3.05 V	221	79.2	41.9
3	*5720.00	111.8 AV			3.05 V	221	69.9	41.9
4	#5850.00	62.2 PK	68.2	-6.0	3.05 V	221	39.6	22.6
5	11440.00	65.9 PK	74.0	-8.1	2.93 V	285	38.6	27.3
6	11440.00	49.9 AV	54.0	-4.1	2.93 V	285	22.6	27.3

Remarks:

1. Emission Level(dBuV/m) = Raw Value(dBuV) + Correction Factor(dB/m)
2. Correction Factor(dB/m) = Antenna Factor(dB/m) + Cable Factor(dB) – Pre-Amplifier Factor(dB)
3. Margin value = Emission Level – Limit value
4. The other emission levels were very low against the limit.
5. " * " : Fundamental frequency, the limit was restricted at the RF Output Power.
6. " # " : The radiated frequency is out of the restricted band.



RF Mode	802.11ax (HE20)	Channel	CH 52 : 5260 MHz
Frequency Range	1 GHz ~ 40 GHz	Detector Function & Bandwidth	(PK) RB = 1 MHz, VB = 3 MHz (AV) RB = 1 MHz, VB = 10 Hz
Input Power	120 Vac, 60 Hz	Environmental Conditions	20.9°C, 76.8% RH
Tested By	Rex Wang/Adair Peng		

Antenna Polarity & Test Distance : Horizontal at 3 m								
No	Frequency (MHz)	Emission Level (dBuV/m)	Limit (dBuV/m)	Margin (dB)	Antenna Height (m)	Table Angle (Degree)	Raw Value (dBuV)	Correction Factor (dB/m)
1	5150.00	59.7 PK	74.0	-14.3	3.52 H	98	38.8	20.9
2	5150.00	48.7 AV	54.0	-5.3	3.52 H	98	27.8	20.9
3	*5260.00	122.8 PK			3.52 H	98	82.0	40.8
4	*5260.00	110.6 AV			3.52 H	98	69.8	40.8
5	5455.00	62.9 PK	74.0	-11.1	3.52 H	98	41.3	21.6
6	5455.00	51.0 AV	54.0	-3.0	3.52 H	98	29.4	21.6
7	#10520.00	63.9 PK	68.2	-4.3	3.89 H	117	38.7	25.2
Antenna Polarity & Test Distance : Vertical at 3 m								
No	Frequency (MHz)	Emission Level (dBuV/m)	Limit (dBuV/m)	Margin (dB)	Antenna Height (m)	Table Angle (Degree)	Raw Value (dBuV)	Correction Factor (dB/m)
1	5000.00	60.4 PK	74.0	-13.6	2.66 V	232	40.0	20.4
2	5000.00	48.5 AV	54.0	-5.5	2.66 V	232	28.1	20.4
3	*5260.00	123.1 PK			2.66 V	232	82.3	40.8
4	*5260.00	110.8 AV			2.66 V	232	70.0	40.8
5	5452.00	63.1 PK	74.0	-10.9	2.66 V	232	41.5	21.6
6	5452.00	51.1 AV	54.0	-2.9	2.66 V	232	29.5	21.6
7	#10520.00	64.2 PK	68.2	-4.0	3.05 V	284	39.0	25.2

Remarks:

1. Emission Level(dBuV/m) = Raw Value(dBuV) + Correction Factor(dB/m)
2. Correction Factor(dB/m) = Antenna Factor(dB/m) + Cable Factor(dB) – Pre-Amplifier Factor(dB)
3. Margin value = Emission Level – Limit value
4. The other emission levels were very low against the limit.
5. " * " : Fundamental frequency, the limit was restricted at the RF Output Power.
6. " # " : The radiated frequency is out of the restricted band.

RF Mode	802.11ax (HE20)	Channel	CH 60 : 5300 MHz
Frequency Range	1 GHz ~ 40 GHz	Detector Function & Bandwidth	(PK) RB = 1 MHz, VB = 3 MHz (AV) RB = 1 MHz, VB = 10 Hz
Input Power	120 Vac, 60 Hz	Environmental Conditions	20.9°C, 76.8% RH
Tested By	Rex Wang/Adair Peng		

Antenna Polarity & Test Distance : Horizontal at 3 m								
No	Frequency (MHz)	Emission Level (dBuV/m)	Limit (dBuV/m)	Margin (dB)	Antenna Height (m)	Table Angle (Degree)	Raw Value (dBuV)	Correction Factor (dB/m)
1	*5300.00	123.2 PK			3.46 H	98	82.4	40.8
2	*5300.00	110.8 AV			3.46 H	98	70.0	40.8
3	5350.00	69.8 PK	74.0	-4.2	3.46 H	98	48.8	21.0
4	5350.00	52.3 AV	54.0	-1.7	3.46 H	98	31.3	21.0
5	10600.00	64.3 PK	74.0	-9.7	3.80 H	112	38.9	25.4
6	10600.00	49.5 AV	54.0	-4.5	3.80 H	112	24.1	25.4
Antenna Polarity & Test Distance : Vertical at 3 m								
No	Frequency (MHz)	Emission Level (dBuV/m)	Limit (dBuV/m)	Margin (dB)	Antenna Height (m)	Table Angle (Degree)	Raw Value (dBuV)	Correction Factor (dB/m)
1	*5300.00	123.4 PK			2.75 V	232	82.6	40.8
2	*5300.00	111.5 AV			2.75 V	232	70.7	40.8
3	5352.00	70.6 PK	74.0	-3.4	2.75 V	232	49.6	21.0
4	5352.00	52.5 AV	54.0	-1.5	2.75 V	232	31.5	21.0
5	10600.00	64.6 PK	74.0	-9.4	2.96 V	285	39.2	25.4
6	10600.00	49.7 AV	54.0	-4.3	2.96 V	285	24.3	25.4

Remarks:

1. Emission Level(dBuV/m) = Raw Value(dBuV) + Correction Factor(dB/m)
2. Correction Factor(dB/m) = Antenna Factor(dB/m) + Cable Factor(dB) – Pre-Amplifier Factor(dB)
3. Margin value = Emission Level – Limit value
4. The other emission levels were very low against the limit.
5. " * ": Fundamental frequency, the limit was restricted at the RF Output Power.



RF Mode	802.11ax (HE20)	Channel	CH 64 : 5320 MHz
Frequency Range	1 GHz ~ 40 GHz	Detector Function & Bandwidth	(PK) RB = 1 MHz, VB = 3 MHz (AV) RB = 1 MHz, VB = 10 Hz
Input Power	120 Vac, 60 Hz	Environmental Conditions	20.9°C, 76.8% RH
Tested By	Rex Wang/Adair Peng		

Antenna Polarity & Test Distance : Horizontal at 3 m								
No	Frequency (MHz)	Emission Level (dBuV/m)	Limit (dBuV/m)	Margin (dB)	Antenna Height (m)	Table Angle (Degree)	Raw Value (dBuV)	Correction Factor (dB/m)
1	*5320.00	121.8 PK			3.45 H	98	80.9	40.9
2	*5320.00	109.9 AV			3.45 H	98	69.0	40.9
3	5350.00	66.2 PK	74.0	-7.8	3.45 H	98	45.2	21.0
4	5350.00	53.5 AV	54.0	-0.5	3.45 H	98	32.5	21.0
5	10640.00	64.6 PK	74.0	-9.4	3.82 H	110	38.8	25.8
6	10640.00	49.4 AV	54.0	-4.6	3.82 H	110	23.6	25.8
Antenna Polarity & Test Distance : Vertical at 3 m								
No	Frequency (MHz)	Emission Level (dBuV/m)	Limit (dBuV/m)	Margin (dB)	Antenna Height (m)	Table Angle (Degree)	Raw Value (dBuV)	Correction Factor (dB/m)
1	*5320.00	122.3 PK			2.61 V	232	81.4	40.9
2	*5320.00	110.7 AV			2.61 V	232	69.8	40.9
3	5352.10	64.8 PK	74.0	-9.2	2.61 V	232	43.8	21.0
4	5352.10	53.1 AV	54.0	-0.9	2.61 V	232	32.1	21.0
5	10640.00	65.0 PK	74.0	-9.0	3.02 V	291	39.2	25.8
6	10640.00	49.7 AV	54.0	-4.3	3.02 V	291	23.9	25.8

Remarks:

1. Emission Level(dBuV/m) = Raw Value(dBuV) + Correction Factor(dB/m)
2. Correction Factor(dB/m) = Antenna Factor(dB/m) + Cable Factor(dB) – Pre-Amplifier Factor(dB)
3. Margin value = Emission Level – Limit value
4. The other emission levels were very low against the limit.
5. " * ": Fundamental frequency, the limit was restricted at the RF Output Power.



RF Mode	802.11ax (HE20)	Channel	CH 100 : 5500 MHz
Frequency Range	1 GHz ~ 40 GHz	Detector Function & Bandwidth	(PK) RB = 1 MHz, VB = 3 MHz (AV) RB = 1 MHz, VB = 10 Hz
Input Power	120 Vac, 60 Hz	Environmental Conditions	20.9°C, 76.8% RH
Tested By	Rex Wang/Adair Peng		

Antenna Polarity & Test Distance : Horizontal at 3 m								
No	Frequency (MHz)	Emission Level (dBuV/m)	Limit (dBuV/m)	Margin (dB)	Antenna Height (m)	Table Angle (Degree)	Raw Value (dBuV)	Correction Factor (dB/m)
1	5460.00	63.9 PK	74.0	-10.1	3.23 H	99	42.3	21.6
2	5460.00	51.2 AV	54.0	-2.8	3.23 H	99	29.6	21.6
3	#5470.00	67.1 PK	68.2	-1.1	3.23 H	99	45.5	21.6
4	*5500.00	120.0 PK			3.23 H	99	78.5	41.5
5	*5500.00	108.8 AV			3.23 H	99	67.3	41.5
6	11000.00	64.8 PK	74.0	-9.2	3.90 H	109	38.7	26.1
7	11000.00	48.8 AV	54.0	-5.2	3.90 H	109	22.7	26.1
Antenna Polarity & Test Distance : Vertical at 3 m								
No	Frequency (MHz)	Emission Level (dBuV/m)	Limit (dBuV/m)	Margin (dB)	Antenna Height (m)	Table Angle (Degree)	Raw Value (dBuV)	Correction Factor (dB/m)
1	5460.00	64.9 PK	74.0	-9.1	3.09 V	225	43.3	21.6
2	5460.00	51.3 AV	54.0	-2.7	3.09 V	225	29.7	21.6
3	#5470.00	67.2 PK	68.2	-1.0	3.09 V	225	45.6	21.6
4	*5500.00	121.6 PK			3.09 V	225	80.1	41.5
5	*5500.00	109.2 AV			3.09 V	225	67.7	41.5
6	11000.00	65.1 PK	74.0	-8.9	2.99 V	283	39.0	26.1
7	11000.00	49.5 AV	54.0	-4.5	2.99 V	283	23.4	26.1

Remarks:

1. Emission Level(dBuV/m) = Raw Value(dBuV) + Correction Factor(dB/m)
2. Correction Factor(dB/m) = Antenna Factor(dB/m) + Cable Factor(dB) – Pre-Amplifier Factor(dB)
3. Margin value = Emission Level – Limit value
4. The other emission levels were very low against the limit.
5. " * ": Fundamental frequency, the limit was restricted at the RF Output Power.
6. " # ": The radiated frequency is out of the restricted band.



RF Mode	802.11ax (HE20)	Channel	CH 116 : 5580 MHz
Frequency Range	1 GHz ~ 40 GHz	Detector Function & Bandwidth	(PK) RB = 1 MHz, VB = 3 MHz (AV) RB = 1 MHz, VB = 10 Hz
Input Power	120 Vac, 60 Hz	Environmental Conditions	20.9°C, 76.8% RH
Tested By	Rex Wang/Adair Peng		

Antenna Polarity & Test Distance : Horizontal at 3 m

No	Frequency (MHz)	Emission Level (dBuV/m)	Limit (dBuV/m)	Margin (dB)	Antenna Height (m)	Table Angle (Degree)	Raw Value (dBuV)	Correction Factor (dB/m)
1	*5580.00	121.5 PK			3.30 H	101	79.9	41.6
2	*5580.00	109.5 AV			3.30 H	101	67.9	41.6
3	11160.00	64.5 PK	74.0	-9.5	3.89 H	112	38.6	25.9
4	11160.00	48.7 AV	54.0	-5.3	3.89 H	112	22.8	25.9

Antenna Polarity & Test Distance : Vertical at 3 m

No	Frequency (MHz)	Emission Level (dBuV/m)	Limit (dBuV/m)	Margin (dB)	Antenna Height (m)	Table Angle (Degree)	Raw Value (dBuV)	Correction Factor (dB/m)
1	*5580.00	121.9 PK			3.09 V	223	80.3	41.6
2	*5580.00	109.9 AV			3.09 V	223	68.3	41.6
3	11160.00	65.0 PK	74.0	-9.0	2.89 V	278	39.1	25.9
4	11160.00	49.4 AV	54.0	-4.6	2.89 V	278	23.5	25.9

Remarks:

1. Emission Level(dBuV/m) = Raw Value(dBuV) + Correction Factor(dB/m)
2. Correction Factor(dB/m) = Antenna Factor(dB/m) + Cable Factor(dB) – Pre-Amplifier Factor(dB)
3. Margin value = Emission Level – Limit value
4. The other emission levels were very low against the limit.
5. " * " : Fundamental frequency, the limit was restricted at the RF Output Power.



RF Mode	802.11ax (HE20)	Channel	CH 140 : 5700 MHz
Frequency Range	1 GHz ~ 40 GHz	Detector Function & Bandwidth	(PK) RB = 1 MHz, VB = 3 MHz (AV) RB = 1 MHz, VB = 10 Hz
Input Power	120 Vac, 60 Hz	Environmental Conditions	20.9°C, 76.8% RH
Tested By	Rex Wang/Adair Peng		

Antenna Polarity & Test Distance : Horizontal at 3 m								
No	Frequency (MHz)	Emission Level (dBuV/m)	Limit (dBuV/m)	Margin (dB)	Antenna Height (m)	Table Angle (Degree)	Raw Value (dBuV)	Correction Factor (dB/m)
1	*5700.00	115.4 PK			3.17 H	101	73.7	41.7
2	*5700.00	103.9 AV			3.17 H	101	62.2	41.7
3	#5725.00	67.3 PK	68.2	-0.9	3.17 H	101	45.2	22.1
4	11400.00	65.7 PK	74.0	-8.3	3.95 H	112	38.3	27.4
5	11400.00	49.6 AV	54.0	-4.4	3.95 H	112	22.2	27.4

Antenna Polarity & Test Distance : Vertical at 3 m								
No	Frequency (MHz)	Emission Level (dBuV/m)	Limit (dBuV/m)	Margin (dB)	Antenna Height (m)	Table Angle (Degree)	Raw Value (dBuV)	Correction Factor (dB/m)
1	*5700.00	115.5 PK			2.89 V	215	73.8	41.7
2	*5700.00	104.7 AV			2.89 V	215	63.0	41.7
3	#5725.00	67.6 PK	68.2	-0.6	2.89 V	215	45.5	22.1
4	11400.00	66.0 PK	74.0	-8.0	2.89 V	288	38.6	27.4
5	11400.00	49.9 AV	54.0	-4.1	2.89 V	288	22.5	27.4

Remarks:

1. Emission Level(dBuV/m) = Raw Value(dBuV) + Correction Factor(dB/m)
2. Correction Factor(dB/m) = Antenna Factor(dB/m) + Cable Factor(dB) – Pre-Amplifier Factor(dB)
3. Margin value = Emission Level – Limit value
4. The other emission levels were very low against the limit.
5. " * " : Fundamental frequency, the limit was restricted at the RF Output Power.
6. " # " : The radiated frequency is out of the restricted band.

RF Mode	802.11ax (HE20)	Channel	CH 144 : 5720 MHz
Frequency Range	1 GHz ~ 40 GHz	Detector Function & Bandwidth	(PK) RB = 1 MHz, VB = 3 MHz (AV) RB = 1 MHz, VB = 10 Hz
Input Power	120 Vac, 60 Hz	Environmental Conditions	20.9°C, 76.8% RH
Tested By	Rex Wang/Adair Peng		

Antenna Polarity & Test Distance : Horizontal at 3 m								
No	Frequency (MHz)	Emission Level (dBuV/m)	Limit (dBuV/m)	Margin (dB)	Antenna Height (m)	Table Angle (Degree)	Raw Value (dBuV)	Correction Factor (dB/m)
1	#5470.00	62.4 PK	68.2	-5.8	3.23 H	103	40.8	21.6
2	*5720.00	121.5 PK			3.23 H	103	79.6	41.9
3	*5720.00	109.2 AV			3.23 H	103	67.3	41.9
4	#5850.00	61.5 PK	68.2	-6.7	3.23 H	103	38.9	22.6
5	11400.00	66.0 PK	74.0	-8.0	3.96 H	112	38.6	27.4
6	11400.00	49.7 AV	54.0	-4.3	3.96 H	112	22.3	27.4
Antenna Polarity & Test Distance : Vertical at 3 m								
No	Frequency (MHz)	Emission Level (dBuV/m)	Limit (dBuV/m)	Margin (dB)	Antenna Height (m)	Table Angle (Degree)	Raw Value (dBuV)	Correction Factor (dB/m)
1	#5470.00	63.1 PK	68.2	-5.1	3.21 V	218	41.5	21.6
2	*5720.00	122.2 PK			3.21 V	218	80.3	41.9
3	*5720.00	110.4 AV			3.21 V	218	68.5	41.9
4	#5850.00	62.3 PK	68.2	-5.9	3.21 V	218	39.7	22.6
5	11400.00	66.3 PK	74.0	-7.7	2.97 V	282	38.9	27.4
6	11400.00	50.0 AV	54.0	-4.0	2.97 V	282	22.6	27.4

Remarks:

1. Emission Level(dBuV/m) = Raw Value(dBuV) + Correction Factor(dB/m)
2. Correction Factor(dB/m) = Antenna Factor(dB/m) + Cable Factor(dB) – Pre-Amplifier Factor(dB)
3. Margin value = Emission Level – Limit value
4. The other emission levels were very low against the limit.
5. " * " : Fundamental frequency, the limit was restricted at the RF Output Power.
6. " # " : The radiated frequency is out of the restricted band.



RF Mode	802.11ax (HE40)	Channel	CH 54 : 5270 MHz
Frequency Range	1 GHz ~ 40 GHz	Detector Function & Bandwidth	(PK) RB = 1 MHz, VB = 3 MHz (AV) RB = 1 MHz, VB = 10 Hz
Input Power	120 Vac, 60 Hz	Environmental Conditions	20.9°C, 76.8% RH
Tested By	Rex Wang/Adair Peng		

Antenna Polarity & Test Distance : Horizontal at 3 m								
No	Frequency (MHz)	Emission Level (dBuV/m)	Limit (dBuV/m)	Margin (dB)	Antenna Height (m)	Table Angle (Degree)	Raw Value (dBuV)	Correction Factor (dB/m)
1	5150.00	60.7 PK	74.0	-13.3	3.85 H	98	39.8	20.9
2	5150.00	49.0 AV	54.0	-5.0	3.85 H	98	28.1	20.9
3	*5270.00	119.8 PK			3.85 H	98	79.0	40.8
4	*5270.00	106.8 AV			3.85 H	98	66.0	40.8
5	5350.00	69.5 PK	74.0	-4.5	3.85 H	98	48.5	21.0
6	5350.00	53.4 AV	54.0	-0.6	3.85 H	98	32.4	21.0
7	#10540.00	63.8 PK	68.2	-4.4	3.94 H	116	38.4	25.4
Antenna Polarity & Test Distance : Vertical at 3 m								
No	Frequency (MHz)	Emission Level (dBuV/m)	Limit (dBuV/m)	Margin (dB)	Antenna Height (m)	Table Angle (Degree)	Raw Value (dBuV)	Correction Factor (dB/m)
1	5150.00	61.2 PK	74.0	-12.8	2.69 V	232	40.3	20.9
2	5150.00	49.6 AV	54.0	-4.4	2.69 V	232	28.7	20.9
3	*5270.00	119.9 PK			2.69 V	232	79.1	40.8
4	*5270.00	107.3 AV			2.69 V	232	66.5	40.8
5	5352.00	69.7 PK	74.0	-4.3	2.69 V	232	48.7	21.0
6	5352.00	53.5 AV	54.0	-0.5	2.69 V	232	32.5	21.0
7	#10540.00	64.0 PK	68.2	-4.2	2.96 V	278	38.6	25.4

Remarks:

1. Emission Level(dBuV/m) = Raw Value(dBuV) + Correction Factor(dB/m)
2. Correction Factor(dB/m) = Antenna Factor(dB/m) + Cable Factor(dB) – Pre-Amplifier Factor(dB)
3. Margin value = Emission Level – Limit value
4. The other emission levels were very low against the limit.
5. " * " : Fundamental frequency, the limit was restricted at the RF Output Power.
6. " # " : The radiated frequency is out of the restricted band.

RF Mode	802.11ax (HE40)	Channel	CH 62 : 5310 MHz
Frequency Range	1 GHz ~ 40 GHz	Detector Function & Bandwidth	(PK) RB = 1 MHz, VB = 3 MHz (AV) RB = 1 MHz, VB = 10 Hz
Input Power	120 Vac, 60 Hz	Environmental Conditions	20.9°C, 76.8% RH
Tested By	Rex Wang/Adair Peng		

Antenna Polarity & Test Distance : Horizontal at 3 m								
No	Frequency (MHz)	Emission Level (dBuV/m)	Limit (dBuV/m)	Margin (dB)	Antenna Height (m)	Table Angle (Degree)	Raw Value (dBuV)	Correction Factor (dB/m)
1	*5310.00	117.9 PK			3.61 H	96	77.1	40.8
2	*5310.00	105.8 AV			3.61 H	96	65.0	40.8
3	5350.00	64.5 PK	74.0	-9.5	3.61 H	96	43.5	21.0
4	5350.00	53.1 AV	54.0	-0.9	3.61 H	96	32.1	21.0
5	10620.00	64.1 PK	74.0	-9.9	3.83 H	107	38.5	25.6
6	10620.00	49.2 AV	54.0	-4.8	3.83 H	107	23.6	25.6
Antenna Polarity & Test Distance : Vertical at 3 m								
No	Frequency (MHz)	Emission Level (dBuV/m)	Limit (dBuV/m)	Margin (dB)	Antenna Height (m)	Table Angle (Degree)	Raw Value (dBuV)	Correction Factor (dB/m)
1	*5310.00	118.0 PK			2.69 V	229	77.2	40.8
2	*5310.00	106.0 AV			2.69 V	229	65.2	40.8
3	5352.00	64.7 PK	74.0	-9.3	2.69 V	229	43.7	21.0
4	5352.00	53.2 AV	54.0	-0.8	2.69 V	229	32.2	21.0
5	10620.00	64.3 PK	74.0	-9.7	2.90 V	274	38.7	25.6
6	10620.00	49.4 AV	54.0	-4.6	2.90 V	274	23.8	25.6

Remarks:

1. Emission Level(dBuV/m) = Raw Value(dBuV) + Correction Factor(dB/m)
2. Correction Factor(dB/m) = Antenna Factor(dB/m) + Cable Factor(dB) – Pre-Amplifier Factor(dB)
3. Margin value = Emission Level – Limit value
4. The other emission levels were very low against the limit.
5. " * ": Fundamental frequency, the limit was restricted at the RF Output Power.

RF Mode	802.11ax (HE40)	Channel	CH 102 : 5510 MHz
Frequency Range	1 GHz ~ 40 GHz	Detector Function & Bandwidth	(PK) RB = 1 MHz, VB = 3 MHz (AV) RB = 1 MHz, VB = 10 Hz
Input Power	120 Vac, 60 Hz	Environmental Conditions	23°C, 67% RH
Tested By	Rex Wang/Adair Peng		

Antenna Polarity & Test Distance : Horizontal at 3 m								
No	Frequency (MHz)	Emission Level (dBuV/m)	Limit (dBuV/m)	Margin (dB)	Antenna Height (m)	Table Angle (Degree)	Raw Value (dBuV)	Correction Factor (dB/m)
1	5460.00	63.6 PK	74.0	-10.4	3.20 H	98	42.0	21.6
2	5460.00	50.9 AV	54.0	-3.1	3.20 H	98	29.3	21.6
3	#5470.00	67.3 PK	68.2	-0.9	3.20 H	98	45.7	21.6
4	*5510.00	116.5 PK			3.20 H	98	75.0	41.5
5	*5510.00	104.3 AV			3.20 H	98	62.8	41.5
6	11020.00	64.0 PK	74.0	-10.0	3.88 H	119	37.8	26.2
7	11020.00	49.7 AV	54.0	-4.3	3.88 H	119	23.5	26.2
Antenna Polarity & Test Distance : Vertical at 3 m								
No	Frequency (MHz)	Emission Level (dBuV/m)	Limit (dBuV/m)	Margin (dB)	Antenna Height (m)	Table Angle (Degree)	Raw Value (dBuV)	Correction Factor (dB/m)
1	5460.00	63.8 PK	74.0	-10.2	3.23 V	221	42.2	21.6
2	5460.00	51.0 AV	54.0	-3.0	3.23 V	221	29.4	21.6
3	#5470.00	67.5 PK	68.2	-0.7	3.23 V	221	45.9	21.6
4	*5510.00	116.8 PK			3.23 V	221	75.3	41.5
5	*5510.00	104.4 AV			3.23 V	221	62.9	41.5
6	11020.00	64.1 PK	74.0	-9.9	2.85 V	291	37.9	26.2
7	11020.00	49.8 AV	54.0	-4.2	2.85 V	291	23.6	26.2

Remarks:

1. Emission Level(dBuV/m) = Raw Value(dBuV) + Correction Factor(dB/m)
2. Correction Factor(dB/m) = Antenna Factor(dB/m) + Cable Factor(dB) – Pre-Amplifier Factor(dB)
3. Margin value = Emission Level – Limit value
4. The other emission levels were very low against the limit.
5. " * " : Fundamental frequency, the limit was restricted at the RF Output Power.
6. " # " : The radiated frequency is out of the restricted band.



RF Mode	802.11ax (HE40)	Channel	CH 110 : 5550 MHz
Frequency Range	1 GHz ~ 40 GHz	Detector Function & Bandwidth	(PK) RB = 1 MHz, VB = 3 MHz (AV) RB = 1 MHz, VB = 10 Hz
Input Power	120 Vac, 60 Hz	Environmental Conditions	23°C, 67% RH
Tested By	Rex Wang/Adair Peng		

Antenna Polarity & Test Distance : Horizontal at 3 m								
No	Frequency (MHz)	Emission Level (dBuV/m)	Limit (dBuV/m)	Margin (dB)	Antenna Height (m)	Table Angle (Degree)	Raw Value (dBuV)	Correction Factor (dB/m)
1	5460.00	63.2 PK	74.0	-10.8	3.23 H	102	41.6	21.6
2	5460.00	49.7 AV	54.0	-4.3	3.23 H	102	28.1	21.6
3	#5470.00	67.1 PK	68.2	-1.1	3.23 H	102	45.5	21.6
4	*5550.00	117.3 PK			3.23 H	102	75.8	41.5
5	*5550.00	104.8 AV			3.23 H	102	63.3	41.5
6	11100.00	64.0 PK	74.0	-10.0	3.91 H	120	38.0	26.0
7	11100.00	49.5 AV	54.0	-4.5	3.91 H	120	23.5	26.0
Antenna Polarity & Test Distance : Vertical at 3 m								
No	Frequency (MHz)	Emission Level (dBuV/m)	Limit (dBuV/m)	Margin (dB)	Antenna Height (m)	Table Angle (Degree)	Raw Value (dBuV)	Correction Factor (dB/m)
1	5460.00	63.4 PK	74.0	-10.6	3.17 V	224	41.8	21.6
2	5460.00	49.9 AV	54.0	-4.1	3.17 V	224	28.3	21.6
3	#5470.00	67.4 PK	68.2	-0.8	3.17 V	224	45.8	21.6
4	*5550.00	117.9 PK			3.17 V	224	76.4	41.5
5	*5550.00	105.6 AV			3.17 V	224	64.1	41.5
6	11100.00	64.2 PK	74.0	-9.8	2.90 V	288	38.2	26.0
7	11100.00	49.7 AV	54.0	-4.3	2.90 V	288	23.7	26.0

Remarks:

1. Emission Level(dBuV/m) = Raw Value(dBuV) + Correction Factor(dB/m)
2. Correction Factor(dB/m) = Antenna Factor(dB/m) + Cable Factor(dB) – Pre-Amplifier Factor(dB)
3. Margin value = Emission Level – Limit value
4. The other emission levels were very low against the limit.
5. " * " : Fundamental frequency, the limit was restricted at the RF Output Power.
6. " # " : The radiated frequency is out of the restricted band.



RF Mode	802.11ax (HE40)	Channel	CH 134 : 5670 MHz
Frequency Range	1 GHz ~ 40 GHz	Detector Function & Bandwidth	(PK) RB = 1 MHz, VB = 3 MHz (AV) RB = 1 MHz, VB = 10 Hz
Input Power	120 Vac, 60 Hz	Environmental Conditions	23°C, 67% RH
Tested By	Rex Wang/Adair Peng		

Antenna Polarity & Test Distance : Horizontal at 3 m

No	Frequency (MHz)	Emission Level (dBuV/m)	Limit (dBuV/m)	Margin (dB)	Antenna Height (m)	Table Angle (Degree)	Raw Value (dBuV)	Correction Factor (dB/m)
1	*5670.00	114.7 PK			3.23 H	100	73.0	41.7
2	*5670.00	102.8 AV			3.23 H	100	61.1	41.7
3	#5725.00	67.3 PK	68.2	-0.9	3.23 H	100	45.2	22.1
4	11340.00	64.4 PK	74.0	-9.6	3.79 H	117	37.7	26.7
5	11340.00	50.0 AV	54.0	-4.0	3.79 H	117	23.3	26.7

Antenna Polarity & Test Distance : Vertical at 3 m

No	Frequency (MHz)	Emission Level (dBuV/m)	Limit (dBuV/m)	Margin (dB)	Antenna Height (m)	Table Angle (Degree)	Raw Value (dBuV)	Correction Factor (dB/m)
1	*5670.00	115.5 PK			3.19 V	219	73.8	41.7
2	*5670.00	103.5 AV			3.19 V	219	61.8	41.7
3	#5725.00	67.6 PK	68.2	-0.6	3.19 V	219	45.5	22.1
4	11340.00	64.6 PK	74.0	-9.4	2.93 V	290	37.9	26.7
5	11340.00	50.1 AV	54.0	-3.9	2.93 V	290	23.4	26.7

Remarks:

1. Emission Level(dBuV/m) = Raw Value(dBuV) + Correction Factor(dB/m)
2. Correction Factor(dB/m) = Antenna Factor(dB/m) + Cable Factor(dB) – Pre-Amplifier Factor(dB)
3. Margin value = Emission Level – Limit value
4. The other emission levels were very low against the limit.
5. " * " : Fundamental frequency, the limit was restricted at the RF Output Power.
6. " # " : The radiated frequency is out of the restricted band.



RF Mode	802.11ax (HE40)	Channel	CH 142 : 5710 MHz
Frequency Range	1 GHz ~ 40 GHz	Detector Function & Bandwidth	(PK) RB = 1 MHz, VB = 3 MHz (AV) RB = 1 MHz, VB = 10 Hz
Input Power	120 Vac, 60 Hz	Environmental Conditions	23°C, 67% RH
Tested By	Rex Wang/Adair Peng		

Antenna Polarity & Test Distance : Horizontal at 3 m								
No	Frequency (MHz)	Emission Level (dBuV/m)	Limit (dBuV/m)	Margin (dB)	Antenna Height (m)	Table Angle (Degree)	Raw Value (dBuV)	Correction Factor (dB/m)
1	#5470.00	62.8 PK	68.2	-5.4	3.12 H	99	41.2	21.6
2	*5710.00	118.4 PK			3.12 H	99	76.6	41.8
3	*5710.00	106.0 AV			3.12 H	99	64.2	41.8
4	#5850.00	62.3 PK	68.2	-5.9	3.12 H	99	39.7	22.6
5	11420.00	65.4 PK	74.0	-8.6	3.87 H	118	38.0	27.4
6	11420.00	50.0 AV	54.0	-4.0	3.87 H	118	22.6	27.4
Antenna Polarity & Test Distance : Vertical at 3 m								
No	Frequency (MHz)	Emission Level (dBuV/m)	Limit (dBuV/m)	Margin (dB)	Antenna Height (m)	Table Angle (Degree)	Raw Value (dBuV)	Correction Factor (dB/m)
1	#5470.00	62.9 PK	68.2	-5.3	3.20 V	219	41.3	21.6
2	*5710.00	119.7 PK			3.20 V	219	77.9	41.8
3	*5710.00	107.1 AV			3.20 V	219	65.3	41.8
4	#5850.00	62.4 PK	68.2	-5.8	3.20 V	219	39.8	22.6
5	11420.00	65.7 PK	74.0	-8.3	2.85 V	292	38.3	27.4
6	11420.00	50.2 AV	54.0	-3.8	2.85 V	292	22.8	27.4

Remarks:

1. Emission Level(dBuV/m) = Raw Value(dBuV) + Correction Factor(dB/m)
2. Correction Factor(dB/m) = Antenna Factor(dB/m) + Cable Factor(dB) – Pre-Amplifier Factor(dB)
3. Margin value = Emission Level – Limit value
4. The other emission levels were very low against the limit.
5. " * " : Fundamental frequency, the limit was restricted at the RF Output Power.
6. " # " : The radiated frequency is out of the restricted band.

RF Mode	802.11ax (HE80)	Channel	CH 58 : 5290 MHz
Frequency Range	1 GHz ~ 40 GHz	Detector Function & Bandwidth	(PK) RB = 1 MHz, VB = 3 MHz (AV) RB = 1 MHz, VB = 10 Hz
Input Power	120 Vac, 60 Hz	Environmental Conditions	20.9°C, 76.8% RH
Tested By	Rex Wang/Adair Peng		

Antenna Polarity & Test Distance : Horizontal at 3 m								
No	Frequency (MHz)	Emission Level (dBuV/m)	Limit (dBuV/m)	Margin (dB)	Antenna Height (m)	Table Angle (Degree)	Raw Value (dBuV)	Correction Factor (dB/m)
1	*5290.00	115.2 PK			3.75 H	99	74.4	40.8
2	*5290.00	102.6 AV			3.75 H	99	61.8	40.8
3	5359.70	64.2 PK	74.0	-9.8	3.75 H	99	43.2	21.0
4	5359.70	52.4 AV	54.0	-1.6	3.75 H	99	31.4	21.0
5	#10580.00	63.6 PK	68.2	-4.6	3.92 H	115	38.2	25.4

Antenna Polarity & Test Distance : Vertical at 3 m								
No	Frequency (MHz)	Emission Level (dBuV/m)	Limit (dBuV/m)	Margin (dB)	Antenna Height (m)	Table Angle (Degree)	Raw Value (dBuV)	Correction Factor (dB/m)
1	*5290.00	116.0 PK			2.75 V	229	75.2	40.8
2	*5290.00	103.1 AV			2.75 V	229	62.3	40.8
3	5352.00	64.5 PK	74.0	-9.5	2.75 V	229	43.5	21.0
4	5352.00	53.0 AV	54.0	-1.0	2.75 V	229	32.0	21.0
5	#10580.00	63.9 PK	68.2	-4.3	3.05 V	288	38.5	25.4

Remarks:

1. Emission Level(dBuV/m) = Raw Value(dBuV) + Correction Factor(dB/m)
2. Correction Factor(dB/m) = Antenna Factor(dB/m) + Cable Factor(dB) – Pre-Amplifier Factor(dB)
3. Margin value = Emission Level – Limit value
4. The other emission levels were very low against the limit.
5. " * " : Fundamental frequency, the limit was restricted at the RF Output Power.
6. " # " : The radiated frequency is out of the restricted band.



RF Mode	802.11ax (HE80)	Channel	CH 106 : 5530 MHz
Frequency Range	1 GHz ~ 40 GHz	Detector Function & Bandwidth	(PK) RB = 1 MHz, VB = 3 MHz (AV) RB = 1 MHz, VB = 10 Hz
Input Power	120 Vac, 60 Hz	Environmental Conditions	23°C, 67% RH
Tested By	Rex Wang/Adair Peng		

Antenna Polarity & Test Distance : Horizontal at 3 m

No	Frequency (MHz)	Emission Level (dBuV/m)	Limit (dBuV/m)	Margin (dB)	Antenna Height (m)	Table Angle (Degree)	Raw Value (dBuV)	Correction Factor (dB/m)
1	5460.00	65.6 PK	74.0	-8.4	3.25 H	101	44.0	21.6
2	5460.00	53.1 AV	54.0	-0.9	3.25 H	101	31.5	21.6
3	#5470.00	67.1 PK	68.2	-1.1	3.25 H	101	45.5	21.6
4	*5530.00	112.1 PK			3.25 H	101	70.6	41.5
5	*5530.00	100.1 AV			3.25 H	101	58.6	41.5
6	11060.00	63.7 PK	74.0	-10.3	3.86 H	117	37.6	26.1
7	11060.00	48.8 AV	54.0	-5.2	3.86 H	117	22.7	26.1

Antenna Polarity & Test Distance : Vertical at 3 m

No	Frequency (MHz)	Emission Level (dBuV/m)	Limit (dBuV/m)	Margin (dB)	Antenna Height (m)	Table Angle (Degree)	Raw Value (dBuV)	Correction Factor (dB/m)
1	5460.00	67.0 PK	74.0	-7.0	3.16 V	225	45.4	21.6
2	5460.00	53.3 AV	54.0	-0.7	3.16 V	225	31.7	21.6
3	#5470.00	67.3 PK	68.2	-0.9	3.16 V	225	45.7	21.6
4	*5530.00	112.9 PK			3.16 V	225	71.4	41.5
5	*5530.00	100.9 AV			3.16 V	225	59.4	41.5
6	11060.00	64.1 PK	74.0	-9.9	2.92 V	296	38.0	26.1
7	11060.00	49.1 AV	54.0	-4.9	2.92 V	296	23.0	26.1

Remarks:

1. Emission Level(dBuV/m) = Raw Value(dBuV) + Correction Factor(dB/m)
2. Correction Factor(dB/m) = Antenna Factor(dB/m) + Cable Factor(dB) – Pre-Amplifier Factor(dB)
3. Margin value = Emission Level – Limit value
4. The other emission levels were very low against the limit.
5. " * ": Fundamental frequency, the limit was restricted at the RF Output Power.
6. " # ": The radiated frequency is out of the restricted band.

RF Mode	802.11ax (HE80)	Channel	CH 122 : 5610 MHz
Frequency Range	1 GHz ~ 40 GHz	Detector Function & Bandwidth	(PK) RB = 1 MHz, VB = 3 MHz (AV) RB = 1 MHz, VB = 10 Hz
Input Power	120 Vac, 60 Hz	Environmental Conditions	23°C, 67% RH
Tested By	Rex Wang/Adair Peng		

Antenna Polarity & Test Distance : Horizontal at 3 m								
No	Frequency (MHz)	Emission Level (dBuV/m)	Limit (dBuV/m)	Margin (dB)	Antenna Height (m)	Table Angle (Degree)	Raw Value (dBuV)	Correction Factor (dB/m)
1	*5610.00	113.3 PK			3.26 H	105	71.7	41.6
2	*5610.00	101.4 AV			3.26 H	105	59.8	41.6
3	#5725.00	67.1 PK	68.2	-1.1	3.26 H	105	45.0	22.1
4	11220.00	64.1 PK	74.0	-9.9	3.82 H	117	37.9	26.2
5	11220.00	49.0 AV	54.0	-5.0	3.82 H	117	22.8	26.2

Antenna Polarity & Test Distance : Vertical at 3 m								
No	Frequency (MHz)	Emission Level (dBuV/m)	Limit (dBuV/m)	Margin (dB)	Antenna Height (m)	Table Angle (Degree)	Raw Value (dBuV)	Correction Factor (dB/m)
1	*5610.00	115.2 PK			3.20 V	218	73.6	41.6
2	*5610.00	102.2 AV			3.20 V	218	60.6	41.6
3	#5725.00	67.4 PK	68.2	-0.8	3.20 V	218	45.3	22.1
4	11220.00	64.4 PK	74.0	-9.6	2.90 V	301	38.2	26.2
5	11220.00	49.3 AV	54.0	-4.7	2.90 V	301	23.1	26.2

Remarks:

1. Emission Level(dBuV/m) = Raw Value(dBuV) + Correction Factor(dB/m)
2. Correction Factor(dB/m) = Antenna Factor(dB/m) + Cable Factor(dB) – Pre-Amplifier Factor(dB)
3. Margin value = Emission Level – Limit value
4. The other emission levels were very low against the limit.
5. " * ": Fundamental frequency, the limit was restricted at the RF Output Power.
6. " # ": The radiated frequency is out of the restricted band.



RF Mode	802.11ax (HE80)	Channel	CH 138 : 5690 MHz
Frequency Range	1 GHz ~ 40 GHz	Detector Function & Bandwidth	(PK) RB = 1 MHz, VB = 3 MHz (AV) RB = 1 MHz, VB = 10 Hz
Input Power	120 Vac, 60 Hz	Environmental Conditions	23°C, 67% RH
Tested By	Rex Wang/Adair Peng		

Antenna Polarity & Test Distance : Horizontal at 3 m

No	Frequency (MHz)	Emission Level (dBuV/m)	Limit (dBuV/m)	Margin (dB)	Antenna Height (m)	Table Angle (Degree)	Raw Value (dBuV)	Correction Factor (dB/m)
1	#5470.00	63.2 PK	68.2	-5.0	3.25 H	103	41.6	21.6
2	*5690.00	115.5 PK			3.25 H	103	73.8	41.7
3	*5690.00	103.9 AV			3.25 H	103	62.2	41.7
4	#5850.00	66.9 PK	68.2	-1.3	3.25 H	103	44.3	22.6
5	11380.00	65.2 PK	74.0	-8.8	3.86 H	116	38.0	27.2
6	11380.00	49.9 AV	54.0	-4.1	3.86 H	116	22.7	27.2

Antenna Polarity & Test Distance : Vertical at 3 m

No	Frequency (MHz)	Emission Level (dBuV/m)	Limit (dBuV/m)	Margin (dB)	Antenna Height (m)	Table Angle (Degree)	Raw Value (dBuV)	Correction Factor (dB/m)
1	#5470.00	63.4 PK	68.2	-4.8	2.99 V	217	41.8	21.6
2	*5690.00	116.8 PK			2.99 V	217	75.1	41.7
3	*5690.00	104.7 AV			2.99 V	217	63.0	41.7
4	#5850.00	67.6 PK	68.2	-0.6	2.99 V	217	45.0	22.6
5	11380.00	65.5 PK	74.0	-8.5	2.87 V	295	38.3	27.2
6	11380.00	50.2 AV	54.0	-3.8	2.87 V	295	23.0	27.2

Remarks:

1. Emission Level(dBuV/m) = Raw Value(dBuV) + Correction Factor(dB/m)
2. Correction Factor(dB/m) = Antenna Factor(dB/m) + Cable Factor(dB) – Pre-Amplifier Factor(dB)
3. Margin value = Emission Level – Limit value
4. The other emission levels were very low against the limit.
5. " * " : Fundamental frequency, the limit was restricted at the RF Output Power.
6. " # " : The radiated frequency is out of the restricted band.



RF Mode	802.11ax (HE160)	Channel	CH 50 : 5250 MHz
Frequency Range	1 GHz ~ 40 GHz	Detector Function & Bandwidth	(PK) RB = 1 MHz, VB = 3 MHz (AV) RB = 1 MHz, VB = 10 Hz
Input Power	120 Vac, 60 Hz	Environmental Conditions	20.9°C, 76.8% RH
Tested By	Rex Wang/Adair Peng		

Antenna Polarity & Test Distance : Horizontal at 3 m								
No	Frequency (MHz)	Emission Level (dBuV/m)	Limit (dBuV/m)	Margin (dB)	Antenna Height (m)	Table Angle (Degree)	Raw Value (dBuV)	Correction Factor (dB/m)
1	5150.00	65.0 PK	74.0	-9.0	3.70 H	101	44.1	20.9
2	5150.00	52.7 AV	54.0	-1.3	3.70 H	101	31.8	20.9
3	*5250.00	110.4 PK			3.70 H	101	69.6	40.8
4	*5250.00	97.6 AV			3.70 H	101	56.8	40.8
5	5384.90	70.8 PK	74.0	-3.2	3.70 H	101	49.5	21.3
6	5384.90	51.6 AV	54.0	-2.4	3.70 H	101	30.3	21.3
7	#10500.00	63.5 PK	68.2	-4.7	3.86 H	114	38.3	25.2
Antenna Polarity & Test Distance : Vertical at 3 m								
No	Frequency (MHz)	Emission Level (dBuV/m)	Limit (dBuV/m)	Margin (dB)	Antenna Height (m)	Table Angle (Degree)	Raw Value (dBuV)	Correction Factor (dB/m)
1	5147.00	65.1 PK	74.0	-8.9	2.64 V	231	44.2	20.9
2	5147.00	53.2 AV	54.0	-0.8	2.64 V	231	32.3	20.9
3	*5250.00	110.5 PK			2.64 V	231	69.7	40.8
4	*5250.00	97.8 AV			2.64 V	231	57.0	40.8
5	5351.80	71.0 PK	74.0	-3.0	2.64 V	231	50.0	21.0
6	5351.80	52.0 AV	54.0	-2.0	2.64 V	231	31.0	21.0
7	#10500.00	63.7 PK	68.2	-4.5	2.99 V	286	38.5	25.2

Remarks:

1. Emission Level(dBuV/m) = Raw Value(dBuV) + Correction Factor(dB/m)
2. Correction Factor(dB/m) = Antenna Factor(dB/m) + Cable Factor(dB) – Pre-Amplifier Factor(dB)
3. Margin value = Emission Level – Limit value
4. The other emission levels were very low against the limit.
5. " * " : Fundamental frequency, the limit was restricted at the RF Output Power.
6. " # " : The radiated frequency is out of the restricted band.



RF Mode	802.11ax (HE160)	Channel	CH 114 : 5570 MHz
Frequency Range	1 GHz ~ 40 GHz	Detector Function & Bandwidth	(PK) RB = 1 MHz, VB = 3 MHz (AV) RB = 1 MHz, VB = 10 Hz
Input Power	120 Vac, 60 Hz	Environmental Conditions	23°C, 67% RH
Tested By	Rex Wang/Adair Peng		

Antenna Polarity & Test Distance : Horizontal at 3 m

No	Frequency (MHz)	Emission Level (dBuV/m)	Limit (dBuV/m)	Margin (dB)	Antenna Height (m)	Table Angle (Degree)	Raw Value (dBuV)	Correction Factor (dB/m)
1	5460.00	64.5 PK	74.0	-9.5	3.39 H	104	42.9	21.6
2	5460.00	51.6 AV	54.0	-2.4	3.39 H	104	30.0	21.6
3	#5470.00	67.1 PK	68.2	-1.1	3.39 H	104	45.5	21.6
4	*5570.00	107.4 PK			3.39 H	104	65.8	41.6
5	*5570.00	95.4 AV			3.39 H	104	53.8	41.6
6	#5725.00	63.0 PK	68.2	-5.2	3.39 H	104	40.9	22.1
7	11140.00	63.8 PK	74.0	-10.2	3.81 H	118	37.7	26.1
8	11140.00	48.9 AV	54.0	-5.1	3.81 H	118	22.8	26.1

Antenna Polarity & Test Distance : Vertical at 3 m

No	Frequency (MHz)	Emission Level (dBuV/m)	Limit (dBuV/m)	Margin (dB)	Antenna Height (m)	Table Angle (Degree)	Raw Value (dBuV)	Correction Factor (dB/m)
1	5460.00	64.8 PK	74.0	-9.2	3.02 V	226	43.2	21.6
2	5460.00	51.8 AV	54.0	-2.2	3.02 V	226	30.2	21.6
3	#5470.00	67.6 PK	68.2	-0.6	3.02 V	226	46.0	21.6
4	*5570.00	108.9 PK			3.02 V	226	67.3	41.6
5	*5570.00	96.1 AV			3.02 V	226	54.5	41.6
6	#5725.00	63.3 PK	68.2	-4.9	3.02 V	226	41.2	22.1
7	11140.00	64.1 PK	74.0	-9.9	2.88 V	289	38.0	26.1
8	11140.00	49.0 AV	54.0	-5.0	2.88 V	289	22.9	26.1

Remarks:

1. Emission Level(dBuV/m) = Raw Value(dBuV) + Correction Factor(dB/m)
2. Correction Factor(dB/m) = Antenna Factor(dB/m) + Cable Factor(dB) – Pre-Amplifier Factor(dB)
3. Margin value = Emission Level – Limit value
4. The other emission levels were very low against the limit.
5. " * " : Fundamental frequency, the limit was restricted at the RF Output Power.
6. " # " : The radiated frequency is out of the restricted band.

Plot of Band Edge

802.11a Channel 52

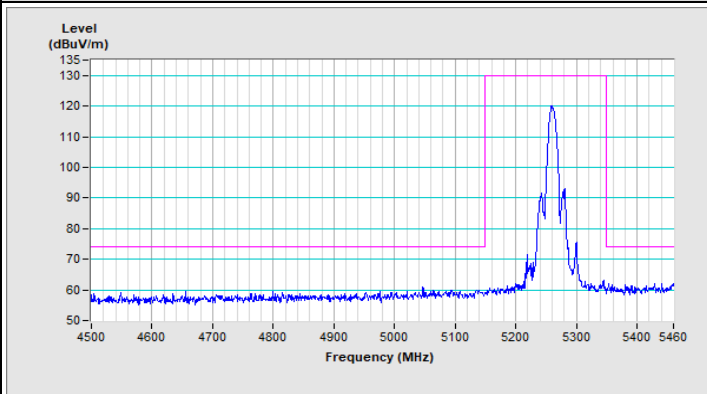

Horizontal (Peak)

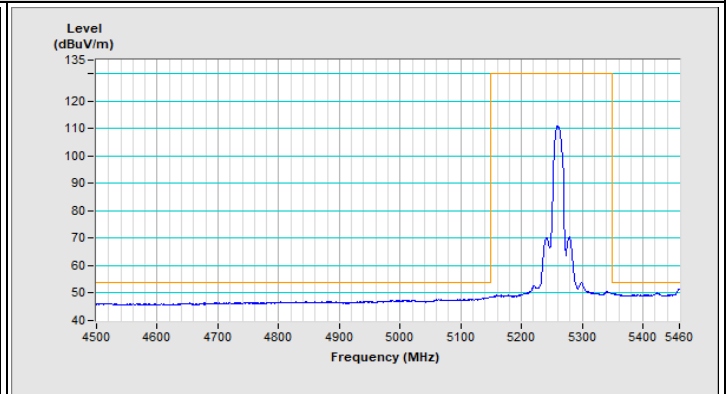

Horizontal (Average)

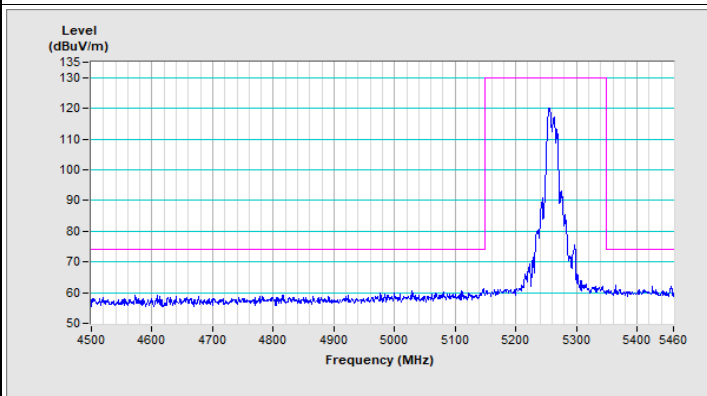

Vertical (Peak)

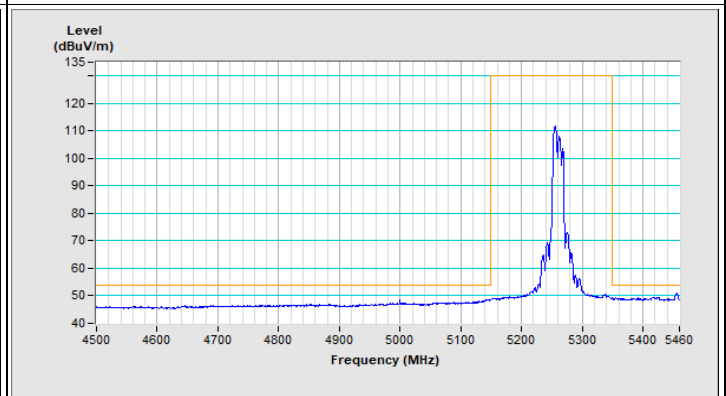

Vertical (Average)

802.11a Channel 64

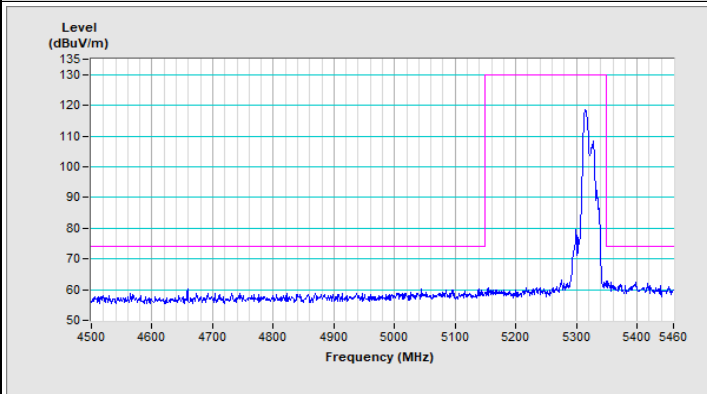

Horizontal (Peak)

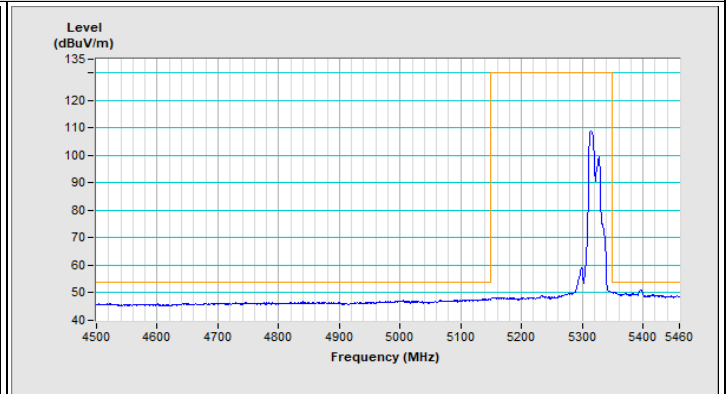

Horizontal (Average)

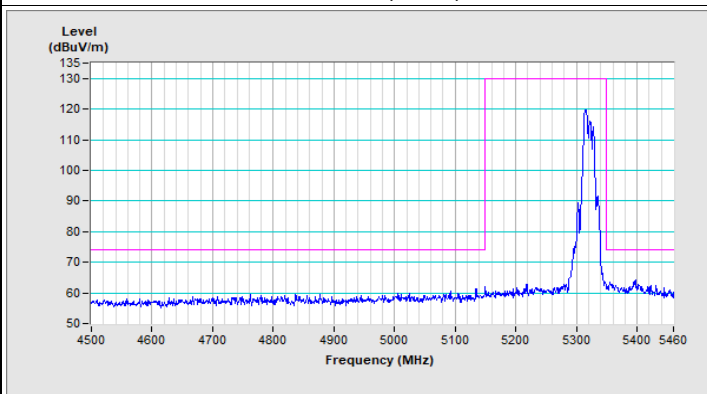

Vertical (Peak)

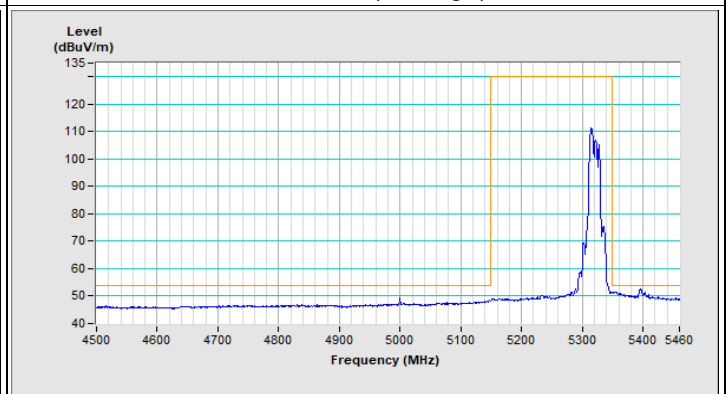

Vertical (Average)

802.11a Channel 100

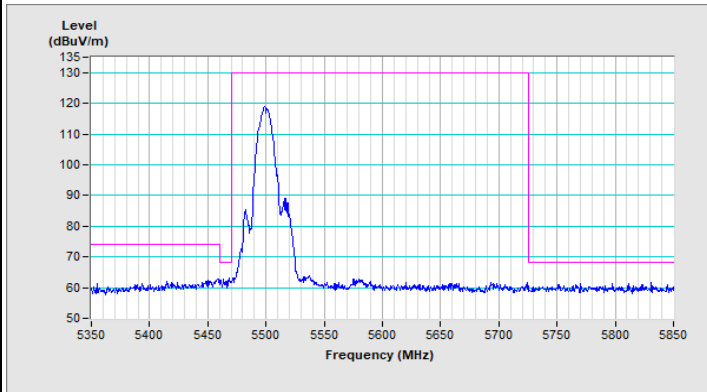

Horizontal (Peak)

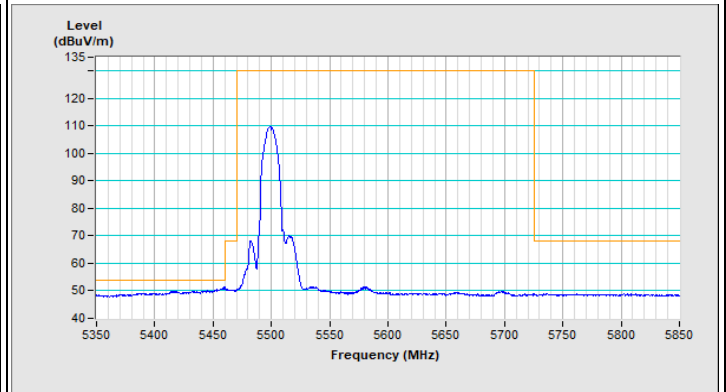

Horizontal (Average)

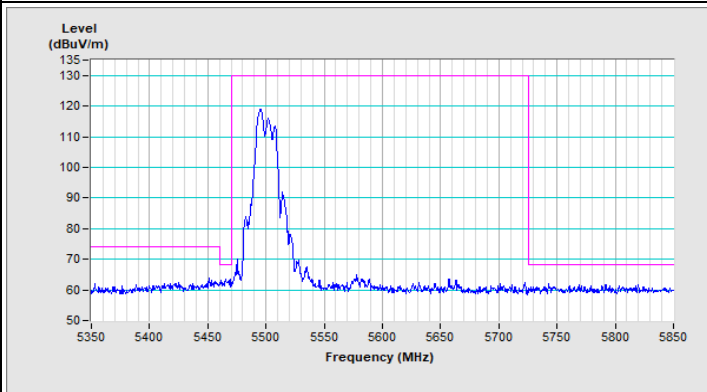

Vertical (Peak)

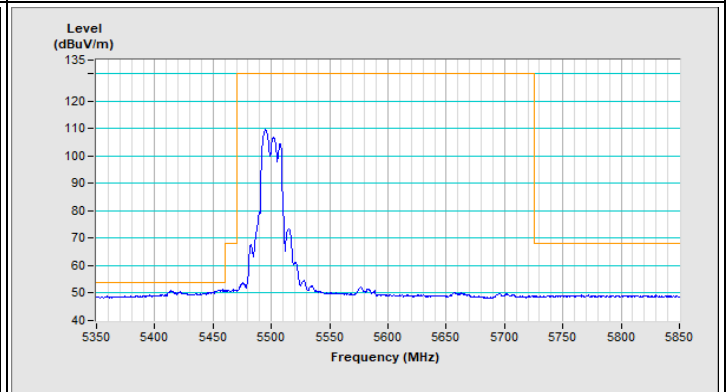

Vertical (Average)

802.11a Channel 140

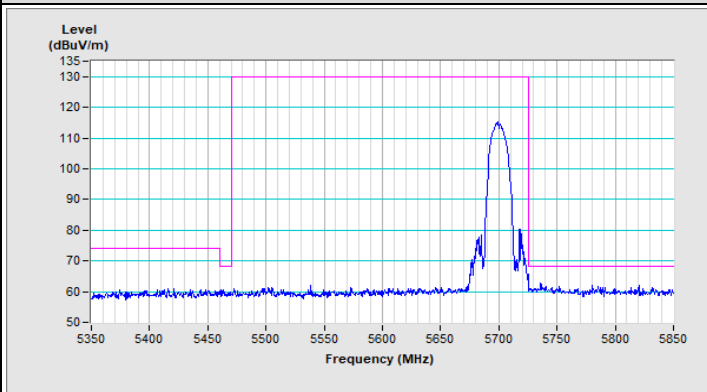

Horizontal (Peak)

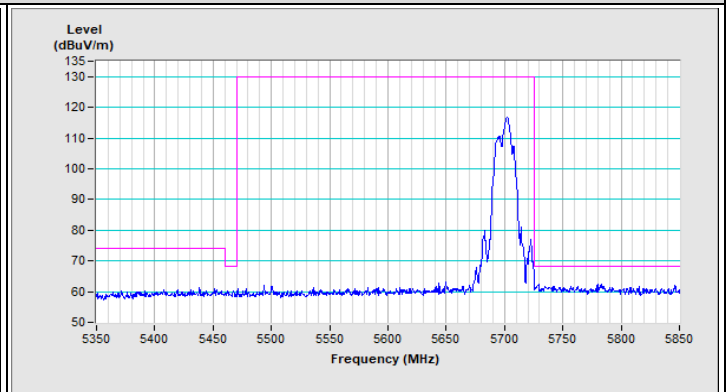

Vertical (Peak)

802.11a Channel 144

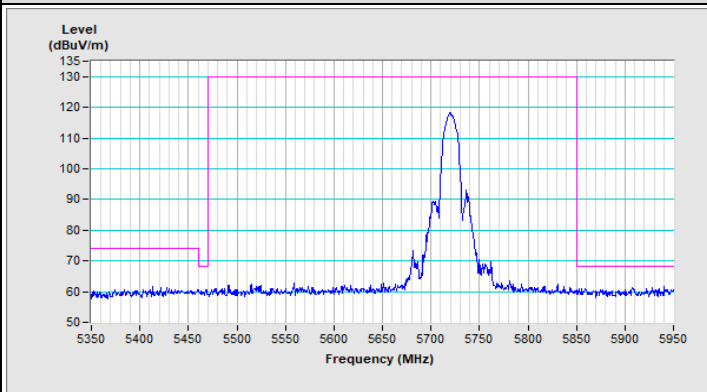

Horizontal (Peak)

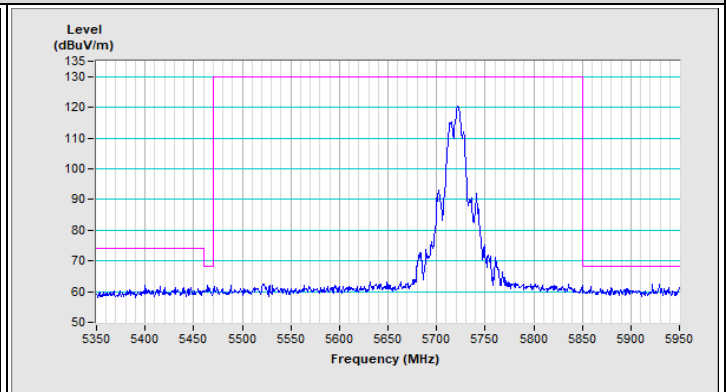

Vertical (Peak)

802.11ax (HE20) Channel 52

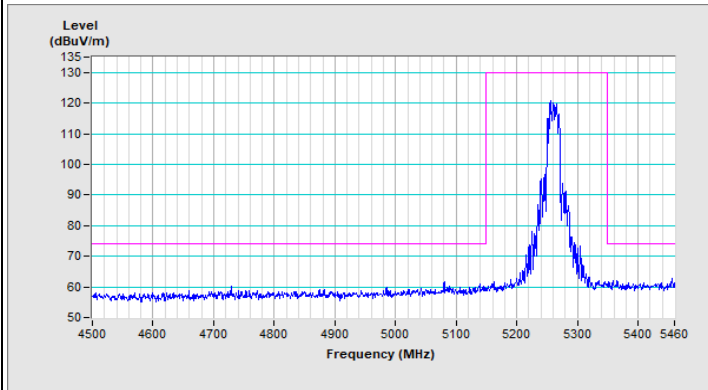

Horizontal (Peak)

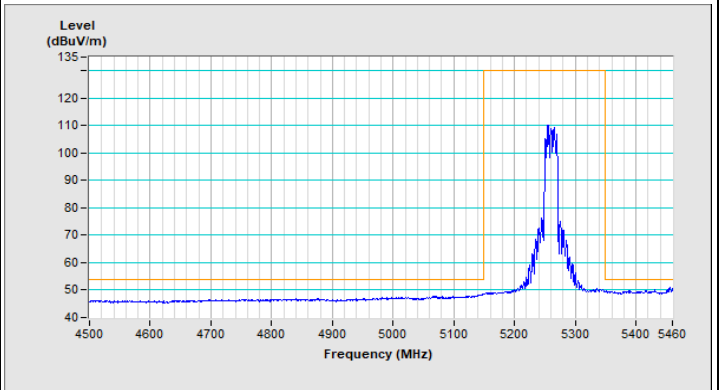

Horizontal (Average)

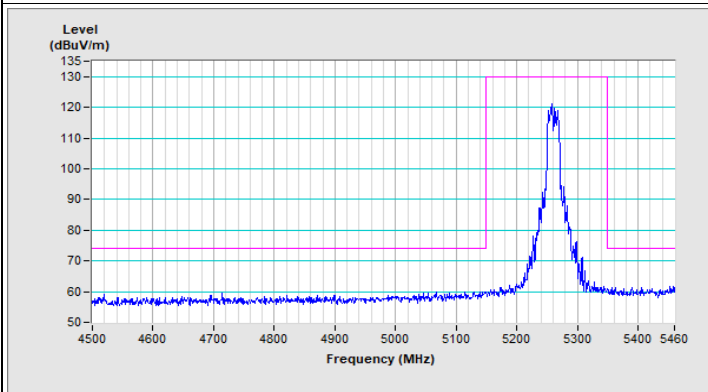

Vertical (Peak)

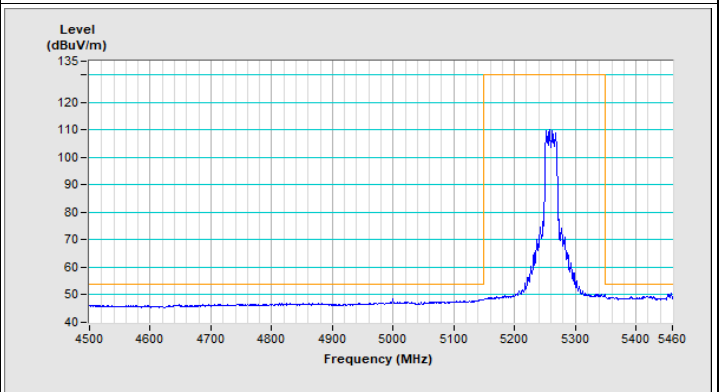

Vertical (Average)

802.11ax (HE20) Channel 64

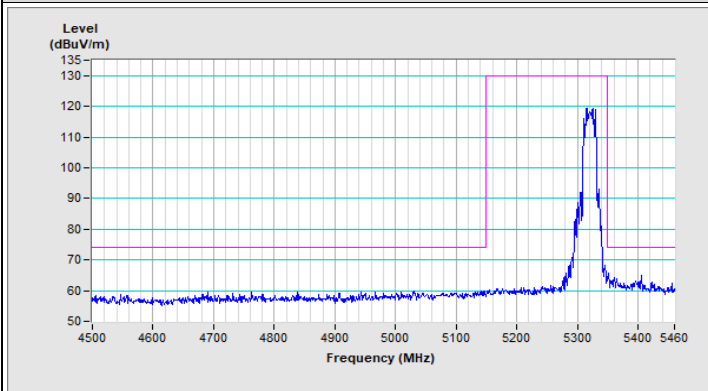

Horizontal (Peak)

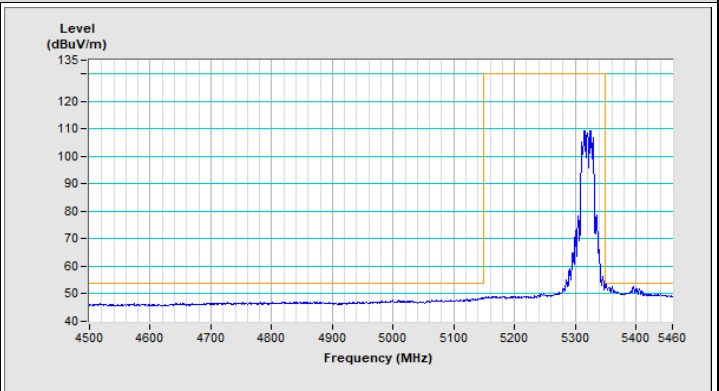

Horizontal (Average)

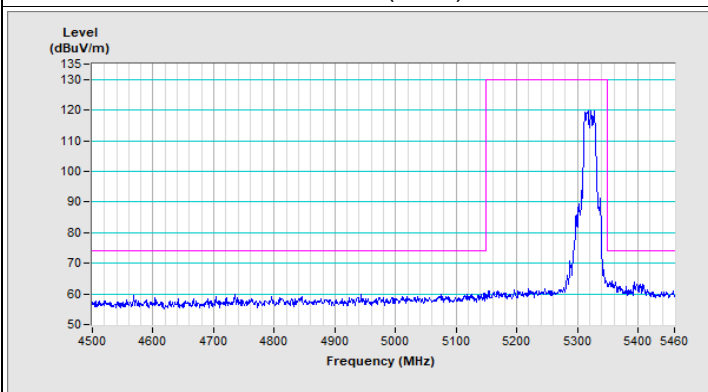

Vertical (Peak)

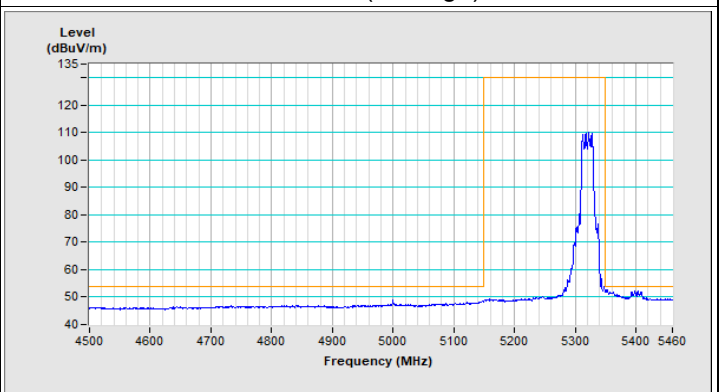

Vertical (Average)

802.11ax (HE20) Channel 100

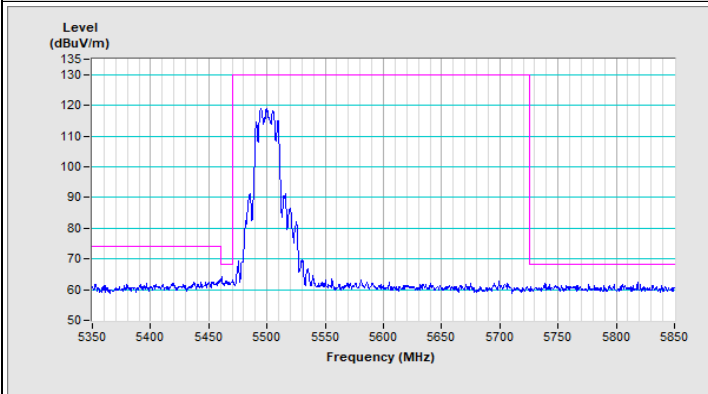

Horizontal (Peak)

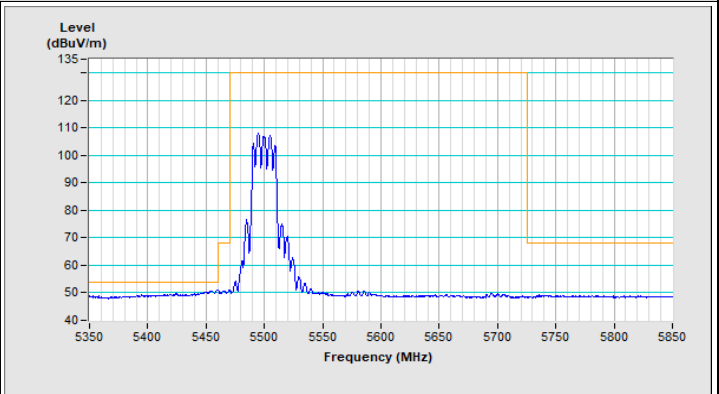

Horizontal (Average)

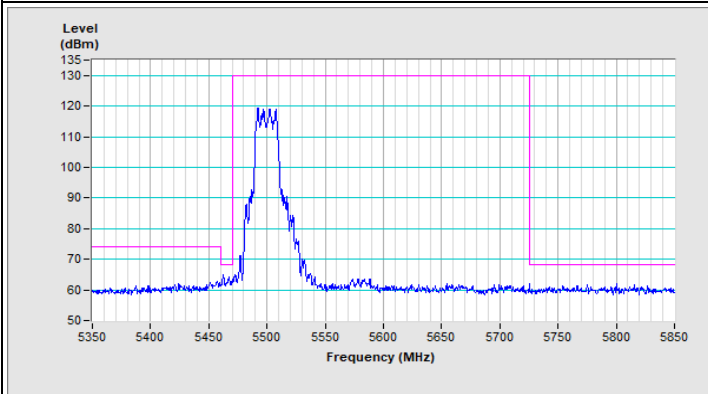

Vertical (Peak)

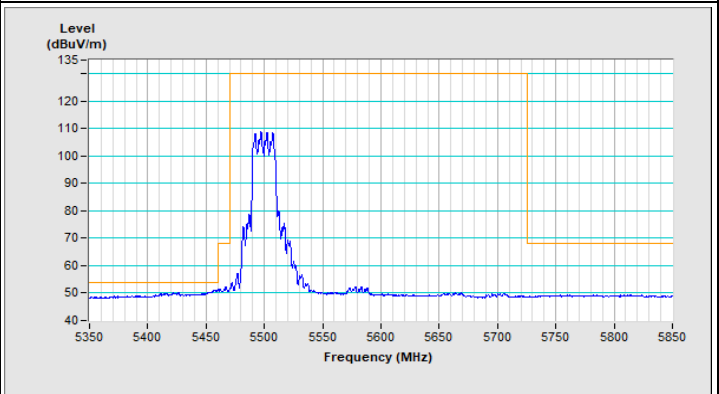

Vertical (Average)

802.11ax (HE20) Channel 140

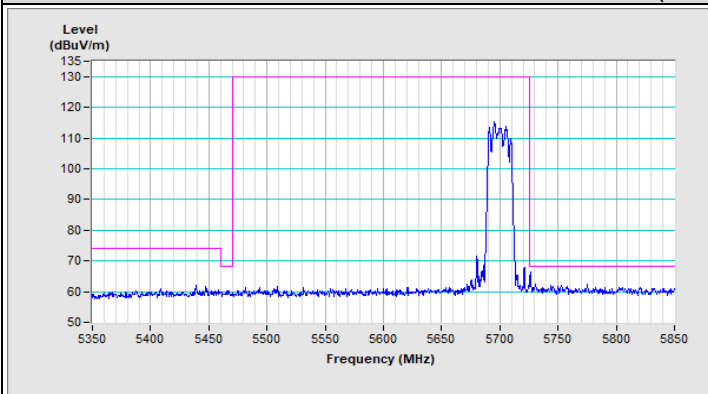

Horizontal (Peak)

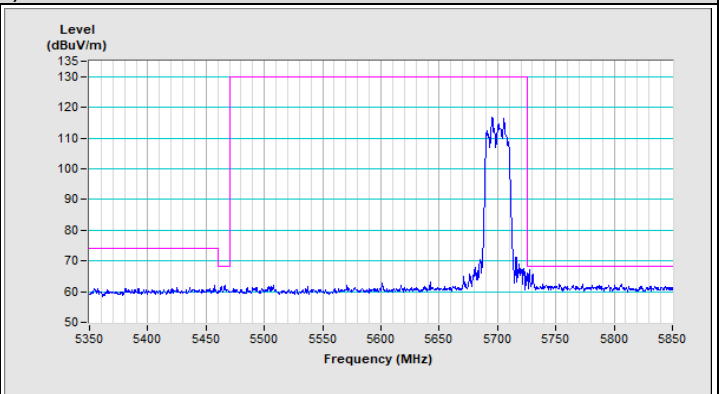

Vertical (Peak)

802.11ax (HE20) Channel 144

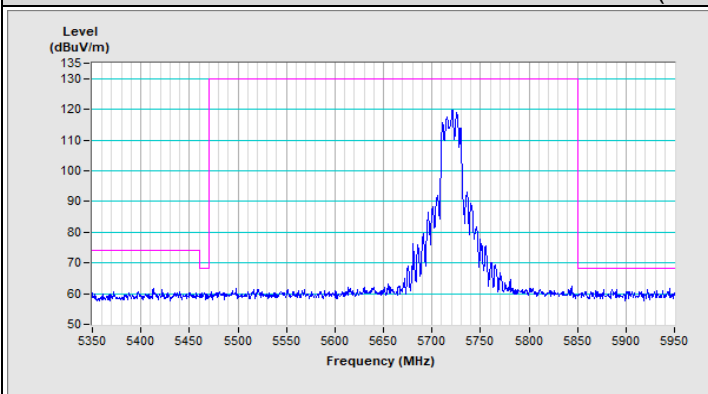

Horizontal (Peak)

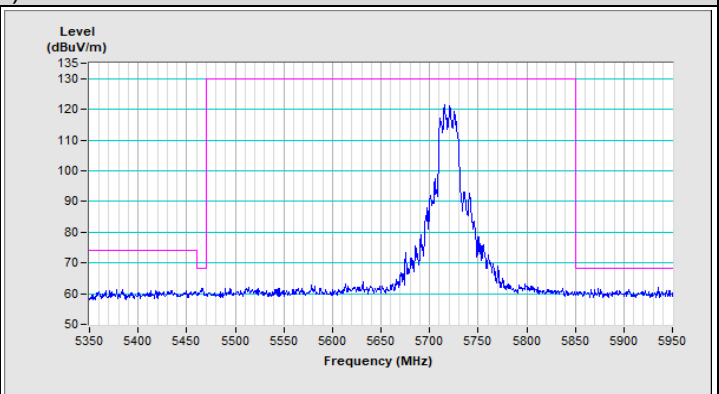

Vertical (Peak)

802.11ax (HE40) Channel 54

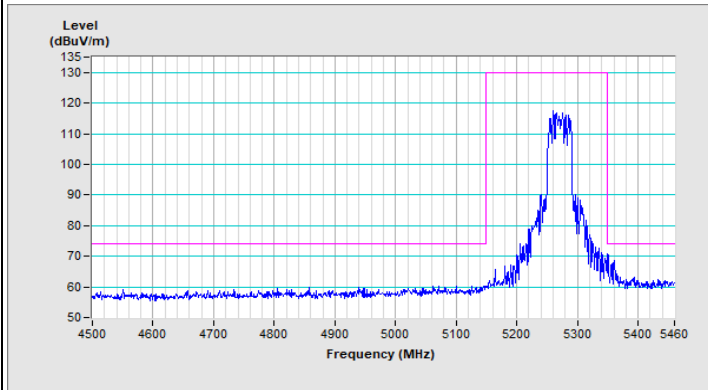

Horizontal (Peak)

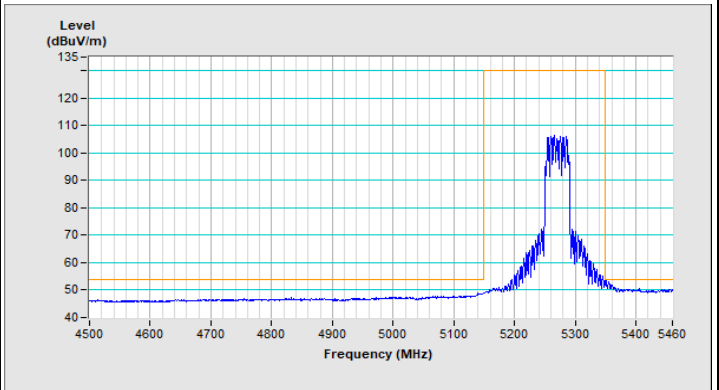

Horizontal (Average)

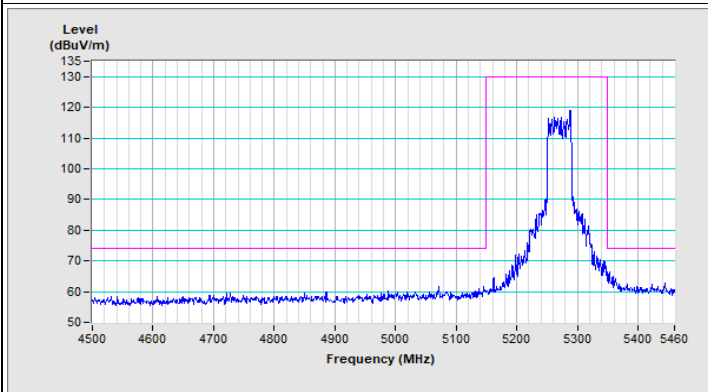

Vertical (Peak)

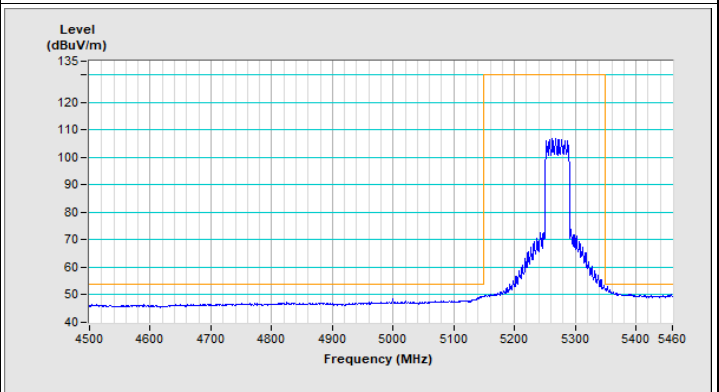

Vertical (Average)

802.11ax (HE40) Channel 62

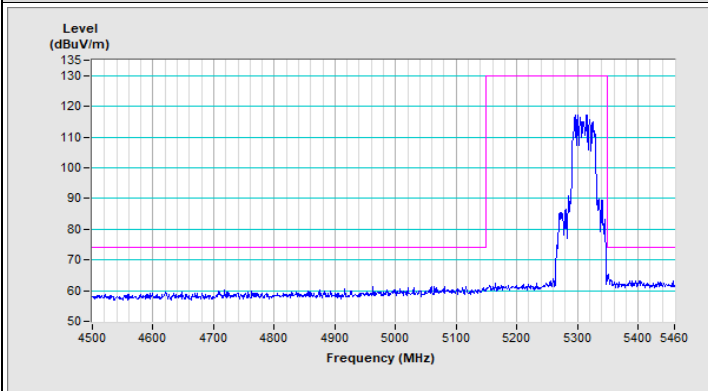

Horizontal (Peak)

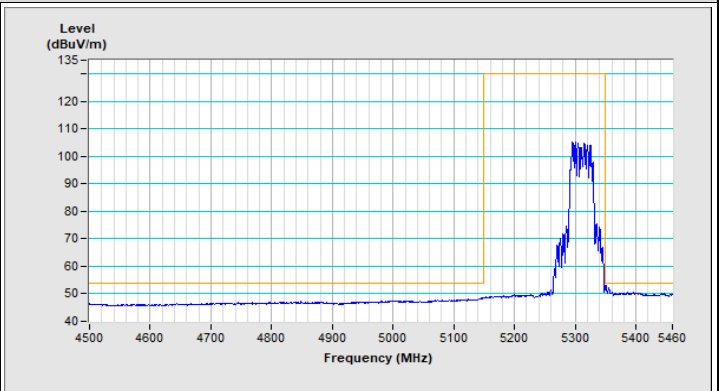

Horizontal (Average)

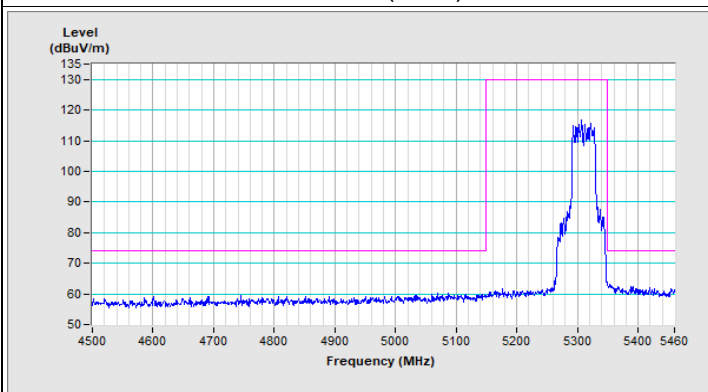

Vertical (Peak)

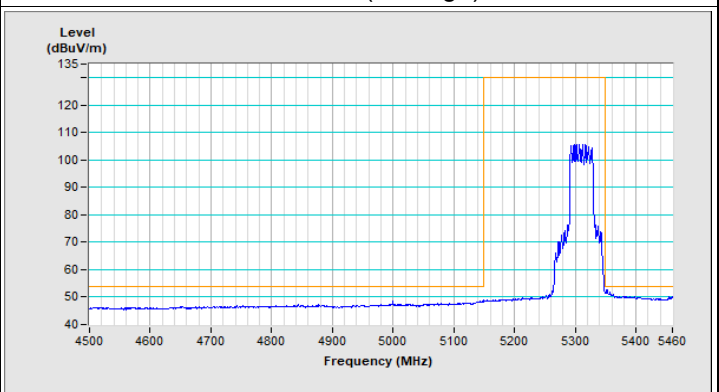

Vertical (Average)

802.11ax (HE40) Channel 102

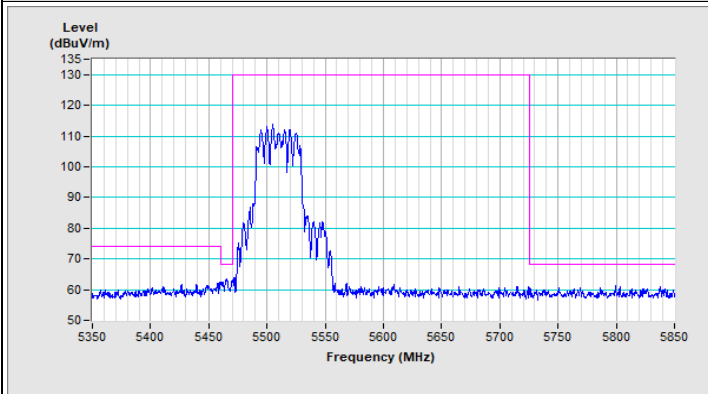

Horizontal (Peak)

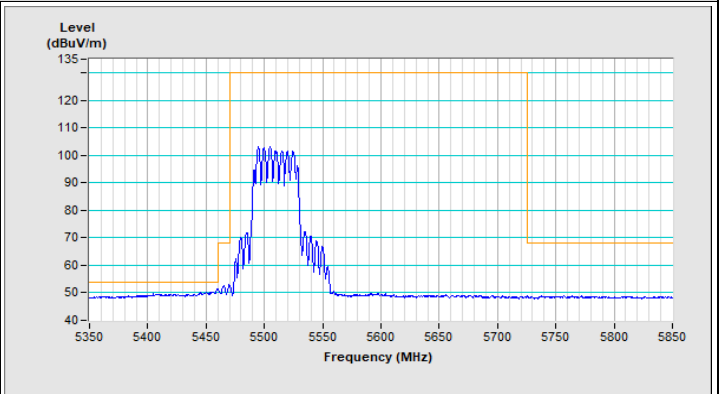

Horizontal (Average)

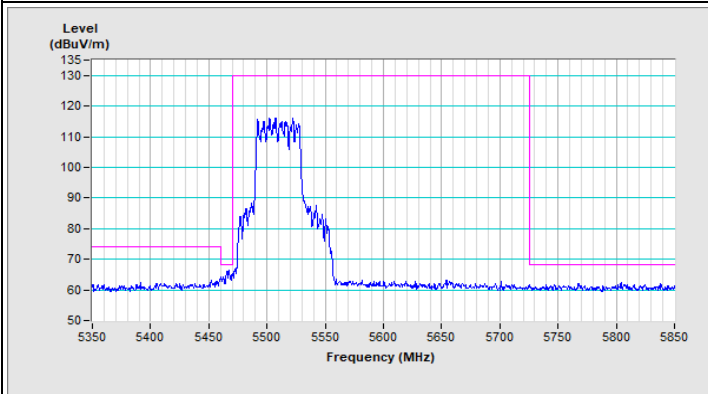

Vertical (Peak)

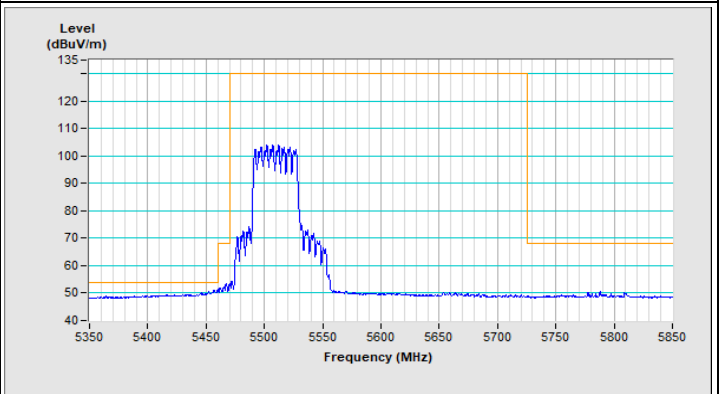

Vertical (Average)

802.11ax (HE40) Channel 134

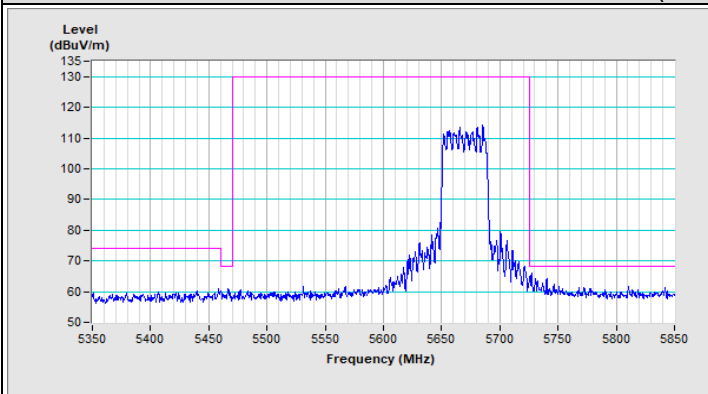

Horizontal (Peak)

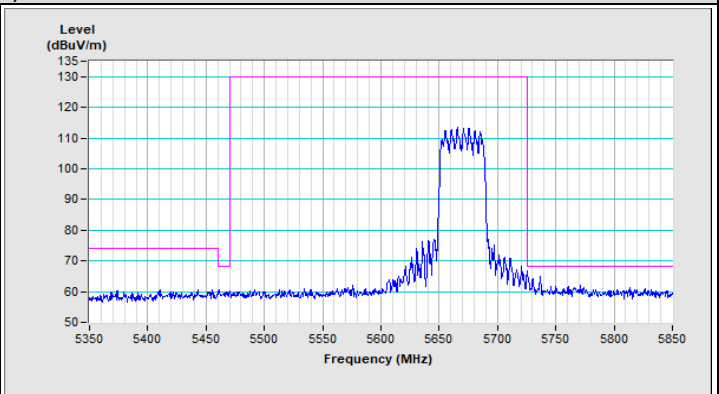

Vertical (Peak)

802.11ax (HE40) Channel 142

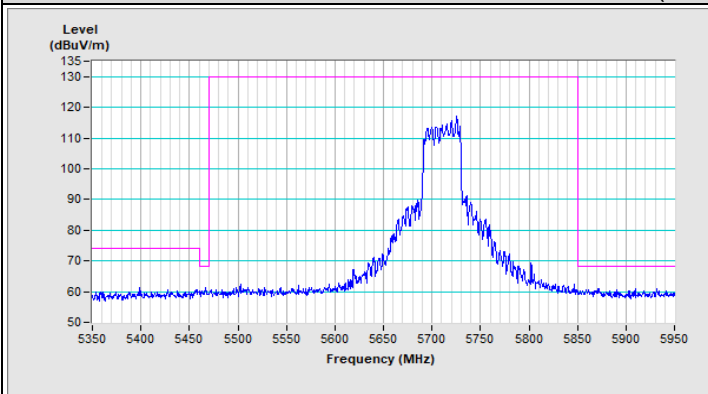

Horizontal (Peak)

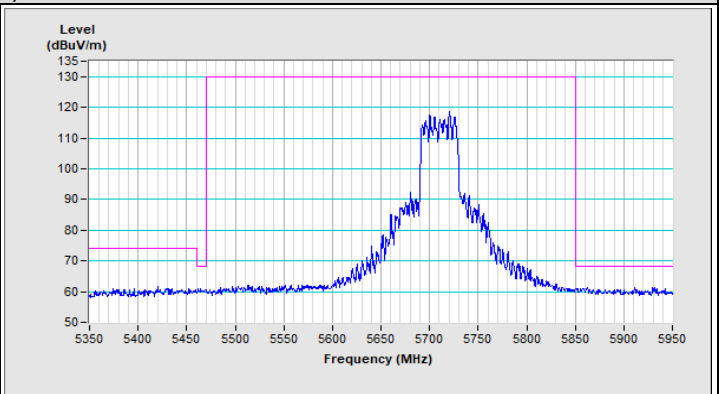

Vertical (Peak)

802.11ax (HE80) Channel 58

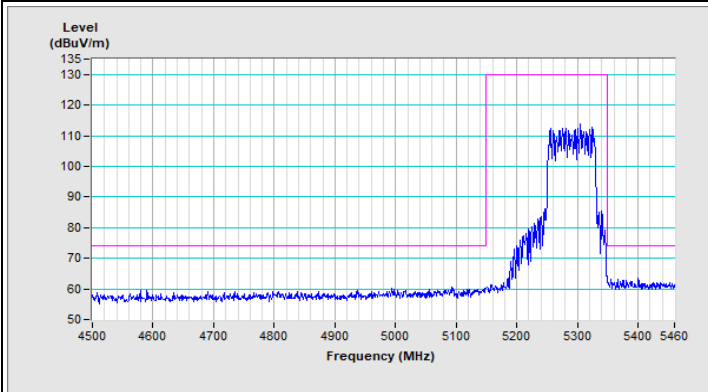

Horizontal (Peak)

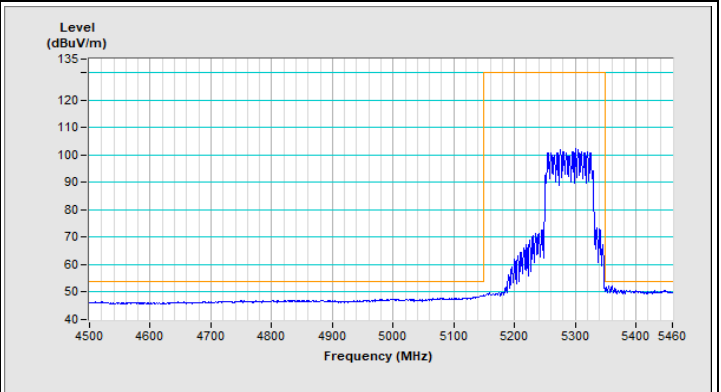

Horizontal (Average)

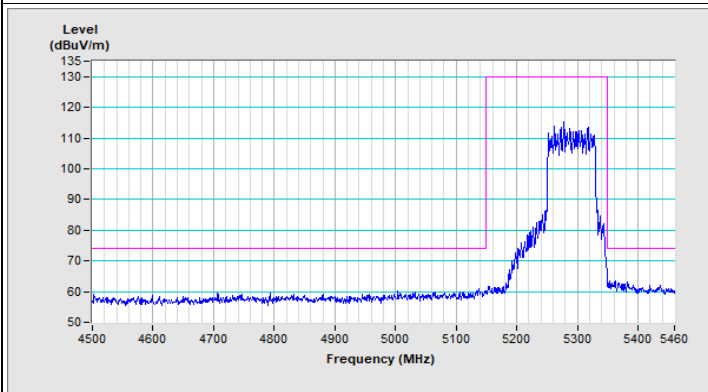

Vertical (Peak)

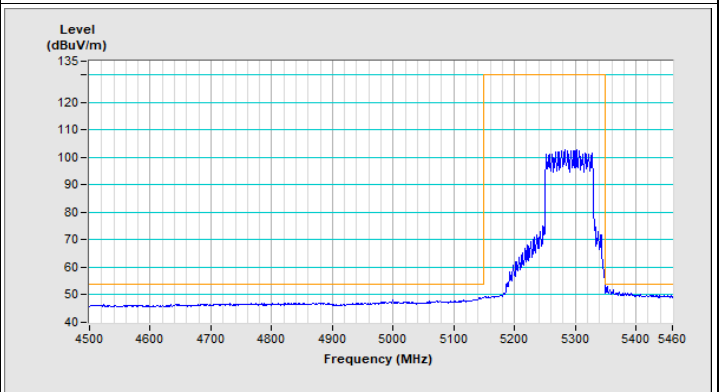

Vertical (Average)

802.11ax (HE80) Channel 106

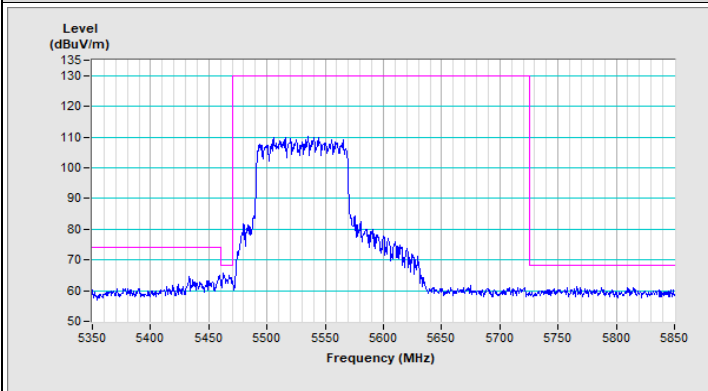

Horizontal (Peak)

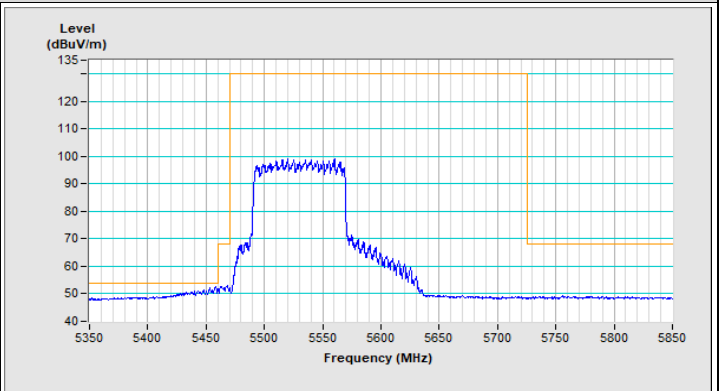

Horizontal (Average)

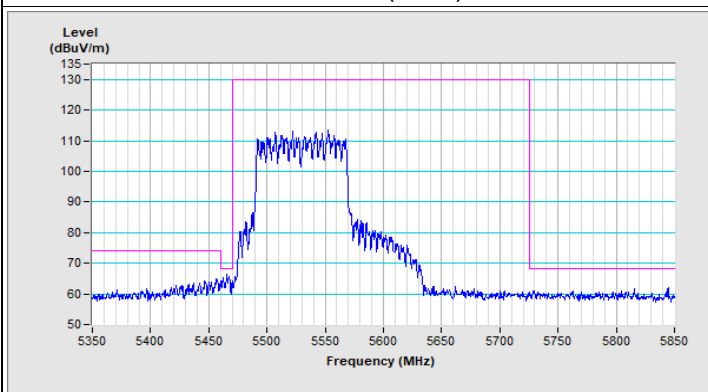

Vertical (Peak)

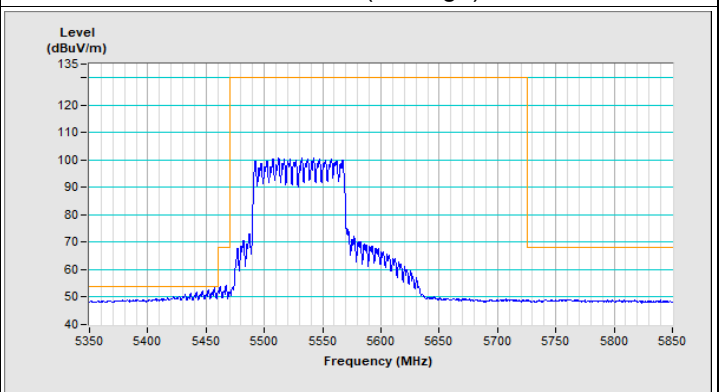

Vertical (Average)

802.11ax (HE80) Channel 122

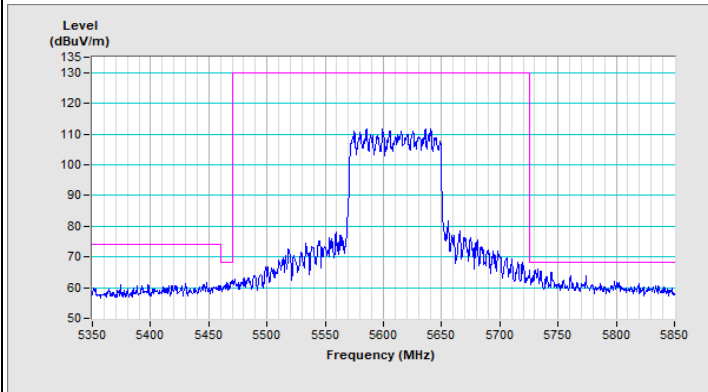

Horizontal (Peak)

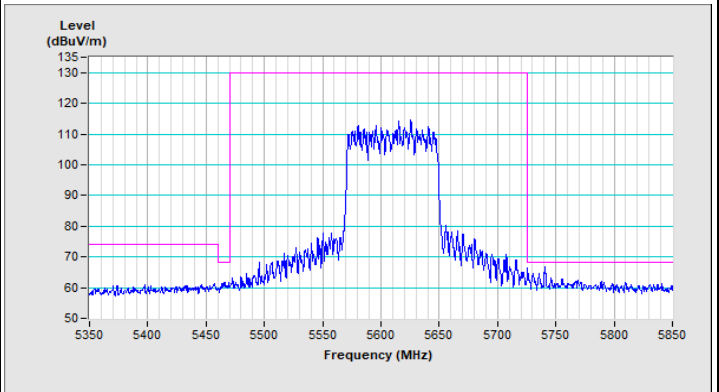

Vertical (Peak)

802.11ax (HE80) Channel 138

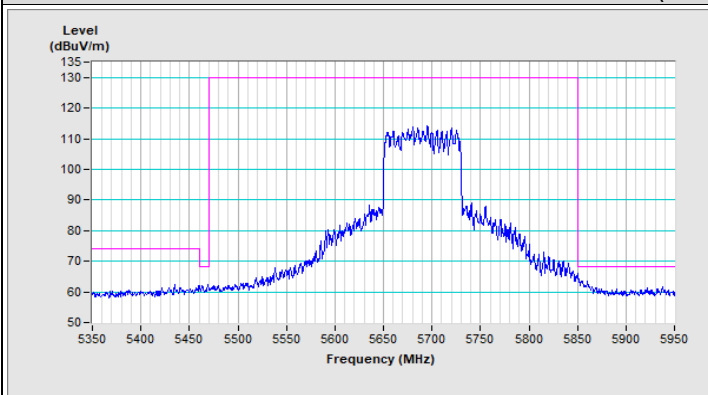

Horizontal (Peak)

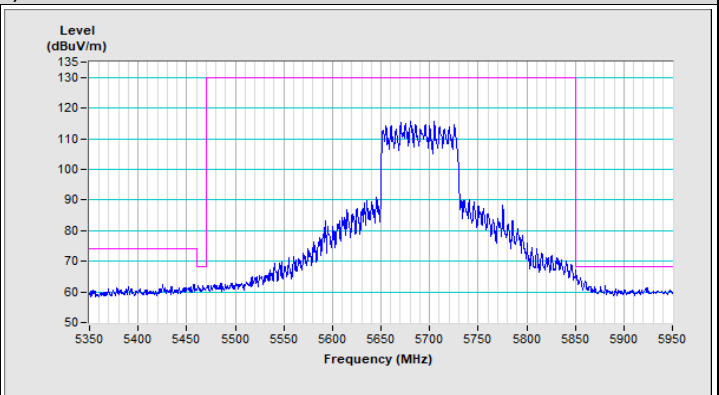

Vertical (Peak)

802.11ax (HE160) Channel 50

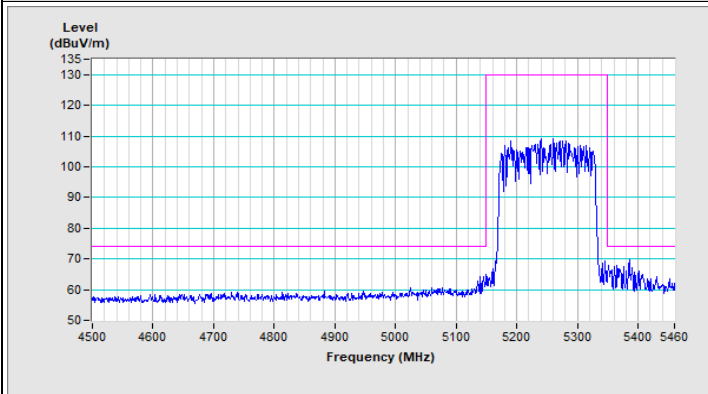

Horizontal (Peak)

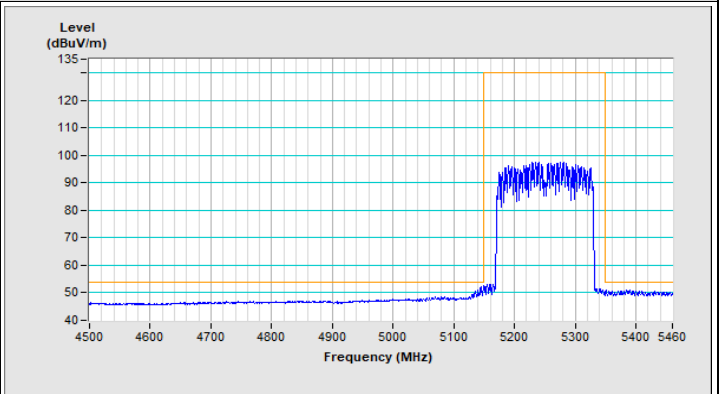

Horizontal (Average)

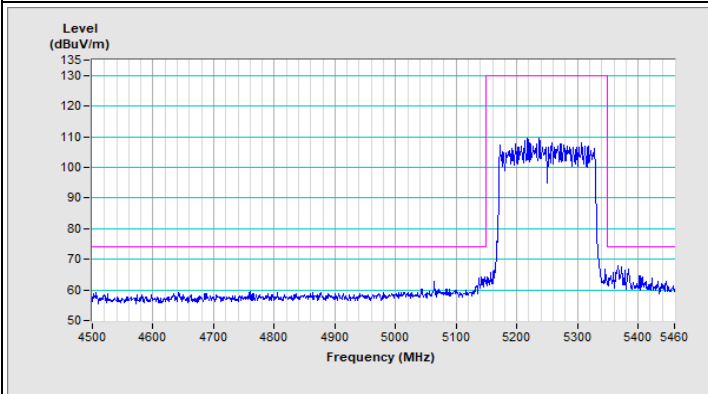

Vertical (Peak)

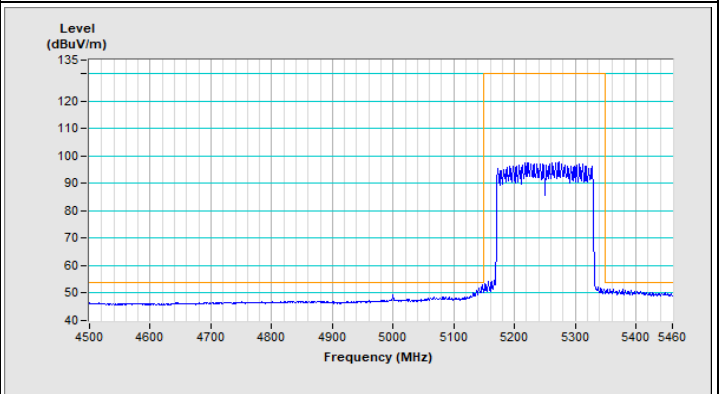

Vertical (Average)

802.11ax (HE160) Channel 114

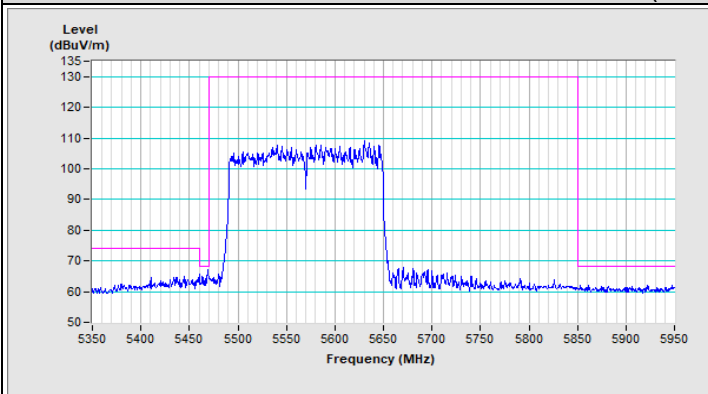

Horizontal (Peak)

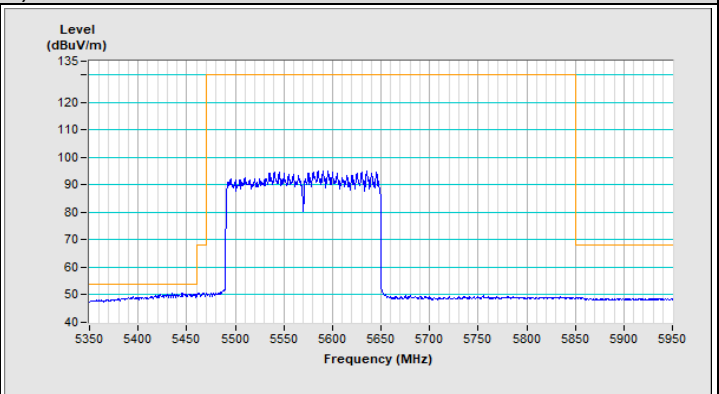

Horizontal (Average)

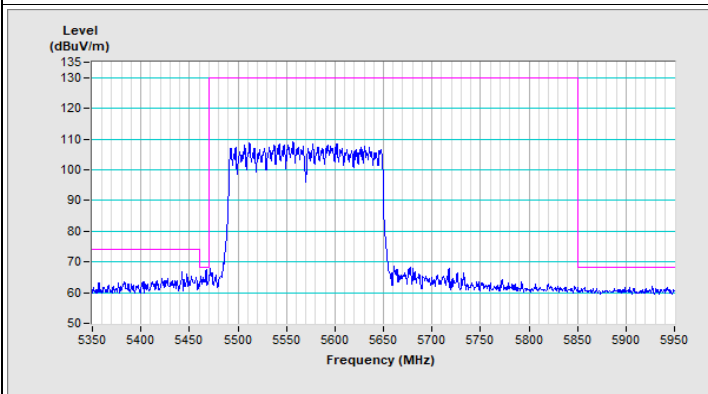

Vertical (Peak)

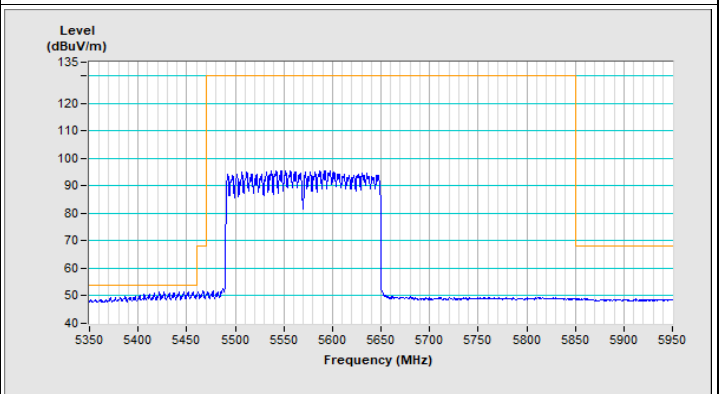

Vertical (Average)

8 Pictures of Test Arrangements

Please refer to the attached file (Test Setup Photo)

9 Information of the Testing Laboratories

We, Bureau Veritas Consumer Products Services (H.K.) Ltd., Taoyuan Branch, were founded in 1988 to provide our best service in EMC, Radio, Telecom and Safety consultation. Our laboratories are FCC recognized accredited test firms and accredited according to ISO/IEC 17025.

If you have any comments, please feel free to contact us at the following:

Lin Kou EMC/RF Lab

Tel: 886-2-26052180

Fax: 886-2-26051924

Hsin Chu EMC/RF/Telecom Lab

Tel: 886-3-6668565

Fax: 886-3-6668323

Hwa Ya EMC/RF/Safety Lab

Tel: 886-3-3183232

Fax: 886-3-3270892

Email: service.adt@bureauveritas.com

Web Site: <http://ee.bureauveritas.com.tw>

The address and road map of all our labs can be found in our web site also.

--- END ---