

THE MENU SYSTEM

WHAT'S A MENU?

The on-screen menu is a list of choices, just like a menu in a restaurant. And, just as a restaurant menu is divided into sections such as appetizers, entrees, and desserts, the on-screen menus are also separated into sections to help you find the information you need.

DON'T FORGET POINT AND SELECT

As with all of the on-screen displays, you use Point and Select to navigate.

1 SETUP AND CONNECTIONS



2 USING THE REMOTE



3 PROGRAM GUIDES



4 THE MENU SYSTEM



5 TROUBLESHOOTING

THE MENU SYSTEM

USING THE MENU SYSTEM

To bring up the Main menu, press MENU on the remote.



Use point and select to choose an item from the Main menu.

To use the menu system, you need to know the Point and Select rule. Use the arrows on the remote to point to an item on the screen, and then press OK to select it.

BACK AND HELP

There are *Back* and *Help* buttons at the top of most screens. Point to *Back* and press OK to leave that screen. Point to *Help* to see more information about that screen.

Exiting a Screen

There are three ways to exit a menu:

- Point to *Back* and press OK.
- Press the CLEAR button on the remote control. The on-screen displays clear from the screen and you return to TV viewing.
- Press the GO BACK button on the remote. You return to the previous on-screen display or normal programming.

Using Help

All menus have a *Help* button. For example, selecting the *Help* button from the Main menu shows you information about using the Main menu screen.

The rest of the *Help* buttons in the menu system bring up helpful information explaining one aspect of that menu.

Use the MENU button to bring up the Main menu, and then use Point and Select to choose a menu option.

If the Main menu doesn't appear when you press MENU, the remote might not be in DSS® mode. Try pressing the DSS button on the remote, and then OK.

Context-Sensitive Help

Most of the screens contain information to help you decide what to do next. If you get stuck, look for the help text.

THE MENU SYSTEM

MENU DESCRIPTIONS

This section briefly describes each of the available Main menu options. More information about each menu and its features is included later in this chapter.

Program Guide

Shows the on-screen programming schedules.

Mailbox

Use to read mail messages from your program providers.

Purchases

Use to review or cancel upcoming purchases, and to review past purchases.

Timers

Allows you to schedule the digital satellite system to tune to a specific channel at a specific time.

Profiles

Allows you to set ratings limits, spending limits, and viewing hours, as well as create favorite channel lists.

Options

Allows you to find out more about the receiver and remote, change how your system looks, run the system test and install a new access card.

Dish Pointing

Use to find your dish pointing coordinates, and to access the on-screen signal strength meter.

Home Control

With the proper equipment, this feature lets you control certain devices and appliances in your house.

DON'T BE AFRAID TO EXPLORE

Once you've learned the basics, feel free to poke around the menu system because exploring is the best way to learn. The context-sensitive help at the bottom of the screen provides instructions for getting through any particular menu or control panel. Remember, press CLEAR at any time to leave the menu system and return to regular system viewing.



Don't Forget About the CLEAR Button

Press the CLEAR button on the remote to remove the on-screen menus and return to normal viewing.

THE MENU SYSTEM

THE PROGRAM GUIDE

1 Program Guide...

Selecting *Program Guide* brings up your default program guide: the Detail Guide, the Grid Guide or SurfGuide.

ANATOMY OF A PROGRAM GUIDE

The following diagram shows you the kind of information you will see in the Detail Guide and Grid Guide.

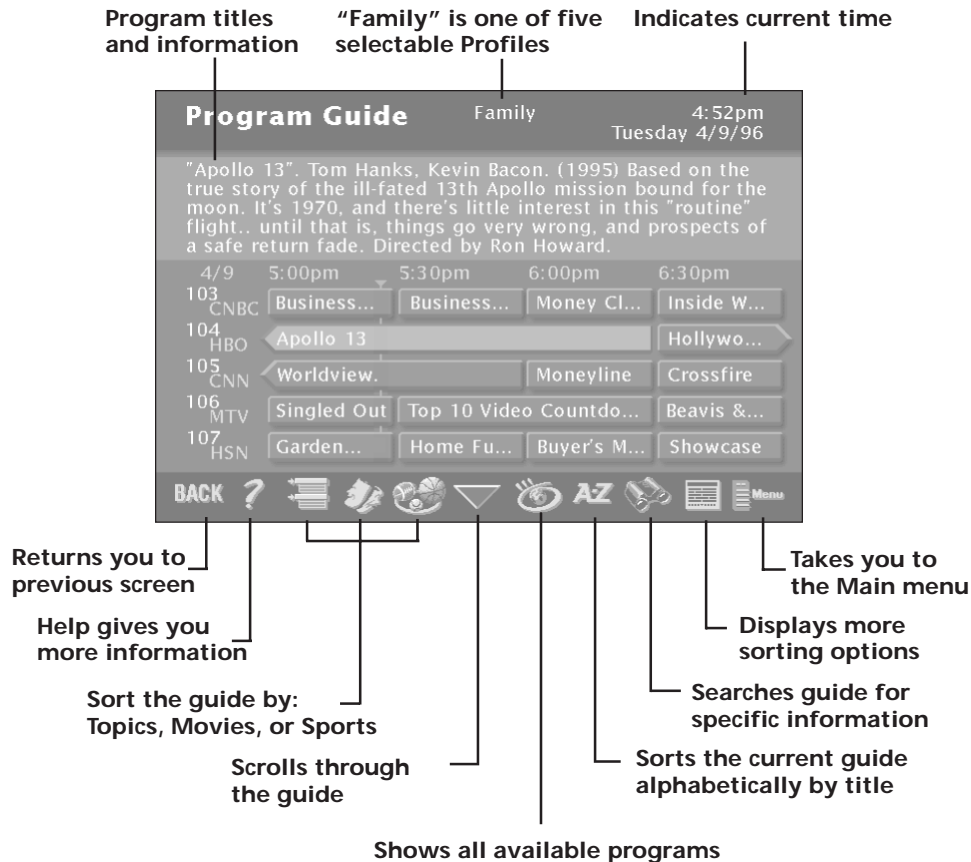

BRINGING UP THE PROGRAM GUIDES

Besides selecting *Program Guide* in the Main menu, you can press the GUIDE button on the remote.

Want More Information?

Read the section in this book called Program Guides for all the details.

THE MENU SYSTEM

THE MAILBOX

The mailbox shows you messages that are sent—or “mailed”—from your program providers. For example, you may receive a message calling your attention to a new service.

2 Mailbox...

HOW TO TELL WHEN YOU HAVE MAIL

There are two ways to tell if you have mail, depending on whether the receiver is turned on or off.

- If the receiver is turned on, the mail icon in the channel banner is highlighted.
- If the receiver is turned off, the power light on the front panel of the receiver flashes.

CHECKING YOUR MAIL

Select *Mailbox* on the Main menu or channel banner to view your mail.

1. Point to a message and press OK. The message is opened for you to read.



Mail provides the latest information from program providers.

2. Press OK again to close the letter.

After you read a message and want to erase it, point to *Erase Message* and press OK. When you exit the display screen, messages not erased are saved in memory.

THE MENU SYSTEM

PAY-PER-VIEW PROGRAMS

Pay-per-view programs (PPV) are programs that you purchase—like a movie ticket—on an event-by-event basis. For instance, there might be a specific channel that runs nothing but previews for movies. After previewing the movie, you can purchase it or find out more details about it. PPV programs can also be found in the program guide.

3 Purchases...

PURCHASING AND PREVIEWING

There are several ways to purchase and preview PPV movies and events:

- Tune to a PPV program's channel. Program providers may offer on-screen purchase instructions, usually as the PPV program begins.
- Choose a PPV program from the program guide.
- Preview a coming attraction by selecting a channel from the Attractions Guide.

TUNING TO A PPV PROGRAM

When you use the channel buttons or digits on the remote to tune to a Pay-Per-View channel, you need to press the INFO button to bring up the *Program Details* screen in order to purchase a program.

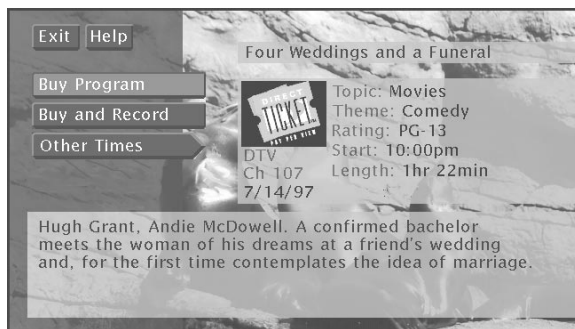

Use the program guide to get to the *Program Details* screen.

Follow the on-screen instructions to purchase the selected program.

You may need to enter your four-digit password to order a PPV program if it costs more than the spending limit you set up in the Profiles menu.

THE MENU SYSTEM

USING THE PROGRAM GUIDE FOR PPV PROGRAMS

When you use the program guide to select a PPV program, the *Program Details* screen gives you a few more options.

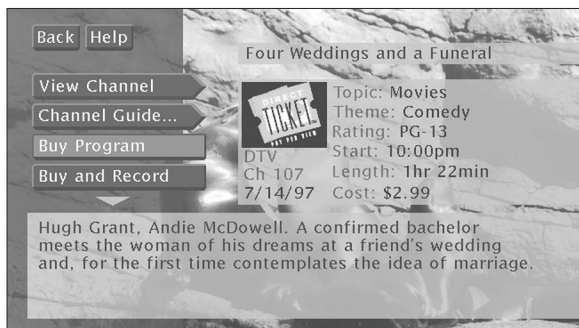

The Program Details screen gives you several options.

You can select:

- *View Channel* to tune to that channel
- *Channel Guide* to see a program lineup for that channel
- *Buy Program* to purchase the program
- *Other Times* to see what other times the program is available. The program title is automatically entered and sorted in the AlphaSort control panel.

The options available to you may vary according to the type of program you select.

3 Purchases...

You need to connect your phone line to your satellite receiver to be able to order PPV programs using the on-screen menus.

THE MENU SYSTEM

USING THE ATTRACTIONS GUIDE

3 Purchases...

Your program providers may offer future programming events not currently listed in your Program guide. These events are called “coming attractions,” and can be previewed in the Attractions Guide.

1. Press the GUIDE button on the remote until the Detail Guide or Grid Guide appears on-screen.
2. Use the down arrow button to move the highlight to the bottom of the screen.
3. Point to and select the *Other Guides* button.
4. Point to and select the *Attractions Guide*.



The Other Guides menu provides several guide formats.

5. Point to a channel and select it.

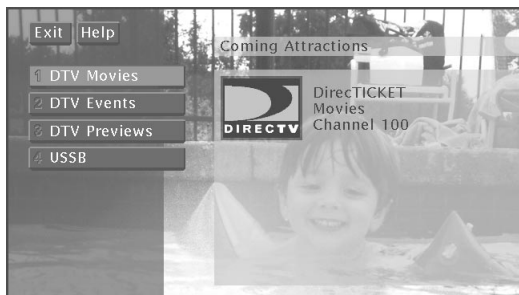

The Attractions Guide is accessed through the Other Guides menu.

THE MENU SYSTEM

USING THE PURCHASES MENU

3 Purchases...

The Purchases menu allows you to review upcoming and past purchases.

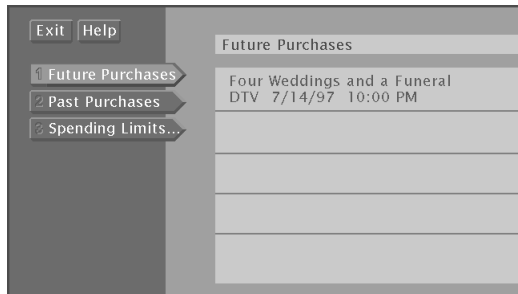

The Purchases menu shows you upcoming or past purchases, and spending limits.

The list of purchases may be longer than one screen; use the down arrow keys to see more items. The display also shows the title, channel, date, time, and cost of each program.

- Note that the Past Purchases list might be modified after each billing cycle and still show purchases for which you have already paid.

REVIEWING AND CANCELING AN UPCOMING PURCHASE

Use Point and Select to choose an upcoming purchase from the *Future Purchases* screen. You can review the program description, as well as cancel an upcoming purchase.



The Purchase Edit screen lets you cancel an upcoming purchase.

THE MENU SYSTEM

SPENDING LIMITS

Use the *Spending Limit* option to indicate a per-event spending limit for pay-per-view programs.

1. Point to *Spending Limit*, and press OK.

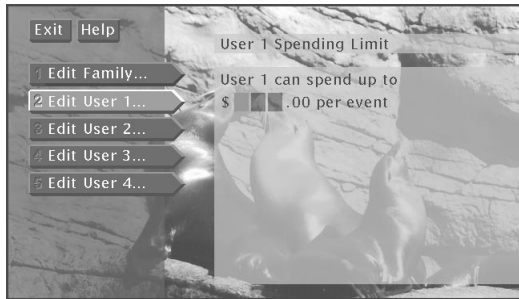

You can set a per-event spending limit for each Profile.

2. Use the digits on the remote or use the arrow keys to enter a single-program spending limit.

After a spending limit is set *and* the system is locked, you must enter a password to purchase a pay-per-view program that costs more than your spending limit allows.

3 Purchases...

Important!

Spending limits are in effect only when the system is locked.

THE MENU SYSTEM

TIMERS FEATURE

The Timers feature allows you to preset your system to automatically tune to a particular channel at a predetermined time.

To use the Timers feature, select *Timers* from the Main menu to bring up the Timers screen. Select a Timer (1-8) and then use the arrow keys to complete the on-screen sentence. When the sentence is complete, select *Run Timer*.



Complete the on-screen sentence to set up a timer.

Setting Up Timer Recordings

The Timers feature allows you to set up timer recordings when you connect the VCR Controller to your satellite receiver, and tell the receiver what type of VCR you are using.

Recording with Timer

If you choose *Record* instead of *Watch* when setting the Timer (and have set up your VCR as previously discussed), the Timer will toggle on your VCR, then start and stop recording a program.

To record with timers:

- Your VCR must be preset to the digital satellite system output channel (RF or Line).
- Your VCR must be OFF at the time the program is to start recording.

4 Timers...

On-screen icons are an easy way to understand the timers.



indicates the timer is set.



indicates the timer is set for a PPV.



indicates a timer conflict.

Editing or Canceling a Timer

From the Timers screen, select the Timer you want to edit or cancel, and then do the following:

- Use the arrows keys to edit the Timer, then select *Run Timer*.
- Select *Clear Timer* to cancel the timer.
- To watch the program daily or weekly, edit that program's timer.

THE MENU SYSTEM

Schedule a Timer with the RECORD Button

You can schedule a recording directly from the guide.

1. With a program highlighted, press the RECORD button on the remote. The *Program Details* appears on-screen.

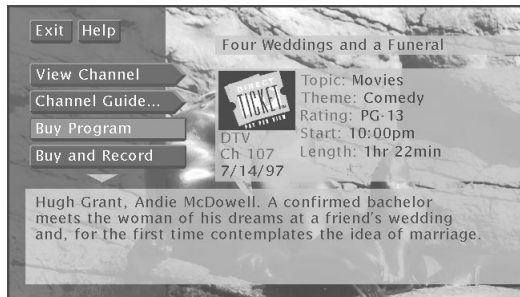

2. To schedule a timer to record, select:
 - *Record Program* to set a timer to record the program.
 - *Buy and Record* to purchase the program and set up a timer to record the program. (Some *Buy and Record* programs may have a different purchase price.)

The options available to you may vary according to the type of program you select.

4 Timers...

Editing or Canceling a Timer

From the Timers screen, select the Timer you want to edit or cancel, and then do the following:

- Use the arrows keys to edit the Timer, then select *Run Timer*.
- Select *Clear Timer* to cancel the timer.
- To record the program on a daily or weekly edit that program's timer.

THE MENU SYSTEM

PROFILES

5 Profiles...

When you select *Profiles* from the Main menu, the first screen you see is the *Master Edit* control panel. In addition to the Family profile, you can create as many as four different profiles that can be easily accessed by using the WHO button on the remote control.

You can personalize the profile by entering a name.

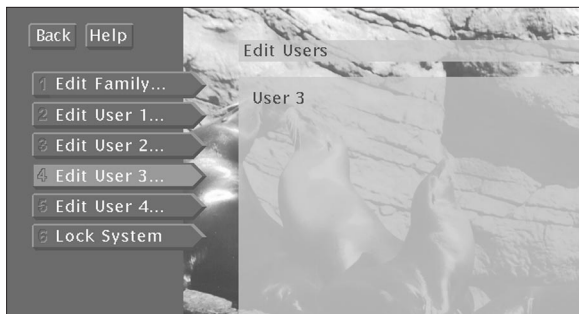

You can personalize each profile.

You can also edit the user profiles. Select a profile from the *Edit Users* control panel. By moving down the options you can create or edit the user's channel list, set a ratings limit, viewing hours, per-event spending limits and assign a profile password.

THE MENU SYSTEM

CREATING A PROFILE CHANNEL LIST

1. Point to and select a user.
2. Point to *Edit Channels* and press OK.



To start, you can add or delete all channels.

3. Use the arrow keys to point to a channel, and press OK to remove (or replace) the check mark. Checkmarked items appear in the channel list.

Add or Delete All Channels

You might be able to save time when creating a channel list by using the *Add All Chans* option or the *Delete All Chans* option to either add all channels or delete all channels before removing or adding individual channels.

Also, program providers may make additional channels available. To prevent new channels from appearing in a profile channel list, choose *Delete All Chans* and checkmark only the channels you want to appear in the list.

5 Profiles...

Important!

You need to lock the system in order for rating limits, channel limits, viewing hours, and spending limits to go into effect.

After you lock the system, you need to enter the system password to edit the limits. See "Locking the System" for details.

THE MENU SYSTEM

SETTING THE RATINGS LIMIT

The Ratings Limit menu enables you to set a maximum viewing limit for rated movies (based on the MPAA ratings system), as long as the program provider has transmitted the proper code.

- Note that the ratings limit cannot be enforced if a program has not been rated, if rating information for that program is not transmitted by the program provider, or if the system has not been locked.
1. Point to *Set Rating Limit* and press OK.



Use the arrow keys to move the selector up and down.

2. Use the up and down arrows to move the rating selector to the highest rating you want to be able to view. In the preceding illustration, movies that are rated up to and including a "PG-13" rating can be viewed.

After the *Rating Limit* is set *and* the system is locked, you must enter the system password to watch programs with a rating higher than your limit.

5 Profiles...

After the system has been locked, you must enter the correct password in order to access the *Edit Users* control panel.

Don't Forget Your Password

If you forget a **USER** password, you need to unlock the system and then assign a new user password.

If you forget the **SYSTEM** password, contact your program provider's authorization center.

THE MENU SYSTEM

VIEWING HOURS

5 Profiles...

Use the *Viewing Hours* option to limit the total amount of time, as well as the viewing hours a user can watch programming.

1. Point to *Viewing Hours*, and press OK.



You can limit viewing seven days a week.

2. Use the digits on the remote or point to the + or – and press OK to complete the on-screen sentence. Choose the days to view, how many hours can be viewed each day (0-24 hours) and when programming can be viewed. Be sure to lock the system for these limits to take effect.

SETTING UP SPENDING LIMITS

Select the *Spending Limit* option to indicate a per-event spending limit for pay-per-view programs.

1. Point to *Spending Limit*, and press OK.

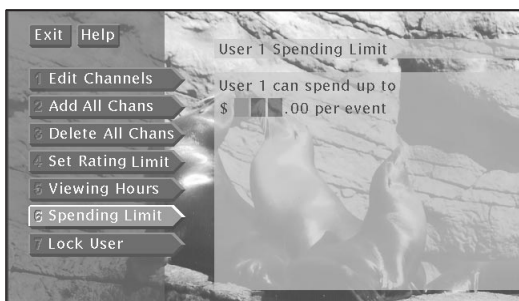

You can set a per-event spending limit for each profile.

THE MENU SYSTEM

2. Use the digits on the remote or use the arrow keys to enter a single-program spending limit.

After a *Spending Limit* is set and the system is locked, you must enter the system password to purchase a pay-per-view program that costs more than your *Spending Limit* allows.

5 Profiles...

LOCKING A USER'S PROFILE

Each user can be assigned a personal password to lock his or her profile. When a password is assigned, the user must enter the password before he or she can view programs using that profile. Profile passwords do not allow access to, or editing of the profile limits. You must enter the system password to edit profile limits.

1. Point to *Lock User* and press OK.

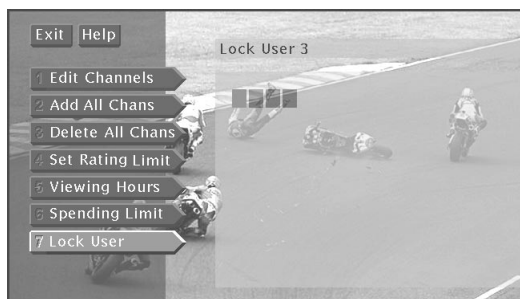

Each user can have a password.

2. Use the arrow or digit keys to select each number of the password.

THE MENU SYSTEM

LOCKING THE SYSTEM

You can lock the system in order to put into effect the ratings, spending, viewing, and channel limits you have set up. When you lock the system, no one can modify any of these settings without first entering the four-digit system password.

1. Point to *Lock System* and press OK.



Locking the system protects the limits you set up.

2. Use the arrows or the digit keys to enter a four-digit system password.
3. Enter the password a second time to confirm it.

In order for the changes to take effect, you must exit out of the menu system.

Unlocking the System

When the system is unlocked, the channel, spending, viewing, and ratings limits, that you have set are no longer in effect.

1. Point to *Unlock System* and press OK.
2. Point to *Yes* and press OK to confirm that you want to unlock the system.

Program Unlock

If your system is locked and you attempt to access a channel or program that is blocked by one or more limits, you are asked to enter the four-digit system password to override the system lock.

If you enter the password to override the rating or spending limit, all limits are unlocked until you turn off the receiver. When you turn on the receiver again, the system will be locked, and the Family profile channel list will be selected. You can also re-lock the system by selecting the lock icon in the channel banner.

5 Profiles...



The Lock/Unlock icons in the channel banner provide an easy way to lock or unlock the system. Just point and select to change the lock status.

Green Unlock icon The system is unlocked. Spending, viewing and other limits can be accessed and changed.

Yellow Unlock icon A password has been entered to override family or profile limits. No limits can be accessed or changed.

Yellow Unlock icon with a "P" A password has been entered to override limits for the current program. After the program ends, limits are restored.

Red Lock icon No limits can be accessed or changed. A password is required to override limits or access the system.

THE MENU SYSTEM

CHOOSING YOUR PROFILE

5 Profiles...

Each time that you turn on the receiver, the Family profile is selected by default. To select a different profile:

1. Press the WHO•INPUT button to scroll through the profiles.

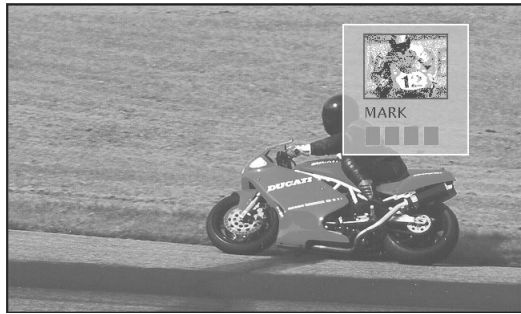

The WHO•INPUT button toggles through the profiles.

2. When your profile appears, enter your four-digit personal password to activate your profile.
 - If the profile is not password protected, you can just press OK to activate it.

The channel, spending, ratings and viewing limits will reflect the chosen profile only when the system is locked.

OPTIONS

The Options menu lets you set up preferences for the look and feel of the system as well as how some of the features work.



The Options menu lets you change how the system works.

The following sections explain your options when changing your personal preferences. Follow the on-screen instructions to make changes to the system.

THE MENU SYSTEM

Interactive Setup

If you self-installed your satellite dish antenna, you may have already used the interactive setup to find the dish pointing coordinates, acquire and fine-tune the signal, and run a system test. If you just want to check your dish pointing coordinates, or run the signal strength meter, select *Dish Pointing* from the Main menu.

A grey arrow-shaped button pointing to the right. On the left side of the button is a small circular icon containing a satellite dish symbol. To the right of the icon, the text "Options..." is written in a light grey font.

About DSS

Select *About DSS* from the *Options* menu to choose from a list of on-line Help topics. Point and select to find out about the specific parts of the satellite system.

Program Guide shows a screen-by-screen overview of the Program guide features.

Menu System shows a screen-by-screen overview of the satellite system menus.

Remote Control shows a descriptive list of the remote control buttons.

Front Panel shows a list of the receiver's front panel features. Point to an item to see a brief description.

Back Panel shows a list of the receiver's back panel features. Point to an item to see a brief description.

Glossary shows a list of common satellite system and TV terms. Point to a glossary item to see a brief description.

LOOK AND FEEL

Default Guide lets you choose which guide appears first when you press the GUIDE button on the remote. The choices are Grid Guide, Detail Guide and SurfGuide.

Color Scheme lets you pick which color appears in the guides and menu system.

Translucency lets you choose the translucency of the menu displays. Slide the indicator bar to make the screens more opaque or less opaque.

Animation lets you select which graphics are displayed and also lets you select the animation time-out.

Edit Fetch lets you combine your favorite menu items onto one menu, or assign one function to the Fetch button on the remote. (See the section "Edit Fetch Menu" for details.)

THE MENU SYSTEM

SYSTEM OPTIONS

A grey arrow-shaped button pointing to the right. On the left side of the button is a circular icon containing a gear symbol. To the right of the icon, the text "Options..." is written in a light grey font.

System Test The System Test display screen is accessed through the *Options* menu, and allows you to initiate diagnostic procedures on the DSS® system. You should use this feature to get your Access Card number, or when your receiver doesn't seem to be working correctly.

A message screen appears, telling you whether the system passed each test. If your system fails a test, run the system test several times before concluding that there is a problem. Occasional fluctuations in the phone line or satellite signal can give temporary false readings.

New Access Card Periodically, your program provider may issue you a replacement access card. The New Access Card Setup display screen allows you to transfer information from the old card onto the new one.

Follow the display screen prompts to initialize your new card. Once you have transferred the information to the new card, your old card becomes invalid.

Because your specific account information is stored in the access card, power failures should have no effect on your satellite system.

Set VCR Type To use the VCR controller feature, you need to tell the receiver which VCR brand you are using.

1. Use the arrows or digit keys to input the correct code for your VCR brand. The VCR codes are located in the Remote Control section.
2. Follow the on-screen instructions to ensure that you are using the correct code. If the VCR automatically stops tape play, then you know that the receiver and the VCR are communicating.
 - Some VCR brands may not be capable of being controlled by the receiver.

RF Remote Setup The remote can control the receiver using both IR (Infrared) signals and RF (radio frequency) signals. IR signals require line of sight to the receiver's front panel remote sensor. RF signals can control the receiver from other parts of your house—even through walls.

Occasionally, due to interference or other RF devices, you may need to change the remote and receiver RF code. To change the code:

Follow the on-screen instructions to change the remote RF code.

Output Channel Lets you choose on which channel to view satellite programming, either channel 3 or channel 4.

THE MENU SYSTEM

Picture Size The Picture size display screen allows you to choose between a standard TV screen and a Cinema option. A standard TV screen has an aspect ratio of 4:3; the Cinema option has an aspect ratio of 16:9.

Data Port Lets you choose whether the low speed data port is used for low speed data or communicating with the Home Control Base accessory. See the Home Control section in this book for more information.



AUDIO LANGUAGE

When you select *Audio Language* from the *Options* menu, the Audio Language display screen comes up.

Point to the audio language or audio type you want and press OK. The satellite system will then automatically set the audio program to the selected audio program type when that type is available.

To change the audio:

- Point to *Audio Language* from the *Options* menu and press OK to set the default *Audio Language*.

ALTERNATE DATA

Selects from among the available data on the current channel.

THE MENU SYSTEM

THE DISH POINTING MENU SCREEN

7 Dish Pointing...

Follow these steps to obtain your dish pointing coordinates:

1. Turn on your television and satellite receiver.
2. Tune your television to the satellite receiver's output channel.
3. Press MENU on the remote to bring up the Main menu.
4. Use the arrows to highlight the "Dish Pointing" option, and then press OK to access the dish pointing screen.

NOTE: The menu screen that you see may be slightly different from the one pictured here.



5. Use the arrows on the remote or the front panel to highlight "Zip Code" and then press OK.
6. Enter the zip code for the dish installation location.
7. Record the elevation and azimuth numbers below.

Elevation _____ Azimuth _____

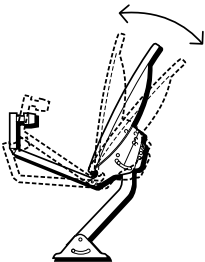

Elevation is the up/down angle that the dish is pointed.

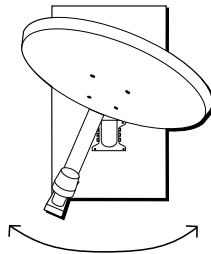

Azimuth is side to side direction that the dish is pointed.

You only need to use one of the available methods to find your dish pointing coordinates. If you know the zip code for the locality where the dish is being installed, use that.

THE MENU SYSTEM

USING THE ON-SCREEN SIGNAL METER

The signal strength meter is used to determine whether or not you are receiving the satellite signal, and it also indicates the strength of the satellite signal.

Follow these steps to bring up the on-screen signal meter:

1. Turn on your television and satellite receiver.
2. Tune your television to the satellite receiver's output channel.
3. Press MENU on the remote to bring up the Main menu.
4. Use the arrows to highlight the "Dish Pointing" option, and then press OK to access the dish pointing screen.
5. Use the arrows on the remote to highlight "Signal Meter" and then press OK.

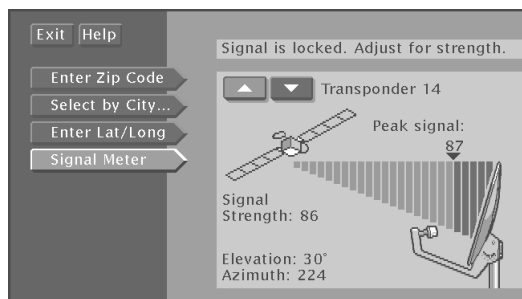

If the dish is pointed to the correct azimuth and elevation, the signal meter will show you the current signal strength (and you should hear a continuous tone).

If you are not receiving a signal, you need to incrementally adjust the azimuth setting on the dish. After you receive a signal, you will want to continue to adjust the azimuth to try to get the best possible signal.

Important

Changing transponders is not the same as fine-tuning the dish. Although the signal strength may appear to change, this may be due to different types of interference. To fine-tune the dish, consult the DSS Installation Guide and follow the instructions on adjusting the dish elevation and azimuth.

7 Dish Pointing...

Peak Signal

The "Peak Signal" indicates the highest signal strength you have obtained, which is not necessarily the highest possible signal.

While the maximum signal strength is 100, the signal strength you achieve will probably be less. Although there is no difference in picture quality between a signal strength of 60 and 85, the higher the signal, the less likely you are to experience negative effects in degraded conditions such as rain or snow (called "rain fade").

THE MENU SYSTEM

HOME CONTROL

Home Control lets you remotely control several lamps and appliances through your receiver.

Home Control Setup

The Home Control Data Interface connects to the HOME CONTROL jack on the back of the receiver. Once connected, you must tell the receiver to use this port for Home Control.

1. Press OK to bring up the Main menu.
2. Point to and select *Options*.
3. Point to and select *System Options*.
4. Point to and select *Data Port* and choose *Home Control* as the default setting.

Device Setup

1. From the Main menu select *Home Control*.



Home Control can control several devices.

2. Select a device you would like to control.
3. Complete the on-screen sentence using the arrow buttons and OK. Press OK to scroll through the lists of appliances and locations.

8 Home Control...

To use control devices, you must connect a Home Control Data Interface to the receiver and a remote module to the device you want to control. The Home Control Data Interface connects to the HOME CONTROL jack on the back of the receiver.

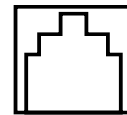

HOME CONTROL

Once connected, you must tell the receiver to use this port for Home Control.

These devices are available as accessories sold through your digital satellite dealer or the accessories order form at the back of this book.

THE MENU SYSTEM

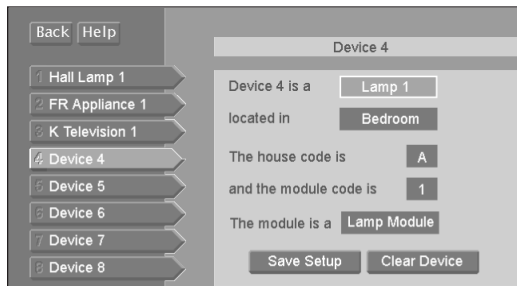

Keep track of devices by assigning a label.

4. Use the arrow buttons and OK to select the house and module codes that match the device's remote module and label the module. Select *Save Setup* to complete the setup.

Device Control

Once the device is set up, there are two ways to control it; with the menu system, or with a timer. Select a device from the Home Control menu screen. You can then, turn it on, turn it off, or adjust the brightness for lamp modules.

Select *Edit Setup* to change a device.

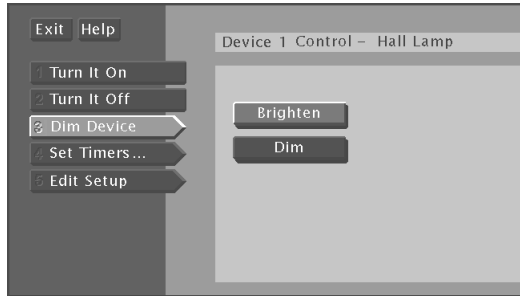

Control the device from the menu.

To schedule a timer:

1. Select *Set Timer*.
2. Schedule a timer by completing the on-screen sentence.



On-screen icons are an easy way to understand the timers.



indicates the timer is set.



indicates the timer is suspended.

You can schedule several timers to control the same device at different times.

THE MENU SYSTEM



Complete the on-screen sentence to schedule a timer.

3. Use the arrows and OK to enter an *on* and *off* time.
4. Point to and select *Run Timer*.

Clear Timer removes all the timer information.

Suspend turns off the timer, but saves the timer information.

EDIT FETCH MENU

The Edit Fetch menu gives you the option of using Fetch in two ways:

- You can customize eight functions on the Fetch menu, or
- You can customize the Fetch button on the remote to take a certain action each time it is pressed.

To view the Edit Fetch Menu, press MENU to bring up the Main Menu, select *Options*, select *Look and Feel*, and then select *Edit Fetch*.

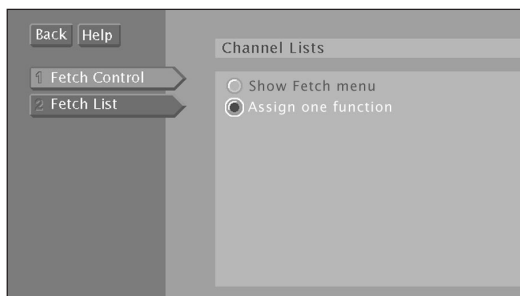

The Edit Fetch menu is a convenient way to call up frequently used menu items.

THE MENU SYSTEM

CUSTOMIZING THE FETCH MENU

To customize your Fetch menu:

1. Press MENU to bring up the Main menu.
2. Point to and select *Options, Look and Feel*, and then *Edit Fetch*.
3. Select *Fetch Control*.
4. Press OK to choose Show Fetch Menu.
5. Select *Fetch List* from the Edit Fetch menu.
6. Choose which eight menu items you would like to include in your customized menu by checkmarking them with the OK key.

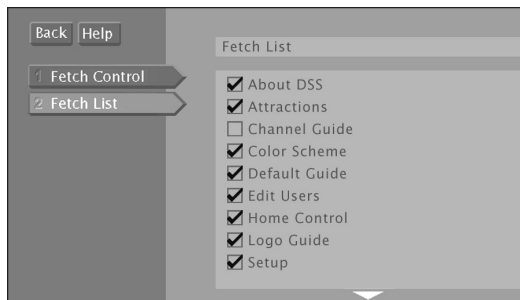

Choose which menu items to include in your customized Fetch menu.

7. Press the left arrow key to confirm your selections and return to the menu.

When you would like to access your customized menu, press the FETCH button on the remote control.

CUSTOMIZING THE FETCH BUTTON

To customize the FETCH button on the remote so it performs one function when pressed:

1. Press MENU to bring up the Main menu.
2. Point to and select *Options, Look and Feel*, and then *Edit Fetch*.
3. Select *Fetch Control*.
4. Choose *Assign One Function*.
5. Select *Fetch List* from the Edit Fetch menu.
6. Choose which menu item you would like to assign to the FETCH button by pointing and selecting.

THE MENU SYSTEM

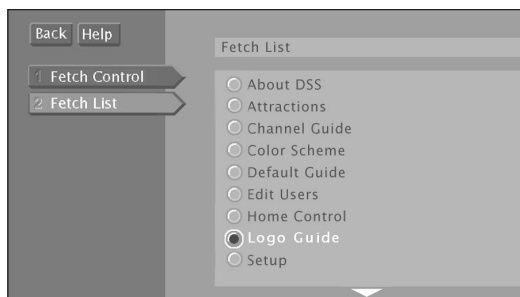

Choose which menu item to assign to the FETCH button.

7. Press the left arrow key to confirm your selection and return to the menu.

You may press the FETCH button on the remote and execute the assigned function at any time while viewing satellite programming.

THE MENU SYSTEM

TROUBLESHOOTING

TIPS FOR SOLVING PROBLEMS

You may have some questions about using your satellite system that you are unsure how to answer. This section provides the answers to such questions. You will find how to run a system test, how to diagnose problems, and how to correct problems.

1 SETUP AND CONNECTIONS



2 USING THE REMOTE



3 PROGRAM GUIDES



4 THE MENU SYSTEM



5 TROUBLESHOOTING

TROUBLESHOOTING

RUNNING THE SYSTEM TEST

The System Test allows you to run a basic diagnostics check on your satellite system. If you are experiencing any trouble with your system, run the system test. It will allow you to get your Access Card number, or to initiate diagnostic procedures on the satellite system.

First make sure that

- All connections—jacks, cables, etc.—are correctly in place. See the section “Setup and Connections” for more information.
- There are batteries in the remote, and that they are working correctly.
- The access card is installed in the receiver.

Follow these steps to run the diagnostics system test on your system.

1. Turn on your TV and the receiver.
2. Press DSS to put the remote in DSS® system mode, then press OK to bring up the Main menu.
3. Point to and select *Options*.
4. Point to and select *System Options*.
5. Point to and select *System Test*.
6. If your system does not pass the system test, check any of these potential trouble areas: cabling, pointing the satellite dish, phone connection, and access card.
7. If you continue to have problems, call 1-800-679-4776.

You should run a system test several times before concluding that there is a problem. Occasional fluctuations in the phone line or satellite signal can give temporary false readings.

FINE-TUNING THE SIGNAL

If you self-installed your satellite dish antenna, you may have already used the interactive setup to find the dish pointing coordinates, acquire and fine-tune the signal, and run a system test.

If you need to run the interactive setup again, select *Options* from the Main menu, then select *Interactive Setup*.

If you just want to check your dish pointing coordinates, or run the signal strength meter, select *Dish Pointing* from the Main menu.

TROUBLESHOOTING

HOW SIGNAL FLOW WORKS

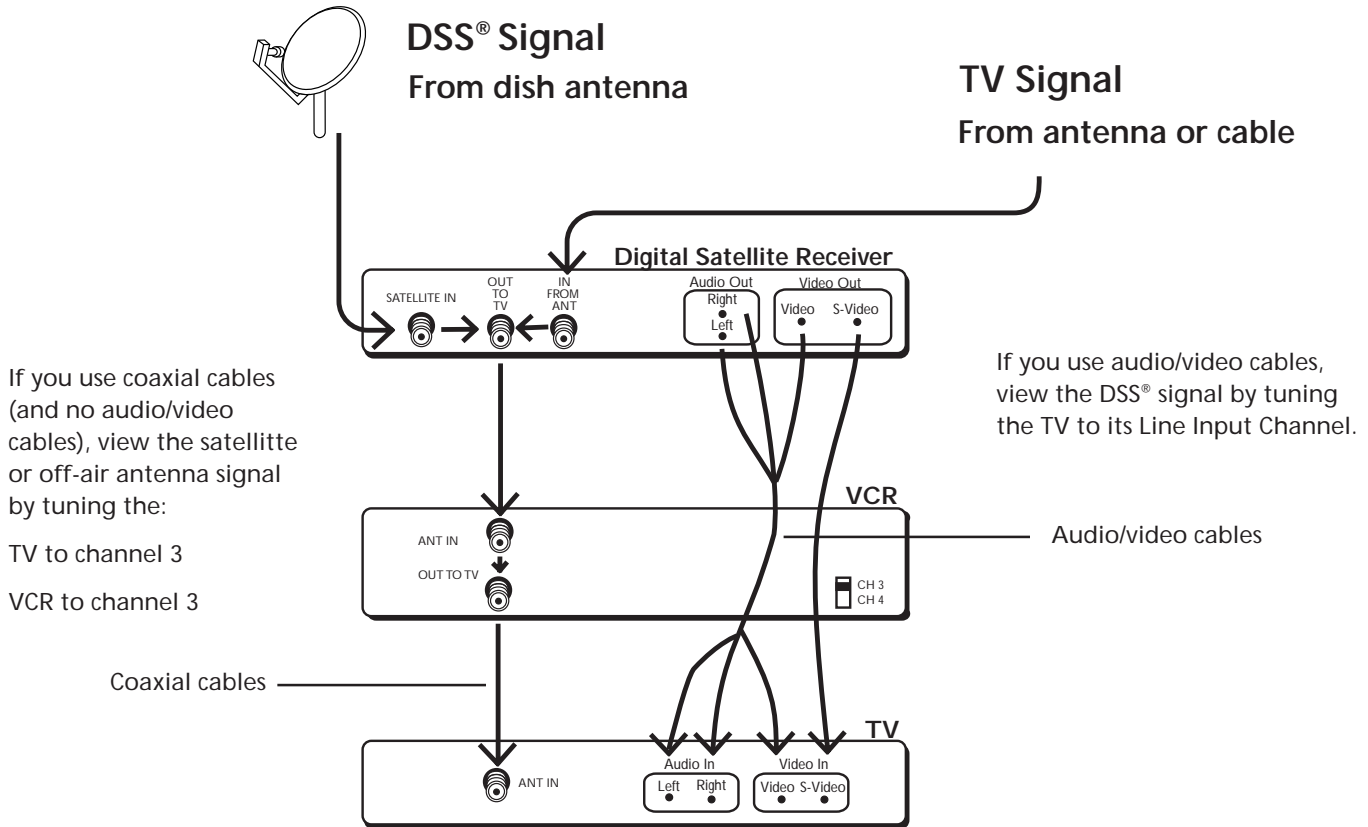

How the Digital Satellite Signals get to Your TV

In the example above:

1. Program providers send signals to your antenna dish.
2. The antenna dish sends the signal to the receiver's SATELLITE IN jack.
3. The signal continues through the coaxial cable to the VCR and then to the TV. (The VCR may seem like an unnecessary link in the chain, but this setup lets you record DSS® programming and off-air antenna/cable programming.)

If you use audio/video cables, the satellite signal also flows through the audio/video cables to the TV's line inputs (left, right, and video or S-video).

How Off-Air Antenna/Cable Signals get to Your TV

In the example above:

1. Off-air/cable broadcasters send signals to your off-air antenna or through cable to your home.
2. The signal passes through the receiver along the coaxial cable to your VCR. The signal can also pass through the VCR to the TV. (The VCR may seem like an unnecessary link in the chain, but this setup lets you record DSS® programming and off-air antenna/cable programming.)

TROUBLESHOOTING

Wrong Signal?

The receiver and most VCRs let you toggle between signals. If you don't see the signal you think you should be seeing, try using these buttons to toggle between the signals:

- Press the TV/VCR button on the VCR remote or on the VCR's front panel.
- Press the ANTENNA button on the remote control.

Taking either of these actions lets you switch the source of the video signal from satellite signals to the off-air antenna or cable signal, and vice versa.

APPENDIX A: WARRANTY INFORMATION

Repair Help

Thomson Consumer Electronics offers hardware repair service if you encounter any problems with your system. Many problems can be diagnosed over the phone, or if necessary a replacement unit can be shipped to you. **Please have your satellite system model, serial number and date of purchase ready when you call.** If your unit is out of warranty, we will quote the cost of an exchange unit to you. Refer to RCA Digital Satellite System Limited Warranty for the repair service phone number.

Returning Equipment to Thomson for Repair or Exchange

If we are unable to resolve your problem over the phone we will gladly service your unit or exchange it for a new or refurbished unit. Refer to the limited warranty in this booklet to learn about your specific rights and responsibilities. *Always consult Thomson and get a Return Authorization number before returning anything.* Obtain a Return Authorization (RA) number from the telephone representative before returning your equipment to avoid delays, accounting errors, or even loss of your unit.

Important Information to Customers Who Ship Defective Equipment to Thomson Consumer Electronics

The Thomson representative who authorizes the return of your equipment will give you an RA number over the phone. The representative will also provide you with instructions on where and how to return your unit. Write the number in large, clear characters on the outside of the box. *To avoid confusion and misunderstandings, shipments without an RA number clearly visible on the outside of the box will be returned to you at your expense.*

Include a brief note describing the problem and any conversations you have had with Thomson personnel about the problem. Include your name, address and model/serial number of your unit. These numbers are located on the back of your receiver. If your satellite system is within the warranty period, please provide a copy of the bill of sale to verify purchase date. Use the original box and packing material to protect the equipment from damage in shipment. **For your protection, insure all shipments for full replacement value and use a reliable shipper.** Thomson assumes no responsibility for warranty shipments from the customer to the factory if not shipped in the manner prescribed by Thomson.

RCA DIGITAL SATELLITE SYSTEM LIMITED WARRANTY

What your warranty covers:

- Any defect in materials or workmanship.

For how long after your purchase:

- 90 days - Unit exchange, which includes parts and labor.
- 91 days to 1 year - Unit exchange, which includes parts only; you pay the labor.
- The warranty for rental units begins with the first rental or 45 days from date of shipment to the rental firm, whichever comes first.

What we will do:

- **During the initial 90 days:**
Exchange the defective portion of your DSS® with a new or, at our option, refurbished unit.
- **After the 90 days and within one year:**
Exchange the defective portion of your DSS® with a new or, at our option, refurbished unit. We will charge you a flat exchange cost to replace a defective receiver. This charge covers the labor cost for its repair.

How you get service:

- Call 1-800-679-4776 and have your unit's date of purchase and model/serial number ready. The model/serial number information is on the back of your receiver.
- A representative will troubleshoot your problem over the phone.
- If the representative determines that you should receive a replacement receiver you will be provided with a Return Authorization (RA) number and the location of a nearby exchange point if one exists. No returns will be accepted without the RA number.
- If the representative determines that your antenna/dish is defective he or she will arrange for its repair or replacement.

To receive a replacement receiver before you return yours:

If you are located near an exchange point:

1. We will send a replacement unit to our exchange point.

APPENDIX A: WARRANTY INFORMATION

2. The exchange location will notify you of its arrival.
3. Take your unit and evidence of purchase date, such as a bill of sale, to the exchange location and you will be provided the new or refurbished unit. Please retain all accessories such as the remote control hand unit.
4. If the repairs are covered by your warranty, you will not be billed.

If you are not located near an exchange point:

1. Provide your Discover, Mastercard or Visa account number and expiration date to your phone representative. This is for security purposes only and your account will not be charged at this time.
2. We will send you a replacement unit.
3. If you return the unit to us within 14 days from the date you were provided a RA number, only items not covered by warranty will be charged to your account. If your unit is not received within 14 days, the suggested retail value of the receiver will be charged to your credit card. This amount will be credited if the unit is subsequently received.
4. Ship your defective unit back to us using the replacement unit's carton. Shipping instructions will be included on the carton along with your RA number which will allow you to easily ship the unit back to us. Make sure you insure your shipment in case of damage or loss. Include with the shipment:
 - Evidence of purchase date such as a bill of sale.
 - A brief note describing your receiver problem.
 - Your name, address and phone number.

Thomson assumes no responsibility of warranty shipments from the customer to the factory if not shipped in the manner prescribed by Thomson.

To receive a replacement receiver after we have received your unit:

- Write the RA number on the outside of the carton used to return the unit. Insure your shipment in case of damage or loss.
- Carefully pack the unit using the original box and packing material if possible. Please retain all accessories that were included with your unit, such as the remote control hand unit.
- Include with the shipment:
 1. Evidence of purchase date such as a bill of sale.
 2. A brief note describing your receiver problem.
 3. Your name, address and phone number.
- The representative will advise the address to mail a cashier's check or money order for payment if there are any out of warranty labor or parts charges, and you elect not to use your credit card.
- After we receive your product, a new or refurbished unit will be shipped to you.

What your warranty *does not* cover:

- Acts of God, such as but not limited to lightning damage.
- Adjustment of customer controls.
- Damage from misuse or neglect.
- A unit that has been modified or incorporated into other products or is used for institutional or other commercial purposes.
- Batteries.
- Units purchased, serviced or operated outside the U.S.A. and Alaska.
- For units intended for use in Alaska, this warranty does not cover installation or the dish antenna. It only covers the receiver.
- Loss of programming.
- Installation.
- Shipping damage if the unit was not packed and shipped in the manner prescribed by Thomson.
- Storage fees may be charged by the exchange point if you fail to pickup the replacement unit in a timely manner.

Product Registration:

- Please complete and mail the Product Registration Card packed with your product. It will make it easier to contact you should it ever be necessary. The return of the card is not required for a warranty coverage.

How state law relates to warranty:

- This warranty gives you specific legal rights and you may have other rights that vary from state to state.

If you purchased your product outside the United States:

- This warranty does not apply. See your dealer for warranty information.

APPENDIX B: FCC REGULATIONS

FCC Registration Information

Your equipment is registered with the Federal Communications Commission and is in compliance with parts 15B and 68, FCC Rules and Regulations.

1. Notification to the Local Telephone Company.

On the bottom of this equipment is a label indicating among other information, the FCC Registration number and Ringer Equivalence Number (REN) for the equipment. You must, upon request, provide this information to your telephone company.

The REN is useful to determine the number of devices you may connect to your telephone line and still have all these devices ring when your telephone number is called. In most (but not all) areas, the sum of the RENs of all devices connected to one line should not exceed 5. To be certain of the number of devices you may connect to your line as determined by the REN, you should contact your local telephone company.

Note: This equipment may not be used on coin service provided by the telephone company. Party lines are subject to state tariffs, and therefore you may not be able to use your own telephone equipment if you are on a party line. Check with your local telephone company.

Notice must be given to the telephone company upon permanent disconnection of your equipment from your line.

2. Rights of the Telephone Company.

Should your equipment cause trouble on your line which may harm the telephone network, the telephone company shall, where practicable, notify you that temporary discontinuance of service may be required. Where prior notice is not practicable and the circumstances warrant such action, the telephone company may temporarily discontinue service immediately. In case of such temporary discontinuance, the telephone company must: (1) promptly notify you of such temporary discontinuance (2) afford you the opportunity to correct the situation and (3) inform you of your right to bring a complaint to the Commission pursuant to procedures set forth in Subpart E of Part 68, FCC Rules and Regulations. The telephone company may make changes in its communications facilities, equipment, operations of procedures where such action is required in the operation of its business and not inconsistent with FCC Rules and Regulations. If these changes are expected to affect the use or performance of your telephone equipment, the telephone company must give you adequate notice, in writing, to allow you to maintain uninterrupted service.

Radio Interference

This equipment has been type tested and found to comply with the limits for a Class B Digital Device in accordance with the specifications in Part 15 of FCC Rules. These rules are designed to provide reasonable protection against radio and television interference in a residential installation. This equipment generates, uses and can radiate radio frequency energy and, if not installed and used in accordance with the instructions, may cause harmful interference to radio communications. However, there is no guarantee that interference will not occur in a particular installation. If this equipment does cause interference to radio or television reception (which you can determine by turning the equipment off and on), try to correct the interference by one or more of the following measures.

- Reorient or relocate the receiving antenna (that is, the antenna for radio or television that is "receiving" the interference).
- Change the position of the satellite receiver with respect to the radio or television equipment that is receiving interference.
- Move the satellite receiver away from equipment receiving interference.
- Plug the satellite receiver into a different wall outlet so the receiver and equipment receiving interference are on different branch circuits.

If these measures do not eliminate interference, please consult your dealer or an experienced radio/television technician for additional suggestions. Also, the Federal Communications Commission has prepared a helpful booklet, "How To Identify and Resolve Radio/TV Interference Problems". This booklet is available from the U.S. Government Printing Office, Washington, D.C. 20402. Please specify stock number 004-000-00345-4 when ordering copies.

APPENDIX C: ACCESSORIES

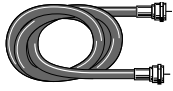

RG-6 Coaxial Burial Cable with weatherproof "F" connectors

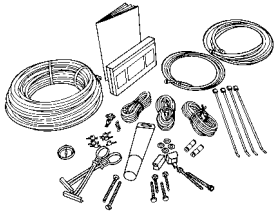

Self-Installer's Kit contains cable and hardware to install the dish and connect the system.

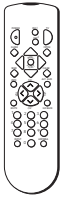

Remote Control replaces a lost remote. Or, order a second remote for convenience.



HCDSS10 Home Control Kit contains a Data Interface that connects to the DSS® receiver, and a lamp module.



HC10LM Lamp module lets you control incandescent lamps. Use to dim/brighten and turn lamps on/off.



HC20AM or HC30AM Appliance modules turn small appliances, like coffee pots, popcorn makers, or stereo, on or off. Also controls non-incandescent lamps. Choose 2 prong (HC20AM) or 3 prong (HC30AM).

Accessory Order Form for Digital Satellite Systems

Description	Part No.	Price	Qty	Total
RG-6 Coaxial Cable				
12 feet	D912	\$12.95		
25 feet	D925	\$15.95		
50 feet	D950	\$21.95		
75 feet	D975	\$29.95		
100 feet	D901	\$35.95		
S-Video Cable 12 feet	D913	\$12.95		
Weatherproof "F" Connector (2)	D905	\$ 5.30		
TVRO Bullet Amplifier	D903	\$24.95		
Self-Installer's Kit	DKIT96	\$69.95		
Remote Control	232579	\$40.45		
Home Control Kit	HCDSS10	\$59.95		
Lamp Module	HC10LM	\$14.95		
2-Prong Appliance Module	HC20AM	\$16.95		
3-Prong Appliance Module	HC30AM	\$16.95		

Prices are subject to change without notice.

Total Merchandise \$ _____

Sales Tax \$ _____

We are required by law to collect the appropriate sales tax for each individual state, country, and locality to which the merchandise is being sent.

Shipping, Handling, and Insurance \$ 5.00

Total Amount Enclosed \$ _____

Use VISA, MasterCard, or Discover preferably.
Money order or check must be in U.S. currency only.
No COD or CASH.



Detach Here

All accessories are subject to availability.

Please complete other side also

APPENDIX C: ACCESSORIES

Charge your order on your VISA, MasterCard, or Discover Card by filling in below

USE YOUR CREDIT CARD

IMPORTANT: Copy complete account number from your VISA card



My card expires:

IMPORTANT: Copy complete account number from your MasterCard



Copy Number above your name on MasterCard My card expires:

IMPORTANT: Copy complete account number from your Discover Card



My card expires:

AUTHORIZED SIGNATURE
 (Credit card order will not be processed without signature)
 Prices are subject to change without notice.

Print or type your name and address clearly.  A complete and correct order will save you days of waiting.

Name: _____

Street: _____

_____ Apt: _____

City: _____

State: _____ Zip: _____

- Please make sure that both sides of this form have been filled out completely.
- Allow 4 weeks for delivery.
 - All accessories are subject to availability.
 - Prices are subject to change

United States and Canada Orders

To place your order by phone, have your Visa, MasterCard or Discover Card ready and call the toll-free number listed below between 8AM and 10PM (EST) Monday through Friday or between 9AM and 5PM (EST) Saturday.

Use this number only to place an order for accessory items listed on this order form.

1-800-338-0376

To place your order by mail, detach and mail the completed order form with credit card information, money order or check in US currency (made payable to Thomson Consumer Electronics, Inc.) to the following address:

Video Accessories
PO Box 8419
Ronks, PA 17573

INDEX

If your DSS® system needs service, please contact your dealer or the nearest Servicenter from the yellow pages. Please do not send any products to the Indianapolis address listed in this manual or on the carton. This will only add delays in service for your product.

10330 North Meridian Street
Indianapolis, IN 46290

 **THOMSON CONSUMER ELECTRONICS**

©1998 Thomson Consumer Electronics, Inc.
Trademark(s)® Registered
Marca(s) Registrada(s)
Printed in USA
TOCOM 15351420

The following materials were used
in printing this publication:



85%

THIS PAPER CONTAINS 85% RECYCLED MATERIAL.

THIS PAPER IS WHITENED BY A TOTALLY
CHLORINE-FREE PROCESS.



**PRINTED WITH
SOY INK™**