

## **EMC Test Report**

### **Application for Grant of Equipment Authorization**

#### **FCC Part 15 Subpart C**

**Model: C61-100**

FCC ID: G95C61

APPLICANT: Technicolor Connected Home USA LLC  
101 W. 103rd St  
Indianapolis, IN 46290

TEST SITE(S): National Technical Systems - Silicon Valley  
41039 Boyce Road.  
Fremont, CA. 94538-2435

IC SITE REGISTRATION #: 2845B-3; 2845B-5, 2845B-7

REPORT DATE: January 13, 2016

REISSUE DATE: January 26, 2016

FINAL TEST DATES: November 24 and 28 and December 11 and 14,  
2015

TOTAL NUMBER OF PAGES: 55

PROGRAM MGR /  
TECHNICAL REVIEWER:

QUALITY ASSURANCE DELEGATE /  
FINAL REPORT PREPARER:



Mark E Hill  
Staff Engineer



David Guidotti  
Senior Technical Writer



National Technical Systems - Silicon Valley is accredited by the A2LA, certificate number 0214.26, to perform the test(s) listed in this report, except where noted otherwise. This report and the information contained herein represent the results of testing test articles identified and selected by the client performed to specifications and/or procedures selected by the client. National Technical Systems (NTS) makes no representations, expressed or implied, that such testing is adequate (or inadequate) to demonstrate efficiency, performance, reliability, or any other characteristic of the articles being tested, or similar products. This report should not be relied upon as an endorsement or certification by NTS of the equipment tested, nor does it represent any statement whatsoever as to its merchantability or fitness of the test article, or similar products, for a particular purpose. This report shall not be reproduced except in full



**REVISION HISTORY**

Rev#	Date	Comments	Modified By
-	January 13, 2016	First release	
1.0	January 26, 2016	Clarified modulation used. Updated reference to spurious emissions limit. Clarified samples used for testing.	MEH

**TABLE OF CONTENTS**

<b>REVISION HISTORY</b> .....	<b>2</b>
<b>TABLE OF CONTENTS</b> .....	<b>3</b>
<b>SCOPE</b> .....	<b>4</b>
<b>OBJECTIVE</b> .....	<b>4</b>
<b>STATEMENT OF COMPLIANCE</b> .....	<b>5</b>
<b>DEVIATIONS FROM THE STANDARDS</b> .....	<b>5</b>
<b>TEST RESULTS SUMMARY</b> .....	<b>6</b>
DIGITAL TRANSMISSION SYSTEMS (2400 – 2483.5MHZ) .....	6
GENERAL REQUIREMENTS APPLICABLE TO ALL BANDS .....	6
MEASUREMENT UNCERTAINTIES .....	7
<b>EQUIPMENT UNDER TEST (EUT) DETAILS</b> .....	<b>8</b>
GENERAL.....	8
ANTENNA SYSTEM .....	8
ENCLOSURE .....	8
MODIFICATIONS .....	8
SUPPORT EQUIPMENT .....	9
EUT INTERFACE PORTS .....	10
EUT OPERATION .....	10
<b>TEST SITE</b> .....	<b>11</b>
GENERAL INFORMATION .....	11
CONDUCTED EMISSIONS CONSIDERATIONS .....	11
RADIATED EMISSIONS CONSIDERATIONS .....	11
<b>MEASUREMENT INSTRUMENTATION</b> .....	<b>12</b>
RECEIVER SYSTEM .....	12
INSTRUMENT CONTROL COMPUTER .....	12
LINE IMPEDANCE STABILIZATION NETWORK (LISN) .....	12
FILTERS/ATTENUATORS .....	13
ANTENNAS.....	13
ANTENNA MAST AND EQUIPMENT TURNTABLE .....	13
INSTRUMENT CALIBRATION.....	13
<b>TEST PROCEDURES</b> .....	<b>14</b>
EUT AND CABLE PLACEMENT .....	14
CONDUCTED EMISSIONS.....	14
RADIATED EMISSIONS .....	14
CONDUCTED EMISSIONS FROM ANTENNA PORT .....	18
BANDWIDTH MEASUREMENTS .....	18
SPECIFICATION LIMITS AND SAMPLE CALCULATIONS .....	19
CONDUCTED EMISSIONS SPECIFICATION LIMITS: FCC 15.207; FCC 15.107(A), RSS GEN .....	19
GENERAL TRANSMITTER RADIATED EMISSIONS SPECIFICATION LIMITS .....	20
OUTPUT POWER LIMITS – DIGITAL TRANSMISSION SYSTEMS .....	20
TRANSMIT MODE SPURIOUS RADIATED EMISSIONS LIMITS – FHSS AND DTS SYSTEMS.....	20
SAMPLE CALCULATIONS - CONDUCTED EMISSIONS .....	20
SAMPLE CALCULATIONS - RADIATED EMISSIONS .....	21
SAMPLE CALCULATIONS - FIELD STRENGTH TO EIRP CONVERSION.....	22
<b>APPENDIX A TEST EQUIPMENT CALIBRATION DATA</b> .....	<b>23</b>
<b>APPENDIX B TEST DATA</b> .....	<b>24</b>
<b>END OF REPORT</b> .....	<b>55</b>

## **SCOPE**

An electromagnetic emissions test has been performed on the Technicolor Connected Home USA LLC model C61-100, pursuant to the following rules:

### FCC Part 15 Subpart C

Conducted and radiated emissions data has been collected, reduced, and analyzed within this report in accordance with measurement guidelines set forth in the following reference standards and as outlined in National Technical Systems - Silicon Valley test procedures:

### ANSI C63.10-2013

### FCC DTS Measurement Guidance KDB558074

The intentional radiator above has been tested in a simulated typical installation to demonstrate compliance with the relevant Industry Canada performance and procedural standards.

Final system data was gathered in a mode that tended to maximize emissions by varying orientation of EUT, orientation of power and I/O cabling, antenna search height, and antenna polarization.

Every practical effort was made to perform an impartial test using appropriate test equipment of known calibration. All pertinent factors have been applied to reach the determination of compliance.

## **OBJECTIVE**

The primary objective of the manufacturer is compliance with the regulations outlined in the previous section.

Prior to marketing in the USA, all unlicensed transmitters and transceivers require certification. Receive-only devices operating between 30 MHz and 960 MHz are subject to either certification or a manufacturer's declaration of conformity, with all other receive-only devices exempt from the technical requirements.

Certification is a procedure where the manufacturer submits test data and technical information to a certification body and receives a certificate or grant of equipment authorization upon successful completion of the certification body's review of the submitted documents. Once the equipment authorization has been obtained, the label indicating compliance must be attached to all identical units, which are subsequently manufactured.

Maintenance of compliance is the responsibility of the manufacturer. Any modification of the product which may result in increased emissions should be checked to ensure compliance has been maintained (i.e., printed circuit board layout changes, different line filter, different power supply, harnessing or I/O cable changes, etc.).

**STATEMENT OF COMPLIANCE**

The tested sample of Technicolor Connected Home USA LLC model C61-100 complied with the requirements of the following regulations:

FCC Part 15 Subpart C

Maintenance of compliance is the responsibility of the manufacturer. Any modifications to the product should be assessed to determine their potential impact on the compliance status of the device with respect to the standards detailed in this test report.

The test results recorded herein are based on a single type test of Technicolor Connected Home USA LLC model C61-100 and therefore apply only to the tested sample. The sample was selected and prepared by Rodolfo Rascon of Technicolor Connected Home USA LLC.

**DEVIATIONS FROM THE STANDARDS**

No deviations were made from the published requirements listed in the scope of this report.

## TEST RESULTS SUMMARY

### DIGITAL TRANSMISSION SYSTEMS (2400 – 2483.5MHz)

FCC Rule Part	RSS Rule Part	Description	Measured Value / Comments	Limit / Requirement	Result
15.247(a)	RSS 210 A8.2	Digital Modulation	Systems uses OQPSK modulation	System must utilize a digital transmission technology	Complies
15.247 (a) (2)	RSS 210 A8.2 (1)	6dB Bandwidth	1.56 MHz	>500kHz	Complies
15.247 (b) (3)	RSS 210 A8.2 (4)	Output Power (multipoint systems)	4.6dBm (3.1mW) EIRP = 7.9 mW <small>Note 1</small>	1Watt, EIRP limited to 4 Watts.	Complies
15.247(d)	RSS 210 A8.2 (2)	Power Spectral Density	-12.7 dBm/3kHz	8dBm/3kHz	Complies
15.247(c) / 15.209	RSS 210 A8.5	Radiated Spurious Emissions 30MHz – 25 GHz	45.5 dB $\mu$ V/m @ 240.30 MHz (-0.5 dB)	15.209 in restricted bands, all others < -20dBc	Complies
Note 1: Conducted power calculated from EIRP measurement and antenna gain of 3.0dBi.					

### GENERAL REQUIREMENTS APPLICABLE TO ALL BANDS

FCC Rule Part	RSS Rule part	Description	Measured Value / Comments	Limit / Requirement	Result (margin)
15.203	-	RF Connector	Antennas are integral to the internal PCB	Unique or integral antenna required	Complies
15.207	RSS GEN Table 3	AC Conducted Emissions	51.1dB $\mu$ V @ 0.55MHz (-4.9dB)	Refer to page 19	Complies
15.247 (b) (5) / 15.407 (f)	RSS 102	RF Exposure Requirements	Refer to MPE calculations in separate exhibit	Refer to OET 65, FCC Part 1 and RSS 102	Complies

**MEASUREMENT UNCERTAINTIES**

ISO/IEC 17025 requires that an estimate of the measurement uncertainties associated with the emissions test results be included in the report. The measurement uncertainties given below are based on a 95% confidence level and were calculated in accordance with UKAS document LAB 34.

Measurement Type	Measurement Unit	Frequency Range	Expanded Uncertainty
RF power, conducted (power meter)	dBm	25 to 7000 MHz	± 0.52 dB
RF power, conducted (Spectrum analyzer)	dBm	25 to 7000 MHz	± 0.7 dB
Conducted emission of transmitter	dBm	25 to 26500 MHz	± 0.7 dB
Conducted emission of receiver	dBm	25 to 26500 MHz	± 0.7 dB
Radiated emission (substitution method)	dBm	25 to 26500 MHz	± 2.5 dB
Radiated emission (field strength)	dB $\mu$ V/m	25 to 1000 MHz	± 3.6 dB
		1000 to 40000 MHz	± 6.0 dB
Conducted Emissions (AC Power)	dB $\mu$ V	0.15 to 30 MHz	± 2.4 dB

**EQUIPMENT UNDER TEST (EUT) DETAILS****GENERAL**

The Technicolor Connected Home USA LLC model C61-100 is a high definition set top box, with MoCA 2.0 and RF4CE. Since the EUT would be placed on a tabletop during operation, the EUT was treated as tabletop equipment during testing to simulate the end-user environment. The electrical rating of the EUT is 100-240V, 50/60Hz, 0.5 Amps.

The sample was received on November 24, 2015 and tested on November 24 and 28 and December 11 and 14, 2015. The EUT consisted of the following component(s):

Company	Model	Description	Serial Number	FCC ID
Technicolor	C61-100	DIRECTV Home Client	A61LA5PX100017 (15.C and CE)	G95C61
DIRECTV	EPS10R3-15	AC/DC Adapter	CL10G1533A2389	-

**ANTENNA SYSTEM**

The EUT uses two pcb trace antennas, 3dBi gain, configured for transmit diversity.

**ENCLOSURE**

The EUT enclosure is primarily constructed of plastic. It measures approximately 15 cm wide by 9.5 cm deep by 3 cm high.

**MODIFICATIONS**

No modifications were made to the EUT during the time the product was at NTS Silicon Valley.



**SUPPORT EQUIPMENT**

The following equipment was used as local support equipment for testing:

## Test Configuration #1

Company	Model	Description	Serial Number	FCC ID
JVC	EM39FT	TV	TA1SEI042503850	-

The following equipment was used as remote support equipment for testing:

## Test Configuration #1

Company	Model	Description	Serial Number	FCC ID
Technicolor	H44	DVR STB	T30LA5DR110104	-
DIRECTV	EPS44R3-16	AC/DC Adapter	DD44C1506A8021	-
Seagate	SRD00F1	SSD	NA70907P	-

**EUT INTERFACE PORTS**

The I/O cabling configuration during testing was as follows:

**Test Configuration #1**

Port		Cable(s)		
From	To	Description	Shielded/Unshielded	Length(m)
Network	DVR STB - SAT IN	COAX	Shielded	20
HDMI	TV	Multiconductor	Shielded	
A/V Out	TV	Multiconductor	Shielded	
USB	Not Connected*	-	-	-
Digital Audio (optical)	Not Connected	-	-	-
Power In	AC/DC Adapter	Multiconductor (w/molded ferrite at EUT)	Shielded	1.8
AC/DC Adapter	AC Mains	2wire	Unshielded	1.7

Note, the USB port is not supported at this time.

**EUT OPERATION****Test Configuration #1**

During testing, the EUT was configured to transmit a modulated signal on the noted channel at the maximum power setting.

**TEST SITE****GENERAL INFORMATION**

Final test measurements were taken at the test sites listed below. Pursuant to section 2.948 of the FCC's Rules and section 3.3 of RSP-100, construction, calibration, and equipment data has been filed with the Commission and with industry Canada.

Site	Designation / Registration Numbers		Location
	FCC	Canada	
Chamber 3	US0027	2845B-3	41039 Boyce Road Fremont, CA 94538-2435
Chamber 5	US0027	2845B-5	
Chamber 7	US0027	2845B-7	

ANSI C63.4 recommends that ambient noise at the test site be at least 6 dB below the allowable limits. Ambient levels are below this requirement. The test site(s) contain separate areas for radiated and conducted emissions testing. Considerable engineering effort has been expended to ensure that the facilities conform to all pertinent requirements of ANSI C63.4.

**CONDUCTED EMISSIONS CONSIDERATIONS**

Conducted emissions testing is performed in conformance with ANSI C63.10. Measurements are made with the EUT connected to the public power network through a nominal, standardized RF impedance, which is provided by a line impedance stabilization network, known as a LISN. A LISN is inserted in series with each current-carrying conductor in the EUT power cord.

**RADIATED EMISSIONS CONSIDERATIONS**

The FCC has determined that radiation measurements made in a shielded enclosure are not suitable for determining levels of radiated emissions. Radiated measurements are performed in an open field environment or in a semi-anechoic chamber. The test sites are maintained free of conductive objects within the CISPR defined elliptical area incorporated in ANSI C63.4 guidelines and meet the Normalized Site Attenuation (NSA) requirements of ANSI C63.4.

## **MEASUREMENT INSTRUMENTATION**

### **RECEIVER SYSTEM**

An EMI receiver as specified in CISPR 16-1-1 is used for emissions measurements. The receivers used can measure over the frequency range of 9 kHz up to 2000 MHz. These receivers allow both ease of measurement and high accuracy to be achieved. The receivers have Peak, Average, and CISPR (Quasi-peak) detectors built into their design so no external adapters are necessary. The receiver automatically sets the required bandwidth for the CISPR detector used during measurements. If the repetition frequency of the signal being measured is below 20Hz, peak measurements are made in lieu of Quasi-Peak measurements.

For measurements above the frequency range of the receivers, a spectrum analyzer is utilized because it provides visibility of the entire spectrum along with the precision and versatility required to support engineering analysis. Average measurements above 1000MHz are performed on the spectrum analyzer using the linear-average method with a resolution bandwidth of 1 MHz and a video bandwidth of 10 Hz, unless the signal is pulsed in which case the average (or video) bandwidth of the measuring instrument is reduced to onset of pulse desensitization and then increased.

### **INSTRUMENT CONTROL COMPUTER**

The receivers utilize either a Rohde & Schwarz EZM Spectrum Monitor/Controller or contain an internal Spectrum Monitor/Controller to view and convert the receiver measurements to the field strength at an antenna or voltage developed at the LISN measurement port, which is then compared directly with the appropriate specification limit. This provides faster, more accurate readings by performing the conversions described under Sample Calculations within the Test Procedures section of this report. Results are printed in a graphic and/or tabular format, as appropriate. A personal computer is used to record all measurements made with the receivers. The software used for radiated and conducted emissions measurements is NTS EMI Test Software (rev 2.10)

The Spectrum Monitor provides a visual display of the signal being measured. In addition, the controller or a personal computer run automated data collection programs which control the receivers. This provides added accuracy since all site correction factors, such as cable loss and antenna factors are added automatically.

### **LINE IMPEDANCE STABILIZATION NETWORK (LISN)**

Line conducted measurements utilize a fifty microhenry Line Impedance Stabilization Network as the monitoring point. The LISN used also contains a 250 uH CISPR adapter. This network provides for calibrated radio frequency noise measurements by the design of the internal low pass and high pass filters on the EUT and measurement ports, respectively.

**FILTERS/ATTENUATORS**

External filters and precision attenuators are often connected between the receiving antenna or LISN and the receiver. This eliminates saturation effects and non-linear operation due to high amplitude transient events.

**ANTENNAS**

A loop antenna is used below 30 MHz. For the measurement range 30 MHz to 1000 MHz either a combination of a biconical antenna and a log periodic or a bi-log antenna is used. Above 1000 MHz, horn antennas are used. The antenna calibration factors to convert the received voltage to an electric field strength are included with appropriate cable loss and amplifier gain factors to determine an overall site factor, which is then programmed into the test receivers or incorporated into the test software.

**ANTENNA MAST AND EQUIPMENT TURNTABLE**

The antennas used to measure the radiated electric field strength are mounted on a non-conductive antenna mast equipped with a motor-drive to vary the antenna height. Measurements below 30 MHz are made with the loop antenna at a fixed height of 1m above the ground plane.

ANSI C63.10 specifies that the test height above ground for table mounted devices shall be 80 centimeters. Floor mounted equipment shall be placed on the ground plane if the device is normally used on a conductive floor or separated from the ground plane by insulating material from 3 to 12 mm if the device is normally used on a non-conductive floor as specified in ANSI C63.4. During radiated measurements, the EUT is positioned on a motorized turntable in conformance with this requirement.

**INSTRUMENT CALIBRATION**

All test equipment is regularly checked to ensure that performance is maintained in accordance with the manufacturer's specifications. All antennas are calibrated at regular intervals with respect to tuned half-wave dipoles. An exhibit of this report contains the list of test equipment used and calibration information.

## TEST PROCEDURES

### EUT AND CABLE PLACEMENT

The regulations require that interconnecting cables be connected to the available ports of the unit and that the placement of the unit and the attached cables simulate the worst case orientation that can be expected from a typical installation, so far as practicable. To this end, the position of the unit and associated cabling is varied within the guidelines of ANSI C63.10, and the worst-case orientation is used for final measurements.

### CONDUCTED EMISSIONS

Conducted emissions are measured at the plug end of the power cord supplied with the EUT. Excess power cord length is wrapped in a bundle between 30 and 40 centimeters in length near the center of the cord. Preliminary measurements are made to determine the highest amplitude emission relative to the specification limit for all the modes of operation. Placement of system components and varying of cable positions are performed in each mode. A final peak mode scan is then performed in the position and mode for which the highest emission was noted on all current carrying conductors of the power cord.

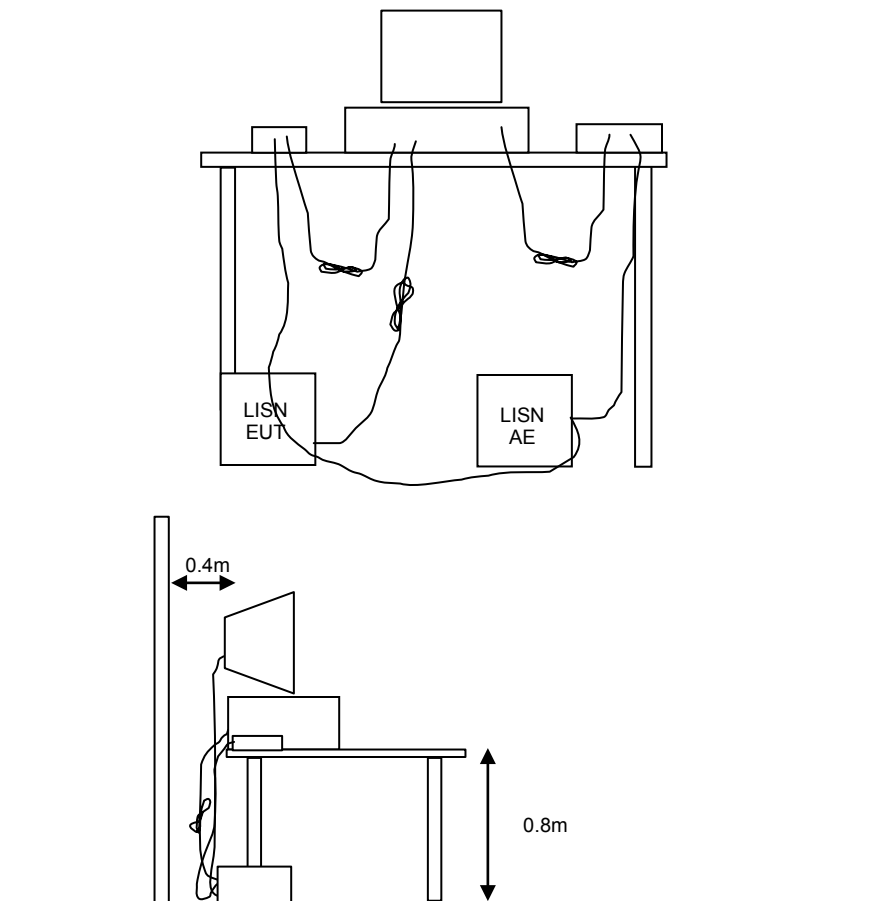

Figure 1 Typical Conducted Emissions Test Configuration

**RADIATED EMISSIONS**

A preliminary scan of the radiated emissions is performed in which all significant EUT frequencies are identified with the system in a nominal configuration. At least two scans are performed, one scan for each antenna polarization (horizontal and vertical; loop parallel and perpendicular to the EUT). During the preliminary scans, the EUT is rotated through 360°, the antenna height is varied (for measurements above 30 MHz) and cable positions are varied to determine the highest emission relative to the limit. Preliminary scans may be performed in a fully anechoic chamber for the purposes of identifying the frequencies of the highest emissions from the EUT.

A speaker is provided in the receiver to aid in discriminating between EUT and ambient emissions. Other methods used during the preliminary scan for EUT emissions involve scanning with near field magnetic loops, monitoring I/O cables with RF current clamps, and cycling power to the EUT.

Final maximization is a phase in which the highest amplitude emissions identified in the spectral search are viewed while the EUT azimuth angle is varied from 0 to 360 degrees relative to the receiving antenna. The azimuth, which results in the highest emission is then maintained while varying the antenna height from one to four meters (for measurements above 30 MHz, measurements below 30 MHz are made with the loop antenna at a fixed height of 1m). The result is the identification of the highest amplitude for each of the highest peaks. Each recorded level is corrected in the receiver using appropriate factors for cables, connectors, antennas, and preamplifier gain.

When testing above 18 GHz, the receive antenna is located at 1 meter from the EUT and the antenna height is restricted to a maximum of 2.5 meters.

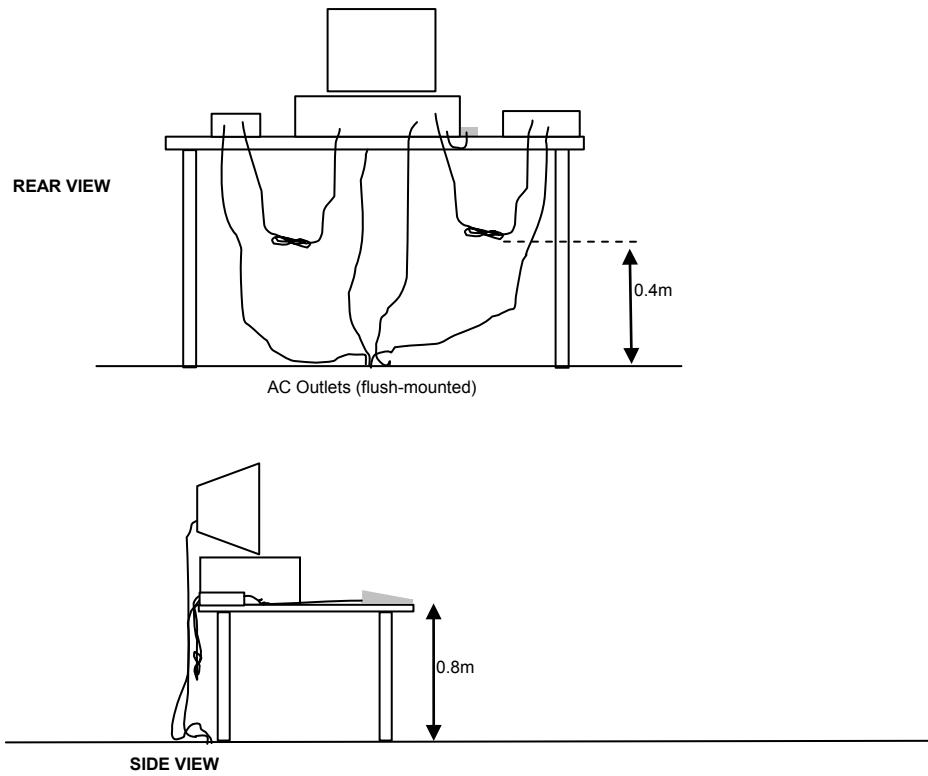

Typical Test Configuration for Radiated Field Strength Measurements



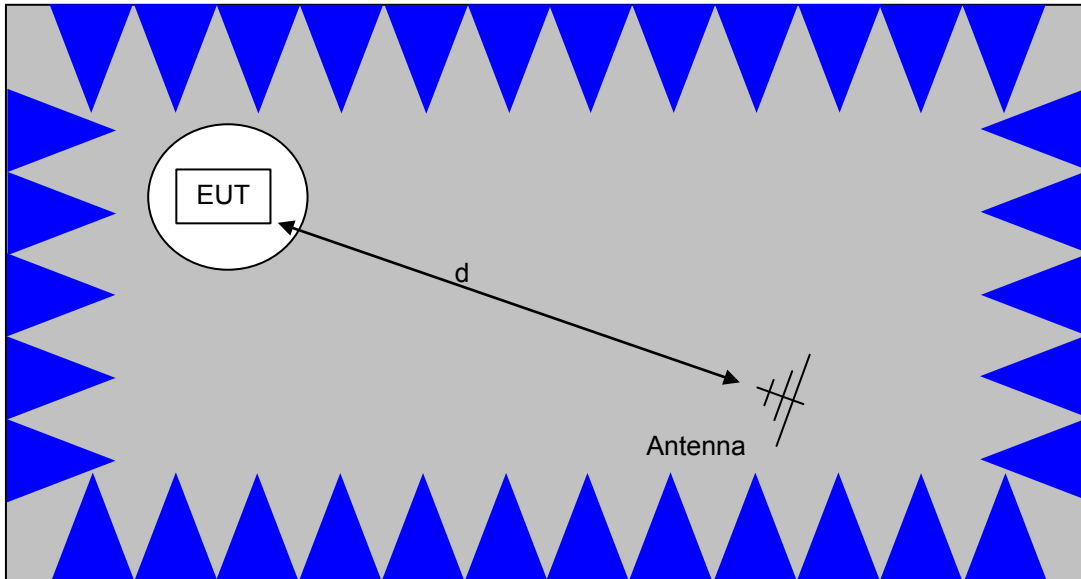

The anechoic materials on the walls and ceiling ensure compliance with the normalized site attenuation requirements of CISPR 16 / CISPR 22 / ANSI C63.4 for an alternate test site at the measurement distances used.

Floor-standing equipment is placed on the floor with insulating supports between the unit and the ground plane.

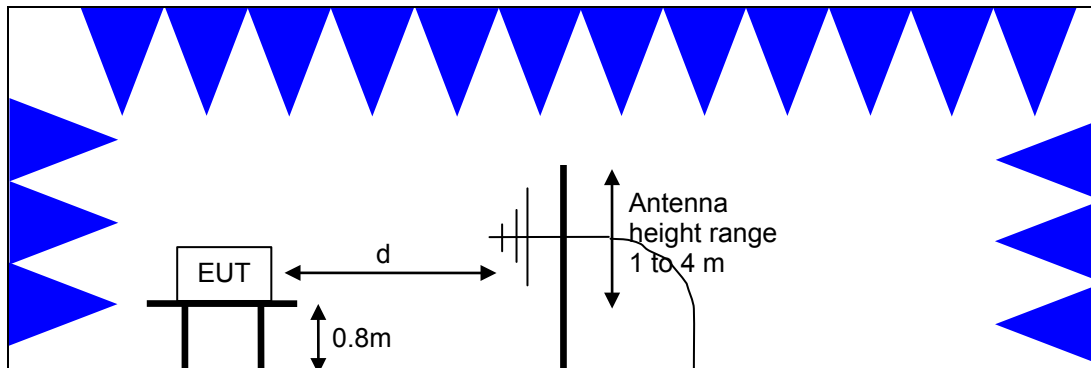

Test Configuration for Radiated Field Strength Measurements  
Semi-Anechoic Chamber, Plan and Side Views

**CONDUCTED EMISSIONS FROM ANTENNA PORT**

Direct measurements of power, bandwidth and power spectral density are performed, where possible, with the antenna port of the EUT connected to either the power meter or spectrum analyzer via a suitable attenuator and/or filter. These are used to ensure that the front end of the measurement instrument is not overloaded by the fundamental transmission.

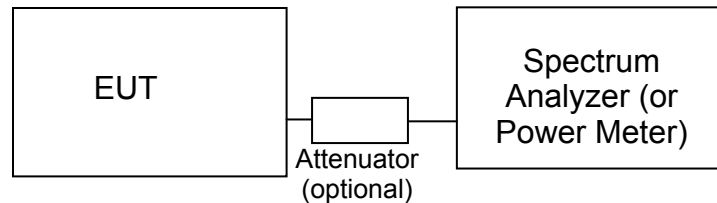
Test Configuration for Antenna Port Measurements

Measurement bandwidths (video and resolution) are set in accordance with the relevant standards and NTS Silicon Valley's test procedures for the type of radio being tested. When power measurements are made using a resolution bandwidth less than the signal bandwidth the power is calculated by summing the power across the signal bandwidth using either the analyzer channel power function or by capturing the trace data and calculating the power using software. In both cases the summed power is corrected to account for the equivalent noise bandwidth (ENBW) of the resolution bandwidth used.

If power averaging is used (typically for certain digital modulation techniques), the EUT is configured to transmit continuously. Power averaging is performed using either the built-in function of the analyzer or, if the analyzer does not feature power averaging, using external software. In both cases the average power is calculated over a number of sweeps (typically 100). When the EUT cannot be configured to continuously transmit then either the analyzer is configured to perform a gated sweep to ensure that the power is averaged over periods that the device is transmitting or power averaging is disabled and a max-hold feature is used.

If a power meter is used to make output power measurements the sensor head type (peak or average) is stated in the test data table.

**BANDWIDTH MEASUREMENTS**

The 6dB, 20dB, 26dB and/or 99% signal bandwidth are measured using the bandwidths recommended by ANSI C63.10 and RSS GEN.

**SPECIFICATION LIMITS AND SAMPLE CALCULATIONS**

The limits for conducted emissions are given in units of microvolts, and the limits for radiated emissions are given in units of microvolts per meter at a specified test distance. Data is measured in the logarithmic form of decibels relative to one microvolt, or dB microvolts (dBuV). For radiated emissions, the measured data is converted to the field strength at the antenna in dB microvolts per meter (dBuV/m). The results are then converted to the linear forms of uV and uV/m for comparison to published specifications.

For reference, converting the specification limits from linear to decibel form is accomplished by taking the base ten logarithm, then multiplying by 20. These limits in both linear and logarithmic form are as follows:

**CONDUCTED EMISSIONS SPECIFICATION LIMITS: FCC 15.207; FCC 15.107(a), RSS GEN**

The table below shows the limits for the emissions on the AC power line from an intentional radiator and a receiver.

Frequency (MHz)	Average Limit (dBuV)	Quasi Peak Limit (dBuV)
0.150 to 0.500	Linear decrease on logarithmic frequency axis between 56.0 and 46.0	Linear decrease on logarithmic frequency axis between 66.0 and 56.0
0.500 to 5.000	46.0	56.0
5.000 to 30.000	50.0	60.0

### GENERAL TRANSMITTER RADIATED EMISSIONS SPECIFICATION LIMITS

The table below shows the limits for the spurious emissions from transmitters that fall in restricted bands<sup>1</sup>.

Frequency Range (MHz)	Limit (uV/m)	Limit (dBuV/m @ 3m)
0.009-0.490	2400/F <sub>KHz</sub> @ 300m	67.6-20*log <sub>10</sub> (F <sub>KHz</sub> ) @ 300m
0.490-1.705	24000/F <sub>KHz</sub> @ 30m	87.6-20*log <sub>10</sub> (F <sub>KHz</sub> ) @ 30m
1.705 to 30	30 @ 30m	29.5 @ 30m
30 to 88	100 @ 3m	40 @ 3m
88 to 216	150 @ 3m	43.5 @ 3m
216 to 960	200 @ 3m	46.0 @ 3m
Above 960	500 @ 3m	54.0 @ 3m

### OUTPUT POWER LIMITS – DIGITAL TRANSMISSION SYSTEMS

The table below shows the limits for output power and output power density.

Operating Frequency (MHz)	Output Power	Power Spectral Density
2400 – 2483.5	1 Watt (30 dBm)	8 dBm/3kHz

The maximum permitted output power is reduced by 1dB for every dB the antenna gain exceeds 6dBi. Fixed point-to-point applications using the 5725 – 5850 MHz band are not subject to this restriction.

### TRANSMIT MODE SPURIOUS RADIATED EMISSIONS LIMITS – FHSS and DTS SYSTEMS

The limits for unwanted (spurious) emissions from the transmitter falling in the restricted bands are those specified in the general limits sections of FCC Part 15 and RSS GEN. All other unwanted (spurious) emissions shall be at least 20dB below the level of the highest in-band signal level (30dB if the power is measured using the sample detector/power averaging method).

### SAMPLE CALCULATIONS - CONDUCTED EMISSIONS

Receiver readings are compared directly to the conducted emissions specification limit (decibel form) as follows:

$$R_r - S = M$$

where:

$R_r$  = Receiver Reading in dBuV

$S$  = Specification Limit in dBuV

$M$  = Margin to Specification in +/- dB

<sup>1</sup> The restricted bands are detailed in FCC 15.205, RSS-GEN Table 3

**SAMPLE CALCULATIONS - RADIATED EMISSIONS**

Receiver readings are compared directly to the specification limit (decibel form). The receiver internally corrects for cable loss, preamplifier gain, and antenna factor. The calculations are in the reverse direction of the actual signal flow, thus cable loss is added and the amplifier gain is subtracted. The Antenna Factor converts the voltage at the antenna coaxial connector to the field strength at the antenna elements.

A distance factor, when used for electric field measurements above 30MHz, is calculated by using the following formula:

$$F_d = 20 * \text{LOG}_{10} (D_m/D_s)$$

where:

$$F_d = \text{Distance Factor in dB}$$

$$D_m = \text{Measurement Distance in meters}$$

$$D_s = \text{Specification Distance in meters}$$

For electric field measurements below 30MHz the extrapolation factor is either determined by making measurements at multiple distances or a theoretical value is calculated using the formula:

$$F_d = 40 * \text{LOG}_{10} (D_m/D_s)$$

Measurement Distance is the distance at which the measurements were taken and Specification Distance is the distance at which the specification limits are based. The antenna factor converts the voltage at the antenna coaxial connector to the field strength at the antenna elements.

The margin of a given emission peak relative to the limit is calculated as follows:

$$R_c = R_r + F_d$$

and

$$M = R_c - L_s$$

where:

$$R_r = \text{Receiver Reading in dBuV/m}$$

$$F_d = \text{Distance Factor in dB}$$

$$R_c = \text{Corrected Reading in dBuV/m}$$

$$L_s = \text{Specification Limit in dBuV/m}$$

$$M = \text{Margin in dB Relative to Spec}$$

**SAMPLE CALCULATIONS - FIELD STRENGTH TO EIRP CONVERSION**

Where the radiated electric field strength is expressed in terms of the equivalent isotropic radiated power (eirp), or where a field strength measurement of output power is made in lieu of a direct measurement, the following formula is used to convert between eirp and field strength at a distance of d (meters) from the equipment under test:

$$E = \frac{1000000 \sqrt{30 P}}{d} \text{ microvolts per meter}$$

where P is the eirp (Watts)

For a measurement at 3m the conversion from a logarithmic value for field strength (dBuV/m) to an eirp power (dBm) is -95.3dB.

## Appendix A Test Equipment Calibration Data

<u>Manufacturer</u>	<u>Description</u>	<u>Model</u>	<u>Asset #</u>	<u>Calibrated</u>	<u>Cal Due</u>
<b>Radiated Emissions, 30 - 1,000 MHz, 24-Nov-15</b>					
Sunol Sciences	Biconilog, 30-3000 MHz	JB3	1657	6/25/2014	6/25/2016
Rohde & Schwarz	EMI Test Receiver, 20 Hz-7 GHz	ESIB7	1756	6/20/2015	6/20/2016
Com-Power	Preamplifier, 30-1000 MHz	PA-103	2465	9/1/2015	9/1/2016
<b>Radiated Emissions, 30 - 25,000 MHz, 28-Nov-15</b>					
Hewlett Packard	Microwave Preamplifier, 1-26.5GHz	8449B	870	2/20/2015	2/20/2016
Hewlett Packard	Spectrum Analyzer (SA40) Red 30 Hz -40 GHz	8564E (84125C)	1148	10/17/2015	10/17/2016
EMCO	Antenna, Horn, 1-18 GHz	3115	1561	6/27/2014	6/27/2016
A. H. Systems	Purple System Horn, 18-40GHz	SAS-574, p/n: 2581	2160	8/28/2014	8/28/2017
<b>Radiated Emissions, 30 - 1,000 MHz, 11-Dec-15</b>					
Sunol Sciences	Biconilog, 30-3000 MHz	JB3	1657	6/25/2014	6/25/2016
Rohde & Schwarz	EMI Test Receiver, 20 Hz-7 GHz	ESIB7	1756	6/20/2015	6/20/2016
Com-Power	Preamplifier, 30-1000 MHz	PA-103	2465	9/1/2015	9/1/2016
<b>Fundamental and Tx Spurious Emissions, 14-Dec-15</b>					
Hewlett Packard	Microwave Preamplifier, 1-26.5GHz	8449B	870	2/20/2015	2/20/2016
Hewlett Packard	Spectrum Analyzer (SA40) Red 30 Hz -40 GHz	8564E (84125C)	1148	10/17/2015	10/17/2016
Rohde & Schwarz	EMI Test Receiver, 20 Hz-7 GHz	ESIB7	1538	12/20/2014	12/20/2015
EMCO	Antenna, Horn, 1-18 GHz	3115	1561	6/27/2014	6/27/2016
Micro-Tronics	Band Reject Filter, 2400-2500 MHz	BRM50702-02	2238	9/16/2015	9/16/2016
<b>Radiated Emissions, 30 - 25,000 MHz, 14-Dec-15</b>					
Hewlett Packard	Spectrum Analyzer (SA40) Red 30 Hz -40 GHz	8564E (84125C)	1148	10/17/2015	10/17/2016
Rohde & Schwarz	EMI Test Receiver, 20 Hz-7 GHz	ESIB7	1538	12/20/2014	12/20/2015
Sunol Sciences	Biconilog, 30-3000 MHz	JB3	1549	6/2/2015	6/2/2017
EMCO	Antenna, Horn, 1-18 GHz	3115	1561	6/27/2014	6/27/2016
A. H. Systems	Purple System Horn, 18-40GHz	SAS-574, p/n: 2581	2160	8/28/2014	8/28/2017
Micro-Tronics	Band Reject Filter, 2400-2500 MHz	BRM50702-02	2238	9/16/2015	9/16/2016
Hewlett Packard	9KHz-1300MHz pre-amp	8447F	2777	3/4/2015	3/5/2016
<b>Conducted Emissions - AC Power Ports, 14-Dec-15</b>					
Rohde & Schwarz	EMI Test Receiver, 20 Hz-7 GHz	ESIB7	1538	12/20/2014	12/20/2015
Rohde & Schwarz	Pulse Limiter	ESH3 Z2	1594	5/14/2015	5/14/2016
Fischer Custom Comm	LISN, 25A, 150kHz to 30MHz, 25 Amp,	FCC-LISN-50-25-2-09	2001	7/24/2015	7/24/2016
Com-Power	9KHz-30MHz, 50uH, 15Aac, 10Adc, max CISPR 15	LI-215A	2671	6/26/2015	6/26/2016

## **Appendix B Test Data**

T100110 Pages 25 – 54





## ***EMC Test Data***

Client:	Technicolor Connected Home	Job Number:	JD100094
Product	C61-100	T-Log Number:	T100110
System Configuration:		Project Manager:	Christine Krebill
Contact:	Rodolfo Rascon	Project Coordinator:	
Emissions Standard(s):	FCC 15.B / 15.247	Class:	B
Immunity Standard(s):	-	Environment:	-

# **EMC Test Data**

For The

## **Technicolor Connected Home**

Product

**C61-100**

Date of Last Test: 1/8/2016

Client: Technicolor Connected Home	Job Number: JD100094
Model: C61-100	T-Log Number: T100110
Contact: Rodolfo Rascon	Project Manager: Christine Krebill
Standard: FCC 15.B / 15.247	Project Coordinator: -
	Class: N/A

## Duty Cycle

Date of Test: 12/14/2015  
 Test Engineer: Mark Hill  
 Test Location: FT Chamber #7

Duty cycle measurements performed on the worse case data rate for power.

Notes: Measurements taken with maximum RBW/VBW settings allowed.

Mode	Data Rate	Duty Cycle (x)	Constant DC?	T (ms)	Pwr Cor Factor*	Lin Volt Cor Factor**	Min VBW for FS (Hz)
RF4CE	-	100.00	Yes	N/A	0	0	10

\* Correction factor when using RMS/Power averaging -  $10 \cdot \log(1/x)$

\*\* Correction factor when using linear voltage average -  $20 \cdot \log(1/x)$

T = Minimum transmission duration

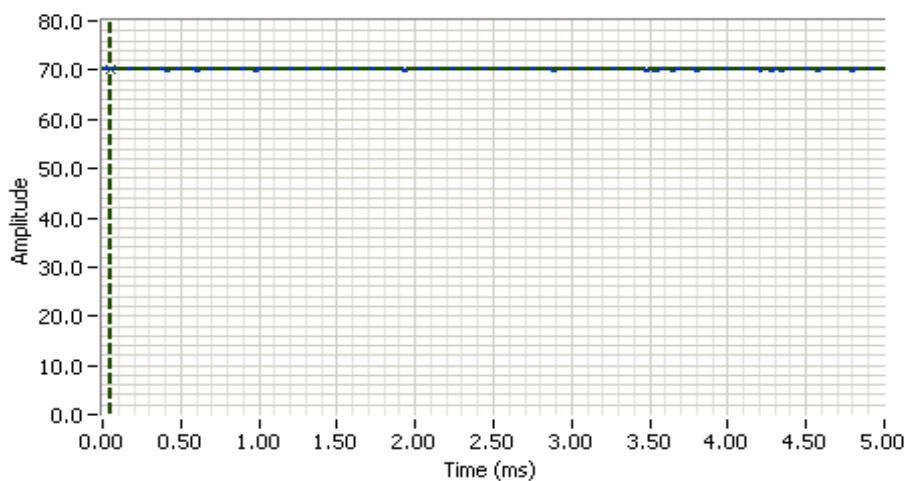

**Analyzer Settings**  
 Rohde&Schwarz, ESI  
 CF: 2450.000 MHz  
 SPAN: 0.000 MHz  
 RB: 10.000 MHz  
 VB: 10.000 MHz  
 Detector: POS  
 Attn: 0 DB  
 RL Offset: 0.0 DB  
 Sweep Time: 5.0ms  
 Ref Lvl: 76.0 DBUV

**Comments**  
 Duty Cycle

Cursor 1 0.0501 70.06

0.0000 0.00



# EMC Test Data

Client:	Technicolor Connected Home	Job Number:	JD100094
Model:	C61-100	T-Log Number:	T100110
Contact:	Rodolfo Rascon	Project Manager:	Christine Krebill
Standard:	FCC 15.B / 15.247	Project Coordinator:	-
		Class:	N/A

## RSS-247 and FCC 15.247 (DTS) Radiated Spurious Emissions

### Test Specific Details

Objective: The objective of this test session is to perform final qualification testing of the EUT with respect to the specification listed above.

### General Test Configuration

The EUT and all local support equipment were located on the turntable for radiated spurious emissions testing. For radiated emissions testing the measurement antenna was located 3 meters from the EUT, unless otherwise noted.

### Ambient Conditions:

Temperature: 21.6 °C  
Rel. Humidity: 38 %

### Summary of Results - Device Operating in the 2400-2483.5 MHz Band

Run #	Mode	Channel	Target Power	Power Setting	Test Performed	Limit	Result / Margin
1	RF4CE	2425MHz	3	3	Restricted Band Edge (2390 MHz)	FCC Part 15.209 / 15.247( c)	30.4 dBµV/m @ 2385.0 MHz (-23.6 dB)
	RF4CE	2475MHz	3	3	Restricted Band Edge (2483.5 MHz)	FCC Part 15.209 / 15.247( c)	30.0 dBµV/m @ 2377.1 MHz (-24.0 dB)

### Modifications Made During Testing

No modifications were made to the EUT during testing

### Deviations From The Standard

No deviations were made from the requirements of the standard.

### Sample Notes

Sample S/N: A61LA5PX100017

Driver:

Antenna: Internal



# EMC Test Data

Client: Technicolor Connected Home	Job Number: JD100094
Model: C61-100	T-Log Number: T100110
	Project Manager: Christine Krebill
Contact: Rodolfo Rascon	Project Coordinator: -
Standard: FCC 15.B / 15.247	Class: N/A

### Procedure Comments:

Measurements performed in accordance with FCC KDB 558074

Peak measurements performed with: RBW=1MHz, VBW=3MHz, peak detector, max hold, auto sweep time

Unless otherwise stated/noted, emission has a duty cycle  $\geq 98\%$  and was measured using RBW=1MHz, VBW=10Hz, peak detector, linear average mode, auto sweep time, max hold.

Mode	Data Rate	Duty Cycle (x)	Constant DC?	T (ms)	Pwr Cor Factor*	Lin Volt Cor Factor**	Min VBW for FS (Hz)
RF4CE	-	100.00	Yes	N/A	0	0	10

### Measurement Specific Notes:

Note 1:	Emission in non-restricted band, but limit of 15.209 used.
Note 2:	Emission in non-restricted band, the limit was set 30dB below the level of the fundamental and measured in 100kHz.
Note 8:	Plots of the average and peak bandedge do not account for any duty cycle correction. Refer to the tabular results for final measurements.



# EMC Test Data

Client: Technicolor Connected Home	Job Number: JD100094
Model: C61-100	T-Log Number: T100110
Contact: Rodolfo Rascon	Project Manager: Christine Krebill
Standard: FCC 15.B / 15.247	Project Coordinator: -
	Class: N/A

### Run #1: Radiated Bandedge Measurements

Date of Test: 12/14/2015 0:00      Config. Used: 1  
 Test Engineer: Mark Hill              Config Change: None  
 Test Location: FT Chamber #7        EUT Voltage: 120V/60Hz

Channel: 2425MHz                      Mode: RF4CE  
 Tx Chain: Ant 1                         Data Rate: -

### Band Edge Signal Field Strength - Direct measurement of field strength

Frequency	Level	Pol	15.209 / 15.247		Detector	Azimuth	Height	Comments
MHz	dB $\mu$ V/m	v/h	Limit	Margin	Pk/QP/Avg	degrees	meters	
2385.030	30.4	H	54.0	-23.6	AVG	58	1.5	POS; RB 1 MHz; VB: 10 Hz
2358.180	42.4	H	74.0	-31.6	PK	58	1.5	POS; RB 1 MHz; VB: 3 MHz
2376.930	30.1	V	54.0	-23.9	AVG	242	1.0	POS; RB 1 MHz; VB: 10 Hz
2378.460	41.3	V	74.0	-32.7	PK	242	1.0	POS; RB 1 MHz; VB: 3 MHz

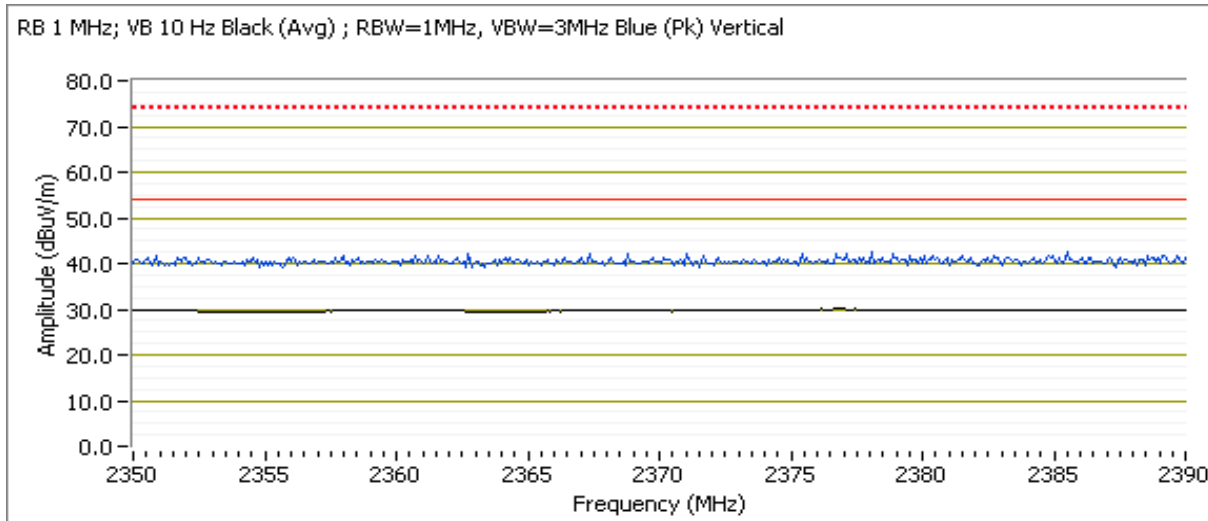



# EMC Test Data

Client: Technicolor Connected Home	Job Number: JD100094
Model: C61-100	T-Log Number: T100110
	Project Manager: Christine Krebill
Contact: Rodolfo Rascon	Project Coordinator: -
Standard: FCC 15.B / 15.247	Class: N/A

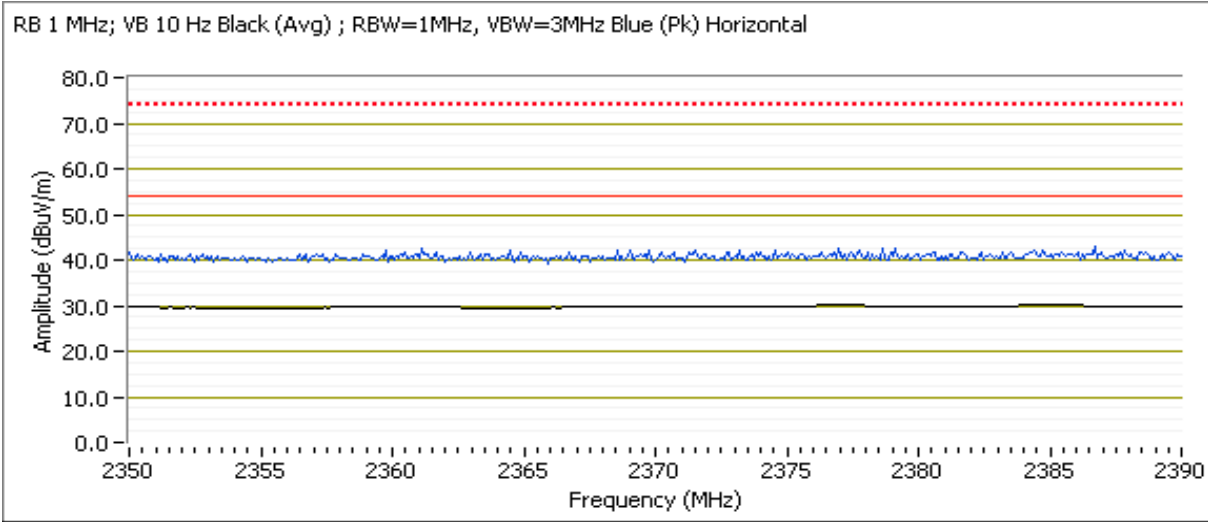



# EMC Test Data

Client: Technicolor Connected Home	Job Number: JD100094
Model: C61-100	T-Log Number: T100110
Contact: Rodolfo Rascon	Project Manager: Christine Krebill
Standard: FCC 15.B / 15.247	Project Coordinator: -
	Class: N/A

Channel: 2475MHz      Mode: RF4CE  
 Tx Chain: Ant 1      Data Rate: -

### Band Edge Signal Field Strength - Direct measurement of field strength

Frequency MHz	Level dB $\mu$ V/m	Pol v/h	15.209 / 15.247		Detector Pk/QP/Avg	Azimuth degrees	Height meters	Comments
			Limit	Margin				
2377.090	30.0	H	54.0	-24.0	AVG	61	1.0	POS; RB 1 MHz; VB: 10 Hz
2376.930	41.2	H	74.0	-32.8	PK	61	1.0	POS; RB 1 MHz; VB: 3 MHz
2376.370	29.9	V	54.0	-24.1	AVG	244	1.1	POS; RB 1 MHz; VB: 10 Hz
2384.790	42.2	V	74.0	-31.8	PK	244	1.1	POS; RB 1 MHz; VB: 3 MHz

RB 1 MHz; VB 10 Hz Black (Avg) ; RBW=1MHz, VBW=3MHz Blue (Pk) Vertical

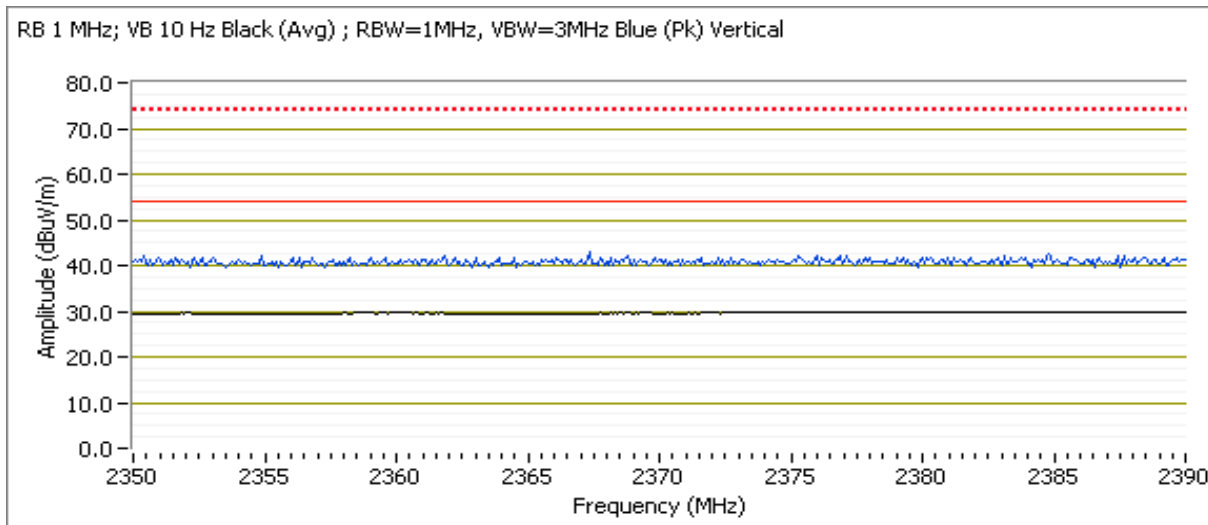

Client: Technicolor Connected Home	Job Number: JD100094
Model: C61-100	T-Log Number: T100110
	Project Manager: Christine Krebill
Contact: Rodolfo Rascon	Project Coordinator: -
Standard: FCC 15.B / 15.247	Class: N/A

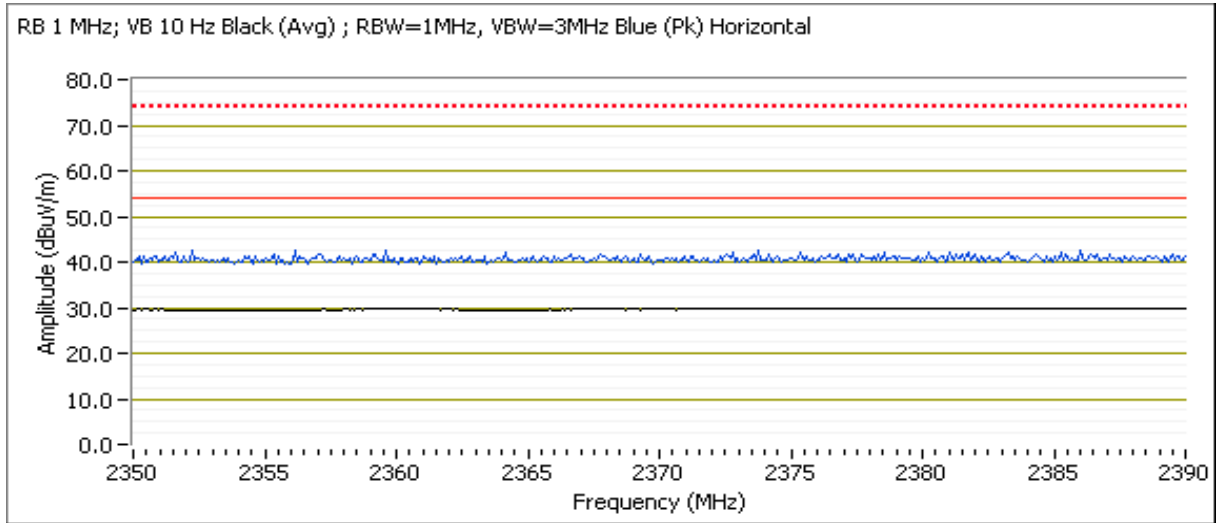





# EMC Test Data

Client:	Technicolor Connected Home	Job Number:	JD100094
Model:	C61-100	T-Log Number:	T100110
Contact:	Rodolfo Rascon	Project Manager:	Christine Krebill
Standard:	FCC 15.B / 15.247	Project Coordinator:	-
		Class:	N/A

## RSS-247 and FCC 15.247 (DTS) Radiated Spurious Emissions

### Test Specific Details

Objective: The objective of this test session is to perform final qualification testing of the EUT with respect to the specification listed above.

### General Test Configuration

The EUT and all local support equipment were located on the turntable for radiated spurious emissions testing.

For radiated emissions testing the measurement antenna was located 3 meters from the EUT, unless otherwise noted.

### Ambient Conditions:

Temperature: 20-22 °C  
Rel. Humidity: 35-40 %

### Summary of Results - Device Operating in the 2400-2483.5 MHz Band

Run #	Mode	Channel	Target Power	Power Setting	Test Performed	Limit	Result / Margin
1	RF4CE	2425MHz	3	3	Radiated Emissions, 1 - 25 GHz	FCC Part 15.209 / 15.247( c)	45.3 dBµV/m @ 4851.1 MHz (-8.7 dB)
	RF4CE	2450MHz	3	3	Radiated Emissions, 1 - 25 GHz	FCC Part 15.209 / 15.247( c)	45.2 dBµV/m @ 4899.1 MHz (-8.8 dB)
	RF4CE	2475MHz	3	3	Radiated Emissions, 1 - 25 GHz	FCC Part 15.209 / 15.247( c)	45.2 dBµV/m @ 4800.0 MHz (-8.8 dB)

### Modifications Made During Testing

No modifications were made to the EUT during testing

### Deviations From The Standard

No deviations were made from the requirements of the standard.

### Sample Notes

Sample S/N: A61LA5PX100017  
Driver:  
Antenna: Internal

Client:	Technicolor Connected Home	Job Number:	JD100094
Model:	C61-100	T-Log Number:	T100110
		Project Manager:	Christine Krebill
Contact:	Rodolfo Rascon	Project Coordinator:	-
Standard:	FCC 15.B / 15.247	Class:	N/A

### Procedure Comments:

Measurements performed in accordance with FCC KDB 558074

Peak measurements performed with: RBW=1MHz, VBW=3MHz, peak detector, max hold, auto sweep time

Unless otherwise stated/noted, emission has duty cycle  $\geq 98\%$  and was measured using RBW=1MHz, VBW=10Hz, peak detector, linear average mode, auto sweep time, max hold.

2.4GHz band reject filter used

Mode	Data Rate	Duty Cycle (x)	Constant DC?	T (ms)	Pwr Cor Factor*	Lin Volt Cor Factor**	Min VBW for FS (Hz)
RF4CE	-	100.00	Yes	N/A	0	0	10

### Measurement Specific Notes:

Note 1:	Emission in non-restricted band, but limit of 15.209 used.
Note 2:	Emission in non-restricted band, the limit was set 30dB below the level of the fundamental and measured in 100kHz.
Note 3:	Emission has a duty cycle $\geq 98\%$ , average measurement performed: RBW=1MHz, VBW=3MHz, RMS, Power averaging, auto sweep, trace average 100 traces
Note 4:	Emission has constant duty cycle $< 98\%$ , average measurement performed: RBW=1MHz, VBW $> 1/T$ but not less than 10Hz, peak detector, linear averaging, auto sweep, trace average 100 traces, measurement corrected by Linear voltage correction factor
Note 5:	Emission has constant duty cycle $< 98\%$ , average measurement performed: RBW=1MHz, VBW=3MHz, RMS, Power averaging, auto sweep, trace average 100 traces, measurement corrected by Pwr correction factor
Note 6:	Emission has non constant duty cycle $< 98\%$ , average measurement performed: RBW=1MHz, VBW $> 1/T$ , peak detector, linear average mode, sweep time auto, max hold. Max hold for $50 \cdot (1/DC)$ traces
Note 7:	Emission has non constant duty cycle $< 98\%$ , average measurement performed: RBW=1MHz, VBW $> 1/T$ , RMS detector, sweep time auto, max hold. Max hold for $50 \cdot (1/DC)$ traces



# EMC Test Data

Client: Technicolor Connected Home	Job Number: JD100094
Model: C61-100	T-Log Number: T100110
	Project Manager: Christine Krebill
Contact: Rodolfo Rascon	Project Coordinator: -
Standard: FCC 15.B / 15.247	Class: N/A

**Run #1: Radiated Spurious Emissions, 1,000 - 25000 MHz. Operating Mode: RF4CE**  
 Date of Test: 12/14/2015 0:00 Config. Used: 1  
 Test Engineer: Mark Hill Config Change: None  
 Test Location: FT Chamber #7 EUT Voltage: 120V/60Hz

**Run #1a: Low Channel**

Channel: 2425MHz Mode: RF4CE  
 Tx Chain: Ant 1 Data Rate: -

**Fundamental Signal Field Strength:** peak value measured in 100kHz

Frequency	Level	Pol	15.209 / 15.247		Detector	Azimuth	Height	Comments
MHz	dB $\mu$ V/m	v/h	Limit	Margin	Pk/QP/Avg	degrees	meters	
2425.410	96.5	V	-	-	Pk	242	1.0	POS; RB 3 MHz; VB: 10 MHz
2424.880	92.2	V	-	-	Pk	242	1.0	POS; RB 100 kHz; VB: 300 kHz
2425.320	101.8	H	-	-	Pk	58	1.5	POS; RB 3 MHz; VB: 10 MHz
2424.740	97.4	H	-	-	Pk	58	1.5	POS; RB 100 kHz; VB: 300 kHz

Fundamental emission level @ 3m in <b>100kHz RBW</b> :	97.4 dB $\mu$ V/m	
Limit for emissions outside of restricted bands:	77.4 dB $\mu$ V/m	Limit is -20dBc (Peak power measurement)
Limit for emissions outside of restricted bands:	67.4 dB $\mu$ V/m	Limit is -30dBc (UNII power measurement)

**Spurious Emissions**

Frequency	Level	Pol	15.209 / 15.247		Detector	Azimuth	Height	Comments
MHz	dB $\mu$ V/m	v/h	Limit	Margin	Pk/QP/Avg	degrees	meters	
<b>4851.050</b>	<b>45.3</b>	H	54.0	<b>-8.7</b>	AVG	306	1.0	RB 1 MHz;VB 10 Hz;Peak
4800.060	44.5	V	54.0	-9.5	AVG	61	1.3	RB 1 MHz;VB 10 Hz;Peak
4851.140	53.2	H	74.0	-20.8	PK	306	1.0	RB 1 MHz;VB 3 MHz;Peak
4799.760	49.5	V	74.0	-24.5	PK	61	1.3	RB 1 MHz;VB 3 MHz;Peak

**Note:** Scans made between 11 - 25 GHz with the measurement antenna moved around the card and its antennas 20-50cm from the device indicated there were no significant emissions in this frequency range

Client: Technicolor Connected Home	Job Number: JD100094
Model: C61-100	T-Log Number: T100110
	Project Manager: Christine Krebill
Contact: Rodolfo Rascon	Project Coordinator: -
Standard: FCC 15.B / 15.247	Class: N/A

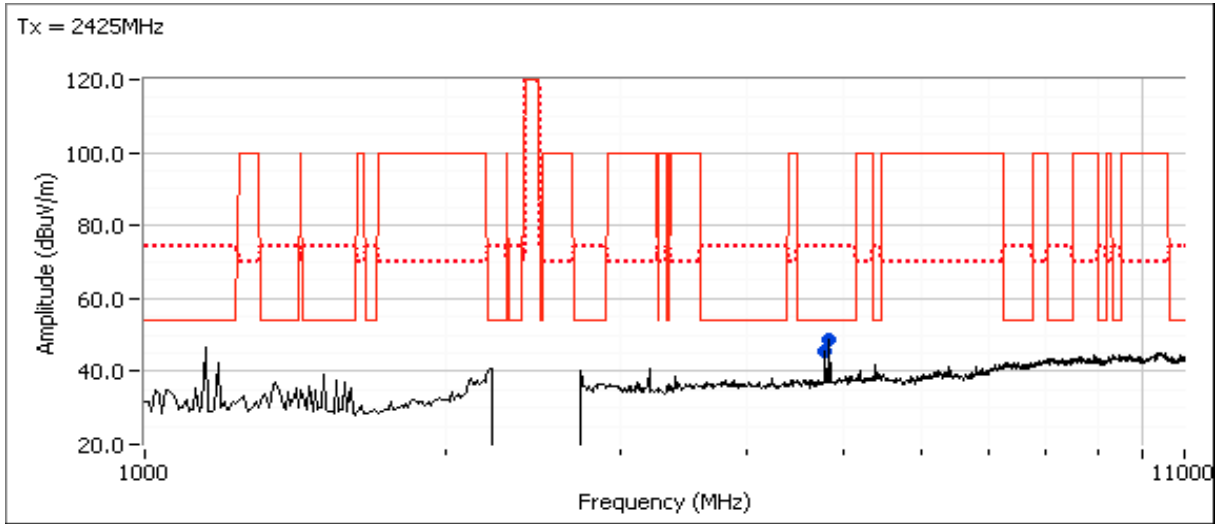



# EMC Test Data

Client: Technicolor Connected Home	Job Number: JD100094
Model: C61-100	T-Log Number: T100110
	Project Manager: Christine Krebill
Contact: Rodolfo Rascon	Project Coordinator: -
Standard: FCC 15.B / 15.247	Class: N/A

## Run #1b: Center Channel

Channel: 2450MHz      Mode: RF4CE  
 Tx Chain: Main      Data Rate: -

### Fundamental Signal Field Strength: peak value measured in 100kHz

Frequency	Level	Pol	15.209 / 15.247		Detector	Azimuth	Height	Comments
MHz	dB $\mu$ V/m	v/h	Limit	Margin	Pk/QP/Avg	degrees	meters	
<b>Ant #1</b>								
2449.360	94.0	V	-	-	Pk	240	1.2	POS; RB 3 MHz; VB: 5 MHz
2449.770	89.6	V	-	-	Pk	240	1.2	POS; RB 100 kHz; VB: 300 kHz
2450.370	101.8	H	-	-	Pk	52	1.0	POS; RB 3 MHz; VB: 5 MHz
2450.100	97.5	H	-	-	Pk	52	1.0	POS; RB 100 kHz; VB: 300 kHz
<b>Ant #2</b>								
2449.380	96.8	V	-	-	Pk	237	1.2	POS; RB 3 MHz; VB: 10 MHz
2449.800	92.6	V	-	-	Pk	237	1.2	POS; RB 100 kHz; VB: 300 kHz
2449.310	99.6	H	-	-	Pk	55	1.8	POS; RB 3 MHz; VB: 10 MHz
2450.060	95.5	H	-	-	Pk	55	1.8	POS; RB 100 kHz; VB: 300 kHz

Fundamental emission level @ 3m in 100kHz RBW:	97.5 dB $\mu$ V/m	
Limit for emissions outside of restricted bands:	77.5 dB $\mu$ V/m	Limit is -20dBc (Peak power measurement)
Limit for emissions outside of restricted bands:	67.5 dB $\mu$ V/m	Limit is -30dBc (UNII power measurement)

## Spurious Emissions

Frequency	Level	Pol	15.209 / 15.247		Detector	Azimuth	Height	Comments
MHz	dB $\mu$ V/m	v/h	Limit	Margin	Pk/QP/Avg	degrees	meters	
<b>4899.120</b>	<b>45.2</b>	H	54.0	<b>-8.8</b>	AVG	302	1.3	RB 1 MHz;VB 10 Hz;Peak
4800.020	44.4	V	54.0	-9.6	AVG	29	1.0	RB 1 MHz;VB 10 Hz;Peak
4899.150	52.6	H	74.0	-21.4	PK	302	1.3	RB 1 MHz;VB 3 MHz;Peak
4799.560	49.5	V	74.0	-24.5	PK	29	1.0	RB 1 MHz;VB 3 MHz;Peak

**Note:** Scans made between 11 - 25 GHz with the measurement antenna moved around the card and its antennas 20-50cm from the device indicated there were no significant emissions in this frequency range

Client: Technicolor Connected Home	Job Number: JD100094
Model: C61-100	T-Log Number: T100110
	Project Manager: Christine Krebill
Contact: Rodolfo Rascon	Project Coordinator: -
Standard: FCC 15.B / 15.247	Class: N/A

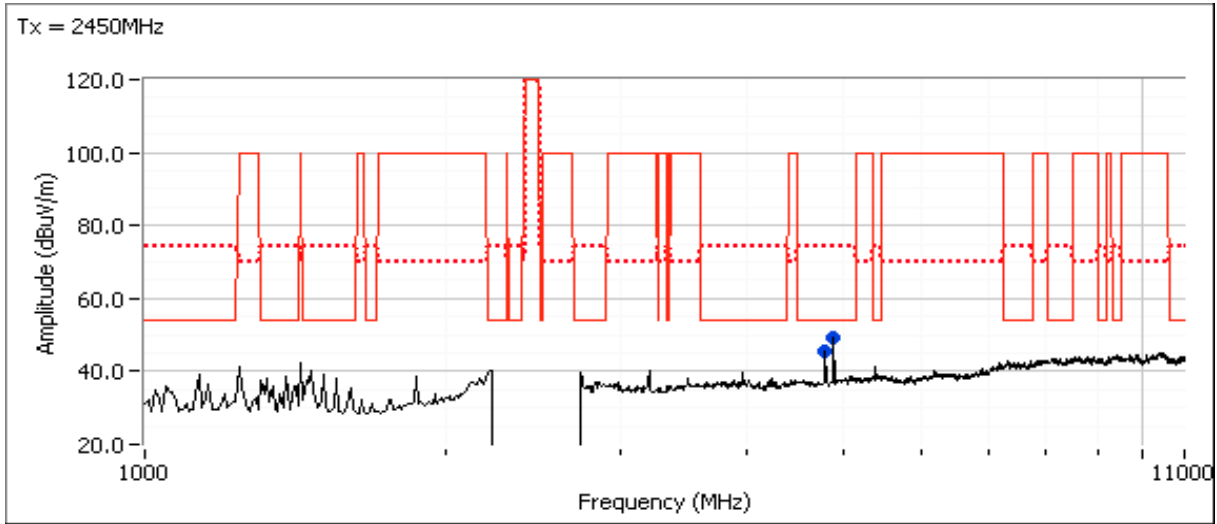



# EMC Test Data

Client: Technicolor Connected Home	Job Number: JD100094
Model: C61-100	T-Log Number: T100110
	Project Manager: Christine Krebill
Contact: Rodolfo Rascon	Project Coordinator: -
Standard: FCC 15.B / 15.247	Class: N/A

## Run #1c: High Channel

Channel: 2475MHz                      Mode: RF4CE  
 Tx Chain: Ant 1                      Data Rate: -

### Fundamental Signal Field Strength: peak value measured in 100kHz

Frequency	Level	Pol	15.209 / 15.247		Detector	Azimuth	Height	Comments
MHz	dB $\mu$ V/m	v/h	Limit	Margin	Pk/QP/Avg	degrees	meters	
2475.480	92.3	V	-	-	Pk	244	1.1	POS; RB 3 MHz; VB: 10 MHz
2474.760	88.0	V	-	-	Pk	244	1.1	POS; RB 100 kHz; VB: 300 kHz
2475.310	101.5	H	-	-	Pk	61	1.0	POS; RB 3 MHz; VB: 10 MHz
2475.240	96.9	H	-	-	Pk	61	1.0	POS; RB 100 kHz; VB: 300 kHz

Fundamental emission level @ 3m in <b>100kHz RBW</b> :	96.9 dB $\mu$ V/m	
Limit for emissions outside of restricted bands:	76.9 dB $\mu$ V/m	Limit is -20dBc (Peak power measurement)
Limit for emissions outside of restricted bands:	66.9 dB $\mu$ V/m	Limit is -30dBc (UNII power measurement)

### Spurious Emissions

Frequency	Level	Pol	15.209 / 15.247		Detector	Azimuth	Height	Comments
MHz	dB $\mu$ V/m	v/h	Limit	Margin	Pk/QP/Avg	degrees	meters	
<b>4800.030</b>	<b>45.2</b>	V	54.0	<b>-8.8</b>	AVG	61	1.2	RB 1 MHz;VB 10 Hz;Peak
4951.080	44.3	V	54.0	-9.7	AVG	58	1.3	RB 1 MHz;VB 10 Hz;Peak
4949.050	51.9	V	74.0	-22.1	PK	58	1.3	RB 1 MHz;VB 3 MHz;Peak
4799.940	50.0	V	74.0	-24.0	PK	61	1.2	RB 1 MHz;VB 3 MHz;Peak

**Note:** Scans made between 11 - 25 GHz with the measurement antenna moved around the card and its antennas 20-50cm from the device indicated there were no significant emissions in this frequency range

Client: Technicolor Connected Home	Job Number: JD100094
Model: C61-100	T-Log Number: T100110
	Project Manager: Christine Krebill
Contact: Rodolfo Rascon	Project Coordinator: -
Standard: FCC 15.B / 15.247	Class: N/A

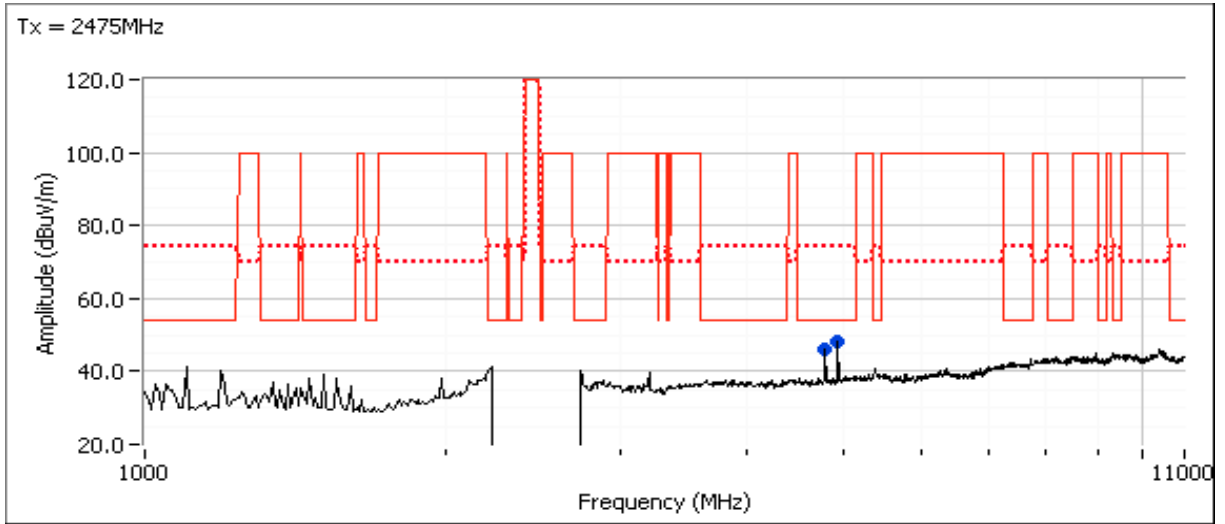





# EMC Test Data

Client:	Technicolor Connected Home	Job Number:	JD100094
Model:	C61-100	T-Log Number:	T100110
Contact:	Rodolfo Rascon	Project Manager:	Christine Krebill
Standard:	FCC 15.B / 15.247	Project Coordinator:	-
		Class:	N/A

## RSS-247 and FCC 15.247 (DTS) Radiated Spurious Emissions

### Test Specific Details

Objective: The objective of this test session is to perform final qualification testing of the EUT with respect to the specification listed above.

### General Test Configuration

The EUT and all local support equipment were located on the turntable for radiated spurious emissions testing.

For radiated emissions testing the measurement antenna was located 3 meters from the EUT, unless otherwise noted.

**Ambient Conditions:**  
 Temperature: 22 °C  
 Rel. Humidity: 33 %

### Summary of Results - Device Operating in the 2400-2483.5 MHz Band

Run #	Mode	Channel	Target Power	Power Setting	Test Performed	Limit	Result / Margin
1	RF4CE	2450MHz	3	3	Radiated Emissions, 30 -1000 MHz	FCC Part 15.209 / 15.247( c)	45.5 dBµV/m @ 240.30 MHz (-0.5 dB)

### Modifications Made During Testing

No modifications were made to the EUT during testing

### Deviations From The Standard

No deviations were made from the requirements of the standard.

### Sample Notes

Sample S/N: A61LA5PX100017  
 Driver:  
 Antenna: internal

### Procedure Comments:

Measurements performed in accordance with FCC KDB 558074  
 2.4GHz band reject filter used



# EMC Test Data

Client:	Technicolor Connected Home	Job Number:	JD100094
Model:	C61-100	T-Log Number:	T100110
Contact:	Rodolfo Rascon	Project Manager:	Christine Krebill
Standard:	FCC 15.B / 15.247	Project Coordinator:	-
		Class:	N/A

Mode	Data Rate	Duty Cycle (x)	Constant DC?	T (ms)	Pwr Cor Factor*	Lin Volt Cor Factor**	Min VBW for FS (Hz)
RF4CE	-	100.00	Yes	N/A	0	0	10

### Measurement Specific Notes:

Note 1:	Emission in non-restricted band, but limit of 15.209 used.
Note 2:	Emission in non-restricted band, the limit was set 30dB below the level of the fundamental and measured in 100kHz.

Date of Test: 12/14/15  
 Test Engineer: Mehran Birgani  
 Test Location: Chamber #7

Config. Used: 1  
 Config Change: none  
 EUT Voltage: 120V / 60Hz

Client: Technicolor Connected Home	Job Number: JD100094
Model: C61-100	T-Log Number: T100110
	Project Manager: Christine Krebill
Contact: Rodolfo Rascon	Project Coordinator: -
Standard: FCC 15.B / 15.247	Class: N/A

**Run #1: Radiated Spurious Emissions, 30 - 1000 MHz. Operating Mode: RF4CE**

Channel: 2450MHz      Mode: RF4CE  
 Tx Chain: 1          Data Rate: -

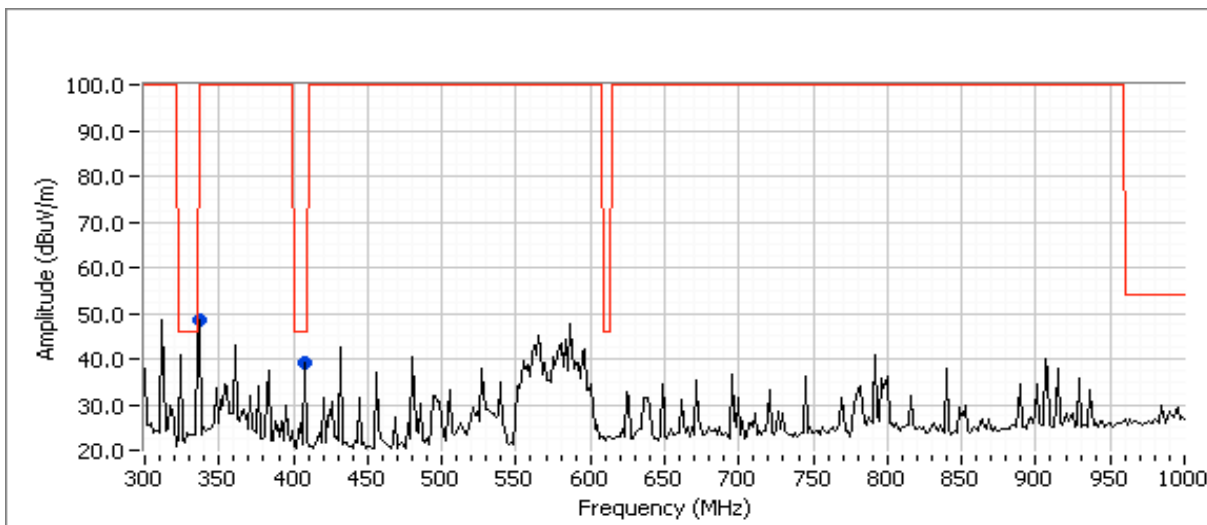
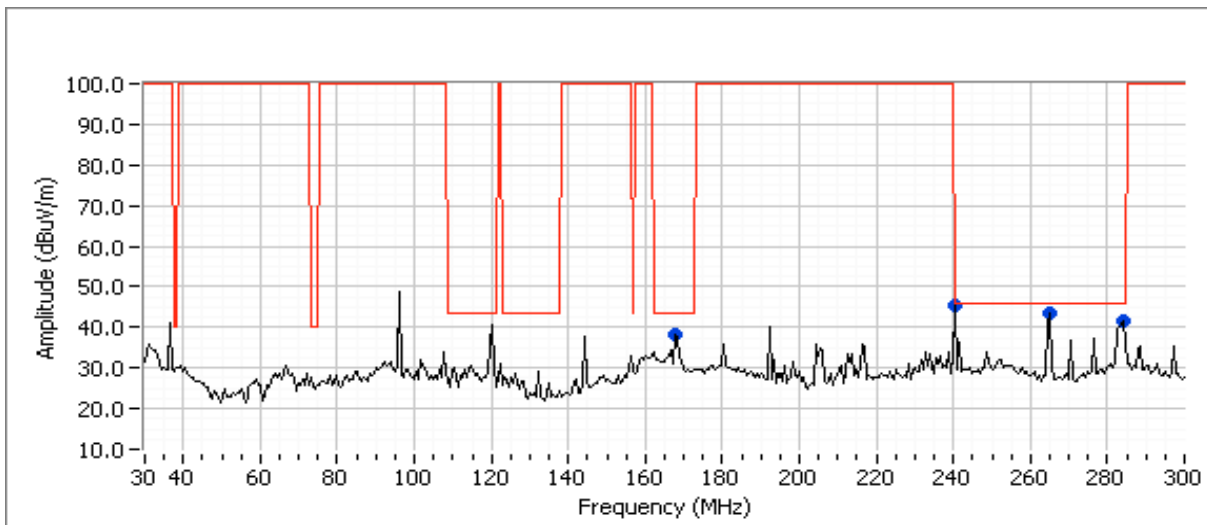



# EMC Test Data

Client: Technicolor Connected Home	Job Number: JD100094
Model: C61-100	T-Log Number: T100110
	Project Manager: Christine Krebill
Contact: Rodolfo Rascon	Project Coordinator: -
Standard: FCC 15.B / 15.247	Class: N/A

## Run #1: Radiated Spurious Emissions, 30 - 1000 MHz. Operating Mode: RF4CE

### Preliminary peak readings captured during pre-scan

Frequency	Level	Pol	15.209 / 15.247		Detector	Azimuth	Height	Comments
MHz	dB $\mu$ V/m	v/h	Limit	Margin	Pk/QP/Avg	degrees	meters	
240.302	45.2	H	46.0	-0.8	Peak	267	1.0	
264.333	43.5	H	46.0	-2.5	Peak	329	1.0	
282.903	41.4	H	46.0	-4.6	Peak	5	1.0	
167.999	38.2	H	43.5	-5.3	Peak	228	1.5	
408.513	39.2	H	46.0	-6.8	Peak	266	1.0	
336.414	48.4	H	77.5	-29.1	Peak	73	1.0	

### Final quasi-peak readings

Frequency	Level	Pol	15.209 / 15.247		Detector	Azimuth	Height	Comments
MHz	dB $\mu$ V/m	v/h	Limit	Margin	Pk/QP/Avg	degrees	meters	
<b>240.302</b>	<b>45.5</b>	H	46.0	<b>-0.5</b>	QP	264	1.0	QP (1.00s)
264.333	44.0	H	46.0	-2.0	QP	326	1.0	QP (1.00s)
167.999	39.0	H	43.5	-4.5	QP	222	1.6	QP (1.00s)
408.513	39.2	H	46.0	-6.8	QP	266	1.0	QP (1.00s)
282.903	36.7	H	46.0	-9.3	QP	0	1.0	QP (1.00s)
336.414	48.4	H	77.5	-29.1	Peak	66	1.0	QP (1.00s)



# EMC Test Data

Client:	Technicolor Connected Home	Job Number:	JD100094
Model:	C61-100	T-Log Number:	T100110
		Project Manager:	Christine Krebill
Contact:	Rodolfo Rascon	Project Coordinator:	-
Standard:	FCC 15.B / 15.247	Class:	N/A

## RSS-247 and FCC 15.247 (DTS) Antenna Port Measurements Power, PSD, Bandwidth and Spurious Emissions

### Test Specific Details

Objective: The objective of this test session is to perform final qualification testing of the EUT with respect to the specification listed above.

Date of Test: 12/14/2015	Config. Used: 1
Test Engineer: Mark Hill	Config Change: None
Test Location: FT Chamber #5	EUT Voltage: 120V/60Hz

### General Test Configuration

The EUT does not provide an RF connector. All measurements performed radiated. For power and PSD measurements, the field strength was maximized at a distance of 3m.

All measurements have been corrected to allow for the external attenuators used.

**Ambient Conditions:**                      Temperature:        20-22 °C  
    Rel. Humidity:      35-40 %

### Summary of Results

Run #	Pwr setting	Avg Pwr	Test Performed	Limit	Pass / Fail	Result / Margin
1	-	-	Output Power	15.247(b)	Pass	4.6dBm (3.1mW)
2	-	-	Power spectral Density (PSD)	15.247(d)	Pass	-12.7 dBm/3kHz
3	-	-	Minimum 6dB Bandwidth	15.247(a)	Pass	1.56 MHz
3	-	-	99% Bandwidth	RSS GEN	-	2.38 MHz

### Modifications Made During Testing

No modifications were made to the EUT during testing

### Deviations From The Standard

No deviations were made from the requirements of the standard.



# EMC Test Data

Client: Technicolor Connected Home	Job Number: JD100094
Model: C61-100	T-Log Number: T100110
	Project Manager: Christine Krebill
Contact: Rodolfo Rascon	Project Coordinator: -
Standard: FCC 15.B / 15.247	Class: N/A

## Procedure Comments:

Measurements performed in accordance with FCC KDB 558074

Mode	Data Rate	Duty Cycle (x)	Constant DC?	T (ms)	Pwr Cor Factor*	Lin Volt Cor Factor**	Min VBW for FS (Hz)
RF4CE	-	100.00	Yes	N/A	0	0	10

## Sample Notes

Sample S/N: A61LA5PX100017

Driver:

## Notes

The EUT has a fixed antenna, without provisions for a connector for test purposes. All measurements performed radiated

Client: Technicolor Connected Home	Job Number: JD100094
Model: C61-100	T-Log Number: T100110
Contact: Rodolfo Rascon	Project Manager: Christine Krebill
Standard: FCC 15.B / 15.247	Project Coordinator: -
	Class: N/A

### Run #1: Output Power

Power Setting <sup>2</sup>	Frequency (MHz)	EIRP <sup>1</sup>		Antenna Gain (dBi)	Output Power		Result	
		dBm	W		(dBm) <sup>1</sup>	mW		
3	2425	7.4	0.005	3.0	4.4	2.8	Pass	Ant 1
3	2450	7.6	0.006	3.0	4.6	2.9	Pass	Ant 1
3	2450	6.2	0.004	3.0	3.2	2.1	Pass	Ant 2
3	2475	7.9	0.006	3.0	4.9	3.1	Pass	Ant 1

- Note 1: Output power measured using RBW > OBW, VBW=3xRBW, peak detector, max hold
- Note 2: Power setting - the software power setting used during testing, included for reference only.
- Note 3: Power measurement performed at the worse case orientation and measurement antenna polarity. Refer to the fundamental field strength measurements in the spurious emissions results.
- Note 4: As the device operates using Tx diversity, the power for each output was measured at the center channel. Measurements on the low and high channels were performed on the port with the highest EIRP.

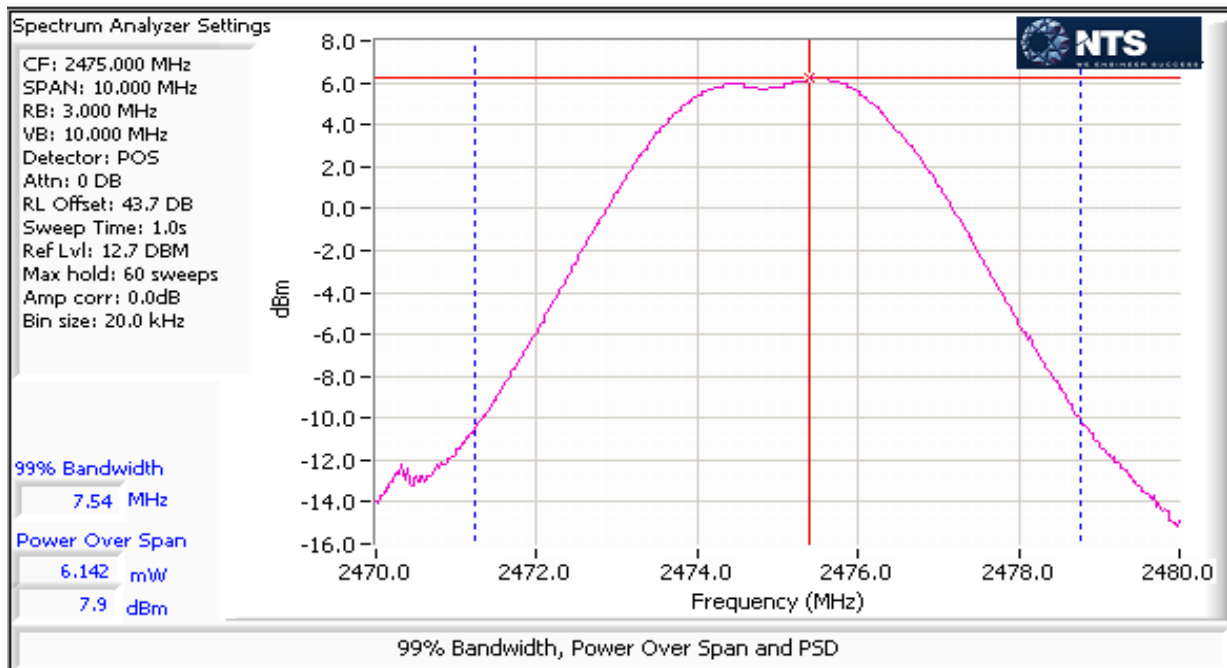



# EMC Test Data

Client: Technicolor Connected Home	Job Number: JD100094
Model: C61-100	T-Log Number: T100110
Contact: Rodolfo Rascon	Project Manager: Christine Krebill
Standard: FCC 15.B / 15.247	Project Coordinator: -
	Class: N/A

## Run #2: Power spectral Density

Power Setting	Frequency (MHz)	PSD (eirp)	Antenna Gain (dBi)	PSD	Limit dBm/3kHz	Result
		(dBm/3kHz) <sup>Note 1</sup>		(dBm/3kHz) <sup>Note 1</sup>		
3	2425	-10.3	3.0	-13.3	8.0	Pass
3	2450	-9.7	3.0	-12.7	8.0	Pass
3	2475	-10.5	3.0	-13.5	8.0	Pass

Note 1: Power spectral density measured radiated using RB=3 kHz, VB=10kHz, analyzer with peak detector and with a sweep time set to ensure a dwell time of at least 1 second per 3kHz. The measurement is made at the frequency of PPSD determined from preliminary scans using RB=3kHz using multiple sweeps at a faster rate over the 6dB bandwidth of the signal. Final PSD calculated from the measured eirp value.

Note 2: PSD performed radiated using Ant 1 (highest output power). Measurement performed at the worse case orientation and measurement antenna polarity (horizontal).

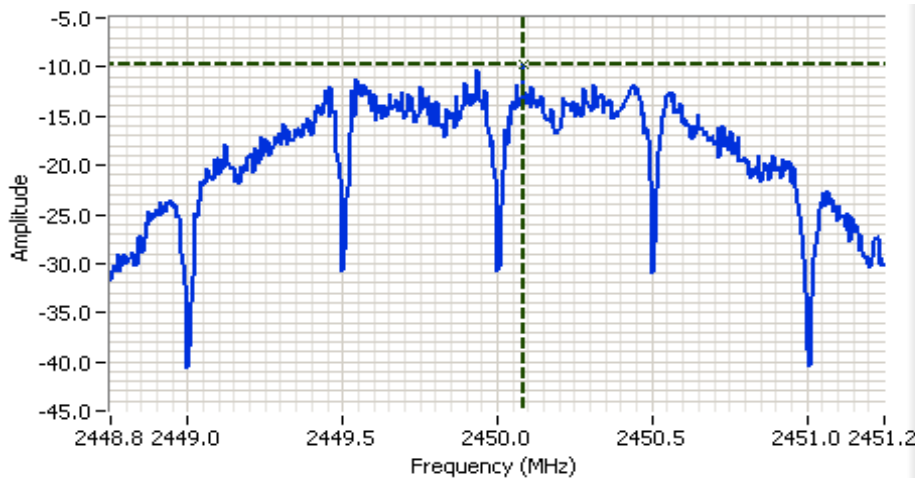

### Analyzer Settings

Rohde&Schwarz, ESI  
 CF: 2450.000 MHz  
 SPAN: 2.500 MHz  
 RB: 3.00 kHz  
 VB: 10.0 kHz  
 Detector: POS  
 Attn: 0 DB  
 RL Offset: 43.6 DB  
 Sweep Time: 0.7s  
 Ref Lvl: 6.6 DBM

### Comments

PSD: -9.72dBm/3kHz

Cursor 1 2450.0827 -9.72

0.0000 0.00





Client: Technicolor Connected Home	Job Number: JD100094
Model: C61-100	T-Log Number: T100110
	Project Manager: Christine Krebill
Contact: Rodolfo Rascon	Project Coordinator: -
Standard: FCC 15.B / 15.247	Class: N/A

### Run #3: Signal Bandwidth

Mode: **RF4CE**

Power Setting	Frequency (MHz)	Bandwidth (MHz)		RBW Setting (kHz)	
		6dB	99%	6dB	99%
3	2425	1.56	2.36	100	30
3	2450	1.57	2.35	100	30
3	2475	1.61	2.38	100	30

Note 1: DTS BW: RBW=100kHz, VBW ≥ 3\*RBW, peak detector, max hold, auto sweep time, Span 2-5 times measured BW. 99% BW: RBW=1-5% of 99%BW, VBW ≥ 3\*RBW, peak detector, max hold, auto sweep time. Span 1.5-5 times OBW.

Note 2: Bandwidth measurements performed radiated using Ant 1 (highest output power). Measurement performed at the worse case orientation and measurement antenna polarity (horizontal).

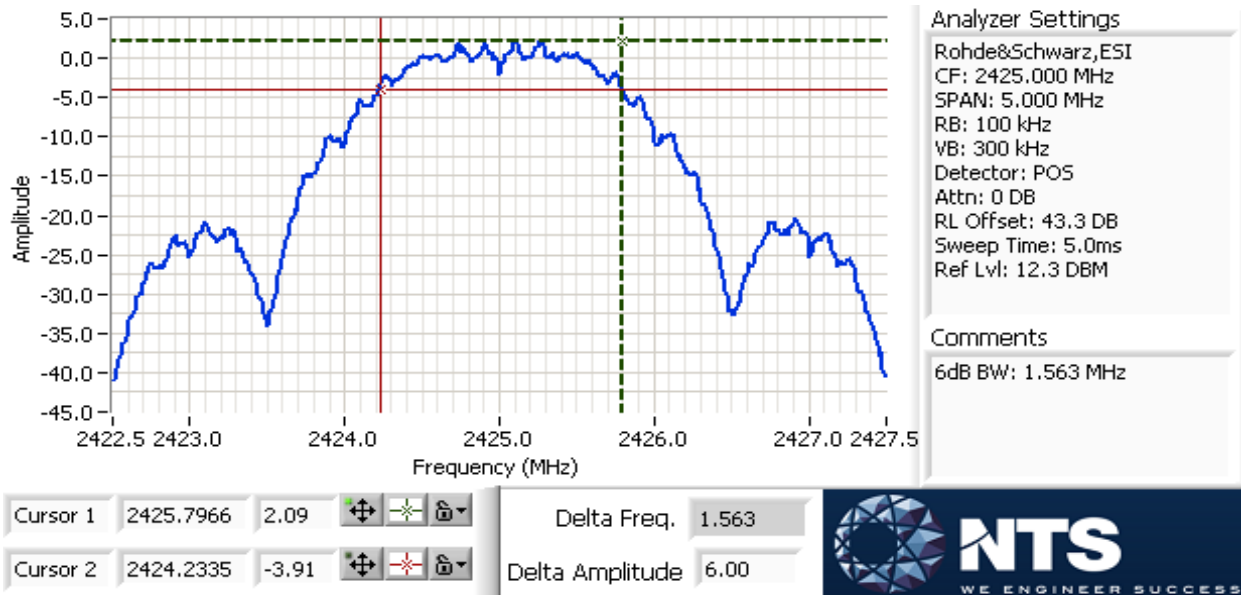

Client: Technicolor Connected Home	Job Number: JD100094
Model: C61-100	T-Log Number: T100110
Contact: Rodolfo Rascon	Project Manager: Christine Krebill
Standard: FCC 15.B / 15.247	Project Coordinator: -
	Class: N/A

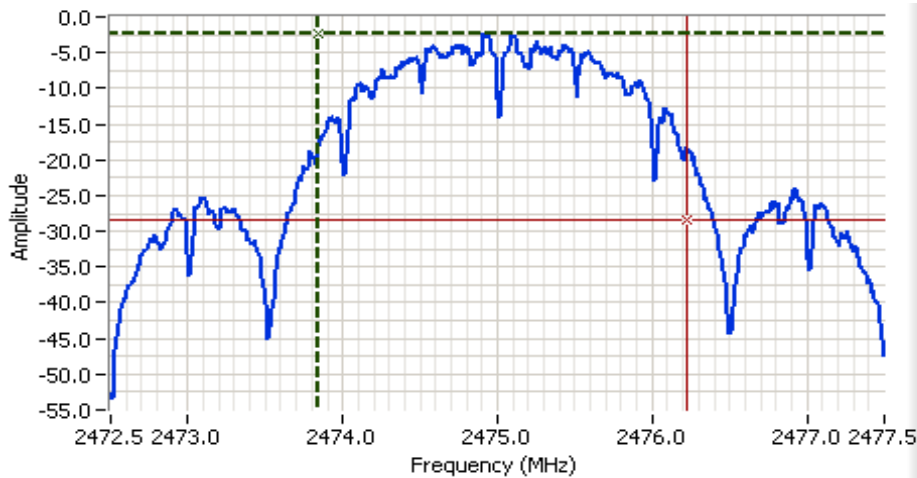

**Analyzer Settings**  
 Rohde&Schwarz, ESI  
 CF: 2475.000 MHz  
 SPAN: 5.000 MHz  
 RB: 30.0 kHz  
 VB: 100 kHz  
 Detector: POS  
 Attn: 0 DB  
 RL Offset: 43.7 DB  
 Sweep Time: 14.0ms  
 Ref Lvl: 12.7 DBM

**Comments**  
 99% power BW: 2.380 MHz

Cursor 1	2473.8400	-2.30	
Cursor 2	2476.2200	-28.30	

Delta Freq. 2.380  
 Delta Amplitude 26.00

Client: Technicolor Connected Home	Job Number: JD100094
Model: C61-100	T-Log Number: T100110
	Project Manager: Christine Krebill
Contact: Rodolfo Rascon	Project Coordinator: -
Standard: FCC 15.B / 15.247	Class: B

## Conducted Emissions

(NTS Silicon Valley, Fremont Facility, Semi-Anechoic Chamber)

### Test Specific Details

Objective: The objective of this test session is to perform final qualification testing of the EUT with respect to the specification listed above.

Date of Test: 12/14/2015  
 Test Engineer: M. Birgani  
 Test Location: Chamber #7

Config. Used: 1  
 Config Change: None  
 EUT Voltage: 120V/60Hz

### General Test Configuration

For tabletop equipment, the EUT was located on a wooden table inside the semi-anechoic chamber, 40 cm from a vertical coupling plane and 80cm from the LISN. A second LISN was used for all local support equipment. Remote support equipment was located outside of the semi-anechoic chamber. Any cables running to remote support equipment where routed through metal conduit and when possible passed through a ferrite clamp upon exiting the chamber.

**Ambient Conditions:**                      Temperature:        18-20 °C  
    Rel. Humidity:      30-35 %

### Summary of Results

Run #	Test Performed	Limit	Result	Margin
1	CE, AC Power, 120V/60Hz	Class B	Pass	51.1dBμV @ 0.55MHz (-4.9dB)

### Modifications Made During Testing

No modifications were made to the EUT during testing

### Deviations From The Standard

No deviations were made from the requirements of the standard.

Channel: 2450MHz                      Mode: RF4CE  
 Tx Chain: 1                                  Data Rate: 0

Sample S/N: A61LA5PX100017

Client: Technicolor Connected Home	Job Number: JD100094
Model: C61-100	T-Log Number: T100110
Contact: Rodolfo Rascon	Project Manager: Christine Krebill
Standard: FCC 15.B / 15.247	Project Coordinator: -
	Class: B

**Run #1: AC Power Port Conducted Emissions, 0.15 - 30MHz, 120V/60Hz**

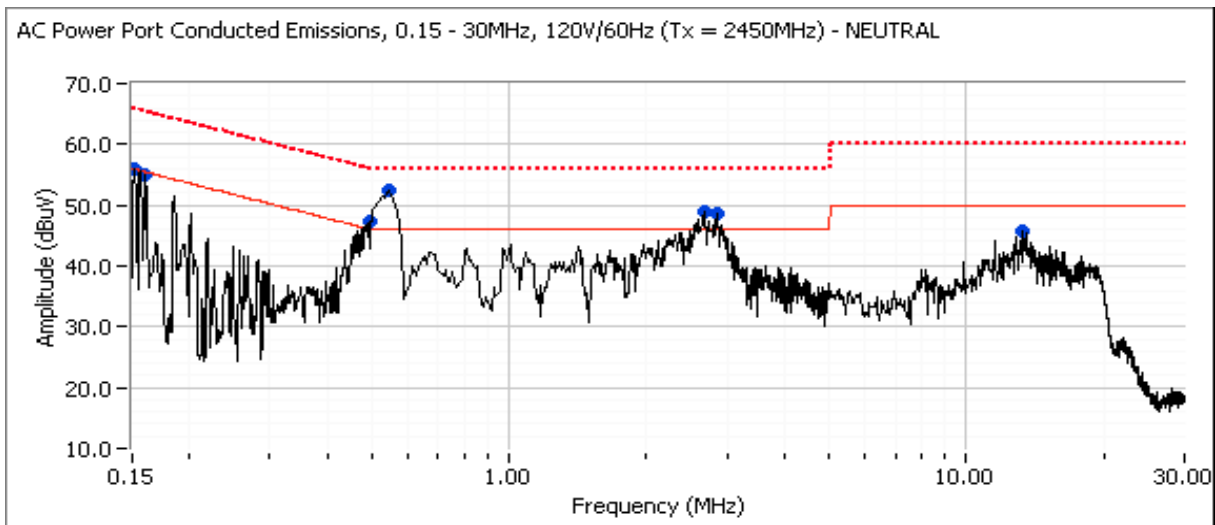
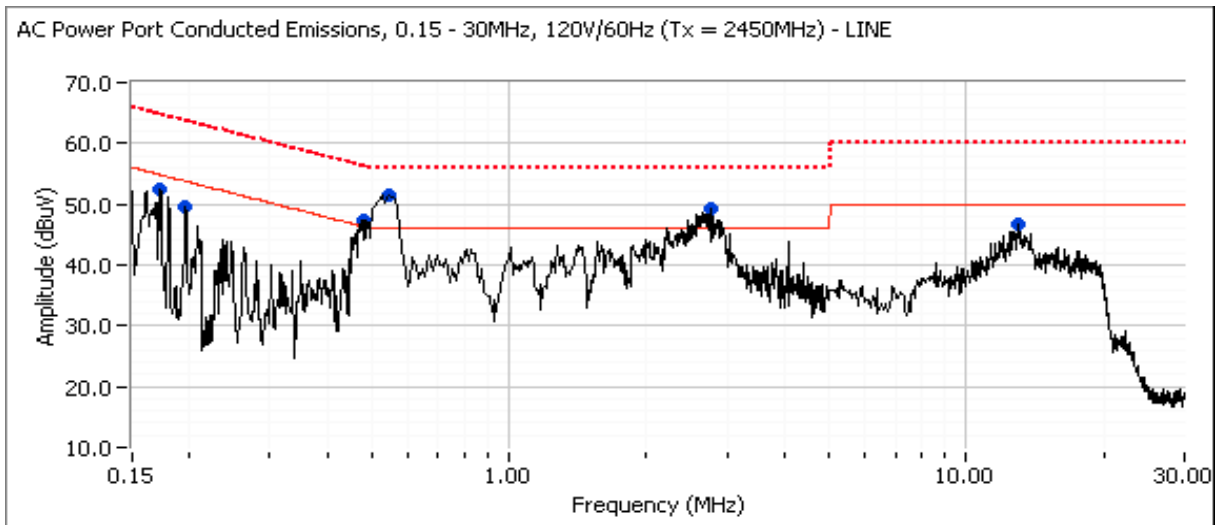



# EMC Test Data

Client: Technicolor Connected Home	Job Number: JD100094
Model: C61-100	T-Log Number: T100110
	Project Manager: Christine Krebill
Contact: Rodolfo Rascon	Project Coordinator: -
Standard: FCC 15.B / 15.247	Class: B

**Run #1: AC Power Port Conducted Emissions, 0.15 - 30MHz, 120V/60Hz**

**Preliminary peak readings captured during pre-scan (peak readings vs. average limit)**

Frequency MHz	Level dB $\mu$ V	AC Line	Class B		Detector QP/Ave	Comments
			Limit	Margin		
0.535	52.5	Neutral	46.0	6.5	Peak	
0.545	51.4	Line	46.0	5.4	Peak	
2.751	49.1	Line	46.0	3.1	Peak	
2.676	48.8	Neutral	46.0	2.8	Peak	
2.836	48.5	Neutral	46.0	2.5	Peak	
0.495	47.3	Neutral	46.1	1.2	Peak	
0.484	47.3	Line	46.3	1.0	Peak	
0.152	55.8	Neutral	55.9	-0.1	Peak	
0.159	55.0	Neutral	55.4	-0.4	Peak	
0.172	52.4	Line	54.8	-2.4	Peak	
12.945	46.8	Line	50.0	-3.2	Peak	
0.195	49.6	Line	53.8	-4.2	Peak	
13.433	45.6	Neutral	50.0	-4.4	Peak	



# EMC Test Data

Client: Technicolor Connected Home	Job Number: JD100094
Model: C61-100	T-Log Number: T100110
	Project Manager: Christine Krebill
Contact: Rodolfo Rascon	Project Coordinator: -
Standard: FCC 15.B / 15.247	Class: B

### Final quasi-peak and average readings

Frequency MHz	Level dB $\mu$ V	AC Line	Class B		Detector QP/Ave	Comments
			Limit	Margin		
0.545	51.1	Line	56.0	-4.9	QP	QP (1.00s)
0.535	50.3	Neutral	56.0	-5.7	QP	QP (1.00s)
0.535	40.1	Neutral	46.0	-5.9	AVG	AVG (0.10s)
0.545	40.0	Line	46.0	-6.0	AVG	AVG (0.10s)
0.495	46.8	Neutral	56.1	-9.3	QP	QP (1.00s)
0.484	46.5	Line	56.3	-9.8	QP	QP (1.00s)
2.676	45.1	Neutral	56.0	-10.9	QP	QP (1.00s)
0.484	35.2	Line	46.3	-11.1	AVG	AVG (0.10s)
2.836	34.3	Neutral	46.0	-11.7	AVG	AVG (0.10s)
2.836	44.2	Neutral	56.0	-11.8	QP	QP (1.00s)
0.495	34.2	Neutral	46.1	-11.9	AVG	AVG (0.10s)
2.676	33.7	Neutral	46.0	-12.3	AVG	AVG (0.10s)
2.751	43.7	Line	56.0	-12.3	QP	QP (1.00s)
2.751	31.7	Line	46.0	-14.3	AVG	AVG (0.10s)
0.159	50.9	Neutral	65.5	-14.6	QP	QP (1.00s)
0.152	49.9	Neutral	65.9	-16.0	QP	QP (1.00s)
0.171	47.3	Line	64.9	-17.6	QP	QP (1.00s)
12.945	31.1	Line	50.0	-18.9	AVG	AVG (0.10s)
13.433	30.8	Neutral	50.0	-19.2	AVG	AVG (0.10s)
0.159	36.2	Neutral	55.5	-19.3	AVG	AVG (0.10s)
0.195	43.7	Line	63.8	-20.1	QP	QP (1.00s)
12.945	39.7	Line	60.0	-20.3	QP	QP (1.00s)
13.433	39.7	Neutral	60.0	-20.3	QP	QP (1.00s)
0.171	32.7	Line	54.9	-22.2	AVG	AVG (0.10s)
0.152	29.7	Neutral	55.9	-26.2	AVG	AVG (0.10s)
0.195	26.0	Line	53.8	-27.8	AVG	AVG (0.10s)

***End of Report***

This page is intentionally blank and marks the last page of this test report.