

technicolor

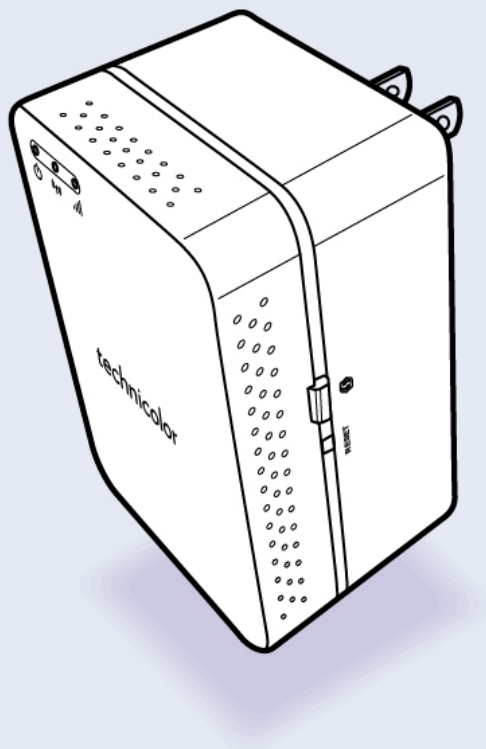

Power Wall Plug Repeater TG213

User's Manual

Table of Contents

Chapter 1: Product Overview	4
1.1 Features.....	4
1.2 Package Contents.....	4
1.3 Product Overview.....	5
1.3.1 Front Panel.....	5
1.3.2 Power Plug.....	6
1.3.3 How to Reset.....	7
1.4 Modes.....	8
1.4.1 Access Point.....	8
1.4.2 Repeater.....	8
Chapter 2: Repeater Mode	9
2.1 Setting as Repeater.....	9
2.2 Connecting Wireless Clients.....	12
2.3 Modifying Extended Wi-Fi Settings.....	13
Chapter 3: AP Mode.....	14
3.1 Using as Access Point	14
3.1.1 Connecting Wireless Devices.....	14
3.1.2 Wireless Settings of Your Device	16
3.2 Using as Station.....	17
3.2.1 Setting Your Device as AP Station	17
3.2.2 Connecting a Network	19
Chapter 4: System Configuration	21
4.1 Login.....	21
4.2 Using the Menu.....	22
4.3 Operation Menu	23
4.4 Network Menu	23
4.4.1 Lan Setting.....	23
4.4.2 IPV6 Setting	24
4.5 Wireless Menu.....	25
4.5.1 Repeater Mode.....	25
4.5.2 AP Mode - Access Point.....	28

4.5.3 AP Mode – Station.....	32
4.6 Administrator Menu	33
4.6.1 Management	33
4.6.2 Upload Firmware	34
4.6.3 Settings Management	35
4.6.4 Status.....	36
Appendix	37
A. Configure the Computer.....	37
B. Wireless Considerations	39
C. Regulatory & Safety Information.....	40
D. Specifications.....	43

Chapter 1: Product Overview

Thank you for choosing Technicolor® Power Wall Plug Repeater. You can use your device as a Repeater to leverage your existing wireless network by repeating the wireless network signal so that coverage range is extended. Or, use as an Access Point to allow wireless clients to connect to a wired network. The various security features, such as WPS, WPA2, and WPA protect your data and privacy online. The web-based utility allows you to configure your Repeater easily.

1.1 Features

- Wireless AC gives high-speed wireless connectivity to devices
- Wireless 802.11n/g/b/a/ac backward compatibility
- Wireless speed of up to 750Mbps (300 2.4Ghz / 433 5Ghz)
- Dual-band connectivity for greater flexibility and reduced interference
- 1x 10/100Mbps Auto-MDIX port
- WPA2/WPA wireless encryption to keep wireless communication secure
- Wi-Fi Protected Setup (WPS) for secure setup with simple press of a button
- Web-based configuration tools and management via Web Browser
- Supports statistics information
- Supports Station/AP/Repeater mode

1.2 Package Contents

Check if the package contains the following items. If any item is missing or appears damaged, contact your dealer.

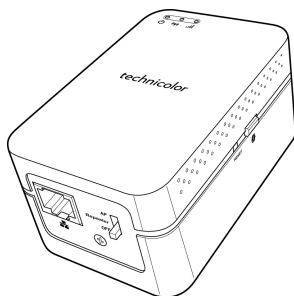

Power Wall Plug Repeater

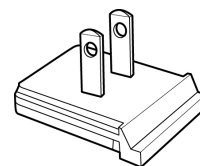

Power Plug

Note: Plug type may differ depending on the location where the device is purchased

1.3 Product Overview

1.3.1 Front Panel

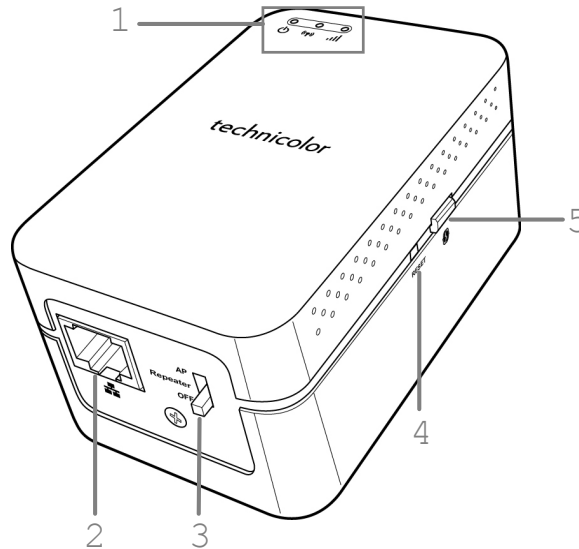

No.	LED	Description
1	Power LED	<p>Lights up when the device is powered on.</p> <ul style="list-style-type: none"> • Solid GREEN – Indicates the device is powered ON and operating normally • Flashing GREEN – Indicates Ethernet traffic in progress • Solid RED – Indicates the device is powering ON or the system is defective. • Flashing RED – The device is in recovery mode or the device has malfunctioned. • Flashing ORANGE – Cannot connect or be assigned an IP address from the router • Off – The device is powered off.
	Wireless LED	<p>Lights up to indicate wireless connection.</p> <ul style="list-style-type: none"> • Solid GREEN – A wired connection is established. • Flashing GREEN – Data transmission is in progress.
	Link LED	<p>Lights up to indicate link activity.</p> <ul style="list-style-type: none"> • Solid GREEN – Wireless link between the Repeater and the AP is above -55dBm RSSI • Solid ORANGE – Wireless link between the Repeater and the AP is above -75dBm and -55dBm RSSI • Solid RED – Wireless link between the Repeater and the AP is below -75dBm RSSI

No.	LED	Description
2	Ethernet port	Connects a computer and other Ethernet network devices to the Repeater using RJ-45 cables.
3	Power/ Mode Switch	Use the switch to select: <ul style="list-style-type: none"> • AP – AP mode • Repeater – Repeater mode • Off – Turn off the device
4	Reset button	Press and hold this button for at least 10 seconds to restore your device to its original factory default setting.
5	WPS Button and LED	Press and hold for at least 5 seconds to enable WPS. The LED lights up to indicate: <ul style="list-style-type: none"> • Flashing GREEN – WPS connection in progress • Solid GREEN – WPS connection is established • Flashing ORANGE – WPS connection failed

1.3.2 Power Plug

Slide the bundled power plug into your device. The plug type that comes with your device may vary depending on the location where the device is purchased.

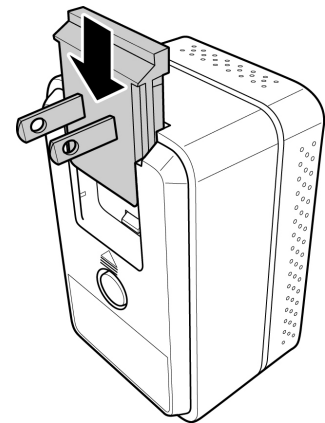

In case there is a need to replace the plug, press the lock button and slide the plug upwards to remove the plug from the device.

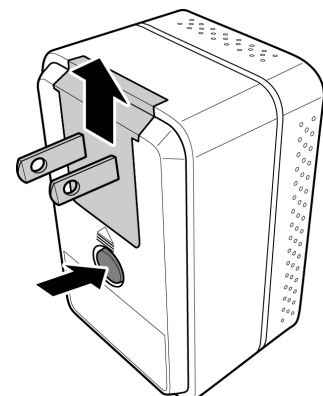

1.3.3 How to Reset

Use the **Reset** button in case there is a need to reset the device and restore the factory default settings.

Using a pointed object, press and hold the **Reset** button for at least 5 seconds to reset the device.

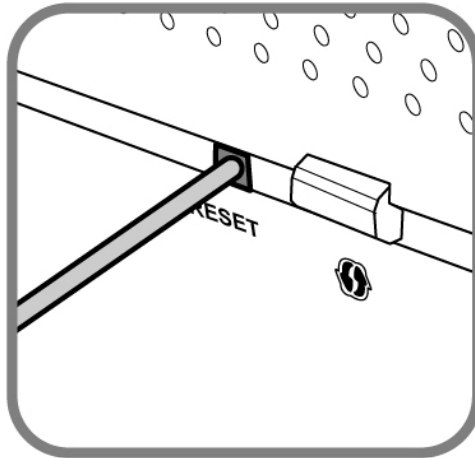

1.4 Modes

Your device can be used as:

- Access Point
- Repeater

1.4.1 Access Point

Use the **AP** (Access Point) mode to connect your device to a wired network and allow other clients to connect to the network wirelessly.

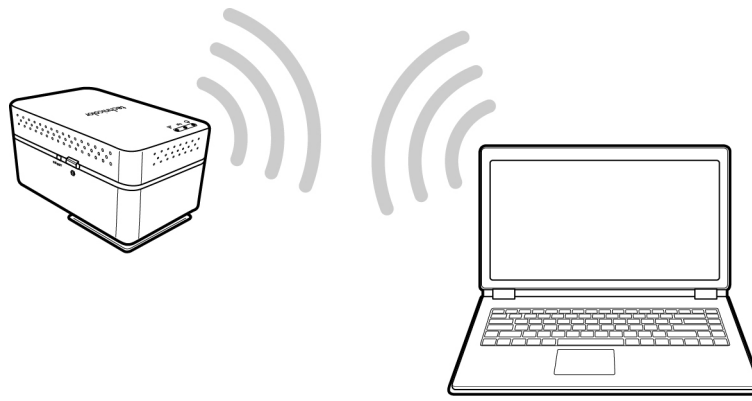

1.4.2 Repeater

Use the **Repeater** mode to extend the coverage range of an existing wireless network.

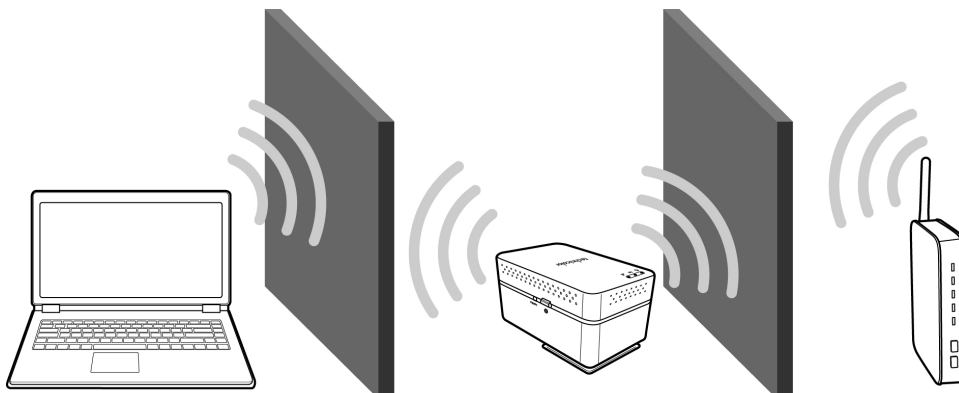

Chapter 2: Repeater Mode

Use the **Repeater** mode to extend the coverage range of your existing wireless network.

2.1 Setting as Repeater

1. Press the **Power/Mode** switch to **Repeater**.

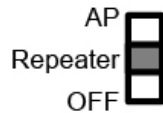

2. Plug your device to a power outlet.

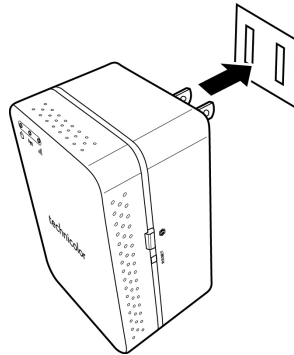

3. **Connect by WPS:** The easiest way to setup your device in **Repeater** mode is to connect to a router or access point using Wi-Fi Protected Setup (WPS). This feature is used only if the WPS pairing process is available on the router or access point. Otherwise, skip to step 4.

- a. Press the **WPS** (🔑) button on your wireless router or access point.
- b. Push the **WPS** button on your Repeater device.

The WPS LED will blink green while pairing is in progress. When pairing is successful, the WPS LED turns solid green.

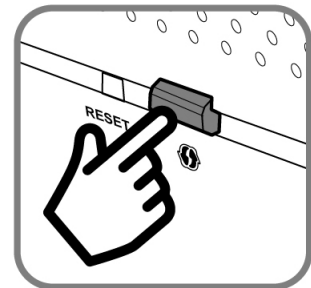

- c. After pairing, skip to **“Connecting Wireless Clients”** on page 12 to start connecting wireless clients to your device.

4. On your PC, search for available wireless networks. The default SSID of your device is "TCHREP2.4G958CD8" (2.4Ghz) or "TCHREP5G958CD8" (5Ghz). By default, the password is empty.

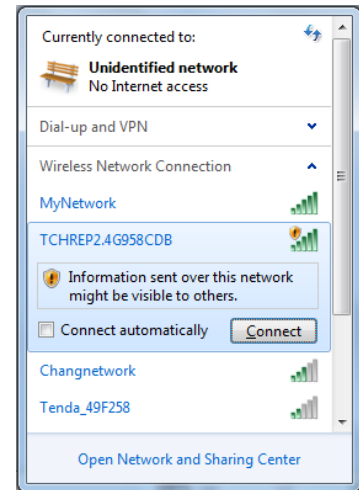

5. Once connected, open a web browser and type the default IP address of your device <http://192.168.0.50> on the URL address bar. The Login page appears.

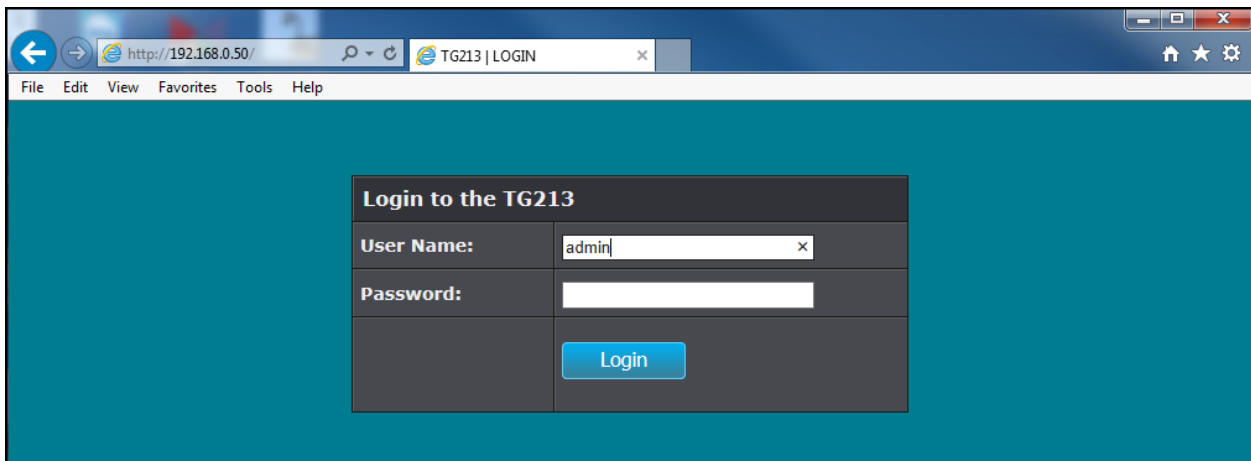

NOTE:

- If you cannot connect to the web configuration page, make sure your PC belongs to the same network segment as your device. The easiest way to do this is to set the Internet Protocol (TCP/IP) properties of your PC to automatic. If not, configure it accordingly. See "Configure the Computer" on page 37 for more information.

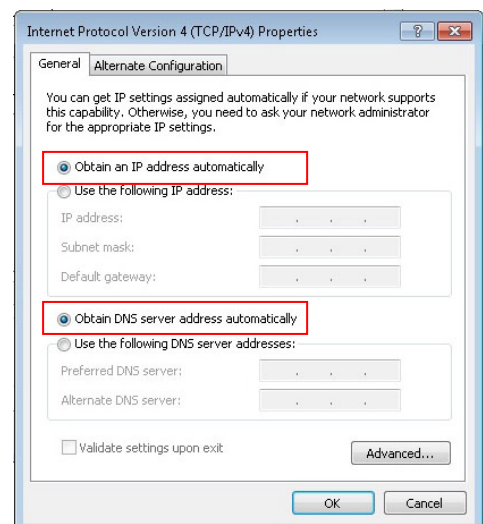

6. Type the **Username** "admin" and leave the **Password** empty.

NOTE:

- The default user name is "admin" and password is an empty field. It is advised to change the password see "Management" on page 33.

7. Once logged in, the **Wi-Fi Settings** screen appears. If you know the SSID of the wireless network, type it on the **SSID** box and fill in the **Authentication Type** and **Password** (if any). Otherwise, skip to step 3.

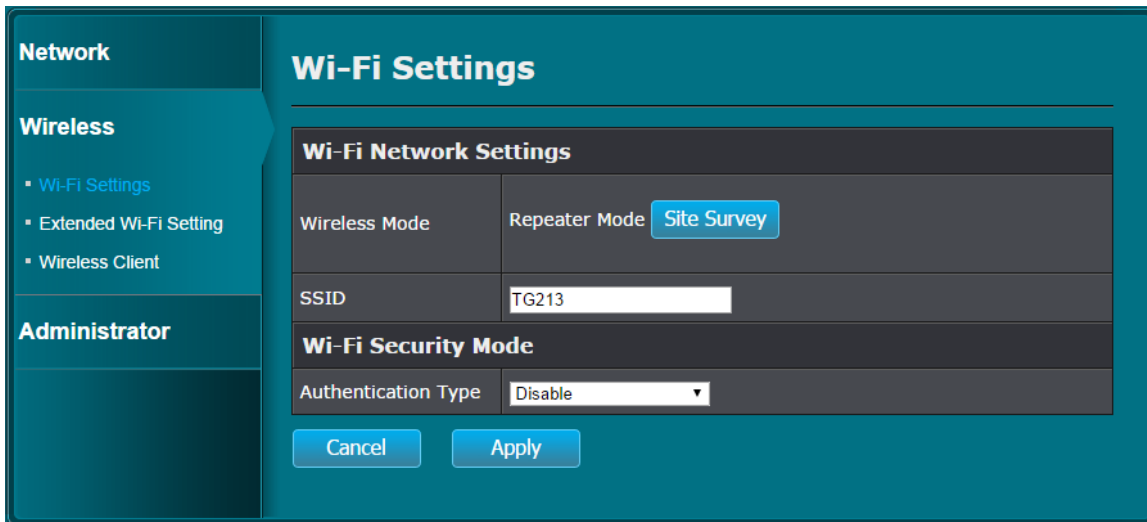

TIP:

- By default, the extended wireless network names (SSIDs) of your device are: "TCHREP2.4G958CD8" (2.4Ghz) or "TCHREP5G958CD8" (5Ghz). It is recommended to modify these SSIDs or set the security settings of these SSIDs from the **Extended Wi-Fi Setting** page before connecting to the wireless network you wish to extend. See "Extended Wi-Fi Setting" on page 26 for more information.

8. To scan for the wireless network to extend, click **Site Survey**. A list of available networks is shown.

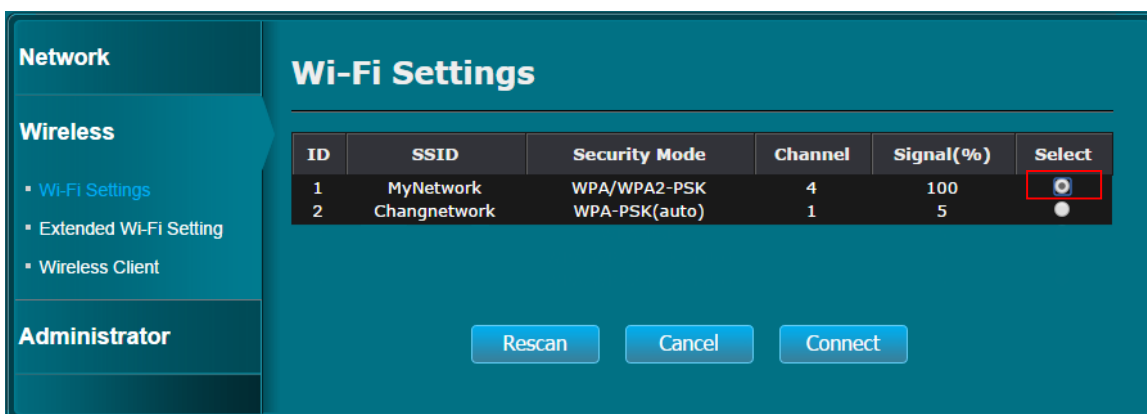

- Click the **Select** button of the network, and click **Connect**. The screen will revert back to previous page.

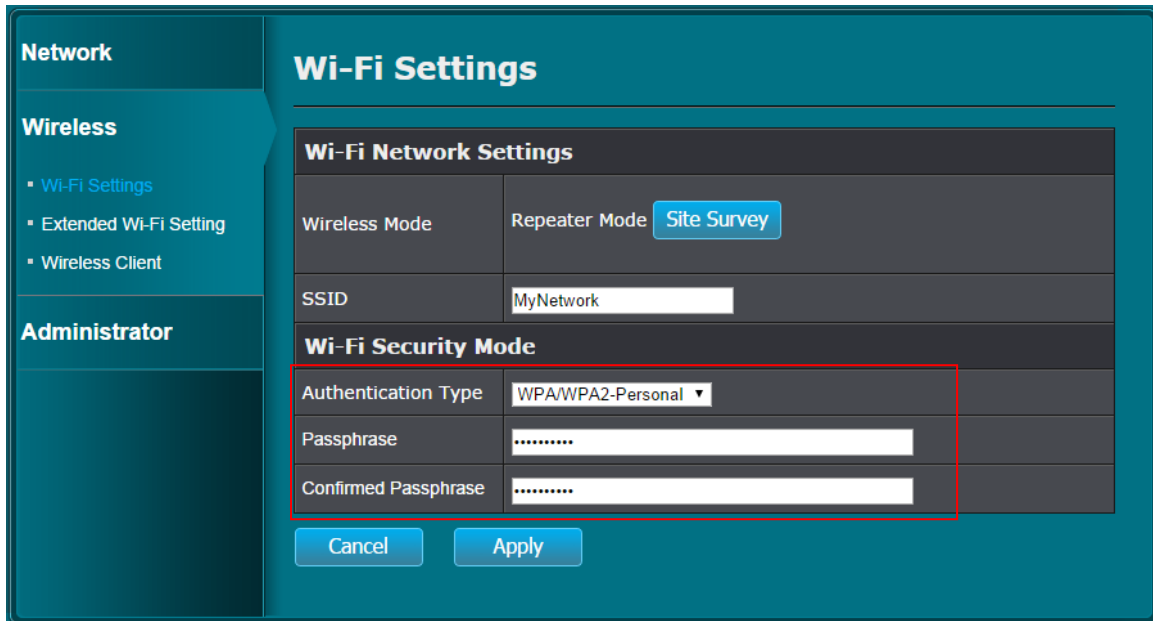

- Enter the **Authentication Type** and **Password** (if any), then click **Apply**. The device will reboot and establish your connection.

NOTE:

- Once your device is connected to the router, it will be assigned a new IP address based on the router DHCP settings. See your router documentation to determine the new IP address of your device. This address will be used to access the web configuration page of your device, if needed.

2.2 Connecting Wireless Clients

To connect wireless devices, open the wireless utility on your wireless device and select the default SSID of your device is "TCHREP2.4G958CD8" (2.4Ghz) or "TCHREP5G958CD8" (5Ghz). By default, the password is empty.

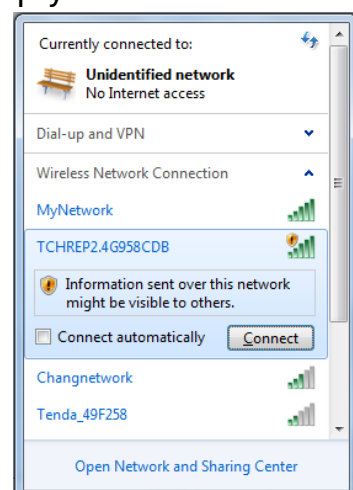
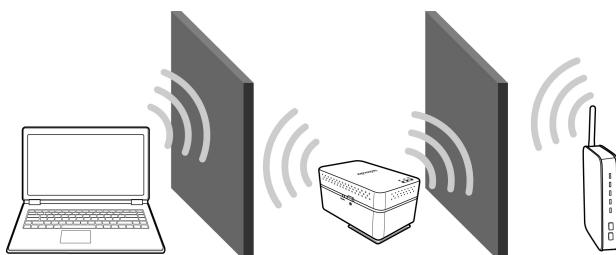

2.3 Modifying Extended Wi-Fi Settings

Login to the web configuration page. The **Wi-Fi Settings** screen appears.

Wi-Fi Network Settings	
Wireless Mode	Repeater Mode <input type="button" value="Site Survey"/>
SSID	<input type="text" value="MyNetwork"/>

Wi-Fi Security Mode	
Authentication Type	<input type="text" value="WPA/WPA2-Personal"/>
Passphrase	<input type="password" value="....."/>
Confirmed Passphrase	<input type="password" value="....."/>

To access other wireless settings, click the menu on the left panel:

- **Wi-Fi Settings** – Allows you to connect to a router/network and extend its signal to allow wireless clients to connect to the network via your device. See “**Wi-Fi Settings**” on page 25 for more information.
- **Extended Wi-Fi Setting** – Allows you to modify the default SSIDs assigned to your device and configure its authentication and password settings to protect it from unauthorized access. See “**Extended Wi-Fi Setting**” on page 26 for more information.
- **Wireless Client** – Allows you to view the wireless clients connected to your device. See “**Wireless Client**” on page 27 for more information.

Chapter 3: AP Mode

The AP mode of your device can be further configured as: **Access Point** or **Station**. As an **Access Point**, you can use your device to connect to a wired network and allow other clients to connect to the network wirelessly. You can also use your device as a **Station**, wherein you can connect your device to a non-wireless client via RJ-45 and allow other clients to connect to that client through your device wirelessly.

3.1 Using as Access Point

3.1.1 Connecting Wireless Devices

1. Press the **Power/Mode** switch to **AP**.

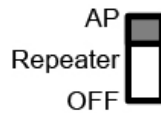

2. Plug your device to a power outlet.

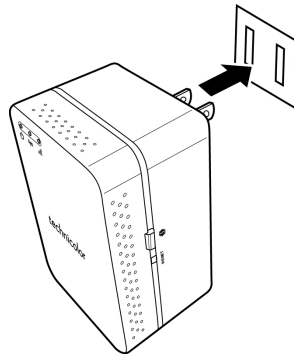

Below is a sample wireless connection illustration.

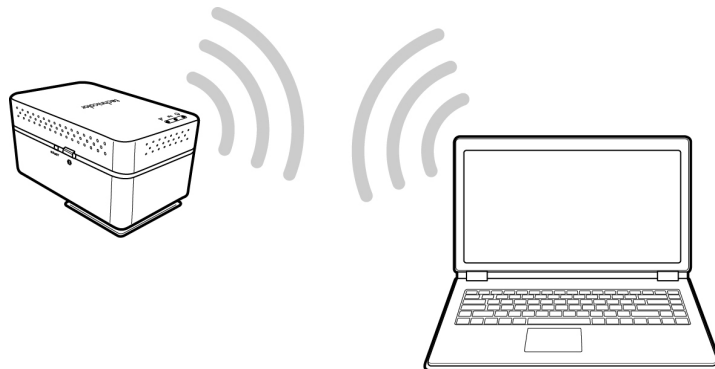

3. Open the wireless utility of the PC and select the wireless network name (SSID) of your device: **“TCHREP2.4G958CDB”** (for 2.4Ghz band) or **“TCHREP5G958CDB”** (for 5Ghz band). Click **Connect**.

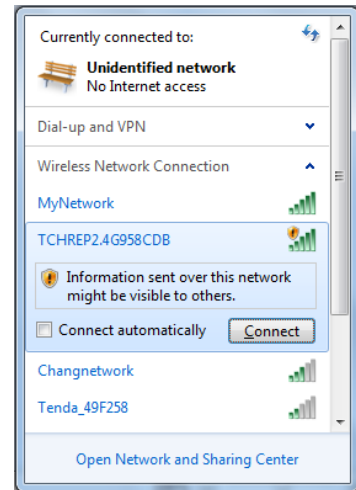

4. Open a web browser and type the default IP address of your device <http://192.168.0.50> on the URL address bar. The **Login** page appears.

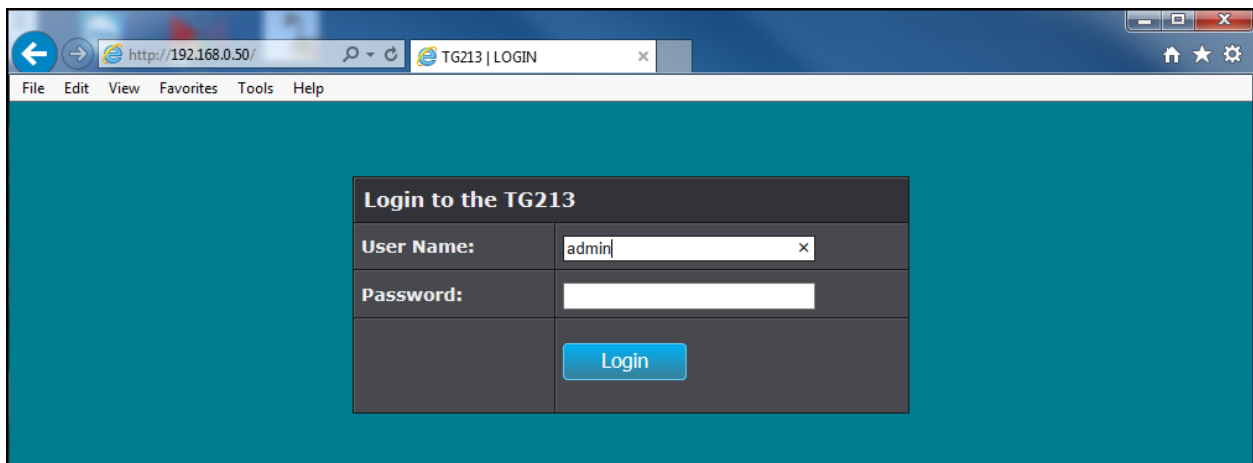

NOTE:

- If you cannot connect to the web configuration page, make sure your PC belongs to the same network segment as your device. The easiest way to do this is to set the **Internet Protocol (TCP/IP)** properties of your PC to automatic. If not, configure it accordingly. See **“Configure the Computer”** on page 37 for more information.

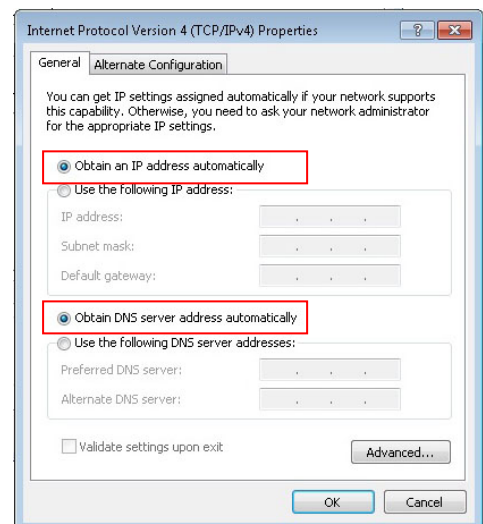

5. Type the **Username** "admin" and leave the **Password** empty.

NOTE:

- The default user name is "admin" and password is an empty field. It is advised to change the password, see "**Management**" on page 33.

3.1.2 Wireless Settings of Your Device

Once logged in, the **Wireless Basic** page appears. This page allows you to configure the basic wireless settings.

Wireless Basic	
2.4g Basic	
SSID	TCHREP2.4G958CDB
AutoChannel	<input checked="" type="checkbox"/>
Channel	6
802.11 Mode	2.4Ghz 802.11b/g/n mixed mode
Channel Width	Auto 20/40 MHz
5g Basic	
SSID	TCHREP5G958CDB
AutoChannel	<input checked="" type="checkbox"/>
Channel	36
802.11 Mode	5Ghz 802.11ac, 802.11n and 802.11a mixed mode
Channel Width	Auto 20/40/80 MHz

To access other wireless settings, click the menu on the left panel:

- **Basic** – Allows you to modify the SSID and select the channel, 802.11 mode, and channel width of both the 2.4Ghz and 5.0Ghz band network. See "**Basic**" on page 28 for more information.
- **Security** – Allows you to configure the authentication and password settings of your device to protect it from unauthorized access. See "**Security**" on page 29 for more information.
- **WiFi Protected Setup** – Allows you to enable/disable the WPS function of your device and allow wireless clients to connect to your device using the Push Button (PBC). See "**Wi-Fi Protected Setup**" on page 30 for more information.
- **Wireless Client** – Allows you to view the wireless clients connected to your device. See "**Wireless Client**" on page 31 for more information.

3.2 Using as Station

3.2.1 Setting Your Device as AP Station

1. Press the **Power/Mode** switch to **AP**.

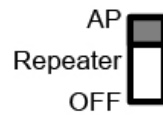

2. Connect your device to a computer using an RJ-45 cable.

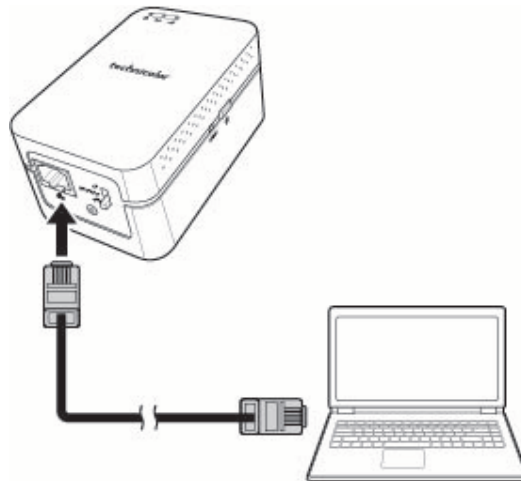

3. Plug your device to a power outlet.

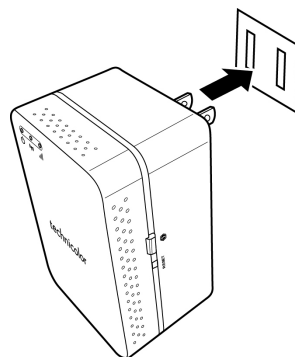

- The default IP address of your device is **192.168.0.50**. Make sure your PC belongs to the same network segment as your device. The easiest way to do this is to set the **Internet Protocol (TCP/IP)** properties of your PC to automatic. If not, configure it accordingly. See “**Configure the Computer**” on page 37 for more information.

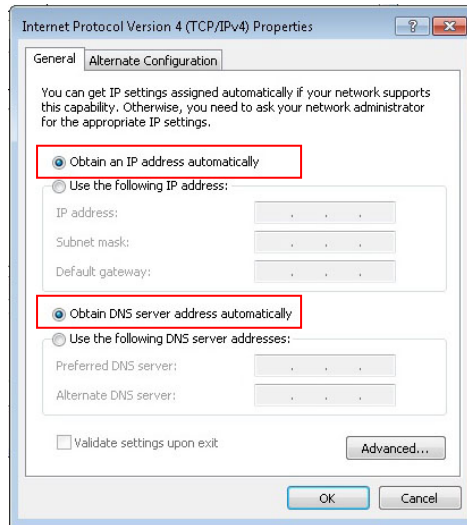

- Open a web browser and type <http://192.168.0.50> on the URL address bar. The **Login** page appears.

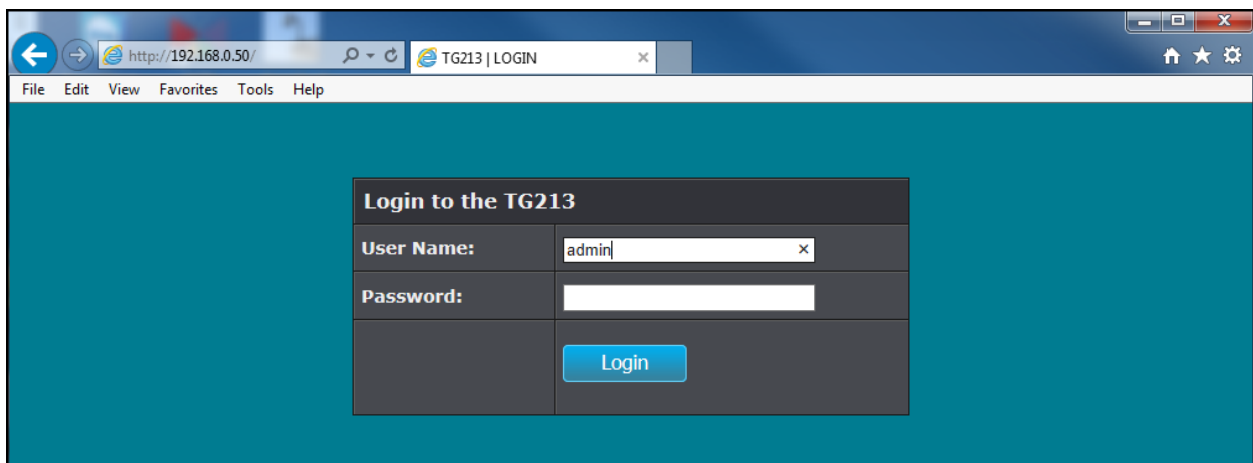

- Type the **Username** “admin” and leave the **Password** empty. Once logged in, the **Operation** screen appears.

NOTE:

- The default user name is “admin” and password is an empty field. It is advised to change the password, see “**Management**” on page 33.

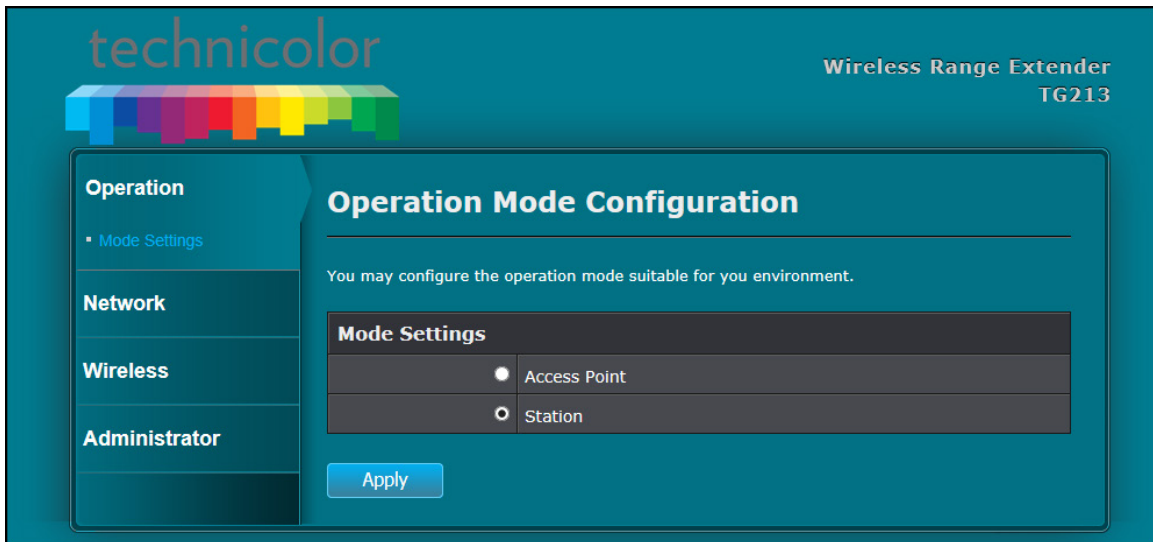

3.2.2 Connecting a Network

After setting your device as an AP Station, now you can connect to a wireless router.

1. Click the **Wireless** from the left panel menu.



2. If you know the SSID of the wireless network, type it on the **SSID** box and fill in the **Authentication Type** and **Password** (if any). Otherwise, skip to step 3.

- To scan for a wireless network in range, click **Site Survey**. A list of available networks is shown.

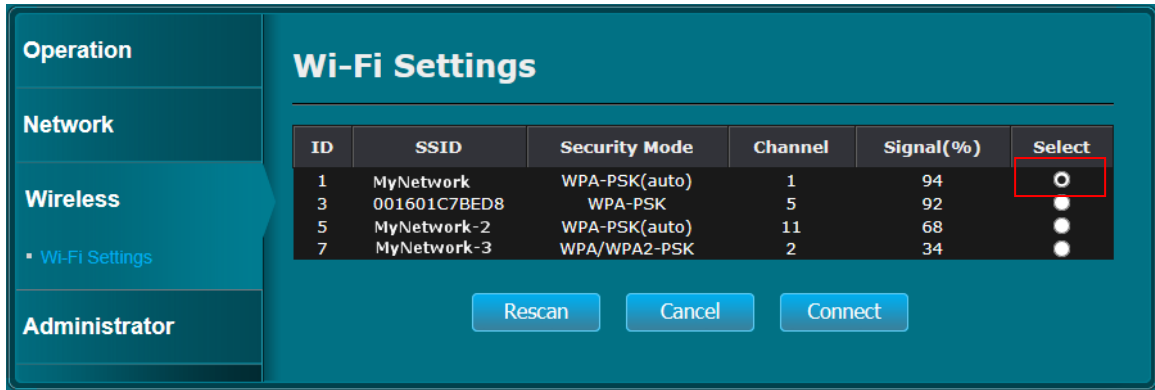

- Click the **Select** button of the network, and click **Connect**. The screen will revert back to previous page.

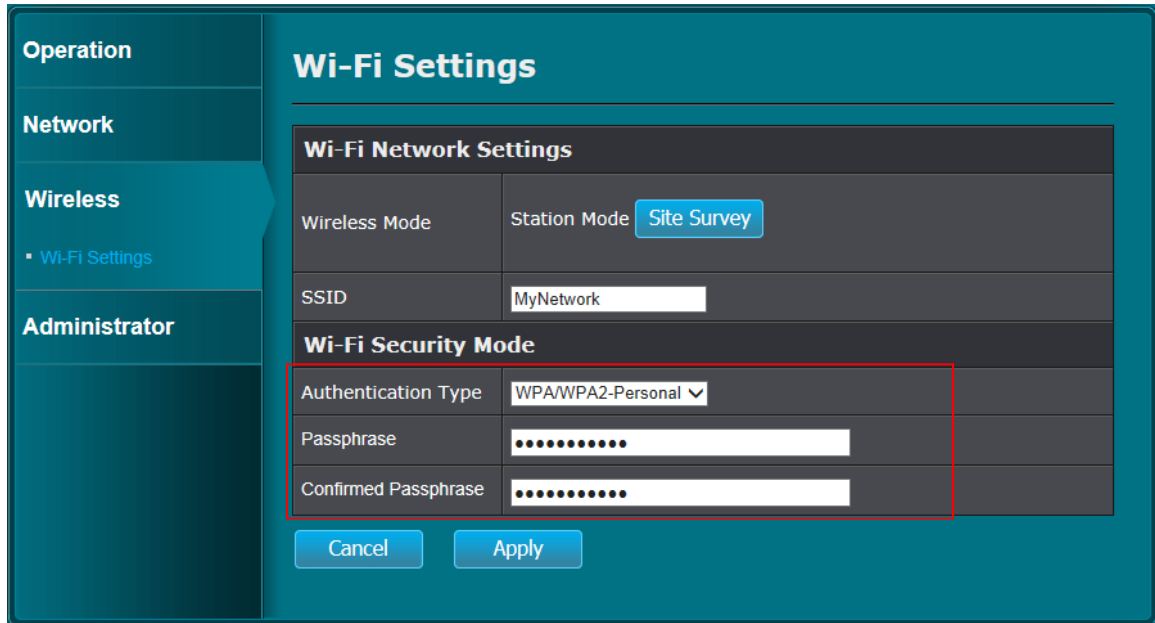

- Enter the **Authentication Type** and **Password** (if any), then click **Apply**. The device will reboot and establish your connection.

NOTE:

- Once your device is connected to the router, it will be assigned a new IP address based on the router DHCP settings. See your router documentation to determine the new IP address of your device. This address will be used to access the web configuration page of your device, if needed.

Chapter 4: System Configuration

Use the Web Configurations utility to configure your Repeater.

4.1 Login

1. On your PC, launch the web browser.
2. On the address bar, type the default IP address <http://192.168.0.50> then press **Enter**. The **Login** screen appears.

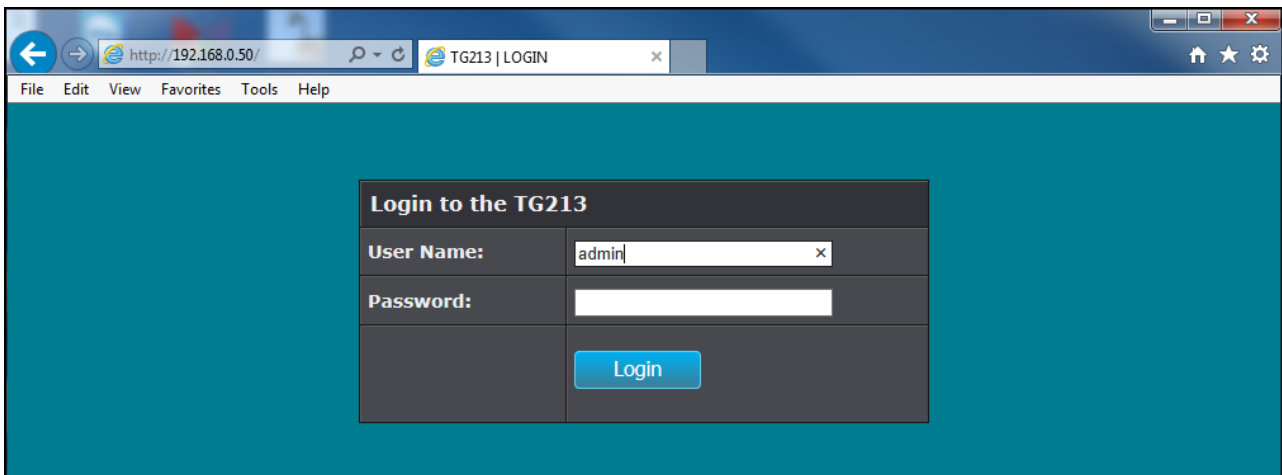

3. Type the **Username** "admin" and leave the **Password** empty. Once logged in, the **Operation** screen appears.

NOTE:

- The default user name is "admin" and password is an empty field. It is advised to change the password, see "**Management**" on page 33.

4.2 Using the Menu

Click a menu from the left panel to access the functions of your Repeater.

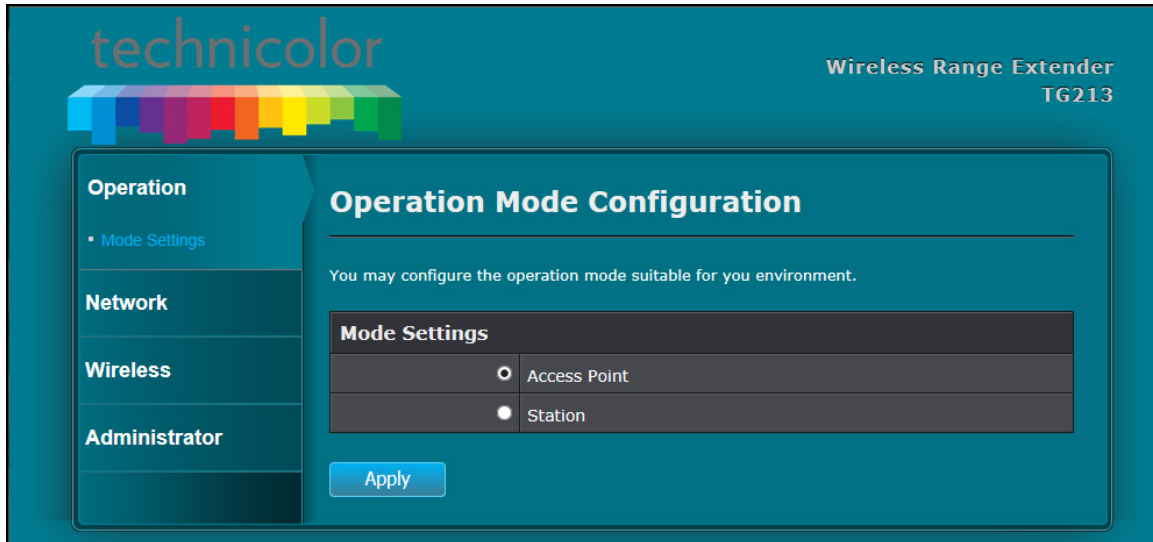

The following menu items are available:

- **Operation** — Allows you to select the device mode: **Access Point** or **Station**.
- **Network** — Allows you to configure the LAN and IPV6 settings.
- **Wireless** — Allows you to remotely configure the wireless settings.
- **Administrator** — Allows you to configure more advanced functions, such as managing the admin and user passwords, setting of device name, upgrading the firmware, restoring configuration settings, and others.

4.3 Operation Menu

The **Operation** menu is available only when the **Power / Mode** switch is set to **AP** mode. Select **Access Point** or **Station**, then click **Apply**.

4.4 Network Menu

The **Network** menu allows you to manually configure the LAN and IPV6 settings of your device.

4.4.1 Lan Setting

This page allows you manually configure the LAN connection of your device.

Properties	Description
Connection Type	<p>Select the connection type:</p> <ul style="list-style-type: none"> Static IP: Select to assign a specific IP address to your device. If Static IP is selected, the following properties must be configured: IP Address, Subnet Mask, Gateway, DNS 1, and DNS 2.

Properties	Description
	<p>NOTE: Ask your network service provider for these information.</p> <ul style="list-style-type: none"> • DHCP Client: Select to allow the router to assign a dynamic IP address to your device.

After modifying any of the above properties, click **Apply** to save and apply changes.

4.4.2 IPV6 Setting

This page allows you to configure the IPV6 settings of your device.

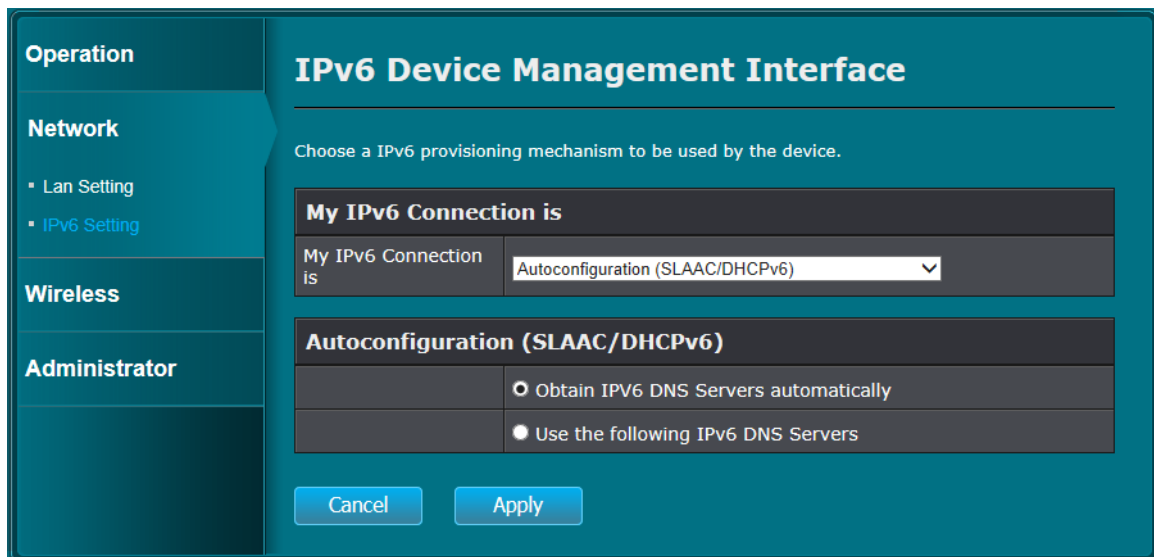

Properties	Description
My IPv6 Connection is	<p>Select IPv6 connection:</p> <ul style="list-style-type: none"> • Link-local only: Select to link to local network only when IPv6 address is used. If selected, the IPv6 local address is shown. • Static IPv6: Select to manually configure the IPv6 settings of your device. If Static IPv6 is selected, the following properties must be configured: IPv6 Address, Subnet Prefix Length, Default Gateway, Primary DNS Server, and Secondary DNS Server. • Autoconfiguration: Select to allow the router to assign the IPv6 address to your device and automatically or manually assign the IPv6 DNS servers.

After modifying any of the above properties, click **Apply** to save and apply changes.

4.5 Wireless Menu

The **Wireless** menu varies depending on the selected mode.

4.5.1 Repeater Mode

Wi-Fi Settings

The **Wi-Fi Settings** page allows you to connect to a router/network and extend its signal to allow wireless clients to connect to the network via your device.

The screenshot shows the 'Wi-Fi Settings' configuration page. On the left is a navigation menu with 'Network', 'Wireless', and 'Administrator' sections. Under 'Wireless', there are links for 'Wi-Fi Settings', 'Extended Wi-Fi Setting', and 'Wireless Client'. The main content area is titled 'Wi-Fi Settings' and contains the following sections:

- Wi-Fi Network Settings:**
 - Wireless Mode: Repeater Mode (with a 'Site Survey' button)
 - SSID: MyNetwork
- Wi-Fi Security Mode:**
 - Authentication Type: WPA/WPA2-Personal (dropdown menu)
 - Passphrase: [masked]
 - Confirmed Passphrase: [masked]

At the bottom of the settings area are 'Cancel' and 'Apply' buttons.

Properties	Description
Wireless Mode	Click Site Survey to search for the wireless network you wish to extend. The list of available network appears, select and click Connect .
SSID	Displays the SSID of the wireless network selected from Site Survey or the last connected network.
Authentication Type	Select the authentication type needed to connect to the wireless network. <ul style="list-style-type: none"> • Disable: Select if authentication is not required to connect to the wireless network. • WEP: Select if the network uses the WEP security setting. Select WEP, Mode, and WEP Key, and then type the Key on the allotted box. • WPA/WPA-2Personal: Select if the network uses the

Properties	Description
	WPA/WPA-2 security setting. Then, type the Passphrase on the allotted boxes.

After modifying any of the above properties, click **Apply** to save and apply changes.

Extended Wi-Fi Setting

The **Extended Wi-Fi Setting** menu allows you to modify the default SSIDs assigned to your device and configure its authentication and password settings to protect it from unauthorized access.

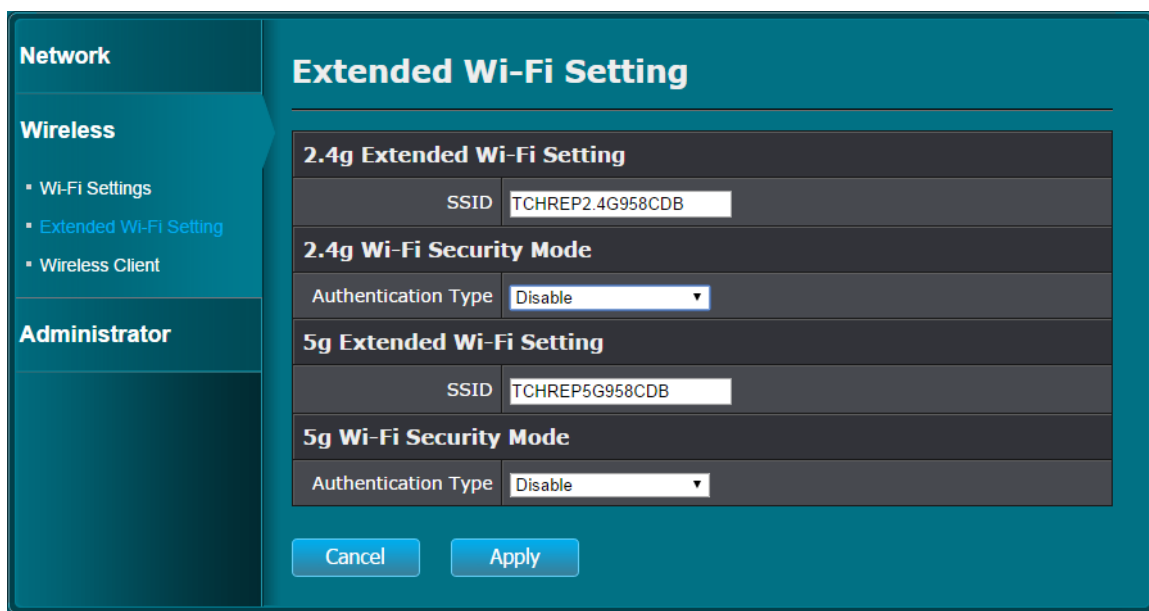

Properties	Description
2.4g Extended Wi-Fi Setting	If you wish to modify the default SSID assigned to the 2.4Ghz band, type the preferred network name on this box.
2.4g Wi-Fi Security Mode	<p>To prevent unauthorized access to the network, select and configure the authentication type for your device.</p> <ul style="list-style-type: none"> • Disable: Select if you will not require authentication to connect to the wireless network. • WEP: Select if you wish to use the WEP security for authentication. Select WEP, Mode, and WEP Key, and then type the Key on the allotted box. Connecting devices must enter the correct WEP key to establish connection. • WPA/WPA-2Personal: Select if you wish to use the WPA/WPA-2 security for authentication. Then, type the Passphrase on the allotted boxes. Connecting devices

Properties	Description
	must enter the correct WPA/WPA-2 passphrase to establish connection.
5g Extended Wi-Fi Setting	If you wish to modify the default SSID assigned to the 5Ghz band, type the preferred network name on this box.
5g Wi-Fi Security Mode	<p>To prevent unauthorized access to the network, select and configure the authentication type for your device.</p> <ul style="list-style-type: none"> • Disable: Select if you will not require authentication to connect to the wireless network. • WEP: Select if you wish to use the WEP security for authentication. Select WEP, Mode, and WEP Key, and then type the Key on the allotted box. Connecting devices must enter the correct WEP key to establish connection. • WPA/WPA-2Personal: Select if you wish to use the WPA/WPA-2 security for authentication. Then, type the Passphrase on the allotted boxes. Connecting devices must enter the correct WPA/WPA-2 passphrase to establish connection.

After modifying any of the above properties, click **Apply** to save and apply changes.

Wireless Client

This page allows you to view the wireless clients connected to your device.

Wireless Client	
Name	MAC Address
MY_CLIENT	00:1e:65:99:2e:3a

4.5.2 AP Mode - Access Point

Basic

The **Basic** page allows you to configure the basic wireless settings.

The screenshot shows the 'Wireless Basic' configuration interface. On the left is a navigation menu with sections: Operation, Network, Wireless (with sub-items: Basic, Security, WiFi Protected Setup, Wireless Client), and Administrator. The main area is titled 'Wireless Basic' and contains two sections: '2.4g Basic' and '5g Basic'. Each section has a table of settings. The 2.4g section has SSID, AutoChannel, Channel, 802.11 Mode, and Channel Width. The 5g section has SSID, AutoChannel, Channel, 802.11 Mode, and Channel Width. At the bottom are 'Cancel' and 'Apply' buttons.

Properties	Description
2.4g Basic	
SSID	If you wish to modify the default SSID assigned to the 2.4Ghz band, type the preferred network name on this box.
AutoChannel	Check the box to select auto channel option.
Channel	If AutoChannel is not selected, you may select the Channel from this box.
802.11 Mode	Limit the type of wireless clients that can connect to your device by selecting the 802.11 protocol.
Channel Width	Select the channel width.
5g Basic	
SSID	If you wish to modify the default SSID assigned to the 5Ghz band, type the preferred network name on this box.
AutoChannel	Check the box to select auto channel option.

Properties	Description
Channel	If AutoChannel is not selected, you may select the Channel from this box.
802.11 Mode	Limit the type of wireless clients that can connect to your device by selecting the 802.11 protocol.
Channel Width	Select the channel width.

After modifying any of the above properties, click **Apply** to save and apply changes.

Security

The Security page allows you to configure the authentication and password settings of your device to protect it from unauthorized access.



Properties	Description
2.4g Security Authentication Type	<p>To protect your device from unauthorized access, select and configure the authentication type that connecting devices must use to connect to the 2.4Ghz band.</p> <ul style="list-style-type: none"> • Disable: Select if you will not require authentication to connect to your device. • WEP: Select if you wish to use the WEP security for authentication. Select WEP, Mode, and WEP Key, and then type the Key on the allotted box. Connecting devices must enter the correct WEP key to establish connection. • WPA/WPA-2Personal: Select if you wish to use the WPA/WPA-2 security for authentication. Then, type the Passphrase on the allotted boxes. Connecting devices must enter the correct WPA/WPA-2 passphrase to establish connection.

Properties	Description
5g Security Authentication Type	<p>To protect your device from unauthorized access, select and configure the authentication type that connecting devices must use to connect to the 2.4Ghz band.</p> <ul style="list-style-type: none"> • Disable: Select if you will not require authentication to connect to your device. • WEP: Select if you wish to use the WEP security for authentication. Select WEP, Mode, and WEP Key, and then type the Key on the allotted box. Connecting devices must enter the correct WEP key to establish connection. • WPA/WPA-2Personal: Select if you wish to use the WPA/WPA-2 security for authentication. Then, type the Passphrase on the allotted boxes. Connecting devices must enter the correct WPA/WPA-2 passphrase to establish connection.

After modifying any of the above properties, click **Apply** to save and apply changes.

Wi-Fi Protected Setup

The Wi-Fi Protected Setup page allows you to enable/disable the WPS function of your device and allow wireless clients to connect to your device using the Push Button (PBC).

Properties	Description
WPS Configuration	Wi-Fi Protected Setup (WPS) allows wireless clients to connect to your device by pressing the WPS button on your

Properties	Description
	device and the WPS button on the connecting device. Once connected, the wireless connection settings, such as SSID, password, etc., are automatically sync on both devices. Select Enable to enable WPS function or Disable to disable the function, then click Apply .
PushButton Configuration (PBC)	Instead of pressing the WPS button on your device physically, you may click Start PBC to activate the WPS function of your device and start pairing with a wireless client.

Wireless Client

The **Wireless Client** page allows you to view the wireless clients connected to your device.

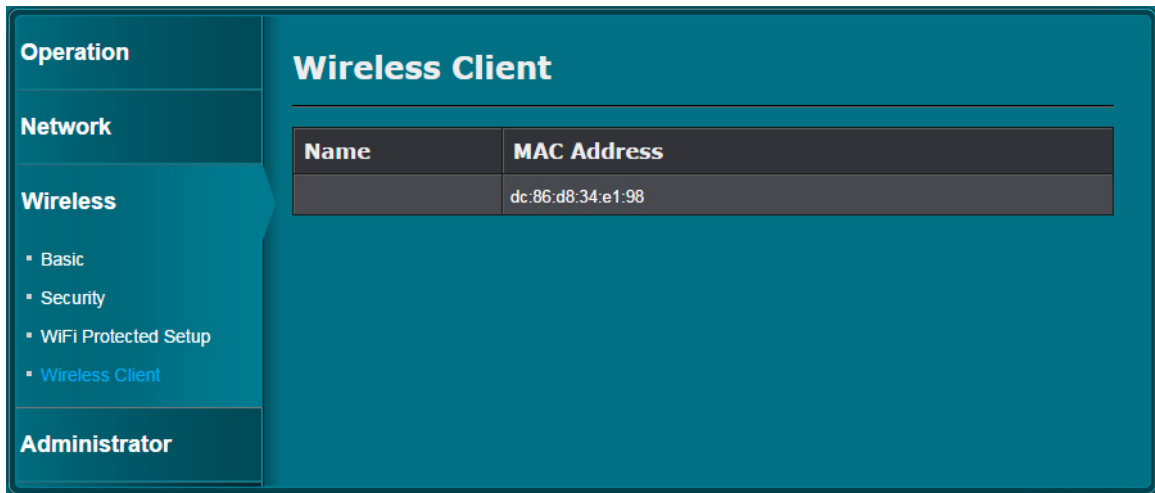

4.5.3 AP Mode – Station

The AP-Station mode is used when a client device, for example a PC, has no wireless function but wish to connect to a wireless network. Connect the PC to your device using an RJ-45 cable and access the web configuration page of your device.

The **Wireless Settings** page on AP - Station mode allows your PC to connect to a wireless network.

Properties	Description
Wireless Mode	Click Site Survey to search for the wireless network you wish to connect to. The list of available network appears, select and click Connect .
SSID	Displays the SSID of the wireless network selected from Site Survey or the last connected network. If you know the SSID of the wireless network that you want to connect to, you can also directly type it on this box.
Authentication Type	Select the authentication type needed to connect to the wireless network. <ul style="list-style-type: none"> • Disable: Select if authentication is not required to connect to the wireless network. • WEP: Select if the network uses the WEP security setting. Select WEP, Mode, and WEP Key, and then type the Key on the allotted box. • WPA/WPA-2Personal: Select if the network uses the WPA/WPA-2 security setting. Then, type the Passphrase on the allotted boxes.

After modifying any of the above properties, click **Apply** to save and apply changes.

4.6 Administrator Menu

The **Administrator** menu allows you to configure more advanced functions, such as managing the admin and user passwords, setting of device name, upgrading the firmware, restoring configuration settings, and others.

4.6.1 Management

The Management page allows you to set the administrator and user password and configure the device name setting.

Properties	Description
Administrator	There is only one administrator account for your device. The administrator account has all the rights to modify all of the device settings. The default name is "admin". The administrator account name cannot be modified. By default, the administrator account's password is blank.
New Password	Type a password to access the administrator account.
Confirm Password	Re-type the administrator account password to confirm.
User	There is only one user account for your device. The user account can only view the device settings, modification of any setting is not allowed. The default name is "user". The administrator account name cannot be modified. By default, the user account's password is blank.
New Password	Type a password to access the user account.

Properties	Description
Confirm Password	Re-type the user account password to confirm.
Device Name Settings	
Host Name	Type the preferred name for your device.

After modifying any of the above properties, click **Apply** to save and apply changes.

4.6.2 Upload Firmware

The **Upload Firmware** page allows you to upgrade the firmware of your device.

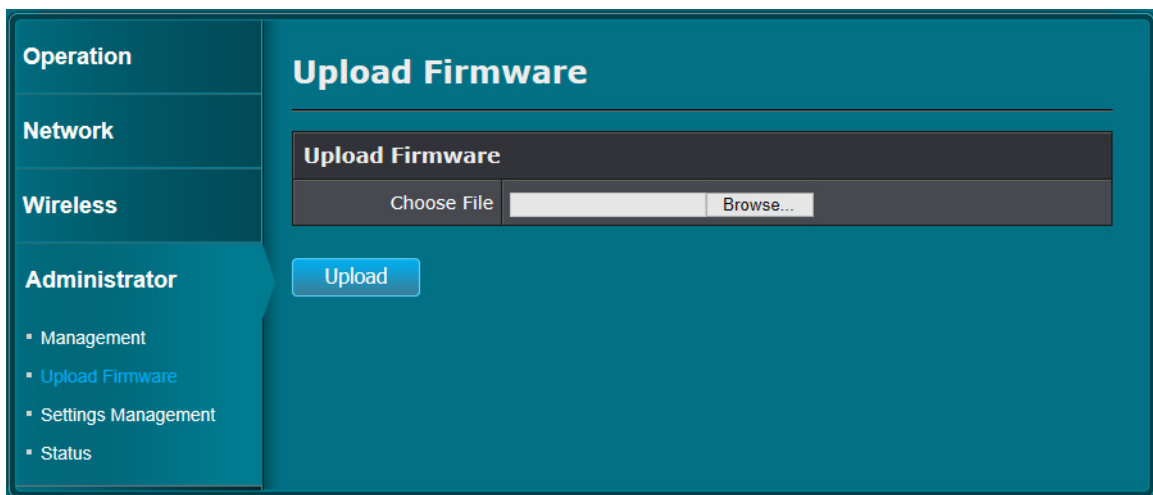

1. Download the latest firmware from the website and save it to your PC.
2. On the **Upload Firmware** page, click **Browse** and select the firmware.
3. Click **Upload** to start the upgrade.

4.6.3 Settings Management

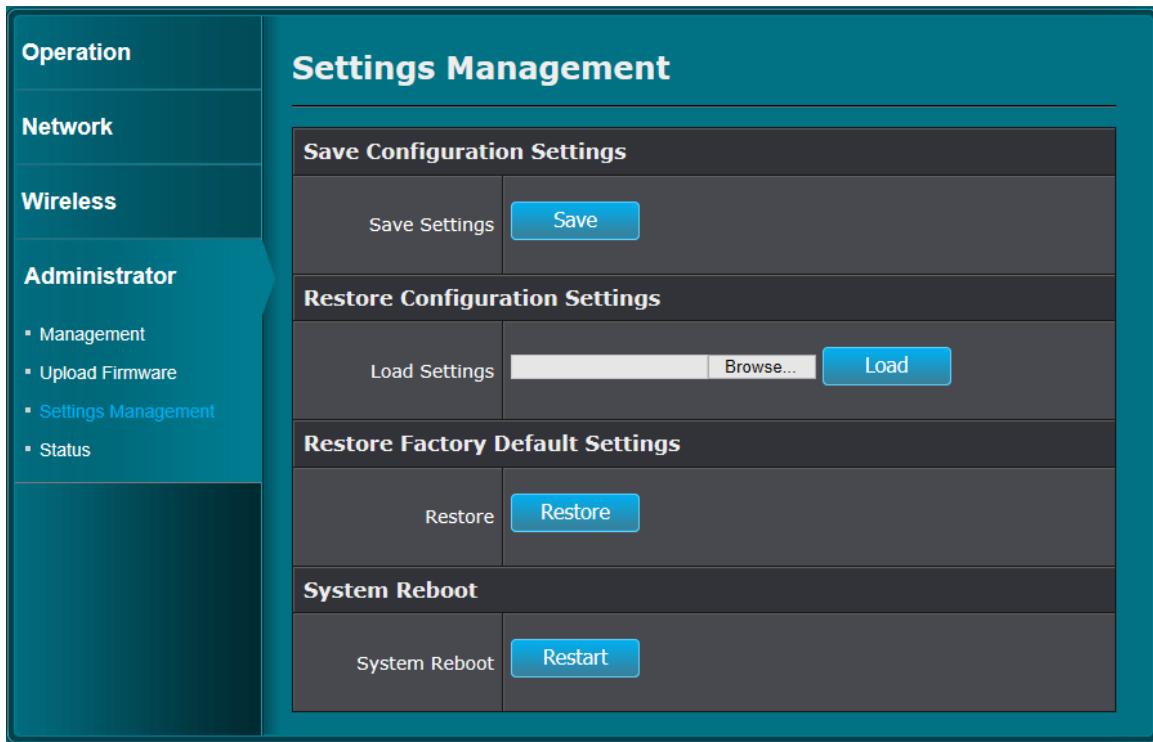

Properties	Description
Save Configuration Settings	To save the current device configuration settings, click Save .
Restore Configuration Settings	Use this setting to restore a previously saved configuration settings. Click Browse to browse for the saved configuration file and click Load to start the restoration process.
Restore Factory Default Settings	Click Restore to restore the device to its default factory settings.
System Reboot	Click Restart to reboot the device.

4.6.4 Status

The Status page allows you to view all the device information.

Operation

Network

Wireless

Administrator

- Management
- Upload Firmware
- Settings Management
- Status

Status

Device Information	
Firmware Version	1.00B11
Station up time	0 Day, 00:09:45

Network Configurations	
MAC Address	00:18:e7:95:8c:db
Connection	DHCP
IP Address	192.168.0.50
Subnet Mask	255.255.255.0
Gateway Address	0.0.0.0
DNS	0.0.0.0

IPv6	
IPv6 Device Management Interface	Autoconfiguration (SLAAC/DHCPv6)
LAN IPv6 Address	NONE
IPv6 Default Gateway	N/A
LAN IPv6 Link-Local Address	FE80::218:E7FF:FE95:8CDB/64
DNS	Not Available

Wi-Fi Network	
Network Status	Disconnected
MAC Address	02:18:e7:94:8c:db
SSID	MyNetwork
Security Mode	Auto (WPA or WPA2)
Channel Width	Auto 20/40/80 MHz
Channel	36

Appendix

A. Configure the Computer

This chapter will guide you on how to configure your computer according to the operating system you are using.

Windows® XP, see below.

Windows® Vista, see page 16.

Windows® 7, see page 16.

Windows XP

If you are using Windows® XP, follow the instructions below to configure your computer.

1. Click Start > Control Panel > Network Connections.
2. Right-click Local Area Connection, then click Properties.
3. On the network components list, make sure that **Internet Protocol (TCP/IP)** is checked. If not, check it to enable the **Properties** button.
4. Select Internet Protocol (TCP/IP), and then click Properties.
5. On the General tab, select Obtain an IP Address automatically and Obtain DNS server address automatically.
6. Click **OK**.

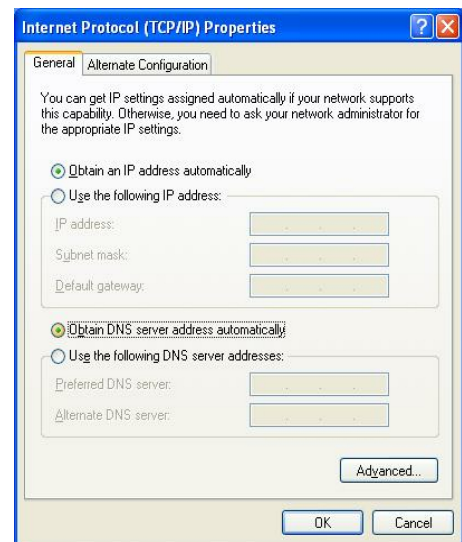

General Page

Windows Vista

If you are using Windows® Vista, follow the instructions below to configure your computer.

1. Click Start > Control Panel > Network and Internet Connections > Network Connections.
2. Right-click Local Area Connection, then click Properties.
3. On the General tab, make sure that **Internet Protocol (TCP/IP)** is checked. If not, check it to enable the **Properties** button.
4. Select Internet Protocol (TCP/IP), and then click Properties.
5. Select Obtain an IP Address automatically and Obtain DNS server address automatically.
6. Click **OK**.

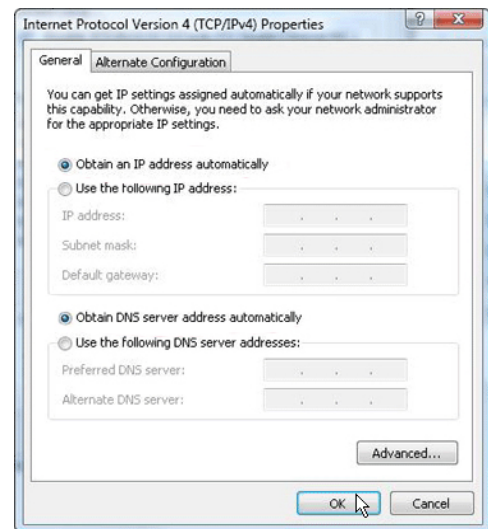

General Page

Windows 7

If you are using Windows® 7, follow the instructions below to configure your computer.

1. Click Start > Control Panel > Network & Sharing Center.
2. Click Local Area Connection.
3. Click Properties.
4. On the network components list, make sure that **Internet Protocol (TCP/IP)** is checked. If not, check it to enable the **Properties** button.
5. Select Internet Protocol (TCP/IP), and then click Properties.
6. On the General tab, select Obtain an IP Address automatically and Obtain DNS server address automatically.
7. Click **OK**.

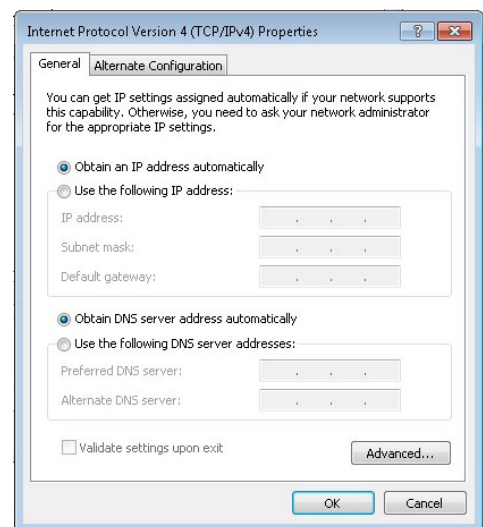

General Page

B. Wireless Considerations

Connection Performance

A number of factors affect wireless connections. To ensure high-range and stable connectivity, do the following:

1. Keep the Repeater and other wireless devices away from obstructions, such as walls or buildings. Each obstruction can reduce the range of a wireless device.
2. Keep the Repeater and other wireless devices away from devices that produce radio frequency (RF) noise, such as microwave ovens or radios.
3. Keep the Repeater and other wireless devices away from any device operating on the 2.4GHz frequency, such as cordless phones or remote controls.

Security Checklist

Wireless network signals can be intercepted easily. To prevent unauthorized users from connecting to your wireless network, follow the guidelines below.

1. Change the default wireless network name.
Your device has a default Service Set Identifier (SSID) which is the wireless network name. Change the SSID with a unique name to identify your network. The SSID can be up to 32 characters in length.
2. Change the default password.
Your device has a default password. You have to enter this password to change your network settings. Change the password to prevent unauthorized users from hacking into your network and changing the settings.
3. Enable MAC address filtering.
Your device supports Media Access Control (MAC) address filtering. You can assign a MAC address on each computer that you want to connect to your wireless network. When MAC address filtering is enabled, only the computers with the specified MAC addresses are allowed access.
4. Enable encryption
Your device supports Wired Equivalent Privacy (WEP), and Wi-Fi Protected Access (WAP/WPA2) encryption. To ensure a high level of security, enable the highest security encryption and use strong passphrases, avoid using words that can be found in the dictionary.

C. Regulatory & Safety Information

Wireless LAN, Health and Authorization

Radio frequency electromagnetic energy is emitted from Wireless LAN devices. The energy levels of these emissions however are far much less than the electromagnetic energy emissions from wireless devices like for example mobile phones. Wireless LAN devices are safe for use frequency safety standards and recommendations. The use of Wireless LAN devices may be restricted in some situations or environments for example:

Onboard airplanes, or

In an explosive environment, or

In case the interference risk to other devices or services is perceived or identified as harmful

In case the policy regarding the use of Wireless LAN devices in specific organizations or environments (e.g. airports, hospitals, chemical/oil/gas industrial plants, private buildings etc.) is not clear, please ask for authorization to use these devices prior to operating the equipment.

Disclaimers

Installation and use of this Wireless LAN device must be in strict accordance with the instructions included in the user documentation provided with the product. Any changes or modifications made to this device that are not expressly approved by the manufacturer may void the user's authority to operate the equipment. The Manufacturer is not responsible for any radio or television interference caused by unauthorized modification of this device, of the substitution or attachment. Manufacturer and its authorized resellers or distributors will assume no liability for any damage or violation of government regulations arising from failing to comply with these guidelines.

FCC (Federal Communications Commission) Statement

This equipment has been tested and found to comply with the limits for a Class B digital device, pursuant to Part 15 of the FCC Rules. These limits are designed to provide reasonable protection against harmful interference in a residential installation. This equipment generates, uses and can radiate radio frequency energy and, if not installed and used in accordance with the instructions, may cause harmful interference to radio communications. However, there is no guarantee that interference will not occur in a particular installation. If this equipment does cause harmful interference to radio or television reception, which can be determined by turning the equipment off and on, the user is encouraged to try to correct the interference by one of the following measures:

- Reorient or relocate the receiving antenna.
- Increase the separation between the equipment and receiver.

- Connect the equipment into an outlet on a circuit different from that to which the receiver is connected.
- Consult the dealer or an experienced radio/TV technician for help.

FCC Caution: Any changes or modifications not expressly approved by the party responsible for compliance could void the user's authority to operate this equipment. This device complies with Part 15 of the FCC Rules. Operation is subject to the following two conditions:

1. This device may not cause interference, and
2. This device must accept any interference, including interference that may cause undesired operation of this device.

Operation of this device is restricted to indoor use only.

IMPORTANT NOTE:

FCC Radiation Exposure Statement:

This equipment complies with FCC radiation exposure limits set forth for an uncontrolled environment. This equipment should be installed and operated with minimum distance 20cm between the radiator & your body.

This transmitter must not be co-located or operating in conjunction with any other antenna or transmitter.

The availability of some specific channels and/or operational frequency bands are country dependent and are firmware programmed at the factory to match the intended destination. The firmware setting is not accessible by the end user.

RF Exposure Notice:

To comply with FCC/IC RF Exposure Limits set forth for an uncontrolled environment, the product must be installed and operated with a minimum separation distance (between nearby person(s) and radiating antenna) according to the following scenarios:

1. 20cm minimum when the product is operated alone without co-transmitting with a plug-in 3G USB dongle device.
2. 45cm minimum when the product is operated with a plug-in 3G USB device which has a maximum of 7W ERP output power.
3. For co-transmission scenario which is not covered above, please consult the RF technician or device supplier.



CE statement

Europe – EU Declaration of Conformity

This device complies with the essential requirements of the R&TTE Directive 1999/5/EC. The following test methods have been applied in order to prove presumption of conformity with the essential requirements of the R&TTE Directive 1999/5/EC:

EN60950-1: 2006

Safety of Information Technology Equipment

EN 50385: 2002

Product standard to demonstrate the compliance of radio base stations and fixed terminal stations for wireless telecommunication systems with the basic restrictions or the reference levels related to human exposure to radio frequency electromagnetic fields (110MHz - 40 GHz) - General public

EN 300 328 V1.7.1 (2006-10)

Electromagnetic compatibility and Radio spectrum Matters (ERM); Wideband transmission systems; Data transmission equipment operating in the 2,4 GHz ISM band and using wide band modulation techniques; Harmonized EN covering essential requirements under article 3.2 of the R&TTE Directive

EN 301 489-1 V1.8.1 (2008-04)

Electromagnetic compatibility and Radio Spectrum Matters (ERM); ElectroMagnetic Compatibility (EMC) standard for radio equipment and services; Part 1: Common technical requirements

EN 301 489-17 V2.1.1 (2009-05)

Electromagnetic compatibility and Radio spectrum Matters (ERM); ElectroMagnetic Compatibility (EMC) standard for radio equipment; Part 17: Specific conditions for Broadband Data Transmission Systems.

This device is a 2.4 GHz wideband transmission system (transceiver), intended for use in all EU member states and EFTA countries, except in France and Italy where restrictive use applies.

In Italy the end-user should apply for a license at the national spectrum authorities in order to obtain authorization to use the device for setting up outdoor radio links and/or for supplying public access to telecommunications and/or network services. This device may not be used for setting up outdoor radio links in France and in some areas the RF output power may be limited to 10 mW EIRP in the frequency range of 2454 – 2483.5 MHz. For detailed information the end-user should contact the national spectrum authority in France.



D. Specifications

Interface	<ul style="list-style-type: none"> • LAN: 1 x 10/100Mbps Auto-MDIX Ethernet port • Reset Button • WPS Button • On/Off Switch
LEDs	<ul style="list-style-type: none"> • Power LED • Wireless LED • Link LED • WPS LED
Standards	IEEE 802.11ac/n/g/b/a
Transmission Rate	<ul style="list-style-type: none"> • 802.11a: up to 54Mbps • 802.11b: up to 11Mbps • 802.11g: up to 54Mbps • 802.11n: up to 300Mbps (for 2.4GHz) • 802.11n: up to 150Mbps (for 5GHz) • 802.11ac: up to 433Mbps
Receiver Sensitivity	<ul style="list-style-type: none"> • 11ac VHT80 MCS9: Typical - 51dBm @ 10% PER • 11a/n HT40 MCS7: Typical - 61dBm @ 10% PER • 11a/n HT20 MCS7: Typical - 64dBm @ 10% PER • 11a/g 54Mbps: Typical - 65dBm @ 10% PER • 11b 11Mbps: Typical - 83dBm @ 8% PER
Wireless LAN Frequency Range	<ul style="list-style-type: none"> • 5GHz: FCC 5.180 – 5.240 + 5.745 – 5.825, ETSI: 5.180 – 5.725 GHz • 2.4GHz: FCC: 2.412 – 2.462, ETSI:2.412 – 2.472 GHz
Modulation Schemes	<ul style="list-style-type: none"> • DBPSK/DQPSK/CCK for DSSS technique • BPSK/QPSK/16-QAM/64-QAM/256-QAM for OFDM technique
Media Access Protocol	<ul style="list-style-type: none"> • CSMA/CA with ACK
Transmit Power	<p>2.4G Mode</p> <ul style="list-style-type: none"> • FCC:20dBm,ETSI:16.5dBm (max) @ 802.11b • FCC:20dBm,ETSI:16.5dBm (max) @ 802.11g • FCC:20dBm,ETSI:13.5dBm (max) @ 802.11n HT20 • FCC:17dBm,ETSI:13.5dBm (max) @ 802.11n HT40 <p>5G Mode</p> <ul style="list-style-type: none"> • FCC:20dBm,ETSI:18dBm (max) @ 802.11a • FCC:20dBm,ETSI:18dBm (max) @ 802.11n HT20 / 802.11ac VHT20 • FCC:18dBm,ETSI:18dBm (max) @ 802.11n HT40 / 802.11ac VHT40 • FCC:14dBm,ETSI:14dBm (max) @ 802.11ac VHT80

Antenna Type	<ul style="list-style-type: none">• 2.4G 2dBi Single Band PIFA antenna x 1• 2.4G & 5G 3dBi Dual Band PIFA antenna x 1
Protocol	TCP/IP
Network Management	Web base configuration utility via Ethernet
Channel	2.4Ghz <ul style="list-style-type: none">• Channel 1 ~ 11(FCC)• Channel 1 ~ 13(ETSI) 5Ghz <ul style="list-style-type: none">• Channel 36, 40, 44, 48, 149, 153, 157, 161 and 165(FCC)• Channel 36, 40, 44, 48(ETSI)
Security	<ul style="list-style-type: none">• 64/128-bits WEP Encryption• WPA, WPA2• WPA-PSK, WPA2-PSK• MAC address filtering
Range Coverage	<ul style="list-style-type: none">• Indoor: Up to 100 meters (depends on environment)• Outdoor: Up to 300 meters (depends on environment)
Power	Power Input: AC 100~240V Max. Power Consumption: 3.2W (Full load)
Temperature	Operating: 0°C ~ 40° C Storage: -10°c ~ 70°C
Humidity	Operating: 10% ~ 95%, RH, no condensation
Dimensions	87 x 56 x 47 mm (plug excluded)



TECHNICOLOR WORLDWIDE HEADQUARTERS

1, Rue Jeanne d'Arc

92443 Issy-les-Moulineaux

France

www.technicolor.com