

FCC RADIO TEST REPORT

according to

47 CFR FCC Part 15 Subpart E § 15.407

Equipment Name : Cable Modem
Model Number : TC8737C , TC8737COX , TC8735S
Filing Type : New Application
FCC ID : G95-TC8737C
Trade Name : technicolor
Applicant : Technicolor USA, Inc.
101 West 103rd Street
Indianapolis, IN 46290

Statement

Test result included is for the IEEE 802.11n and IEEE 802.11a/ac (5150 ~ 5250MHz / 5725 ~ 5850MHz) of the product.

The test result in this report refers exclusively to the presented test model / sample.

Without written approval of SPORTON International Inc., the test report shall not be reproduced except in full.

The measurements and test results shown in this test report were made in accordance with the procedures and found in compliance with the limit given in **ANSI C63.10-2013, 47 CFR FCC Part 15 Subpart E,**

KDB789033 D02 v01, KDB 662911 D01 v02r01 and KDB644545 D03 v01.

The test equipment used to perform the test is calibrated and traceable to NML/ROC.



SPORTON International Inc.

No. 52, Hwa Ya 1st Rd., Kwei-Shan Hsiang, Tao Yuan Hsien, Taiwan, R.O.C.

Table of Contents

1 SUMMARY OF THE TEST RESULT 2

- 1.1 Information provided by the manufacturer..... 3
- 1.2 Application of harmonized standard 3
- 1.3 Cabling Attached to the Equipment..... 4
- 1.4 Panel Drawing 5

2 GENERAL INFORMATION..... 6

- 2.1 Product Details 6
- 2.2 Accessories 7
- 2.3 Table for Filed Antenna 7
- 2.4 Transmit Operating Modes 12
- 2.5 Table for Carrier Frequencies 13
- 2.6 Table for Test Modes 14
- 2.7 Duty Cycle 15
- 2.8 Table for Testing Locations 16
- 2.9 Table for Supporting Units..... 16
- 2.10 Table for Parameters of Test Software Setting 17
- 2.11 Test Configuration 19

3 TEST RESULT 22

- 3.1 AC Power Line Conducted Emissions Measurement..... 22
- 3.2 Emission bandwidth Measurement 26
- 3.3 Maximum Conducted Output Power Measurement 122
- 3.4 Power Spectral Density Measurement 133
- 3.5 Radiated Emissions Measurement..... 178
- 3.6 Frequency Stability Measurement..... 332
- 3.7 Antenna Requirements..... 340

4 LIST OF MEASURING EQUIPMENTS 341

5 MEASUREMENT UNCERTAINTY 343

APPENDIX A. TEST PHOTO..... A1 ~ A5

APPENDIX B. MAXIMUM PERMISSIBLE EXPOSURE..... B1 ~ B17

APPENDIX C. PHOTOGRAPHS OF EUT C1 ~ C30

APPENDIX D. SSROM VALUE AND CURPOWER VALUE

History of This Test Report

REPORT NO.	VERSION	DESCRIPTION	ISSUED DATE
FR510501AB	Rev.01	Initial issue of report	Apr. 17, 2015

VERIFICATION OF COMPLIANCE

according to

47 CFR FCC Part 15 Subpart E § 15.407

Equipment Name : Cable Modem
Model Number : TC8737C , TC8737COX , TC8735S
Trade Name : technicolor
Applicant : Technicolor USA, Inc.
101 West 103rd Street
Indianapolis, IN 46290

Sporton International as requested by the applicant to evaluate the EMC performance of the product sample received on Mar. 25, 2015 would like to declare that the tested sample has been evaluated and found to be in compliance with the tested rule parts. The data recorded as well as the test configuration specified is true and accurate for showing the sample's EMC nature.



Sam Chen

SPORTON International Inc.

No. 52, Hwa Ya 1st Rd., Kwei-Shan Hsiang, Tao Yuan Hsien, Taiwan, R.O.C.

1 SUMMARY OF THE TEST RESULT

Applied Standard: 47 CFR FCC Part 15 Subpart E				
Part	Rule Section	Description of Test	Result	Under Limit
3.1	15.407(b)(6)	AC Power Conducted Emissions	Complies	19.02 dB
3.2	15.407(e)	Emission bandwidth 6dB bandwidth for U-NII-3	Complies	-
3.3	15.407(a)(1/2/3)	Maximum Conducted Output Power	Complies	6.76 dB
3.4	15.407(a)(1/2/3)	Power Spectral Density	Complies	7.02 dB
3.5	15.407(b)(1/2/3/4/6)	Radiated Emissions	Complies	3.61 dB
		Band Edge Measurement	Complies	0.04 dB
3.6	15.407(g)	Frequency Stability	Complies	-
3.7	15.203	Antenna Requirements	Complies	-

1.1 Information provided by the manufacturer

Equipment Name: Cable Modem
 Model Number: TC8737C , TC8737COX , TC8735S
 Trade Name: technicolor
 Power Supply: 1. Internal AC-DC power pack, 12Vdc, 3.5A, Manufacturer: AcBel, Model: STD003
 2. Battery, Manufacturer: Getac, Model: BP-TC8-22/2250 S, Rating:7.2V 4300mAh
 AC Power Cord: 2pin
 Hardware Version: Lab2

Interface Availability

Interface Model Number.	Internal AC-DC power pack Input: 100V~130Voutput: 12Vdc3.5A	Battery	Cable modem: DOCSIS 3.0 Cable Modem MoCA: MoCA 2.0 D Band 1125MHz and 1525MHz	Ethernet 10/100/1000Mbps	USB 2. 0	FXS	WLAN IEEE 802.11a/b/g/n/ac(2.4GHz/5GHz 3*3)
TC8737C	●	●	●	●(4 port)	●(2 port)	●(2 port)	●
TC8737COX	●	●	●	●(4 port)	●(2 port)	●(2 port)	●
TC8735S	●	○	●	●(4 port)	●(2 port)	○	●

- : Equipped ○ : Not Equipped
- Model Number: TC8737C and TC8737COX HW are the same, different model name is because for different marketing purpose.
- Model Number: TC8735S is without battery pack and without FXS port function.
- Model Number: TC8737C was selected as representative model for the test and its data was recorded in this report.

1.2 Application of harmonized standard

US Standard: 47 CFR FCC Part 15 Subpart E § 15.407
 ANSI C63.10-2013
 KDB662911 D01 Multiple Transmitter Output v02r01, 10/31/2013
 KDB789033 D02 General UNII Test Procedures New Rules v01, 06/06/2014
 KDB644545 D02 Alternative Guidance for 802 11ac v01, 06/07/2012
 KDB644545 D03 Guidance for IEEE 802.11ac v01, 08/14/2014

1.3 Cabling Attached to the Equipment

Table 1- Cable and Interconnection

For Model Number: TC8737C, TC8737COX

Interface	Cable type	Cable length delivered with the modem	“Real life” Cable length that can be attached to this type of interface	Cable length to be used for testing	Internal/ external connection
Cable & MoCA	coaxial	2 meter	> 10 meter	10 meter	External
Eth1	UTP Cat 5	2 meter	> 10 meter	10 meter	Internal
FXS1/2	UTP Cat 3	2 meter	> 10 meter	1 meter flat cable	Internal
USB1/2	STP	1 meter	< 3 meter	1 meter	Internal
AC power					Internal
Battery					Internal

For Model Number: TC8735S

Interface	Cable type	Cable length delivered with the modem	“Real life” Cable length that can be attached to this type of interface	Cable length to be used for testing	Internal/ external connection
Cable & MoCA	coaxial	2 meter	> 10 meter	10 meter	External
Eth1	UTP Cat 5	2 meter	> 10 meter	10 meter	Internal
USB1/2	STP	1 meter	< 3 meter	1 meter	Internal
AC power					Internal

1.4 Panel Drawing

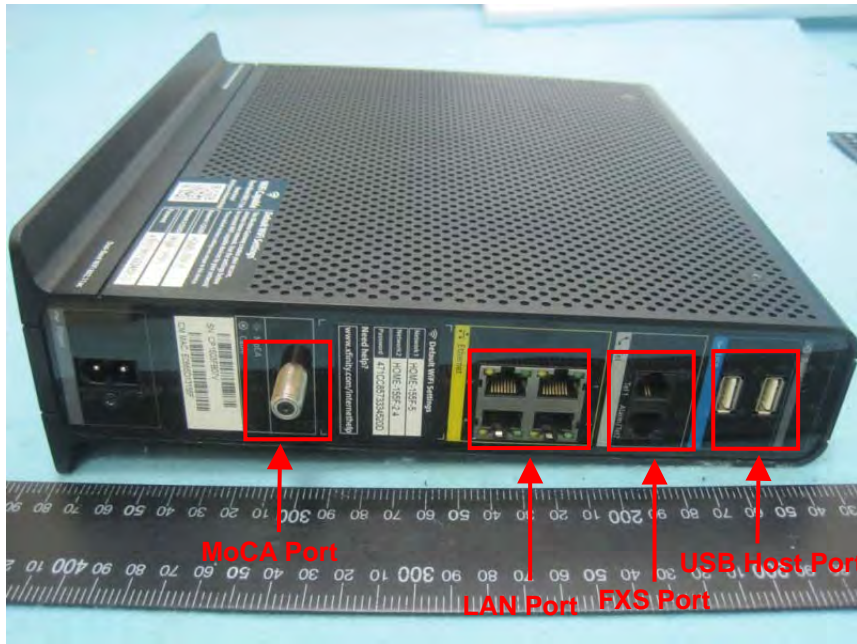

2 GENERAL INFORMATION

2.1 Product Details

Items	Description			
Product	Stand alone			
Model Number	TC8737C , TC8737COX , TC8735S			
FCC ID	G95-TC8737C			
Power Type	Internal power supply and Battery			
EUT Stage	<input checked="" type="checkbox"/> Product Unit	<input type="checkbox"/>	Pre-Sample	
Antenna Type	Please see Section 2.3			
Operating Band, Conducted Power	U-NII-1 5150~5250MHz	<input checked="" type="checkbox"/>	IEEE 802.11a: 21.22 dBm	
		<input checked="" type="checkbox"/>	For Non-Beamforming IEEE 802.11ac (20MHz): 23.24 dBm IEEE 802.11ac (40MHz): 20.72 dBm IEEE 802.11ac (80MHz): 18.07 dBm	
		<input checked="" type="checkbox"/>	For Beamforming IEEE 802.11ac (20MHz): 21.64 dBm IEEE 802.11ac (40MHz): 19.43 dBm IEEE 802.11ac (80MHz): 18.48 dBm	
	U-NII-3 5725~ 5850 MHz	<input checked="" type="checkbox"/>	IEEE 802.11a: 19.64 dBm	
		<input checked="" type="checkbox"/>	For Non-Beamforming IEEE 802.11ac (20MHz): 20.58 dBm IEEE 802.11ac (40MHz): 21.20 dBm IEEE 802.11ac (80MHz): 18.06 dBm	
		<input checked="" type="checkbox"/>	For Beamforming IEEE 802.11ac (20MHz): 19.64 dBm IEEE 802.11ac (40MHz): 19.27 dBm IEEE 802.11ac (80MHz): 17.65 dBm	
Product Type	For IEEE 802.11a: WLAN (3TX, 3RX) For IEEE 802.11n: WLAN (3TX, 3RX) For IEEE 802.11ac: WLAN (3TX, 3RX)			
Nominal Channel Bandwidth	20MHz / 40MHz / 80MHz			
Modulation	802.11a: OFDM (BPSK / QPSK / 16QAM / 64QAM) 802.11n: (BPSK / QPSK / 16QAM / 64QAM) See the below table. 802.11ac:(BPSK / QPSK / 16QAM / 64QAM / 256QAM) See the below table			
Data Rate (Mbps)	11a mode :OFDM (6/9/12/18/24/36/48/54) 11n(20MHz) mode (MCS0~MCS23) 11n(40MHz) mode (MCS0~MCS23) 11ac(20MHz) mode (MCS0~MCS9 for Nss1~Nss3) 11ac(40MHz) mode (MCS0~MCS9 for Nss1~Nss3) 11ac(80MHz) mode (MCS0~MCS9 for Nss1~Nss3)			
Beam forming Function	<input checked="" type="checkbox"/>	With Beam forming for IEEE 802.11 n/ac	<input type="checkbox"/>	Without Beam forming

I/O Ports	LAN Port x 4 USB Host Port x 2 FXS Port x 2 Cable + MoCA Port x 1(Coaxial type)
Software Version	02.87.15.05.00
Associated Devices	single-range internal AC-DC power pack

2.2 Accessories

Others
AC power cord*1, unshielded 1.8m

2.3 Table for Filed Antenna

Ant.	Brand	Model Name	Antenna Type	Connector
1	Airgain	N5x20BW	PCB Antenna	I-PEX
2	-	-	Printed Antenna	N/A
3	Airgain	N5x20B	PCB Antenna	I-PEX

Antenna & Bandwidth

Antenna	1st (TX)			2nd (TX)			3rd (TX)		
	20 MHz	40 MHz	80 MHz	20 MHz	40 MHz	80 MHz	20 MHz	40 MHz	80MHz
802.11a	V	X	X	X	X	X	V	X	X
802.11n	V	V	X	V	V	X	V	V	X
802.11ac	V	V	V	V	V	V	V	V	V

Frequency	Antenna Gain (dBi)								
	Ant. 1 (WJ1)			Ant. 2 (WJ2)			Ant. 3 (WJ3)		
	20 MHz	40 MHz	80MHz	20 MHz	40 MHz	80MHz	20 MHz	40 MHz	80MHz
5180MHz	3.82	-	-	5.15	-	-	4.16	-	-
5190MHz	-	3.96	-	-	5.03	-	-	3.86	-
5200MHz	3.86	-	-	4.91	-	-	3.71	-	-
5210MHz	-	-	3.87	-	-	4.82	-	-	3.80
5230MHz	-	3.76	-	-	4.54	-	-	3.79	-
5240MHz	3.83	-	-	4.50	-	-	3.79	-	-
5745MHz	4.33	-	-	5.27	-	-	5.07	-	-
5755MHz	-	4.45	-	-	5.25	-	-	5.00	-
5775MHz	-	-	4.64	-	-	5.48	-	-	4.90
5785MHz	4.67	-	-	5.51	-	-	4.89	-	-
5795MHz	-	4.69	-	-	5.53	-	-	4.83	-
5825MHz	4.46	-	-	5.32	-	-	4.45	-	-

Frequency	Directional Gain (dBi) for Beamforming and CDD mode								
	1 Stream 3TX Ant. 1 + 2 + 3			2 Stream 3TX Ant. 1 + 2 + 3			3 Stream 3TX Ant. 1 + 2 + 3		
	20 MHz	40 MHz	80MHz	20 MHz	40 MHz	80MHz	20 MHz	40 MHz	80MHz
5180MHz	6.51	-	-	5.29	-	-	2.46	-	-
5190MHz	-	6.47	-	-	5.25	-	-	2.42	-
5200MHz	6.40	-	-	5.15	-	-	2.33	-	-
5210MHz	-	-	6.40	-	-	5.14	-	-	2.33
5230MHz	-	6.25	-	-	4.97	-	-	2.16	-
5240MHz	6.26	-	-	4.95	-	-	2.16	-	-
5745MHz	6.25	-	-	4.48	-	-	2.05	-	-
5755MHz	-	6.35	-	-	4.57	-	-	2.14	-
5775MHz	-	-	6.45	-	-	4.65	-	-	2.20
5785MHz	6.45	-	-	4.66	-	-	2.19	-	-
5795MHz	-	6.44	-	-	4.66	-	-	2.17	-
5825MHz	6.43	-	-	4.58	-	-	2.03	-	-

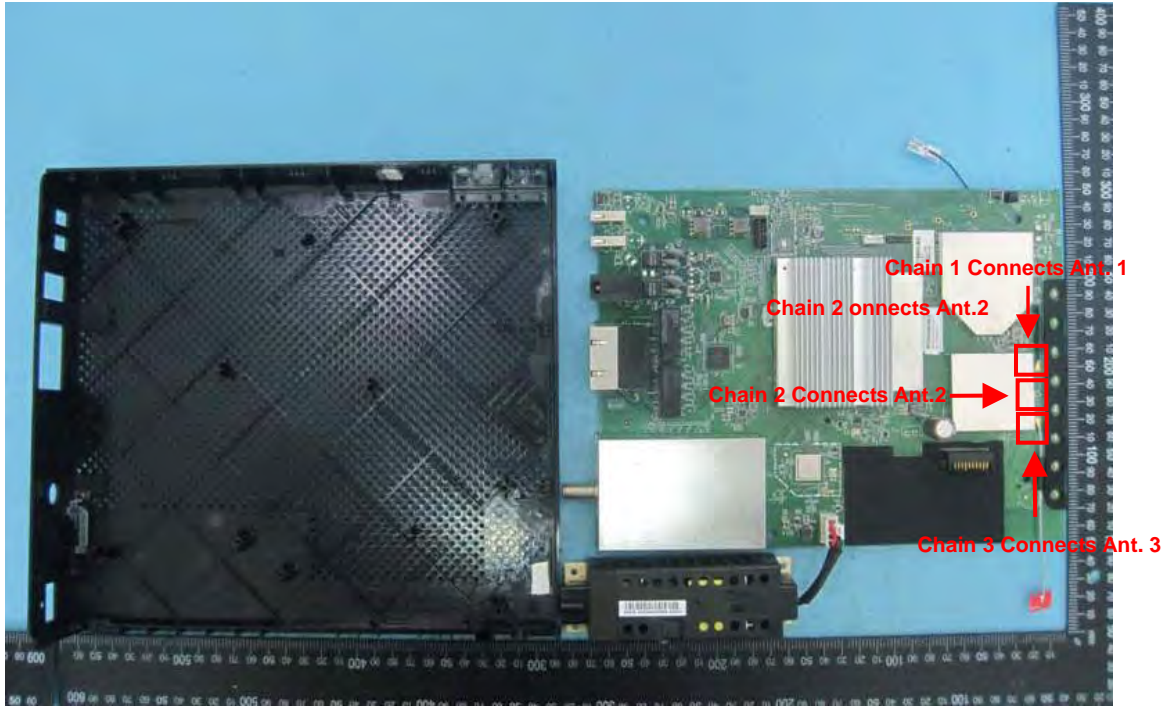

IEEE 802.11n Data Rate spec

Standard	INDEX	Data Rate (Mbps)		Standard	INDEX	Data Rate (Mbps)	
		LGI (800ns)	SIGI (400ns)			LGI (800ns)	SIGI (400ns)
11n 20MHz Nss=1	MCS0	6.5	7.2	11n 40MHz Nss=1	MCS0	13.5	15
	MCS1	13	14.4		MCS1	27	30
	MCS2	19.5	21.7		MCS2	40.5	45
	MCS3	26	28.9		MCS3	54	60
	MCS4	39	43.3		MCS4	81	90
	MCS5	52	57.8		MCS5	108	120
	MCS6	58.5	65		MCS6	121.5	135
	MCS7	65	72.2	MCS7	135	150	
11n 20MHz Nss=2	MCS8	13	14.4	11n 40MHz Nss=2	MCS8	27	30
	MCS9	26	28.9		MCS9	54	60
	MCS10	39	43.3		MCS10	81	90
	MCS11	52	57.8		MCS11	108	120
	MCS12	78	86.7		MCS12	162	180
	MCS13	104	115.6		MCS13	216	240
	MCS14	117	130		MCS14	243	270
	MCS15	130	144.4	MCS15	270	300	
11n 20MHz Nss=3	MCS16	19.5	21.7	11n 40MHz Nss=3	MCS16	40.5	45
	MCS17	39	43.3		MCS17	81	90
	MCS18	58.5	65		MCS18	121.5	135
	MCS19	78	86.7		MCS19	162	180
	MCS20	117	130		MCS20	243	270
	MCS21	156	173.3		MCS21	324	360
	MCS22	175.5	195		MCS22	364.5	405
	MCS23	195	216.7	MCS23	405	450	

IEEE 802.11ac Data Rate spec

Standard	INDEX	Data Rate (Mbps)		Standard	INDEX	Data Rate (Mbps)		Standard	INDEX	Data Rate (Mbps)	
		LGI (800ns)	SGI (400ns)			LGI (800ns)	SGI (400ns)			LGI (800ns)	SGI (400ns)
11ac 20MHz Nss=1	MCS0	6.5	7.2	11ac 40MHz Nss=1	MCS0	13.5	15	11ac 80MHz Nss=1	MCS0	29.3	32.5
	MCS1	13	14.4		MCS1	27	30		MCS1	58.5	65.0
	MCS2	19.5	21.7		MCS2	40.5	45		MCS2	87.8	97.5
	MCS3	26	28.9		MCS3	54	60		MCS3	117.0	130.0
	MCS4	39	43.3		MCS4	81	90		MCS4	175.5	195.0
	MCS5	52	57.8		MCS5	108	120		MCS5	234.0	260.0
	MCS6	58.5	65		MCS6	121.5	135		MCS6	263.3	292.5
	MCS7	65	72.2		MCS7	135	150		MCS7	292.5	325.0
	MCS8	78	86.7		MCS8	162.0	180.0		MCS8	351.0	390.0
	MCS9	Note	Note		MCS9	180.0	200.0		MCS9	390.0	433.3

NOTE: MCS 9 is invalid due to mod (N_{CBPS}/N_{ES}, D_R) not being equal to 0.

11ac 20MHz Nss=2	MCS0	13.0	14.4	11ac 40MHz Nss=2	MCS0	27.0	30.0	11ac 80MHz Nss=2	MCS0	58.5	65.0
	MCS1	26.0	28.9		MCS1	54.0	60.0		MCS1	117.0	130.0
	MCS2	39.0	43.3		MCS2	81.0	90.0		MCS2	175.5	195.0
	MCS3	52.0	57.8		MCS3	108.0	120.0		MCS3	234.0	260.0
	MCS4	78.0	86.7		MCS4	162.0	180.0		MCS4	351.0	390.0
	MCS5	104.0	115.6		MCS5	216.0	240.0		MCS5	468.0	520.0
	MCS6	117.0	130.0		MCS6	243.0	270.0		MCS6	526.5	585.0
	MCS7	130.0	144.4		MCS7	270.0	300.0		MCS7	585.0	650.0
	MCS8	156.0	173.3		MCS8	324.0	360.0		MCS8	702.0	780.0
	MCS9	13.0	14.4		MCS9	360.0	400.0		MCS9	780.0	866.7

11ac 20MHz Nss=3	MCS0	19.5	21.7	11ac 40MHz Nss=3	MCS0	40.5	45	11ac 80MHz Nss=3	MCS0	87.8	97.5
	MCS1	39	43.3		MCS1	81	90		MCS1	175.5	195.0
	MCS2	58.5	65		MCS2	121.5	135		MCS2	263.3	292.5
	MCS3	78	86.7		MCS3	162	180		MCS3	351.0	190.0
	MCS4	117	130		MCS4	243	270		MCS4	526.5	585.0
	MCS5	156	173.3		MCS5	324	360		MCS5	702.0	780.0
	MCS6	175.5	195		MCS6	364.5	405		MCS6	Note	Note
	MCS7	195	216.7		MCS7	405	450		MCS7	877.5	975.0
	MCS8	234.0	260.0		MCS8	486.0	540.0		MCS8	1053.0	1170.0
	MCS9	260.0	228.9		MCS9	540.0	600.0		MCS9	1170.0	1300.0

NOTE: MCS 6 is invalid due to mod (N_{CBPS}/N_{ES}, D_R) not being equal to 0.

2.4 Transmit Operating Modes

Transmit Operating Mode				Transmit Multiple Antennas				
<input type="checkbox"/>	Operating mode 1 (single antenna)			<input checked="" type="checkbox"/>	1TX			
<input type="checkbox"/>	Operating mode 2 (multiple antenna, no beam forming)			<input checked="" type="checkbox"/>	2TX	<input checked="" type="checkbox"/>	3TX <input type="checkbox"/> 4TX	
<input type="checkbox"/>	Operating mode 3 (multiple antenna, with beam forming)			<input checked="" type="checkbox"/>	2TX	<input checked="" type="checkbox"/>	3TX <input type="checkbox"/> 4TX	
<input type="checkbox"/>	802.11a	Operating mode	<input checked="" type="checkbox"/>	1TX	<input checked="" type="checkbox"/>	2TX	<input checked="" type="checkbox"/>	3TX <input type="checkbox"/> Cyclic shift
<input type="checkbox"/>	802.11n(20MHz)	Operating mode	<input checked="" type="checkbox"/>	1TX	<input checked="" type="checkbox"/>	2TX	<input checked="" type="checkbox"/>	3TX <input type="checkbox"/> Cyclic shift
<input type="checkbox"/>	802.11n(40MHz)	Operating mode	<input checked="" type="checkbox"/>	1TX	<input checked="" type="checkbox"/>	2TX	<input checked="" type="checkbox"/>	3TX <input type="checkbox"/> Cyclic shift
<input type="checkbox"/>	802.11ac(20MHz)	Operating mode	<input checked="" type="checkbox"/>	1TX	<input checked="" type="checkbox"/>	2TX	<input checked="" type="checkbox"/>	3TX <input type="checkbox"/> Cyclic shift
<input type="checkbox"/>	802.11ac(40MHz)	Operating mode	<input checked="" type="checkbox"/>	1TX	<input checked="" type="checkbox"/>	2TX	<input checked="" type="checkbox"/>	3TX <input type="checkbox"/> Cyclic shift
<input type="checkbox"/>	802.11ac(80MHz)	Operating mode	<input checked="" type="checkbox"/>	1TX	<input checked="" type="checkbox"/>	2TX	<input checked="" type="checkbox"/>	3TX <input type="checkbox"/> Cyclic shift

Note 1: For IEEE802.11n, MCS0~MCS7: 1TX; MCS8~MCS15: 2TX; MCS16 ~MCS23: 3TX

Note 2: For IEEE802.11ac(20/40/80MHz), MCS0~MCS9: 1 Stream 3TX; MCS0~MCS9: 2 Stream 3TX; MCS0~MCS9: 3 Stream 3TX

Note 3: For IEEE802.11a: 2TX without test due to covered by 3TX.

Note 4: For 1 Stream 2TX, 2 Stream 2TX, 2 Stream 3TX, 3 Stream 3TX without test due to covered by 1 Stream 3TX MCS0

2.5 Table for Carrier Frequencies

Nine channels are provided for 802.11a, 802.11n, 802.11ac (20MHz):

Frequency Band	Channel No.	Frequency	Channel No.	Frequency
5150~5250 MHz Band 1	36	5180 MHz	44	5220 MHz
	40	5200 MHz	48	5240 MHz
5725~5850 MHz Band 4	149	5745 MHz	161	5805 MHz
	153	5765 MHz	165	5825 MHz
	157	5785 MHz	-	-

Four channels are provided for 802.11n, 802.11ac (40MHz):

Frequency Band	Channel No.	Frequency	Channel No.	Frequency
5150~5250 MHz Band 1	38	5190 MHz	46	5230 MHz
5725~5850 MHz Band 4	151	5755 MHz	159	5795 MHz

Two channels are provided for 802.11ac (80MHz):

Frequency Band	Channel No.	Frequency
5150~5250 MHz Band 1	42	5210 MHz
5725~ 5850 MHz Band 4	155	5775 MHz

2.6 Table for Test Modes

Investigation has been done on all the possible configurations for searching the worst cases.

The following table is a list of the test modes shown in this test report.

Test Items	Mode	Note	Channel	Data Rate	Antenna
AC Power Line Conducted Emissions	CTX	OFDM/BPSK	-	-	1+2+3
Emission bandwidth 6dB bandwidth for U-NII-3	11a	OFDM/BPSK	36/40/48 149/157/165	6Mbps	1
				6Mbps	1S3T (CDD)
	11ac(20MHz)		36/40/48 149/157/165	Nss1MCS0	1
				Nss1MCS0	1S3T (CDD)
				Nss1MCS0	1S3T (TXBF)
	11ac(40MHz)		38/46 151/159	Nss1MCS0	1
				Nss1MCS0	1S3T (CDD)
				Nss1MCS0	1S3T (TXBF)
	11ac(80MHz)		42 155	Nss1MCS0	1
				Nss1MCS0	1S3T (CDD)
				Nss1MCS0	1S3T (TXBF)
	Maximum Conducted Output Power (Average)		11a	OFDM/BPSK	36/40/48 149/157/165
6Mbps		1S3T (CDD)			
11ac(20MHz)		36/40/48 149/157/165	Nss1MCS0		1
			Nss1MCS0		1S3T (CDD)
			Nss1MCS0		1S3T (TXBF)
11ac(40MHz)		38/46 151/159	Nss1MCS0		1
			Nss1MCS0		1S3T (CDD)
			Nss1MCS0		1S3T (TXBF)
11ac(80MHz)		42 155	Nss1MCS0		1
			Nss1MCS0		1S3T (CDD)
			Nss1MCS0		1S3T (TXBF)
Power Spectral Density		11a	OFDM/BPSK		36/40/48 149/157/165
	6Mbps			1S3T (CDD)	
	11ac(20MHz)	36/40/48 149/157/165		Nss1MCS0	1
				Nss1MCS0	1S3T (CDD)
				Nss1MCS0	1S3T (TXBF)
	11ac(40MHz)	38/46 151/159		Nss1MCS0	1
				Nss1MCS0	1S3T (CDD)
				Nss1MCS0	1S3T (TXBF)
	11ac(80MHz)	42 155		Nss1MCS0	1
				Nss1MCS0	1S3T (CDD)
				Nss1MCS0	1S3T (TXBF)

Unwanted emissions in the restricted bands Above 1GHz (Radiated) & Band Edge Measurement	11a	OFDM/BPSK	36/40/48 149/157/165	6Mbps	1		
	11ac(20MHz)		36/40/48 149/157/165	6Mbps	1S3T (CDD)		
				Nss1MCS0	1		
				Nss1MCS0	1S3T (CDD)		
	11ac(40MHz)		38/46 151/159	Nss1MCS0	1S3T (TXBF)		
				Nss1MCS0	1		
				Nss1MCS0	1S3T (CDD)		
	11ac(80MHz)		42 155	Nss1MCS0	1S3T (TXBF)		
				Nss1MCS0	1		
				Nss1MCS0	1S3T (CDD)		
	Radiated Emissions Below 1GHz (Radiated)		CTX	OFDM/BPSK	-	-	1+2+3
	Frequency Stability		20MHz	Un-modulation	40/157	-	1, 2, 3
40MHz		38/151	-		1, 2, 3		
80MHz		42/155	-		1, 2, 3		

Note 1:11n (20/40MHz) 1TX/2TX/3TX without test due to covered by 802.11ac (20/40MHz) 1TX/2TX/3TX which are same modulation, bandwidth and frequency.

Note 2:11ac (20/40/80MHz): For 1 Stream 2TX, 2 Stream 2TX, 2 Stream 3TX, 3 Stream 3TX without test due to covered by 1 Stream 3TX MCS0

2.7 Duty Cycle

For non-beamforming mode:

Mode	On Time (ms)	On+Off Time (ms)	Duty Cycle (%)	Duty Factor (dB)	1/T Minimum VBW (kHz)
802.11a	2.050	2.090	98.09%	0.08	0.01
802.11ac 20MHz	1.931	1.951	98.97%	0.04	0.01
802.11ac 40MHz	0.911	0.977	93.24%	0.30	1.10
802.11ac 80MHz	0.426	0.489	87.12%	0.60	2.35

For beamforming mode:

Mode	On Time (ms)	On+Off Time (ms)	Duty Cycle (%)	Duty Factor (dB)	1/T Minimum VBW (kHz)
802.11ac 20MHz	3.833	3.942	97.23%	0.12	0.26
802.11ac 40MHz	0.960	1.059	90.65%	0.43	1.04
802.11ac 80MHz	3.378	4.226	79.93%	0.97	0.30

2.8 Table for Testing Locations

Test Site Location					
Address:	No.8, Lane 724, Bo-ai St., Jhubei City, Hsinchu County 302, Taiwan, R.O.C.				
TEL:	886-3-656-9065				
FAX:	886-3-656-9085				
Test Site No.	Site Category	Location	FCC Reg. No.	IC File No.	VCCI Reg. No
03CH01-CB	SAC	Hsin Chu	262045	IC 4086D	-
CO01-CB	Conduction	Hsin Chu	262045	IC 4086D	-
TH01-CB	OVEN Room	Hsin Chu	-	-	-

Open Area Test Site (OATS); Semi Anechoic Chamber (SAC).

2.9 Table for Supporting Units

For Test Site No: CO01-CB

Support Unit	Brand	Model	FCC ID
Notebook	DELL	E6430	DoC

For Test Site No: 03CH01-CB

For Non-Beamforming

Support Unit	Brand	Model	FCC ID
Notebook	DELL	M1330	DoC

For Beamforming

Support Unit	Brand	Model	FCC ID
Notebook	DELL	M1330	DoC
Notebook	DELL	M1340	DoC
WLAN ac Dongle	Netgear	A6200	PY31220200

For Test Site No: TH01-CB

Support Unit	Brand	Model	FCC ID
Notebook	DELL	E6220	DoC

2.10 Table for Parameters of Test Software Setting

During testing, Channel & Power Controlling Software provided by the customer was used to control the operating channel as well as the output power level. The RF output power selection is for the setting of RF output power expected by the customer and is going to be fixed on the firmware of the final end product.

The Power Setting Parameter					
Test Software Version	02.87.15.05.00				
Worst Modulation Mode	Number of Transmit Chains (NTX)	Frequency (MHz)	Maximum Output Power (dBm)	Power Setting	Data Rate / MCS
802.11a Ant. 1	1 Stream 1TX	5180	17.39	70	6Mbps
802.11a Ant. 1	1 Stream 1TX	5200	17.64	71	6Mbps
802.11a Ant. 1	1 Stream 1TX	5240	20.09	81	6Mbps
802.11a Ant. 1	1 Stream 1TX	5745	18.04	71	6Mbps
802.11a Ant. 1	1 Stream 1TX	5785	16.48	65	6Mbps
802.11a Ant. 1	1 Stream 1TX	5825	15.33	61	6Mbps
802.11a (CDD)	1 stream 3TX	5180	16.37	48	6Mbps
802.11a (CDD)	1 stream 3TX	5200	16.51	49	6Mbps
802.11a (CDD)	1 stream 3TX	5240	21.22	67	6Mbps
802.11a (CDD)	1 stream 3TX	5745	19.64	61	6Mbps
802.11a (CDD)	1 stream 3TX	5785	17.46	52	6Mbps
802.11a (CDD)	1 stream 3TX	5825	16.65	48	6Mbps
802.11ac 20MHz Ant. 1	1 Stream 1TX	5180	17.16	69	Nss1MCS0 (6.5)
802.11ac 20MHz Ant. 1	1 Stream 1TX	5200	16.85	68	Nss1MCS0 (6.5)
802.11ac 20MHz Ant. 1	1 Stream 1TX	5240	20.05	81	Nss1MCS0 (6.5)
802.11ac 20MHz Ant. 1	1 Stream 1TX	5745	17.23	68	Nss1MCS0 (6.5)
802.11ac 20MHz Ant. 1	1 Stream 1TX	5785	15.64	63	Nss1MCS0 (6.5)
802.11ac 20MHz Ant. 1	1 Stream 1TX	5825	15.35	61	Nss1MCS0 (6.5)
802.11ac 20MHz (CDD)	1 stream 3TX	5180	17.65	53	Nss1MCS0 (6.5)
802.11ac 20MHz (CDD)	1 stream 3TX	5200	17.42	52	Nss1MCS0 (6.5)
802.11ac 20MHz (CDD)	1 stream 3TX	5240	23.24	75	Nss1MCS0 (6.5)
802.11ac 20MHz (CDD)	1 stream 3TX	5745	20.58	65	Nss1MCS0 (6.5)
802.11ac 20MHz (CDD)	1 stream 3TX	5785	18.73	58	Nss1MCS0 (6.5)
802.11ac 20MHz (CDD)	1 stream 3TX	5825	18.77	58	Nss1MCS0 (6.5)
802.11ac 20MHz (TXBF)	1 stream 3TX	5180	18.80	58	Nss1MCS0 (6.5)
802.11ac 20MHz (TXBF)	1 stream 3TX	5200	16.09	47	Nss1MCS0 (6.5)
802.11ac 20MHz (TXBF)	1 stream 3TX	5240	21.64	70	Nss1MCS0 (6.5)
802.11ac 20MHz (TXBF)	1 stream 3TX	5745	19.64	61	Nss1MCS0 (6.5)
802.11ac 20MHz (TXBF)	1 stream 3TX	5785	17.96	55	Nss1MCS0 (6.5)
802.11ac 20MHz (TXBF)	1 stream 3TX	5825	17.54	53	Nss1MCS0 (6.5)

802.11ac 40MHz Ant. 1	1 Stream 1TX	5190	17.49	73	Nss1MCS0 (13.5)
802.11ac 40MHz Ant. 1	1 Stream 1TX	5230	18.82	79	Nss1MCS0 (13.5)
802.11ac 40MHz Ant. 1	1 Stream 1TX	5755	15.92	67	Nss1MCS0 (13.5)
802.11ac 40MHz Ant. 1	1 Stream 1TX	5795	16.99	71	Nss1MCS0 (13.5)
802.11ac 40MHz (CDD)	1 Stream 3TX	5190	20.72	68	Nss1MCS0 (13.5)
802.11ac 40MHz (CDD)	1 Stream 3TX	5230	19.62	64	Nss1MCS0 (13.5)
802.11ac 40MHz (CDD)	1 Stream 3TX	5755	19.99	65	Nss1MCS0 (13.5)
802.11ac 40MHz (CDD)	1 Stream 3TX	5795	21.20	70	Nss1MCS0 (13.5)
802.11ac 40MHz (TXBF)	1 Stream 3TX	5190	19.43	63	Nss1MCS0 (13.5)
802.11ac 40MHz (TXBF)	1 Stream 3TX	5230	17.99	57	Nss1MCS0 (13.5)
802.11ac 40MHz (TXBF)	1 Stream 3TX	5755	19.27	62	Nss1MCS0 (13.5)
802.11ac 40MHz (TXBF)	1 Stream 3TX	5795	18.71	60	Nss1MCS0 (13.5)
802.11ac 80MHz Ant. 1	1 Stream 1TX	5210	14.41	63	Nss1MCS0 (29.3)
802.11ac 80MHz Ant. 1	1 Stream 1TX	5775	14.11	62	Nss1MCS0 (29.3)
802.11ac 80MHz (CDD)	1 Stream 3TX	5210	18.07	57	Nss1MCS0 (29.3)
802.11ac 80MHz (CDD)	1 Stream 3TX	5775	18.06	59	Nss1MCS0 (29.3)
802.11ac 80MHz (TXBF)	1 Stream 3TX	5210	18.48	58	Nss1MCS0 (29.3)
802.11ac 80MHz (TXBF)	1 Stream 3TX	5775	17.65	57	Nss1MCS0 (29.3)

2.11 Test Configuration

2.11.1 AC Power Line Conduction Emissions Test Configuration

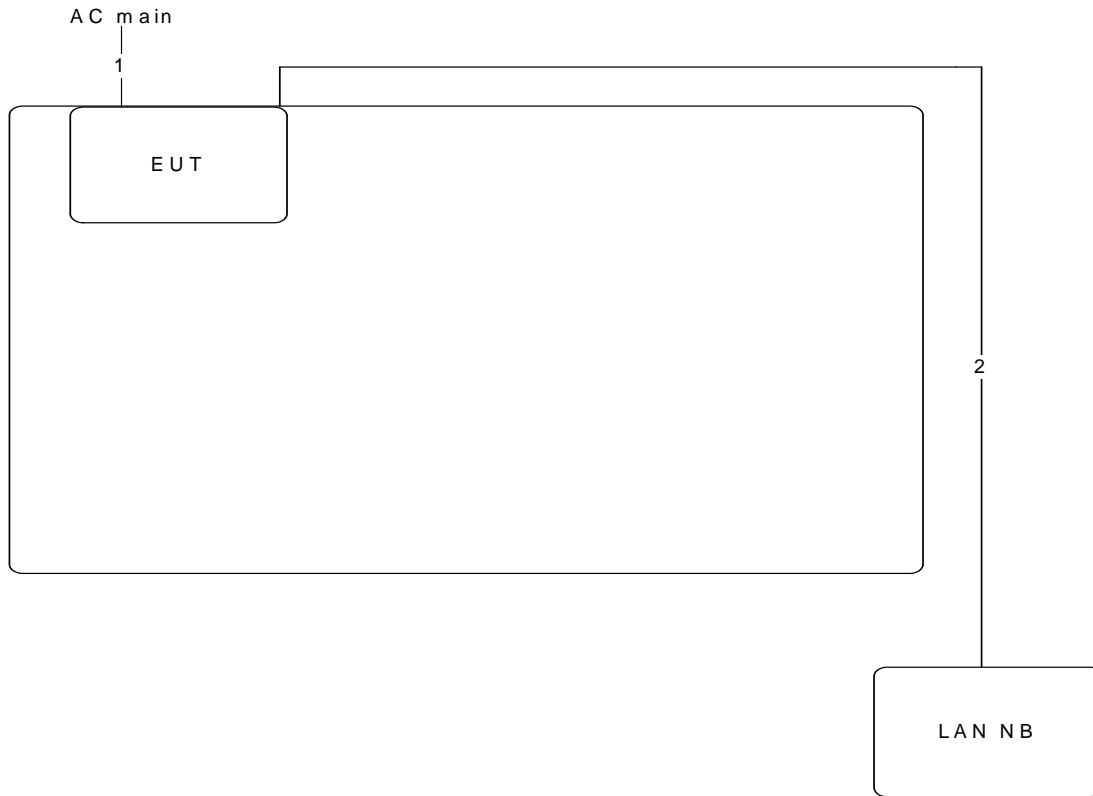

Item	Connection	Shielded	Length
1	Power cable	No	1.8m
2	RJ-45 cable	No	10m

2.11.2 Radiation Emissions Test Configuration

For Non-Beamforming

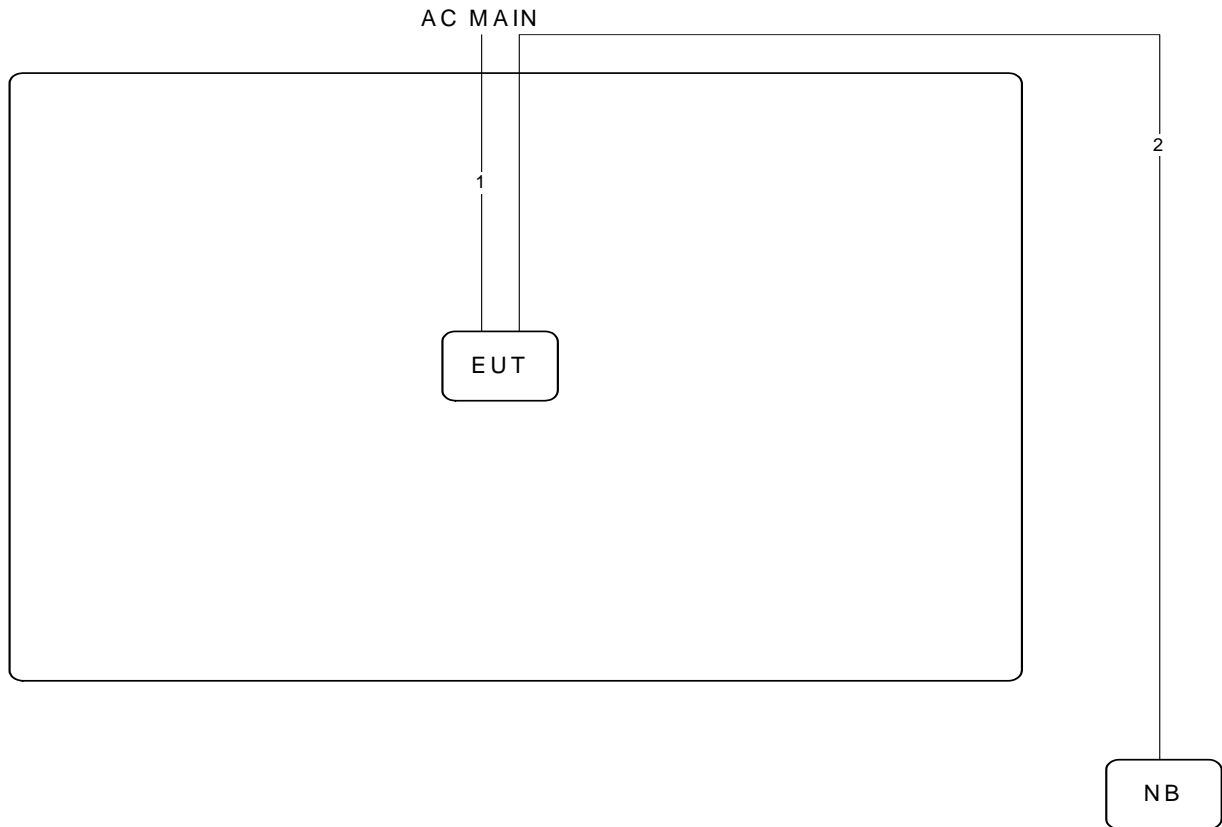

Item	Connection	Shielded	Length(m)
1	Power cable	No	1.8m
2	RJ-45 cable	No	10m

For Beamforming

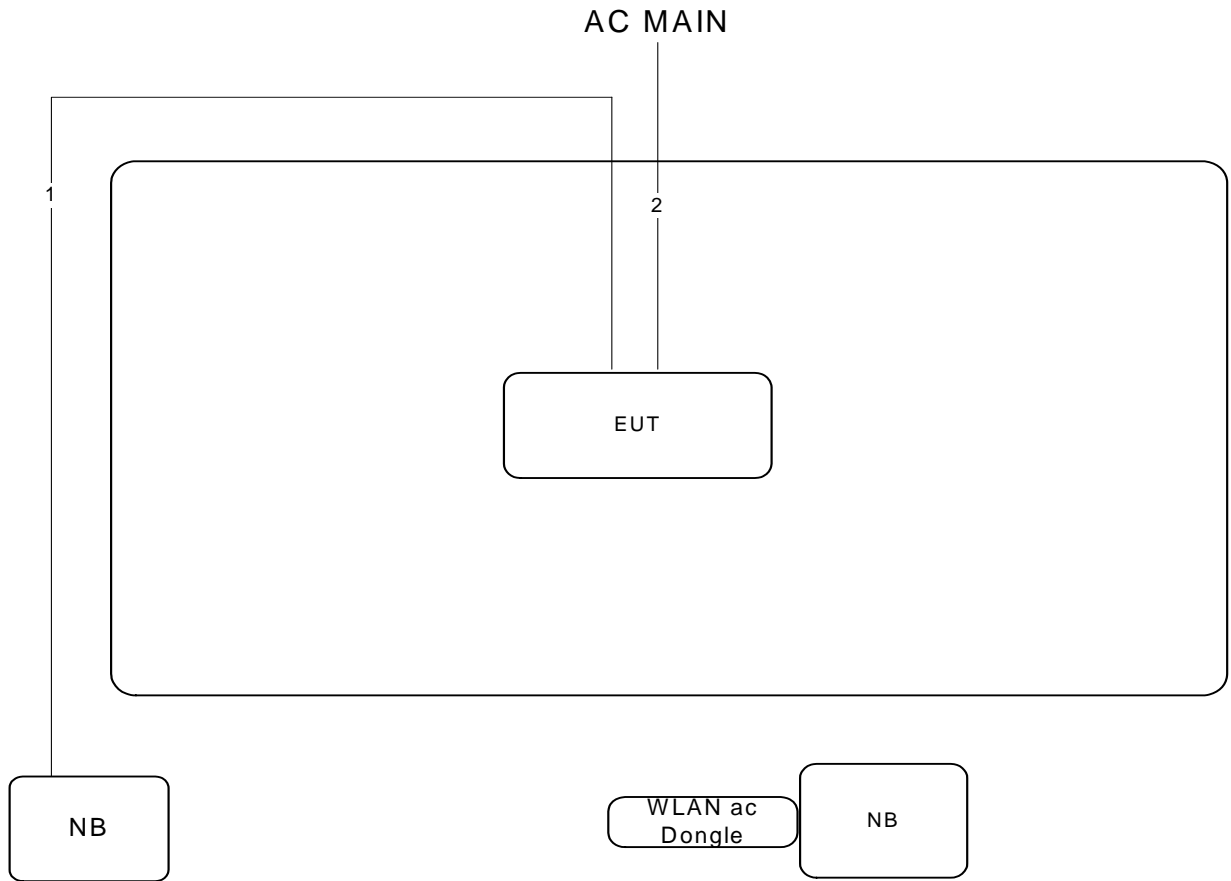

Item	Connection	Shielded	Length
1	RJ-45 cable	No	10m
2	Power cable	No	1.8m

3 TEST RESULT

3.1 AC Power Line Conducted Emissions Measurement

3.1.1 Limit

For this product which is designed to be connected to the AC power line, the radio frequency voltage that is conducted back onto the AC power line on any frequency or frequencies within the band 150 kHz to 30 MHz shall not exceed below limits table.

Frequency (MHz)	QP Limit (dBuV)	AV Limit (dBuV)
0.15~0.5	66~56	56~46
0.5~5	56	46
5~30	60	50

3.1.2 Measuring Instruments and Setting

Please refer to section 4 of equipments list in this report. The following table is the setting of the receiver.

Receiver Parameters	Setting
Attenuation	10 dB
Start Frequency	0.15 MHz
Stop Frequency	30 MHz
IF Bandwidth	9 kHz

3.1.3 Test Procedures

1. Configure the EUT according to ANSI C63.10. The EUT or host of EUT has to be placed 0.4 meter far from the conducting wall of the shielding room and at least 80 centimeters from any other grounded conducting surface.
2. Connect EUT or host of EUT to the power mains through a line impedance stabilization network (LISN).
3. All the support units are connected to the other LISNs. The LISN should provide 50uH/50ohms coupling impedance
4. The frequency range from 150 kHz to 30 MHz was searched.
5. Set the test-receiver system to Peak Detect Function and Specified Bandwidth with Maximum Hold Mode.
6. The measurement has to be done between each power line and ground at the power terminal.

3.1.4 Test Setup Layout

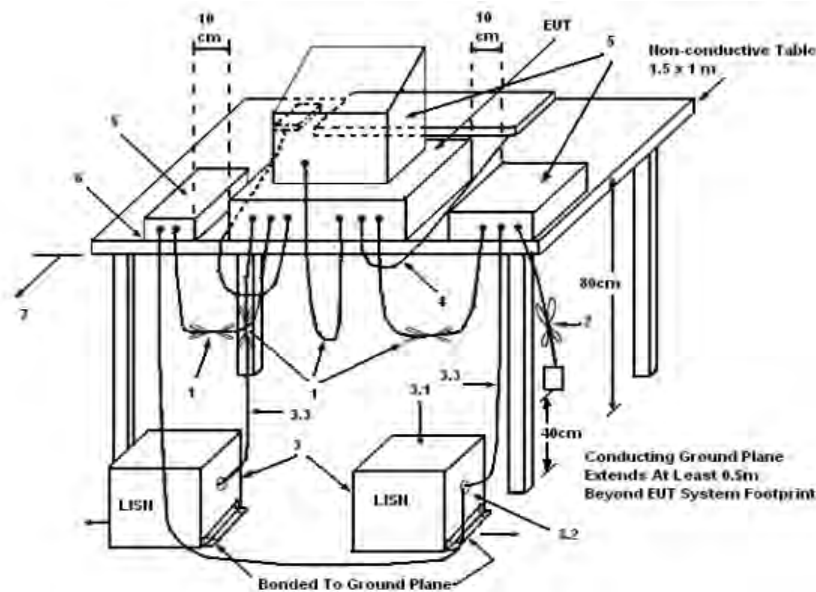

LEGEND:

1. Interconnecting cables that hang closer than 40 cm to the ground plane shall be folded back and forth in the center forming a bundle 30 to 40 cm long.
2. I/O cables that are not connected to a peripheral shall be bundled in the center. The end of the cable may be terminated, if required, using the correct terminating impedance. The overall length shall not exceed 1 m.
3. EUT connected to one LISN. Unused LISN measuring port connectors shall be terminated in 50 Ω. LISN can be placed on top of, or immediately beneath, reference ground plane.
4. All other equipment powered from additional LISN(s).
5. Multiple outlet strip can be used for multiple power cords of non-EUT equipment.
6. LISN at least 80 cm from nearest part of EUT chassis.
7. Cables of hand-operated devices, such as keyboards, mice, etc., shall be placed as for normal use.
8. Non-EUT components of EUT system being tested.
9. Rear of EUT, including peripherals, shall all be aligned and flush with rear of tabletop.
10. Rear of tabletop shall be 40 cm removed from a vertical conducting plane that is bonded to the ground plane.

3.1.5 Test Deviation

There is no deviation with the original standard.

3.1.6 EUT Operation during Test

The EUT was placed on the test table and programmed in normal function.

3.1.7 Results of AC Power Line Conducted Emissions Measurement

Temperature	22°C	Humidity	68%
Test Engineer	Da Deng	Phase	Line
Configuration	CTX		

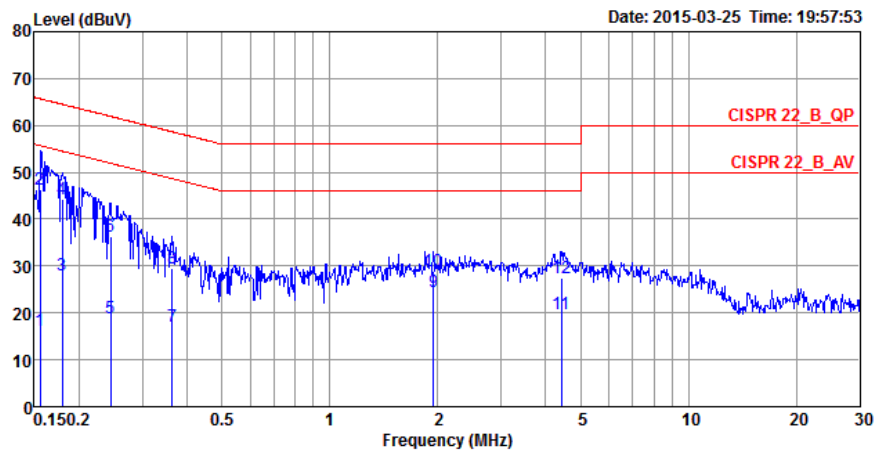

	Freq	Level	Over Limit	Limit Line	Read Level	LISN Factor	Cable Loss	Pol/Phase	Remark
	MHz	dBuV	dB	dBuV	dBuV	dB	dB		
1	0.16	16.17	-39.52	55.69	6.22	9.93	0.02	LINE	Average
2	0.16	46.36	-19.33	65.69	36.41	9.93	0.02	LINE	QP
3	0.18	28.08	-26.42	54.50	18.13	9.93	0.02	LINE	Average
4	0.18	44.23	-20.27	64.50	34.28	9.93	0.02	LINE	QP
5	0.24	18.77	-33.18	51.95	8.81	9.93	0.03	LINE	Average
6	0.24	36.39	-25.56	61.95	26.43	9.93	0.03	LINE	QP
7	0.36	16.99	-31.66	48.65	7.02	9.93	0.04	LINE	Average
8	0.36	29.65	-29.00	58.65	19.68	9.93	0.04	LINE	QP
9	1.95	24.38	-21.62	46.00	14.33	9.99	0.06	LINE	Average
10	1.95	28.90	-27.10	56.00	18.85	9.99	0.06	LINE	QP
11	4.43	19.87	-26.13	46.00	9.75	10.04	0.08	LINE	Average
12	4.43	27.59	-28.41	56.00	17.47	10.04	0.08	LINE	QP

Note 1: The test was passed at the minimum margin that marked by the frame in the following data
 Note 2: The emission levels of other frequencies were very low against the limit.
 Note 3: Q.P. and AV. are abbreviations of quasi-peak and average individually.
 Note 4: Corrected Reading (dBuV) = LISN Factor + Cable Loss + Read Level = Level
 Note 5: Over Limit value = level - Limit value

Temperature	22°C	Humidity	68%
Test Engineer	Da Deng	Phase	Neutral
Configuration	CTX	Test Mode	Mode 1

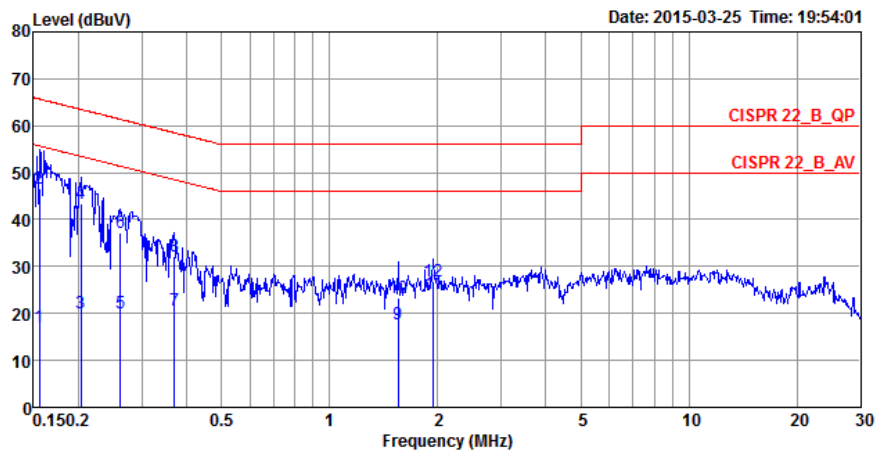

	Freq	Level	Over Limit	Limit Line	Read Level	LISN Factor	Cable Loss	Pol/Phase	Remark
	Hz	dBuV	dB	dBuV	dBuV	dB	dB		
1	0.16	17.19	-38.50	55.69	7.39	9.78	0.02	NEUTRAL	Average
2	0.16	46.67	-19.02	65.69	36.87	9.78	0.02	NEUTRAL	QP
3	0.20	20.06	-33.43	53.49	10.25	9.79	0.02	NEUTRAL	Average
4	0.20	43.28	-20.21	63.49	33.47	9.79	0.02	NEUTRAL	QP
5	0.26	19.98	-31.40	51.38	10.16	9.79	0.03	NEUTRAL	Average
6	0.26	37.12	-24.26	61.38	27.30	9.79	0.03	NEUTRAL	QP
7	0.37	20.65	-27.87	48.52	10.82	9.79	0.04	NEUTRAL	Average
8	0.37	32.16	-26.36	58.52	22.33	9.79	0.04	NEUTRAL	QP
9	1.55	17.83	-28.17	46.00	7.94	9.83	0.06	NEUTRAL	Average
10	1.55	23.22	-32.78	56.00	13.33	9.83	0.06	NEUTRAL	QP
11	1.95	24.23	-21.77	46.00	14.33	9.84	0.06	NEUTRAL	Average
12	1.95	26.96	-29.04	56.00	17.06	9.84	0.06	NEUTRAL	QP

Note 1: The test was passed at the minimum margin that marked by the frame in the following data
 Note 2: The emission levels of other frequencies were very low against the limit.
 Note 3: Q.P. and AV. are abbreviations of quasi-peak and average individually.
 Note 4: Corrected Reading (dBμV) = LISN Factor + Cable Loss + Read Level = Level
 Note 5: Over Limit value = level - Limit value

3.2 Emission bandwidth Measurement

3.2.1 Limit

No restriction limits

3.2.2 26dB Bandwidth Measuring Instruments and Setting

Please refer to section 4 of equipments list in this report. The following table is the setting of the spectrum analyzer.

Power Meter Parameter	Setting
Attenuation	Auto
Span Frequency	> 26dB Bandwidth
RBW	Approximately 1% of the emission bandwidth.
VBW	> RBW.
Detector	peak
Trace	max hold
Sweep Time	Auto

3.2.3 Test Procedures

1. The transmitter output (antenna port) was connected to the spectrum analyzer.
2. Test was performed in accordance with Measurement of Digital Transmission Systems Operating under 789033 D02 General UNII Test Procedures New Rules v01, in section “Emission bandwidth (C)(1)” , 06/06/2014
3. When measuring Emission bandwidth with multiple antenna systems, add every result of the values by mathematic formula.

3.2.4 Test Setup Layout

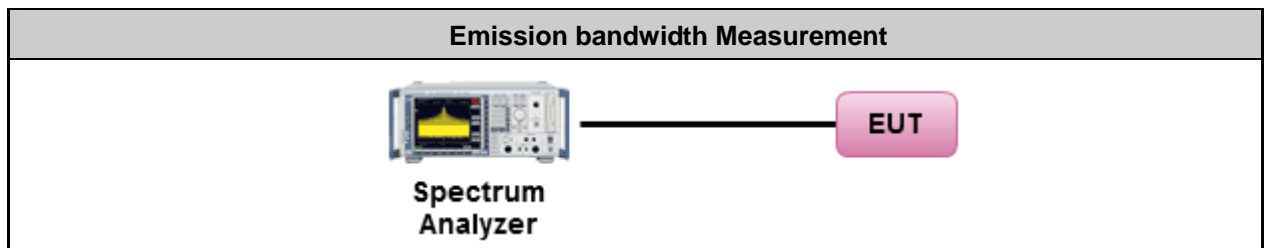

3.2.5 Test Deviation

There is no deviation with the original standard.

3.2.6 EUT Operation during Test

The EUT was programmed to be in continuously transmitting mode.

3.2.7 Test Result for Emission bandwidth

Test date	Mar. 17, 2015~Mar. 25, 2015	Test Site No.	TH01-CB
Temperature	20°C	Humidity	60%
Test Engineer	Mars Lin	Configuration	802.11a
Duty Cycle	<6Mbps, Ant. 1 >: 98.09% <6Mbps, 1S3T, CDD>: 98.09%		

Configuration IEEE 802.11a

<6Mbps, Ant. 1 >

Channel	Frequency	26dB Bandwidth (MHz)	99% Occupied Bandwidth (MHz)	Data Rate / MCS
36	5180 MHz	20.61	17.02	6Mbps
40	5200 MHz	20.35	16.93	6Mbps
48	5240 MHz	33.04	17.71	6Mbps
149	5745 MHz	21.83	17.19	6Mbps
157	5785 MHz	20.43	17.02	6Mbps
165	5825 MHz	20.43	17.02	6Mbps

<6Mbps, 1S3T, CDD>

Channel	Frequency	26dB Bandwidth (MHz)			99% Occupied Bandwidth (MHz)			Data Rate / MCS
		Ant. 1	Ant. 2	Ant. 3	Ant. 1	Ant. 2	Ant. 3	
36	5180 MHz	19.83	20.26	20.43	16.76	16.85	16.93	6Mbps
40	5200 MHz	20.26	20.09	20.35	16.85	16.85	16.93	6Mbps
48	5240 MHz	25.83	31.22	24.00	17.28	17.28	17.02	6Mbps
149	5745 MHz	20.26	20.43	20.26	17.01	16.93	16.85	6Mbps
157	5785 MHz	20.52	20.26	20.35	17.02	16.85	16.85	6Mbps
165	5825 MHz	20.43	20.35	20.35	16.93	16.93	16.85	6Mbps

<6Mbps, Ant. 1 >:

26dB Bandwidth Plot on Configuration IEEE 802.11a / CH 36 / Ant. 1

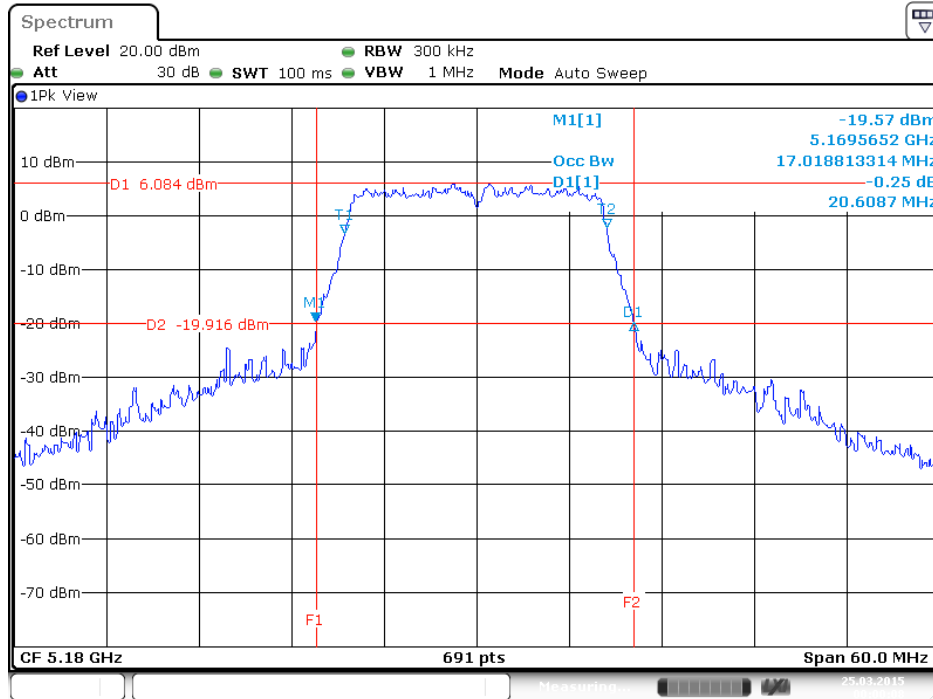

26dB Bandwidth Plot on Configuration IEEE 802.11a / CH 40 / Ant. 1

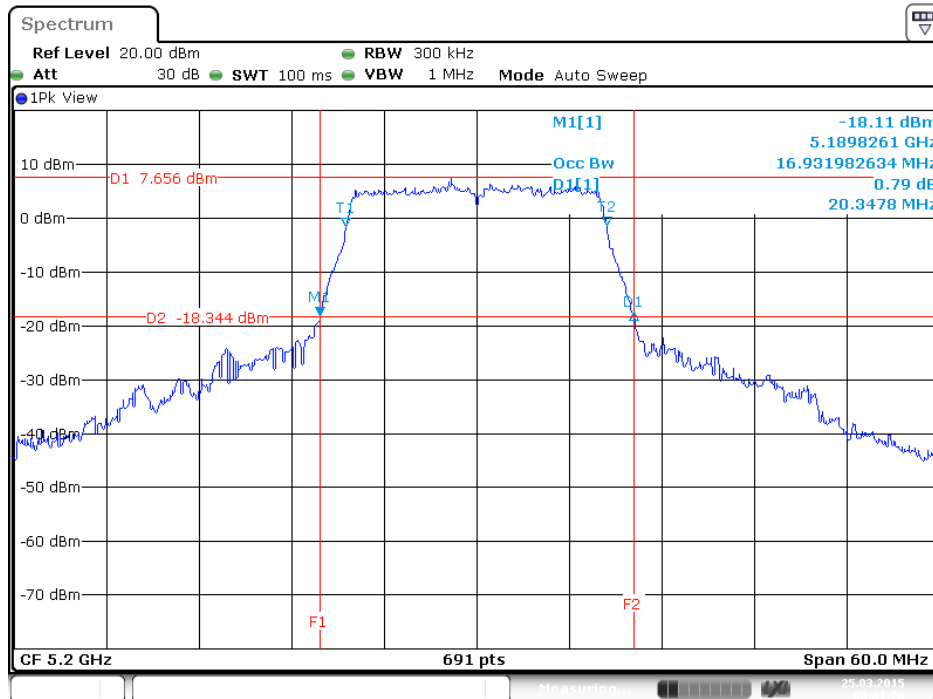

26dB Bandwidth Plot on Configuration IEEE 802.11a / CH 48 / Ant. 1

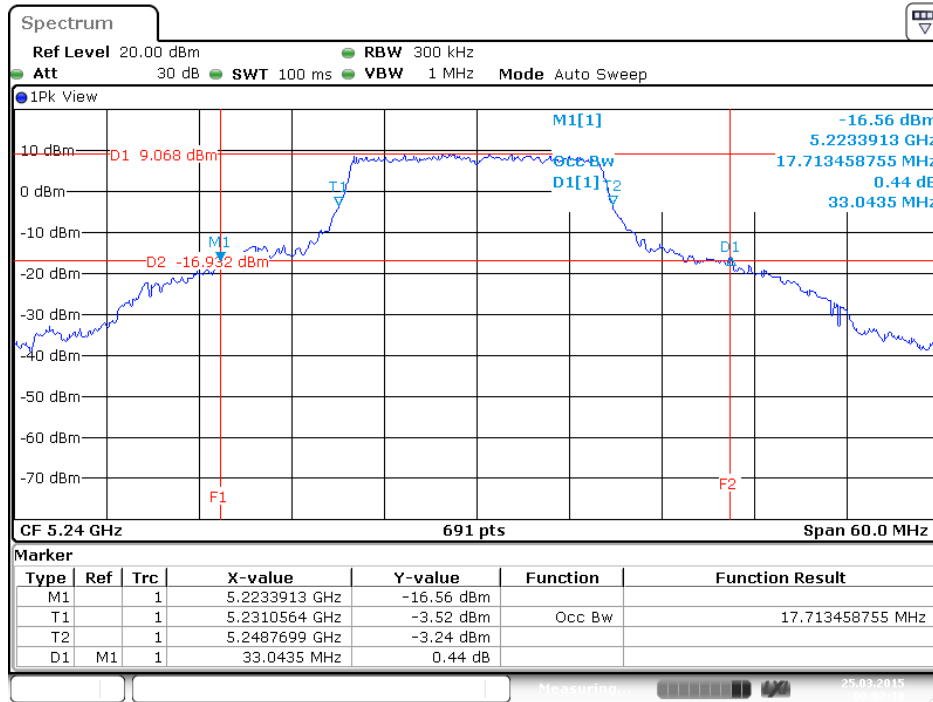

Date: 25 MAR 2015 00:02:19

26dB Bandwidth Plot on Configuration IEEE 802.11a / CH 149 / Ant. 1

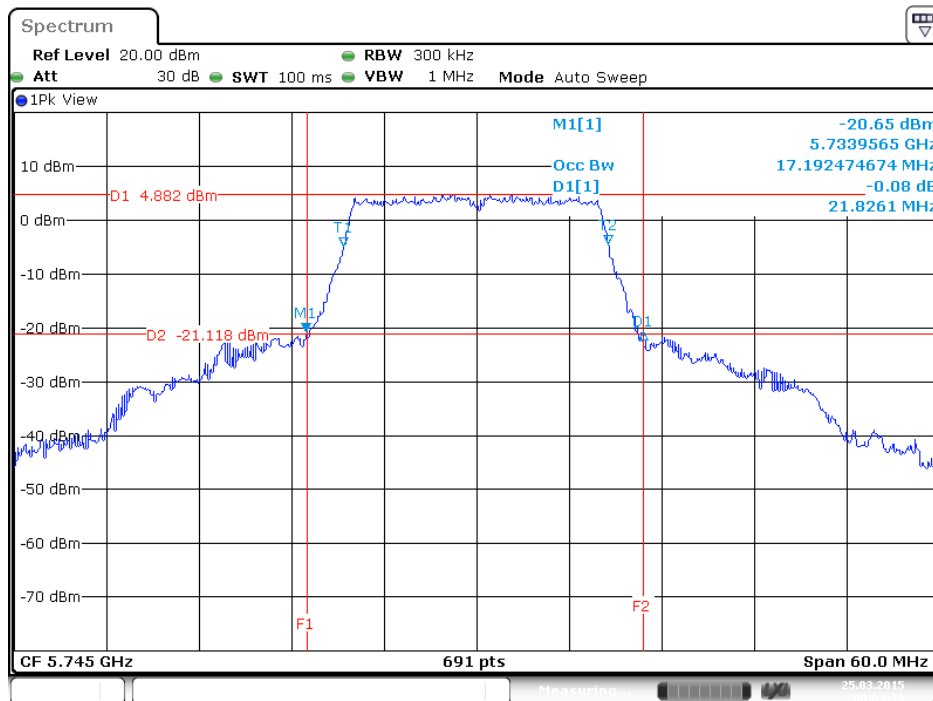

Date: 25 MAR 2015 00:03:37

26dB Bandwidth Plot on Configuration IEEE 802.11a / CH 157 / Ant. 1

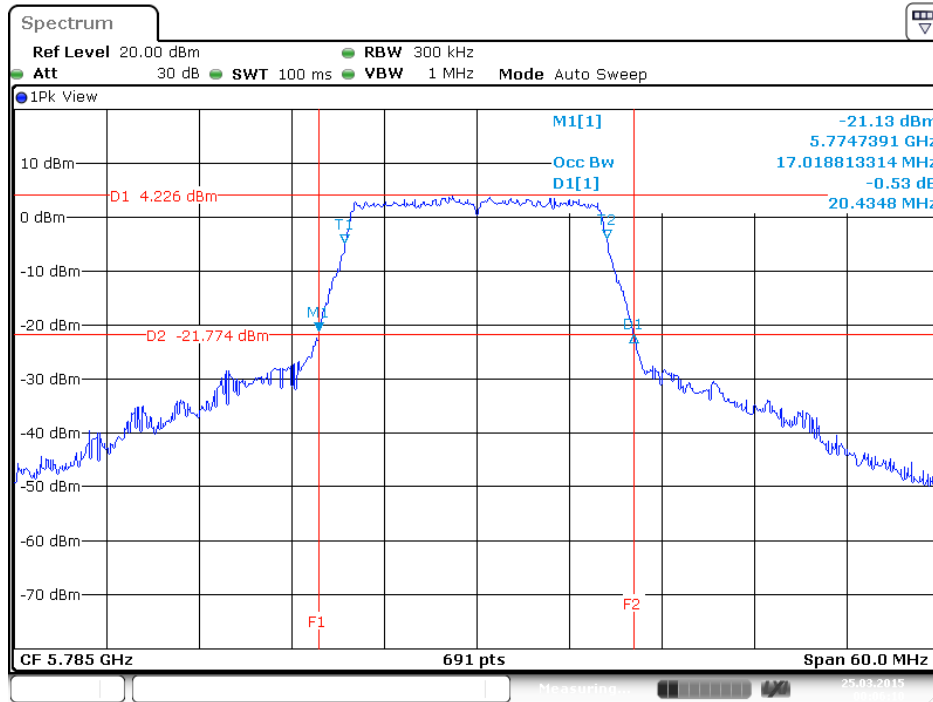

26dB Bandwidth Plot on Configuration IEEE 802.11a / CH 165 / Ant. 1

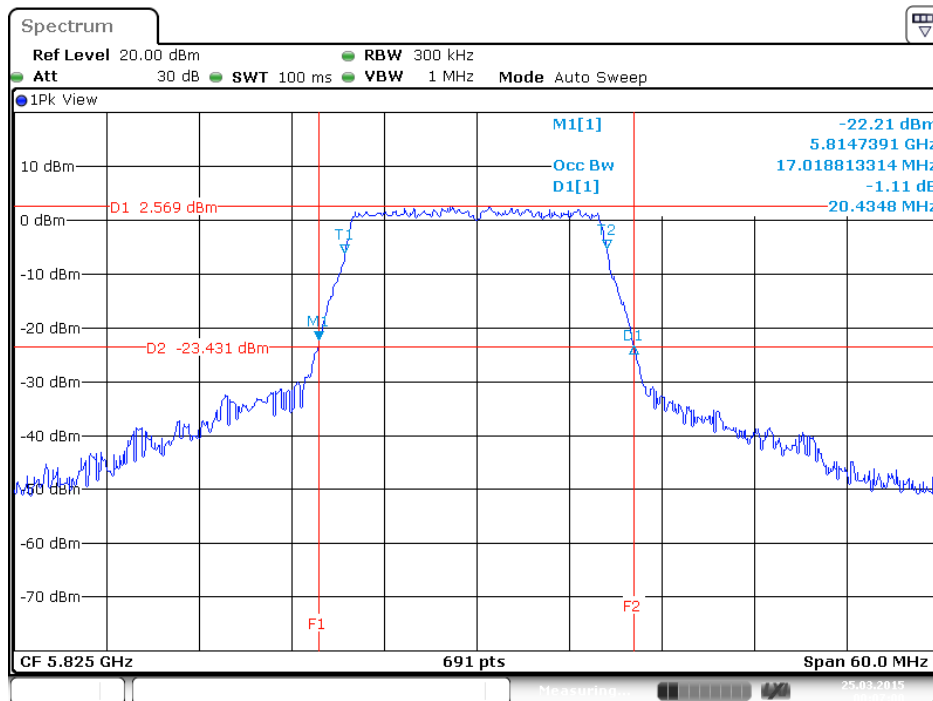

<6Mbps, 1S3T, CDD>:

26dB Bandwidth Plot on Configuration IEEE 802.11a / CH 36 / 6Mbps / 1S3T CDD / Ant. 1

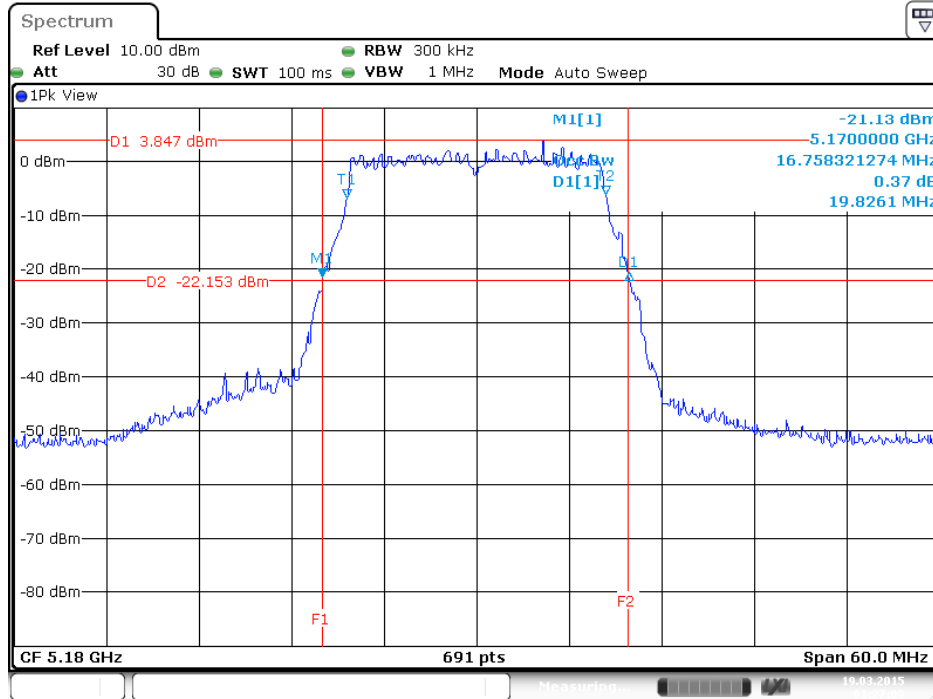

26dB Bandwidth Plot on Configuration IEEE 802.11a / CH 36 / 6Mbps / 1S3T CDD / Ant. 2

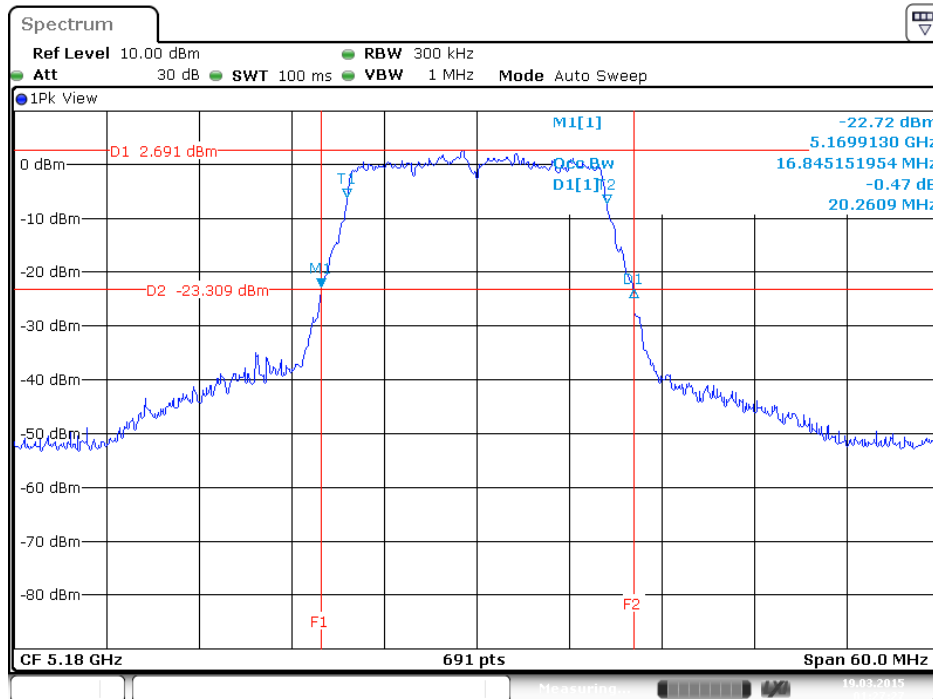

26dB Bandwidth Plot on Configuration IEEE 802.11a / CH 36 / 6Mbps / 1S3T CDD / Ant. 3

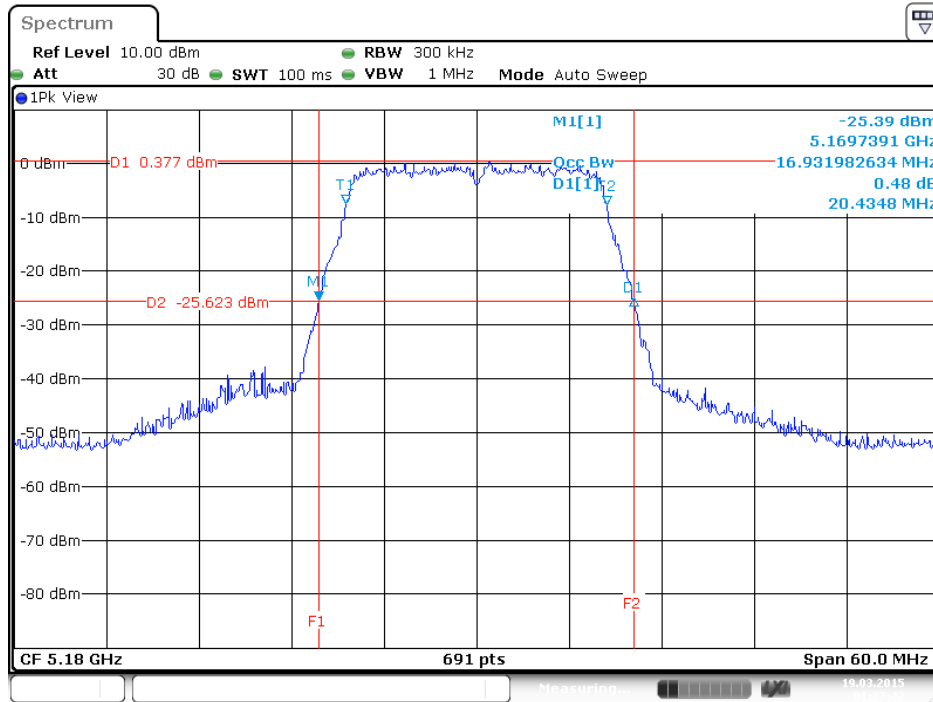

26dB Bandwidth Plot on Configuration IEEE 802.11a / CH 40 / 6Mbps / 1S3T CDD / Ant. 1

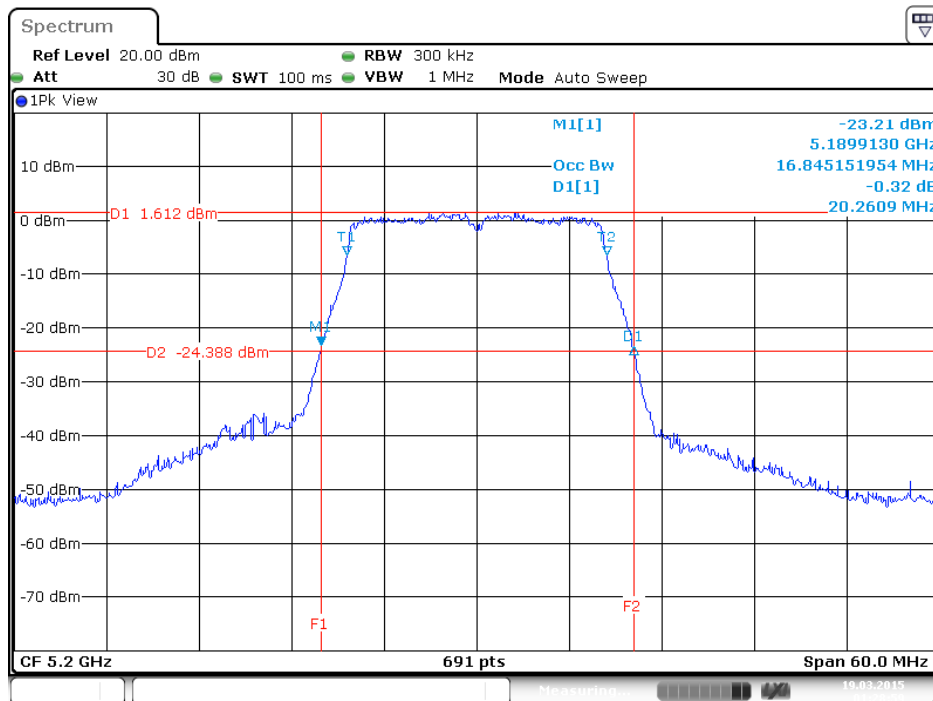

26dB Bandwidth Plot on Configuration IEEE 802.11a / CH 40 / 6Mbps / 1S3T CDD / Ant. 2

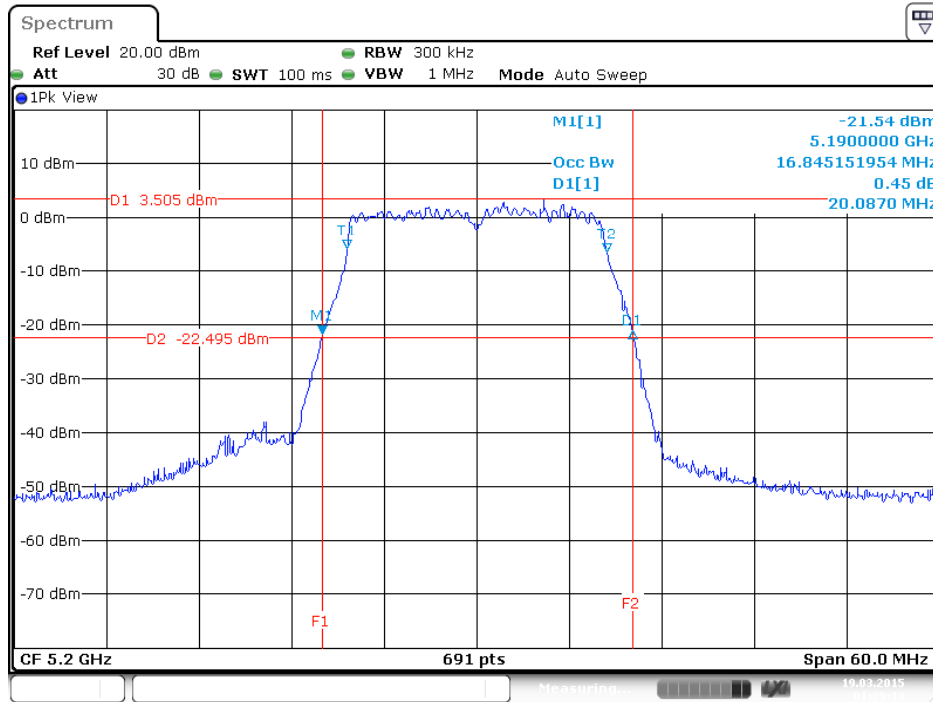

26dB Bandwidth Plot on Configuration IEEE 802.11a / CH 40 / 6Mbps / 1S3T CDD / Ant. 3

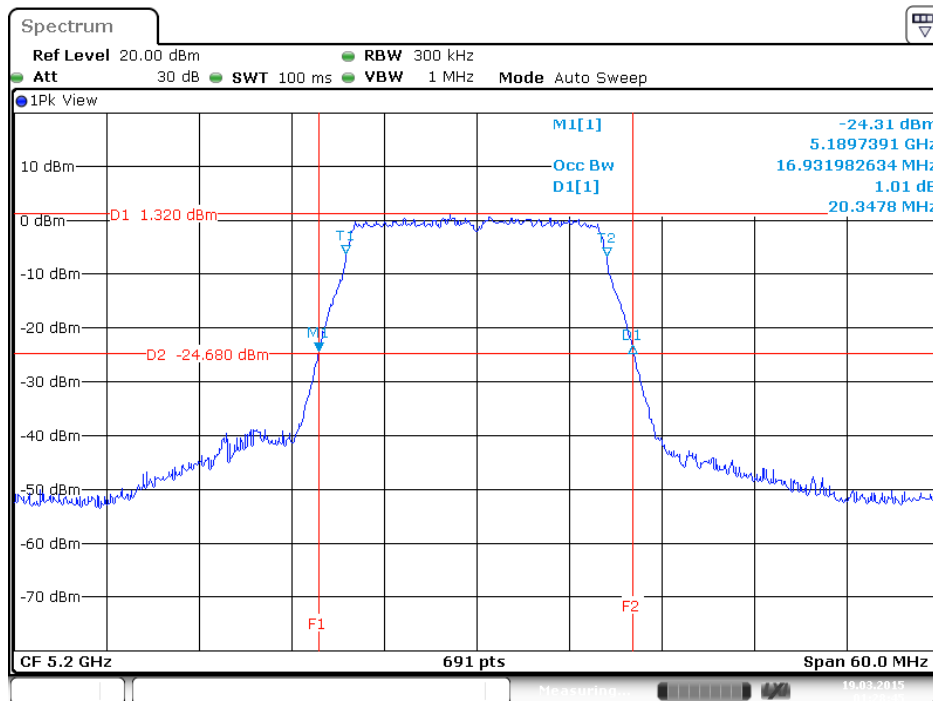

26dB Bandwidth Plot on Configuration IEEE 802.11a / CH 48 / 6Mbps / 1S3T CDD / Ant. 1

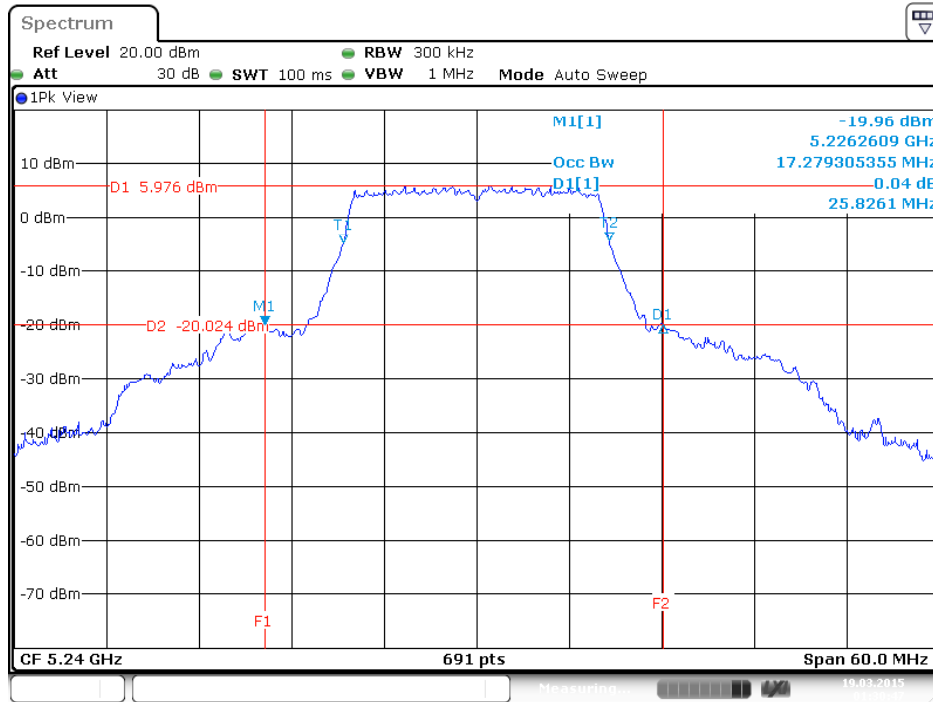

26dB Bandwidth Plot on Configuration IEEE 802.11a / CH 48 / 6Mbps / 1S3T CDD / Ant. 2

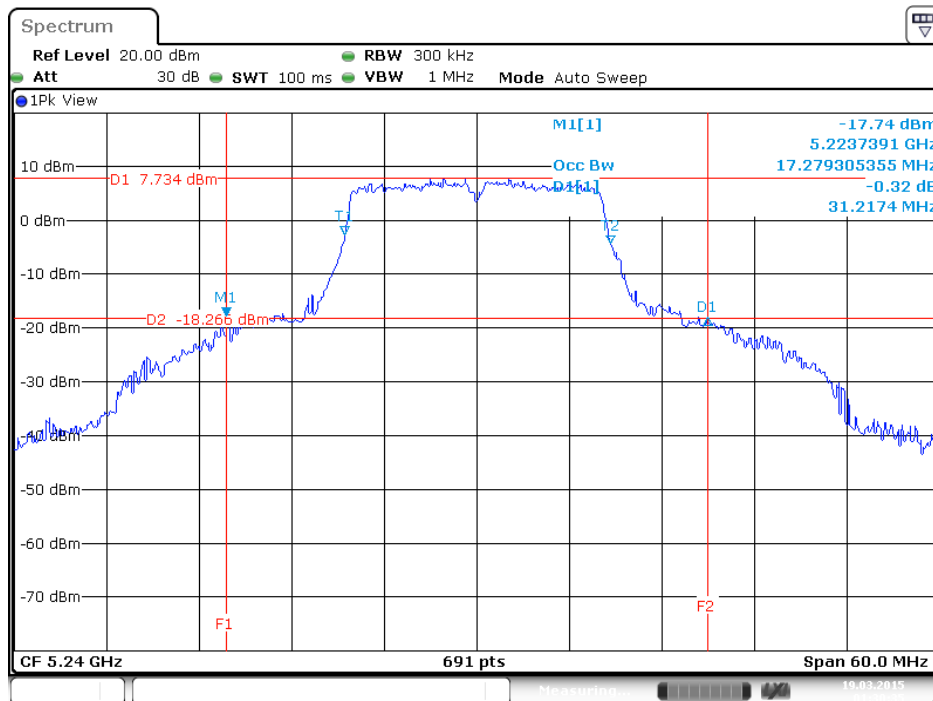

26dB Bandwidth Plot on Configuration IEEE 802.11a / CH 48 / 6Mbps / 1S3T CDD / Ant. 3

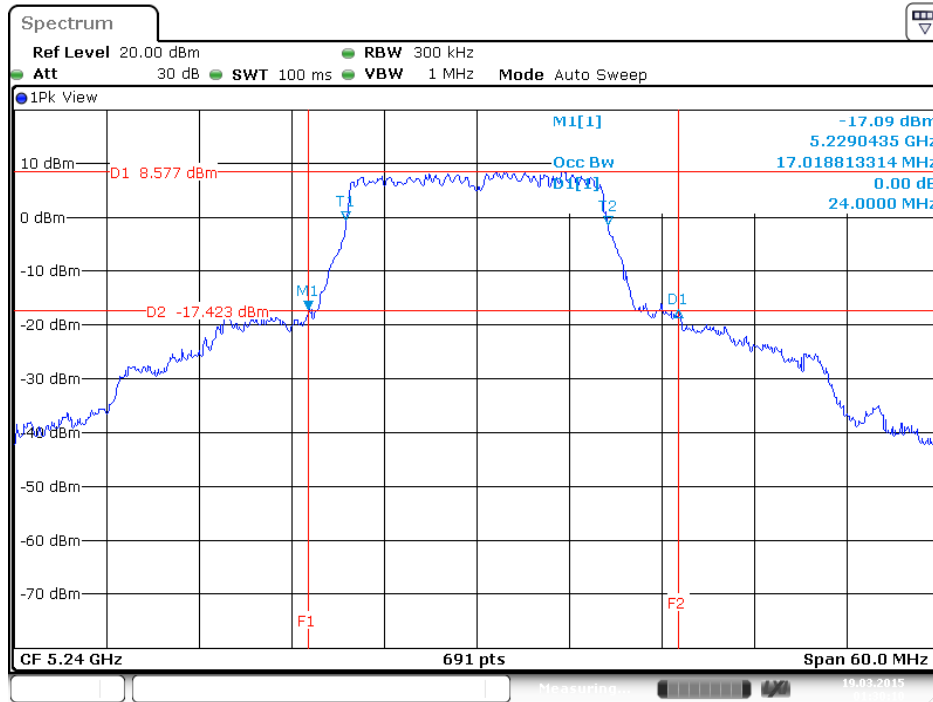

26dB Bandwidth Plot on Configuration IEEE 802.11a / CH 149 / 6Mbps / 1S3T CDD / Ant. 1

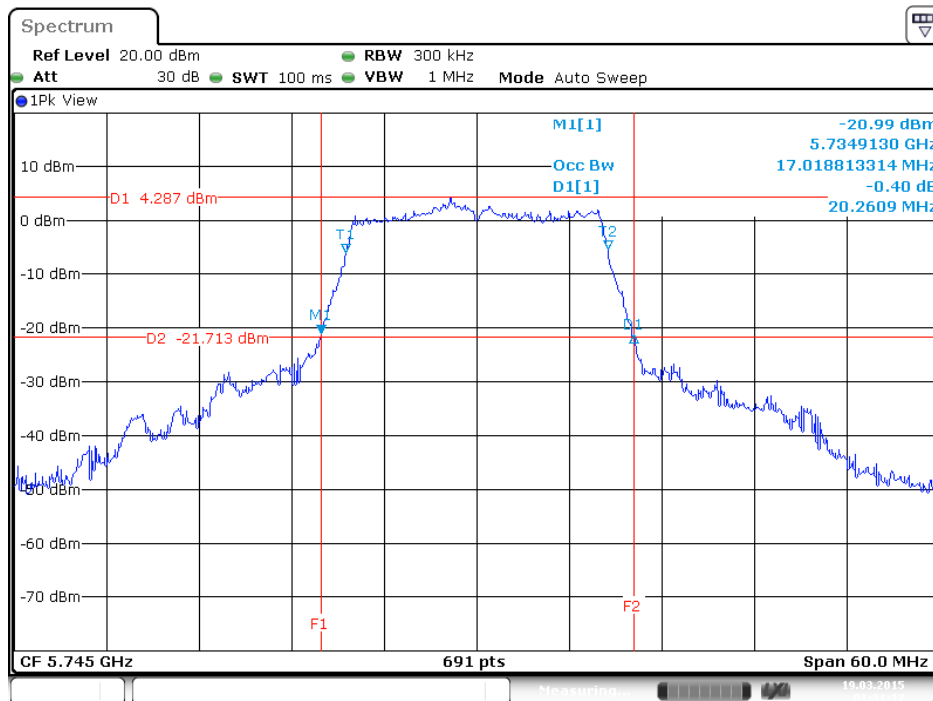

26dB Bandwidth Plot on Configuration IEEE 802.11a / CH 149 / 6Mbps / 1S3T CDD / Ant. 2

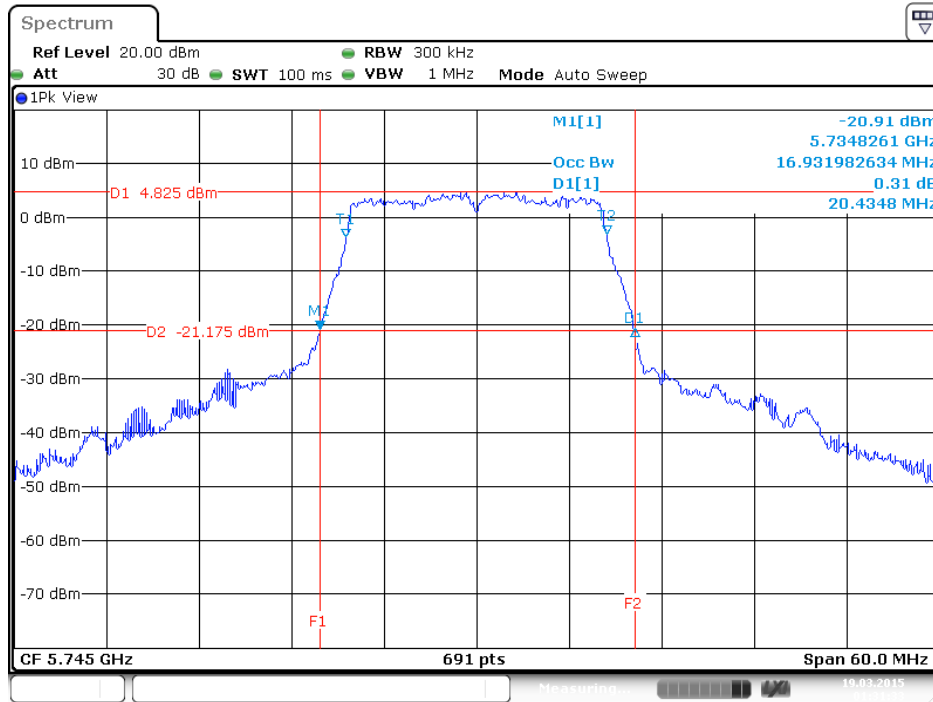

26dB Bandwidth Plot on Configuration IEEE 802.11a / CH 149 / 6Mbps / 1S3T CDD / Ant. 3

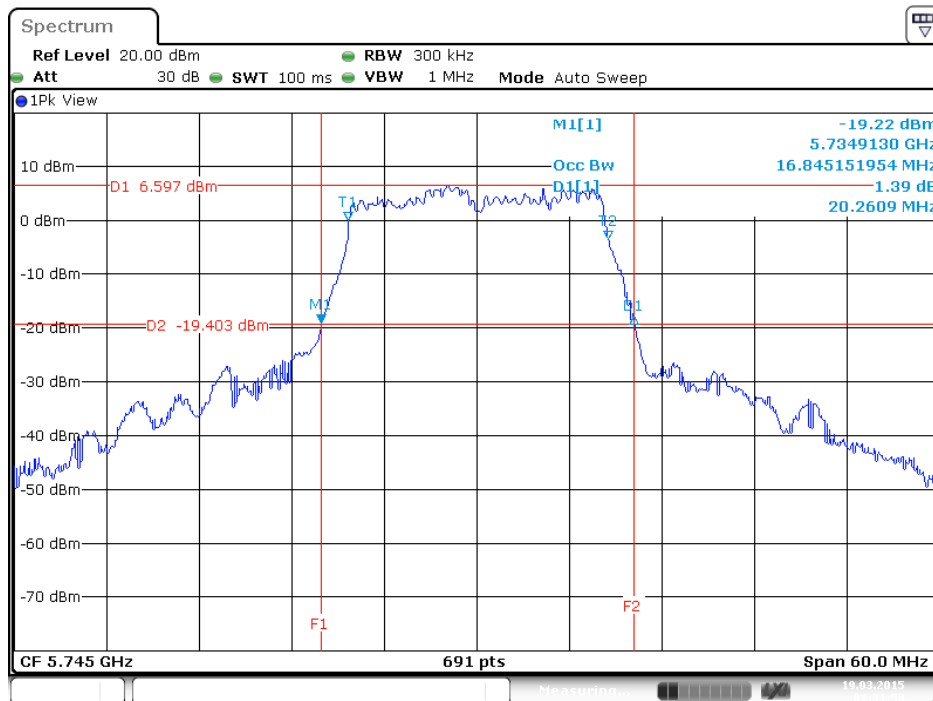

26dB Bandwidth Plot on Configuration IEEE 802.11a / CH 157 / 6Mbps / 1S3T CDD / Ant. 1

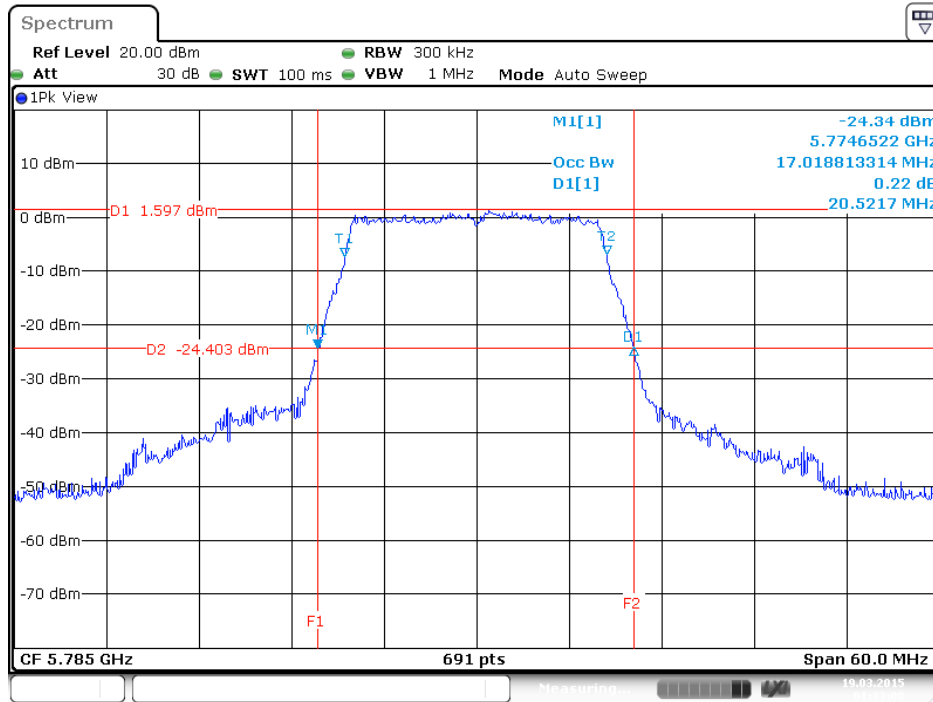

26dB Bandwidth Plot on Configuration IEEE 802.11a / CH 157 / 6Mbps / 1S3T CDD / Ant. 2

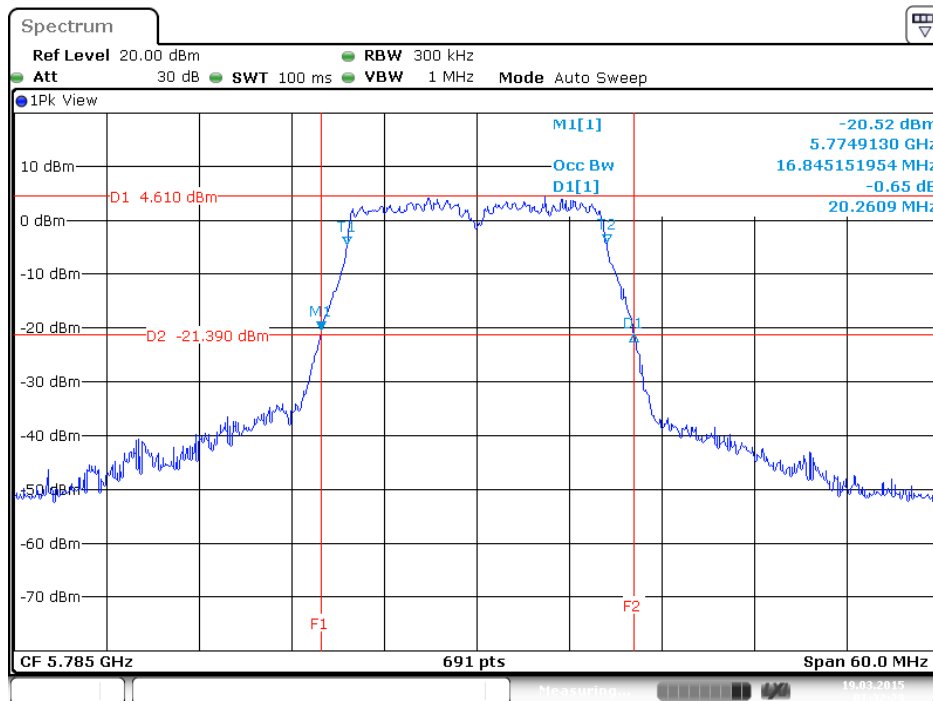

26dB Bandwidth Plot on Configuration IEEE 802.11a / CH 157 / 6Mbps / 1S3T CDD / Ant. 3

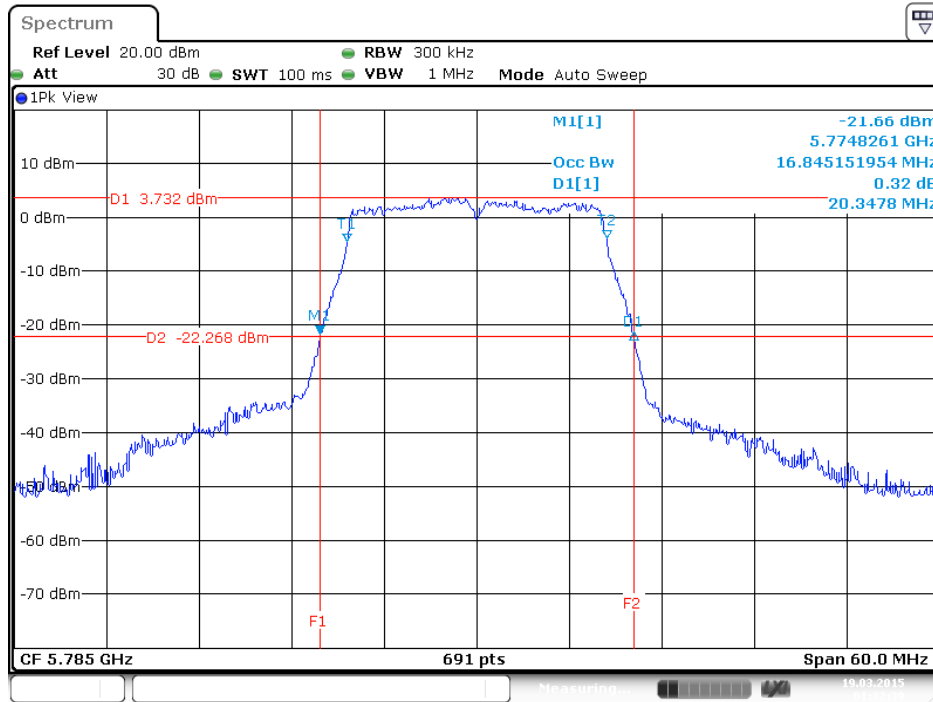

26dB Bandwidth Plot on Configuration IEEE 802.11a / CH 165 / 6Mbps / 1S3T CDD / Ant. 1

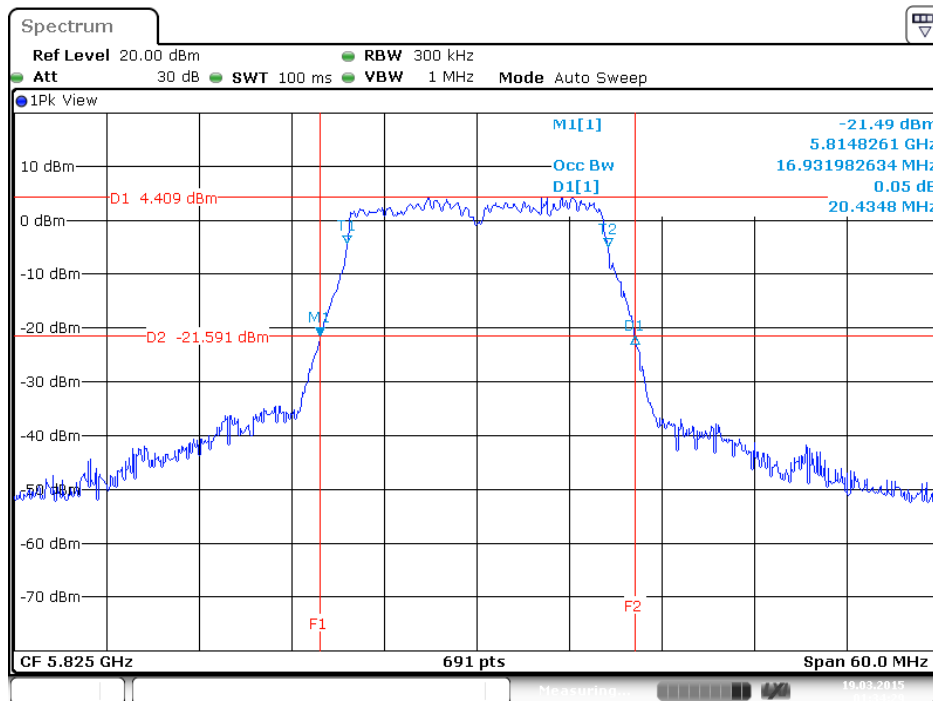

26dB Bandwidth Plot on Configuration IEEE 802.11a / CH 165 / 6Mbps / 1S3T CDD / Ant. 2

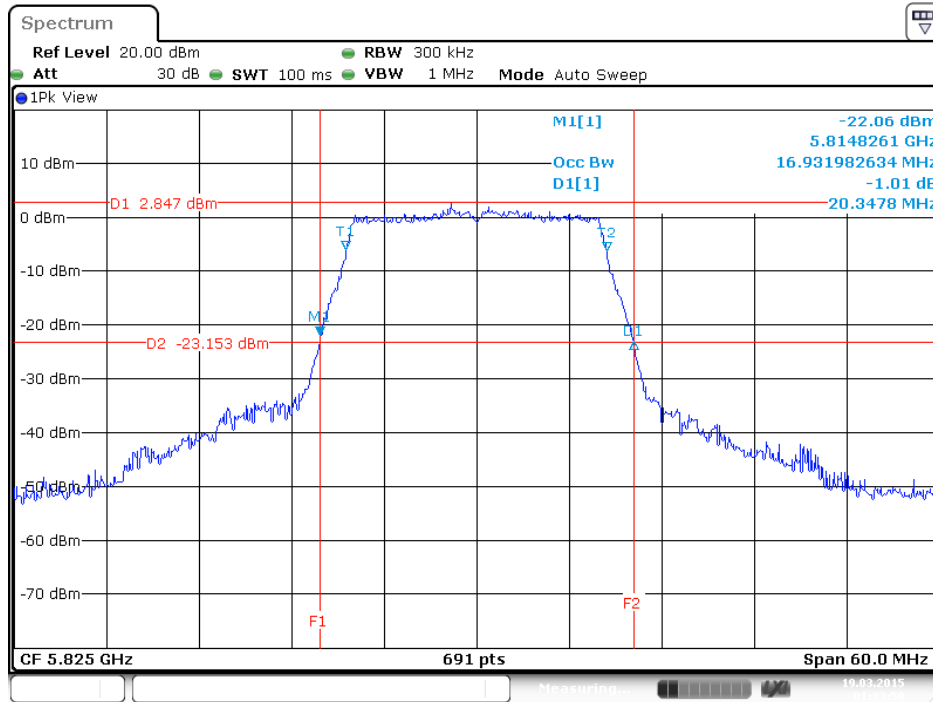

26dB Bandwidth Plot on Configuration IEEE 802.11a / CH 165 / 6Mbps / 1S3T CDD / Ant. 3

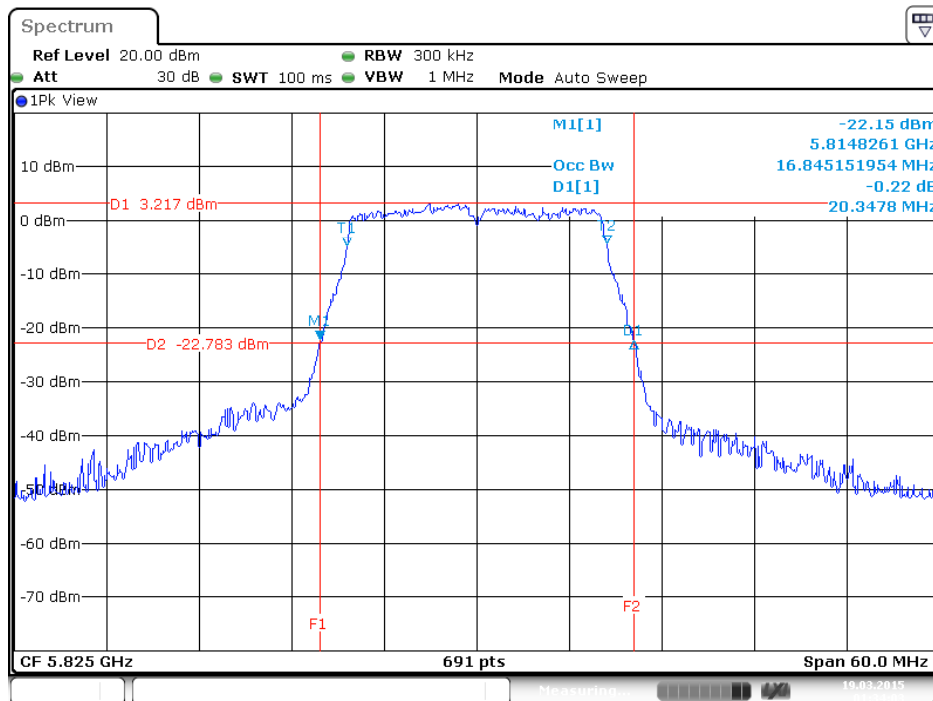

Test date	Mar. 17, 2015~Mar. 25, 2015	Test Site No.	TH01-CB
Temperature	20°C	Humidity	60%
Test Engineer	Mars Lin	Configuration	802.11ac 20MHz
Duty Cycle	<Nss1MCS0, Ant. 1>: 98.97% <Nss1MCS0, 1S3T, CDD>: 98.97% <Nss1MCS0, 1S3T, TXBF>: 97.23%		

Configuration IEEE 802.11ac 20MHz

<Nss1MCS0, Ant. 1>

Channel	Frequency	26dB Bandwidth (MHz)	99% Occupied Bandwidth (MHz)	Data Rate / MCS
36	5180 MHz	20.96	17.97	Nss1MCS0
40	5200 MHz	20.78	17.97	Nss1MCS0
48	5240 MHz	36.09	18.49	Nss1MCS0
149	5745 MHz	22.70	18.15	Nss1MCS0
157	5785 MHz	20.96	17.97	Nss1MCS0
165	5825 MHz	20.61	17.97	Nss1MCS0

<Nss1MCS0, 1S3T, CDD>

Channel	Frequency	26dB Bandwidth (MHz)			99% Occupied Bandwidth (MHz)			Data Rate / MCS
		Ant. 1	Ant. 2	Ant. 3	Ant. 1	Ant. 2	Ant. 3	
36	5180 MHz	20.78	20.26	20.61	17.97	17.80	17.80	Nss1MCS0
40	5200 MHz	20.52	20.52	20.61	17.80	17.89	17.80	Nss1MCS0
48	5240 MHz	20.78	20.96	20.61	17.97	17.80	17.80	Nss1MCS0
149	5745 MHz	20.52	20.87	20.43	17.80	17.97	17.80	Nss1MCS0
157	5785 MHz	20.35	20.52	20.70	17.80	17.89	17.97	Nss1MCS0
165	5825 MHz	20.61	20.52	20.52	17.97	17.80	17.89	Nss1MCS0

<Nss1MCS0, 1S3T, TXBF>

Channel	Frequency	26dB Bandwidth (MHz)			99% Occupied Bandwidth (MHz)			Data Rate / MCS
		Ant. 1	Ant. 2	Ant. 3	Ant. 1	Ant. 2	Ant. 3	
36	5180 MHz	20.61	20.26	20.87	17.80	17.80	17.97	Nss1MCS0
40	5200 MHz	20.61	20.43	20.61	17.80	17.80	17.97	Nss1MCS0
48	5240 MHz	20.70	23.65	21.22	17.89	17.97	18.15	Nss1MCS0
149	5745 MHz	20.43	20.61	20.52	17.80	17.97	17.80	Nss1MCS0
157	5785 MHz	20.43	20.43	20.61	17.80	17.89	17.97	Nss1MCS0
165	5825 MHz	20.43	20.61	20.43	17.80	17.97	17.80	Nss1MCS0

<Nss1MCS0, Ant. 1>:

26dB Bandwidth Plot on Configuration IEEE 802.11ac 20MHz / CH 36 / Ant. 1

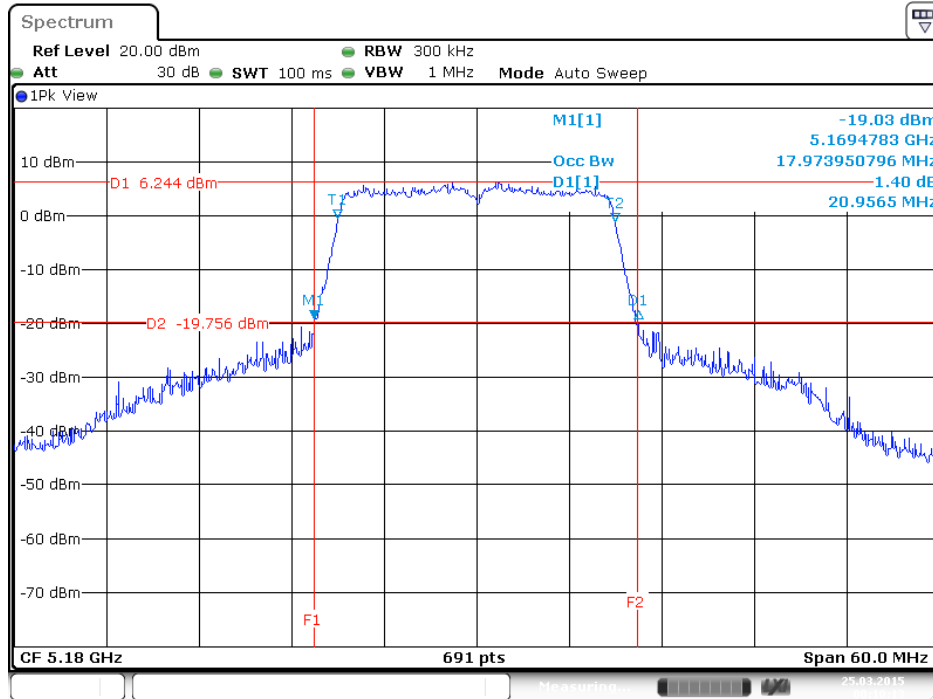

26dB Bandwidth Plot on Configuration IEEE 802.11ac 20MHz / CH 40 / Ant. 1

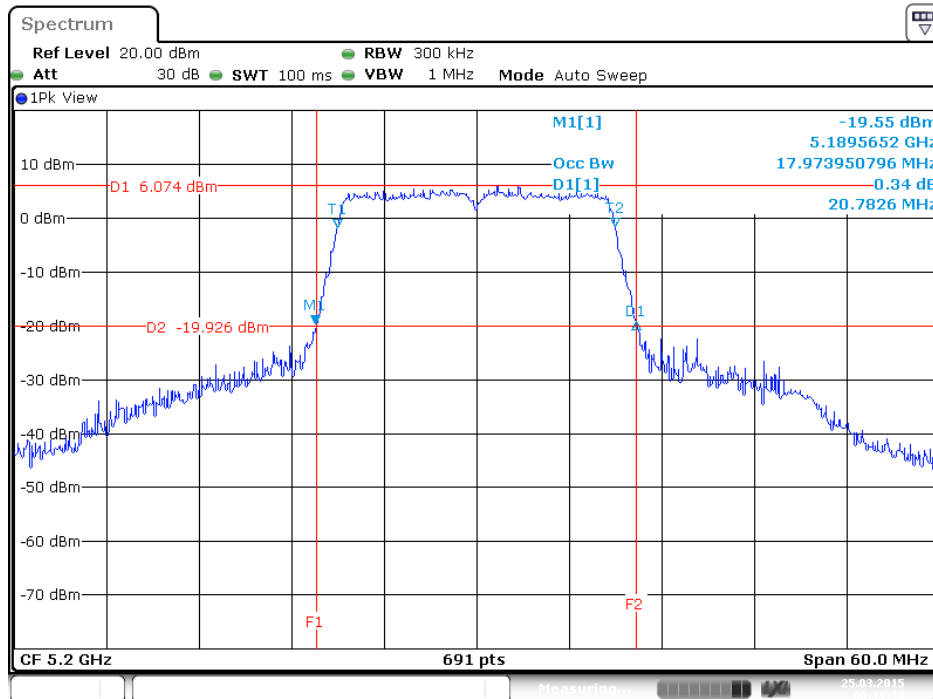

26dB Bandwidth Plot on Configuration IEEE 802.11ac 20MHz / CH 48 / Ant. 1

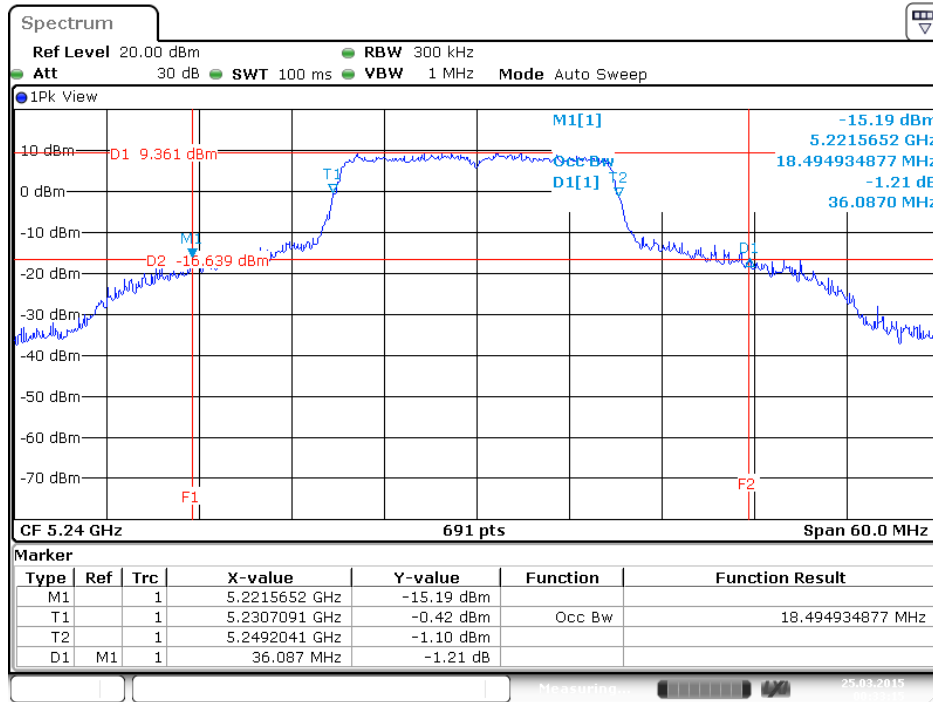

Date: 25 MAR 2015 00:33:15

26dB Bandwidth Plot on Configuration IEEE 802.11ac 20MHz / CH 149 / Ant. 1

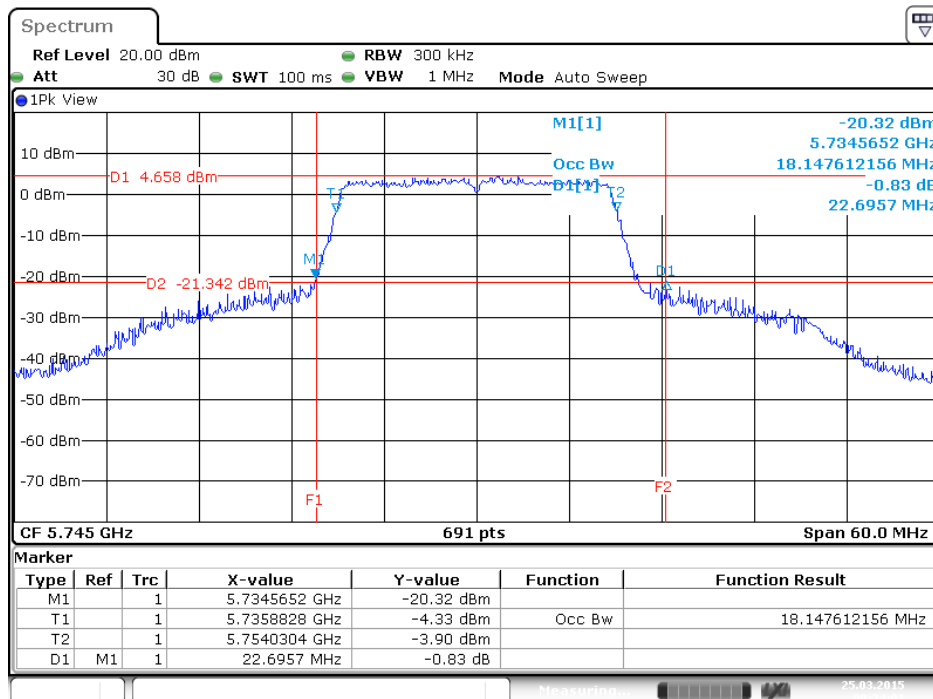

Date: 25 MAR 2015 00:34:00

26dB Bandwidth Plot on Configuration IEEE 802.11ac 20MHz / CH 157 / Ant. 1

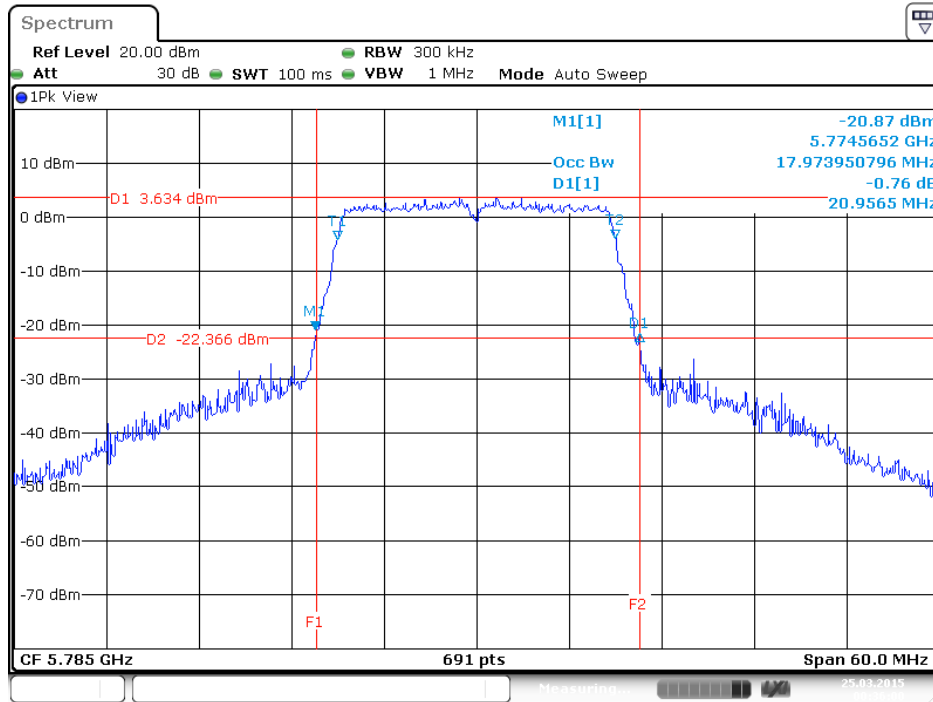

26dB Bandwidth Plot on Configuration IEEE 802.11ac 20MHz / CH 165 / Ant. 1

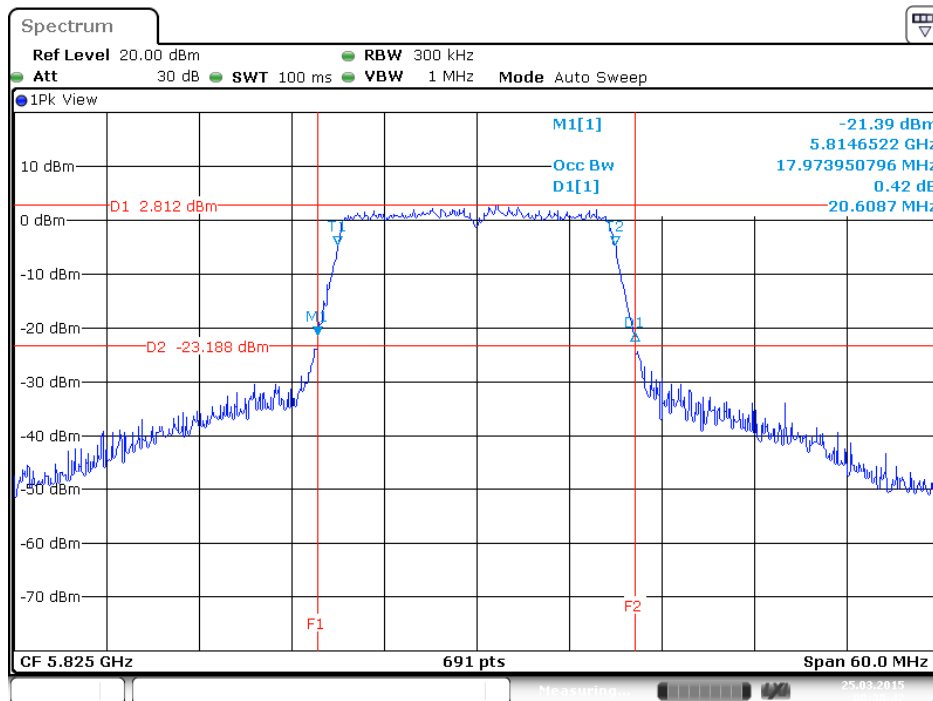

<Nss1MCS0, 1S3T, CDD>:

26dB Bandwidth Plot on Configuration IEEE 802.11ac 20MHz / CH 36 / MCS0 / 1S3T CDD / Ant. 1

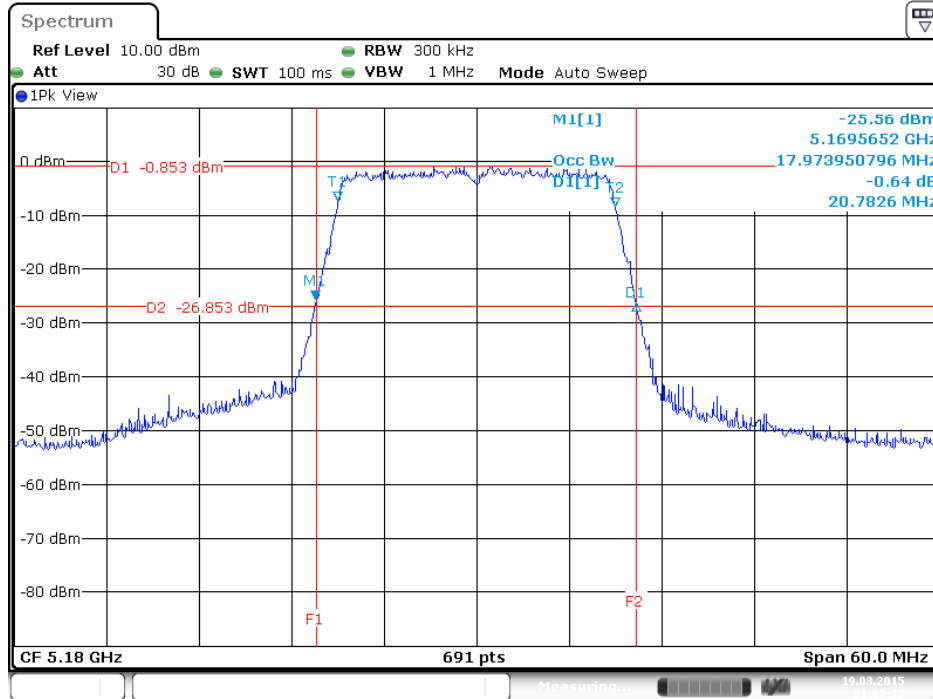

26dB Bandwidth Plot on Configuration IEEE 802.11ac 20MHz / CH 36 / MCS0 / 1S3T CDD / Ant. 2

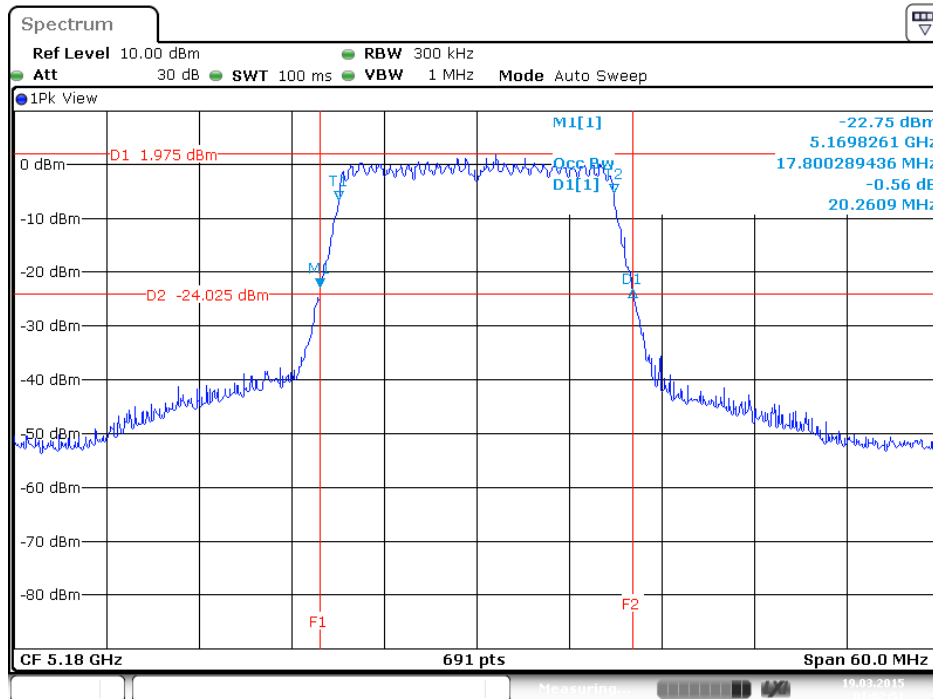

26dB Bandwidth Plot on Configuration IEEE 802.11ac 20MHz / CH 36 / MCS0 / 1S3T CDD / Ant. 3

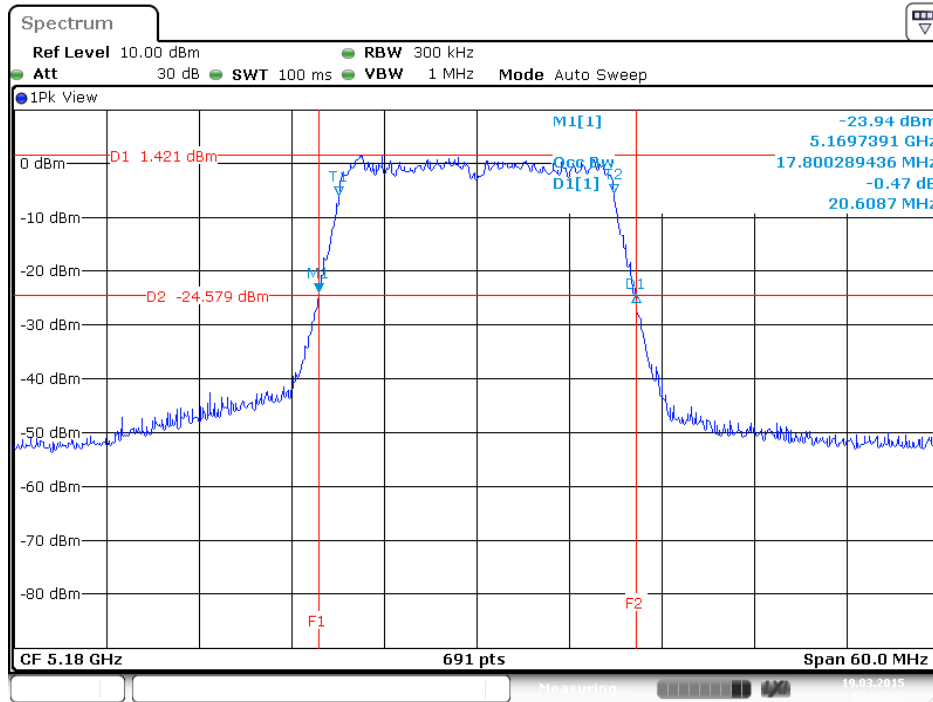

26dB Bandwidth Plot on Configuration IEEE 802.11ac 20MHz / CH 40 / MCS0 / 1S3T CDD / Ant. 1

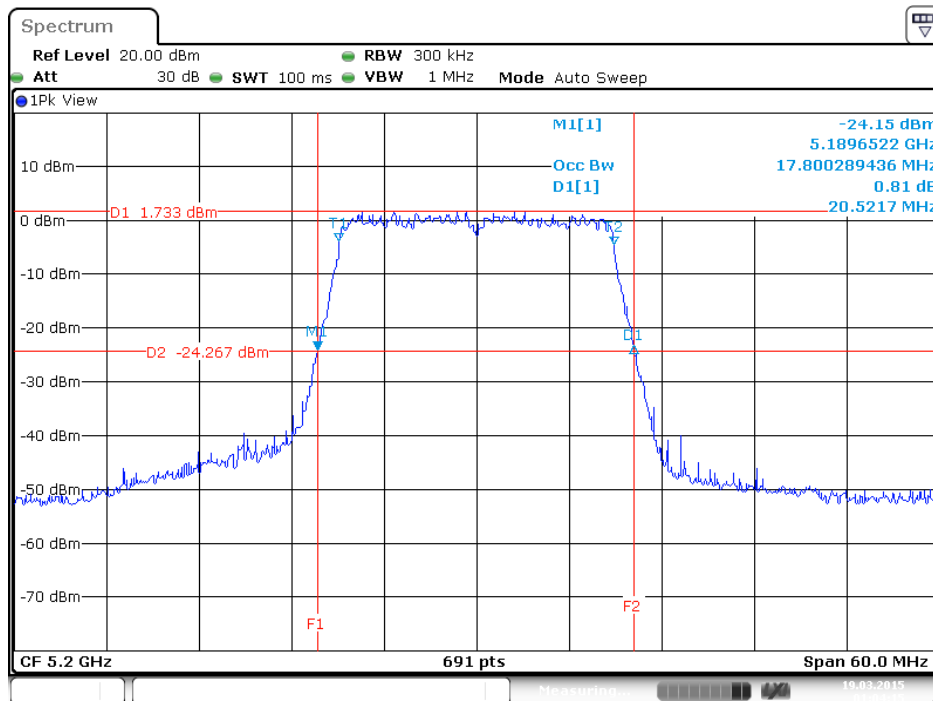

26dB Bandwidth Plot on Configuration IEEE 802.11ac 20MHz / CH 40 / MCS0 / 1S3T CDD / Ant. 2

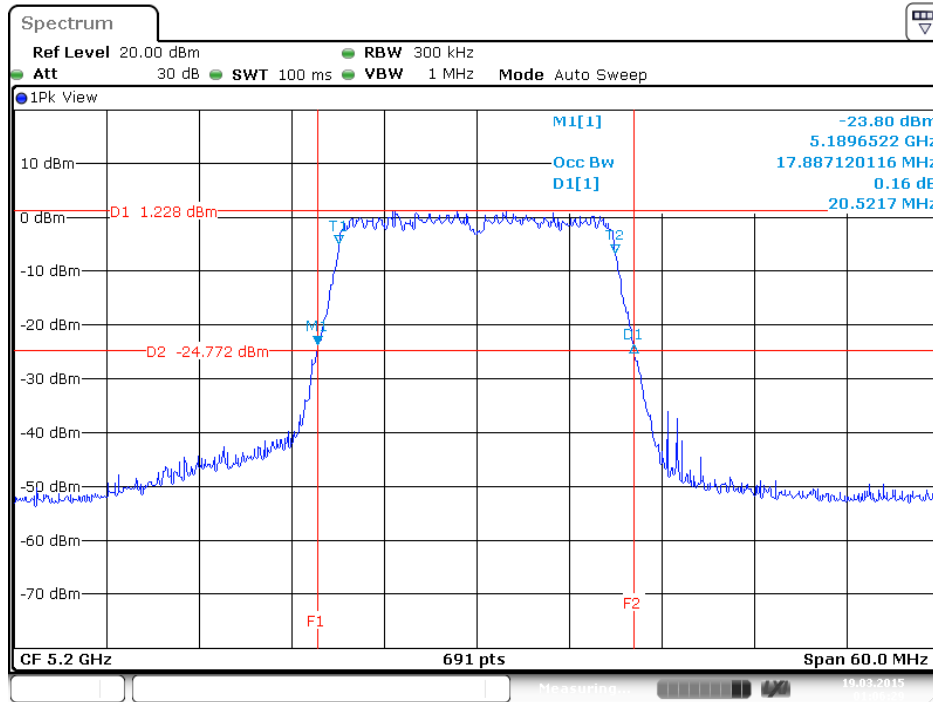

26dB Bandwidth Plot on Configuration IEEE 802.11ac 20MHz / CH 40 / MCS0 / 1S3T CDD / Ant. 3

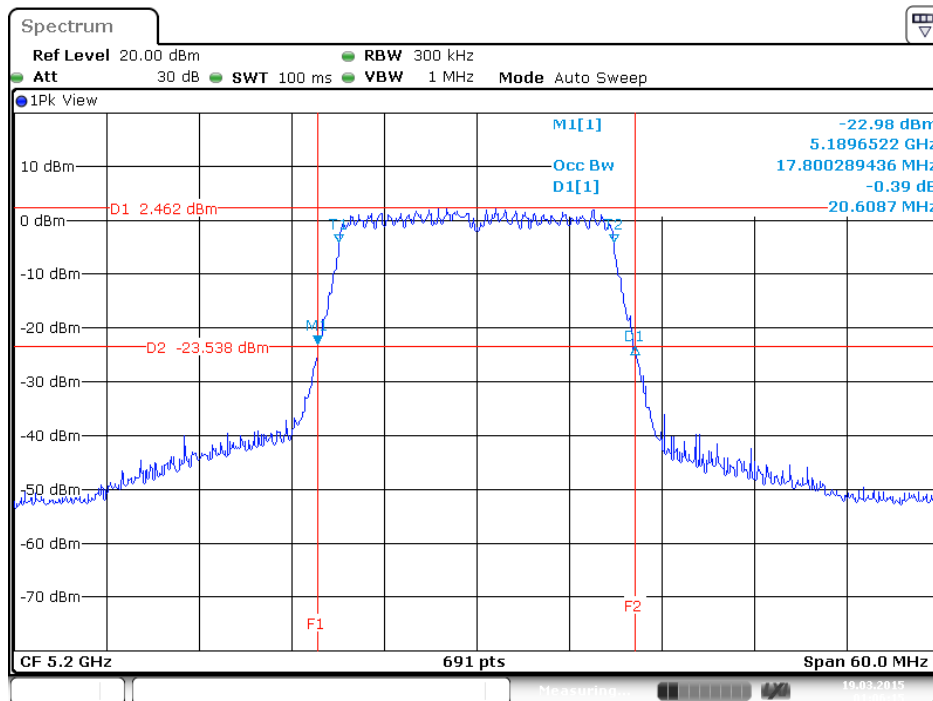

26dB Bandwidth Plot on Configuration IEEE 802.11ac 20MHz / CH 48 / MCS0 / 1S3T CDD / Ant. 1

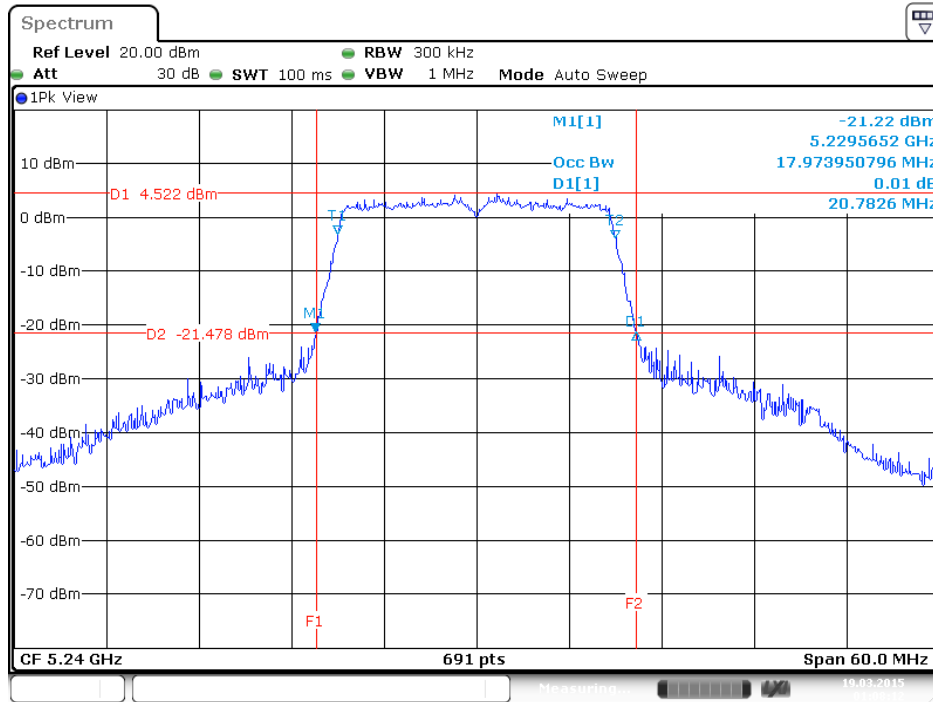

26dB Bandwidth Plot on Configuration IEEE 802.11ac 20MHz / CH 48 / MCS0 / 1S3T CDD / Ant. 2

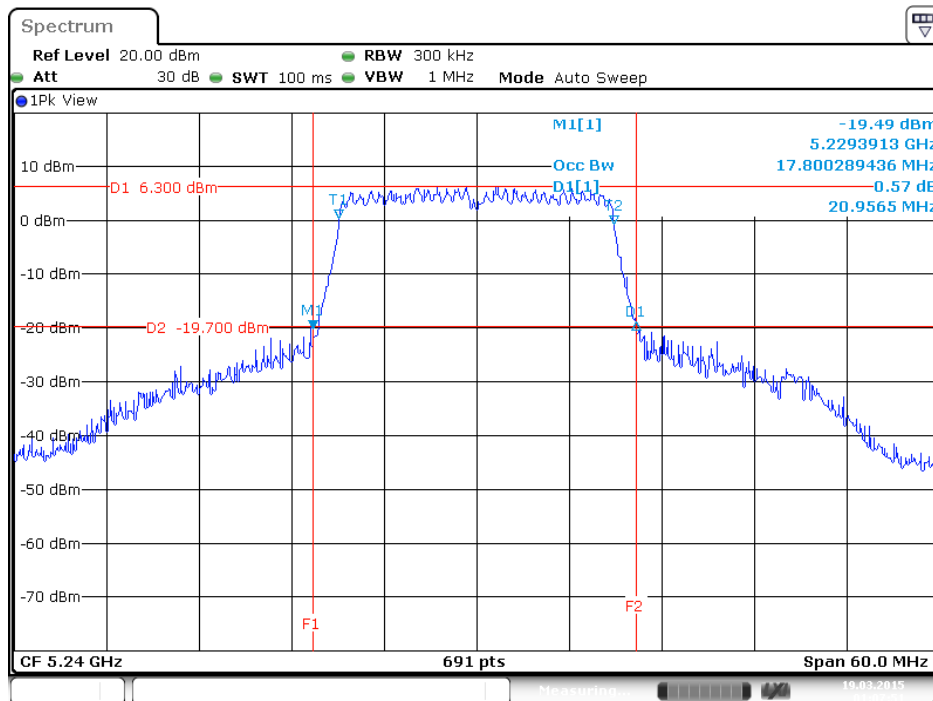

26dB Bandwidth Plot on Configuration IEEE 802.11ac 20MHz / CH 48 / MCS0 / 1S3T CDD / Ant. 3

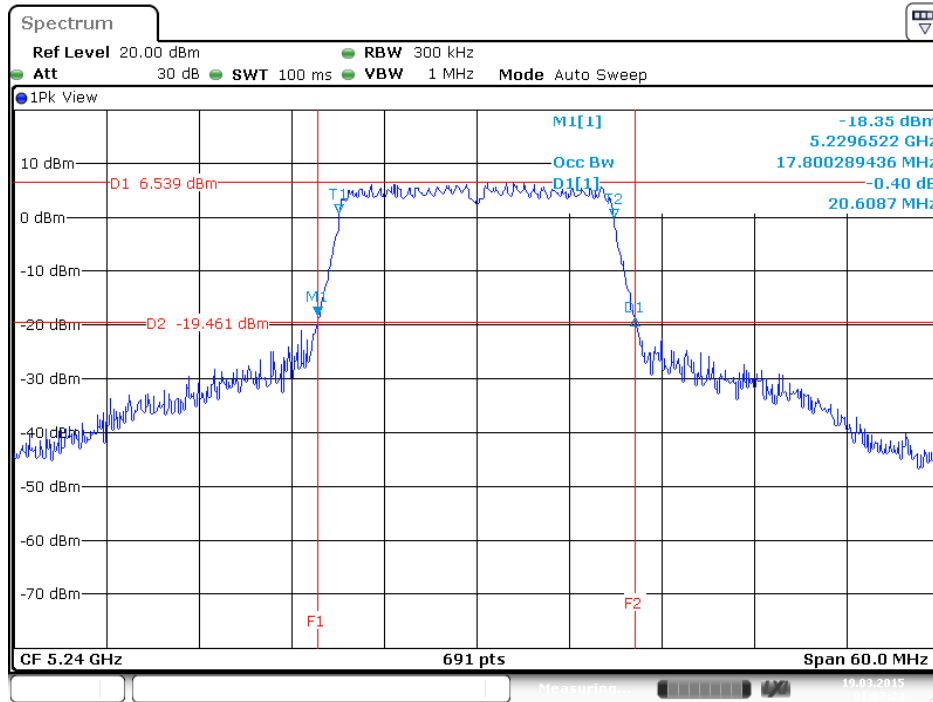

26dB Bandwidth Plot on Configuration IEEE 802.11ac 20MHz / CH 149 / MCS0 / 1S3T CDD / Ant. 1

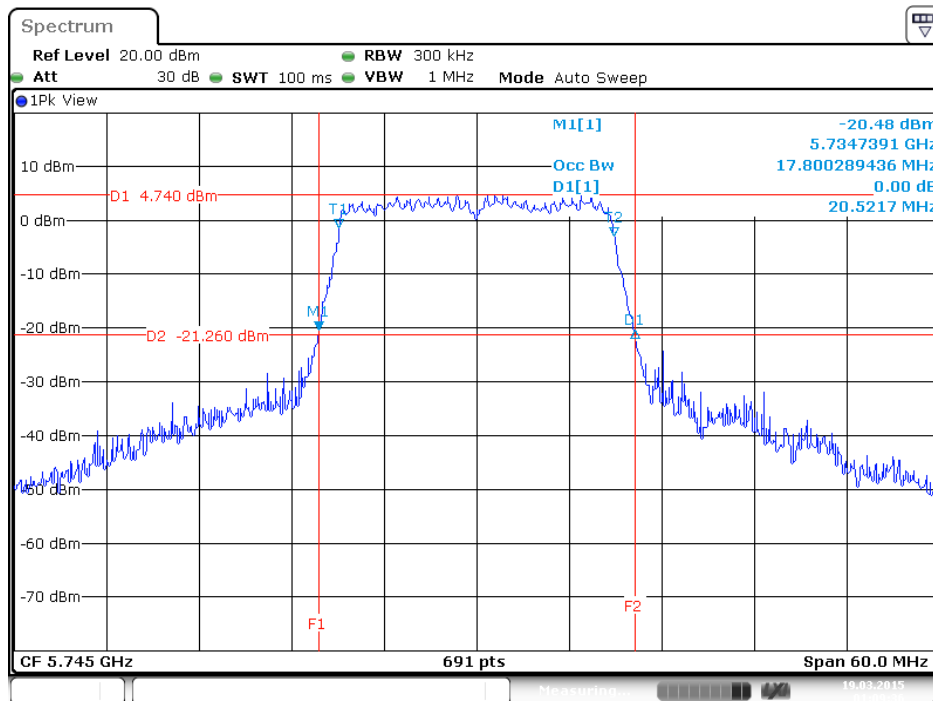

26dB Bandwidth Plot on Configuration IEEE 802.11ac 20MHz / CH 149 / MCS0 / 1S3T CDD / Ant. 2

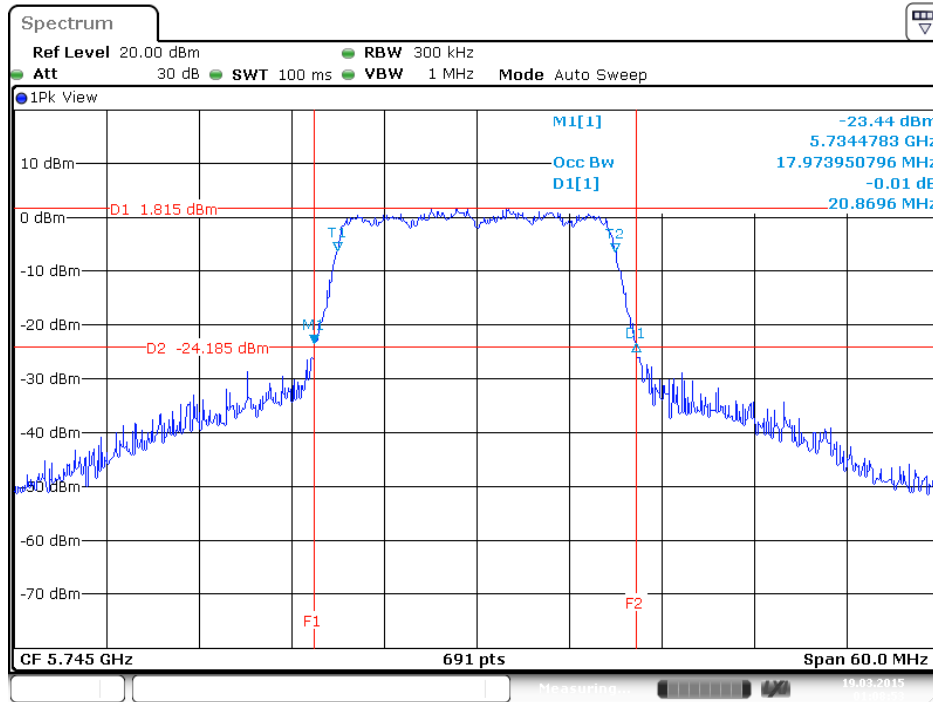

26dB Bandwidth Plot on Configuration IEEE 802.11ac 20MHz / CH 149 / MCS0 / 1S3T CDD / Ant. 3

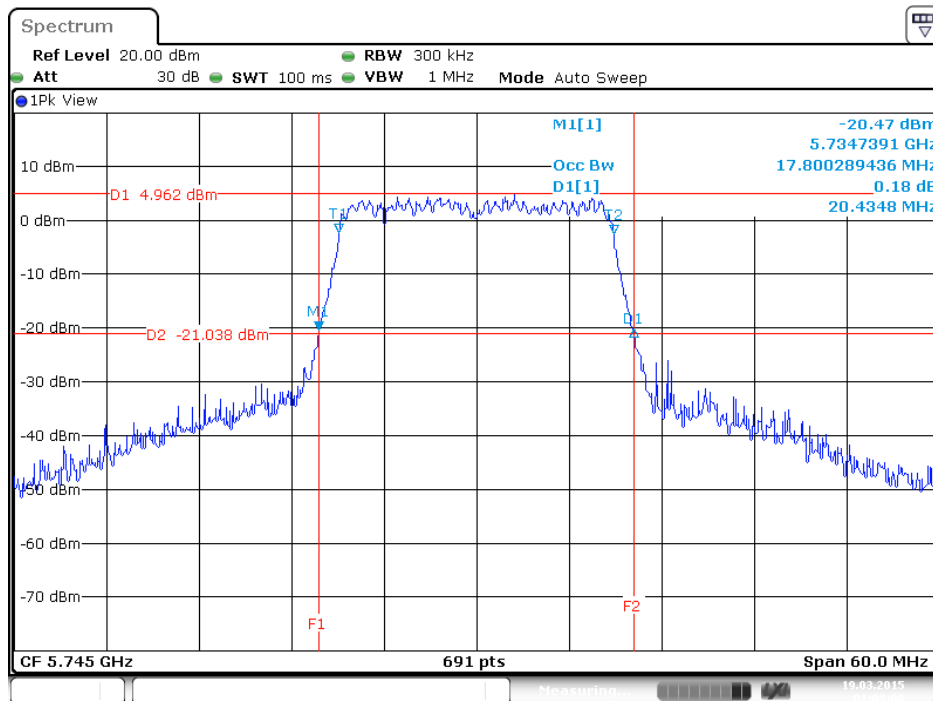

26dB Bandwidth Plot on Configuration IEEE 802.11ac 20MHz / CH 157 / MCS0 / 1S3T CDD / Ant. 1

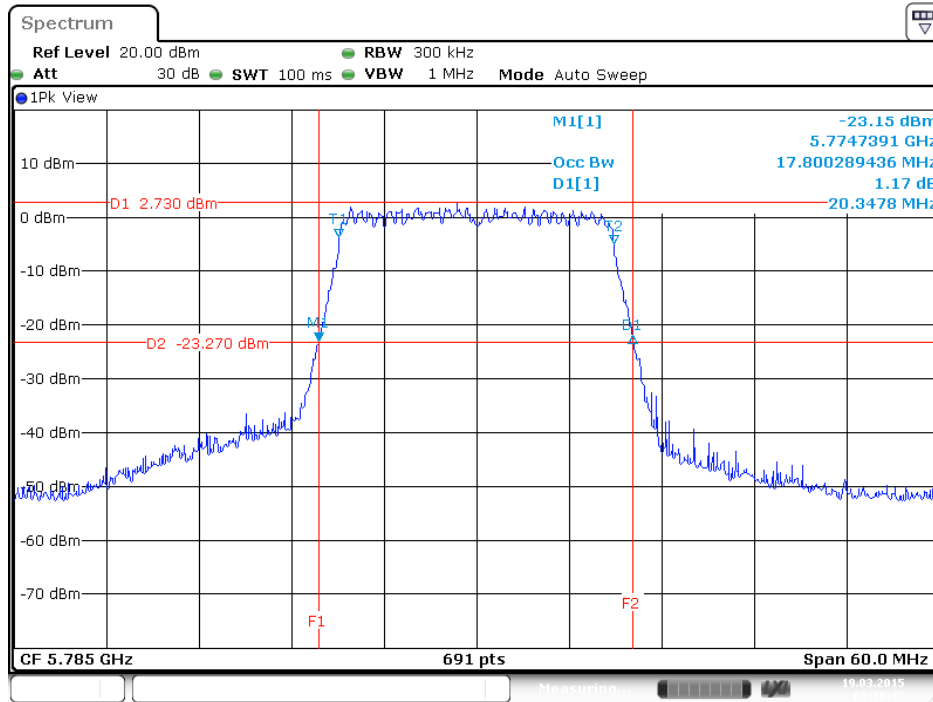

26dB Bandwidth Plot on Configuration IEEE 802.11ac 20MHz / CH 157 / MCS0 / 1S3T CDD / Ant. 2

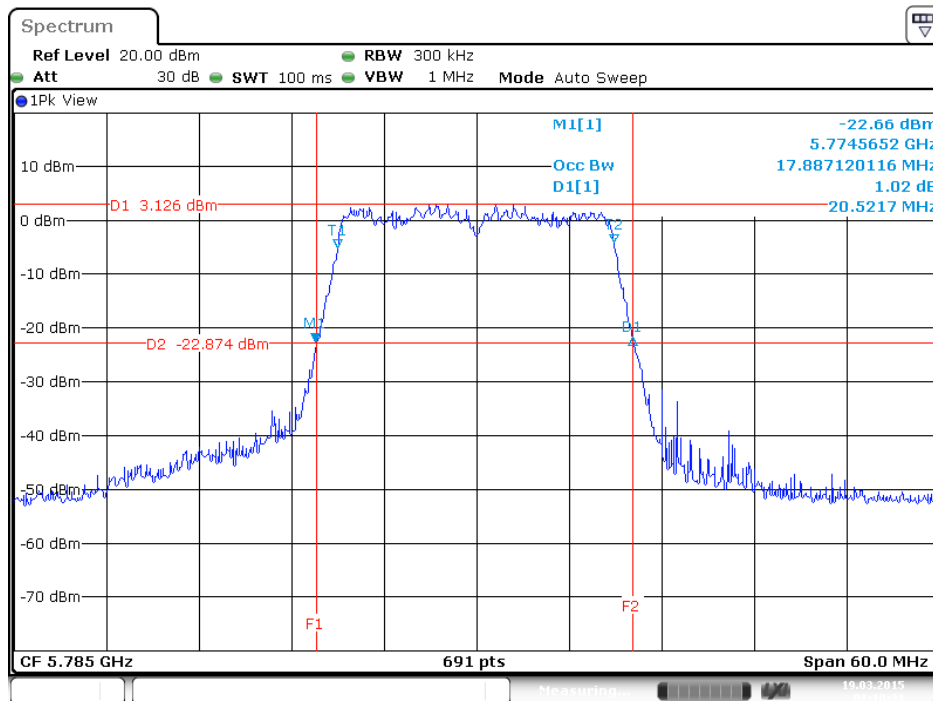

26dB Bandwidth Plot on Configuration IEEE 802.11ac 20MHz / CH 157 / MCS0 / 1S3T CDD / Ant. 3

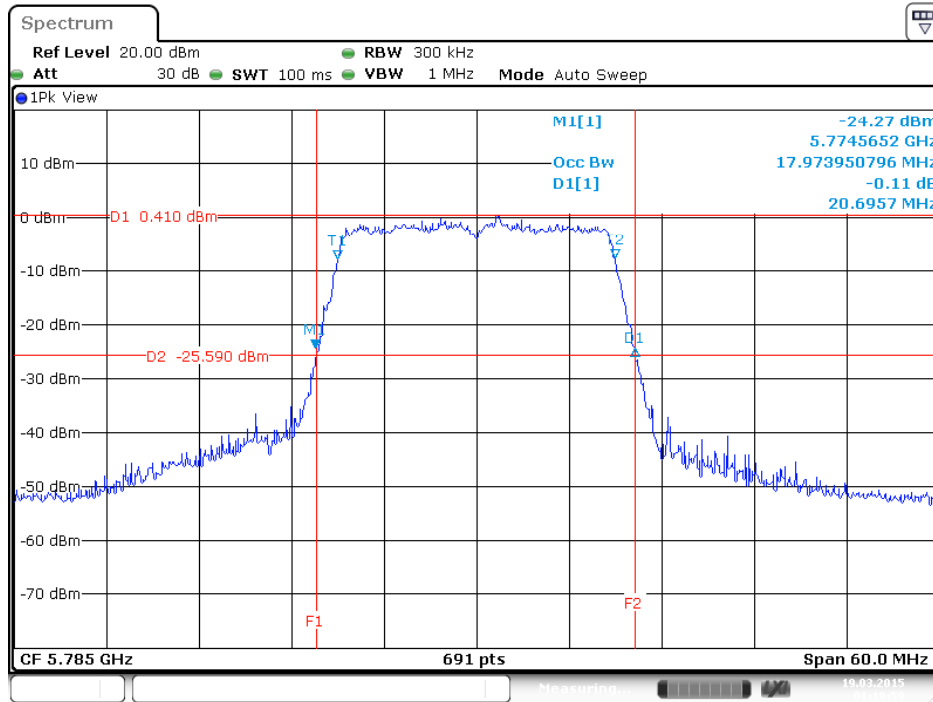

26dB Bandwidth Plot on Configuration IEEE 802.11ac 20MHz / CH 165 / MCS0 / 1S3T CDD / Ant. 1

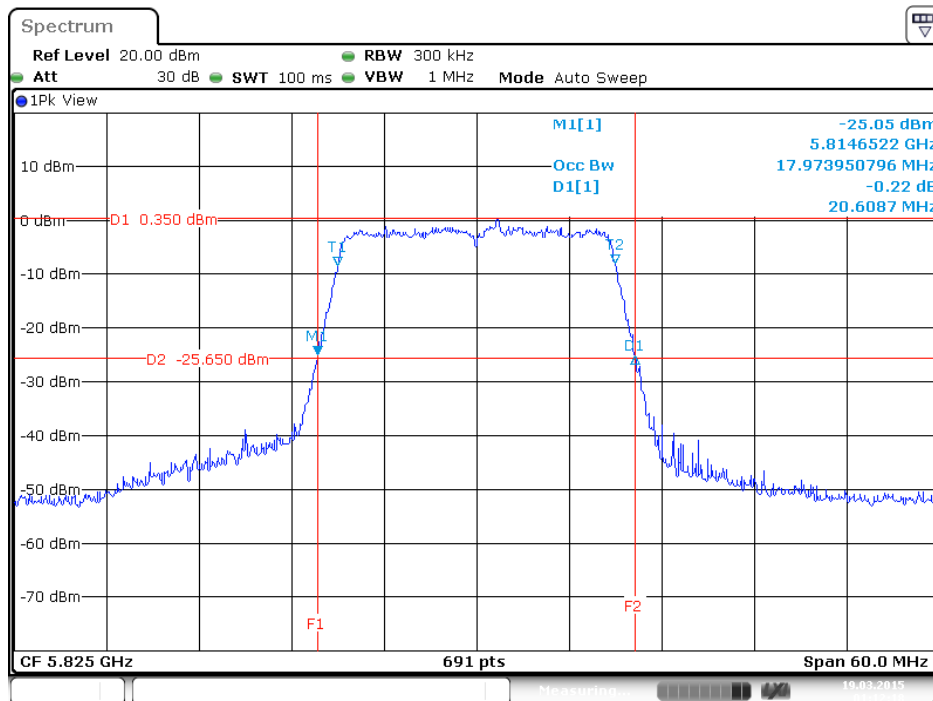

26dB Bandwidth Plot on Configuration IEEE 802.11ac 20MHz / CH 165 / MCS0 / 1S3T CDD / Ant. 2

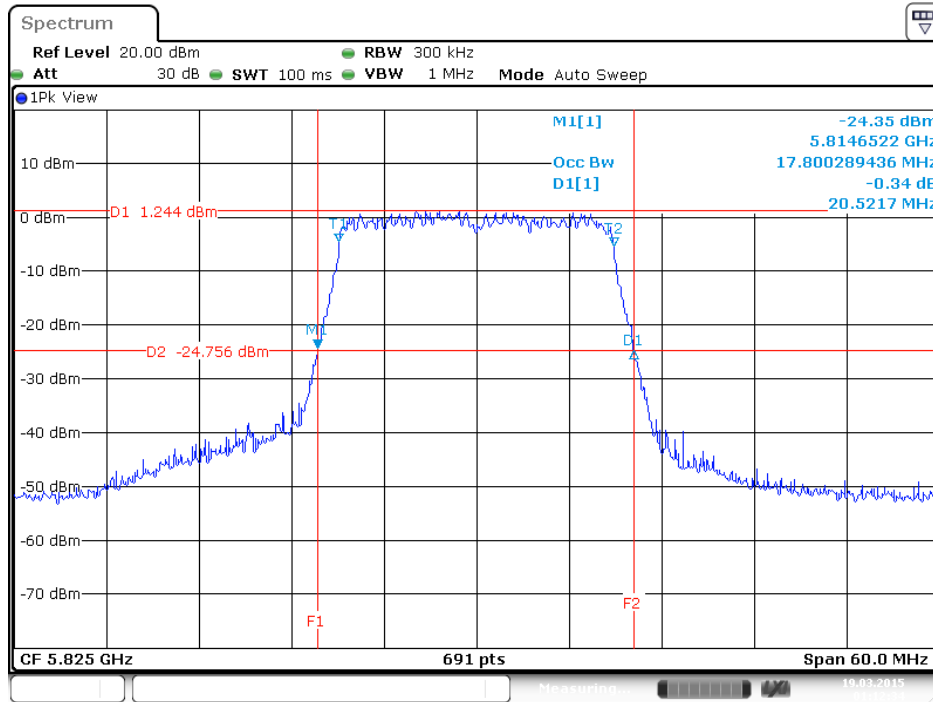

26dB Bandwidth Plot on Configuration IEEE 802.11ac 20MHz / CH 165 / MCS0 / 1S3T CDD / Ant. 3

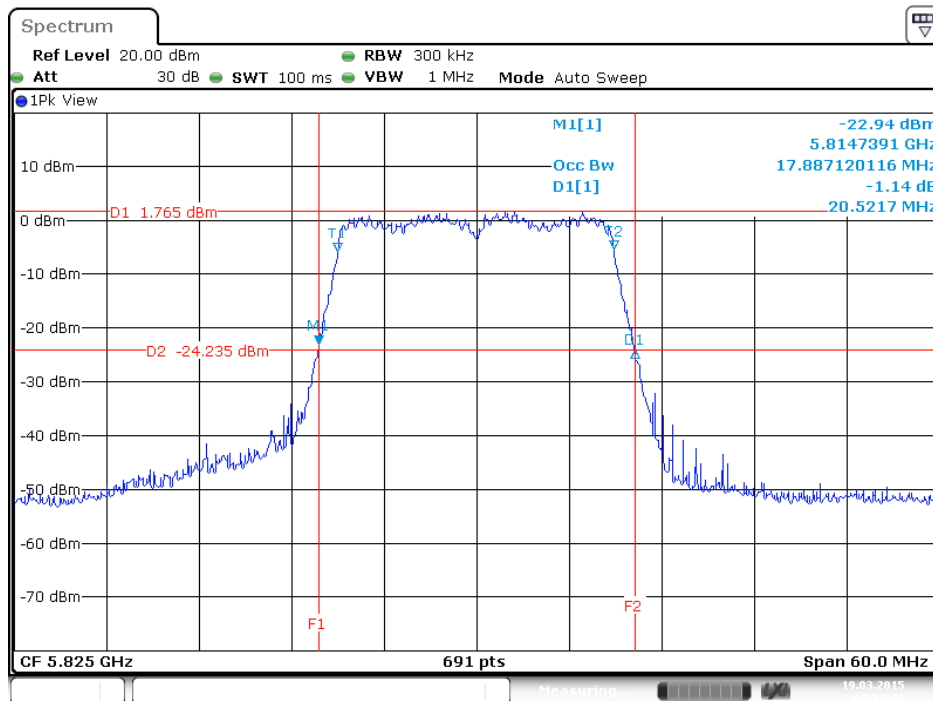

<Nss1MCS0, 1S3T, TXBF>

26dB Bandwidth Plot on Configuration IEEE 802.11ac 20MHz / CH 36 / MCS0 / 1S3T TXBF / Ant. 1

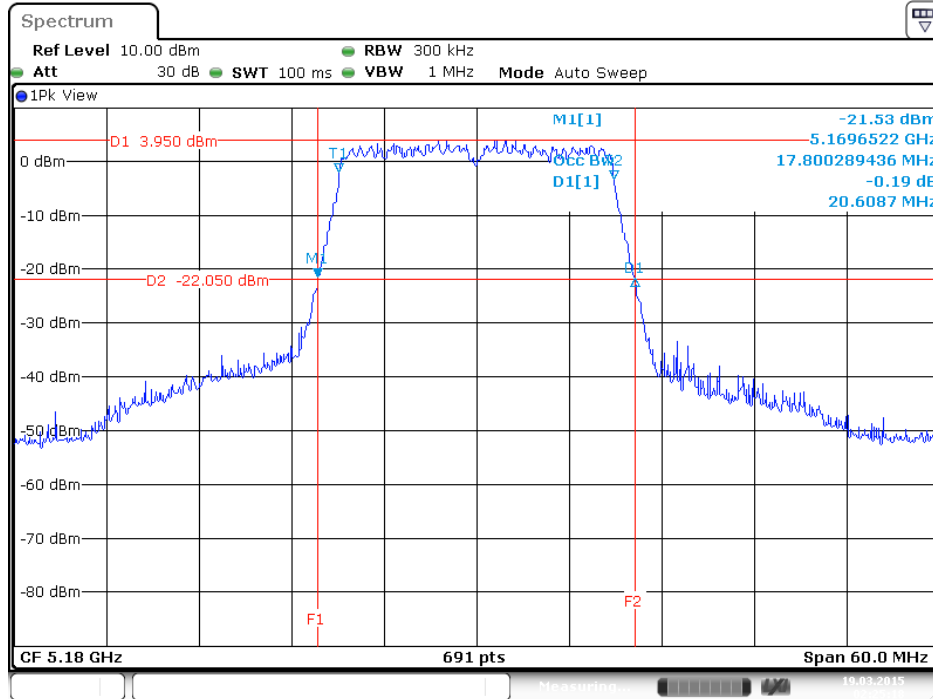

26dB Bandwidth Plot on Configuration IEEE 802.11ac 20MHz / CH 36 / MCS0 / 1S3T TXBF / Ant. 2

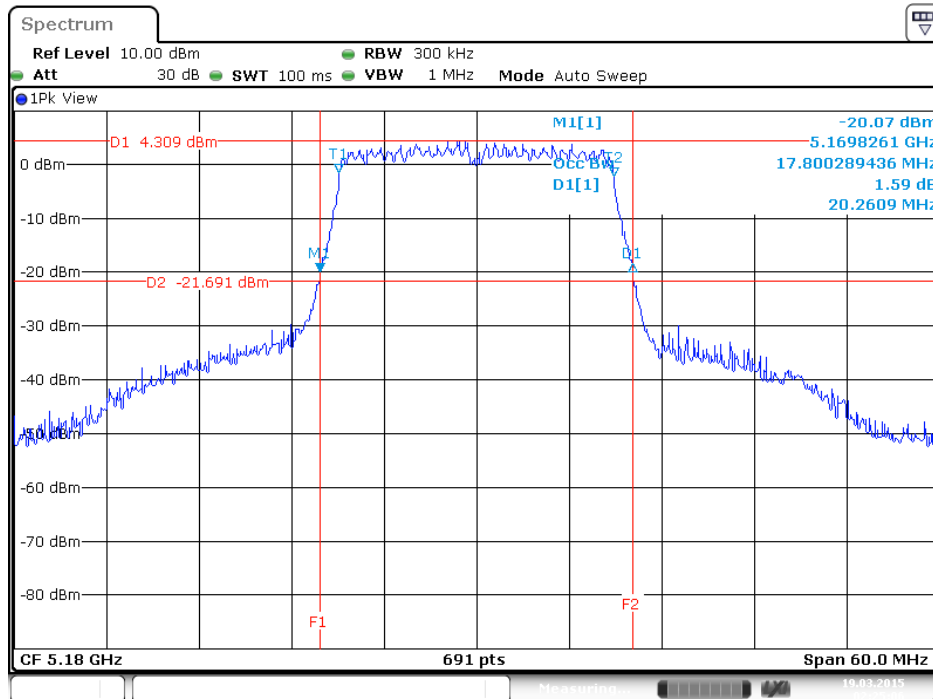

26dB Bandwidth Plot on Configuration IEEE 802.11ac 20MHz / CH 36 / MCS0 / 1S3T TXBF / Ant. 3

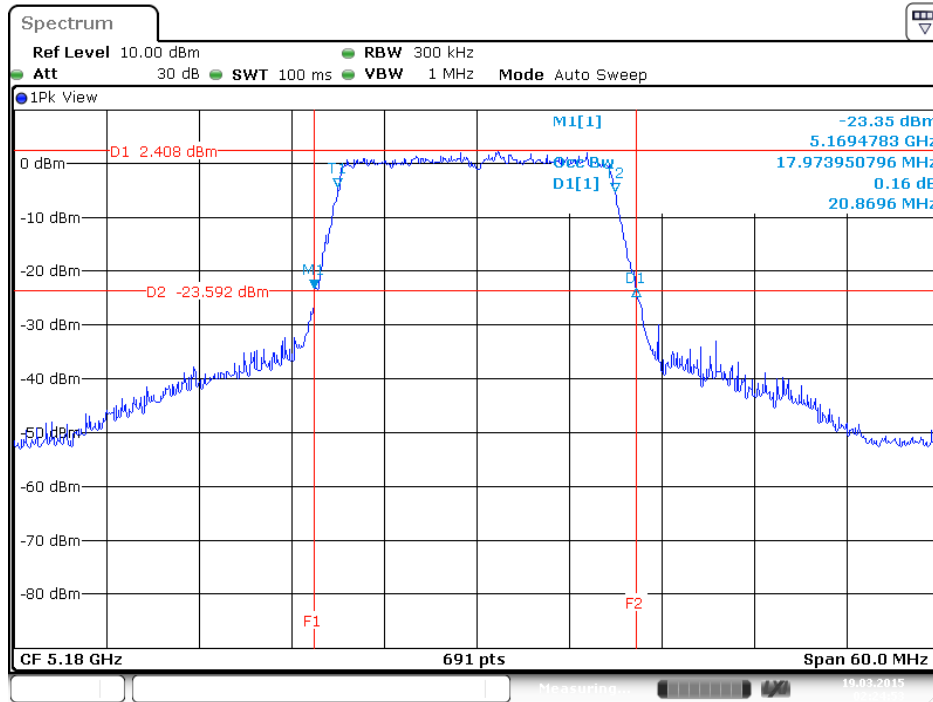

26dB Bandwidth Plot on Configuration IEEE 802.11ac 20MHz / CH 40 / MCS0 / 1S3T TXBF / Ant. 1

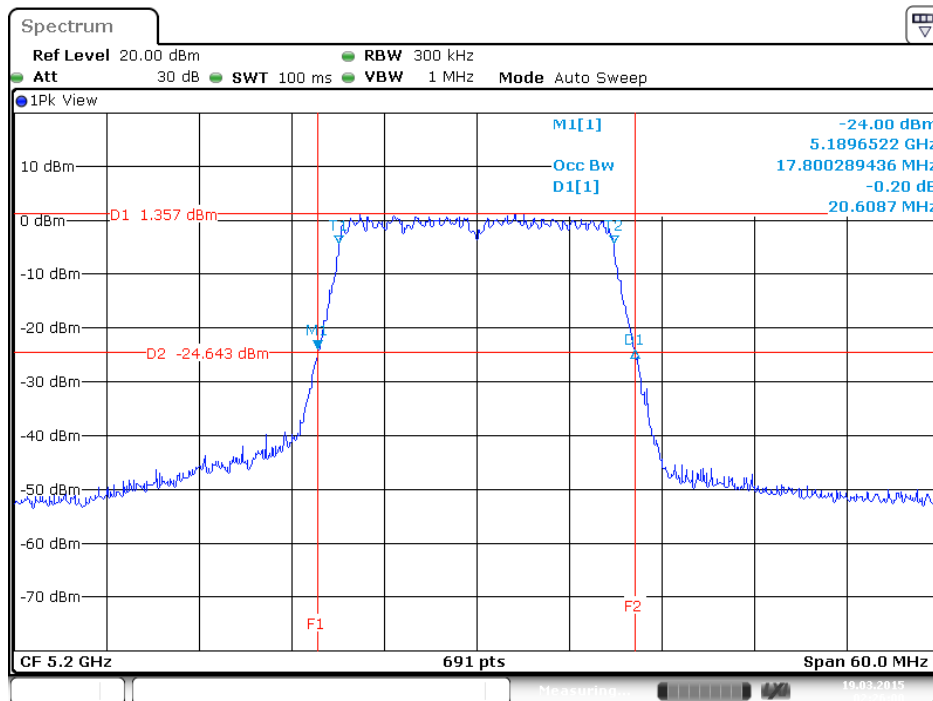

26dB Bandwidth Plot on Configuration IEEE 802.11ac 20MHz / CH 40 / MCS0 / 1S3T TXBF / Ant. 2

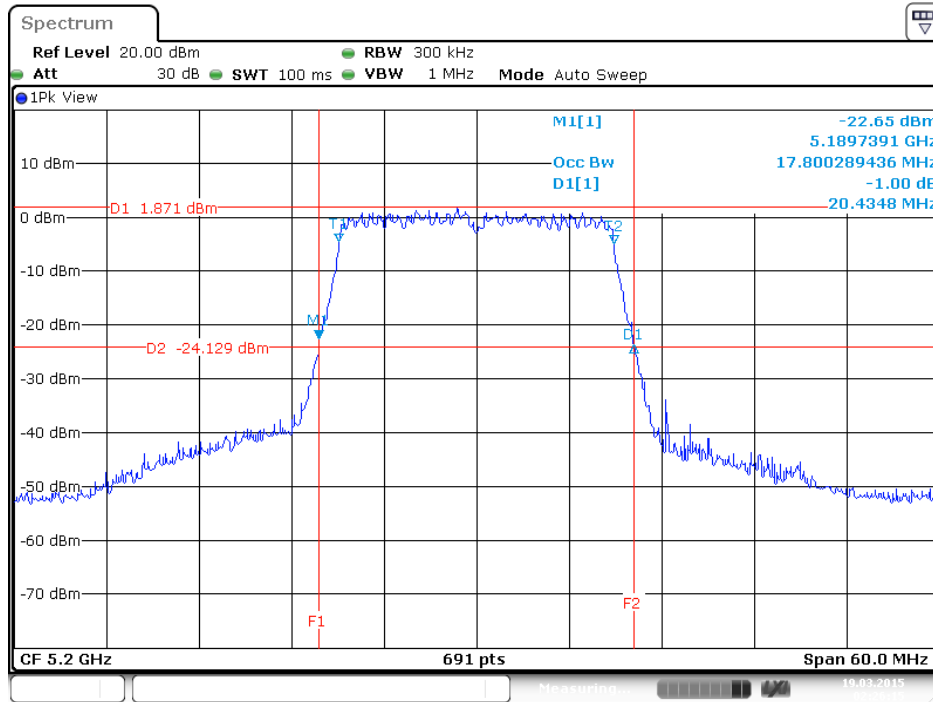

26dB Bandwidth Plot on Configuration IEEE 802.11ac 20MHz / CH 40 / MCS0 / 1S3T TXBF / Ant. 3

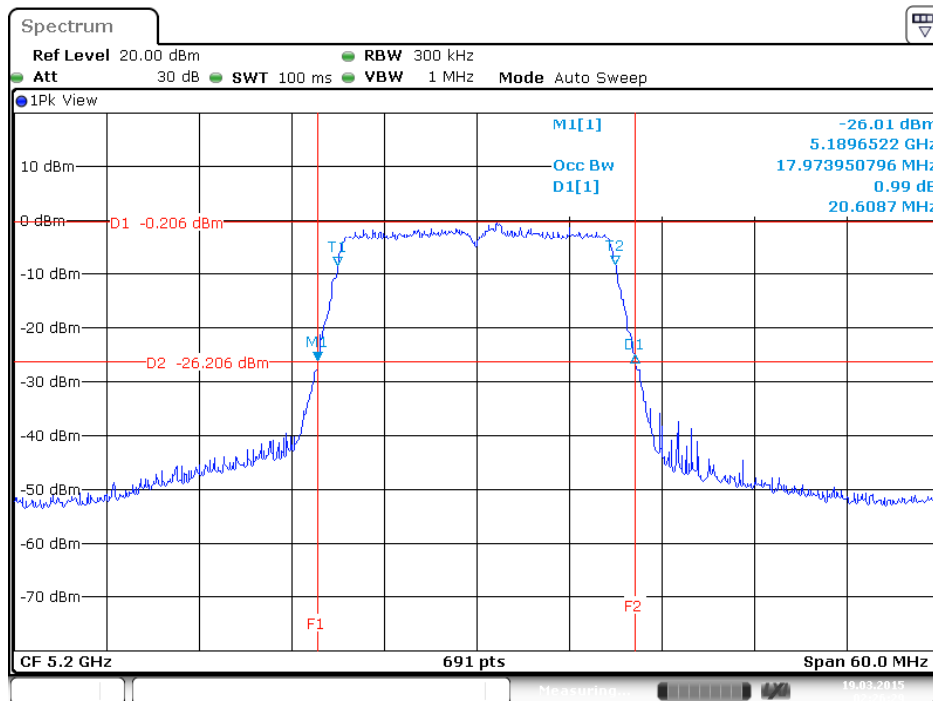

26dB Bandwidth Plot on Configuration IEEE 802.11ac 20MHz / CH 48 / MCS0 / 1S3T TXBF / Ant. 1

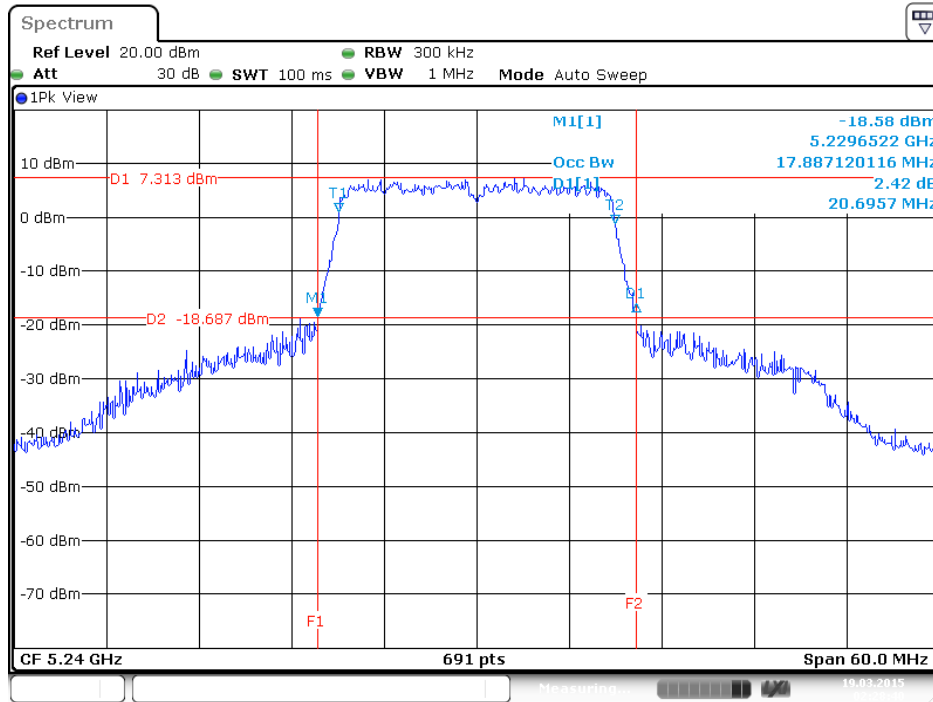

26dB Bandwidth Plot on Configuration IEEE 802.11ac 20MHz / CH 48 / MCS0 / 1S3T TXBF / Ant. 2

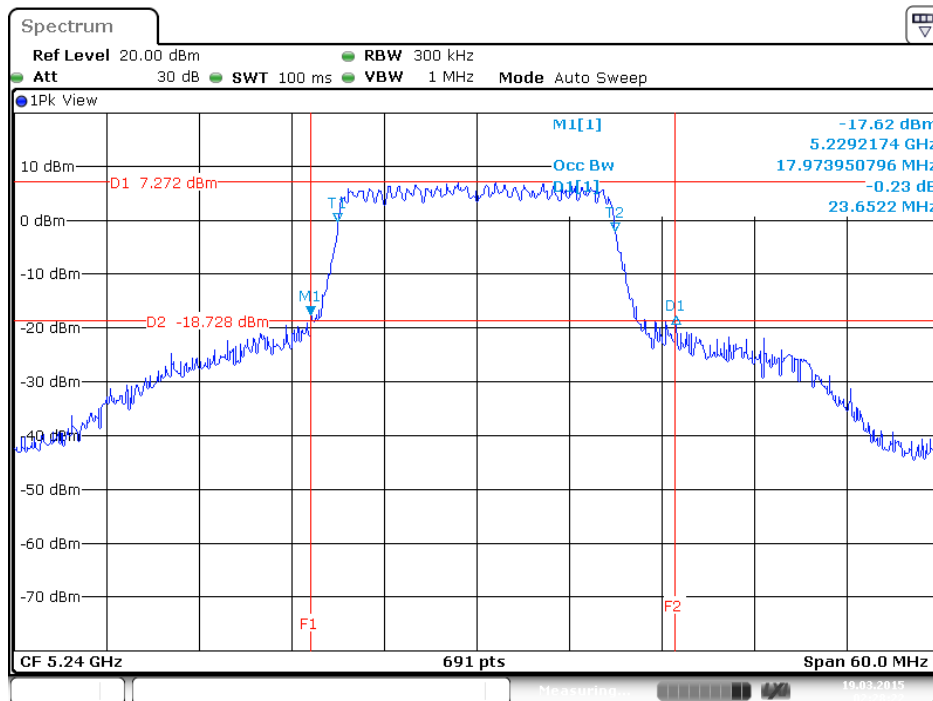

26dB Bandwidth Plot on Configuration IEEE 802.11ac 20MHz / CH 48 / MCS0 / 1S3T TXBF / Ant. 3

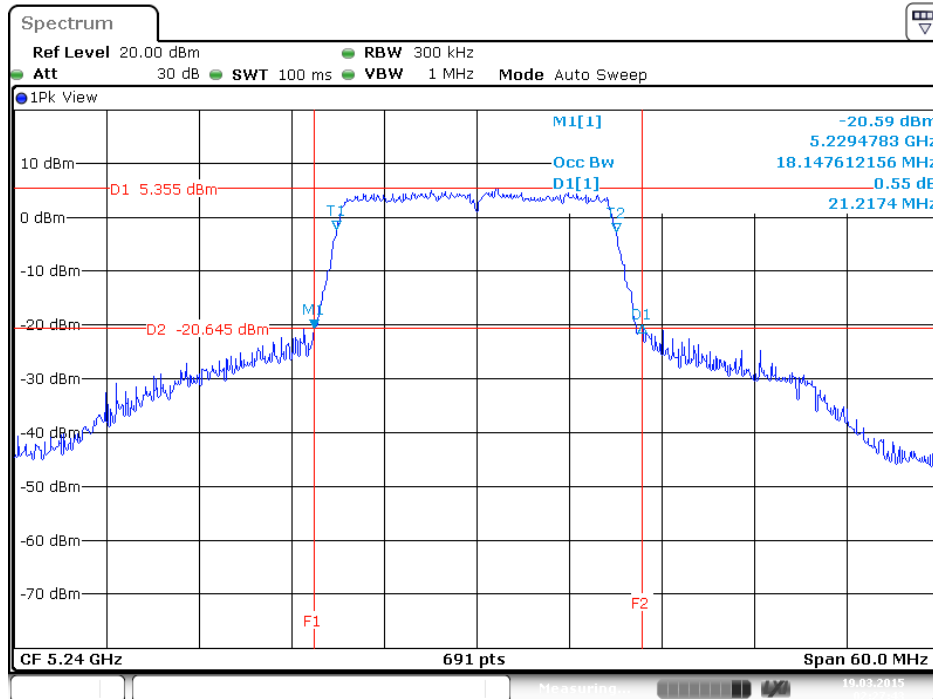

26dB Bandwidth Plot on Configuration IEEE 802.11ac 20MHz / CH 149 / MCS0 / 1S3T TXBF / Ant. 1

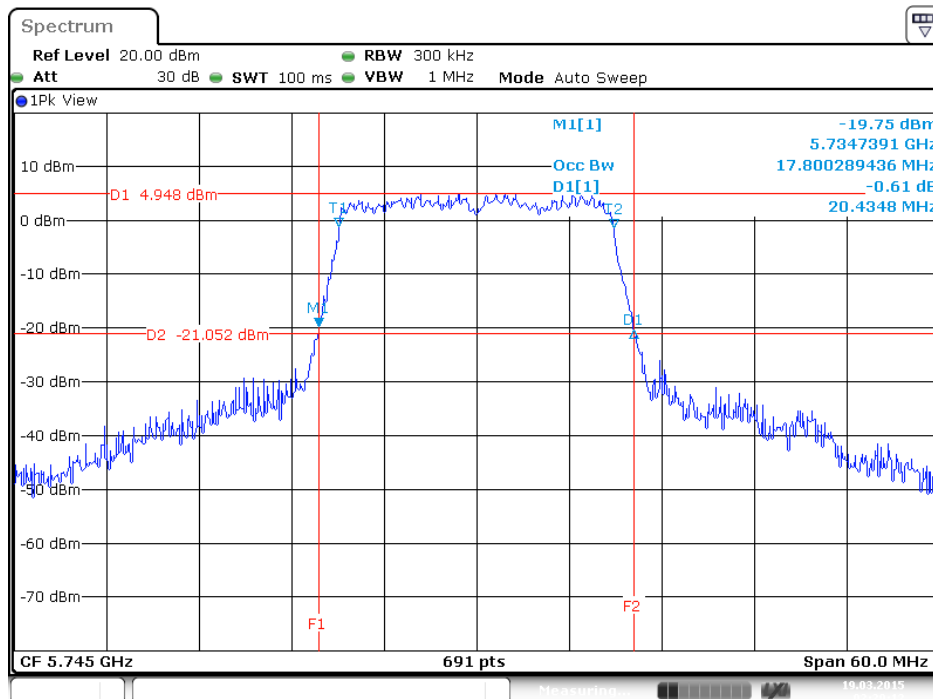

26dB Bandwidth Plot on Configuration IEEE 802.11ac 20MHz / CH 149 / MCS0 / 1S3T TXBF / Ant. 2

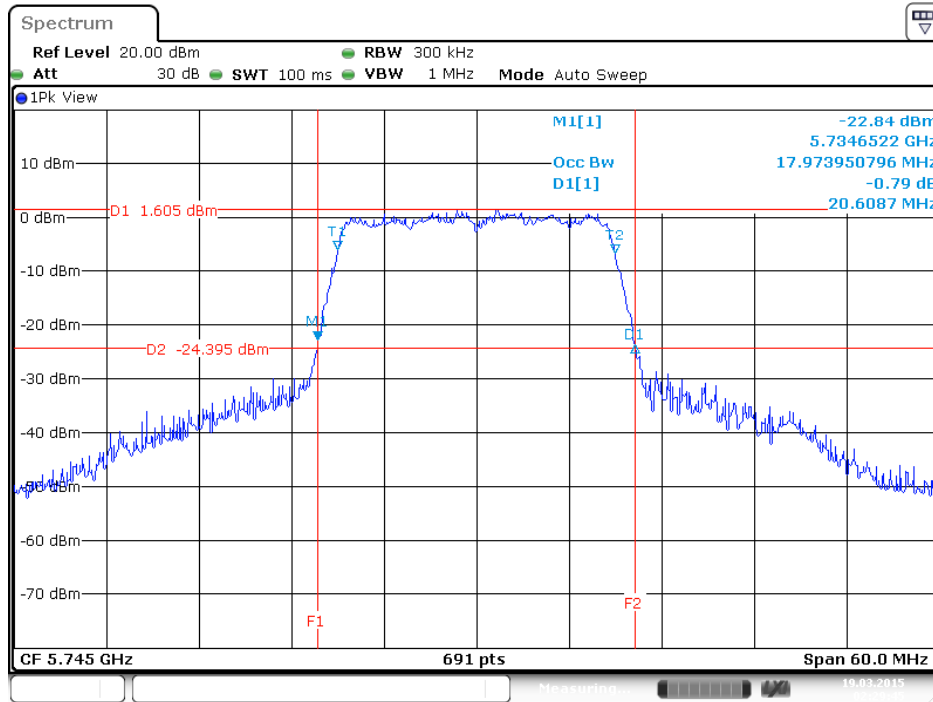

26dB Bandwidth Plot on Configuration IEEE 802.11ac 20MHz / CH 149 / MCS0 / 1S3T TXBF / Ant. 3

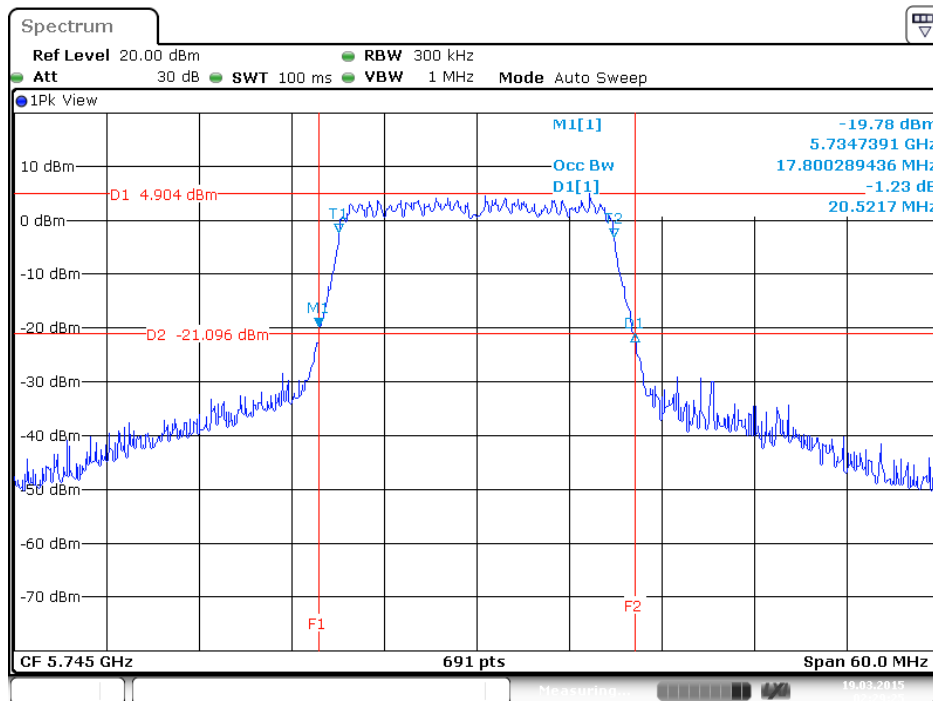

26dB Bandwidth Plot on Configuration IEEE 802.11ac 20MHz / CH 157 / MCS0 / 1S3T TXBF / Ant. 1

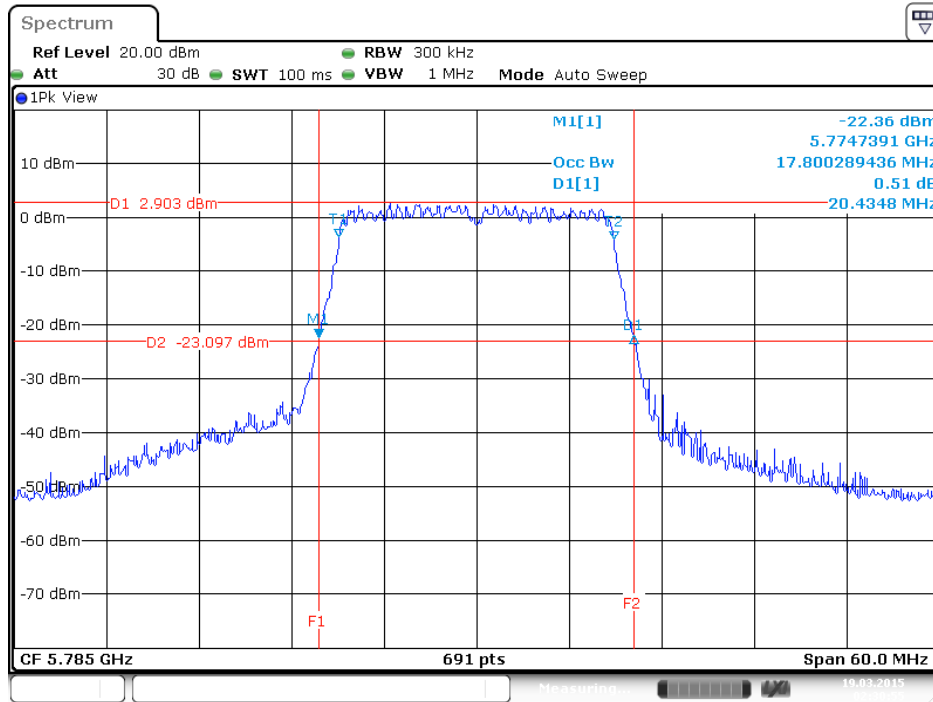

26dB Bandwidth Plot on Configuration IEEE 802.11ac 20MHz / CH 157 / MCS0 / 1S3T TXBF / Ant. 2

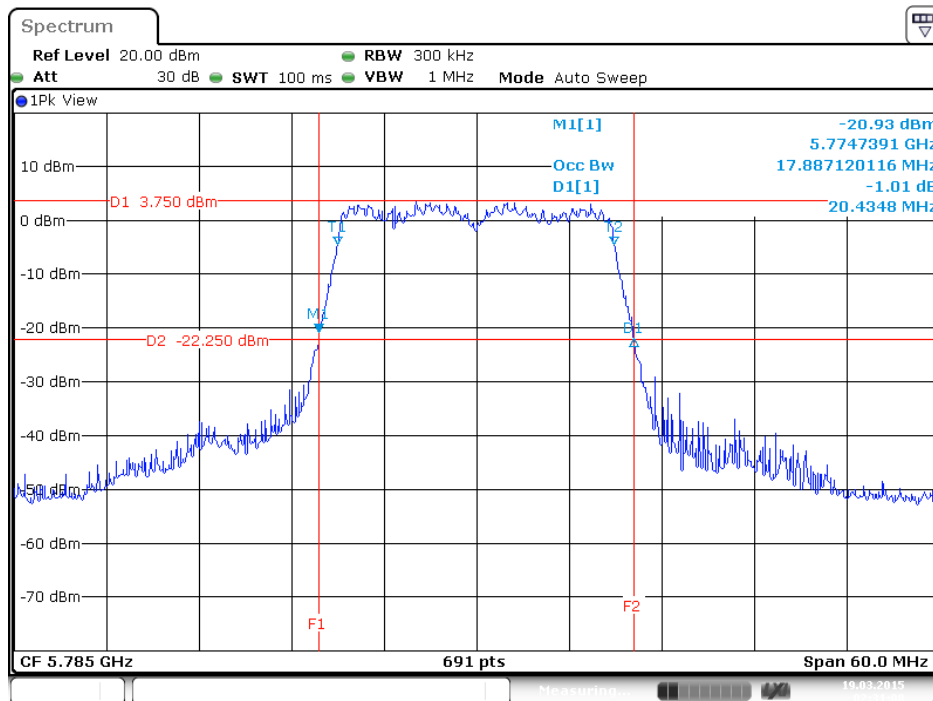

26dB Bandwidth Plot on Configuration IEEE 802.11ac 20MHz / CH 157 / MCS0 / 1S3T TXBF / Ant. 3

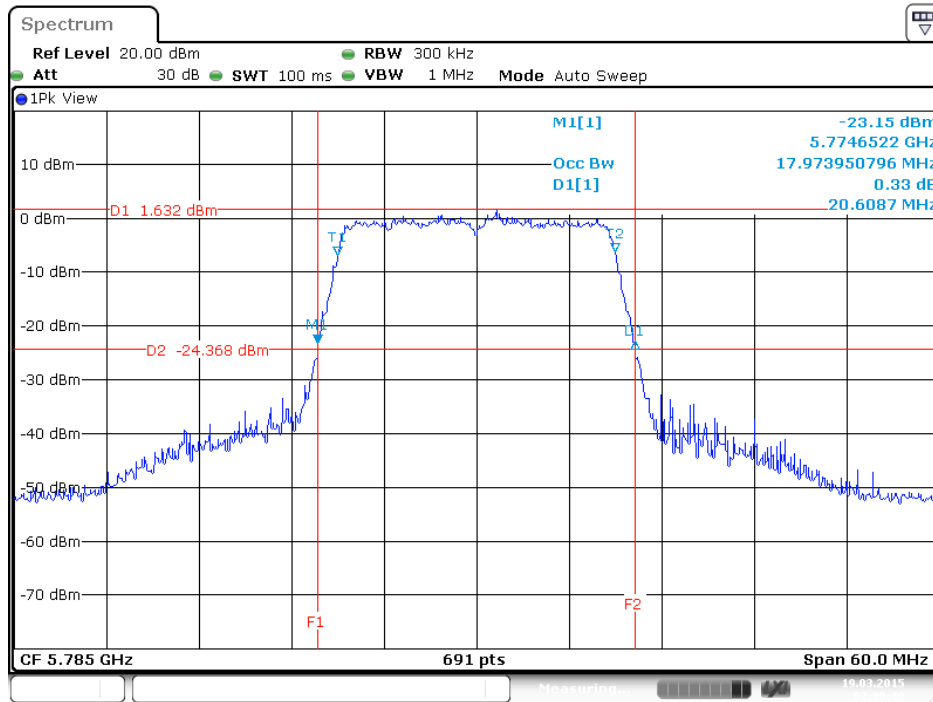

26dB Bandwidth Plot on Configuration IEEE 802.11ac 20MHz / CH 165 / MCS0 / 1S3T TXBF / Ant. 1

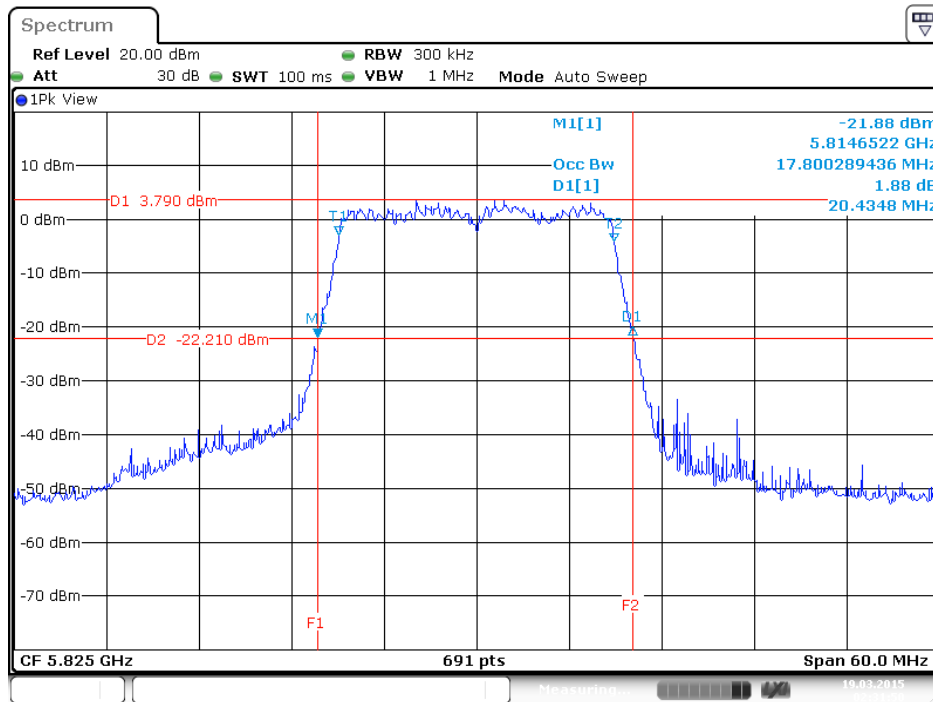

26dB Bandwidth Plot on Configuration IEEE 802.11ac 20MHz / CH 165 / MCS0 / 1S3T TXBF / Ant. 2

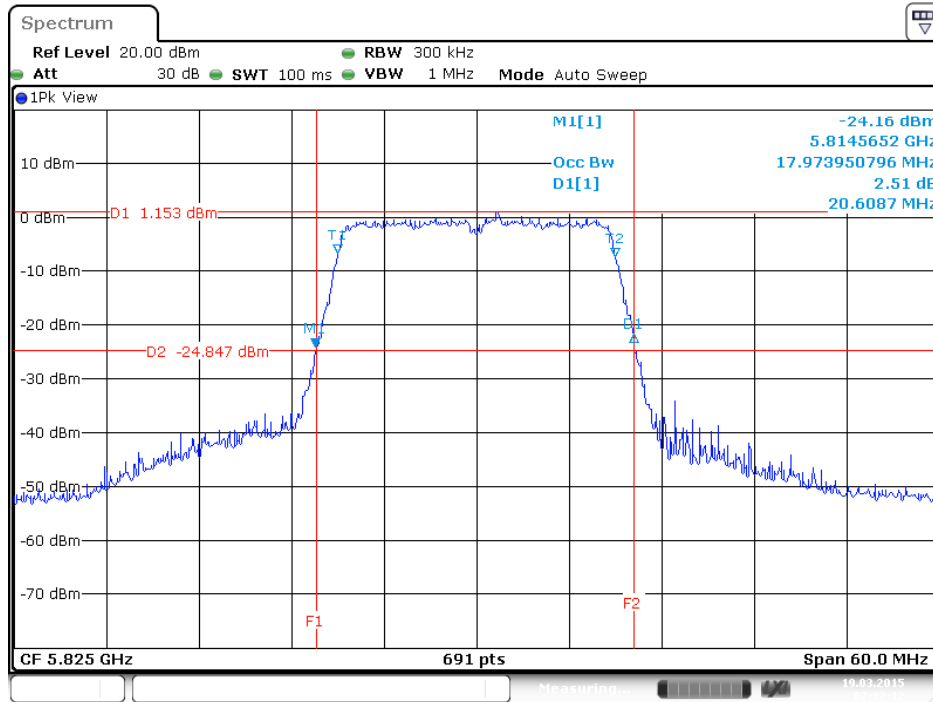

26dB Bandwidth Plot on Configuration IEEE 802.11ac 20MHz / CH 165 / MCS0 / 1S3T TXBF / Ant. 3

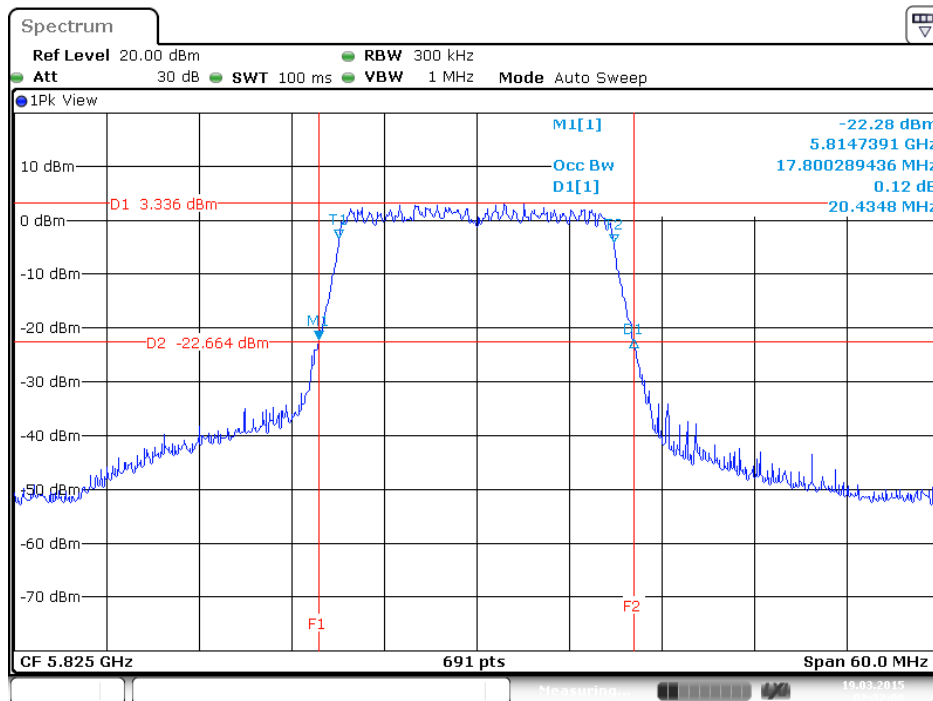

Test date	Mar. 17, 2015~Mar. 25, 2015	Test Site No.	TH01-CB
Temperature	20°C	Humidity	60%
Test Engineer	Mars Lin	Configuration	802.11ac 40MHz
Duty Cycle	<Nss1MCS0, Ant. 1>: 93.24% <Nss1MCS0, 1S3T, CDD>: 93.24% <Nss1MCS0, 1S3T, TXBF>: 90.65%		

Configuration IEEE 802.11ac 40MHz

<Nss1MCS0, Ant. 1>

Channel	Frequency	26dB Bandwidth (MHz)	99% Occupied Bandwidth (MHz)	Data Rate / MCS
38	5190 MHz	49.57	36.90	Nss1MCS0
46	5230 MHz	62.17	37.34	Nss1MCS0
151	5755 MHz	41.01	36.90	Nss1MCS0
159	5795 MHz	48.12	36.90	Nss1MCS0

<Nss1MCS0, 1S3T, CDD>

Channel	Frequency	26dB Bandwidth (MHz)			99% Occupied Bandwidth (MHz)			Data Rate / MCS
		Ant. 1	Ant. 2	Ant. 3	Ant. 1	Ant. 2	Ant. 3	
38	5190 MHz	41.01	40.44	40.15	36.76	36.76	36.76	Nss1MCS0
46	5230 MHz	40.58	40.87	40.29	36.76	36.76	36.61	Nss1MCS0
151	5755 MHz	41.45	40.58	40.29	36.76	36.76	36.76	Nss1MCS0
159	5795 MHz	40.44	52.17	41.74	36.90	36.90	36.76	Nss1MCS0

<Nss1MCS0, 1S3T, TXBF>

Channel	Frequency	26dB Bandwidth (MHz)			99% Occupied Bandwidth (MHz)			Data Rate / MCS
		Ant. 1	Ant. 2	Ant. 3	Ant. 1	Ant. 2	Ant. 3	
38	5190 MHz	40.15	40.73	41.01	36.61	36.61	36.76	Nss1MCS0
46	5230 MHz	40.73	40.29	40.15	36.76	36.61	36.61	Nss1MCS0
151	5755 MHz	40.44	40.73	41.01	36.76	36.61	36.76	Nss1MCS0
159	5795 MHz	40.87	41.01	41.01	36.76	36.90	36.90	Nss1MCS0

<Nss1MCS0, Ant. 1>:

26dB Bandwidth Plot on Configuration IEEE 802.11ac 40MHz / CH 38 / Ant. 1

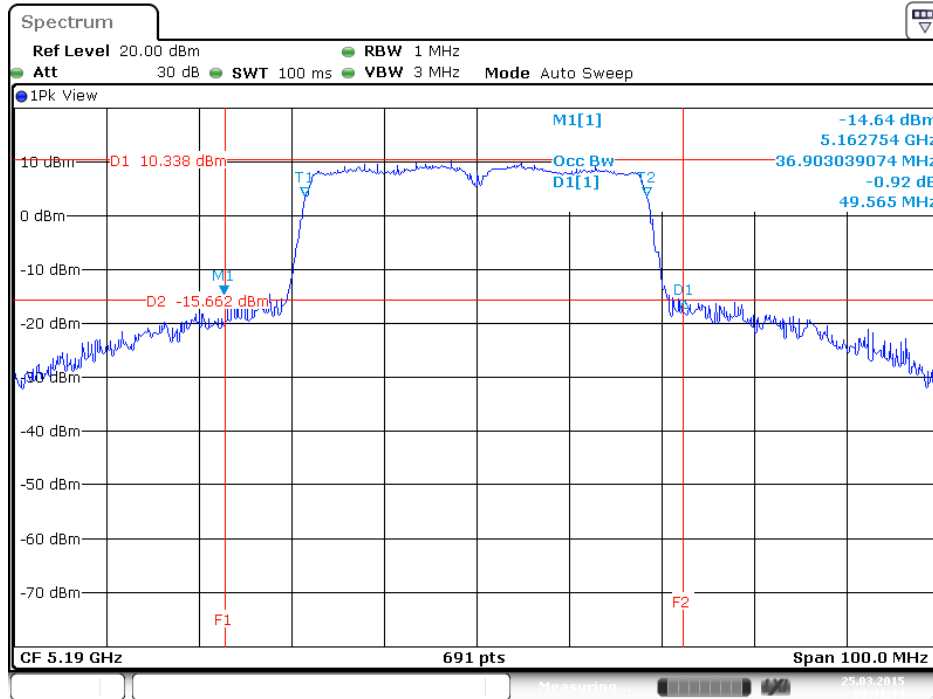

Date: 25 MAR 2015 00:41:34

26dB Bandwidth Plot on Configuration IEEE 802.11ac 40MHz / CH 46 / Ant. 1

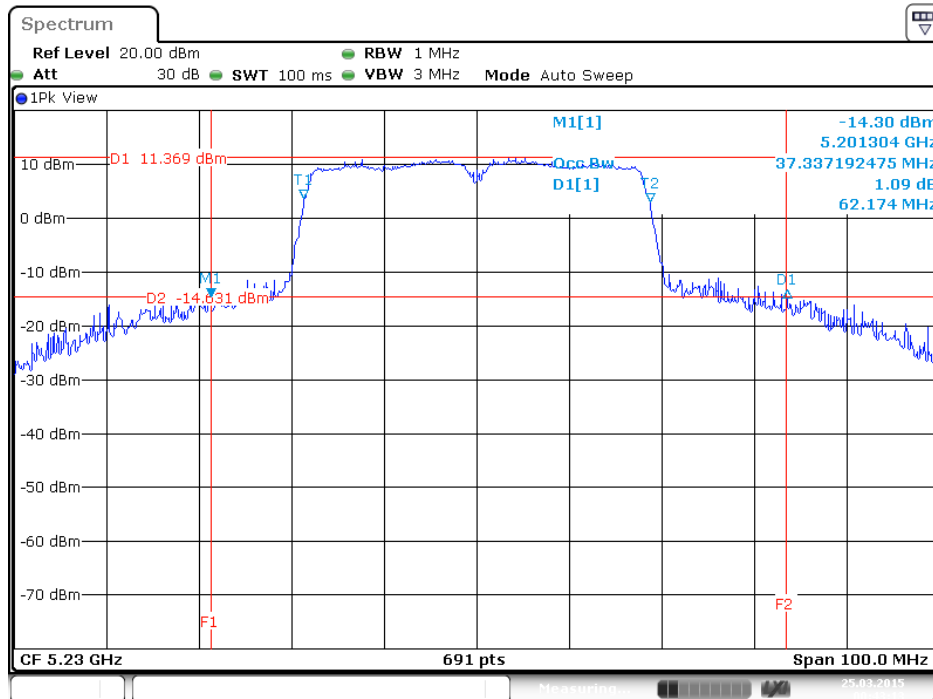

Date: 25 MAR 2015 00:43:13

26dB Bandwidth Plot on Configuration IEEE 802.11ac 40MHz / CH 151 / Ant. 1

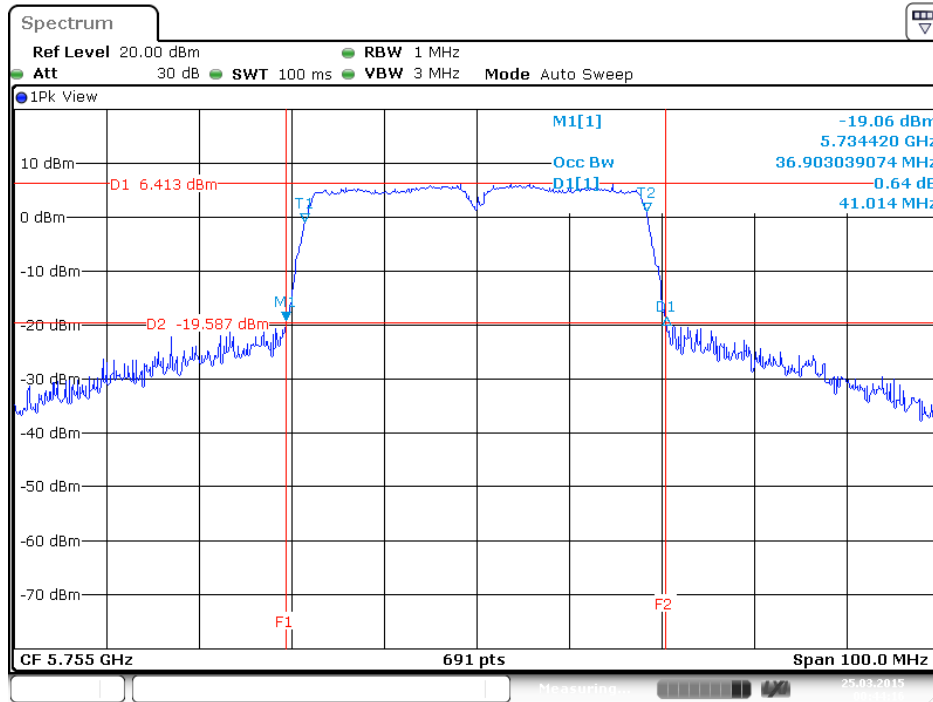

26dB Bandwidth Plot on Configuration IEEE 802.11ac 40MHz / CH 151 / Ant. 1

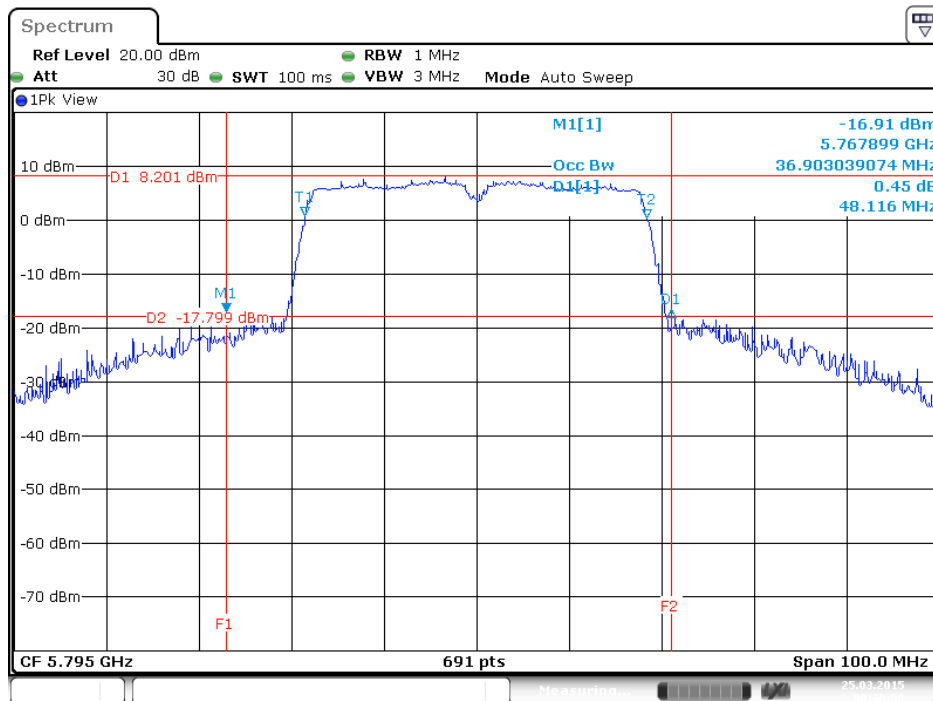

<Nss1MCS0, 1S3T, CDD>:

26dB Bandwidth Plot on Configuration IEEE 802.11ac 40MHz / CH 38 / MCS0 / 1S3T CDD / Ant. 1

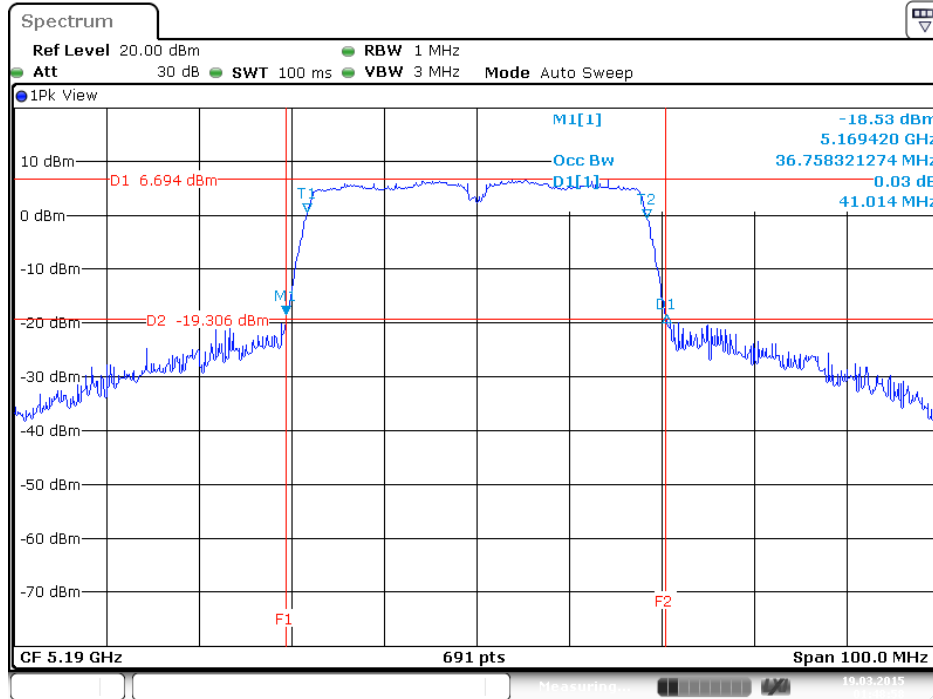

26dB Bandwidth Plot on Configuration IEEE 802.11ac 40MHz / CH 38 / MCS0 / 1S3T CDD / Ant. 2

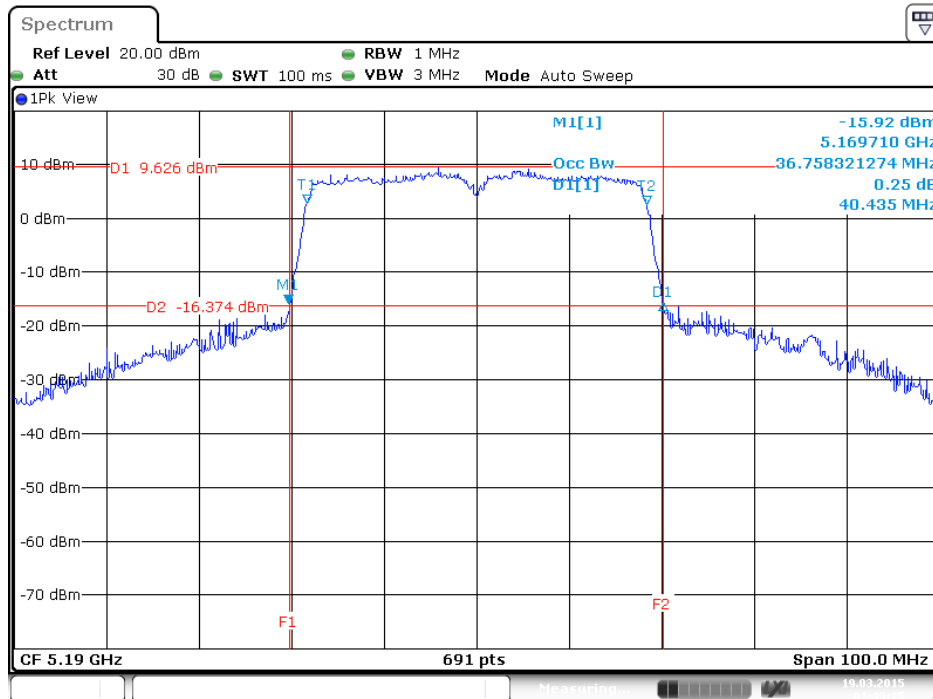

26dB Bandwidth Plot on Configuration IEEE 802.11ac 40MHz / CH 38 / MCS0 / 1S3T CDD / Ant. 3

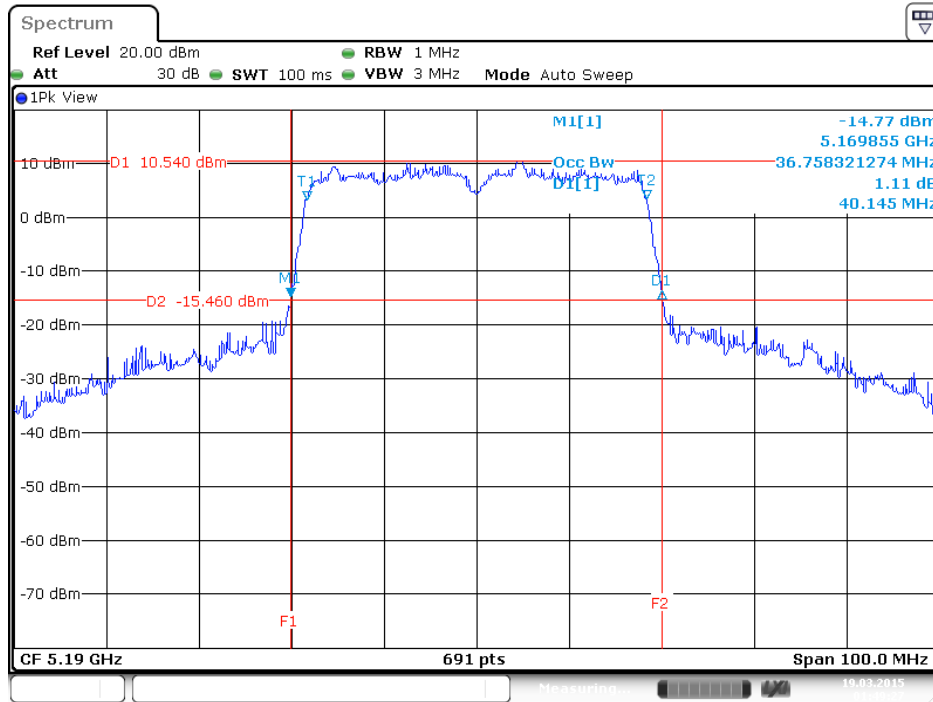

26dB Bandwidth Plot on Configuration IEEE 802.11ac 40MHz / CH 46 / MCS0 / 1S3T CDD / Ant. 1

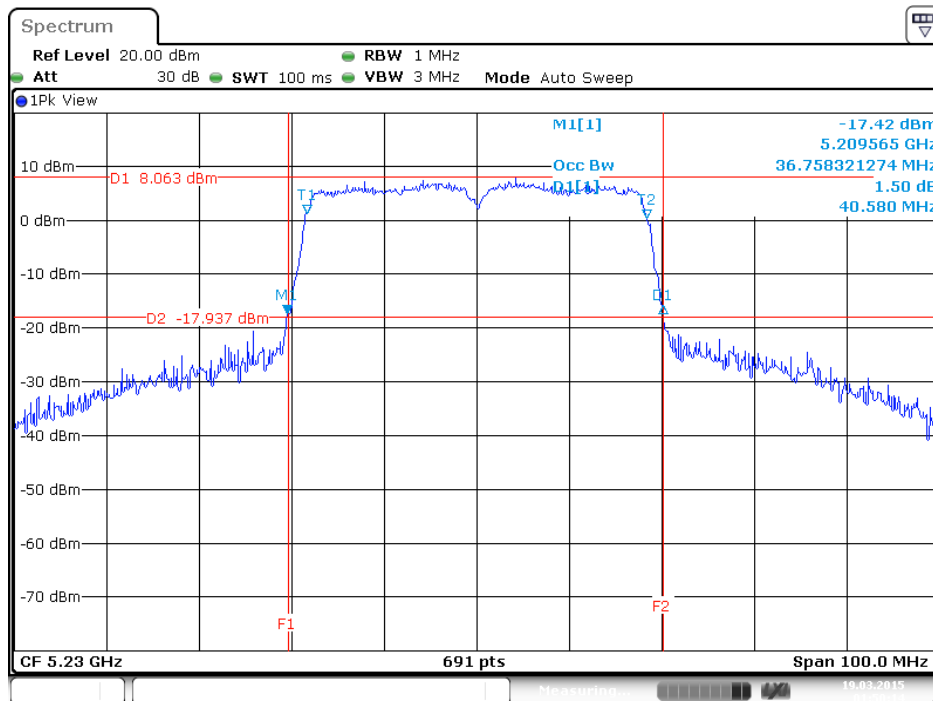

26dB Bandwidth Plot on Configuration IEEE 802.11ac 40MHz / CH 46 / MCS0 / 1S3T CDD / Ant. 2

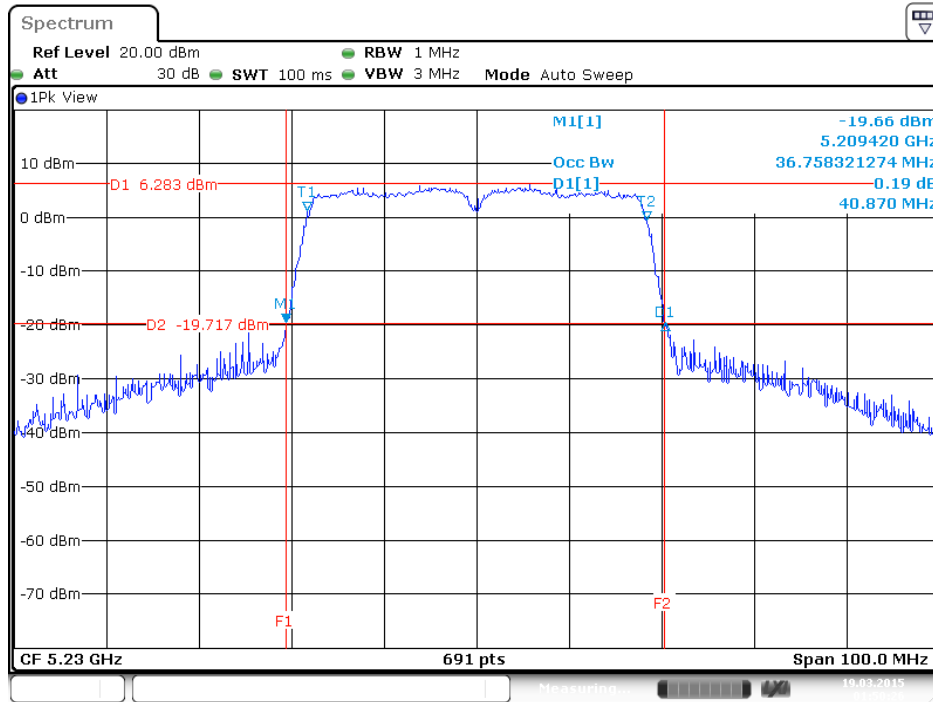

26dB Bandwidth Plot on Configuration IEEE 802.11ac 40MHz / CH 46 / MCS0 / 1S3T CDD / Ant. 3

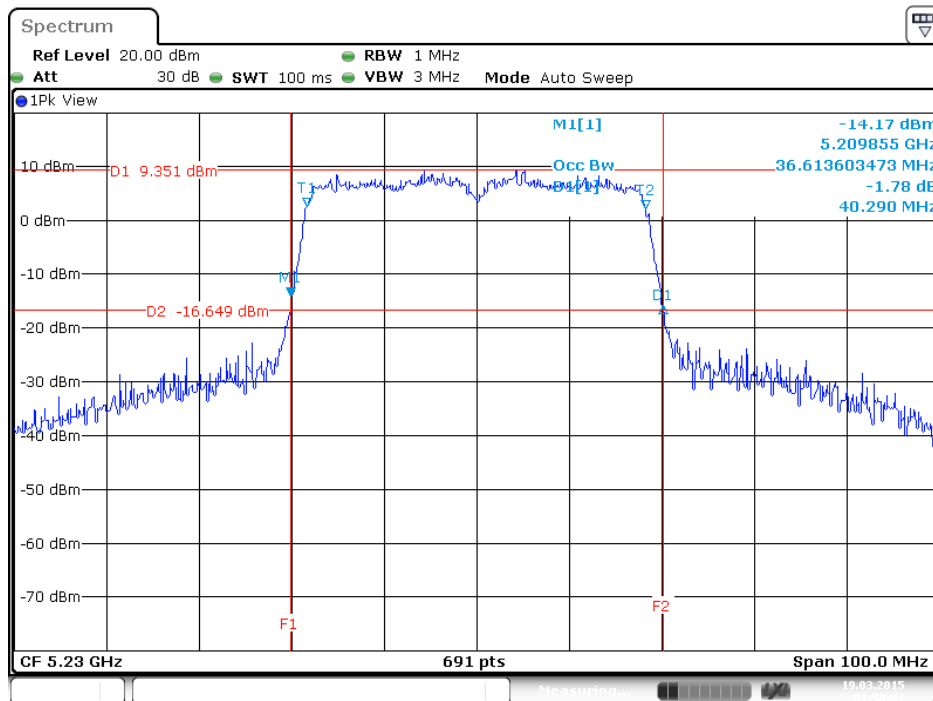

26dB Bandwidth Plot on Configuration IEEE 802.11ac 40MHz / CH 151 / MCS0 / 1S3T CDD / Ant. 1

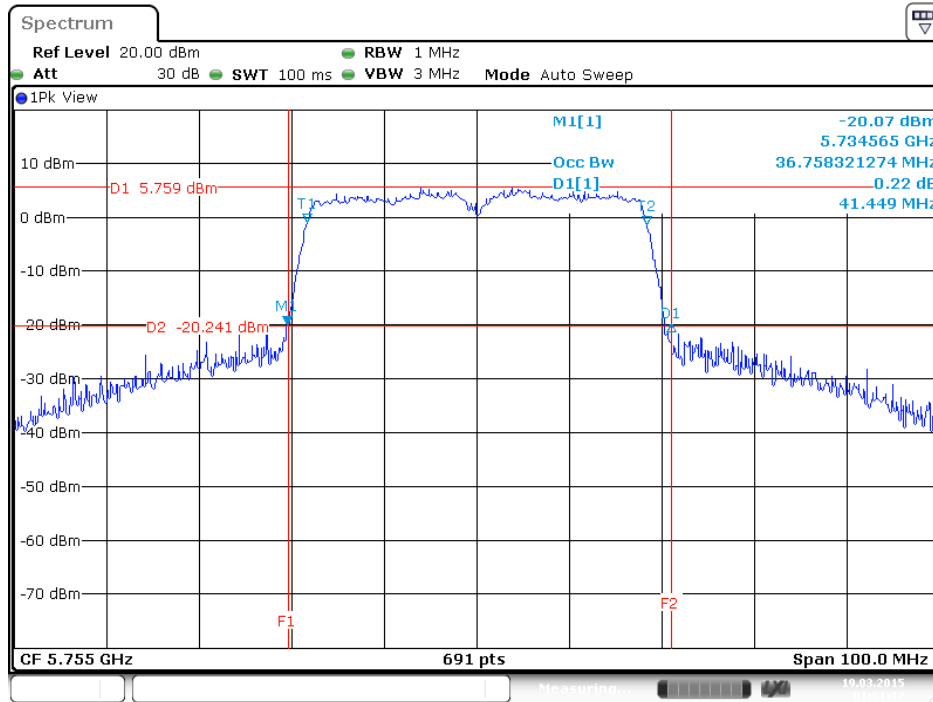

26dB Bandwidth Plot on Configuration IEEE 802.11ac 40MHz / CH 151 / MCS0 / 1S3T CDD / Ant. 2

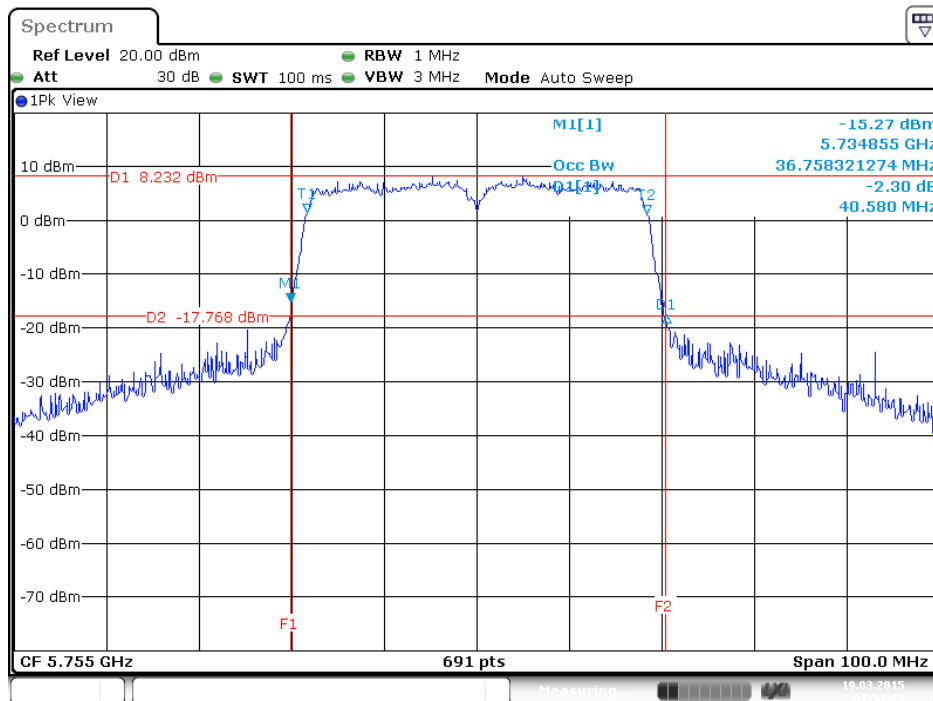

26dB Bandwidth Plot on Configuration IEEE 802.11ac 40MHz / CH 151 / MCS0 / 1S3T CDD / Ant. 3

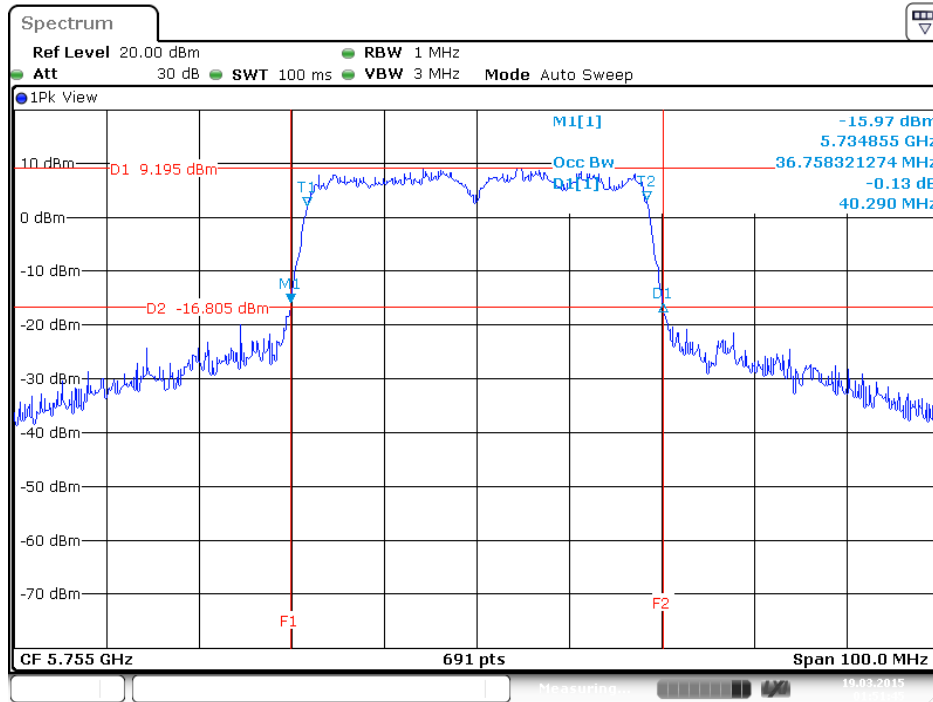

26dB Bandwidth Plot on Configuration IEEE 802.11ac 40MHz / CH 159 / MCS0 / 1S3T CDD / Ant. 1

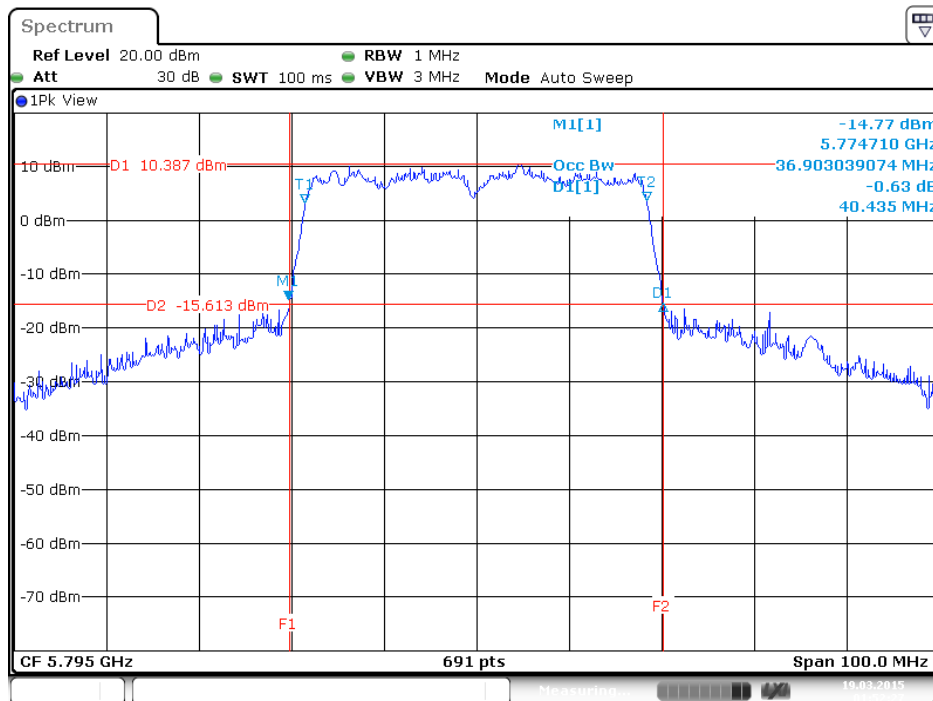

26dB Bandwidth Plot on Configuration IEEE 802.11ac 40MHz / CH 159 / MCS0 / 1S3T CDD / Ant. 2

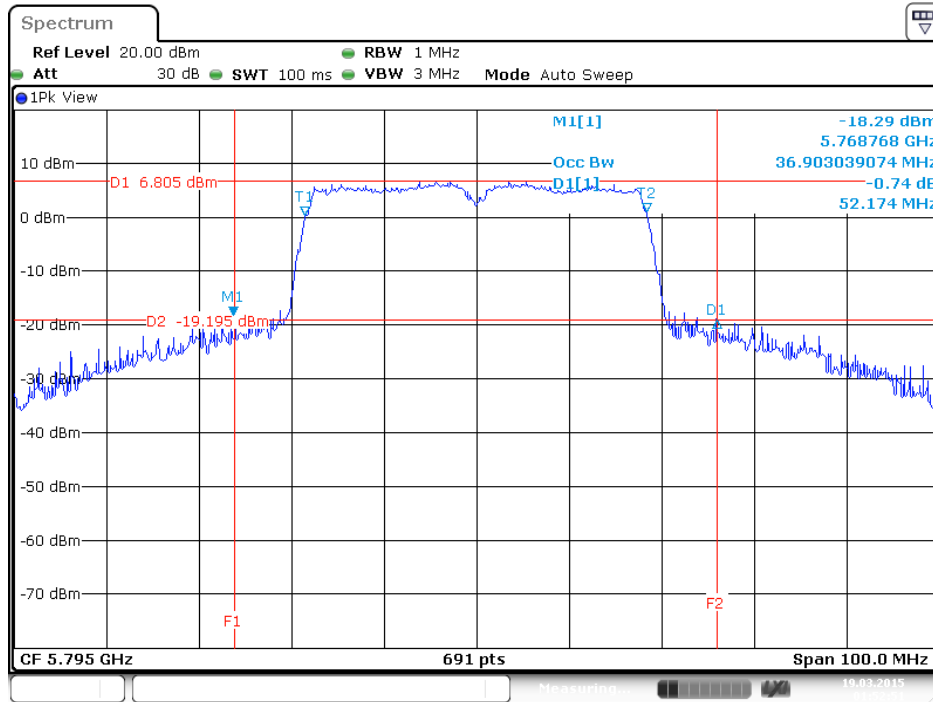

26dB Bandwidth Plot on Configuration IEEE 802.11ac 40MHz / CH 159 / MCS0 / 1S3T CDD / Ant. 3

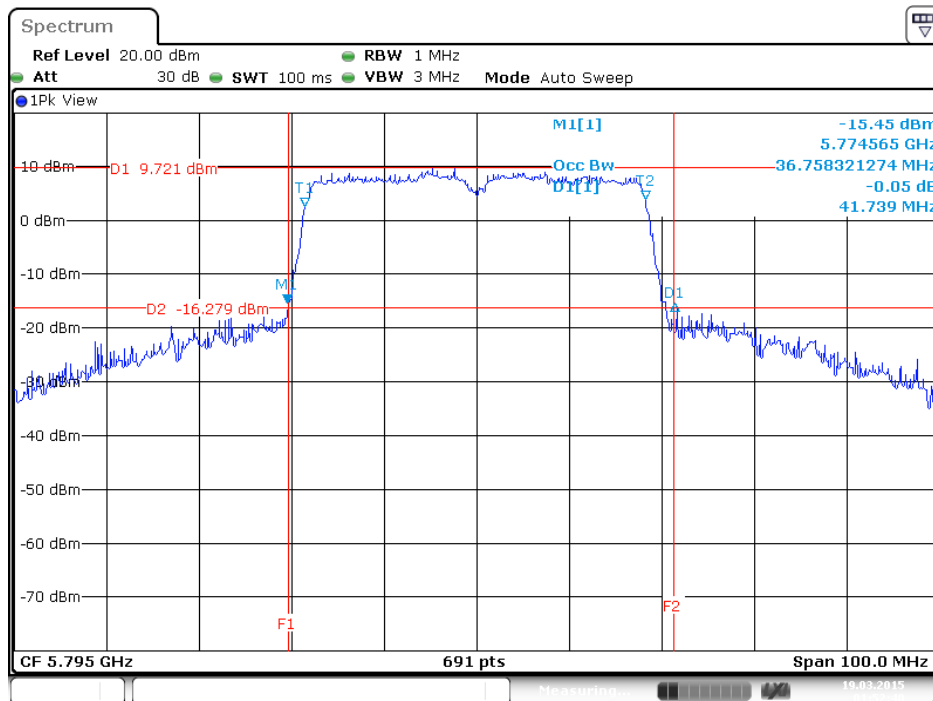

<Nss1MCS0, 1S3T, TXBF>:

26dB Bandwidth Plot on Configuration IEEE 802.11ac 40MHz / CH 38 / MCS0 / 1S3T TXBF / Ant. 1

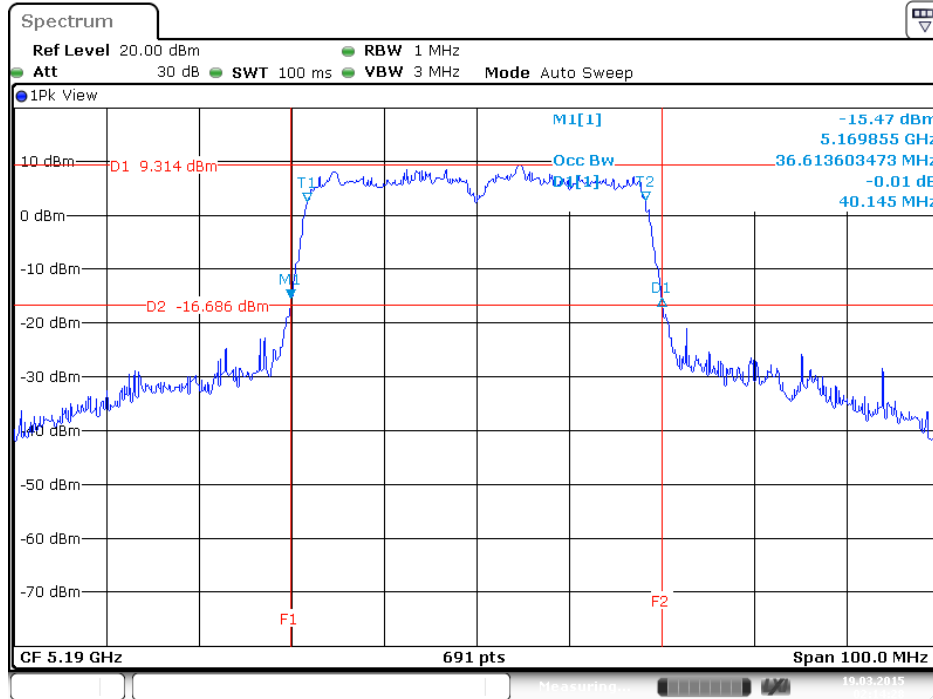

26dB Bandwidth Plot on Configuration IEEE 802.11ac 40MHz / CH 38 / MCS0 / 1S3T TXBF / Ant. 2

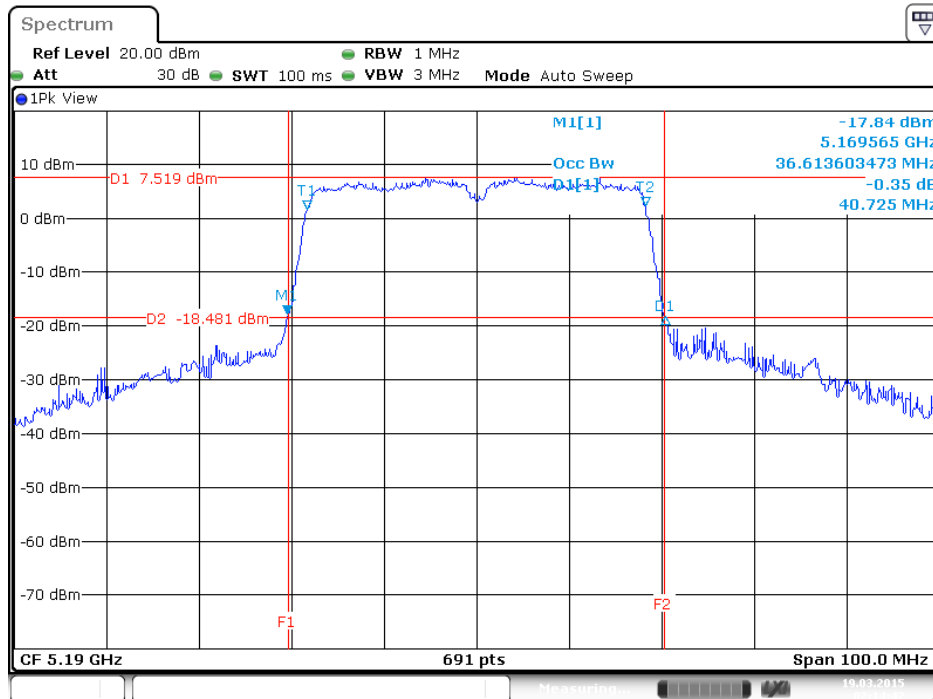

26dB Bandwidth Plot on Configuration IEEE 802.11ac 40MHz / CH 38 / MCS0 / 1S3T TXBF / Ant. 3

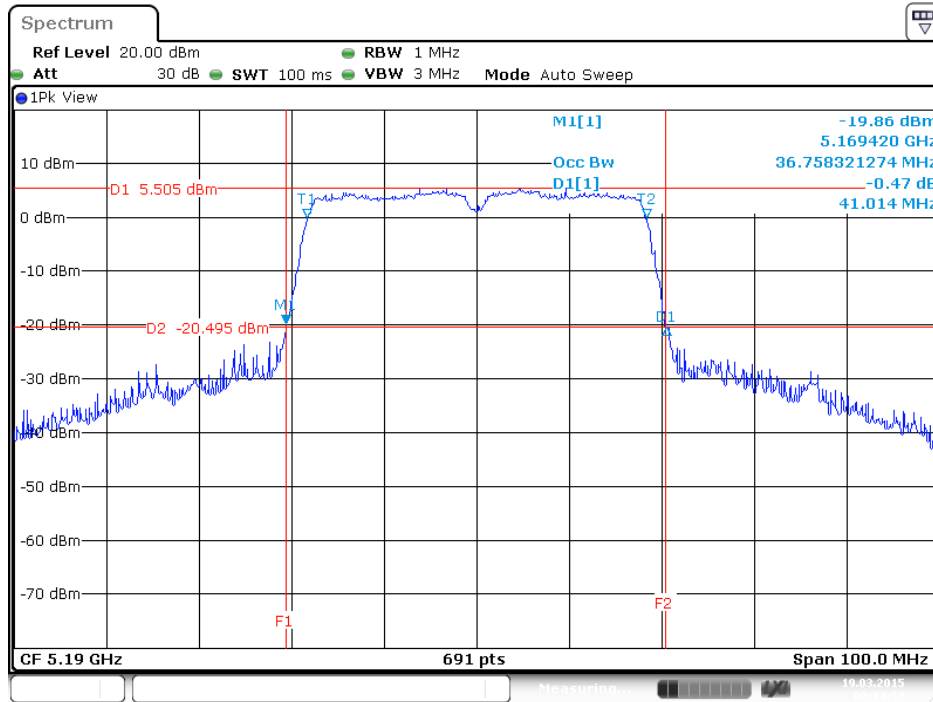

26dB Bandwidth Plot on Configuration IEEE 802.11ac 40MHz / CH 46 / MCS0 / 1S3T TXBF / Ant. 1

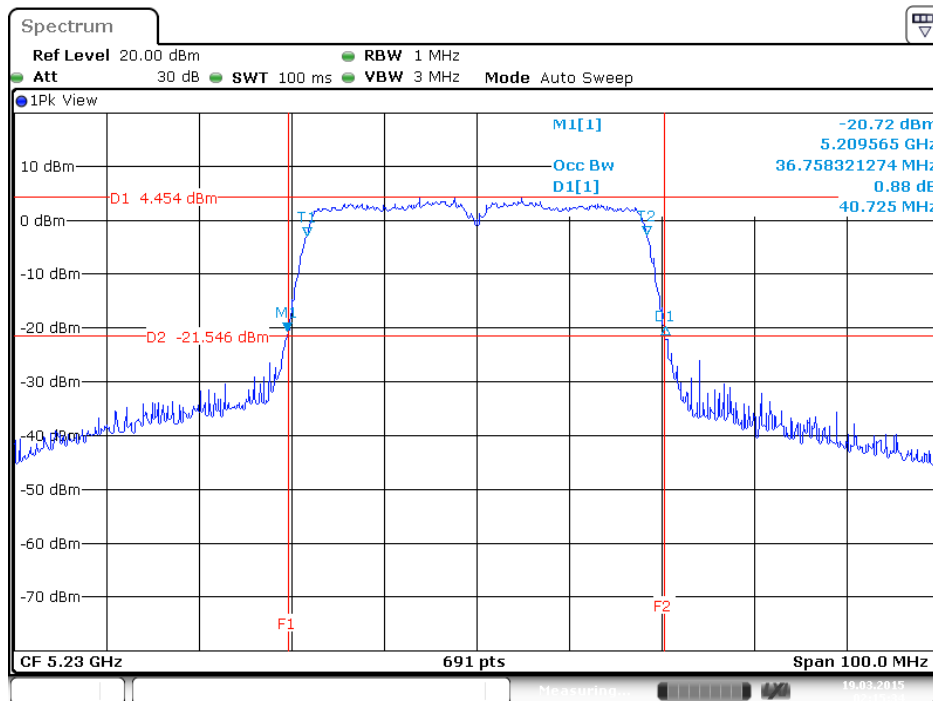

26dB Bandwidth Plot on Configuration IEEE 802.11ac 40MHz / CH 46 / MCS0 / 1S3T TXBF / Ant. 2

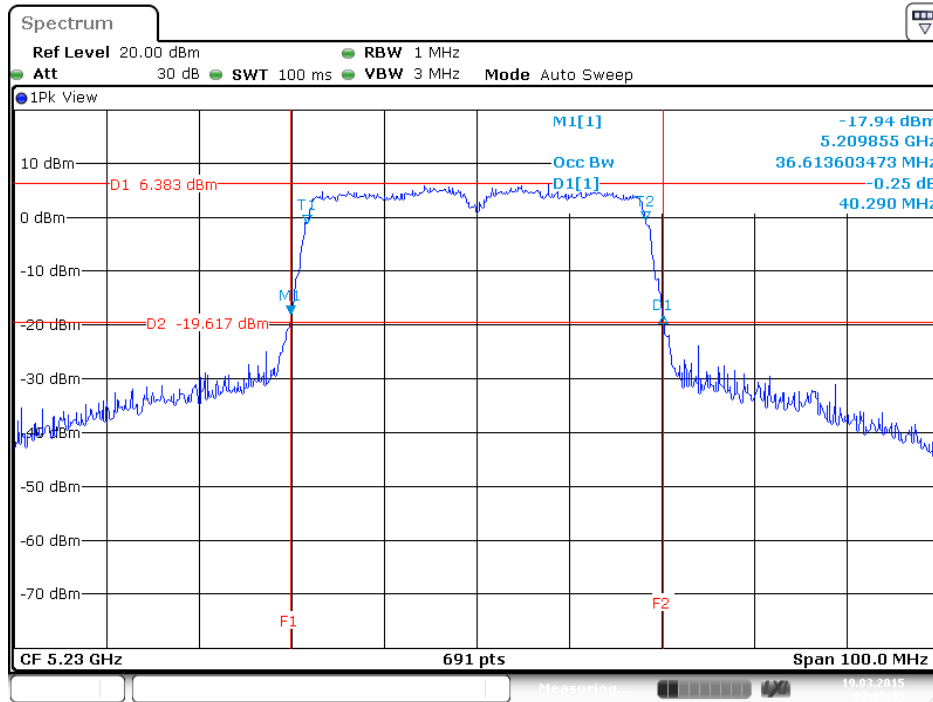

26dB Bandwidth Plot on Configuration IEEE 802.11ac 40MHz / CH 46 / MCS0 / 1S3T TXBF / Ant. 3

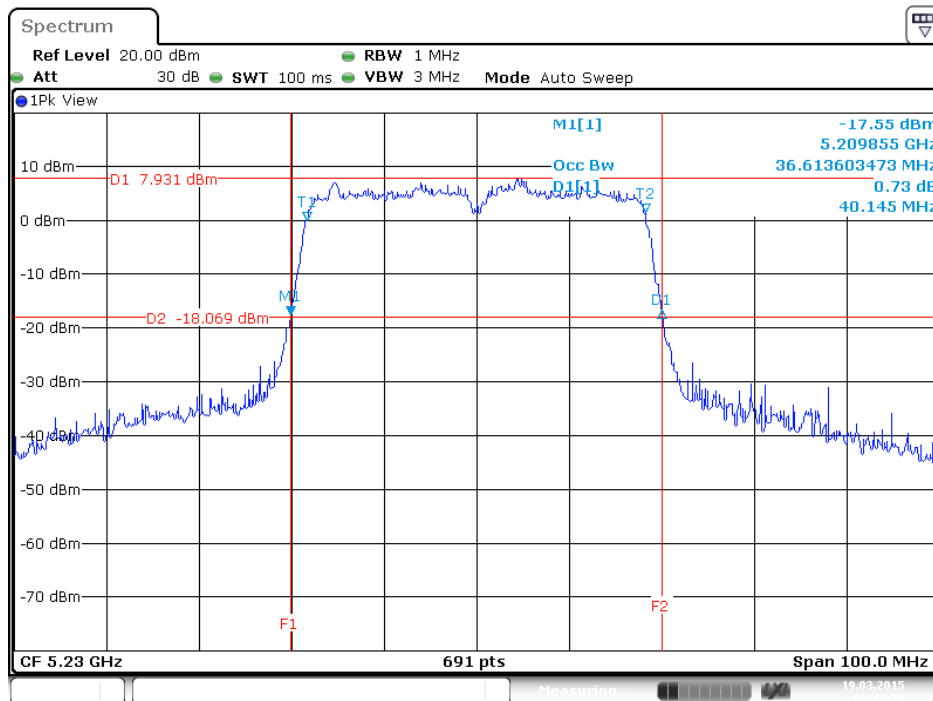

26dB Bandwidth Plot on Configuration IEEE 802.11ac 40MHz / CH 151 / MCS0 / 1S3T TXBF / Ant. 1

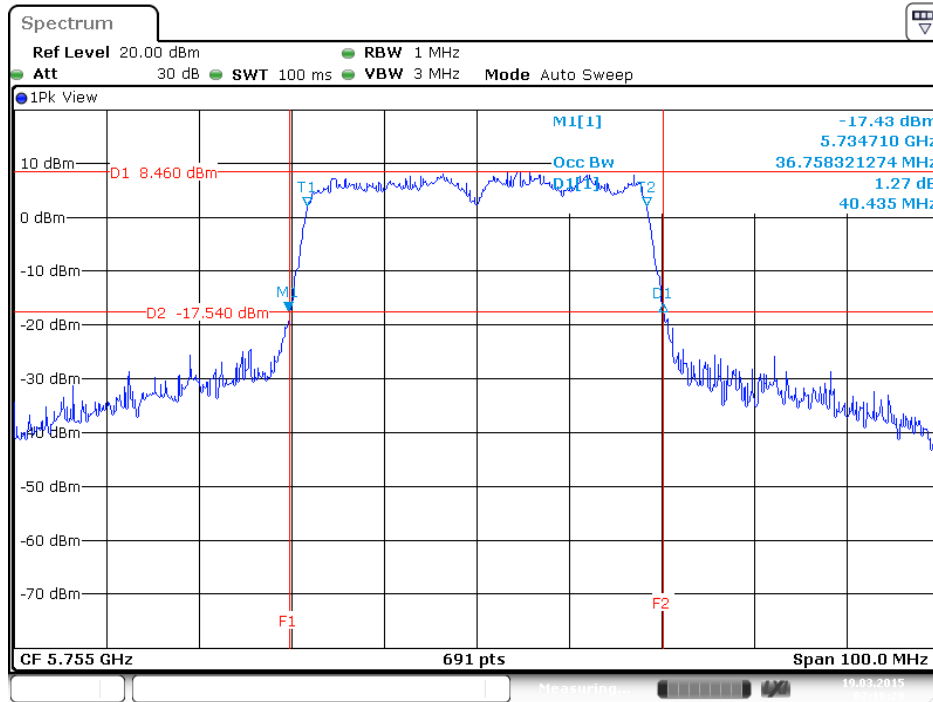

Date: 19 MAR 2015 02:16:28

26dB Bandwidth Plot on Configuration IEEE 802.11ac 40MHz / CH 151 / MCS0 / 1S3T TXBF / Ant. 2

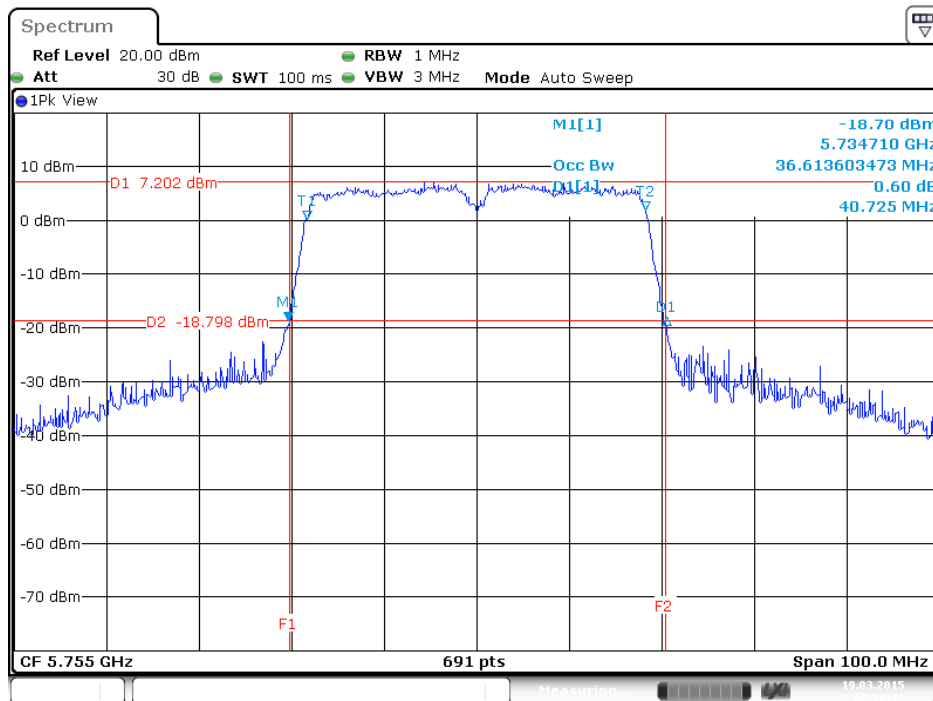

Date: 19 MAR 2015 02:16:42

26dB Bandwidth Plot on Configuration IEEE 802.11ac 40MHz / CH 151 / MCS0 / 1S3T TXBF / Ant. 3

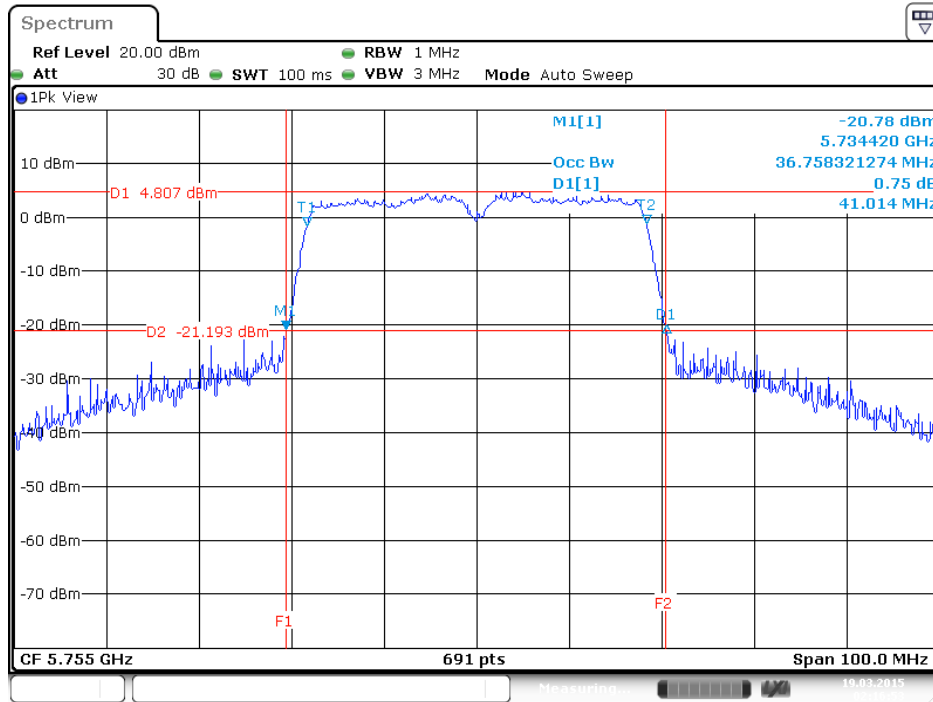

26dB Bandwidth Plot on Configuration IEEE 802.11ac 40MHz / CH 159 / MCS0 / 1S3T TXBF / Ant. 1

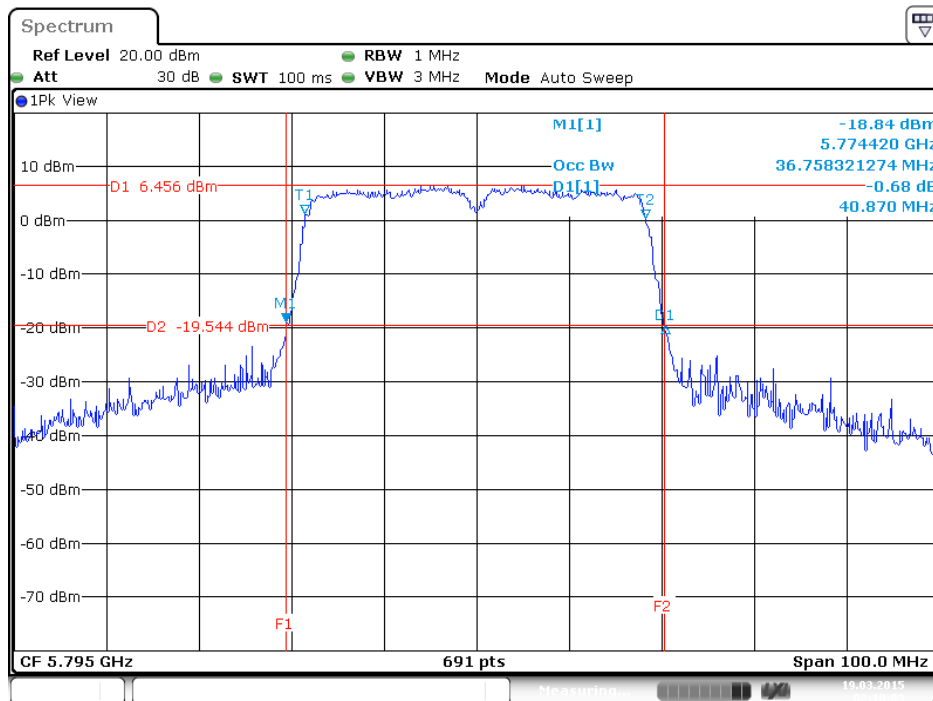

26dB Bandwidth Plot on Configuration IEEE 802.11ac 40MHz / CH 159 / MCS0 / 1S3T TXBF / Ant. 2

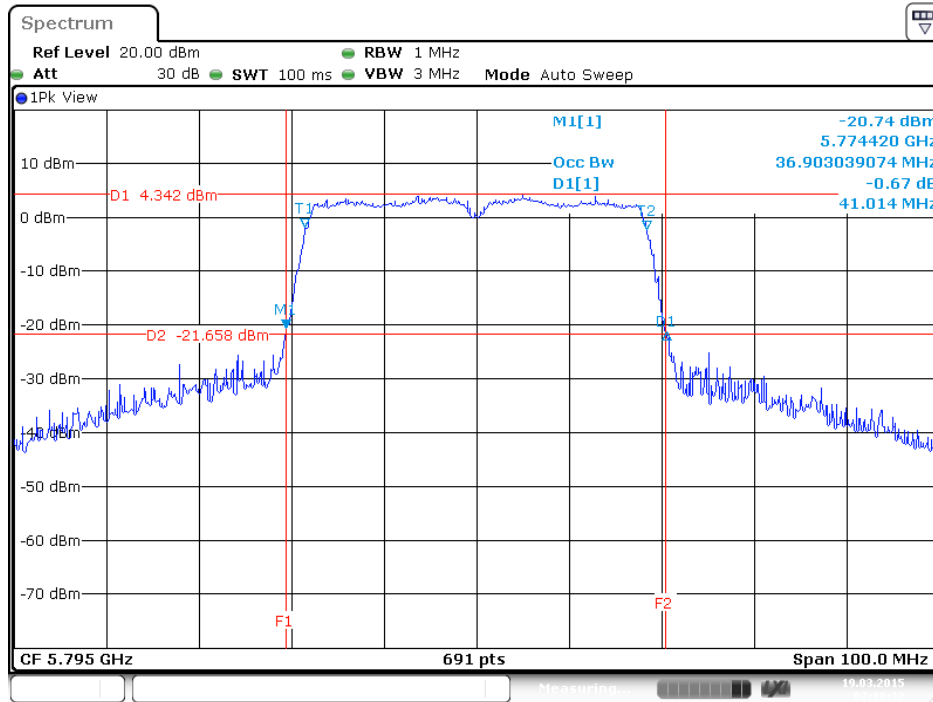

26dB Bandwidth Plot on Configuration IEEE 802.11ac 40MHz / CH 159 / MCS0 / 1S3T TXBF / Ant. 3

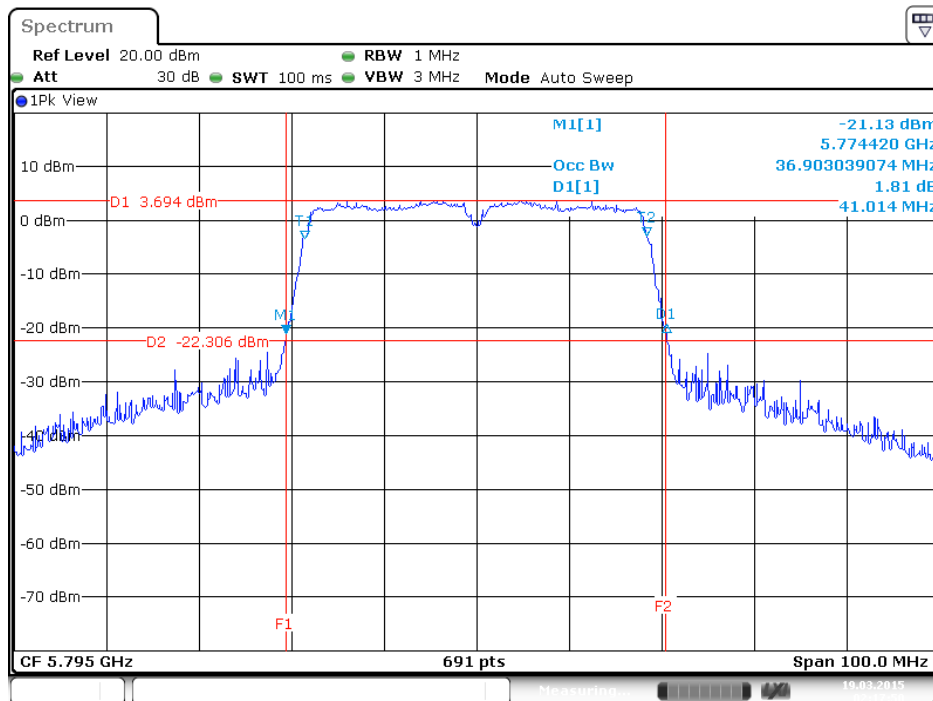

Test date	Mar. 17, 2015~Mar. 25, 2015	Test Site No.	TH01-CB
Temperature	20°C	Humidity	60%
Test Engineer	Mars Lin	Configuration	802.11ac 80MHz
Duty Cycle	<Nss1MCS0, Ant. 1>: 87.12% <Nss1MCS0, 1S3T, CDD>: 87.12% <Nss1MCS0, 1S3T, TXBF>: 79.93%		

Configuration IEEE 802.11ac 80MHz

<Nss1MCS0, Ant. 1>

Channel	Frequency	26dB Bandwidth (MHz)	99% Occupied Bandwidth (MHz)	Data Rate / MCS
42	5210 MHz	82.61	75.83	Nss1MCS0
155	5775 MHz	82.61	75.83	Nss1MCS0

<Nss1MCS0, 1S3T, CDD>

Channel	Frequency	26dB Bandwidth (MHz)			99% Occupied Bandwidth (MHz)			Data Rate / MCS
		Ant. 1	Ant. 2	Ant. 3	Ant. 1	Ant. 2	Ant. 3	
42	5210 MHz	82.32	81.74	82.61	75.83	75.83	75.83	Nss1MCS0
155	5775 MHz	81.74	82.32	82.61	75.83	75.83	75.83	Nss1MCS0

<Nss1MCS0, 1S3T, TXBF>

Channel	Frequency	26dB Bandwidth (MHz)			99% Occupied Bandwidth (MHz)			Data Rate / MCS
		Ant. 1	Ant. 2	Ant. 3	Ant. 1	Ant. 2	Ant. 3	
42	5210 MHz	82.90	82.03	81.74	75.83	75.83	75.83	Nss1MCS0
155	5775 MHz	82.61	82.03	82.90	75.83	75.83	75.83	Nss1MCS0

<Nss1MCS0, Ant. 1>:

26dB Bandwidth Plot on Configuration IEEE 802.11ac 80MHz / CH 42 / Ant. 1

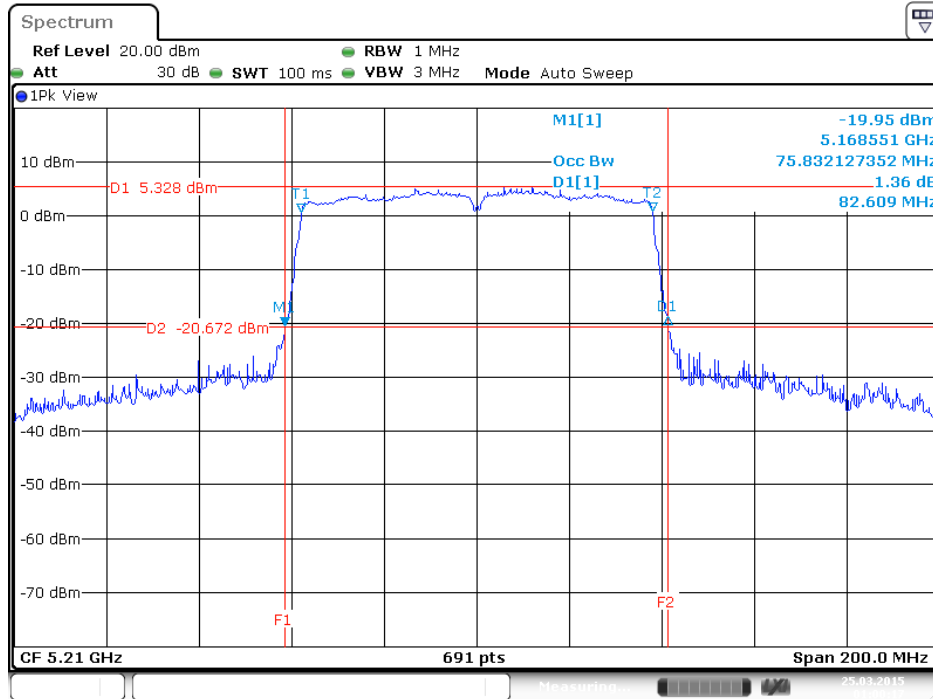

26dB Bandwidth Plot on Configuration IEEE 802.11ac 80MHz / CH 155 / Ant. 1

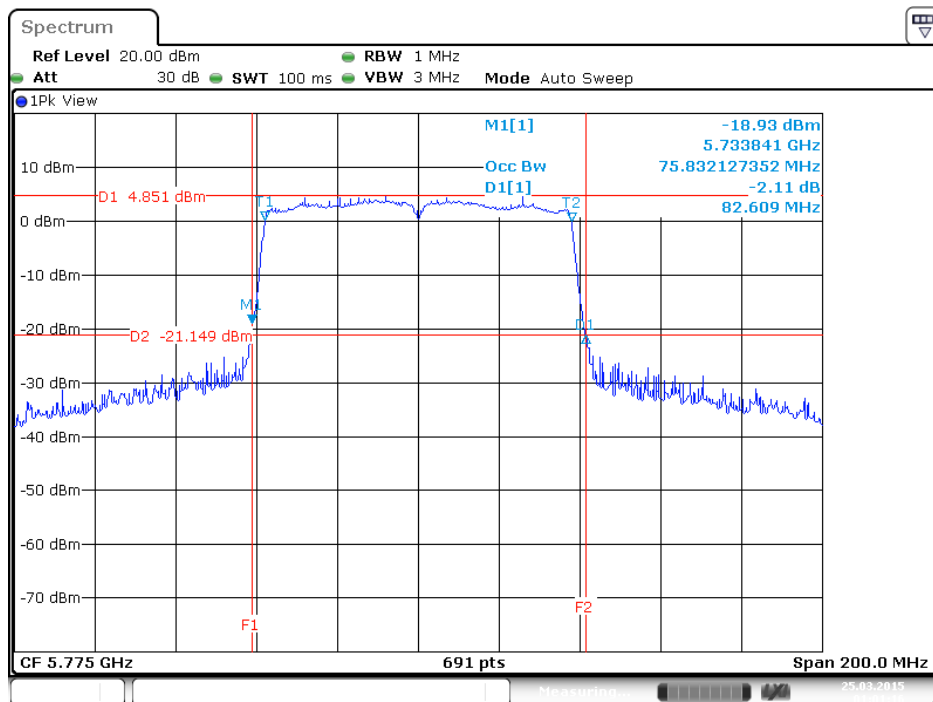

<Nss1MCS0, 1S3T, CDD>:

26dB Bandwidth Plot on Configuration IEEE 802.11ac 80MHz / CH 42 / MCS0 / 1S3T CDD / Ant. 1

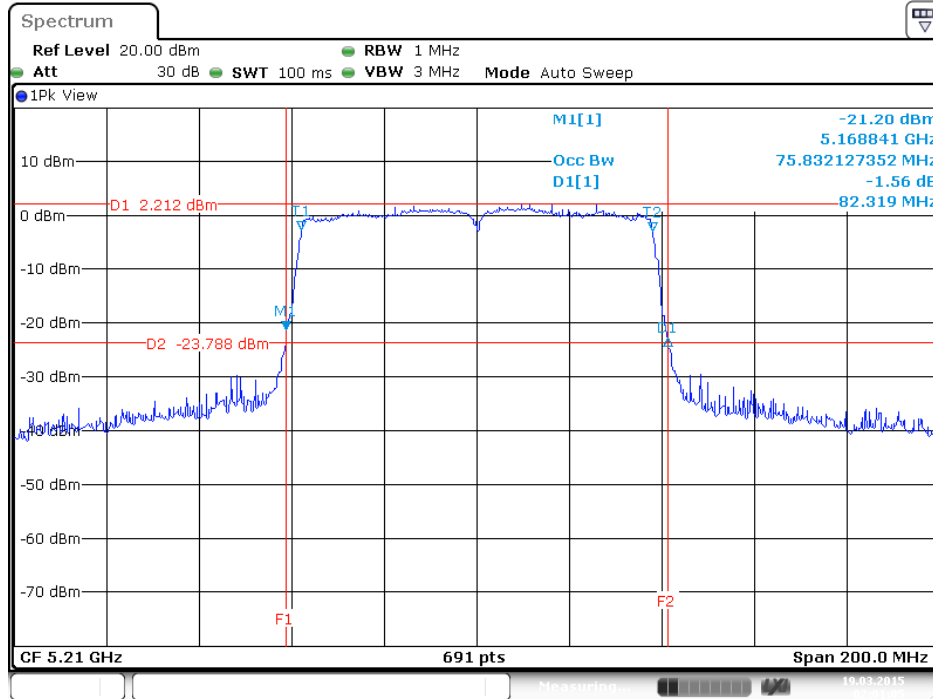

Date: 19 MAR 2015 02:01:05

26dB Bandwidth Plot on Configuration IEEE 802.11ac 80MHz / CH 42 / MCS0 / 1S3T CDD / Ant. 2

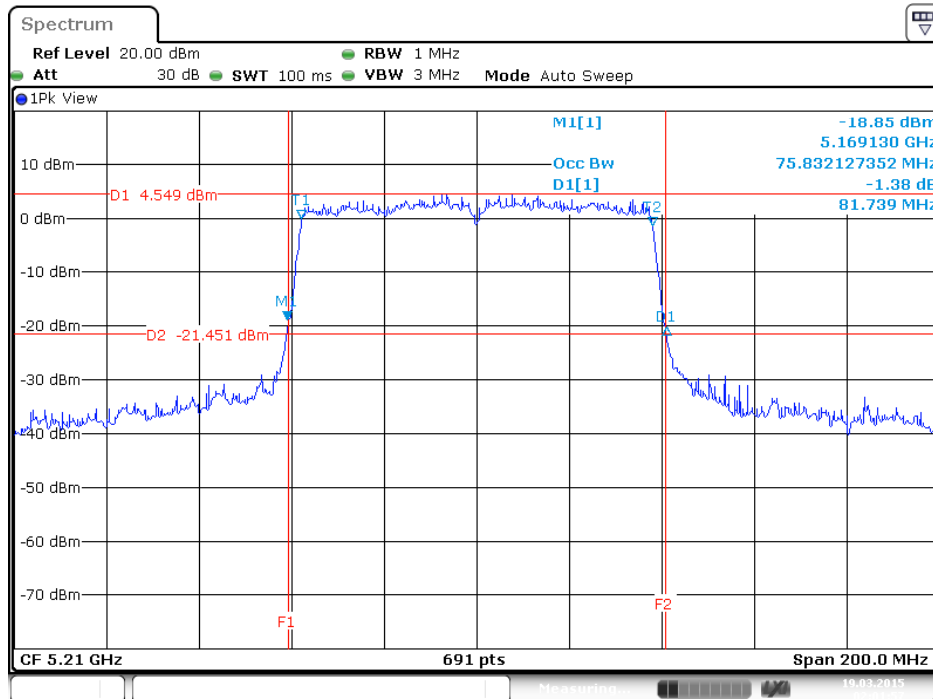

Date: 19 MAR 2015 02:01:07

26dB Bandwidth Plot on Configuration IEEE 802.11ac 80MHz / CH 42 / MCS0 / 1S3T CDD / Ant. 3

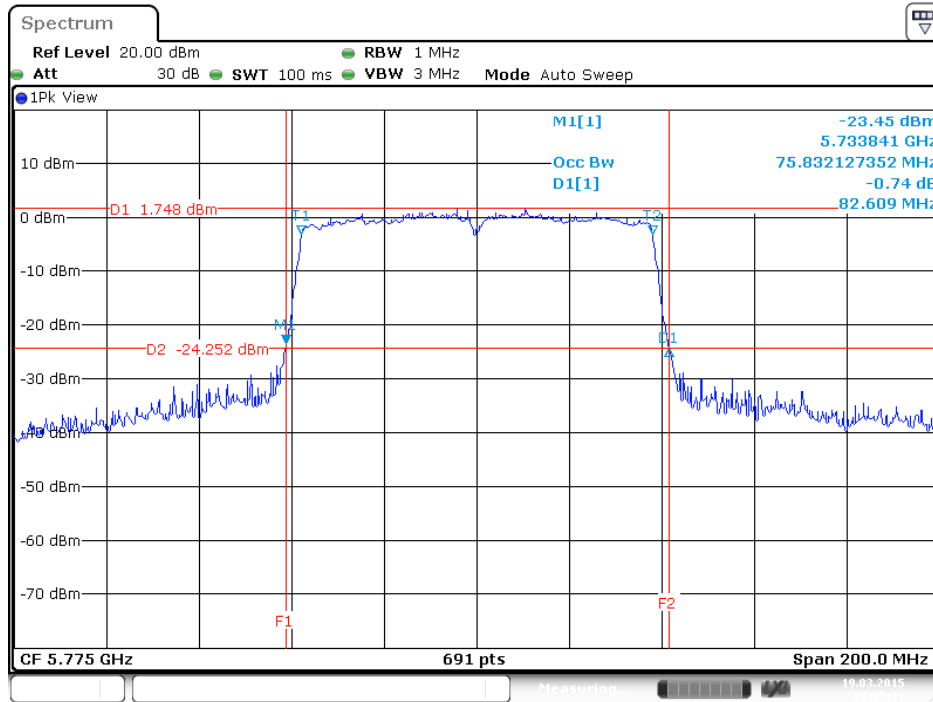

26dB Bandwidth Plot on Configuration IEEE 802.11ac 80MHz / CH 155 / MCS0 / 1S3T CDD / Ant. 1

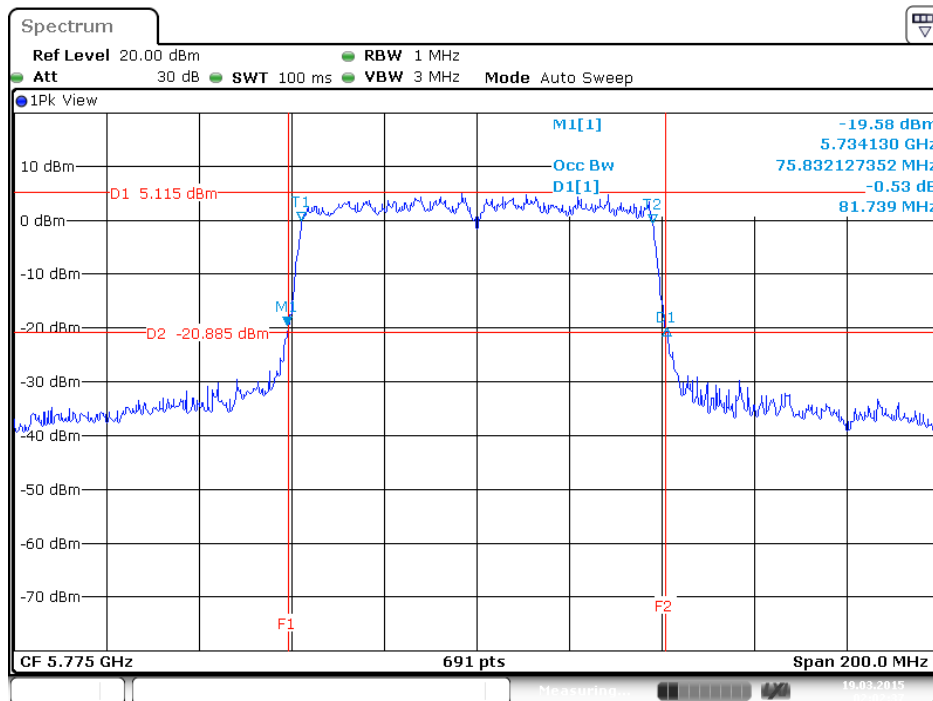

26dB Bandwidth Plot on Configuration IEEE 802.11ac 80MHz / CH 155 / MCS0 / 1S3T CDD / Ant. 2

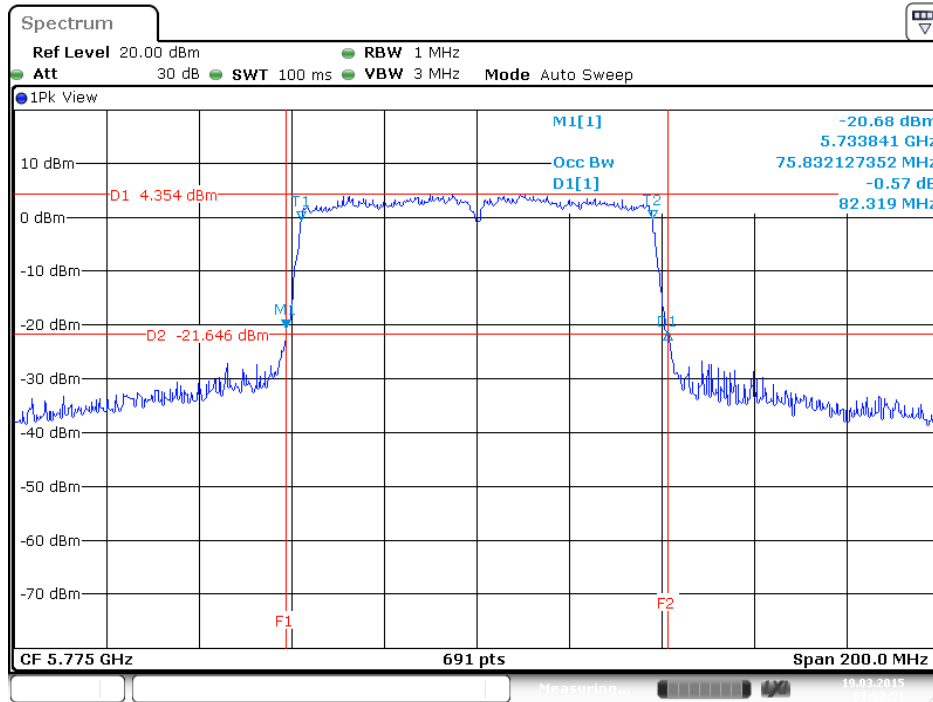

26dB Bandwidth Plot on Configuration IEEE 802.11ac 80MHz / CH 155 / MCS0 / 1S3T CDD / Ant. 3

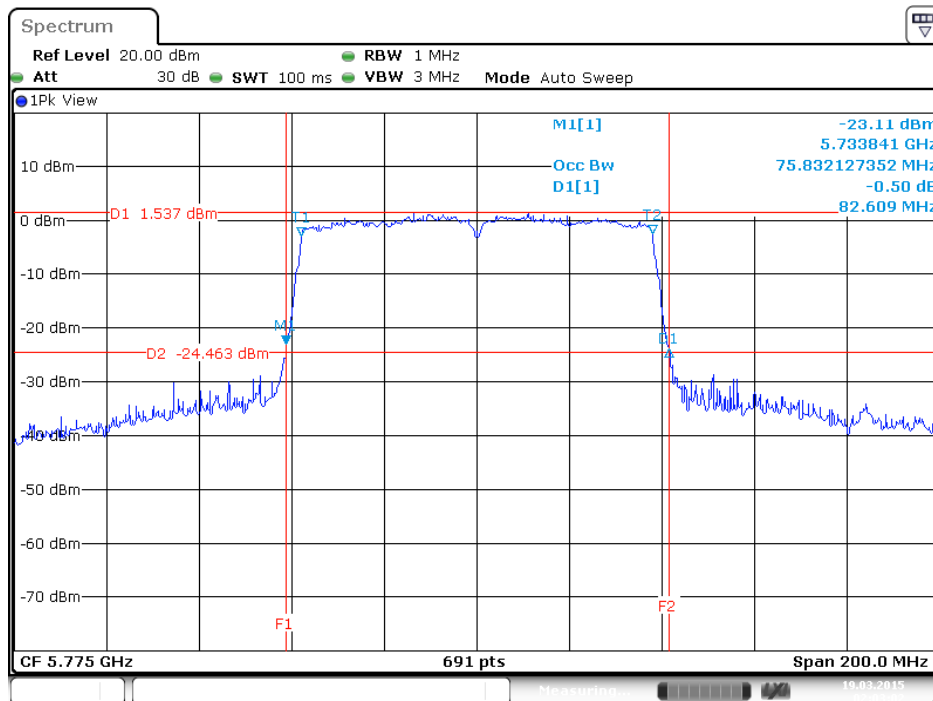

<Nss1MCS0, 1S3T, TXBF>:

26dB Bandwidth Plot on Configuration IEEE 802.11ac 80MHz / CH 42 / MCS0 / 1S3T TXBF / Ant. 1

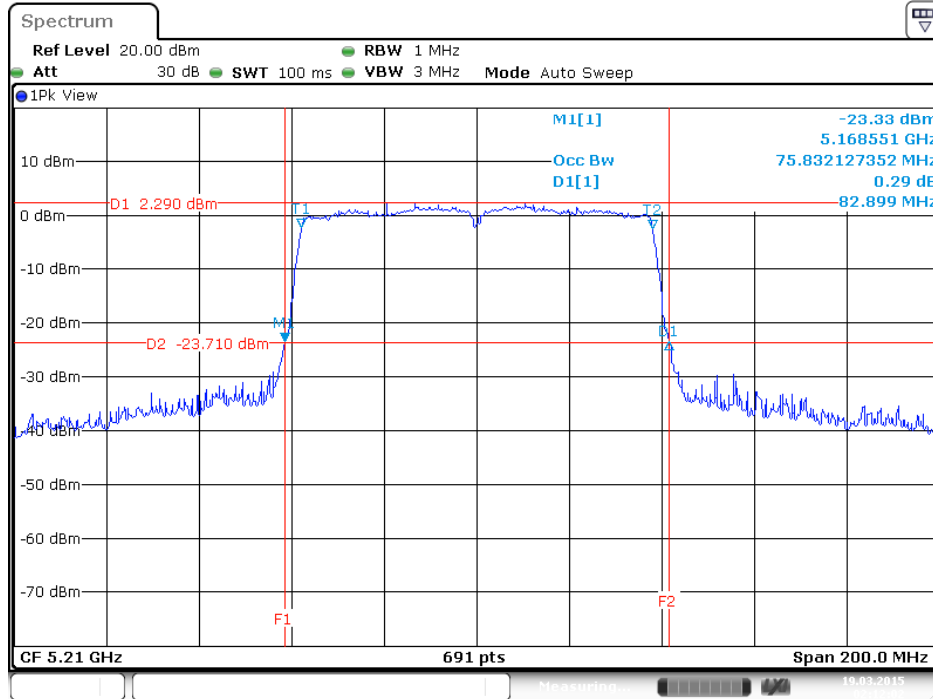

26dB Bandwidth Plot on Configuration IEEE 802.11ac 80MHz / CH 42 / MCS0 / 1S3T TXBF / Ant. 2

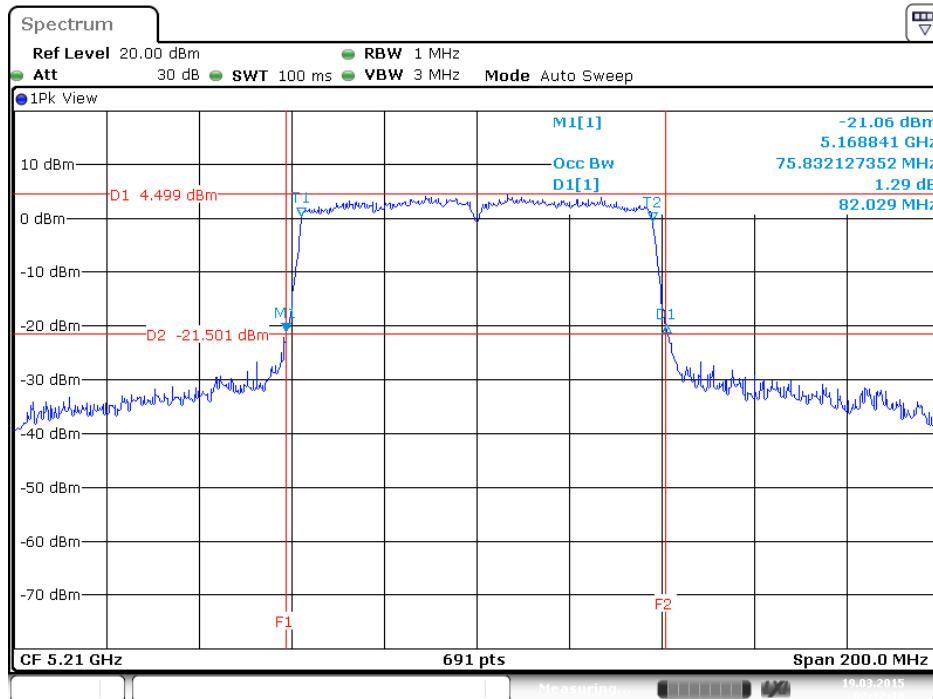

26dB Bandwidth Plot on Configuration IEEE 802.11ac 80MHz / CH 42 / MCS0 / 1S3T TXBF / Ant. 3

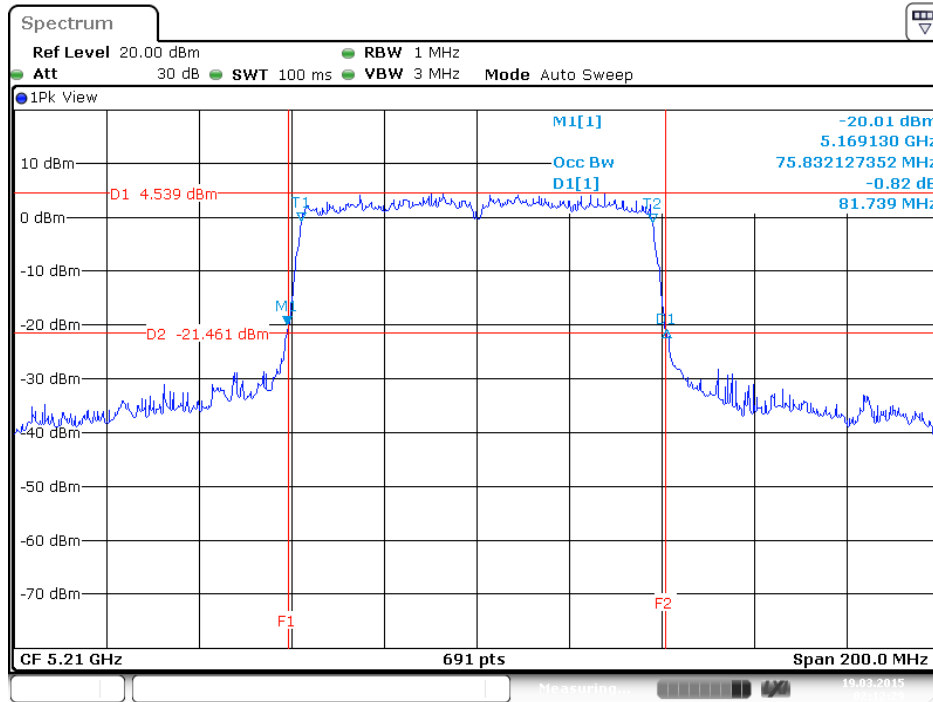

26dB Bandwidth Plot on Configuration IEEE 802.11ac 80MHz / CH 155 / MCS0 / 1S3T TXBF / Ant. 1

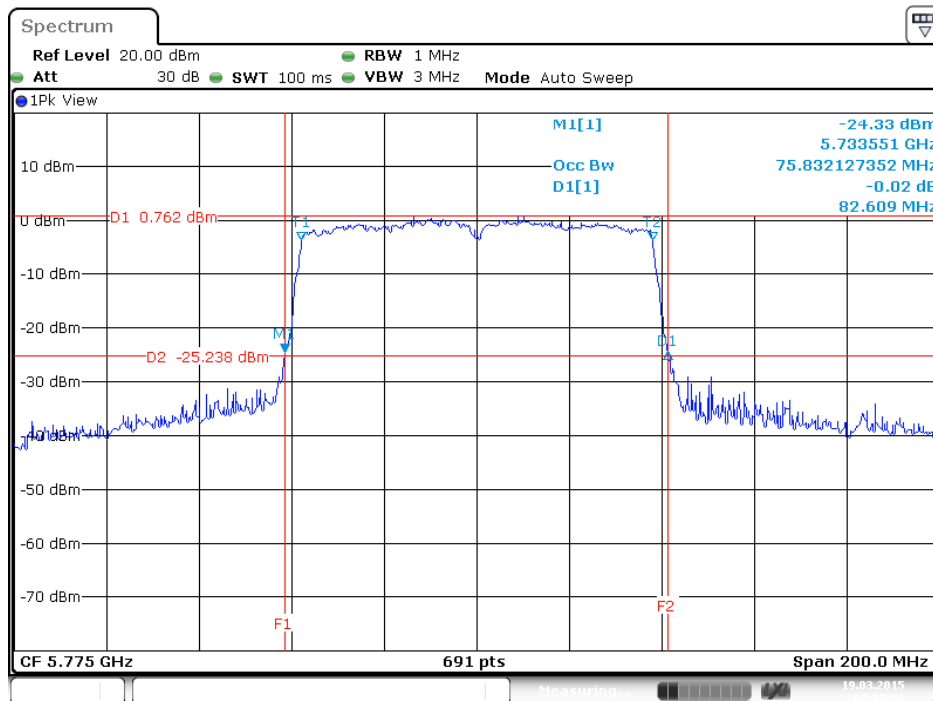

26dB Bandwidth Plot on Configuration IEEE 802.11ac 80MHz / CH 155 / MCS0 / 1S3T TXBF / Ant. 2

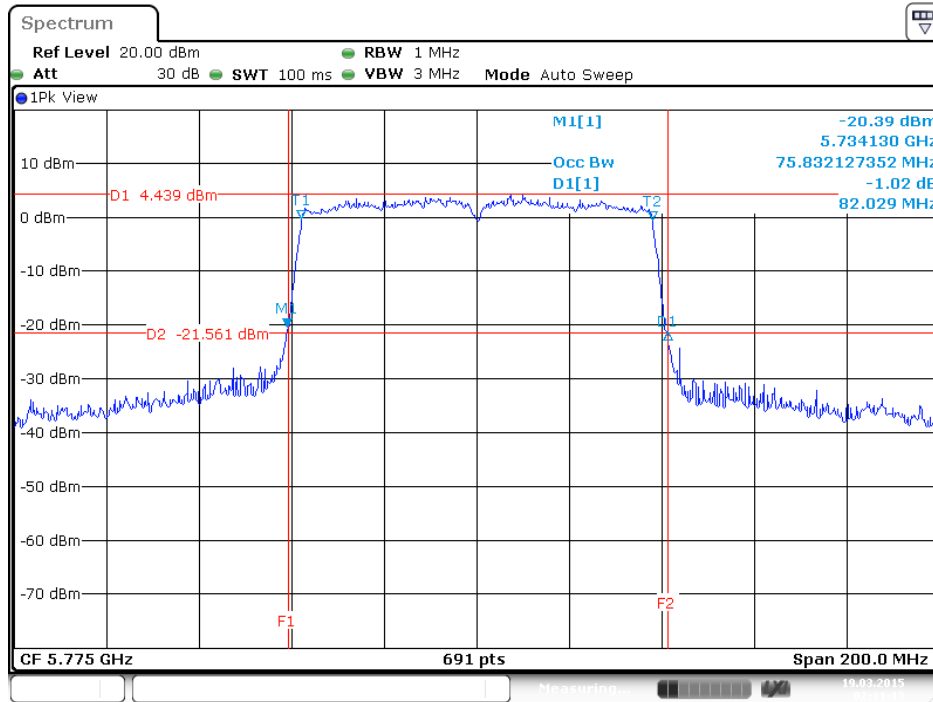

Date: 19 MAR 2015 02:11:13

26dB Bandwidth Plot on Configuration IEEE 802.11ac 80MHz / CH 155 / MCS0 / 1S3T TXBF / Ant. 3

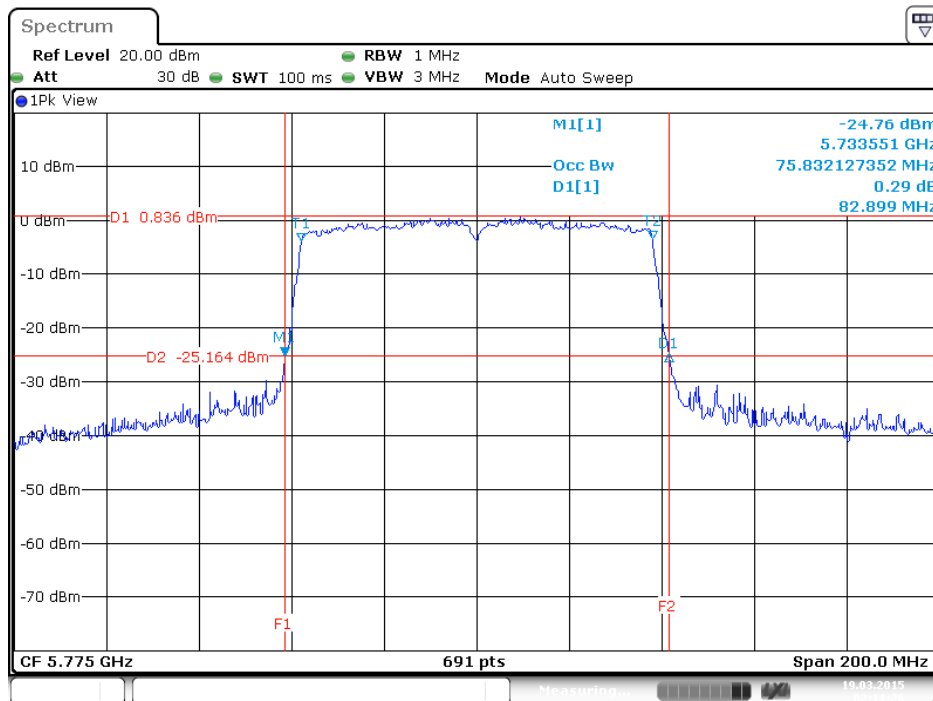

Date: 19 MAR 2015 02:11:26

3.2.8 Minimum Emission Bandwidth for the band 5.725-5.85 GHz

The following table is the setting of the spectrum analyzer.

Spectrum Parameters	Setting
Attenuation	Auto
Span Frequency	> 6dB Bandwidth
RBW	100 kHz
VBW	≥ 3 x RBW
Detector	Peak
Trace	Max Hold
Sweep Time	Auto

3.2.9 Test Procedures

1. The transmitter output (antenna port) was connected to the spectrum analyzer in peak hold mode.
2. Test was performed in accordance with Measurement of Digital Transmission Systems Operating under 789033 D02 General UNII Test Procedures New Rules v01, in section “Emission bandwidth (C)(2)”, 06/06/2014
3. Measured the spectrum width with power higher than 6dB account by this measurement.

3.2.10 Test Setup Layout

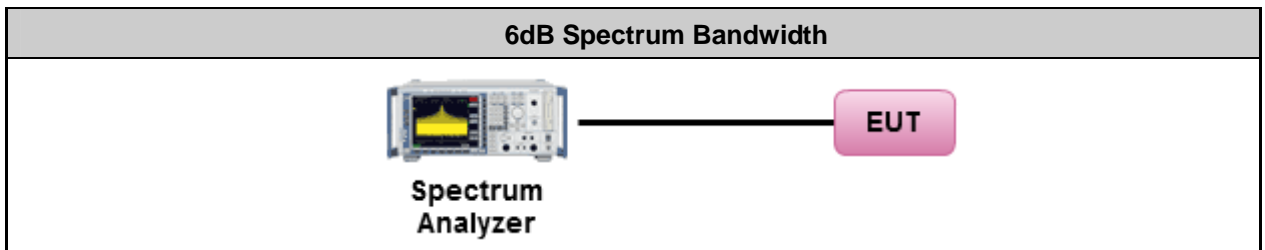

3.2.11 Test Deviation

There is no deviation with the original standard.

3.2.12 EUT Operation during Test

The EUT was programmed to be in continuously transmitting mode.

3.2.13 Test Result of 6dB Spectrum Bandwidth

Test date	Mar. 17, 2015~Mar. 25, 2015	Test Site No.	TH01-CB
Temperature	20°C	Humidity	60%
Test Engineer	Mars Lin	Configuration	802.11a
Duty Cycle	<6Mbps, ANT1 >: 98.09% <6Mbps, 1S3T, CDD>: 98.09%		

Configuration IEEE 802.11a

<6Mbps, ANT1 >

Channel	Frequency	6dB Bandwidth (MHz)	Max. Limit (kHz)	Result
149	5745 MHz	16.35	≥ 500	Complies
157	5785 MHz	16.35	≥ 500	Complies
165	5825 MHz	16.35	≥ 500	Complies

<6Mbps, 1S3T, CDD>

Channel	Frequency	6dB Bandwidth (MHz)			Max. Limit (kHz)	Result
		Ant. 1	Ant. 2	Ant. 3		
149	5745 MHz	16.41	15.42	16.29	≥ 500	Complies
157	5785 MHz	16.35	16.35	16.35	≥ 500	Complies
165	5825 MHz	16.35	16.35	16.35	≥ 500	Complies

<6Mbps, ANT1 >:

6dB Bandwidth Plot on Configuration IEEE 802.11a / CH 149 / Ant. 1

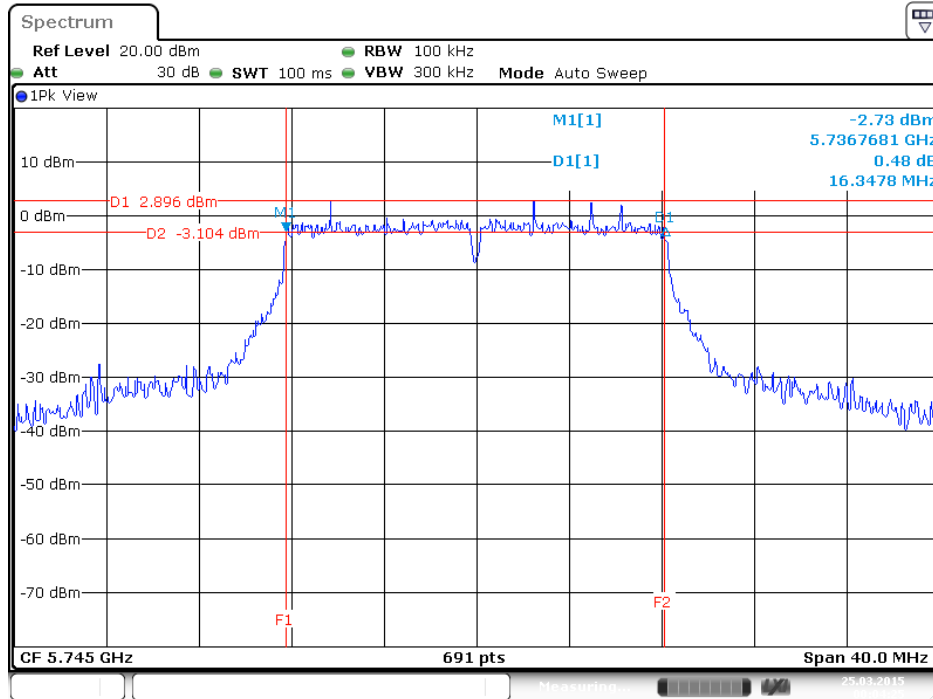

6dB Bandwidth Plot on Configuration IEEE 802.11a / CH 157 / Ant. 1

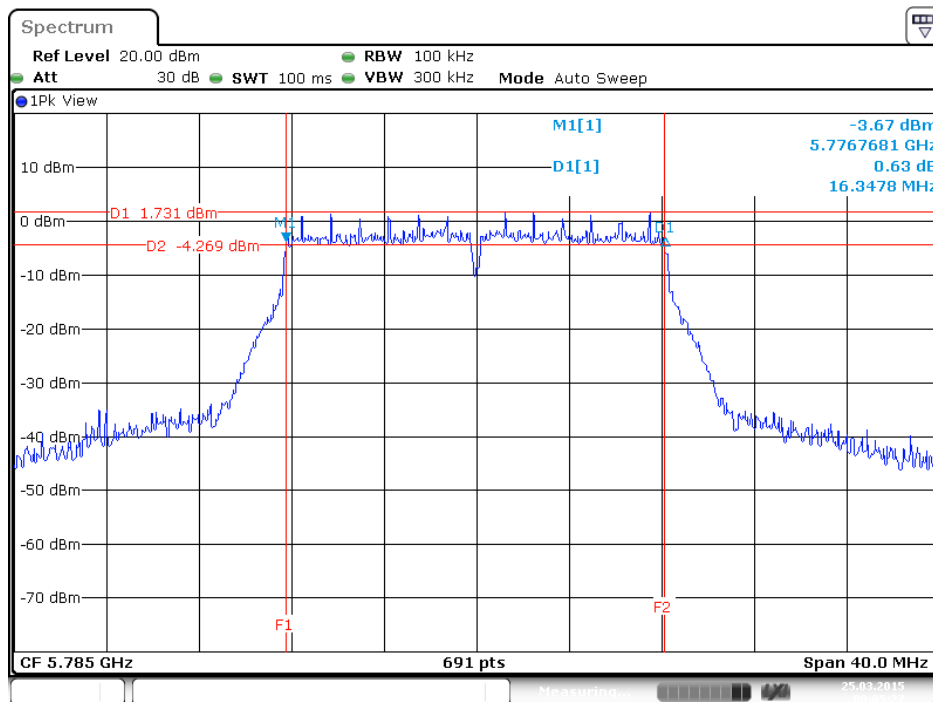

6dB Bandwidth Plot on Configuration IEEE 802.11a / CH 165 / Ant. 1

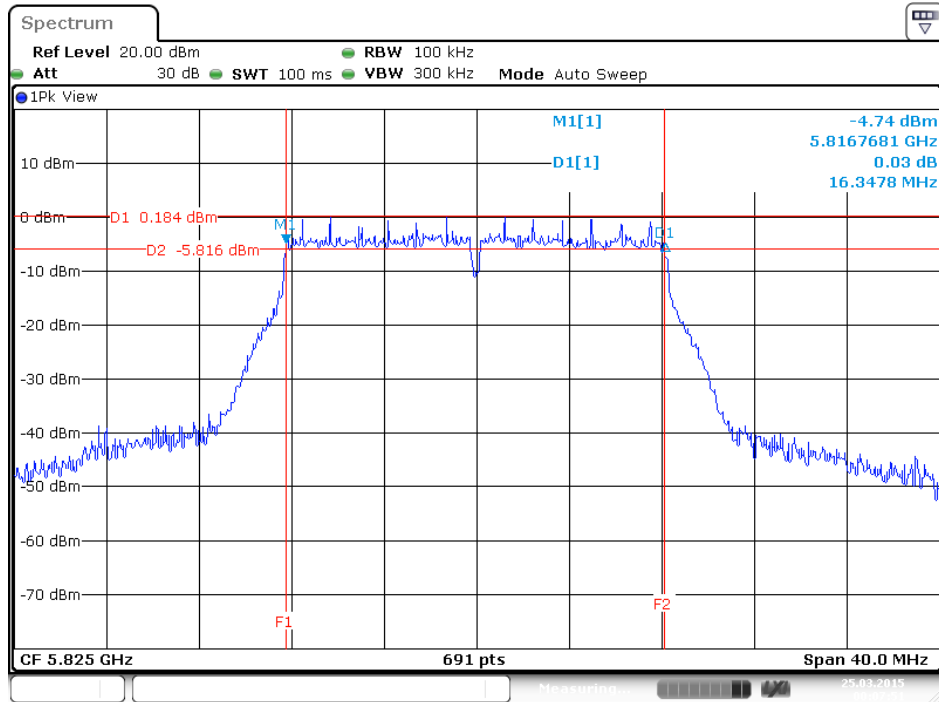

Date: 25 MAR 2015 00:07:51

<6Mbps, 1S3T, CDD>:

6dB Bandwidth Plot on Configuration IEEE 802.11a / CH 149 / 6Mbps / 1S3T CDD / Ant. 1

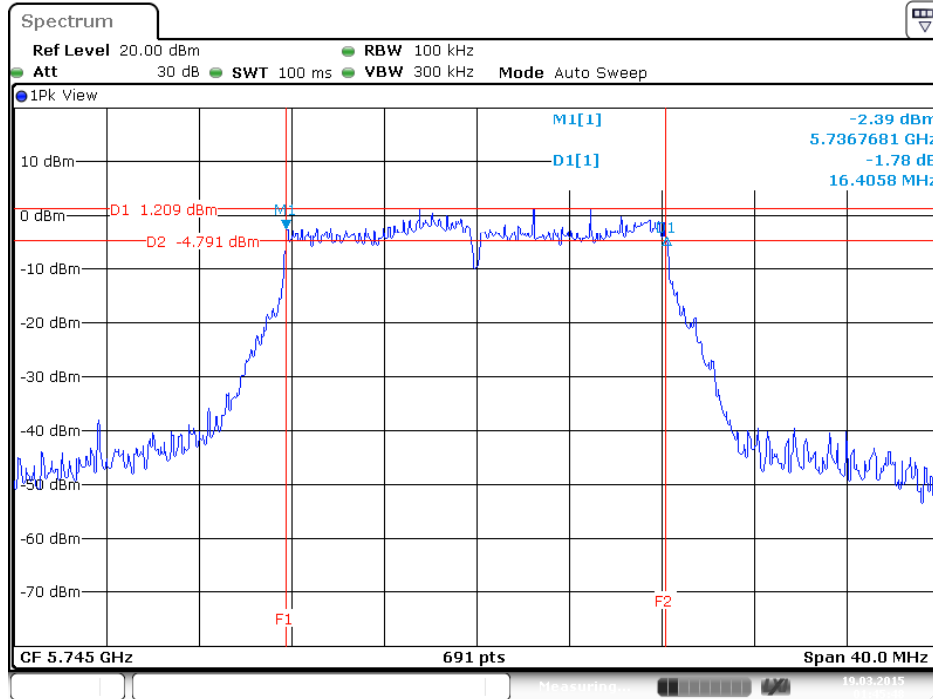

6dB Bandwidth Plot on Configuration IEEE 802.11a / CH 149 / 6Mbps / 1S3T CDD / Ant. 2

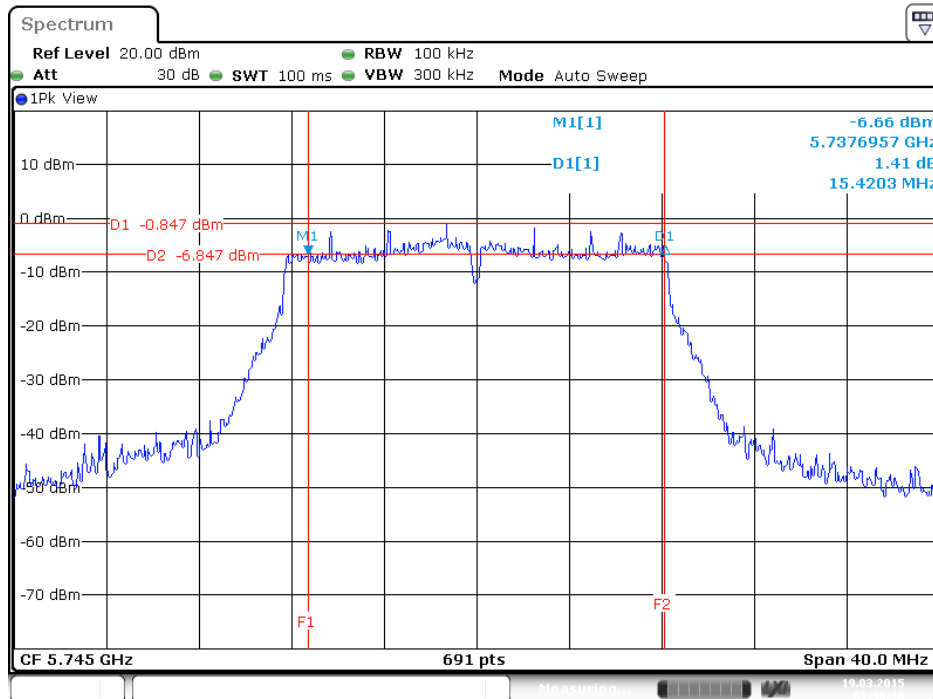

6dB Bandwidth Plot on Configuration IEEE 802.11a / CH 149 / 6Mbps / 1S3T CDD / Ant. 3

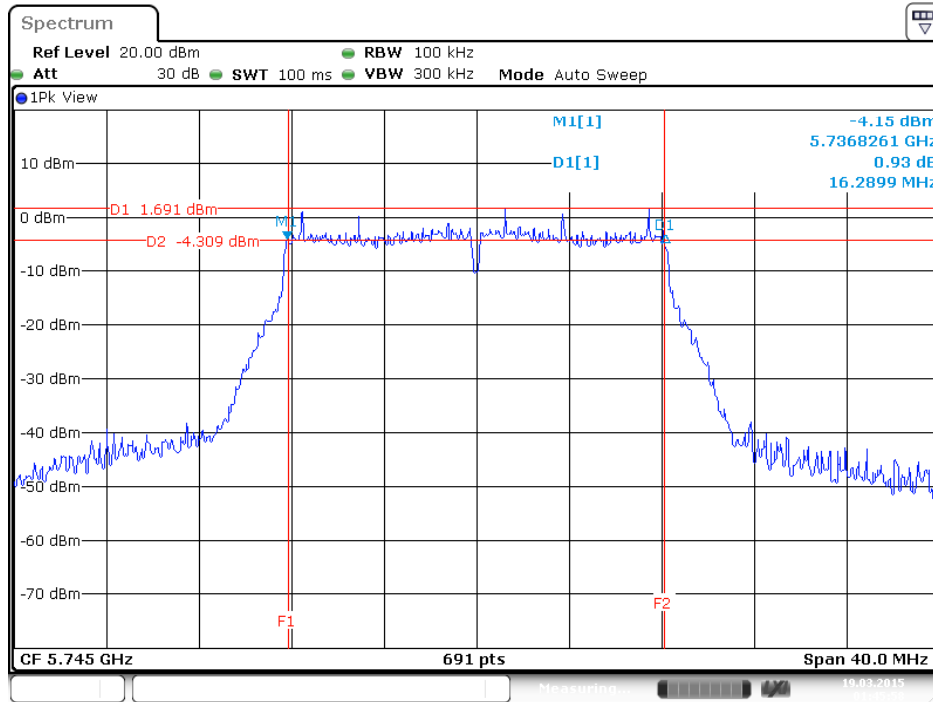

6dB Bandwidth Plot on Configuration IEEE 802.11a / CH 157 / 6Mbps / 1S3T CDD / Ant. 1

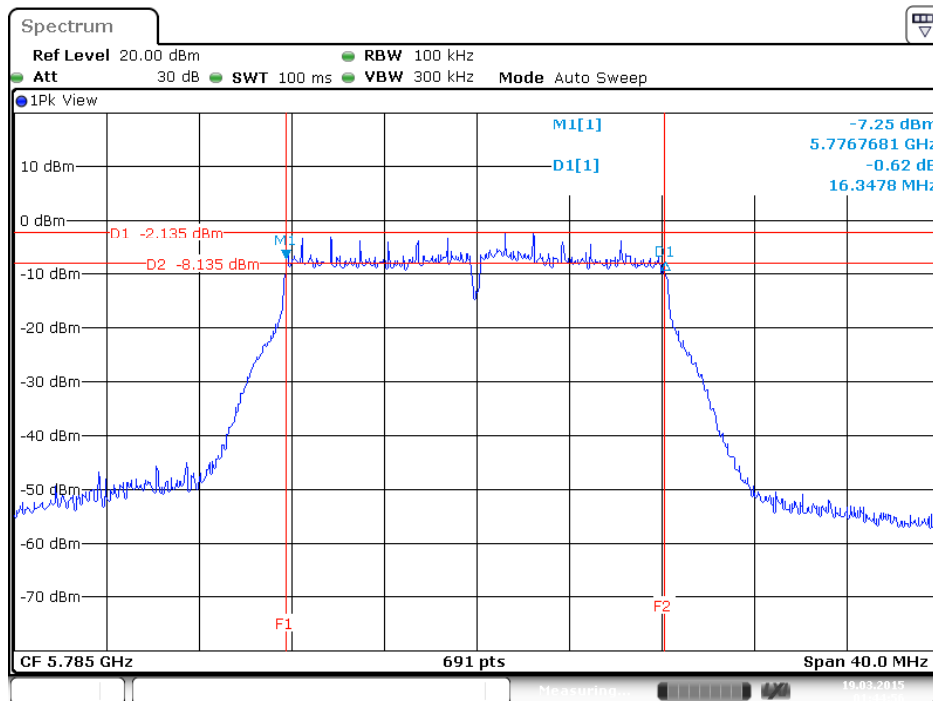

6dB Bandwidth Plot on Configuration IEEE 802.11a / CH 157 / 6Mbps / 1S3T CDD / Ant. 2

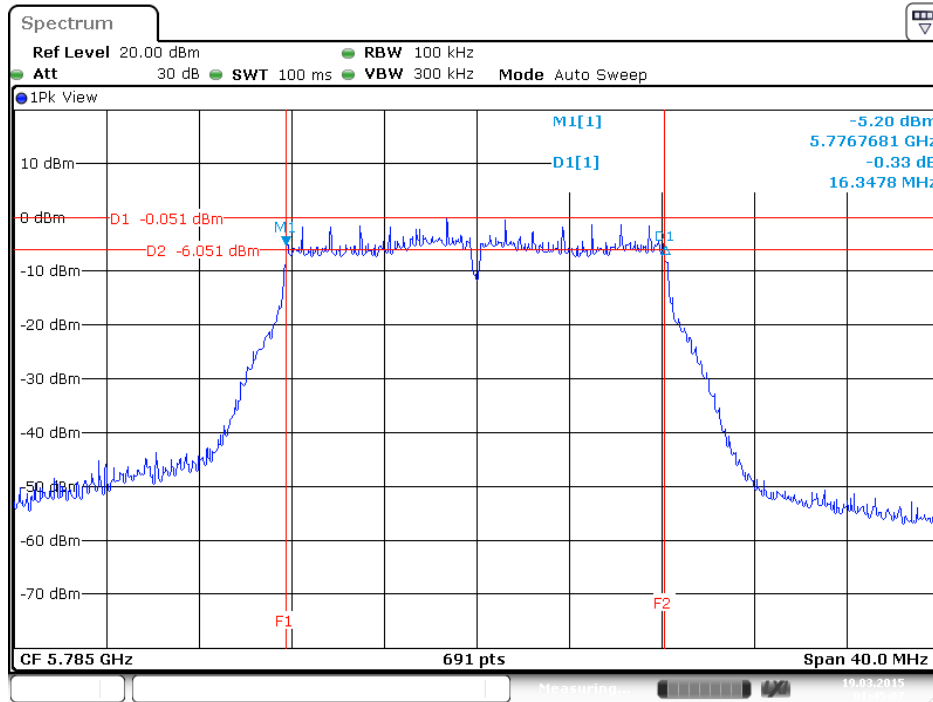

6dB Bandwidth Plot on Configuration IEEE 802.11a / CH 157 / 6Mbps / 1S3T CDD / Ant. 3

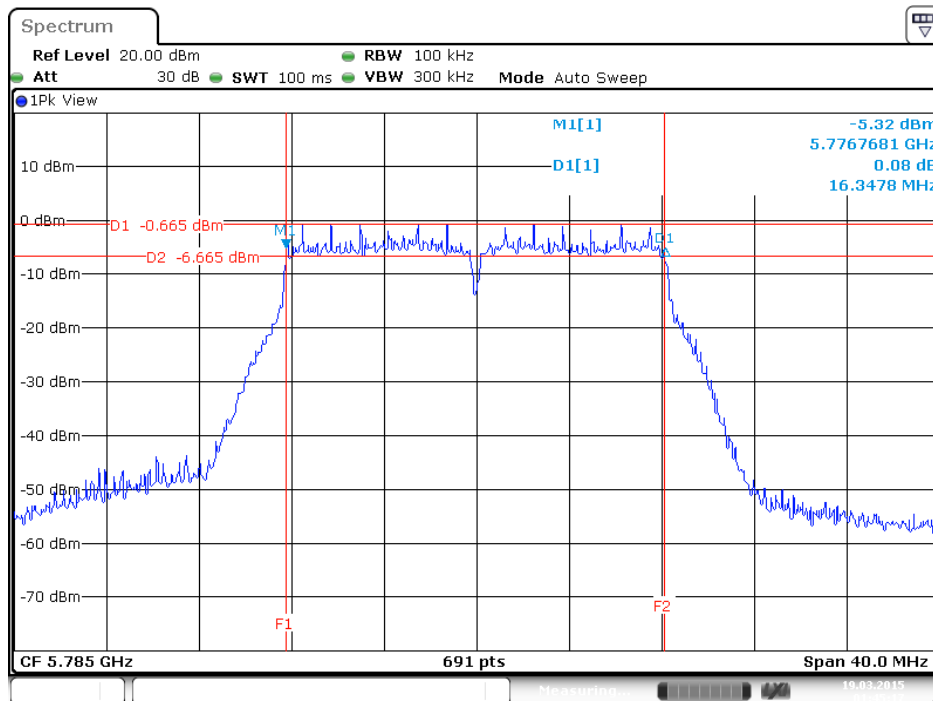

6dB Bandwidth Plot on Configuration IEEE 802.11a / CH 165 / 6Mbps / 1S3T CDD / Ant. 1

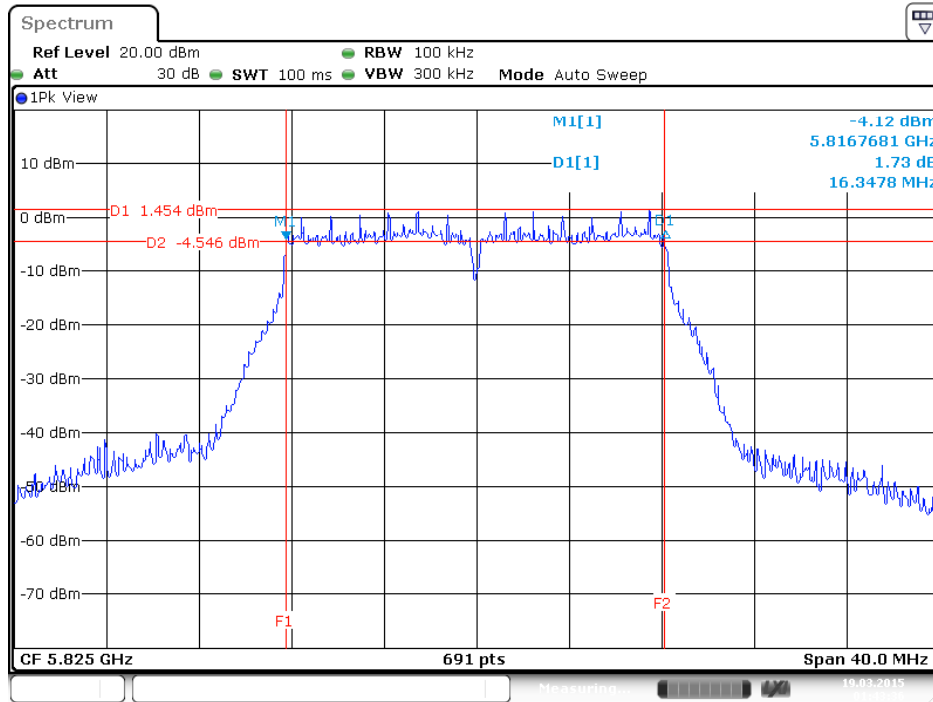

6dB Bandwidth Plot on Configuration IEEE 802.11a / CH 165 / 6Mbps / 1S3T CDD / Ant. 2

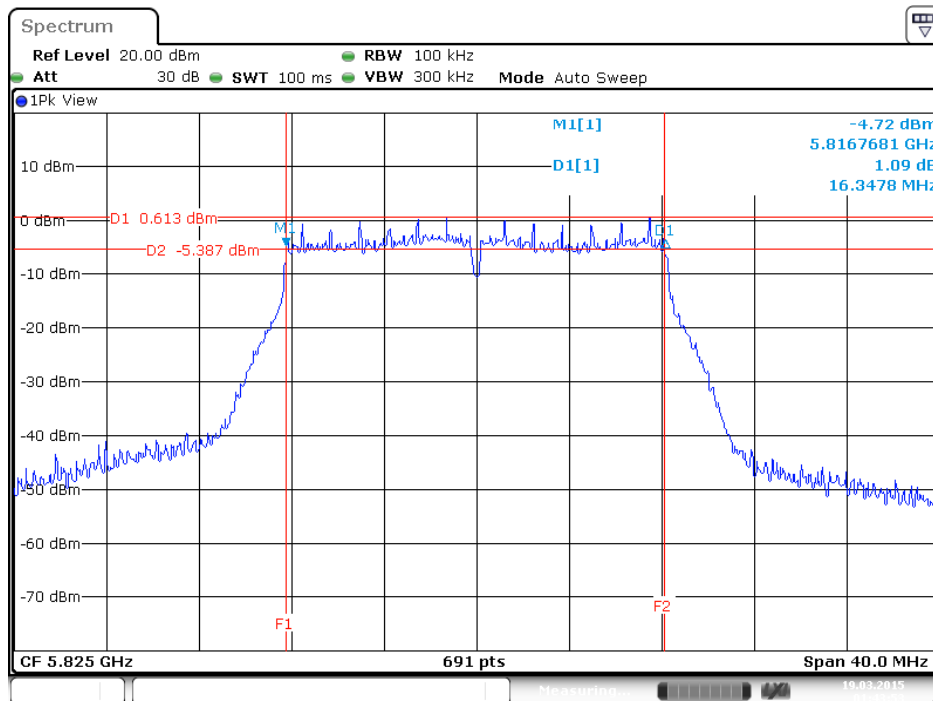

6dB Bandwidth Plot on Configuration IEEE 802.11a / CH 165 / 6Mbps / 1S3T CDD / Ant. 3

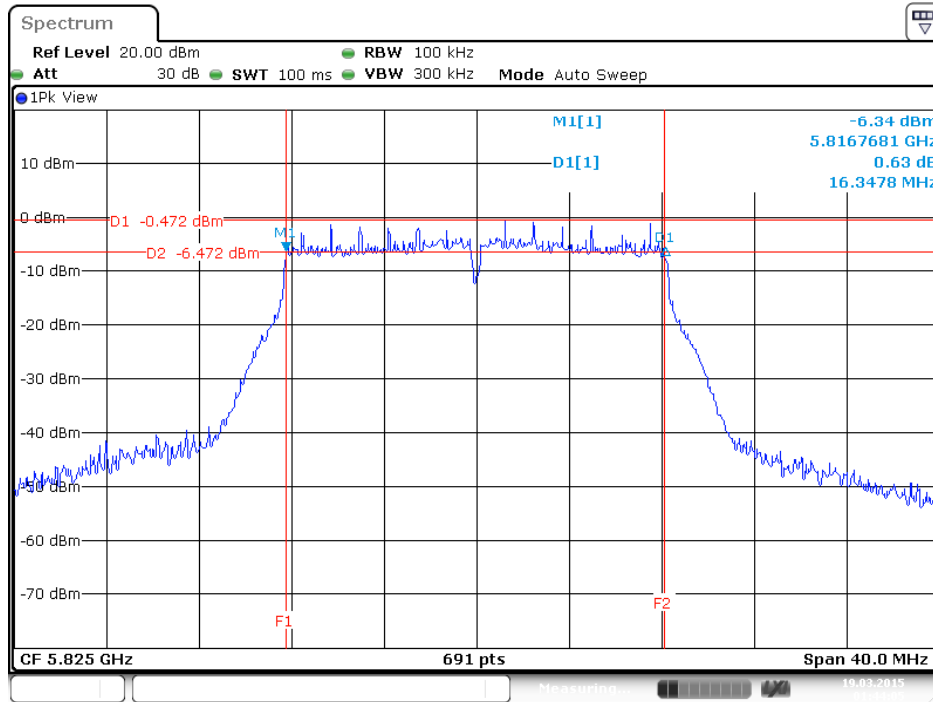

Date: 19 MAR 2015 01:44:05

Test date	Mar. 17, 2015~Mar. 25, 2015	Test Site No.	TH01-CB
Temperature	20°C	Humidity	60%
Test Engineer	Mars Lin	Configuration	802.11ac 20MHz
Duty Cycle	<Nss1MCS0, Ant. 1>: 98.97% <Nss1MCS0, 1S3T, CDD>: 98.97% <Nss1MCS0, 1S3T, TXBF>: 97.23%		

Configuration IEEE 802.11ac 20MHz

<Nss1MCS0, Ant. 1>

Channel	Frequency	6dB Bandwidth (MHz)	Max. Limit (kHz)	Result
149	5745 MHz	17.62	≥ 500	Complies
157	5785 MHz	17.62	≥ 500	Complies
165	5825 MHz	17.62	≥ 500	Complies

<Nss1MCS0, 1S3T, CDD>

Channel	Frequency	6dB Bandwidth (MHz)			Max. Limit (kHz)	Result
		Ant. 1	Ant. 2	Ant. 3		
149	5745 MHz	17.57	16.70	16.29	≥ 500	Complies
157	5785 MHz	17.62	17.57	17.51	≥ 500	Complies
165	5825 MHz	17.28	17.51	17.28	≥ 500	Complies

<Nss1MCS0, 1S3T, TXBF>

Channel	Frequency	6dB Bandwidth (MHz)			Max. Limit (kHz)	Result
		Ant. 1	Ant. 2	Ant. 3		
149	5745 MHz	16.35	17.51	17.51	≥ 500	Complies
157	5785 MHz	17.28	17.51	17.16	≥ 500	Complies
165	5825 MHz	17.62	17.51	17.28	≥ 500	Complies

<Nss1MCS0, Ant. 1>:

6dB Bandwidth Plot on Configuration IEEE 802.11ac 20MHz / CH 149 / Ant. 1

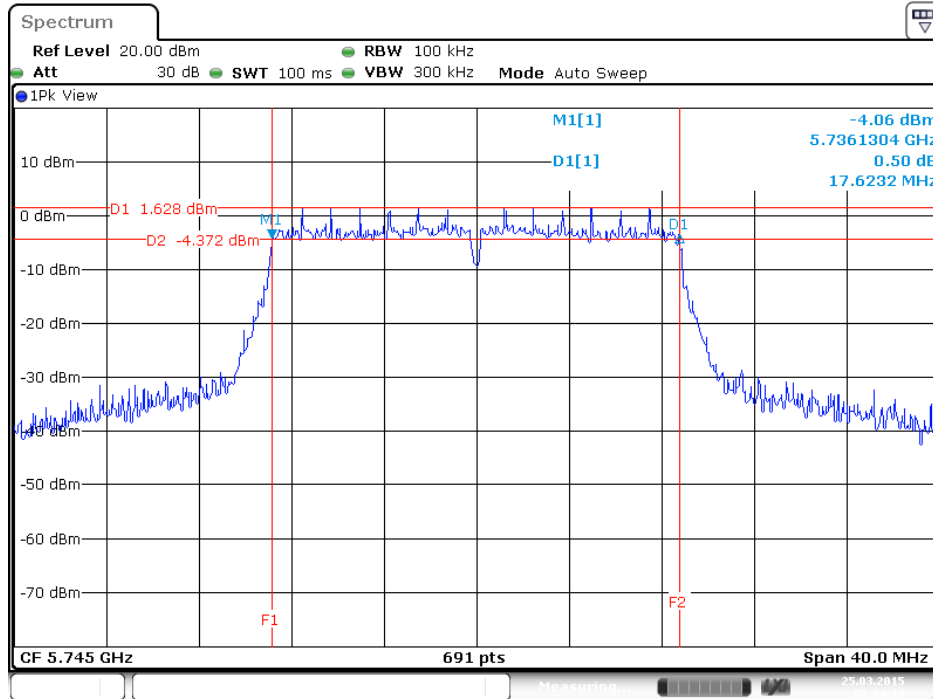

Date: 25 MAR. 2015 00:34:33

6dB Bandwidth Plot on Configuration IEEE 802.11 ac 20MHz / CH 157 / Ant. 1

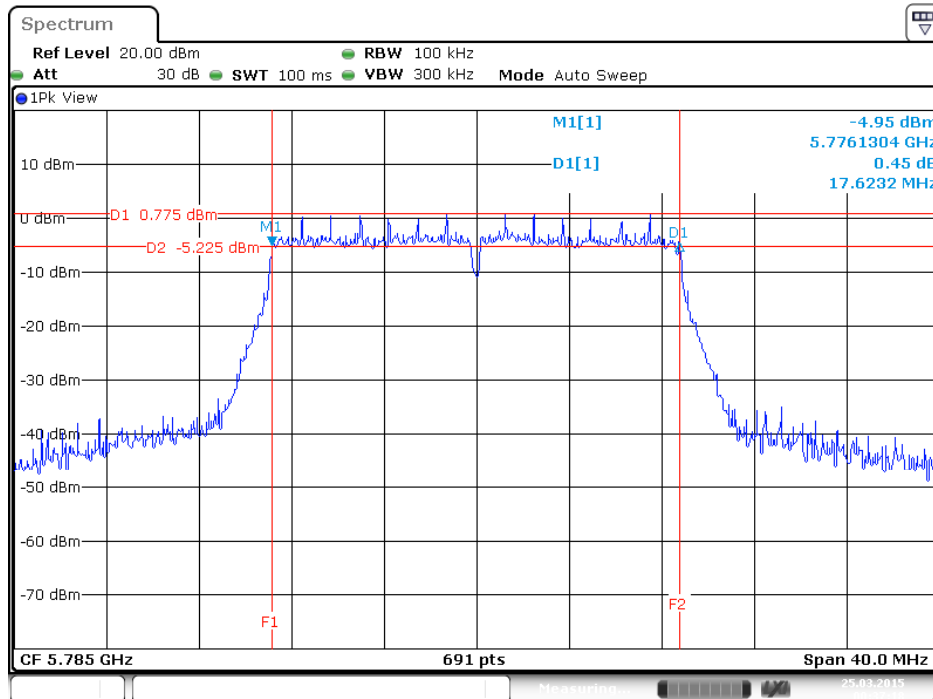

Date: 25 MAR. 2015 00:37:18

6dB Bandwidth Plot on Configuration IEEE 802.11ac 20MHz / CH 165 / Ant. 1

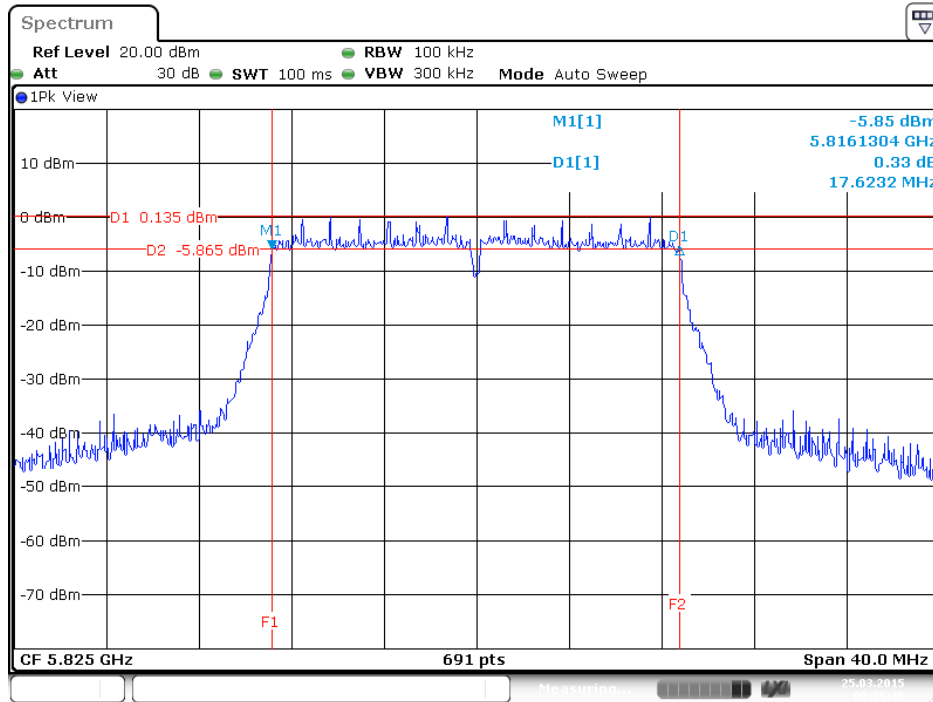

Date: 25 MAR. 2015 00:39:46

<Nss1MCS0, 1S3T, CDD>:

6dB Bandwidth Plot on Configuration IEEE 802.11ac 20MHz / CH 149 / MCS0 / 1S3T CDD / Ant. 1

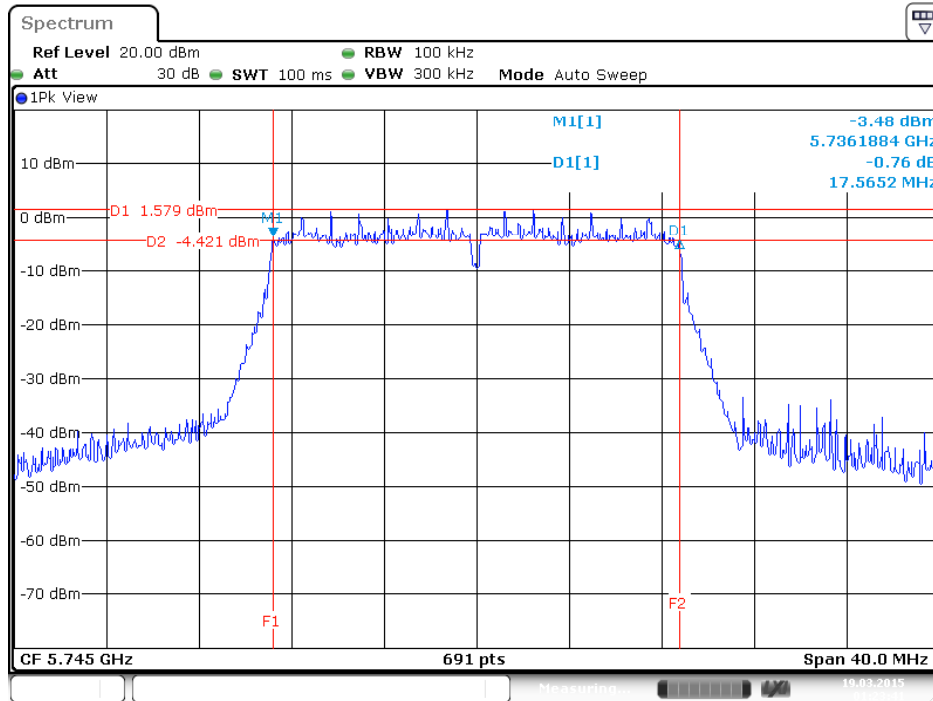

Date: 19 MAR. 2015 01:23:41

6dB Bandwidth Plot on Configuration IEEE 802.11ac 20MHz / CH 149 / MCS0 / 1S3T CDD / Ant. 2

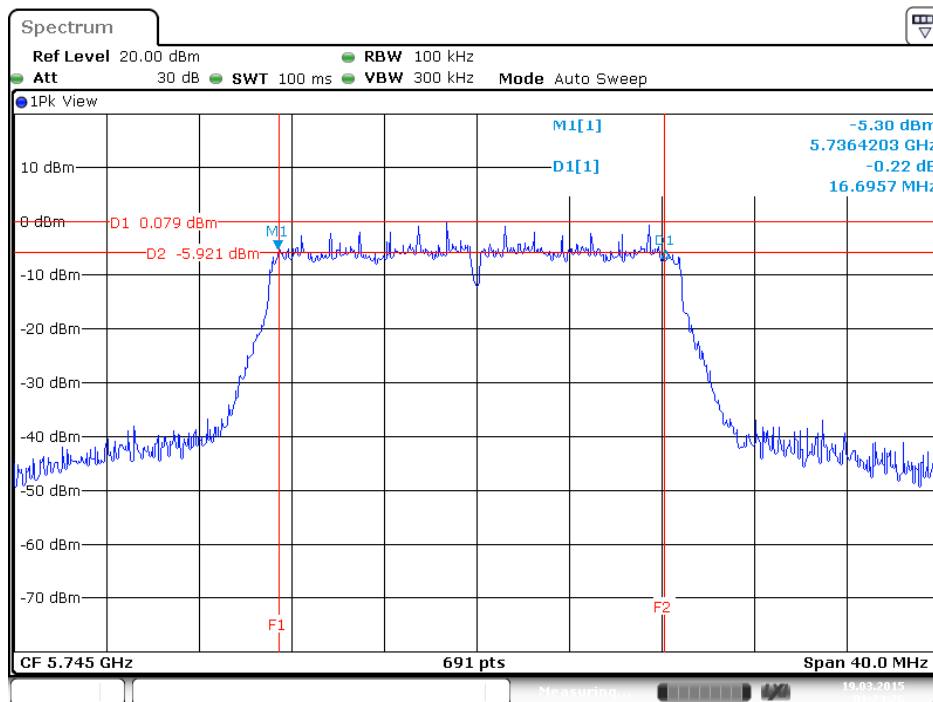

Date: 19 MAR. 2015 01:23:26

6dB Bandwidth Plot on Configuration IEEE 802.11ac 20MHz / CH 149 / MCS0 / 1S3T CDD / Ant. 3

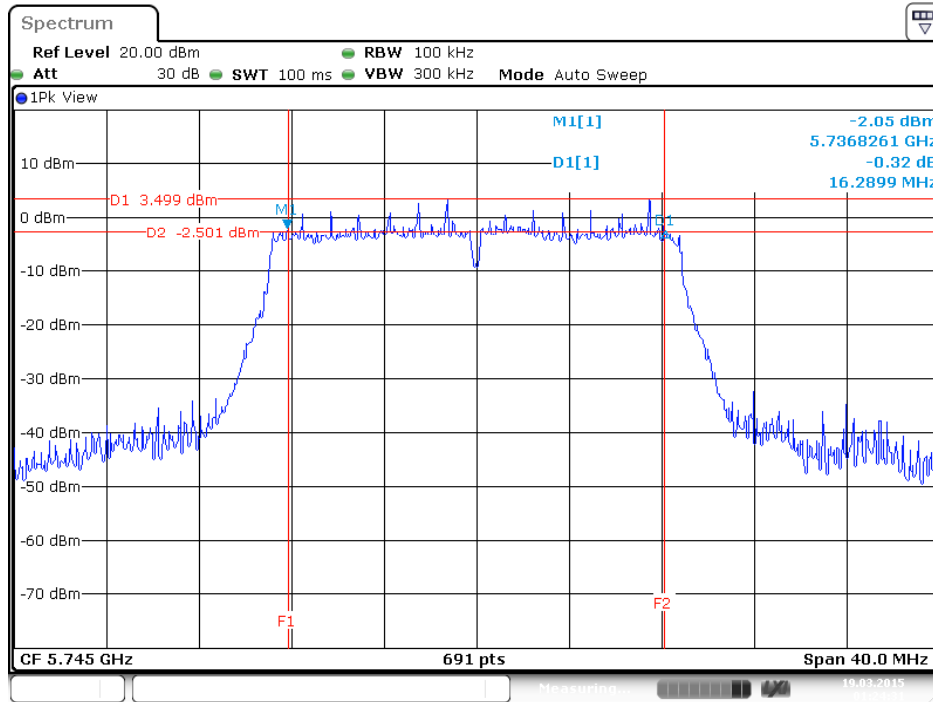

Date: 19 MAR 2015 01:24:31

6dB Bandwidth Plot on Configuration IEEE 802.11ac 20MHz / CH 157 / MCS0 / 1S3T CDD / Ant. 1

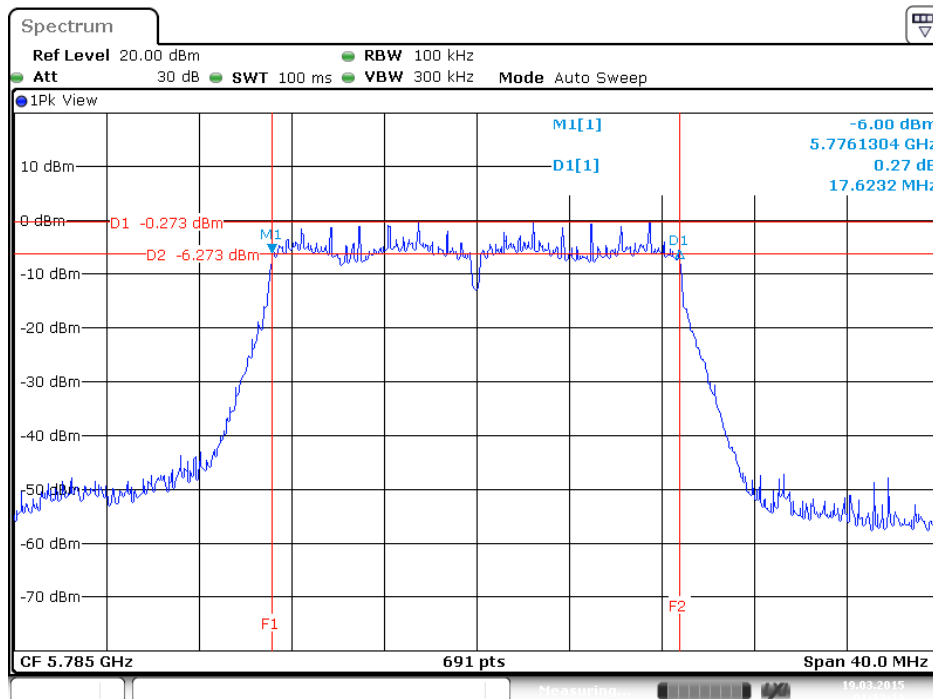

Date: 19 MAR 2015 01:22:11

6dB Bandwidth Plot on Configuration IEEE 802.11ac 20MHz / CH 157 / MCS0 / 1S3T CDD / Ant. 2

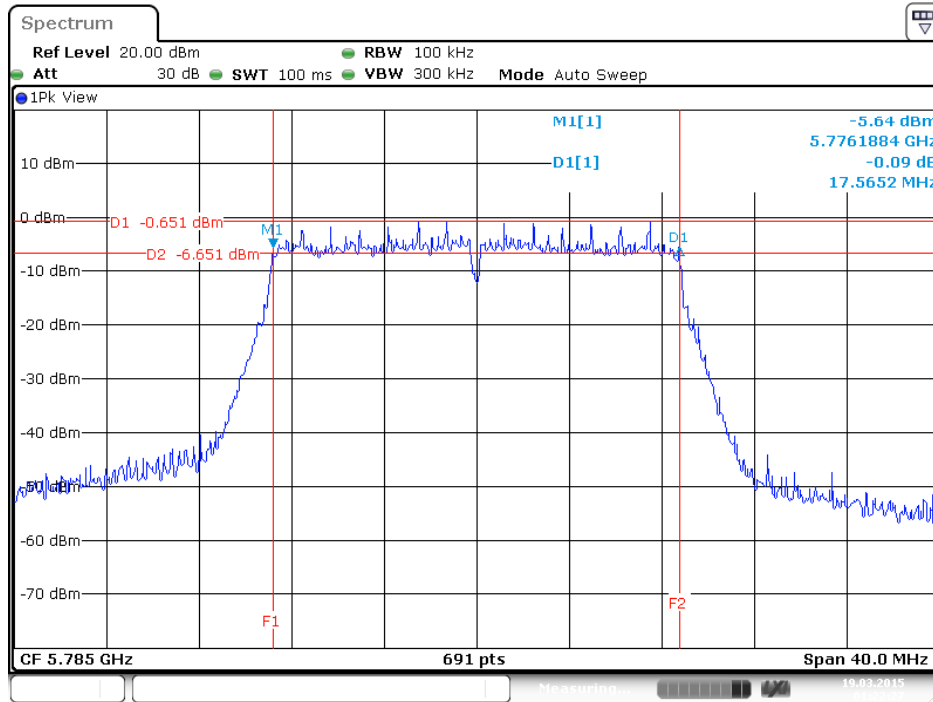

6dB Bandwidth Plot on Configuration IEEE 802.11ac 20MHz / CH 157 / MCS0 / 1S3T CDD / Ant. 3

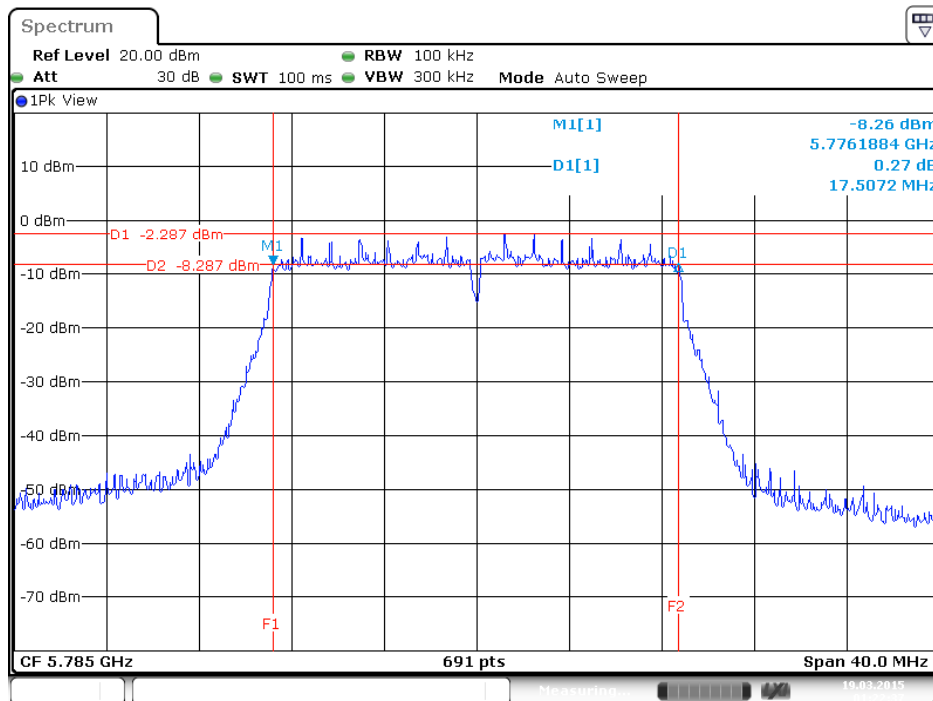

6dB Bandwidth Plot on Configuration IEEE 802.11ac 20MHz / CH 165 / MCS0 / 1S3T CDD / Ant. 1

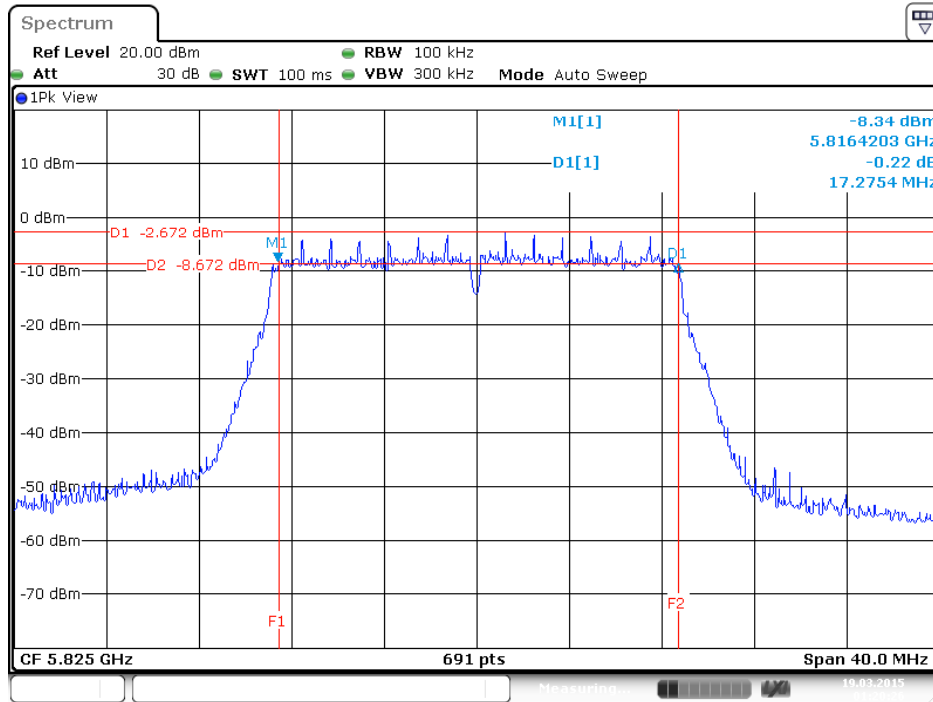

6dB Bandwidth Plot on Configuration IEEE 802.11ac 20MHz / CH 165 / MCS0 / 1S3T CDD / Ant. 2

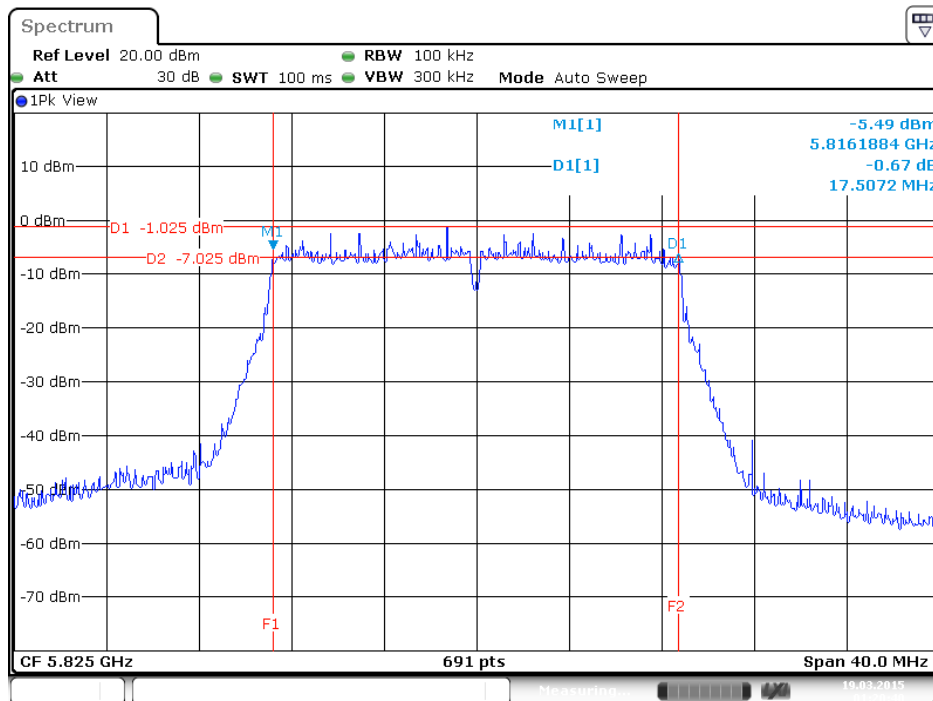

6dB Bandwidth Plot on Configuration IEEE 802.11ac 20MHz / CH 165 / MCS0 / 1S3T CDD / Ant. 3

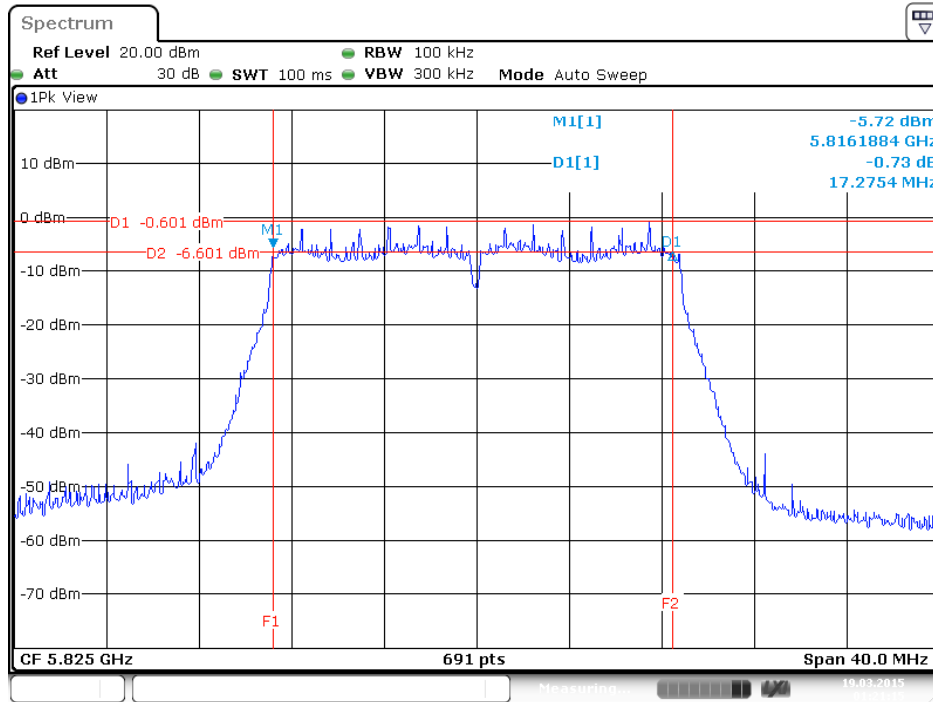

Date: 19 MAR 2015 01:21:15

<Nss1MCS0, 1S3T, TXBF>:

6dB Bandwidth Plot on Configuration IEEE 802.11ac 20MHz / CH 149 / MCS0 / 1S3T TXBF / Ant. 1

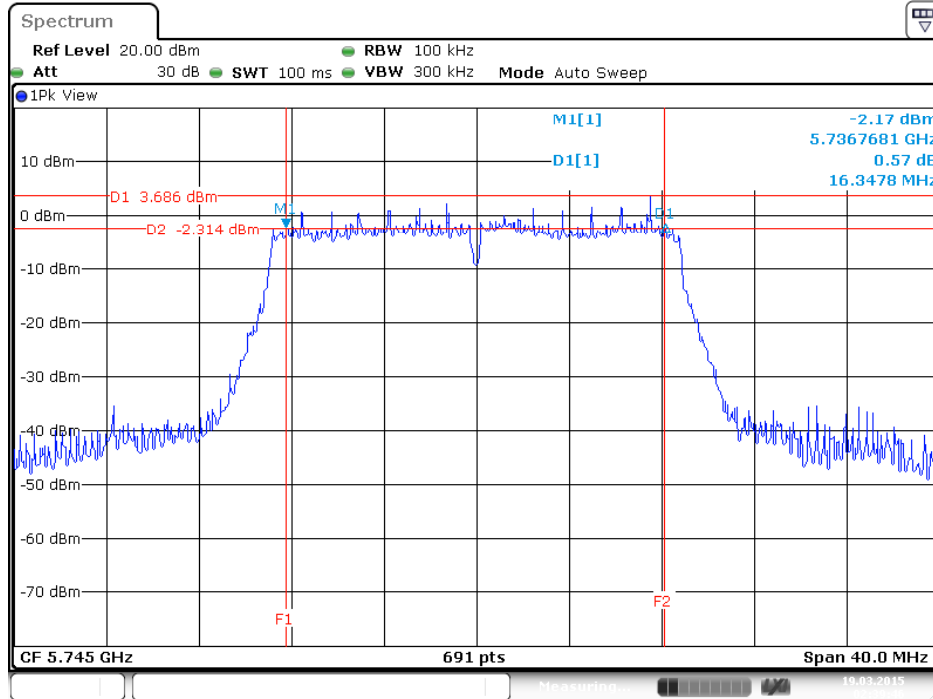

6dB Bandwidth Plot on Configuration IEEE 802.11ac 20MHz / CH 149 / MCS0 / 1S3T TXBF / Ant. 2

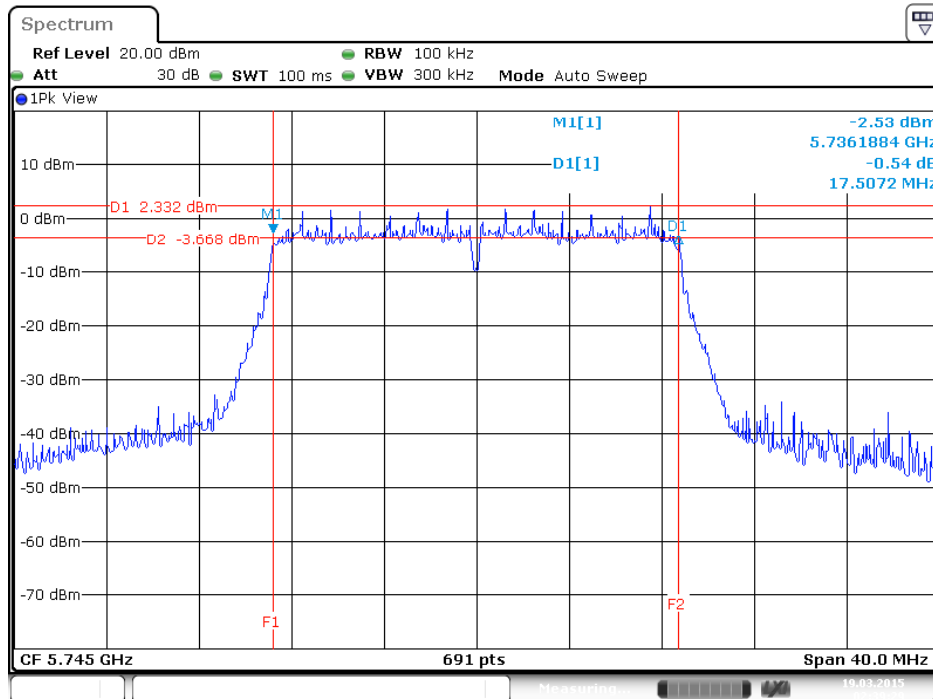

6dB Bandwidth Plot on Configuration IEEE 802.11ac 20MHz / CH 149 / MCS0 / 1S3T TXBF / Ant. 3

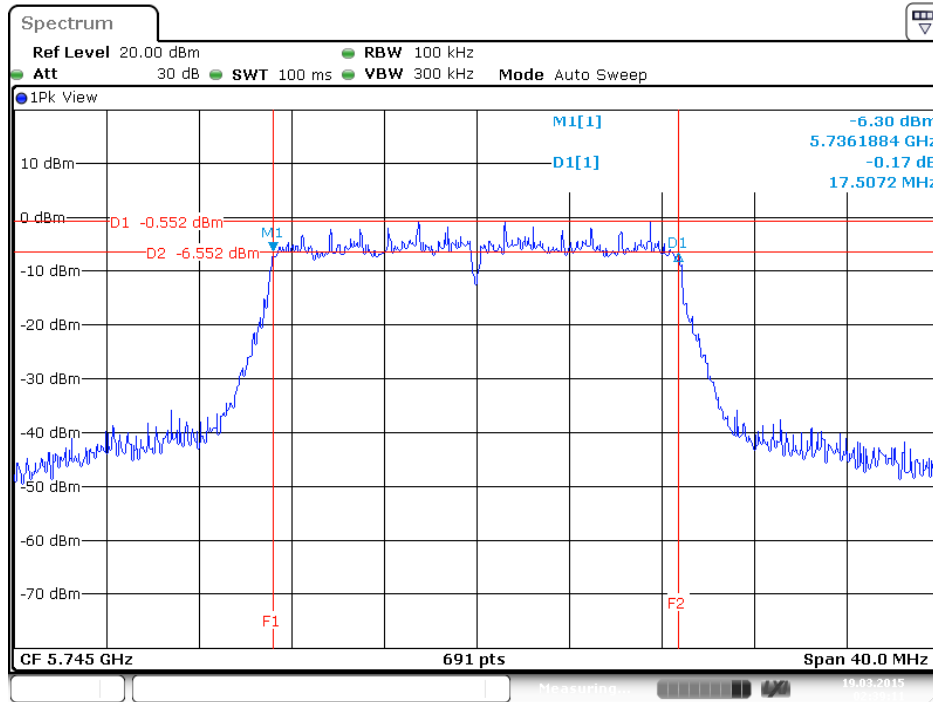

6dB Bandwidth Plot on Configuration IEEE 802.11ac 20MHz / CH 157 / MCS0 / 1S3T TXBF / Ant. 1

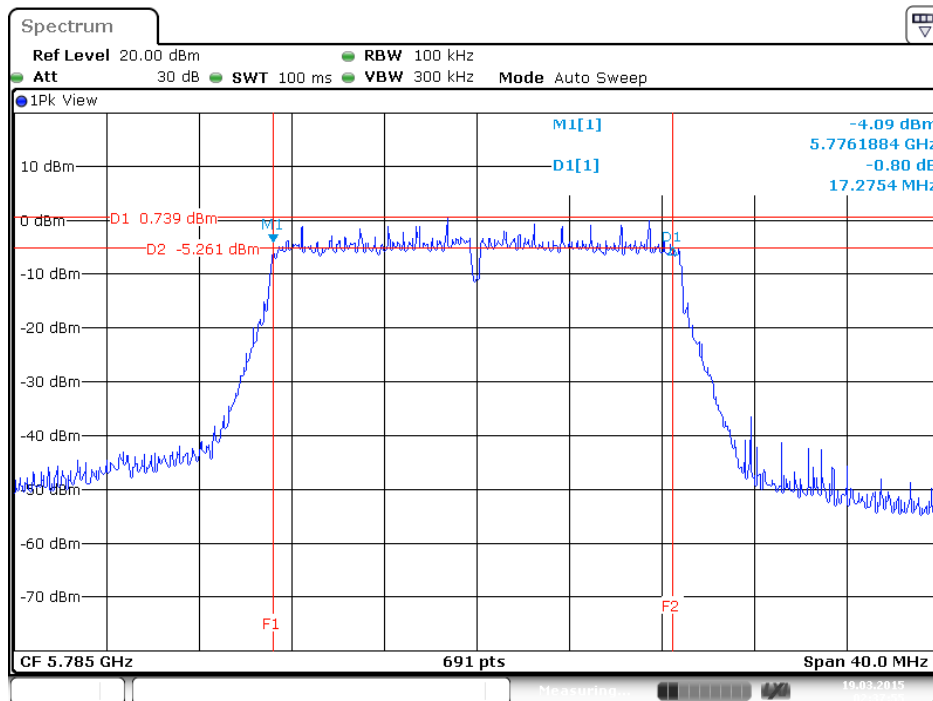

6dB Bandwidth Plot on Configuration IEEE 802.11ac 20MHz / CH 157 / MCS0 / 1S3T TXBF / Ant. 2

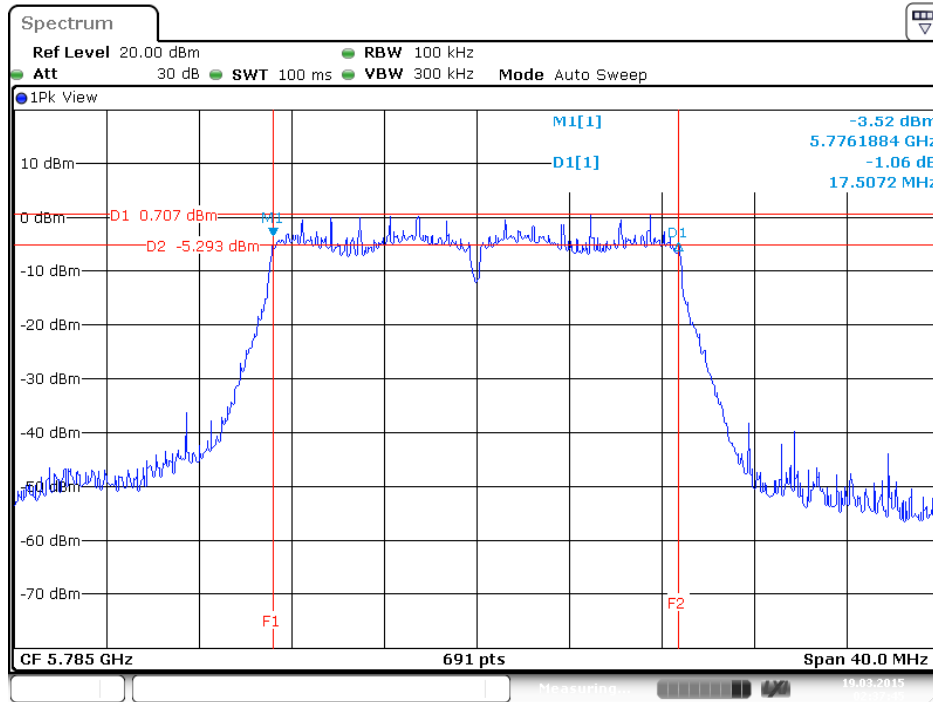

6dB Bandwidth Plot on Configuration IEEE 802.11ac 20MHz / CH 157 / MCS0 / 1S3T TXBF / Ant. 3

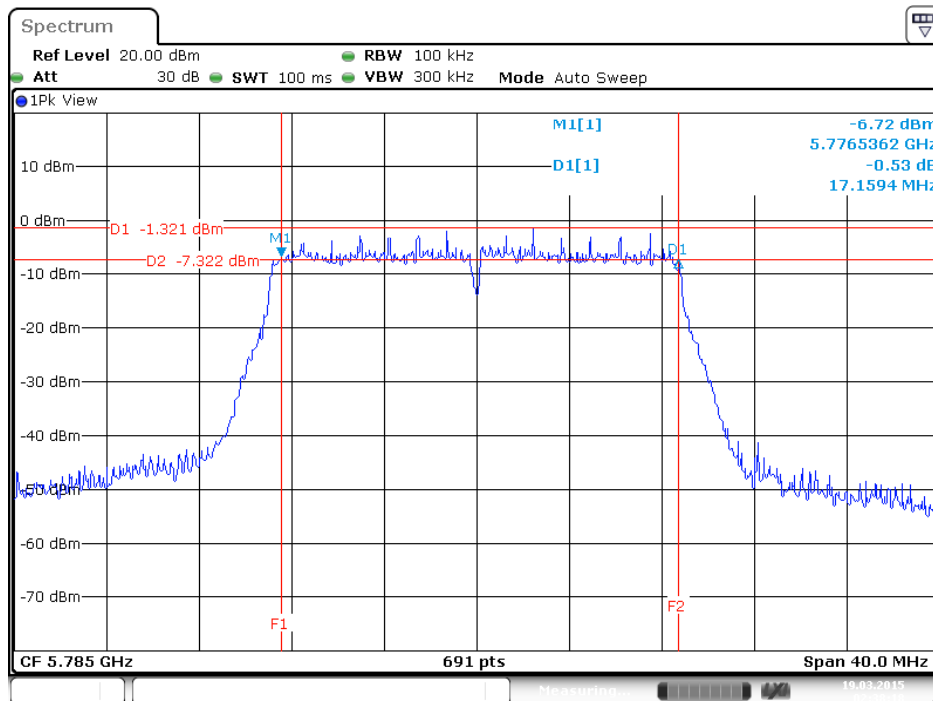

6dB Bandwidth Plot on Configuration IEEE 802.11ac 20MHz / CH 165 / MCS0 / 1S3T TXBF / Ant. 1

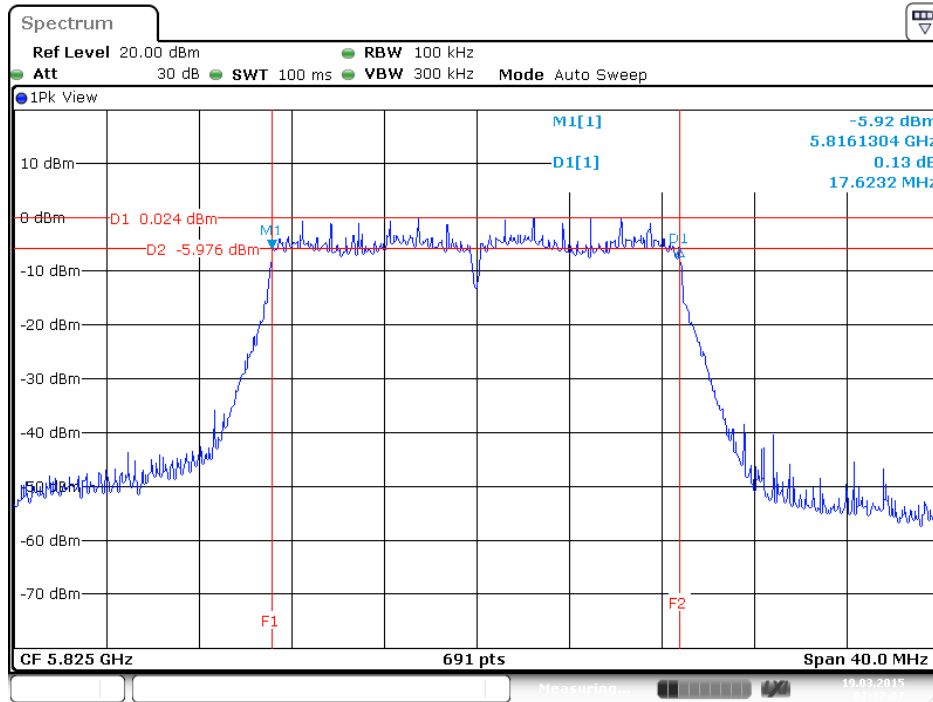

6dB Bandwidth Plot on Configuration IEEE 802.11ac 20MHz / CH 165 / MCS0 / 1S3T TXBF / Ant. 2

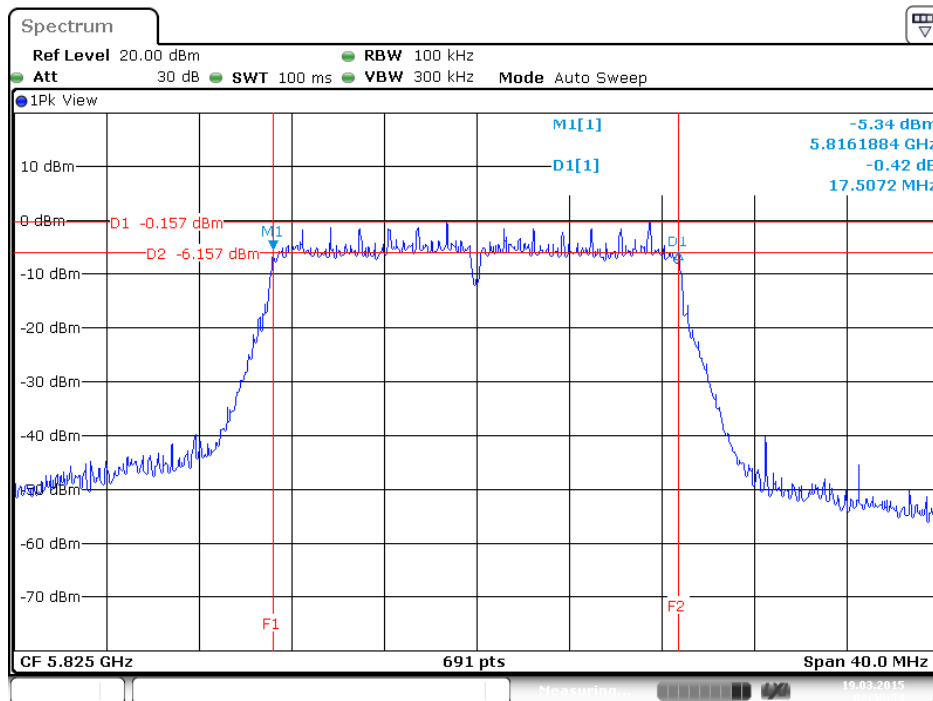

6dB Bandwidth Plot on Configuration IEEE 802.11ac 20MHz / CH 165 / MCS0 / 1S3T TXBF / Ant. 3

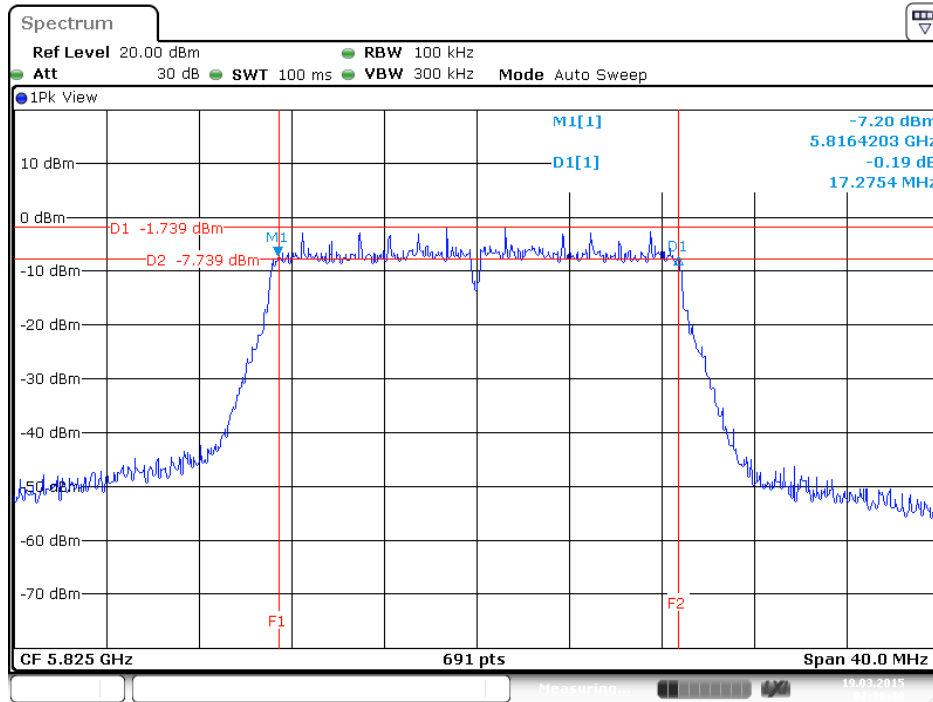

Date: 19 MAR 2015 02:36:41

Test date	Mar. 17, 2015~Mar. 25, 2015	Test Site No.	TH01-CB
Temperature	20°C	Humidity	60%
Test Engineer	Mars Lin	Configuration	802.11ac 40MHz
Duty Cycle	<Nss1MCS0, Ant. 1>: 93.24% <Nss1MCS0, 1S3T, CDD>: 93.24% <Nss1MCS0, 1S3T, TXBF>: 90.65%		

Configuration IEEE 802.11ac 40MHz

<Nss1MCS0, Ant. 1>

Channel	Frequency	6dB Bandwidth (MHz)	Max. Limit (kHz)	Result
151	5755 MHz	36.29	≥ 500	Complies
159	5795 MHz	36.06	≥ 500	Complies

<Nss1MCS0, 1S3T, CDD>

Channel	Frequency	6dB Bandwidth (MHz)			Max. Limit (kHz)	Result
		Ant. 1	Ant. 2	Ant. 3		
151	5755 MHz	36.29	35.48	36.06	≥ 500	Complies
159	5795 MHz	36.06	36.29	36.29	≥ 500	Complies

<Nss1MCS0, 1S3T, TXBF>

Channel	Frequency	6dB Bandwidth (MHz)			Max. Limit (kHz)	Result
		Ant. 1	Ant. 2	Ant. 3		
151	5755 MHz	35.48	36.29	36.06	≥ 500	Complies
159	5795 MHz	36.29	36.06	36.29	≥ 500	Complies

<Nss1MCS0, Ant. 1>:

6dB Bandwidth Plot on Configuration IEEE 802.11ac 40MHz / CH 151 / Ant. 1

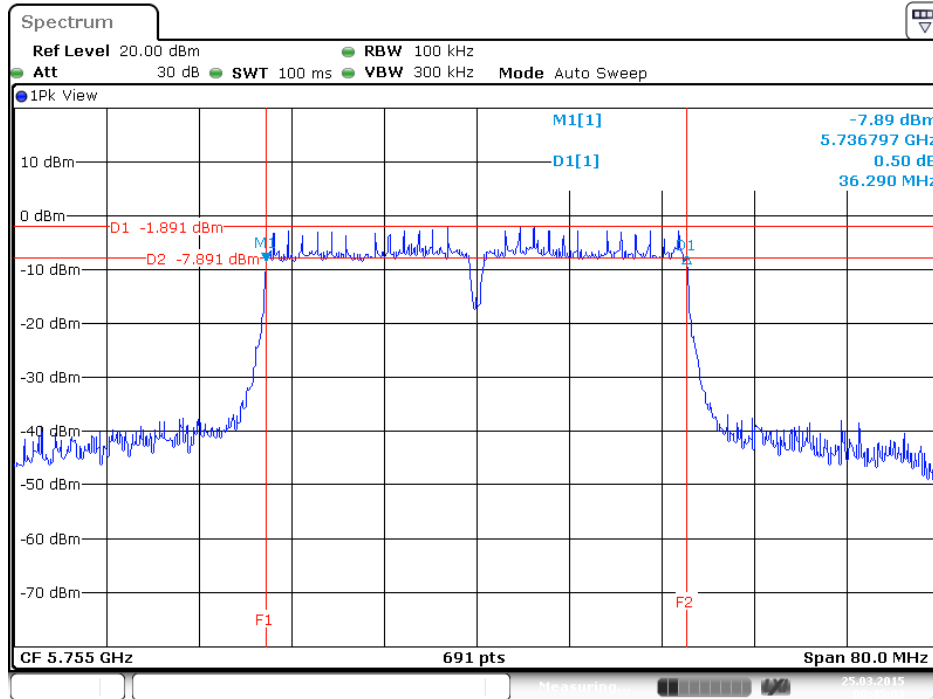

Date: 25 MAR. 2015 00:45:03

6dB Bandwidth Plot on Configuration IEEE 802.11ac 40MHz / CH 159 / Ant. 1

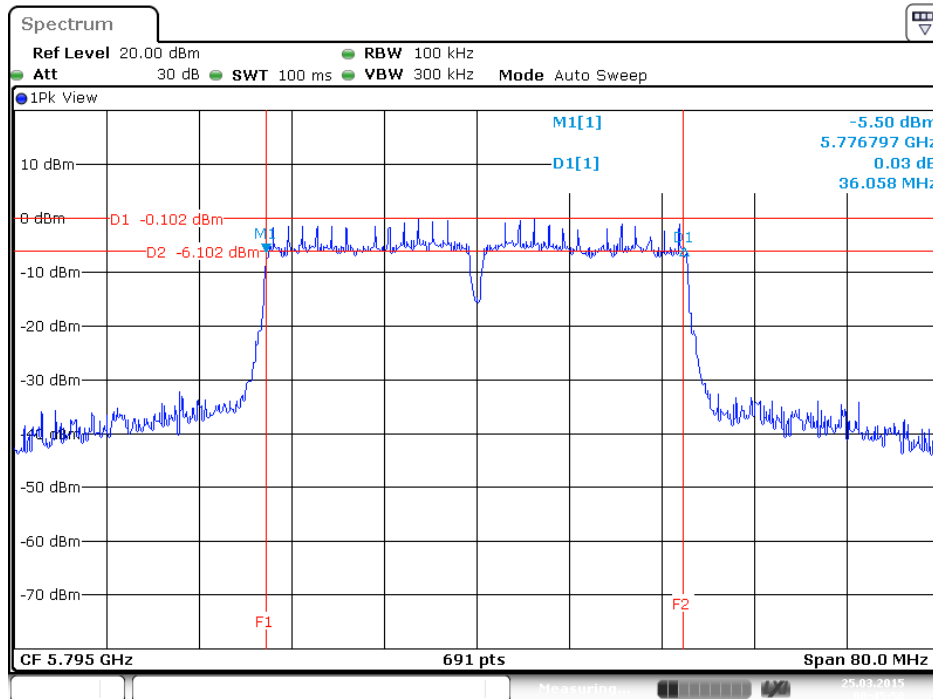

Date: 25 MAR. 2015 00:45:51

<Nss1MCS0, 1S3T, CDD>:

6dB Bandwidth Plot on Configuration IEEE 802.11ac 40MHz / CH 151 / MCS0 / 1S3T CDD / Ant. 1

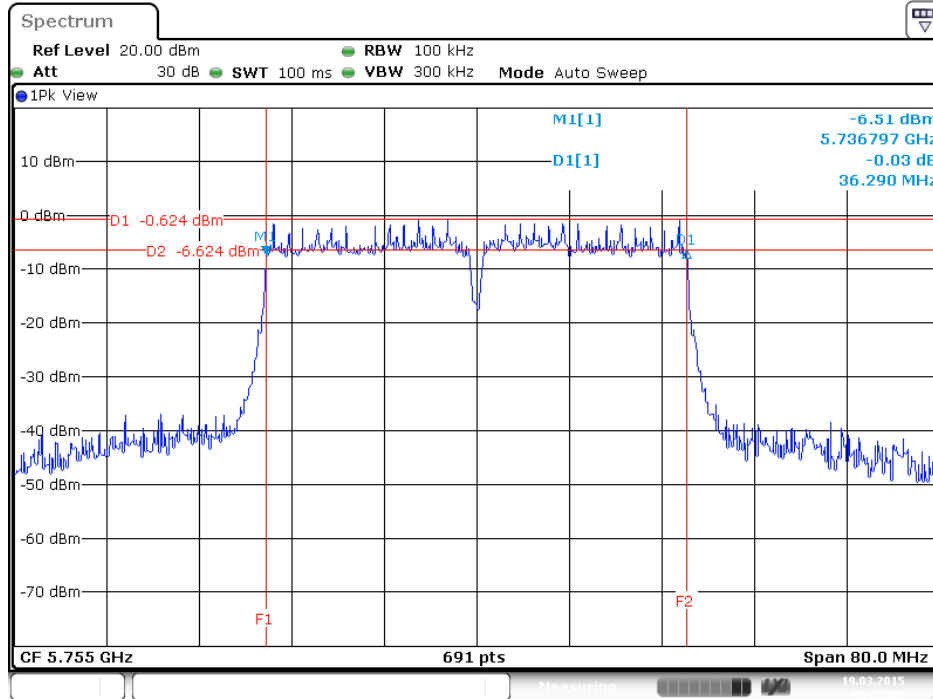

6dB Bandwidth Plot on Configuration IEEE 802.11ac 40MHz / CH 151 / MCS0 / 1S3T CDD / Ant. 2

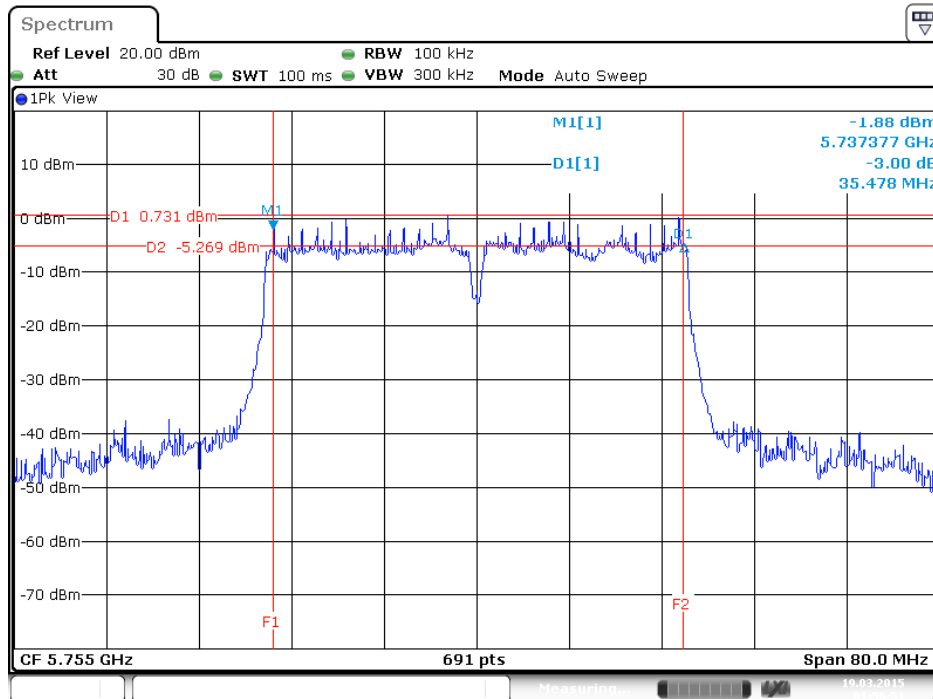

6dB Bandwidth Plot on Configuration IEEE 802.11ac 40MHz / CH 151 / MCS0 / 1S3T CDD / Ant. 3

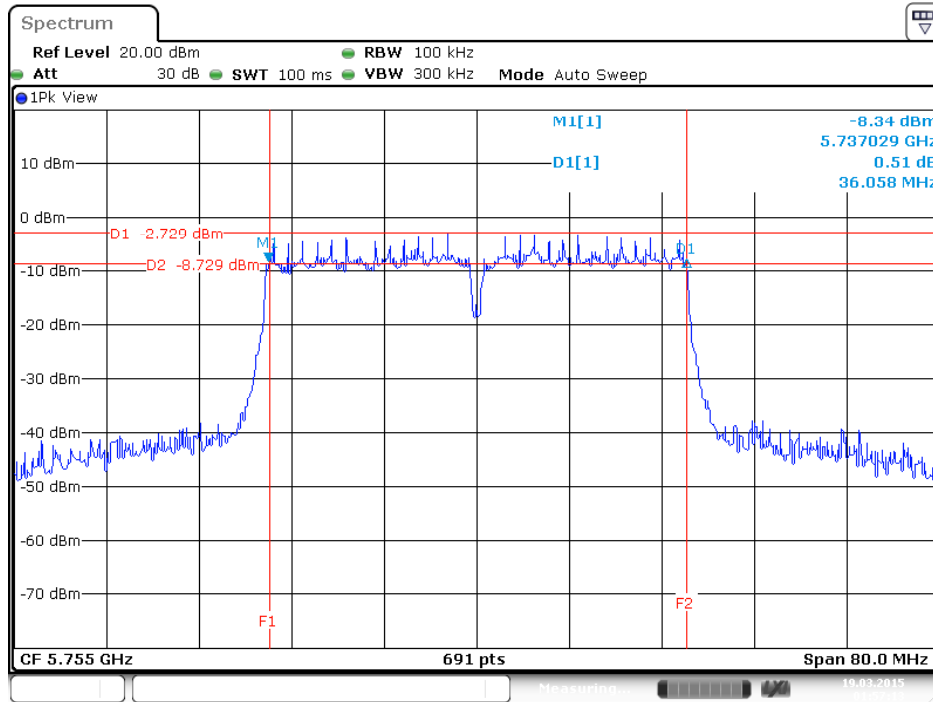

6dB Bandwidth Plot on Configuration IEEE 802.11ac 40MHz / CH 159 / MCS0 / 1S3T CDD / Ant. 1

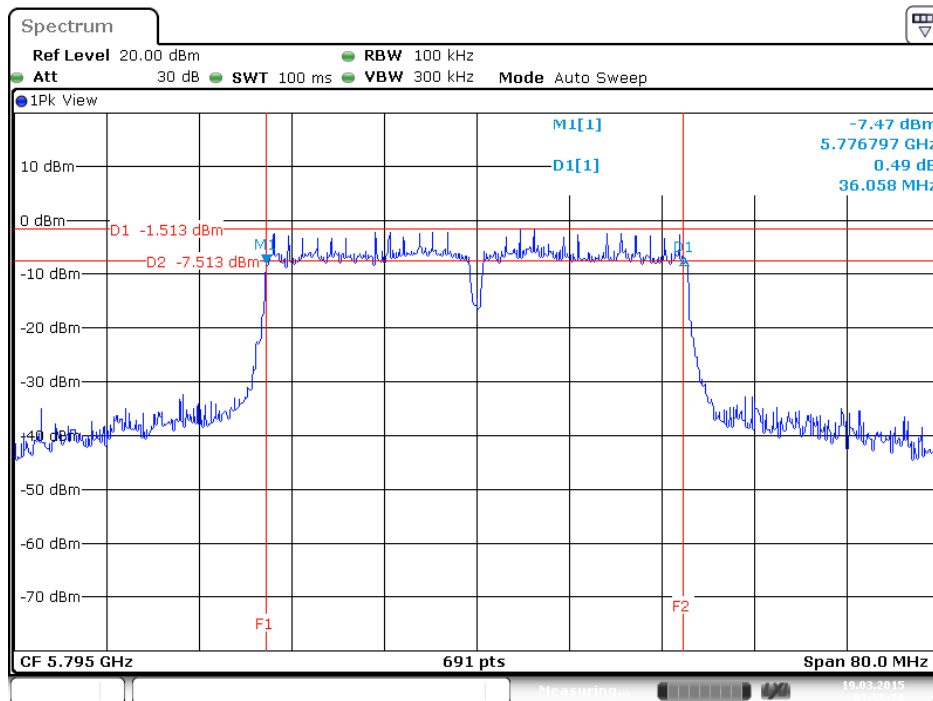

6dB Bandwidth Plot on Configuration IEEE 802.11ac 40MHz / CH 159 / MCS0 / 1S3T CDD / Ant. 2

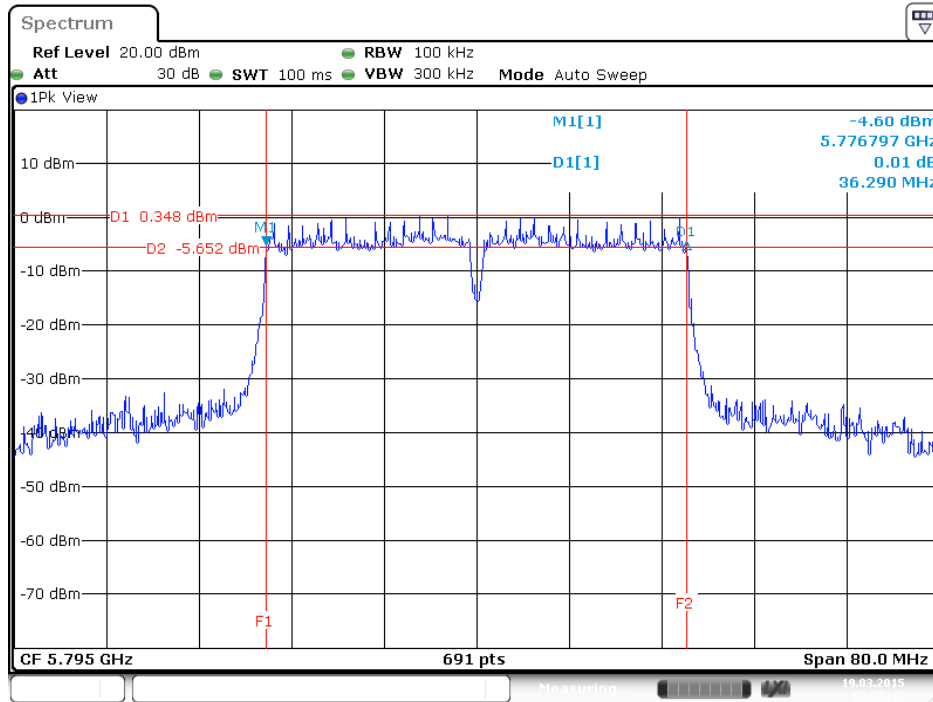

6dB Bandwidth Plot on Configuration IEEE 802.11ac 40MHz / CH 159 / MCS0 / 1S3T CDD / Ant. 3

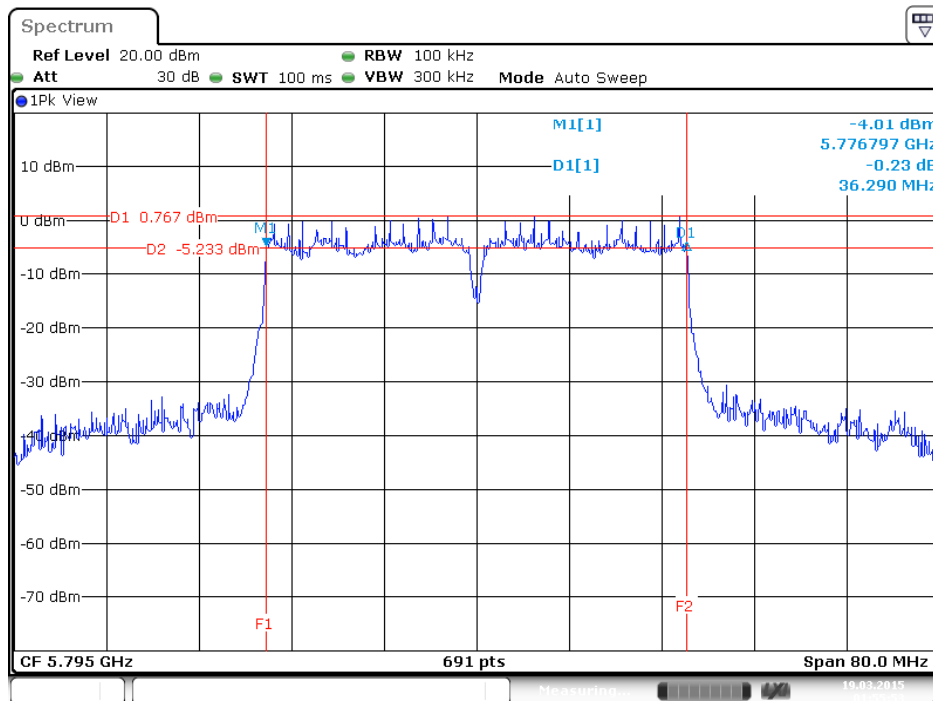

<Nss1MCS0, 1S3T, TXBF>:

6dB Bandwidth Plot on Configuration IEEE 802.11ac 40MHz / CH 151 / MCS0 / 1S3T TXBF / Ant. 1

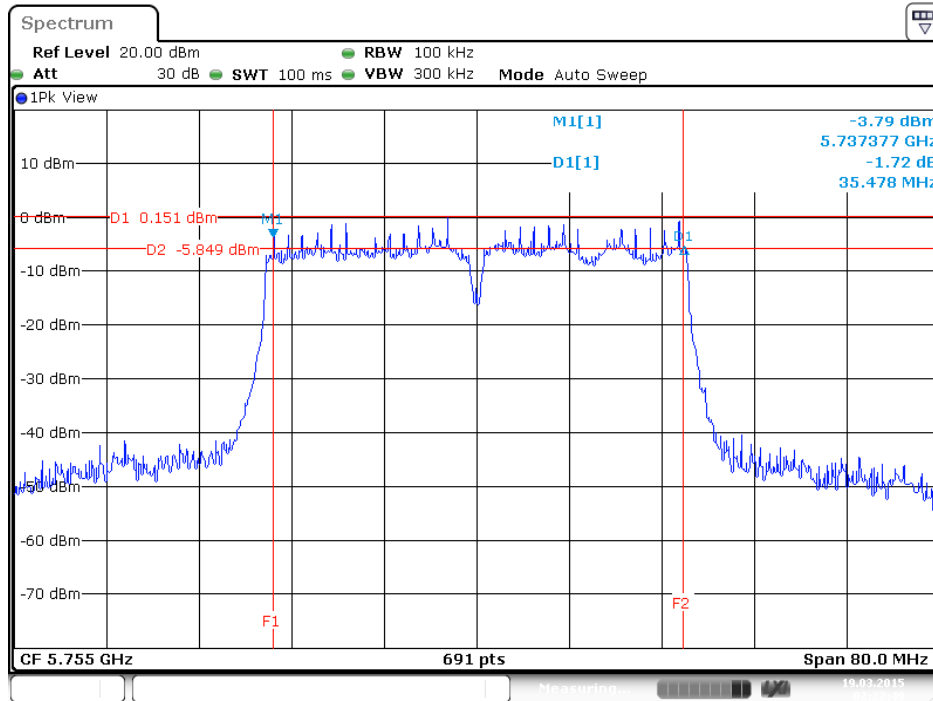

6dB Bandwidth Plot on Configuration IEEE 802.11ac 40MHz / CH 151 / MCS0 / 1S3T TXBF / Ant. 2

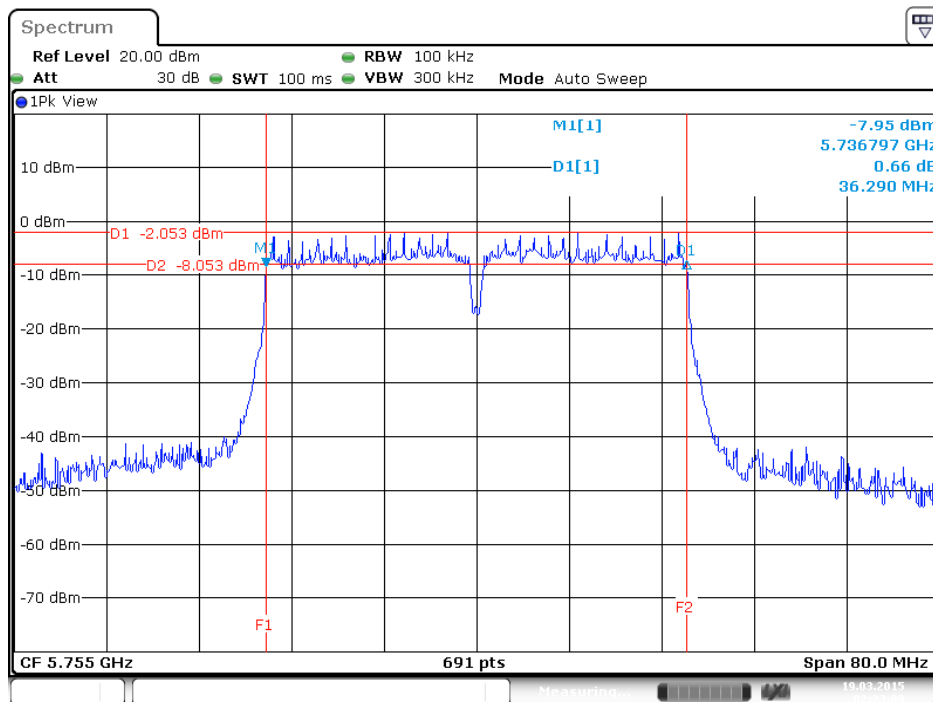

6dB Bandwidth Plot on Configuration IEEE 802.11ac 40MHz / CH 151 / MCS0 / 1S3T TXBF / Ant. 3

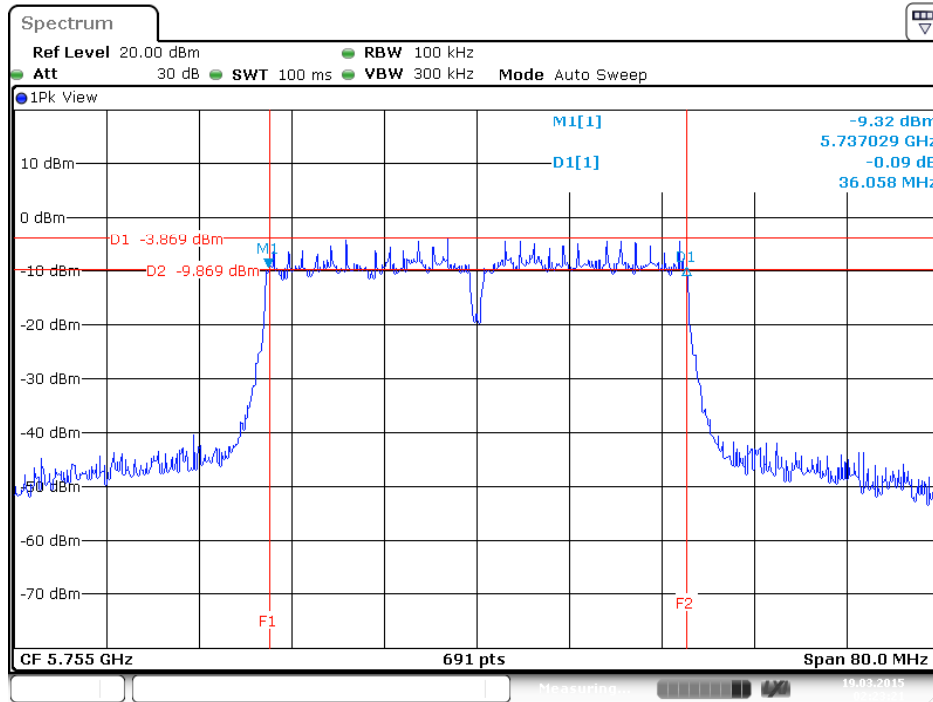

6dB Bandwidth Plot on Configuration IEEE 802.11ac 40MHz / CH 159 / MCS0 / 1S3T TXBF / Ant. 1

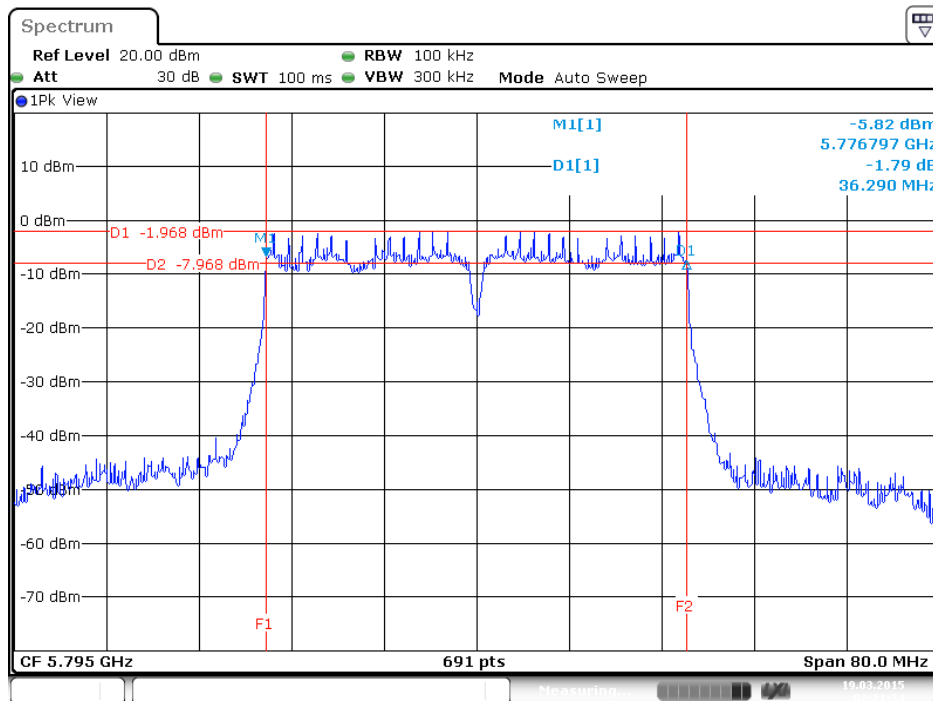

6dB Bandwidth Plot on Configuration IEEE 802.11ac 40MHz / CH 159 / MCS0 / 1S3T TXBF / Ant. 2

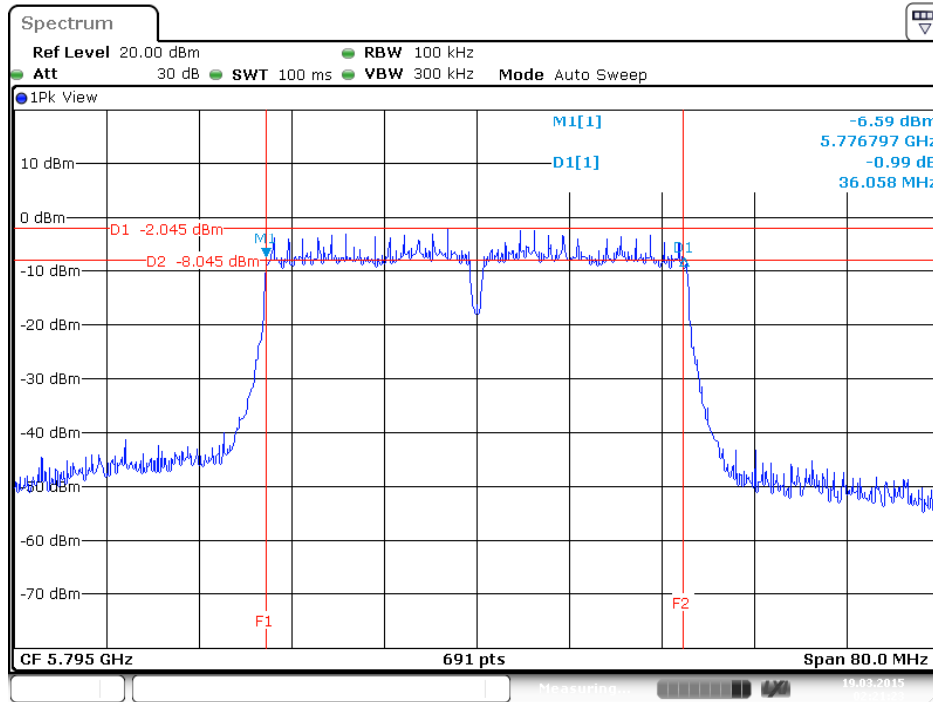

6dB Bandwidth Plot on Configuration IEEE 802.11ac 40MHz / CH 159 / MCS0 / 1S3T TXBF / Ant. 3

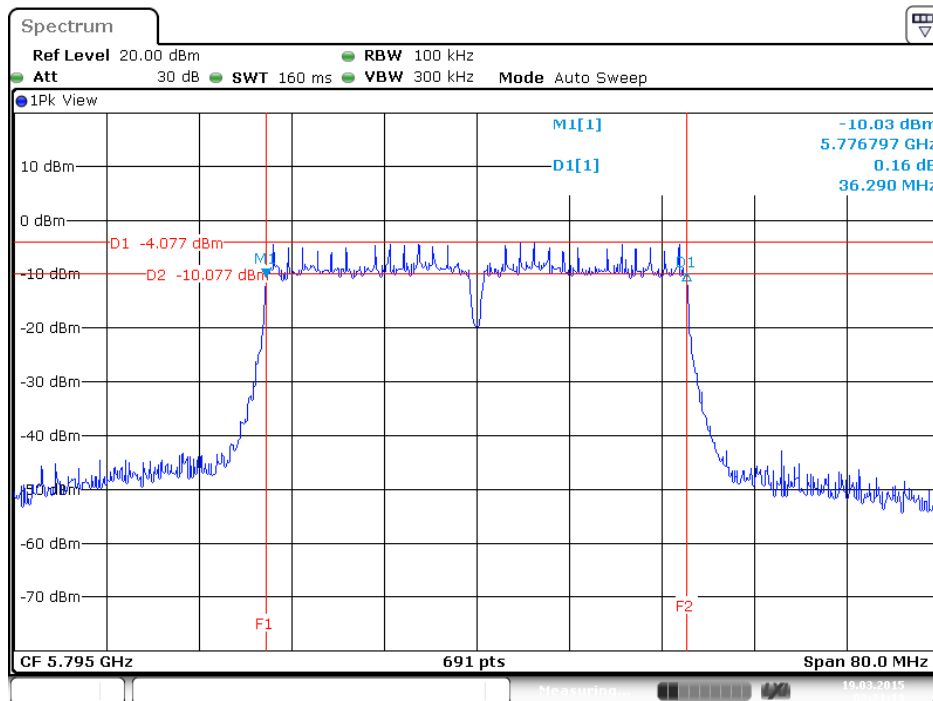

Test date	Mar. 17, 2015~Mar. 25, 2015	Test Site No.	TH01-CB
Temperature	20°C	Humidity	60%
Test Engineer	Mars Lin	Configuration	802.11ac 80MHz
Duty Cycle	<Nss1MCS0, Ant. 1>: 87.12% <Nss1MCS0, 1S3T, CDD>: 87.12% <Nss1MCS0, 1S3T, TXBF>: 79.93%		

Configuration IEEE 802.11ac 80MHz

<Nss1MCS0, Ant. 1>

Channel	Frequency	6dB Bandwidth (MHz)	Max. Limit (kHz)	Result
155	5775 MHz	75.36	≥ 500	Complies

<Nss1MCS0, 1S3T, CDD>

Channel	Frequency	6dB Bandwidth (MHz)			Max. Limit (kHz)	Result
		Ant. 1	Ant. 2	Ant. 3		
155	5775 MHz	75.07	75.36	75.36	≥ 500	Complies

<Nss1MCS0, 1S3T, TXBF>

Channel	Frequency	6dB Bandwidth (MHz)			Max. Limit (kHz)	Result
		Ant. 1	Ant. 2	Ant. 3		
155	5775 MHz	75.36	75.36	75.36	≥ 500	Complies

<Nss1MCS0, Ant. 1>:

6dB Bandwidth Plot on Configuration IEEE 802.11ac 80MHz / CH 155 / Ant. 1

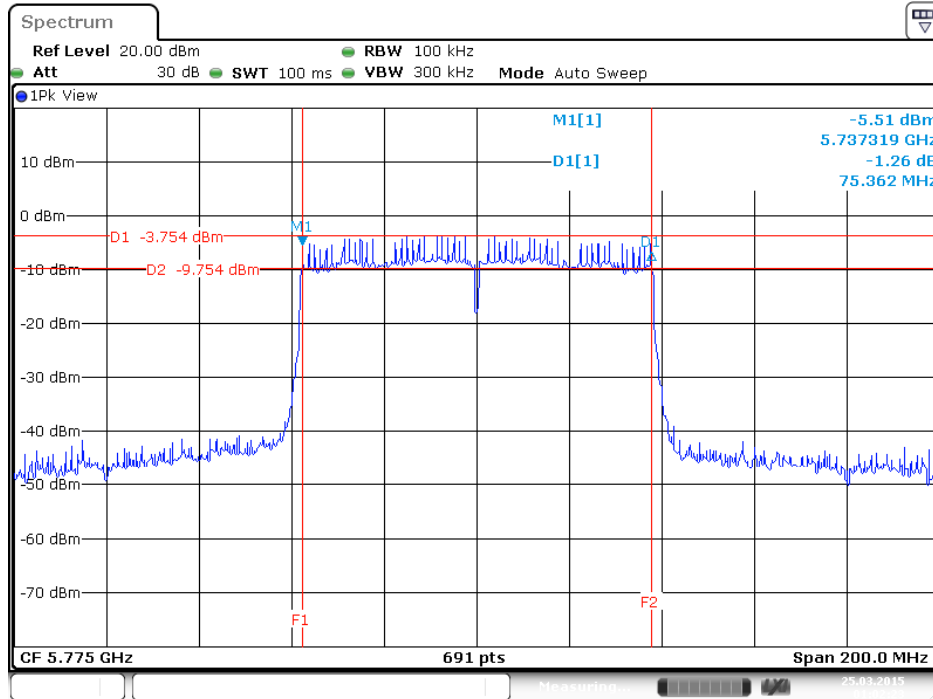

Date: 25 MAR 2015 01:02:23

<Nss1MCS0, 1S3T, CDD>:

6dB Bandwidth Plot on Configuration IEEE 802.11ac 80MHz / CH 155 / MCS0 / 1S3T CDD / Ant. 1

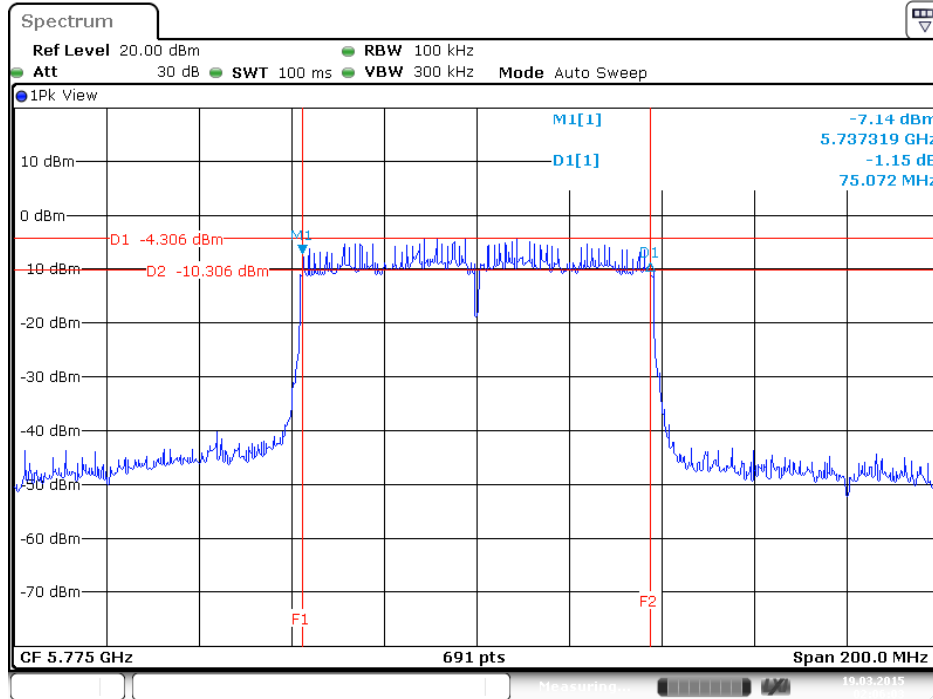

Date: 19 MAR 2015 02:06:03

6dB Bandwidth Plot on Configuration IEEE 802.11ac 80MHz / CH 155 / MCS0 / 1S3T CDD / Ant. 2

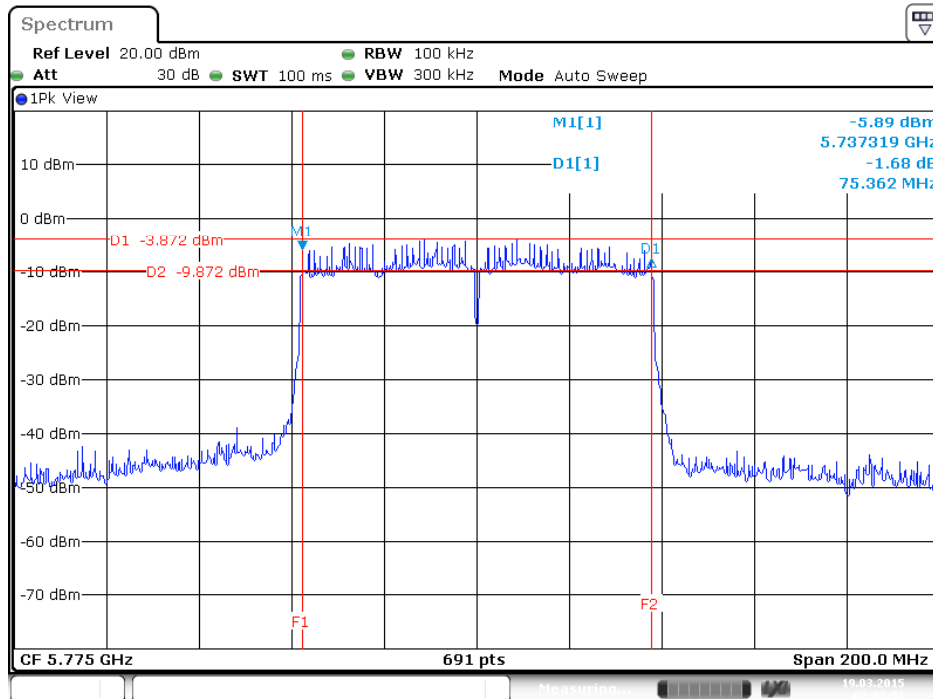

Date: 19 MAR 2015 02:07:51

6dB Bandwidth Plot on Configuration IEEE 802.11ac 80MHz / CH 155 / MCS0 / 1S3T CDD / Ant. 3

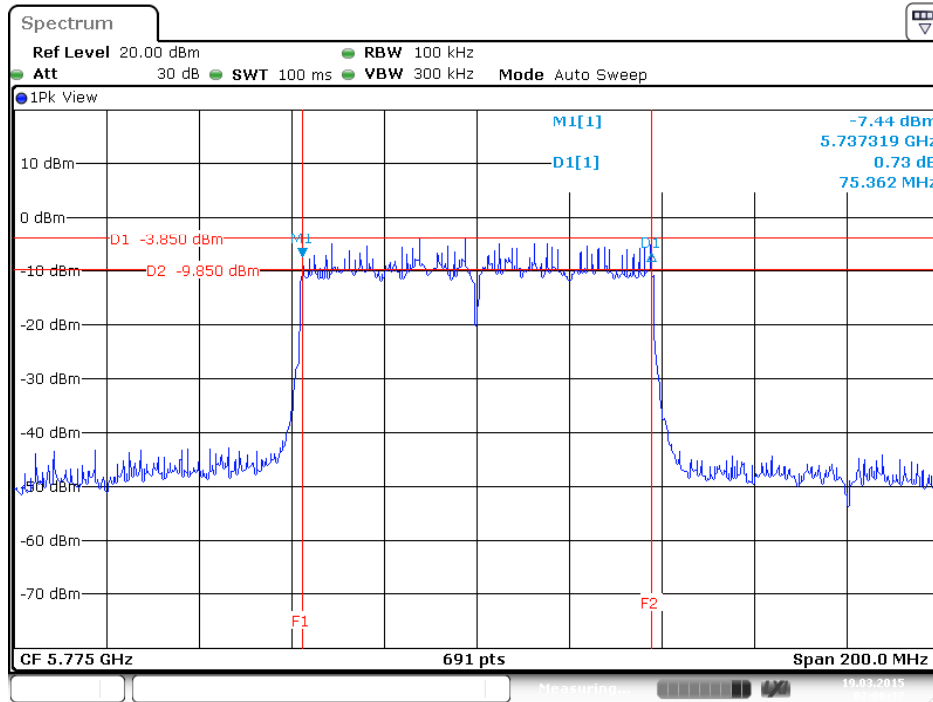

Date: 19 MAR 2015 02:06:38

<Nss1MCS0, 1S3T, TXBF>:

6dB Bandwidth Plot on Configuration IEEE 802.11ac 80MHz / CH 155 / MCS0 / 1S3T TXBF / Ant. 1

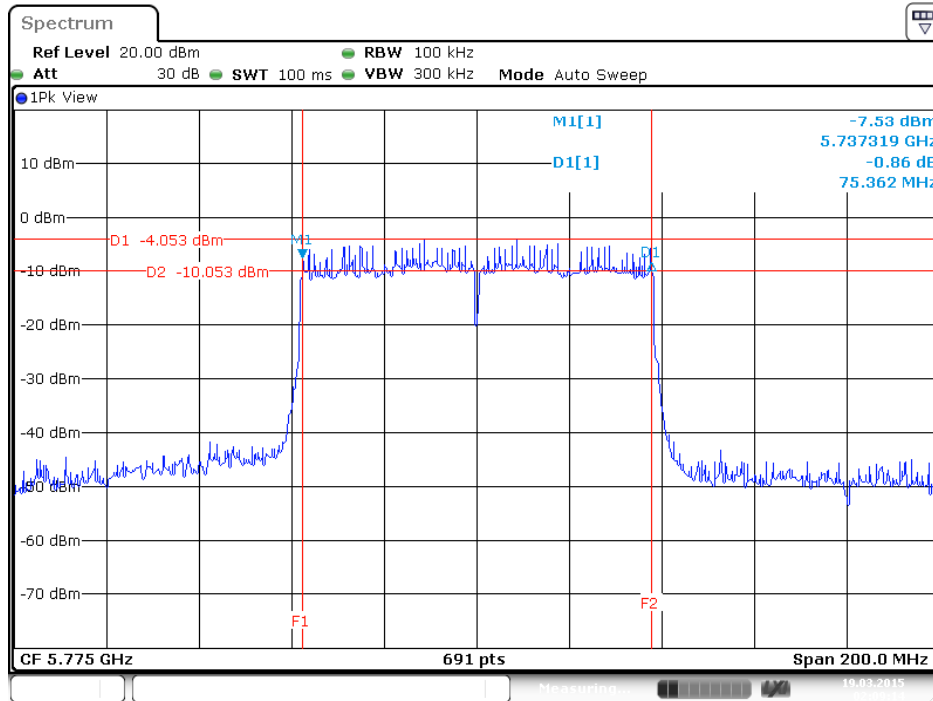

6dB Bandwidth Plot on Configuration IEEE 802.11ac 80MHz / CH 155 / MCS0 / 1S3T TXBF / Ant. 2

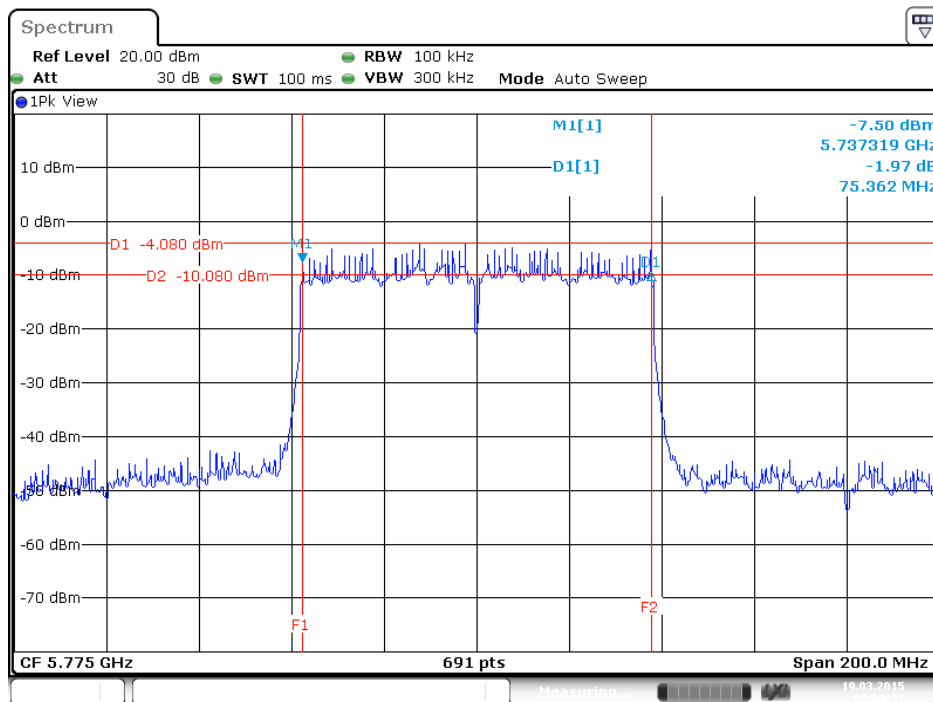

6dB Bandwidth Plot on Configuration IEEE 802.11ac 80MHz / CH 155 / MCS0 / 1S3T TXBF / Ant. 3

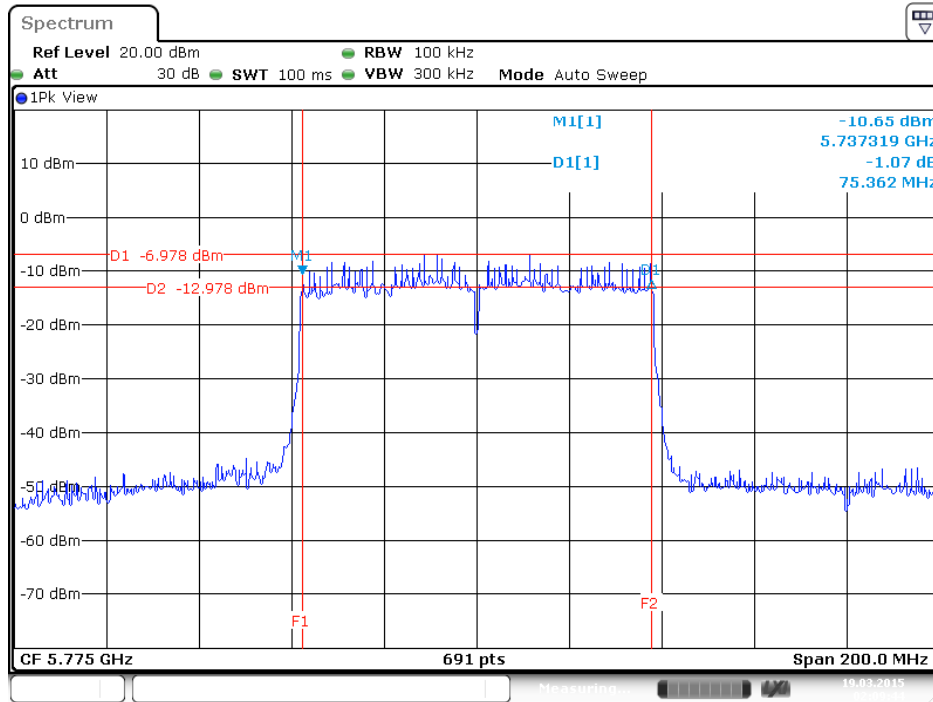

Date: 19 MAR 2015 02:09:45

3.3 Maximum Conducted Output Power Measurement

3.3.1 Limit

Operation Band	EUT Category		LIMIT
U-NII-1		Outdoor Access Point	1 Watt (30 dBm) (Max. e.i.r.p ≤ 125mW (21 dBm) at any elevation angle above 30 degrees as measured from the horizon)
		Fixed point-to-point Access Point	1 Watt (30 dBm)
	v	Indoor Access Point	1 Watt (30 dBm)
		Mobile and Portable client device	250mW (24 dBm)
U-NII-2A	v	---	250mW (24 dBm) or 11 dBm+10 log B*
U-NII-2C	v	---	250mW (24 dBm) or 11 dBm+10 log B*
U-NII-3	v	---	1 Watt (30 dBm)

Note: *B is the 26 dB emission bandwidth in megahertz

3.3.2 Measuring Instruments and Setting

Please refer to section 4 of equipments list in this report. The following table is the setting of Power Meter

Power Meter Parameter	Setting
Filter No.	Auto
Measurement time	0.135 s ~ 26 s
Power Sensor	U2021XA

3.3.3 Test Procedures

1. Test was performed in accordance with Measurement of Digital Transmission Systems Operating under 789033 D02 General UNII Test Procedures New Rules v01, in section "Maximum conducted output power Method (3)", 06/06/2014
2. The average power sensor was used on the output port of the EUT. A power meter was used to read the response of the average power sensor to get the all on time transmission. Record the average power level.
3. When measuring maximum conducted output power with multiple antenna systems, add every result of the values by mathematic formula.
4. Adjust the measurement in dBm by adding 10 log(1/x) where x is the duty cycle. Record the average power level.

3.3.4 Test Setup Layout

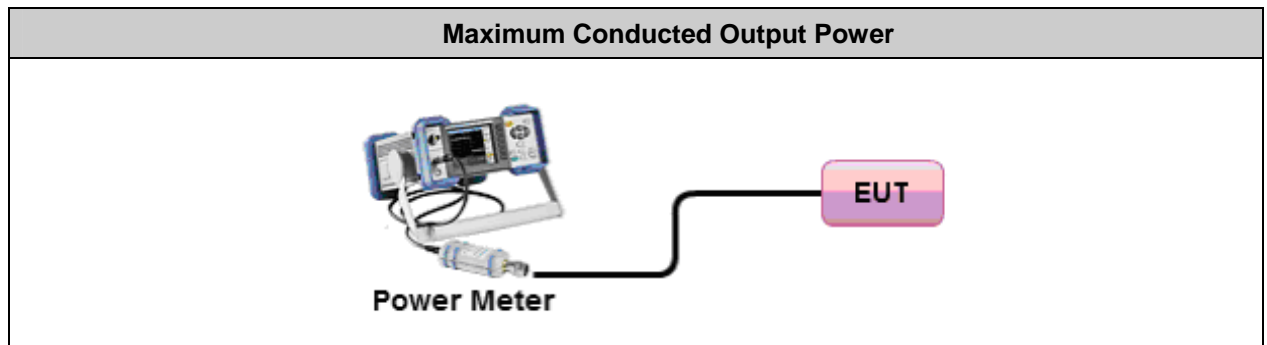

3.3.5 Test Deviation

There is no deviation with the original standard.

3.3.6 EUT Operation during Test

The EUT was programmed to be in continuously transmitting mode.

3.3.7 Test Result for Maximum Conducted Output Power

Test date	Mar. 17, 2015~Mar. 25, 2015	Test Site No.	TH01-CB
Temperature	20°C	Humidity	60%
Test Engineer	Mars Lin	Configuration	802.11a
Duty Cycle	<6Mbps, Ant. 1 >: 98.09% <6Mbps, 1S3T, CDD>: 98.09%		

Configuration IEEE 802.11a

<6Mbps, Ant. 1 >

Channel	Frequency	Conducted Power (dBm)		Antenna Gain	Max. Limit (dBm)	Result
		Ant. 1	Total			
36	5180 MHz	17.39	17.39	3.82	30.00	Complies
40	5200 MHz	17.64	17.64	3.86	30.00	Complies
48	5240 MHz	20.09	20.09	3.83	30.00	Complies
149	5745 MHz	18.04	18.04	4.33	30.00	Complies
157	5785 MHz	16.48	16.48	4.67	30.00	Complies
165	5825 MHz	15.33	15.33	4.46	30.00	Complies

Note:

- 5180 MHz= Antenna Gain= 3.82dBi <6dBi, so the limit doesn't reduce.
- 5200 MHz= Antenna Gain= 3.86dBi <6dBi, so the limit doesn't reduce.
- 5240 MHz= Antenna Gain= 3.83dBi <6dBi, so the limit doesn't reduce.
- 5745 MHz= Antenna Gain= 4.33dBi <6dBi, so the limit doesn't reduce.
- 5785 MHz= Antenna Gain= 4.67dBi <6dBi, so the limit doesn't reduce.
- 5825 MHz= Antenna Gain= 4.46dBi <6dBi, so the limit doesn't reduce.

<6Mbps, 1S3T, CDD>

Channel	Frequency	Conducted Power (dBm)				Antenna Gain	Max. Limit (dBm)	Result
		Ant. 1	Ant. 2	Ant. 3	Total			
36	5180 MHz	11.96	11.47	11.33	16.37	5.15	30.00	Complies
40	5200 MHz	12.22	11.41	11.54	16.51	4.91	30.00	Complies
48	5240 MHz	16.67	16.57	16.08	21.22	4.50	30.00	Complies
149	5745 MHz	15.33	14.39	14.85	19.64	5.27	30.00	Complies
157	5785 MHz	13.19	12.35	12.48	17.46	5.51	30.00	Complies
165	5825 MHz	12.54	11.36	11.65	16.65	5.32	30.00	Complies

Note 1:

- 5180 MHz= Antenna Gain= 5.15dBi <6dBi, so the limit doesn't reduce..
- 5200 MHz= Antenna Gain= 4.91dBi <6dBi, so the limit doesn't reduce.
- 5240 MHz= Antenna Gain= 4.50dBi <6dBi, so the limit doesn't reduce.
- 5745 MHz= Antenna Gain= 5.27dBi <6dBi, so the limit doesn't reduce.
- 5785 MHz= Antenna Gain= 5.51dBi <6dBi, so the limit doesn't reduce.
- 5825 MHz= Antenna Gain= 5.32dBi <6dBi, so the limit doesn't reduce.

Note 2:

- For power measurements onf IEEE 802.11 devices:
- Directional gain= G ANT + Array Gain
- Arry Gain= 0 dB (i.e., no array gain) for $N_{ANT} \leq 4$.

Test date	Mar. 17, 2015~Mar. 25, 2015	Test Site No.	TH01-CB
Temperature	20°C	Humidity	60%
Test Engineer	Mars Lin	Configuration	802.11ac 20MHz
Duty Cycle	<Nss1MCS0, Ant. 1>: 98.97% <Nss1MCS0, 1S3T, CDD>: 98.97% <Nss1MCS0, 1S3T, TXBF>: 99.23%		

Configuration IEEE 802.11ac 20MHz

<Nss1MCS0, Ant. 1>

Channel	Frequency	Conducted Power (dBm)		Antenna Gain	Max. Limit (dBm)	Result
		Ant. 1	Total			
36	5180 MHz	17.16	17.16	3.82	30.00	Complies
40	5200 MHz	16.85	16.85	3.86	30.00	Complies
48	5240 MHz	20.05	20.05	3.83	30.00	Complies
149	5745 MHz	17.23	17.23	4.33	30.00	Complies
157	5785 MHz	15.64	15.64	4.67	30.00	Complies
165	5825 MHz	15.35	15.35	4.46	30.00	Complies

Note:

- 5180 MHz= Antenna Gain= 3.82dBi <6dBi, so the limit doesn't reduce.
- 5200 MHz= Antenna Gain= 3.86dBi <6dBi, so the limit doesn't reduce.
- 5240 MHz= Antenna Gain= 3.83dBi <6dBi, so the limit doesn't reduce.
- 5745 MHz= Antenna Gain= 4.33dBi <6dBi, so the limit doesn't reduce.
- 5785 MHz= Antenna Gain= 4.67dBi <6dBi, so the limit doesn't reduce.
- 5825 MHz= Antenna Gain= 4.46dBi <6dBi, so the limit doesn't reduce.

<Nss1MCS0, 1S3T, CDD>

Channel	Frequency	Conducted Power (dBm)				Antenna Gain	Max. Limit (dBm)	Result
		Ant. 1	Ant. 2	Ant. 3	Total			
36	5180 MHz	13.20	12.78	12.63	17.65	5.15	30.00	Complies
40	5200 MHz	12.98	12.65	12.29	17.42	4.91	30.00	Complies
48	5240 MHz	18.36	18.53	18.52	23.24	4.50	30.00	Complies
149	5745 MHz	16.49	15.26	15.59	20.58	5.27	30.00	Complies
157	5785 MHz	14.51	13.25	14.02	18.73	5.51	30.00	Complies
165	5825 MHz	14.63	13.28	13.97	18.77	5.32	30.00	Complies

Note 1:

- 5180 MHz= Antenna Gain= 5.15dBi <6dBi, so the limit doesn't reduce..
- 5200 MHz= Antenna Gain= 4.91dBi <6dBi, so the limit doesn't reduce.
- 5240 MHz= Antenna Gain= 4.50dBi <6dBi, so the limit doesn't reduce.
- 5745 MHz= Antenna Gain= 5.27dBi <6dBi, so the limit doesn't reduce.
- 5785 MHz= Antenna Gain= 5.51dBi <6dBi, so the limit doesn't reduce.
- 5825 MHz= Antenna Gain= 5.32dBi <6dBi, so the limit doesn't reduce.

Note 2:

For power measurements onf IEEE 802.11 devices:
 Directional gain= G ANT + Array Gain
 Arry Gain= 0 dB (i.e., no array gain) for N_{ANT} ≤ 4.

<Nss1MCS0, 1S3T, TXBF >

Channel	Frequency	Conducted Power (dBm)				Directional Gain	Max. Limit (dBm)	Result
		Ant. 1	Ant. 2	Ant. 3	Total			
36	5180 MHz	14.44	14.02	13.59	18.80	6.51	29.49	Complies
40	5200 MHz	11.59	11.17	11.19	16.09	6.40	29.60	Complies
48	5240 MHz	17.24	16.51	16.83	21.64	6.26	29.74	Complies
149	5745 MHz	15.33	14.39	14.85	19.64	6.25	29.75	Complies
157	5785 MHz	13.74	12.60	13.16	17.96	6.45	29.55	Complies
165	5825 MHz	13.23	12.25	12.76	17.54	6.43	29.57	Complies

Note:

$$5180 \text{ MHz} = \text{Directional Gain} = 10 \cdot \log \left[\frac{\sum_{j=1}^{N_{SS}} \left\{ \sum_{k=1}^{N_{ANT}} g_{j,k} \right\}^2}{N_{ANT}} \right] = 6.51 \text{ dBi} > 6 \text{ dBi}, \text{ So } 5180 \text{ MHz Limit} = 30 - (6.51 - 6) = 29.49 \text{ dBm/MHz}$$

$$5200 \text{ MHz} = \text{Directional Gain} = 10 \cdot \log \left[\frac{\sum_{j=1}^{N_{SS}} \left\{ \sum_{k=1}^{N_{ANT}} g_{j,k} \right\}^2}{N_{ANT}} \right] = 6.40 \text{ dBi} > 6 \text{ dBi}, \text{ So } 5200 \text{ MHz Limit} = 30 - (6.40 - 6) = 29.60 \text{ dBm/MHz}$$

$$5240 \text{ MHz} = \text{Directional Gain} = 10 \cdot \log \left[\frac{\sum_{j=1}^{N_{SS}} \left\{ \sum_{k=1}^{N_{ANT}} g_{j,k} \right\}^2}{N_{ANT}} \right] = 6.26 \text{ dBi} > 6 \text{ dBi}, \text{ So } 5240 \text{ MHz Limit} = 30 - (6.26 - 6) = 29.74 \text{ dBm/MHz}$$

$$5745 \text{ MHz} = \text{Directional Gain} = 10 \cdot \log \left[\frac{\sum_{j=1}^{N_{SS}} \left\{ \sum_{k=1}^{N_{ANT}} g_{j,k} \right\}^2}{N_{ANT}} \right] = 6.25 \text{ dBi} > 6 \text{ dBi}, \text{ So } 5745 \text{ MHz Limit} = 30 - (6.25 - 6) = 29.75 \text{ dBm/MHz}$$

$$5785 \text{ MHz} = \text{Directional Gain} = 10 \cdot \log \left[\frac{\sum_{j=1}^{N_{SS}} \left\{ \sum_{k=1}^{N_{ANT}} g_{j,k} \right\}^2}{N_{ANT}} \right] = 6.45 \text{ dBi} > 6 \text{ dBi}, \text{ So } 5785 \text{ MHz Limit} = 30 - (6.45 - 6) = 29.55 \text{ dBm/MHz}$$

$$5825 \text{ MHz} = \text{Directional Gain} = 10 \cdot \log \left[\frac{\sum_{j=1}^{N_{SS}} \left\{ \sum_{k=1}^{N_{ANT}} g_{j,k} \right\}^2}{N_{ANT}} \right] = 6.43 \text{ dBi} > 6 \text{ dBi}, \text{ So } 5825 \text{ MHz Limit} = 30 - (6.43 - 6) = 29.57 \text{ dBm/MHz}$$

Test date	Mar. 17, 2015~Mar. 25, 2015	Test Site No.	TH01-CB
Temperature	20°C	Humidity	60%
Test Engineer	Mars Lin	Configuration	802.11ac 40MHz
Duty Cycle	<Nss1MCS0, Ant. 1>: 93.24% <Nss1MCS0, 1S3T, CDD>: 93.24% <Nss1MCS0, 1S3T, TXBF>: 90.65%		

Configuration IEEE 802.11ac 40MHz

<Nss1MCS0, Ant. 1>

Channel	Frequency	Conducted Power (dBm)		Antenna Gain	Max. Limit (dBm)	Result
		Ant. 1	Total			
38	5190 MHz	17.49	17.49	3.96	30.00	Complies
46	5230 MHz	18.82	18.82	3.76	30.00	Complies
151	5755 MHz	15.92	15.92	4.45	30.00	Complies
159	5795 MHz	16.99	16.99	4.69	30.00	Complies

Note:

- 5190 MHz= Antenna Gain= 3.96dBi <6dBi, so the limit doesn't reduce.
- 5230 MHz= Antenna Gain= 3.76dBi <6dBi, so the limit doesn't reduce.
- 5755 MHz= Antenna Gain= 4.45dBi <6dBi, so the limit doesn't reduce.
- 5795 MHz= Antenna Gain= 4.96dBi <6dBi, so the limit doesn't reduce.

<Nss1MCS0, 1S3T, CDD>

Channel	Frequency	Conducted Power (dBm)				Antenna Gain	Max. Limit (dBm)	Result
		Ant. 1	Ant. 2	Ant. 3	Total			
38	5190 MHz	16.26	15.77	15.80	20.72	5.03	30.00	Complies
46	5230 MHz	15.12	14.67	14.75	19.62	4.54	30.00	Complies
151	5755 MHz	15.69	14.75	15.15	19.99	5.25	30.00	Complies
159	5795 MHz	16.81	16.01	16.44	21.20	5.53	30.00	Complies

Note 1:

- 5190 MHz= Antenna Gain= 5.03dBi <6dBi, so the limit doesn't reduce.
- 5230 MHz= Antenna Gain= 4.54dBi <6dBi, so the limit doesn't reduce.
- 5755 MHz= Antenna Gain= 5.25dBi <6dBi, so the limit doesn't reduce.
- 5795 MHz= Antenna Gain= 5.53dBi <6dBi, so the limit doesn't reduce.

Note 2:

- For power measurements on IEEE 802.11 devices:
- Directional gain= G ANT + Array Gain
- Array Gain= 0 dB (i.e., no array gain) for $N_{ANT} \leq 4$.

<Nss1MCS0, 1S3T, TXBF >

Channel	Frequency	Conducted Power (dBm)				Directional Gain	Max. Limit (dBm)	Result
		Ant. 1	Ant. 2	Ant. 3	Total			
38	5190 MHz	15.07	14.59	14.28	19.43	6.47	29.53	Complies
46	5230 MHz	13.33	13.25	13.08	17.99	6.25	29.75	Complies
151	5755 MHz	15.25	14.00	14.13	19.27	6.35	29.65	Complies
159	5795 MHz	14.54	13.52	13.69	18.71	6.44	29.56	Complies

Note:

$$5190 \text{ MHz} = \text{Directional Gain} = 10 \cdot \log \left[\frac{\sum_{j=1}^{N_{SS}} \left\{ \sum_{k=1}^{N_{ANT}} g_{j,k} \right\}^2}{N_{ANT}} \right] = 6.47 \text{ dBi} > 6 \text{ dBi}, \text{ So } 5190 \text{ MHz Limit} = 30 - (6.47 - 6) = 29.53 \text{ dBm/MHz}$$

$$5230 \text{ MHz} = \text{Directional Gain} = 10 \cdot \log \left[\frac{\sum_{j=1}^{N_{SS}} \left\{ \sum_{k=1}^{N_{ANT}} g_{j,k} \right\}^2}{N_{ANT}} \right] = 6.25 \text{ dBi} > 6 \text{ dBi}, \text{ So } 5230 \text{ MHz Limit} = 30 - (6.25 - 6) = 29.75 \text{ dBm/MHz}$$

$$5755 \text{ MHz} = \text{Directional Gain} = 10 \cdot \log \left[\frac{\sum_{j=1}^{N_{SS}} \left\{ \sum_{k=1}^{N_{ANT}} g_{j,k} \right\}^2}{N_{ANT}} \right] = 6.35 \text{ dBi} > 6 \text{ dBi}, \text{ So } 5755 \text{ MHz Limit} = 30 - (6.35 - 6) = 29.65 \text{ dBm/MHz}$$

$$5795 \text{ MHz} = \text{Directional Gain} = 10 \cdot \log \left[\frac{\sum_{j=1}^{N_{SS}} \left\{ \sum_{k=1}^{N_{ANT}} g_{j,k} \right\}^2}{N_{ANT}} \right] = 6.44 \text{ dBi} > 6 \text{ dBi}, \text{ So } 5795 \text{ MHz Limit} = 30 - (6.44 - 6) = 29.56 \text{ dBm/MHz}$$

Test date	Mar. 17, 2015~Mar. 25, 2015	Test Site No.	TH01-CB
Temperature	20°C	Humidity	60%
Test Engineer	Mars Lin	Configuration	802.11ac 80MHz
Duty Cycle	<Nss1MCS0, Ant. 1>: 87.12% <Nss1MCS0, 1S3T, CDD>: 87.12% <Nss1MCS0, 1S3T, TXBF>: 79.93%		

Configuration IEEE 802.11ac 80MHz

<Nss1MCS0, Ant. 1>

Channel	Frequency	Conducted Power (dBm)		Antenna Gain	Max. Limit (dBm)	Result
		Ant. 1	Total			
42	5210 MHz	14.41	14.41	3.87	30.00	Complies
155	5775 MHz	14.11	14.11	4.64	30.00	Complies

Note:

5190 MHz= Antenna Gain= 3.87dBi <6dBi, so the limit doesn't reduce.

5775 MHz= Antenna Gain= 4.64dBi <6dBi, so the limit doesn't reduce.

<Nss1MCS0, 1S3T, CDD>

Channel	Frequency	Conducted Power (dBm)				Antenna Gain	Max. Limit (dBm)	Result
		Ant. 1	Ant. 2	Ant. 3	Total			
42	5210 MHz	13.62	13.12	13.13	18.07	4.82	30.00	Complies
155	5775 MHz	13.48	13.12	13.25	18.06	5.48	30.00	Complies

Note 1:

5210 MHz= Antenna Gain= 4.82dBi <6dBi, so the limit doesn't reduce.

5775 MHz= Antenna Gain= 5.48dBi <6dBi, so the limit doesn't reduce.

Note 2:

For power measurements onf IEEE 802.11 devices:

Directional gain= $G_{ANT} + \text{Array Gain}$

Arry Gain= 0 dB (i.e., no array gain) for $N_{ANT} \leq 4$.

<Nss1MCS0, 1S3T, TXBF >

Channel	Frequency	Conducted Power (dBm)				Directional Gain	Max. Limit (dBm)	Result
		Ant. 1	Ant. 2	Ant. 3	Total			
42	5210 MHz	14.01	13.62	13.49	18.48	6.40	29.60	Complies
155	5775 MHz	13.01	12.81	12.82	17.65	6.45	29.55	Complies

Note:

$$5210 \text{ MHz} = \text{Directional Gain} = 10 \cdot \log \left[\frac{\sum_{j=1}^{N_{CS}} \left\{ \sum_{k=1}^{N_{ANT}} g_{j,k} \right\}^2}{N_{ANT}} \right] = 6.40 \text{ dBi} > 6 \text{ dBi}, \text{ So } 5210 \text{ MHz Limit} = 30 - (6.40 - 6) = 29.60 \text{ dBm/MHz}$$

$$5775 \text{ MHz} = \text{Directional Gain} = 10 \cdot \log \left[\frac{\sum_{j=1}^{N_{CS}} \left\{ \sum_{k=1}^{N_{ANT}} g_{j,k} \right\}^2}{N_{ANT}} \right] = 6.45 \text{ dBi} > 6 \text{ dBi}, \text{ So } 5775 \text{ MHz Limit} = 30 - (6.45 - 6) = 29.55 \text{ dBm/MHz}$$

3.4 Power Spectral Density Measurement

3.4.1 Limit

Operation Band	EUT Category		LIMIT
U-NII-1		Outdoor Access Point	17dBm/ MHz
		Fixed point-to-point Access Point	
	v	Indoor Access Point	
		Mobile and Portable client device	11dBm/ MHz
U-NII-2A	v	---	11dBm/ MHz
U-NII-2C	v	---	11dBm/ MHz
U-NII-3	v	---	30 dBm/500kHz (=23.01 dBm/100kHz)

Note: $23.01\text{dBm}/100\text{kHz} = 30\text{dBm}/500\text{kHz} - 10\log\left(\frac{500\text{kHz}}{100\text{kHz}}\right)$

3.4.2 Measuring Instruments and Setting

Please refer to section 4 of equipments list in this report. The following table is the setting of Spectrum Analyzer.

Spectrum Parameter	Setting
Attenuation	Auto
Span Frequency	Encompass the entire emissions bandwidth (EBW) of the signal
RBW	1 MHz
VBW	≥ 3 MHz
Detector	RMS
Trace	Average
Sweep Time	Auto, trigger set to “free run”
Trace average	100 times

For U-NII-3 band:

Spectrum Parameter	Setting
Attenuation	Auto
Span Frequency	Encompass the entire emissions bandwidth (EBW) of the signal
RBW	100kHz
VBW	≥ 3 RBW
Detector	RMS
Trace	Average
Sweep Time	Auto, trigger set to “free run”
Trace average	100 times

3.4.3 Test Procedures

1. The transmitter output (antenna port) was connected RF switch to the spectrum analyzer.
2. For U-NII-1, U-NII-2A & U-NII-2C Bands, PSD Measure was performed in accordance with 789033 D02 General UNII Test Procedures New Rules v01, in section “Maximum conducted output power (E)(2)(d) Method SA-2”, 06/06/2014
3. For U-NII-3 Band, PSD Measure was performed in accordance with 789033 D02 General UNII Test Procedures New Rules v01, in section “Maximum Power Spectral Density (F)(5)” , 06/06/2014
4. Multiple antenna systems was performed in accordance 662911 D01 Multiple Transmitter Output v02r01 in-Band Power Spectral Density (PSD) Measurements (a) Measure and sum the spectra across the outputs (bin-by-bin summing).
5. When measuring first spectral bin of output 1 is summed with that in the first spectral bin of output 2 and that from the first spectral bin of output 3 and so on up to the Nth output to obtain the value for the first
6. frequency bin of the summed spectrum. The summed spectrum value for each of the other frequency bins is computed in the same way.

3.4.4 Test Setup Layout

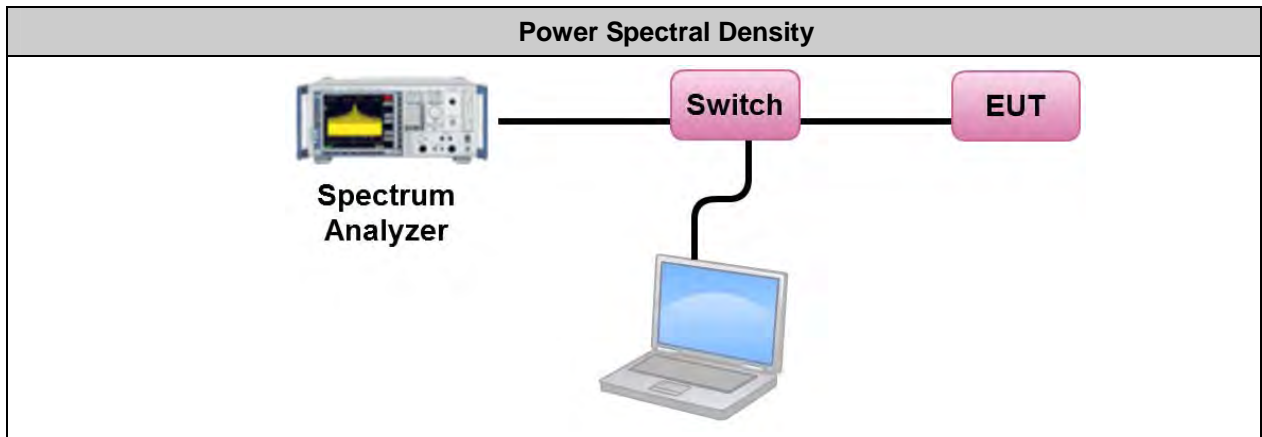

3.4.5 Test Deviation

There is no deviation with the original standard.

3.4.6 EUT Operation during Test

The EUT was programmed to be in continuously transmitting mode.

3.4.7 Test Result of Power Spectral Density

Test date	Mar. 17, 2015~Mar. 25, 2015	Test Site No.	TH01-CB
Temperature	20°C	Humidity	60%
Test Engineer	Mars Lin	Configuration	802.11a
Duty Cycle	<6Mbps, Ant. 1 >: 98.09% <6Mbps, 1S3T, CDD>: 98.09%		

Configuration IEEE 802.11a for U-NII-1 band

<6Mbps, Ant. 1 >

Channel	Frequency	Power Density (dBm/MHz)	Duty Factor	Total Power Density (dBm/MHz)	Antenna Gain	Max. Limit (dBm/MHz)	Result
36	5180 MHz	3.84	0.08	3.92	3.82	17.00	Complies
40	5200 MHz	4.19	0.08	4.27	3.86	17.00	Complies
48	5240 MHz	6.58	0.08	6.66	3.83	17.00	Complies

Note:

$$5180 \text{ MHz} = \text{Directional Gain} = 10 \cdot \log \left[\frac{\sum_{j=1}^{N_{ST}} \left\{ \sum_{k=1}^{N_{ANT}} g_{j,k} \right\}^2}{N_{ANT}} \right] = 3.82 \text{ dBi} <6\text{dBi, So } 5180\text{MHz Limit} = 17 \text{ dBm/MHz}$$

$$5200 \text{ MHz} = \text{Directional Gain} = 10 \cdot \log \left[\frac{\sum_{j=1}^{N_{ST}} \left\{ \sum_{k=1}^{N_{ANT}} g_{j,k} \right\}^2}{N_{ANT}} \right] = 3.86 \text{ dBi} <6\text{dBi, So } 5200\text{MHz Limit} = 17 \text{ dBm/MHz}$$

$$5240 \text{ MHz} = \text{Directional Gain} = 10 \cdot \log \left[\frac{\sum_{j=1}^{N_{ST}} \left\{ \sum_{k=1}^{N_{ANT}} g_{j,k} \right\}^2}{N_{ANT}} \right] = 3.83 \text{ dBi} <6\text{dBi, So } 5240\text{MHz Limit} = 17 \text{ dBm/MHz}$$

<6Mbps, 1S3T, CDD>

Channel	Frequency	Power Density (dBm/MHz)	Duty Factor	Total Power Density (dBm/MHz)	Directional Gain	Max. Limit (dBm/MHz)	Result
36	5180 MHz	2.83	0.08	2.91	6.51	16.49	Complies
40	5200 MHz	3.05	0.08	3.13	6.40	16.60	Complies
48	5240 MHz	7.73	0.08	7.81	6.26	16.74	Complies

Note:

$$5180 \text{ MHz} = \text{Directional Gain} = 10 \cdot \log \left[\frac{\sum_{j=1}^{N_{SK}} \left\{ \sum_{k=1}^{N_{ANT}} g_{j,k} \right\}^2}{N_{ANT}} \right] = 6.51 \text{ dBi} > 6 \text{ dBi}, \text{ So } 5180 \text{ MHz Limit} = 17 - (6.51 - 6) = 16.49 \text{ dBm/MHz}$$

$$5200 \text{ MHz} = \text{Directional Gain} = 10 \cdot \log \left[\frac{\sum_{j=1}^{N_{SK}} \left\{ \sum_{k=1}^{N_{ANT}} g_{j,k} \right\}^2}{N_{ANT}} \right] = 6.4 \text{ dBi} > 6 \text{ dBi}, \text{ So } 5200 \text{ MHz Limit} = 17 - (6.40 - 6) = 16.60 \text{ dBm/MHz}$$

$$5240 \text{ MHz} = \text{Directional Gain} = 10 \cdot \log \left[\frac{\sum_{j=1}^{N_{SK}} \left\{ \sum_{k=1}^{N_{ANT}} g_{j,k} \right\}^2}{N_{ANT}} \right] = 6.26 \text{ dBi} > 6 \text{ dBi}, \text{ So } 5240 \text{ MHz Limit} = 17 - (6.26 - 6) = 16.74 \text{ dBm/MHz}$$

<6Mbps, ANT1 >:

Power Density Plot on Configuration IEEE 802.11a / CH 36 / Ant. 1

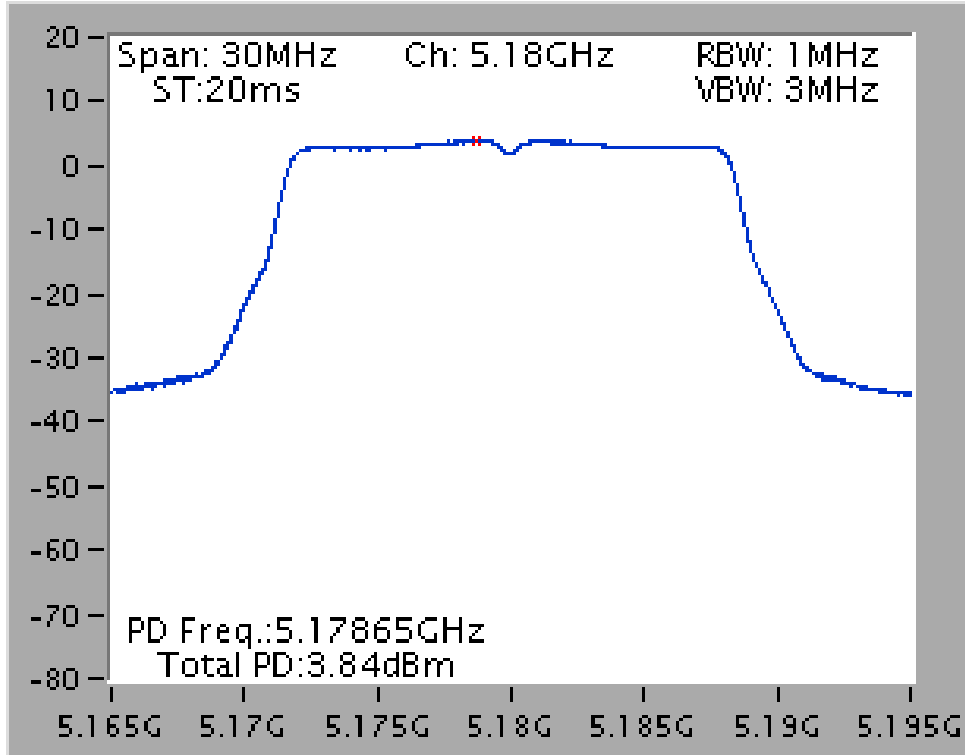

Power Density Plot on Configuration IEEE 802.11a / CH 40 / Ant. 1

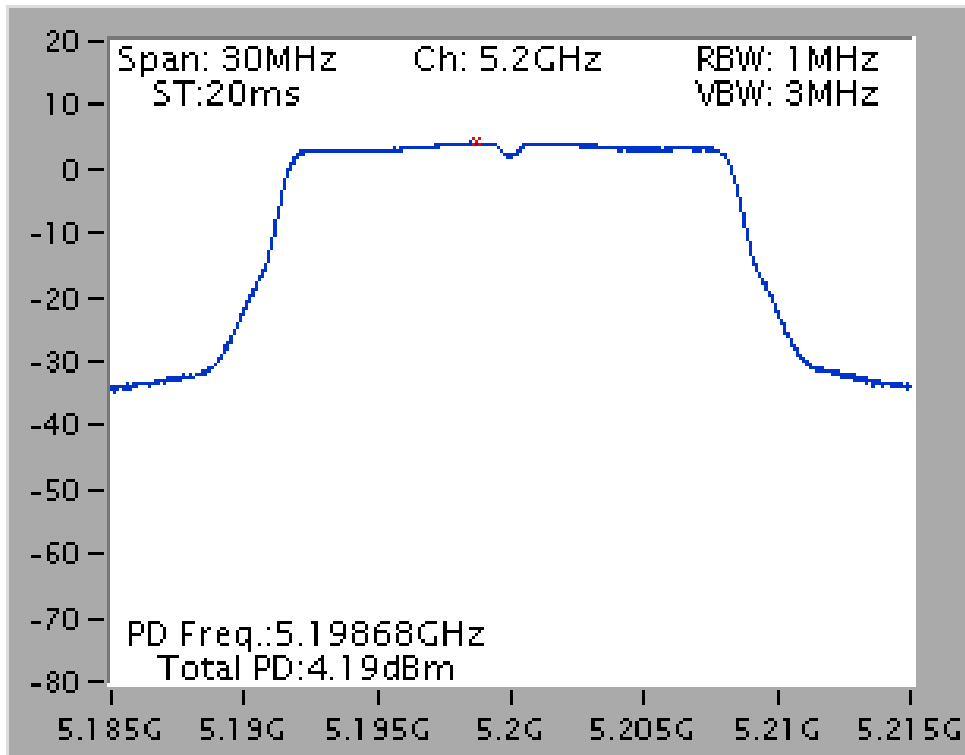

Power Density Plot on Configuration IEEE 802.11a / CH 48 / Ant. 1

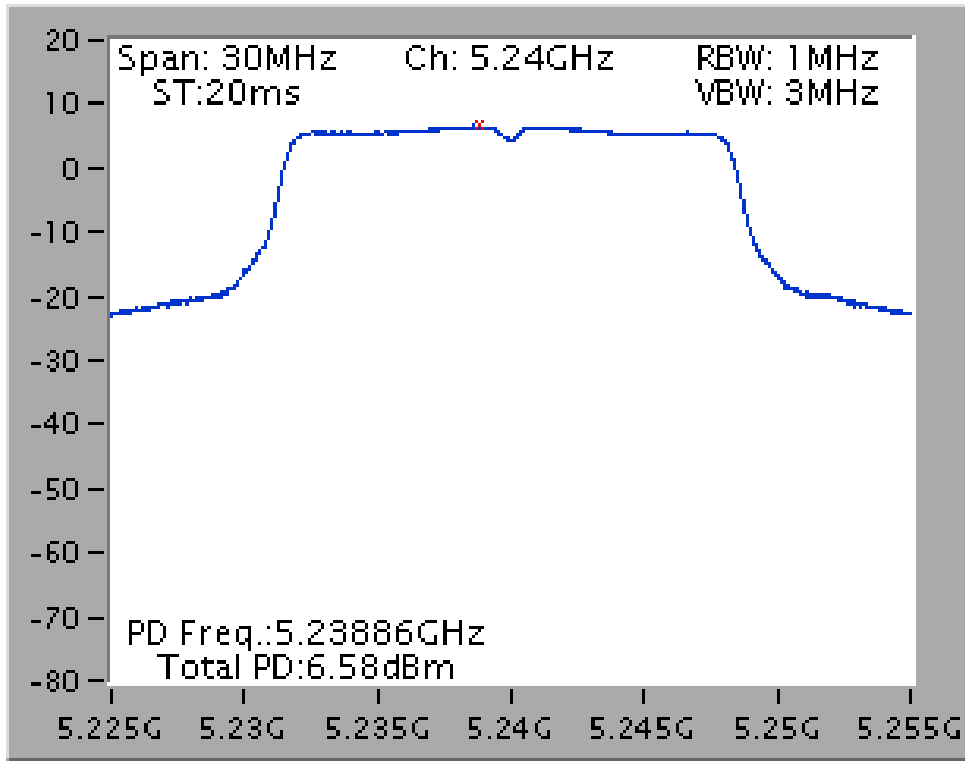

<6Mbps, 1S3T, CDD>:

Power Density Plot on Configuration IEEE 802.11a / CH 36 / 1S3T CDD / Ant. 1+2+3

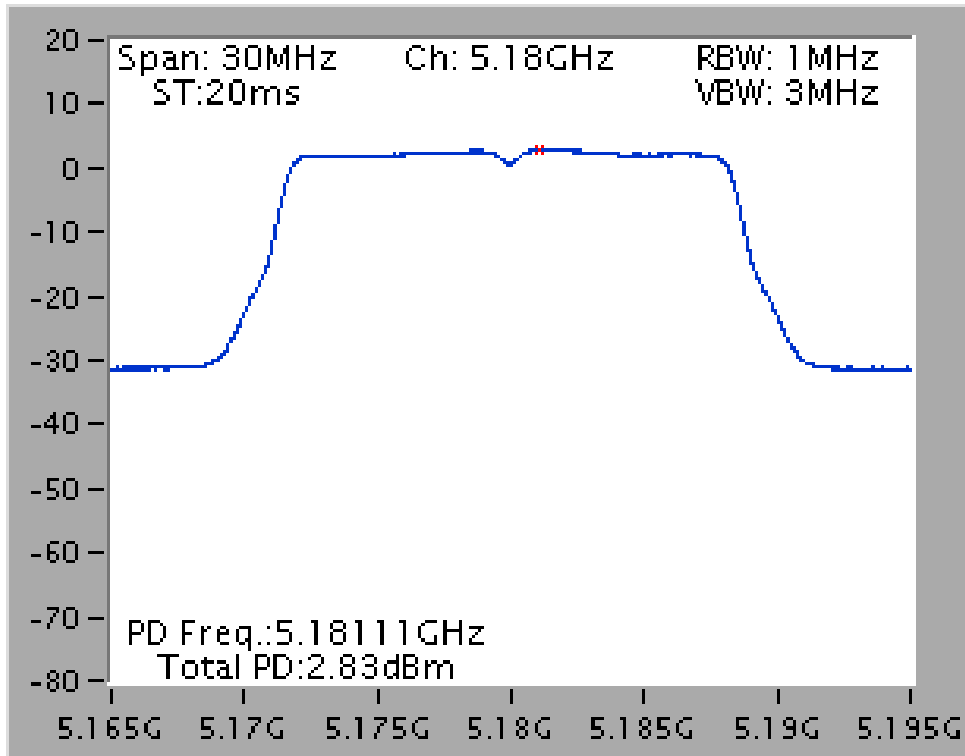

Power Density Plot on Configuration IEEE 802.11a / CH 40 / 1S3T CDD / Ant. 1+2+3

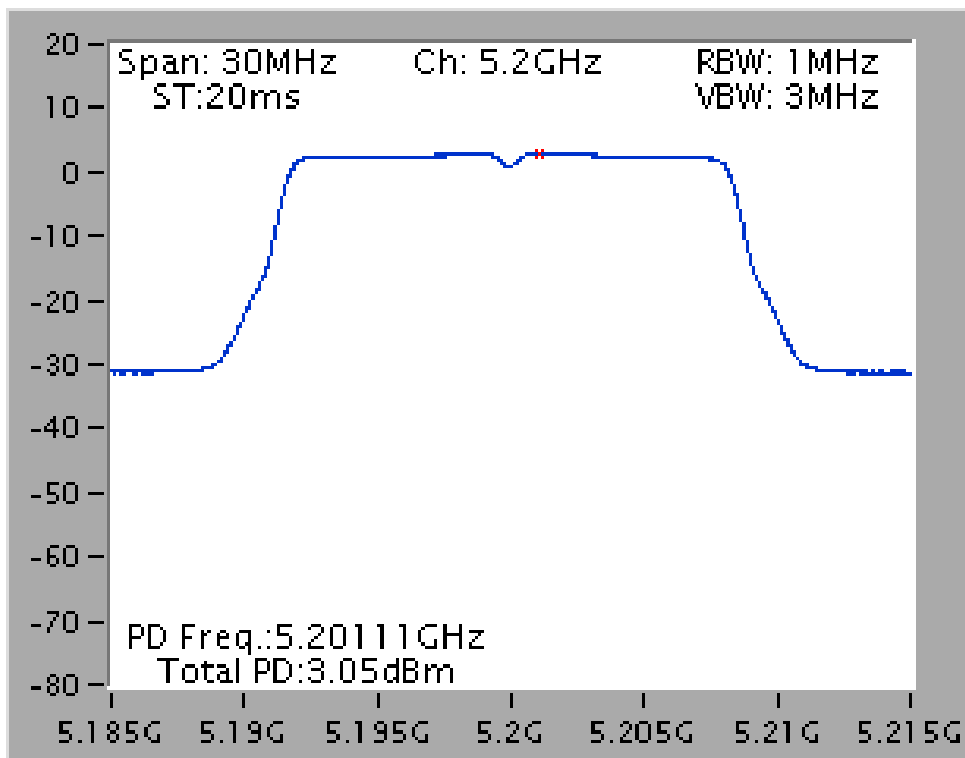

Power Density Plot on Configuration IEEE 802.11a / CH 48 / 1S3T CDD / Ant. 1+2+3

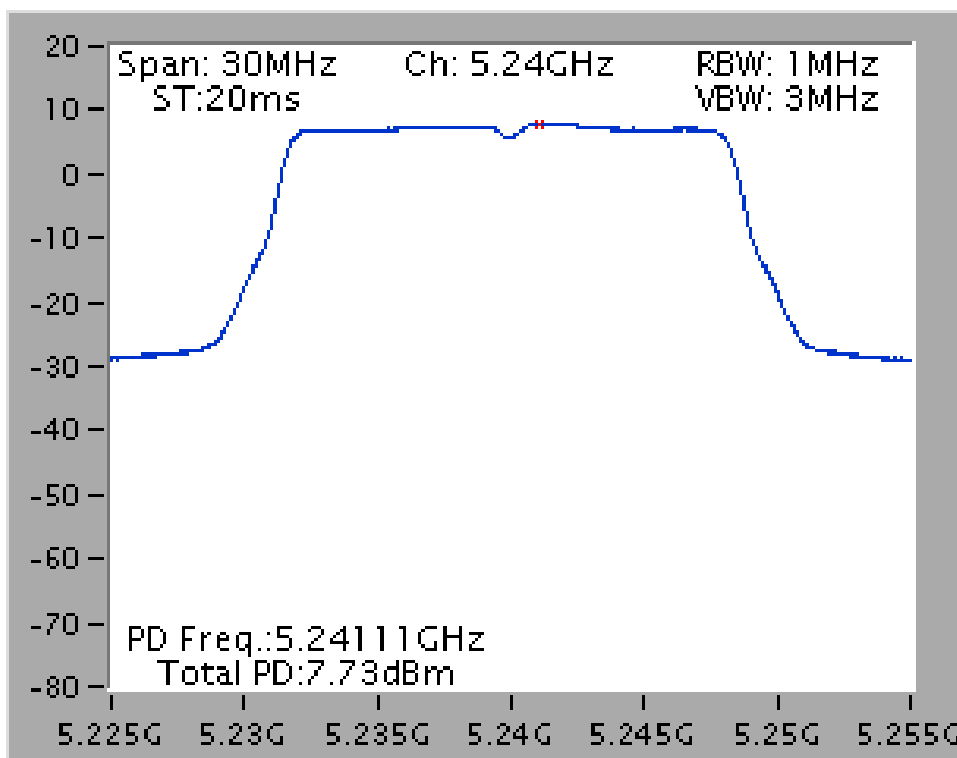

Configuration IEEE 802.11a for U-NII-3 band

<6Mbps, ANT1 >

Channel	Frequency	Power Density (dBm/MHz)	10log (500kHz /RBW) Factor (dB)	Power Density (dBm/500kHz)	Duty Factor	Total Power Density (dBm/500kHz)	Antenna Gain	Power Density Limit (dBm/500kHz)	Result
149	5745 MHz	4.34	-3.01	1.33	0.08	1.41	4.33	30.00	Complies
157	5785 MHz	2.74	-3.01	-0.27	0.08	-0.19	4.67	30.00	Complies
165	5825 MHz	1.74	-3.01	-1.27	0.08	-1.19	4.46	30.00	Complies

Note:

$$5745 \text{ MHz} = \text{Directional Gain} = 10 \cdot \log \left[\frac{\sum_{j=1}^{N_{SS}} \left\{ \sum_{k=1}^{N_{ANT}} g_{j,k} \right\}^2}{N_{ANT}} \right] = 4.33 \text{ dBi} < 6\text{dBi}, \text{So } 5745\text{MHz Limit} = 30 \text{ dBm}/500\text{kHz}$$

$$5785 \text{ MHz} = \text{Directional Gain} = 10 \cdot \log \left[\frac{\sum_{j=1}^{N_{SS}} \left\{ \sum_{k=1}^{N_{ANT}} g_{j,k} \right\}^2}{N_{ANT}} \right] = 4.67 \text{ dBi} < 6\text{dBi}, \text{So } 5785\text{MHz Limit} = 30 \text{ dBm}/500\text{kHz}$$

$$5825 \text{ MHz} = \text{Directional Gain} = 10 \cdot \log \left[\frac{\sum_{j=1}^{N_{SS}} \left\{ \sum_{k=1}^{N_{ANT}} g_{j,k} \right\}^2}{N_{ANT}} \right] = 4.46 \text{ dBi} < 6\text{dBi}, \text{So } 5825\text{MHz Limit} = 30 \text{ dBm}/500\text{kHz}$$

<6Mbps, 1S3T, CDD>

Channel	Frequency	Power Density (dBm/MHz)	10log (500kHz /RBW) Factor (dB)	Power Density (dBm/500kHz)	Duty Factor	Total Power Density (dBm/500kHz)	Directional Gain	Power Density Limit (dBm/500kHz)	Result
149	5745 MHz	6.02	-3.01	3.01	0.08	3.09	6.25	29.75	Complies
157	5785 MHz	3.89	-3.01	0.88	0.08	0.96	6.45	29.55	Complies
165	5825 MHz	3.02	-3.01	0.01	0.08	0.09	6.43	29.57	Complies

Note:

$$5745 \text{ MHz} = \text{Directional Gain} = 10 \cdot \log \left[\frac{\sum_{j=1}^{N_{SS}} \left\{ \sum_{k=1}^{N_{ANT}} g_{j,k} \right\}^2}{N_{ANT}} \right] = 6.25\text{dBi} > 6\text{dBi}, \text{So } 5745\text{MHz Limit} = 30 - (6.25 - 6) = 29.75 \text{ dBm}/500\text{kHz}$$

$$5785 \text{ MHz} = \text{Directional Gain} = 10 \cdot \log \left[\frac{\sum_{j=1}^{N_{SS}} \left\{ \sum_{k=1}^{N_{ANT}} g_{j,k} \right\}^2}{N_{ANT}} \right] = 6.45\text{dBi} > 6\text{dBi}, \text{So } 5785\text{MHz Limit} = 30 - (6.45 - 6) = 29.55 \text{ dBm}/500\text{kHz}$$

$$5825 \text{ MHz} = \text{Directional Gain} = 10 \cdot \log \left[\frac{\sum_{j=1}^{N_{SS}} \left\{ \sum_{k=1}^{N_{ANT}} g_{j,k} \right\}^2}{N_{ANT}} \right] = 6.43\text{dBi} > 6\text{dBi}, \text{So } 5825\text{MHz Limit} = 30 - (6.43 - 6) = 29.57 \text{ dBm}/500\text{kHz}$$

<6Mbps, ANT1 >:

Power Density Plot on Configuration IEEE 802.11a / CH 149 / Ant. 1

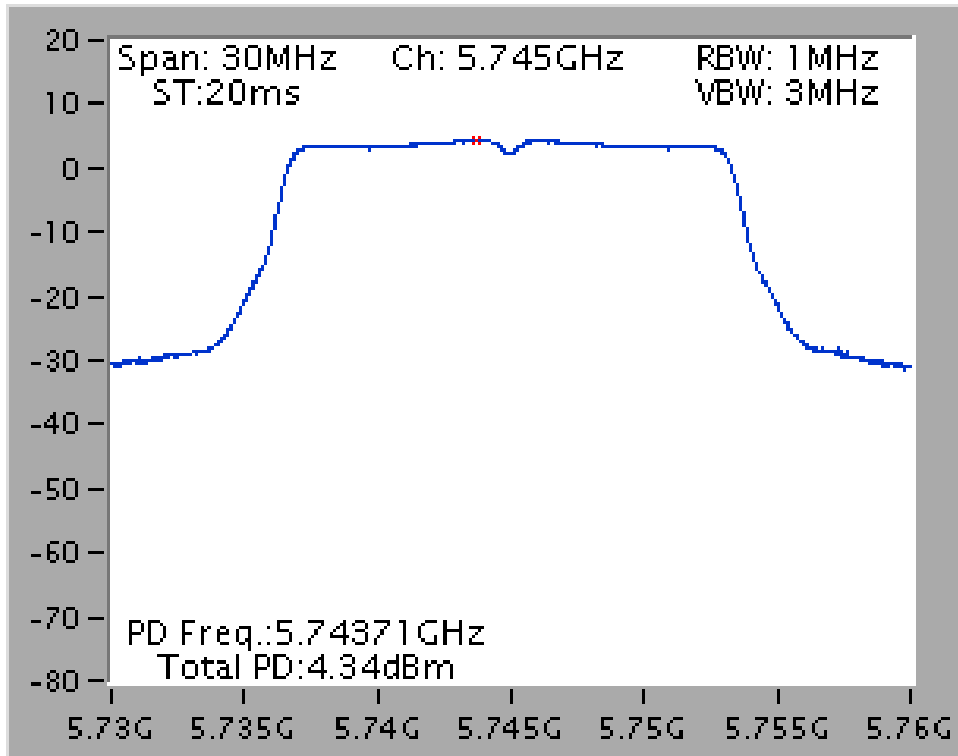

Power Density Plot on Configuration IEEE 802.11a / CH 157 / Ant. 1

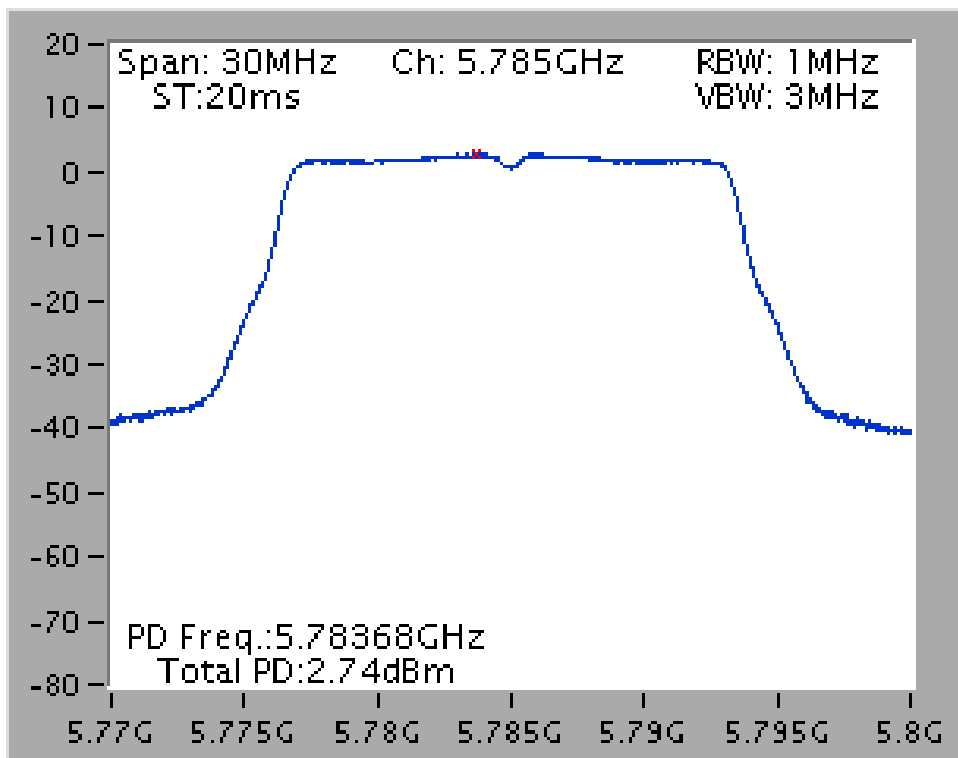

Power Density Plot on Configuration IEEE 802.11a / CH 165 / Ant. 1

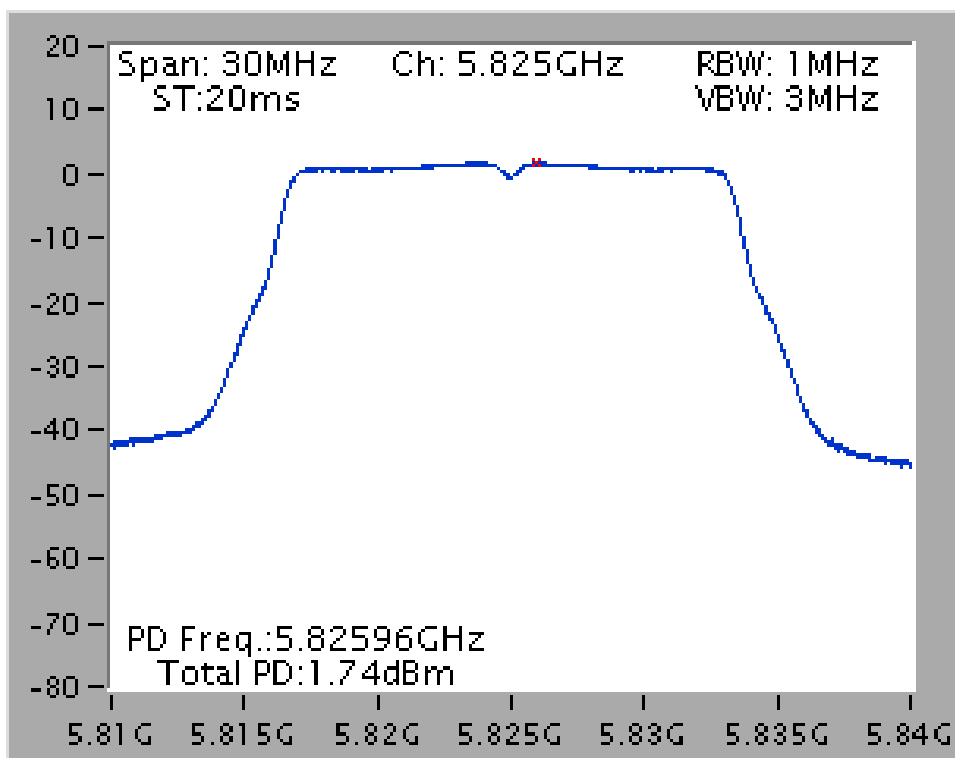

<6Mbps, 1S3T, CDD>:

Power Density Plot on Configuration IEEE 802.11a / CH 149 / 1S3T CDD / Ant. 1+2+3

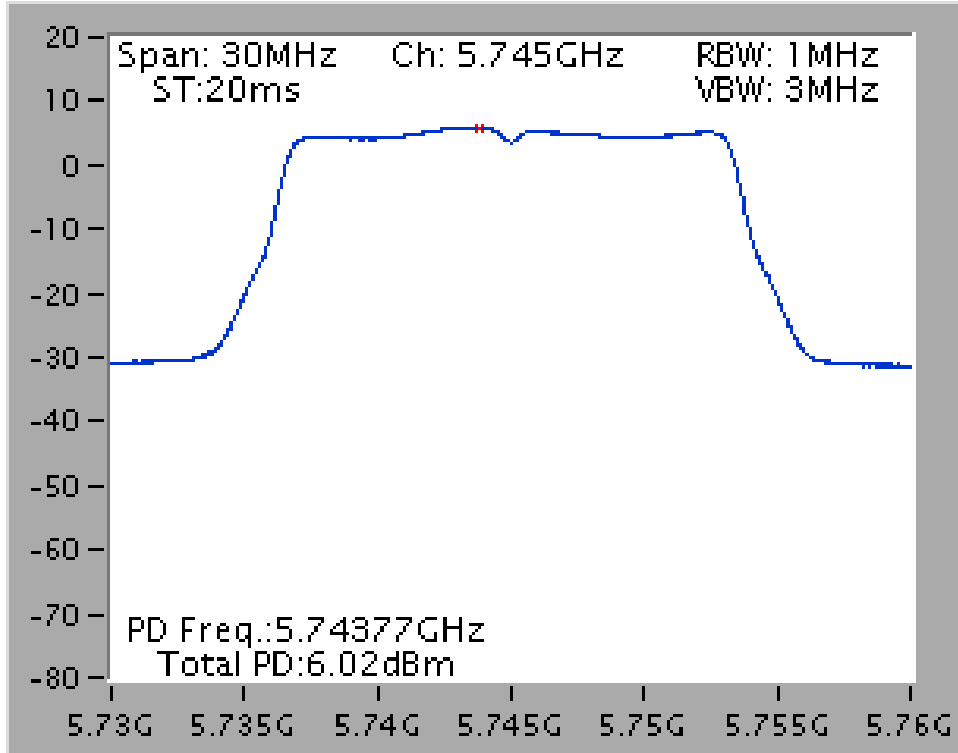

Power Density Plot on Configuration IEEE 802.11a / CH 157 / 1S3T CDD / Ant. 1+2+3

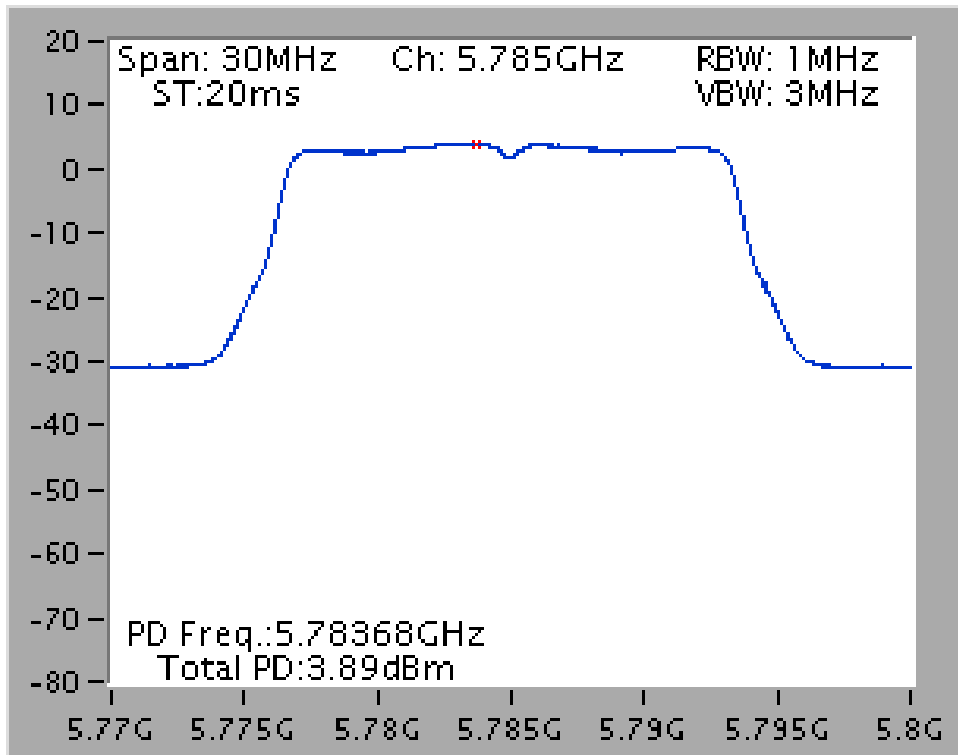

Power Density Plot on Configuration IEEE 802.11a / CH 165 / 1S3T CDD / Ant. 1+2+3

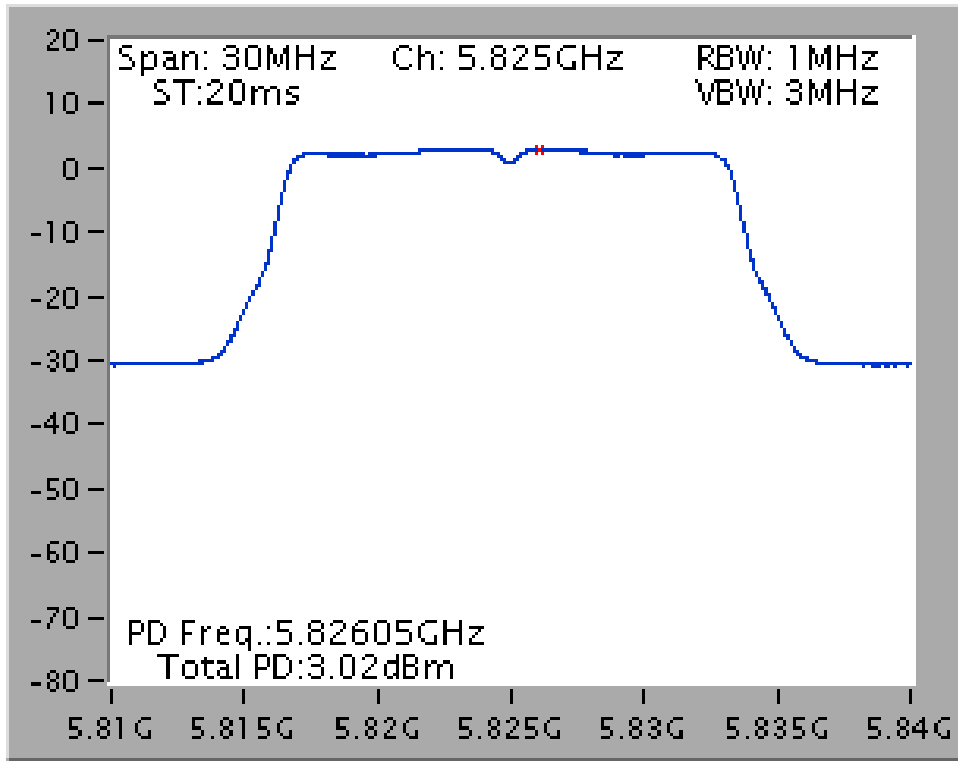

Test date	Mar. 17, 2015~Mar. 25, 2015	Test Site No.	TH01-CB
Temperature	20°C	Humidity	60%
Test Engineer	Mars Lin	Configuration	802.11ac 20MHz
Duty Cycle	<Nss1MCS0, Ant. 1>: 98.97% <Nss1MCS0, 1S3T, CDD>: 98.97% <Nss1MCS0, 1S3T, TXBF>: 97.23%		

Configuration IEEE 802.11ac 20MHz for U-NII-1 band

<Nss1MCS0, Ant. 1>

Channel	Frequency	Power Density (dBm/MHz)	Duty Factor	Total Power Density (dBm/MHz)	Antenna Gain	Max. Limit (dBm/MHz)	Result
36	5180 MHz	3.57	0.04	3.61	3.82	17.00	Complies
40	5200 MHz	3.34	0.04	3.38	3.86	17.00	Complies
48	5240 MHz	6.60	0.04	6.64	3.83	17.00	Complies

Note:

$$5180 \text{ MHz} \Rightarrow \text{Directional Gain} = 10 \cdot \log \left[\frac{\sum_{j=1}^{N_{SS}} \left\{ \sum_{k=1}^{N_{ANT}} g_{j,k} \right\}^2}{N_{ANT}} \right] = 3.82 \text{ dBi} < 6\text{dBi}, \text{So } 5180\text{MHz Limit} = 17 \text{ dBm/MHz}$$

$$5200 \text{ MHz} \Rightarrow \text{Directional Gain} = 10 \cdot \log \left[\frac{\sum_{j=1}^{N_{SS}} \left\{ \sum_{k=1}^{N_{ANT}} g_{j,k} \right\}^2}{N_{ANT}} \right] = 3.86 \text{ dBi} < 6\text{dBi}, \text{So } 5200\text{MHz Limit} = 17 \text{ dBm/MHz}$$

$$5240 \text{ MHz} \Rightarrow \text{Directional Gain} = 10 \cdot \log \left[\frac{\sum_{j=1}^{N_{SS}} \left\{ \sum_{k=1}^{N_{ANT}} g_{j,k} \right\}^2}{N_{ANT}} \right] = 3.83 \text{ dBi} < 6\text{dBi}, \text{So } 5240\text{MHz Limit} = 17 \text{ dBm/MHz}$$

<Nss1MCS0, 1S3T, CDD>

Channel	Frequency	Power Density (dBm/MHz)	Duty Factor	Total Power Density (dBm/MHz)	Directional Gain	Max. Limit (dBm/MHz)	Result
36	5180 MHz	4.12	0.04	4.16	6.51	16.49	Complies
40	5200 MHz	3.99	0.04	4.03	6.40	16.60	Complies
48	5240 MHz	9.68	0.04	9.72	6.26	16.74	Complies

Note:

$$5180\text{MHz} = \text{Directional Gain} = 10 \cdot \log \left[\frac{\sum_{j=1}^{N_{SS}} \left\{ \sum_{k=1}^{N_{ANT}} g_{j,k} \right\}^2}{N_{ANT}} \right] = 6.51\text{dBi} > 6\text{dBi}, \text{So } 5180\text{MHz Limit} = 17 - (6.51 - 6) = 16.49 \text{ dBm/MHz}$$

$$5200\text{MHz} = \text{Directional Gain} = 10 \cdot \log \left[\frac{\sum_{j=1}^{N_{SS}} \left\{ \sum_{k=1}^{N_{ANT}} g_{j,k} \right\}^2}{N_{ANT}} \right] = 6.40\text{dBi} > 6\text{dBi}, \text{So } 5200\text{MHz Limit} = 17 - (6.40 - 6) = 16.60 \text{ dBm/MHz}$$

$$5240 \text{ MHz} = \text{Directional Gain} = 10 \cdot \log \left[\frac{\sum_{j=1}^{N_{SS}} \left\{ \sum_{k=1}^{N_{ANT}} g_{j,k} \right\}^2}{N_{ANT}} \right] = 6.26\text{dBi} > 6\text{dBi}, \text{So } 5240\text{MHz Limit} = 17 - (6.26 - 6) = 16.74 \text{ dBm/MHz}$$

<Nss1MCS0, 1S3T, TXBF>

Channel	Frequency	Power Density (dBm/MHz)	Duty Factor	Total Power Density (dBm/MHz)	Directional Gain	Max. Limit (dBm/MHz)	Result
36	5180 MHz	5.25	0.12	5.37	6.51	16.49	Complies
40	5200 MHz	2.46	0.12	2.58	6.40	16.60	Complies
48	5240 MHz	8.17	0.12	8.29	6.26	16.74	Complies

Note:

$$5180\text{MHz} = \text{Directional Gain} = 10 \cdot \log \left[\frac{\sum_{j=1}^{N_{SS}} \left\{ \sum_{k=1}^{N_{ANT}} g_{j,k} \right\}^2}{N_{ANT}} \right] = 6.51\text{dBi} > 6\text{dBi}, \text{So } 5180\text{MHz Limit} = 17 - (6.51 - 6) = 16.49 \text{ dBm/MHz}$$

$$5200\text{MHz} = \text{Directional Gain} = 10 \cdot \log \left[\frac{\sum_{j=1}^{N_{SS}} \left\{ \sum_{k=1}^{N_{ANT}} g_{j,k} \right\}^2}{N_{ANT}} \right] = 6.40\text{dBi} > 6\text{dBi}, \text{So } 5200\text{MHz Limit} = 17 - (6.40 - 6) = 16.60 \text{ dBm/MHz}$$

$$5240 \text{ MHz} = \text{Directional Gain} = 10 \cdot \log \left[\frac{\sum_{j=1}^{N_{SS}} \left\{ \sum_{k=1}^{N_{ANT}} g_{j,k} \right\}^2}{N_{ANT}} \right] = 6.26\text{dBi} > 6\text{dBi}, \text{So } 5240\text{MHz Limit} = 17 - (6.26 - 6) = 16.74 \text{ dBm/MHz}$$

<Nss1MCS0, Ant. 1>

Power Density Plot on Configuration IEEE 802.11ac 20MHz / CH 36 / Ant. 1

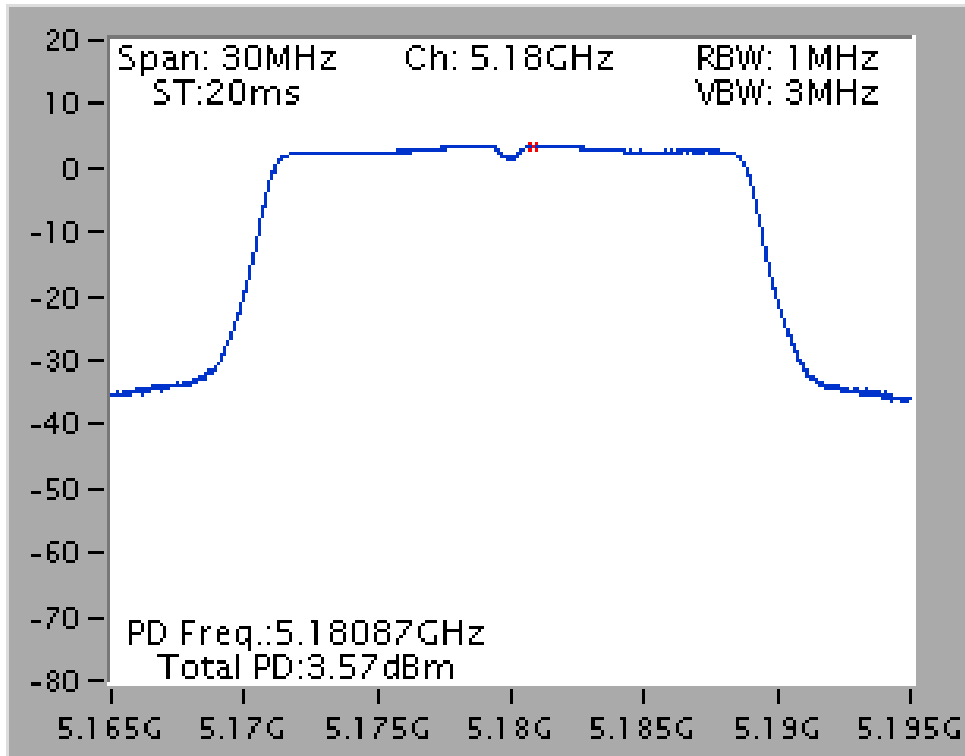

Power Density Plot on Configuration IEEE 802.11ac 20MHz / CH 40 / Ant. 1

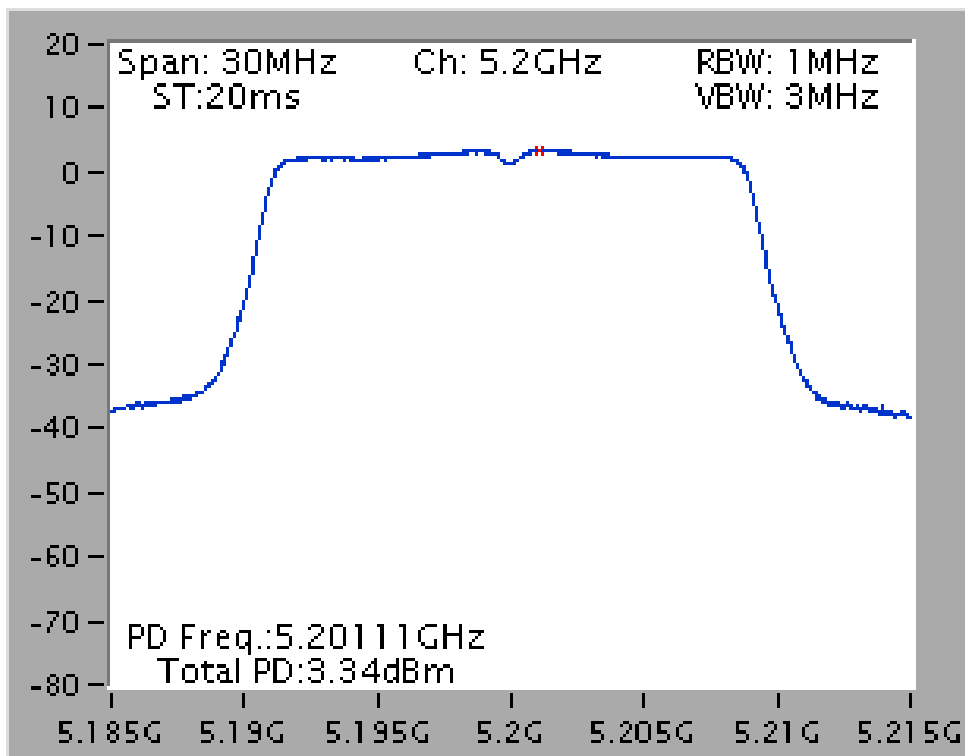

Power Density Plot on Configuration IEEE 802.11ac 20MHz / CH 48 / Ant. 1

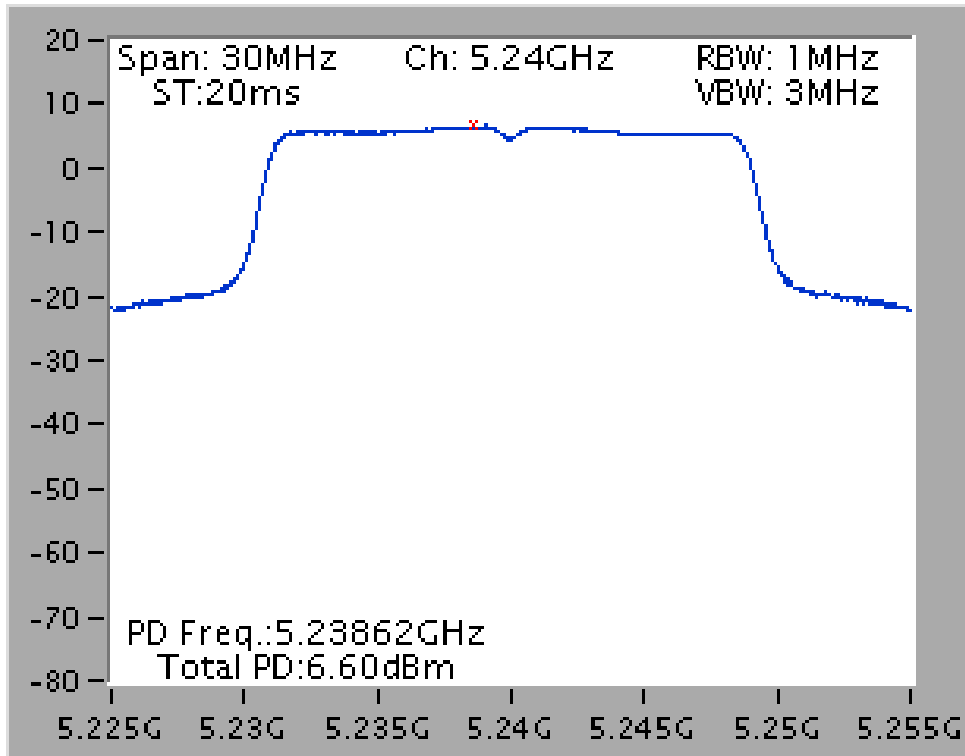

<Nss1MCS0, 1S3T, CDD>:

Power Density Plot on Configuration IEEE 802.11ac 20MHz / CH 36 / 1S3T CDD / Ant. 1+2+3

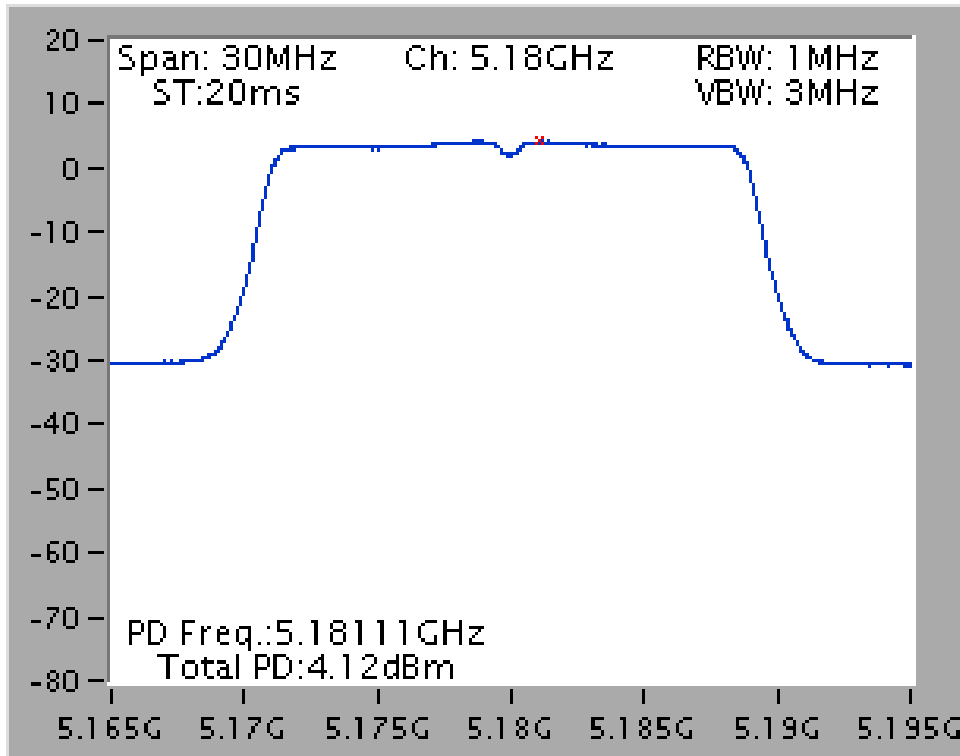

Power Density Plot on Configuration IEEE 802.11ac 20MHz / CH 40 / 1S3T CDD / Ant. 1+2+3

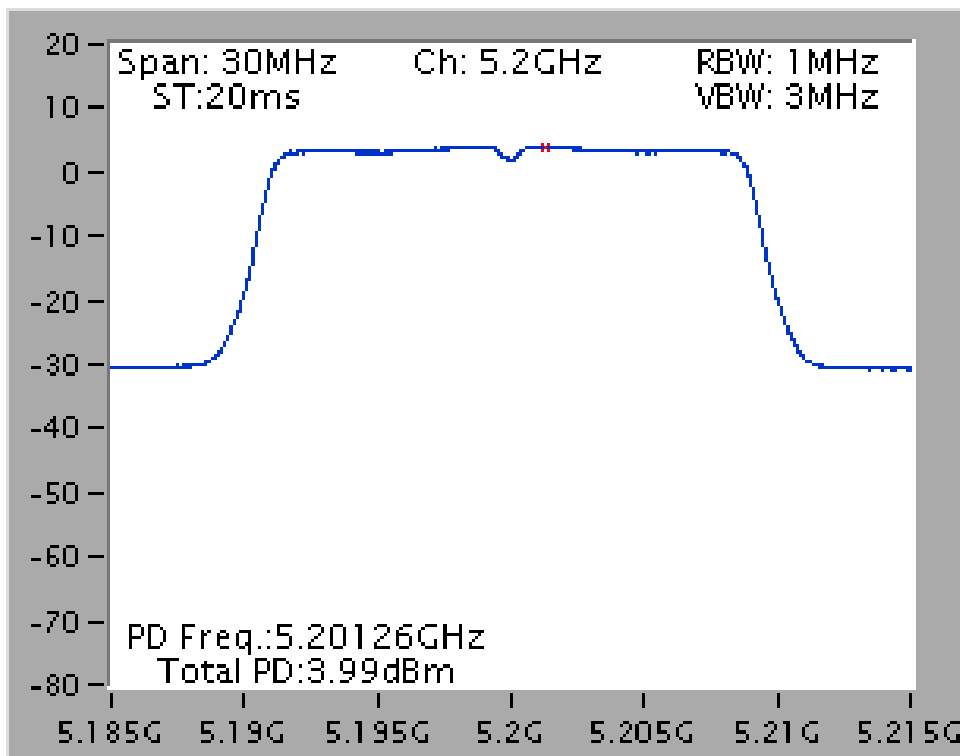

Power Density Plot on Configuration IEEE 802.11ac 20MHz / CH 48 / 1S3T CDD / Ant. 1+2+3

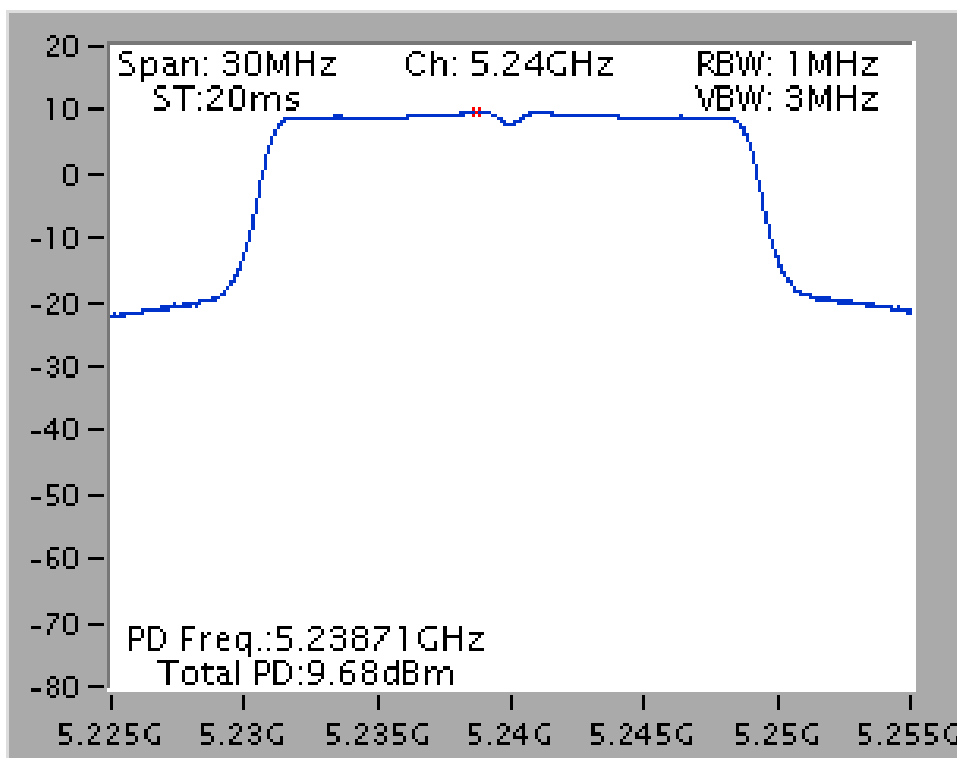

<Nss1MCS0, 1S3T, TXBF>:

Power Density Plot on Configuration IEEE 802.11ac 20MHz / CH 36 / 1S3T TXBF / Ant. 1+2+3

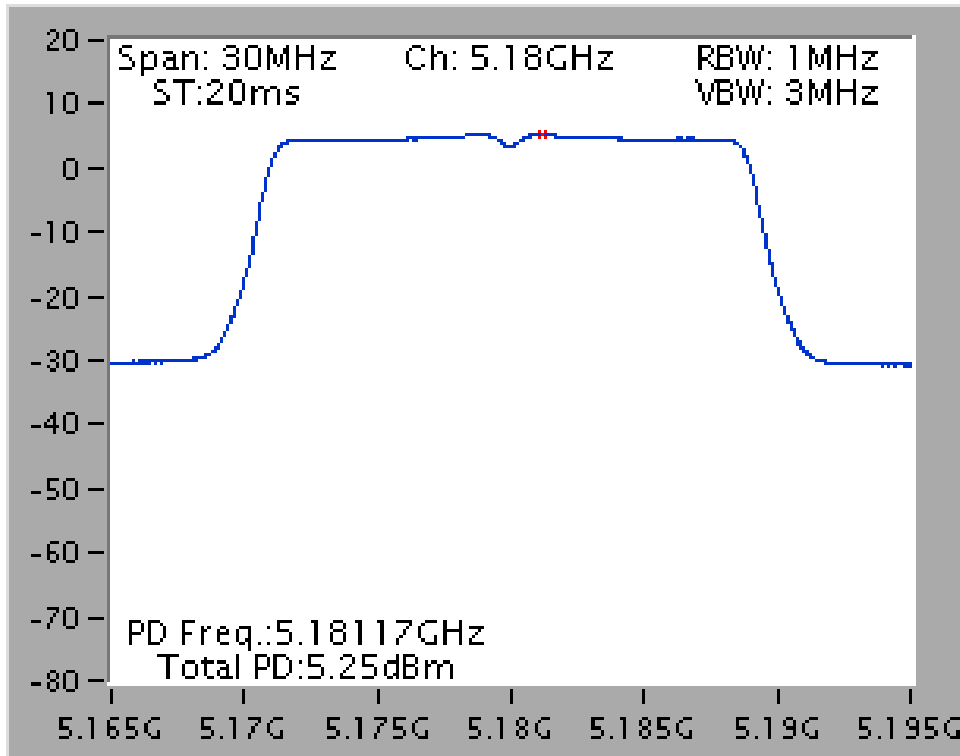

Power Density Plot on Configuration IEEE 802.11ac 20MHz / CH 40 / 1S3T TXBF / Ant. 1+2+3

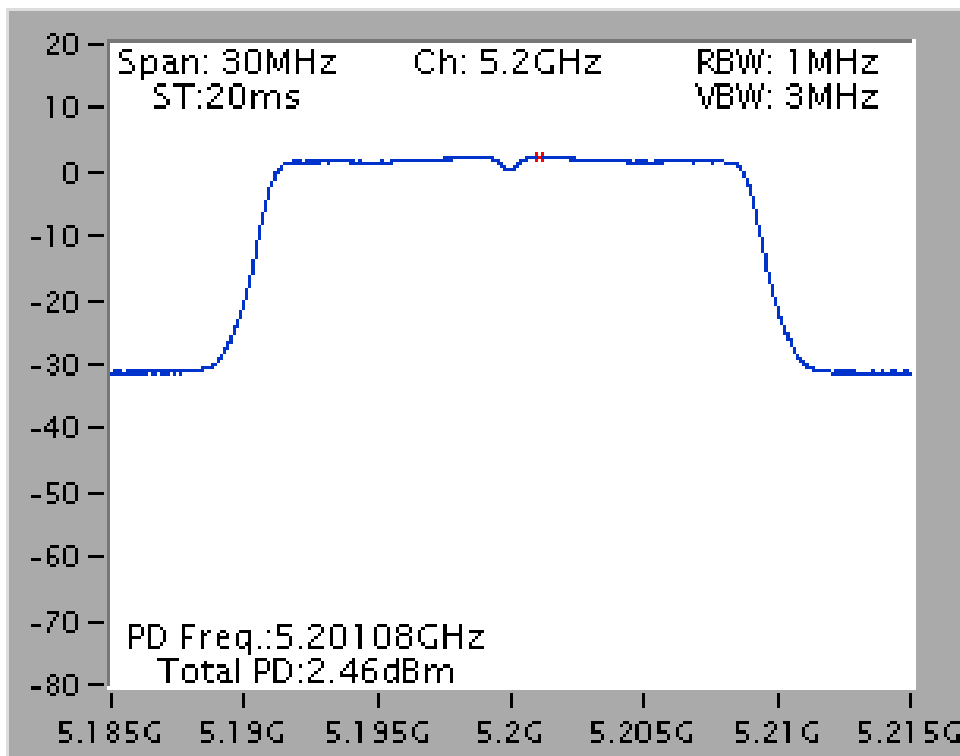

Power Density Plot on Configuration IEEE 802.11ac 20MHz / CH 48 / 1S3T TXBF / Ant. 1+2+3

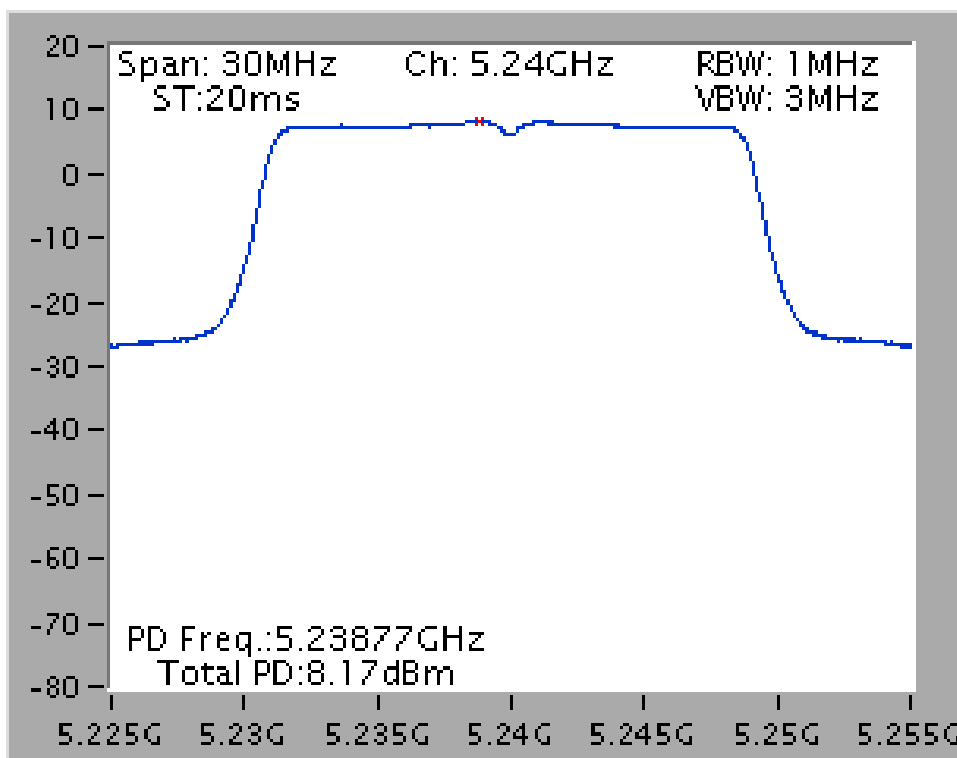

Configuration IEEE 802.11ac 20MHz for U-NII-3 band

<Nss1MCS0, Ant. 1>

Channel	Frequency	Power Density (dBm/MHz)	10log (500kHz /RBW) Factor (dB)	Power Density (dBm/500kHz)	Duty Factor	Total Power Density (dBm/500kHz)	Antenna Gain	Power Density Limit (dBm/500kHz)	Result
149	5745 MHz	3.72	-3.01	0.71	0.04	0.75	4.33	30.00	Complies
157	5785 MHz	2.04	-3.01	-0.97	0.04	-0.93	4.67	30.00	Complies
165	5825 MHz	1.84	-3.01	-1.17	0.04	-1.13	4.46	30.00	Complies

Note:

$$5745 \text{ MHz} = \text{Directional } l\text{Gain} = 10 \cdot \log \left[\frac{\sum_{j=1}^{N_{SS}} \left\{ \sum_{k=1}^{N_{ANT}} g_{j,k} \right\}^2}{N_{ANT}} \right] = 4.33 \text{ dBi} < 6\text{dBi}, \text{So } 5745\text{MHz Limit} = 30 \text{ dBm}/500\text{kHz}$$

$$5785 \text{ MHz} = \text{Directional } l\text{Gain} = 10 \cdot \log \left[\frac{\sum_{j=1}^{N_{SS}} \left\{ \sum_{k=1}^{N_{ANT}} g_{j,k} \right\}^2}{N_{ANT}} \right] = 4.67 \text{ dBi} < 6\text{dBi}, \text{So } 5785\text{MHz Limit} = 30 \text{ dBm}/500\text{kHz}$$

$$5825 \text{ MHz} = \text{Directional } l\text{Gain} = 10 \cdot \log \left[\frac{\sum_{j=1}^{N_{SS}} \left\{ \sum_{k=1}^{N_{ANT}} g_{j,k} \right\}^2}{N_{ANT}} \right] = 4.46 \text{ dBi} < 6\text{dBi}, \text{So } 5825\text{MHz Limit} = 30 \text{ dBm}/500\text{kHz}$$

<Nss1MCS0, 1S3T, CDD>

Channel	Frequency	Power Density (dBm/MHz)	10log (500kHz /RBW) Factor (dB)	Power Density (dBm/500kHz)	Duty Factor	Total Power Density (dBm/500kHz)	Directional Gain	Power Density Limit (dBm/500kHz)	Result
149	5745 MHz	7.07	-3.01	4.06	0.04	4.10	6.25	29.75	Complies
157	5785 MHz	5.25	-3.01	2.24	0.04	2.28	6.45	29.55	Complies
165	5825 MHz	5.28	-3.01	2.27	0.04	2.31	6.43	29.57	Complies

Note:

$$5745 \text{ MHz} = \text{Directional } l\text{Gain} = 10 \cdot \log \left[\frac{\sum_{j=1}^{N_{SS}} \left\{ \sum_{k=1}^{N_{ANT}} g_{j,k} \right\}^2}{N_{ANT}} \right] = 6.25\text{dBi} > 6\text{dBi}, \text{So } 5745\text{MHz Limit} = 30 - (6.25 - 6) = 29.75 \text{ dBm}/500\text{kHz}$$

$$5785 \text{ MHz} = \text{Directional } l\text{Gain} = 10 \cdot \log \left[\frac{\sum_{j=1}^{N_{SS}} \left\{ \sum_{k=1}^{N_{ANT}} g_{j,k} \right\}^2}{N_{ANT}} \right] = 6.45\text{dBi} > 6\text{dBi}, \text{So } 5785\text{MHz Limit} = 30 - (6.45 - 6) = 29.55 \text{ dBm}/500\text{kHz}$$

$$5825 \text{ MHz} = \text{Directional } l\text{Gain} = 10 \cdot \log \left[\frac{\sum_{j=1}^{N_{SS}} \left\{ \sum_{k=1}^{N_{ANT}} g_{j,k} \right\}^2}{N_{ANT}} \right] = 6.43\text{dBi} > 6\text{dBi}, \text{So } 5825\text{MHz Limit} = 30 - (6.43 - 6) = 29.57 \text{ dBm}/500\text{kHz}$$

<Nss1MCS0, 1S3T, TXBF>

Channel	Frequency	Power Density (dBm/MHz)	10log (500kHz /RBW) Factor (dB)	Power Density (dBm/500kHz)	Duty Factor	Total Power Density (dBm/500kHz)	Directional Gain	Power Density Limit (dBm/500kHz)	Result
149	5745 MHz	6.17	-3.01	3.16	0.12	3.28	6.25	29.75	Complies
157	5785 MHz	4.59	-3.01	1.58	0.12	1.70	6.45	29.55	Complies
165	5825 MHz	3.98	-3.01	0.97	0.12	1.09	6.43	29.57	Complies

Note:

$$5745 \text{ MHz} = \text{Directional Gain} = 10 \cdot \log \left[\frac{\sum_{j=1}^{N_{SS}} \left\{ \sum_{k=1}^{N_{ANT}} g_{j,k} \right\}^2}{N_{ANT}} \right] = 6.25 \text{dBi} > 6 \text{dBi}, \text{So } 5745 \text{MHz Limit} = 30 - (6.25 - 6) = 29.75 \text{ dBm/500kHz}$$

$$5785 \text{ MHz} = \text{Directional Gain} = 10 \cdot \log \left[\frac{\sum_{j=1}^{N_{SS}} \left\{ \sum_{k=1}^{N_{ANT}} g_{j,k} \right\}^2}{N_{ANT}} \right] = 6.45 \text{dBi} > 6 \text{dBi}, \text{So } 5785 \text{MHz Limit} = 30 - (6.45 - 6) = 29.55 \text{ dBm/500kHz}$$

$$5825 \text{ MHz} = \text{Directional Gain} = 10 \cdot \log \left[\frac{\sum_{j=1}^{N_{SS}} \left\{ \sum_{k=1}^{N_{ANT}} g_{j,k} \right\}^2}{N_{ANT}} \right] = 6.43 \text{dBi} > 6 \text{dBi}, \text{So } 5825 \text{MHz Limit} = 30 - (6.43 - 6) = 29.57 \text{ dBm/500kHz}$$

<Nss1MCS0, Ant. 1>:

Power Density Plot on Configuration IEEE 802.11ac 20MHz / CH 149 / Ant. 1

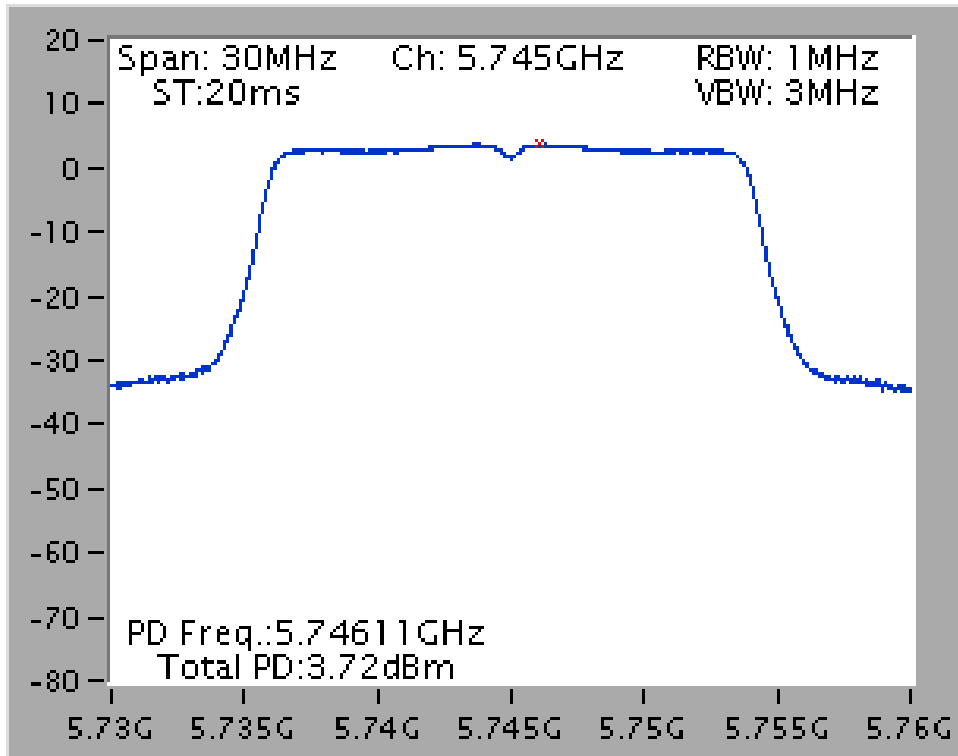

Power Density Plot on Configuration IEEE 802.11ac 20MHz / CH 157 / Ant. 1

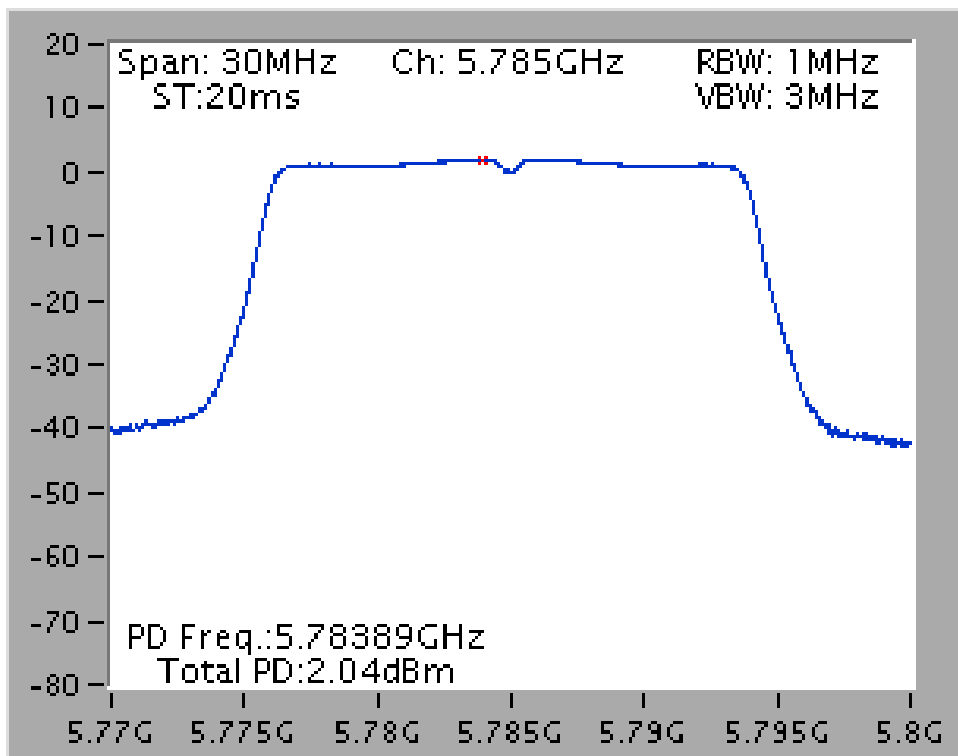

Power Density Plot on Configuration IEEE 802.11ac 20MHz / CH 165 / Ant. 1

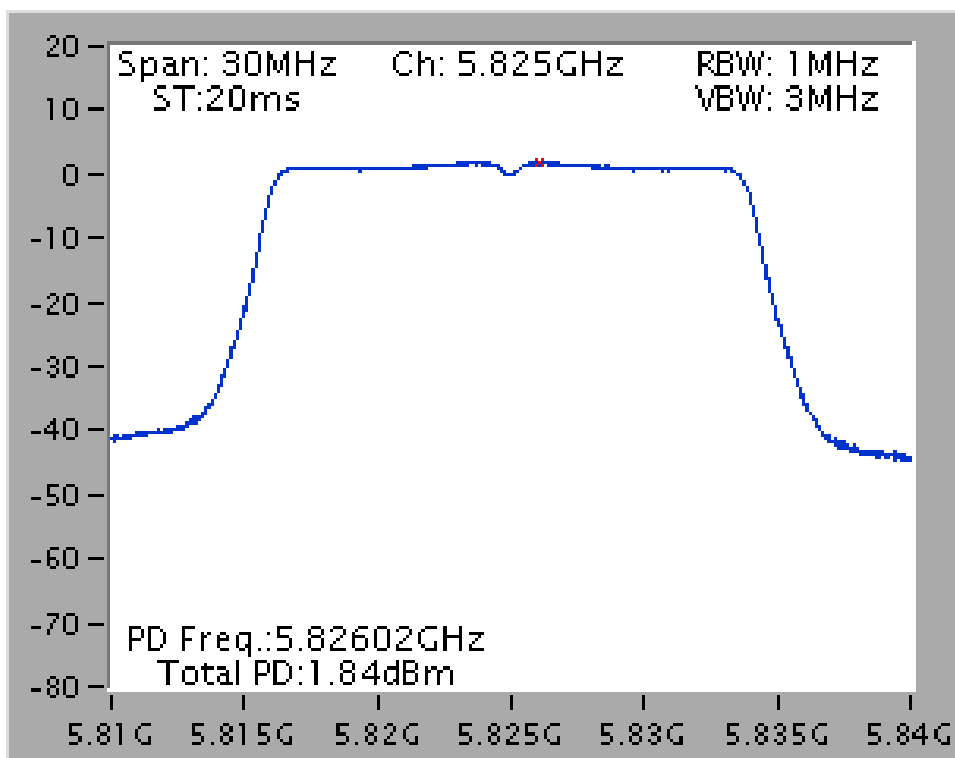

<Nss1MCS0, 1S3T, CDD>:

Power Density Plot on Configuration IEEE 802.11ac 20MHz / CH 149 / 1S3T CDD / Ant. 1+2+3

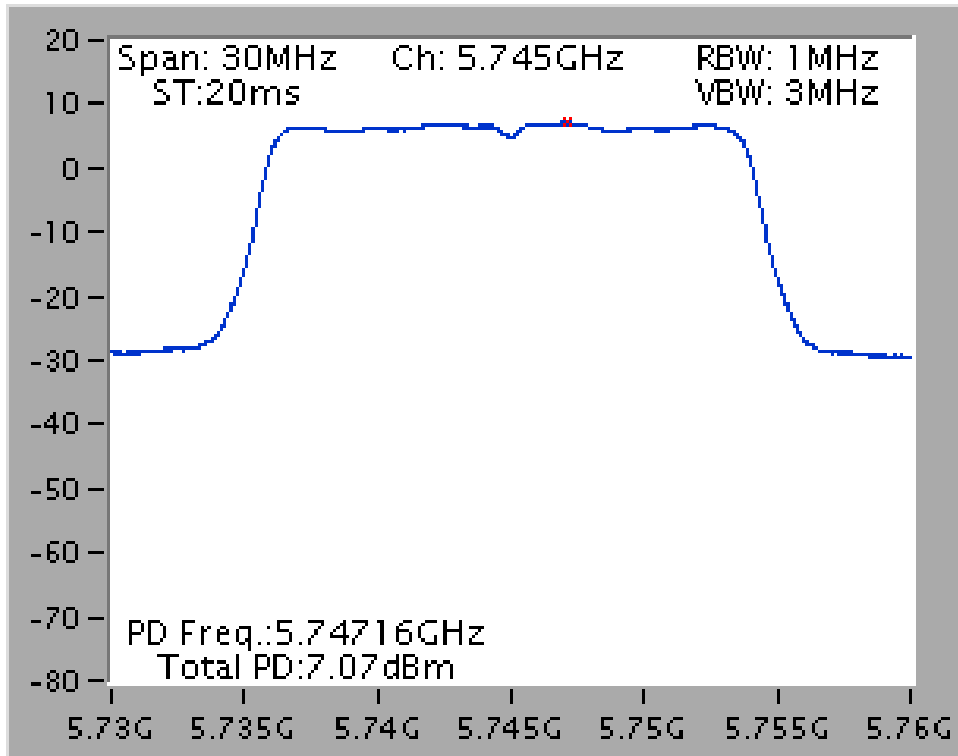

Power Density Plot on Configuration IEEE 802.11ac 20MHz / CH 157 / 1S3T CDD / Ant. 1+2+3

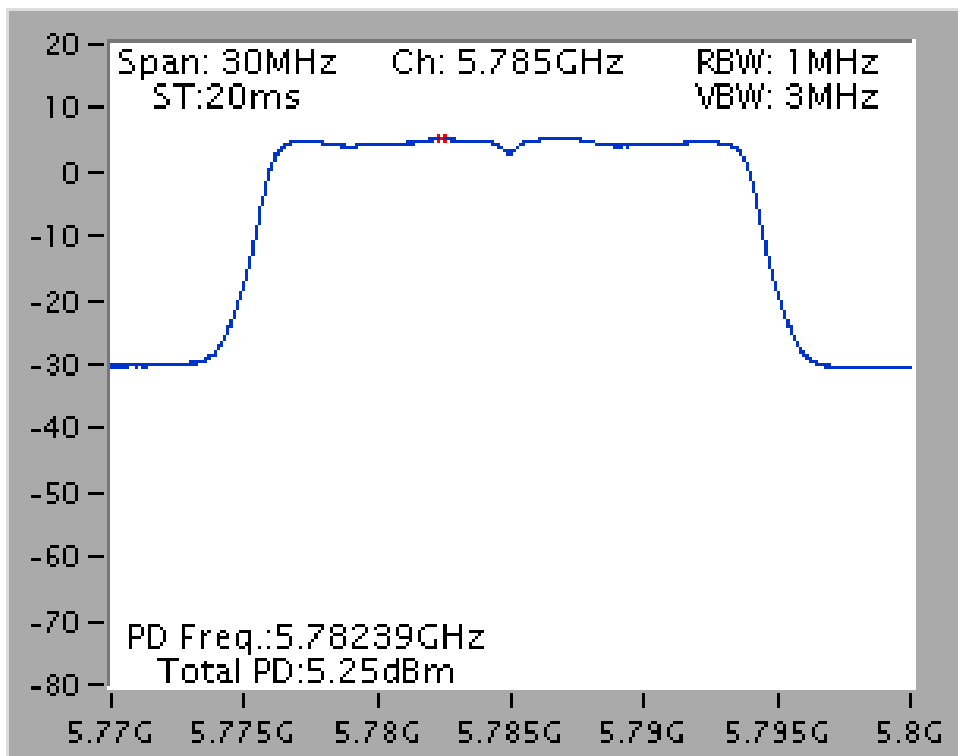

Power Density Plot on Configuration IEEE 802.11ac 20MHz / CH 165 / 1S3T CDD / Ant. 1+2+3

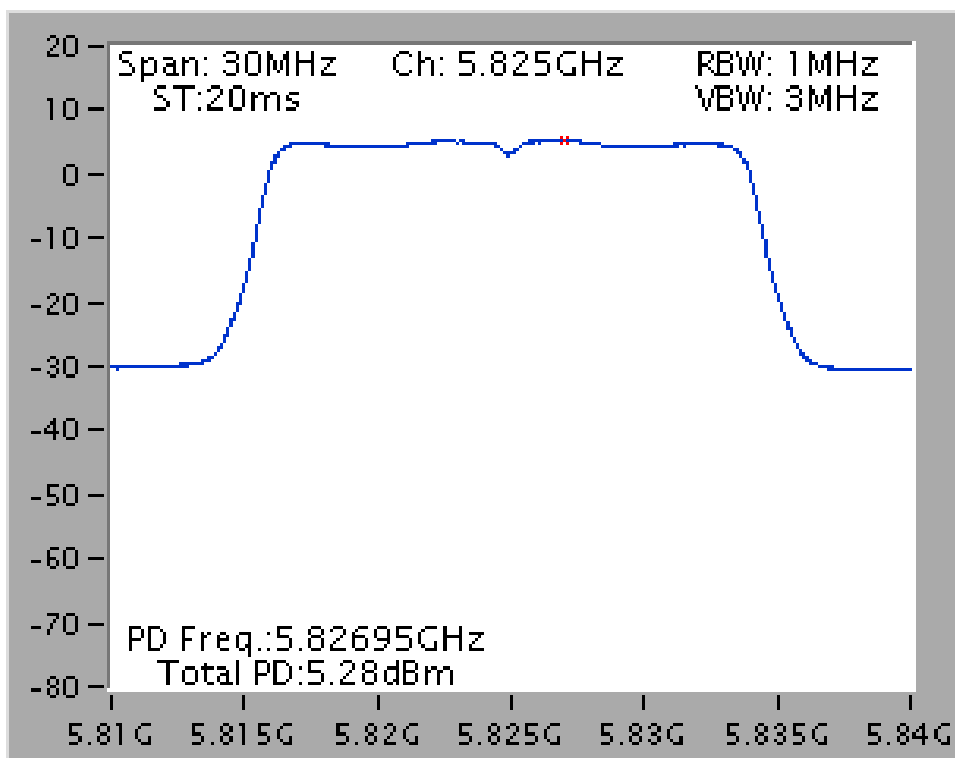

<Nss1MCS0, 1S3T, TXBF>:

Power Density Plot on Configuration IEEE 802.11ac 20MHz / CH 149 / 1S3T TXBF / Ant. 1+2+3

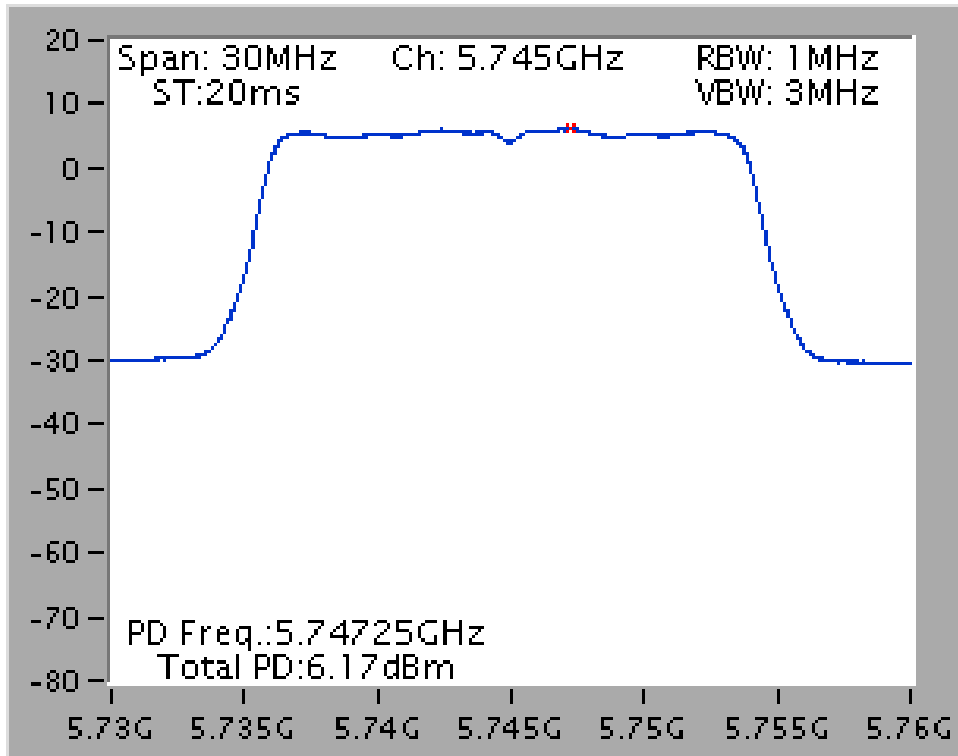

Power Density Plot on Configuration IEEE 802.11ac 20MHz / CH 157 / 1S3T TXBF / Ant. 1+2+3

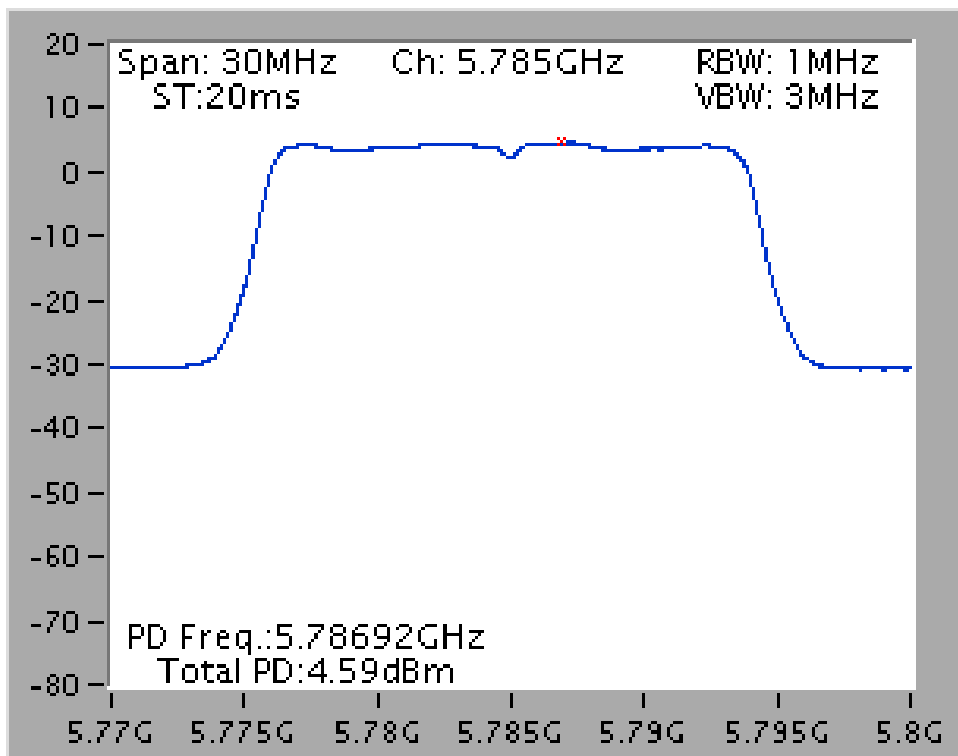

Power Density Plot on Configuration IEEE 802.11ac 20MHz / CH 165 / 1S3T TXBF / Ant. 1+2+3

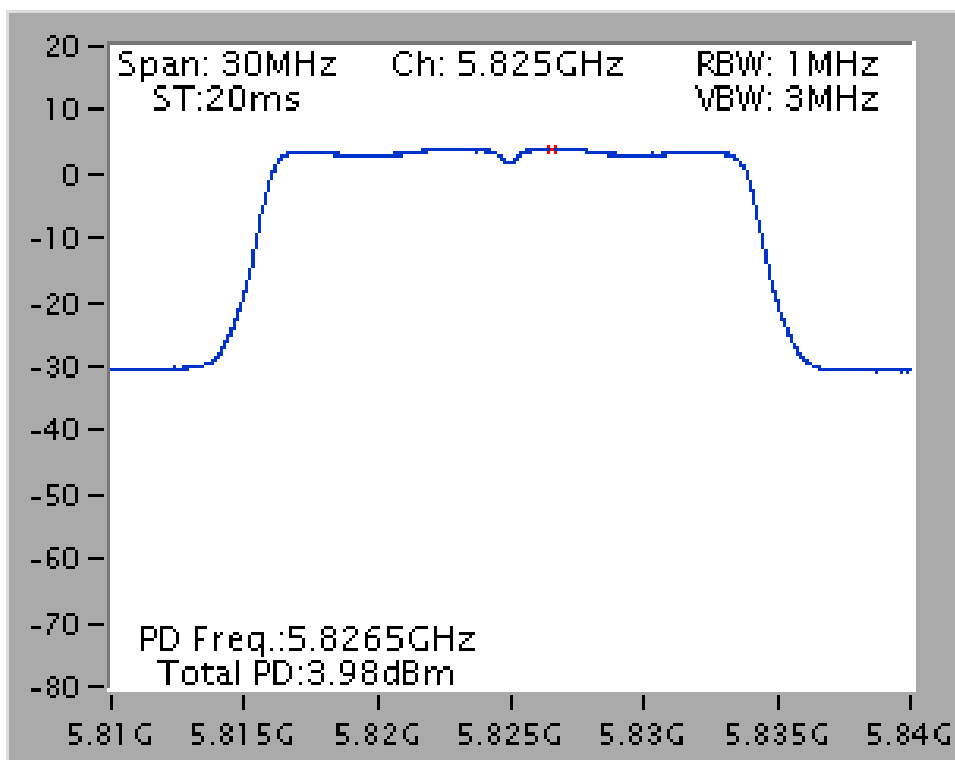

Test date	Mar. 17, 2015~Mar. 25, 2015	Test Site No.	TH01-CB
Temperature	20°C	Humidity	60%
Test Engineer	Mars Lin	Configuration	802.11ac 40MHz
Duty Cycle	<Nss1MCS0, Ant. 1>: 93.24% <Nss1MCS0, 1S3T, CDD>: 93.24% <Nss1MCS0, 1S3T, TXBF>: 90.65%		

Configuration IEEE 802.11ac 40MHz for U-NII-1 band

<Nss1MCS0, Ant. 1>

Channel	Frequency	Power Density (dBm/MHz)	Duty Factor	Total Power Density (dBm/MHz)	Antenna Gain	Max. Limit (dBm/MHz)	Result
38	5190 MHz	0.99	0.30	1.29	3.96	17.00	Complies
46	5230 MHz	2.41	0.30	2.71	3.79	17.00	Complies

Note:

$$5190\text{MHz} = \text{Directional Gain} = 10 \cdot \log \left[\frac{\sum_{j=1}^{N_{SS}} \left\{ \sum_{k=1}^{N_{ANT}} g_{j,k} \right\}^2}{N_{ANT}} \right] = 3.96 \text{ dBi} < 6\text{dBi}, \text{So } 5190\text{MHz Limit} = 17 \text{ dBm/MHz}$$

$$5230\text{MHz} = \text{Directional Gain} = 10 \cdot \log \left[\frac{\sum_{j=1}^{N_{SS}} \left\{ \sum_{k=1}^{N_{ANT}} g_{j,k} \right\}^2}{N_{ANT}} \right] = 3.79 \text{ dBi} < 6\text{dBi}, \text{So } 5230\text{MHz Limit} = 17 \text{ dBm/MHz}$$

<Nss1MCS0, 1S3T, CDD>

Channel	Frequency	Power Density (dBm/MHz)	Duty Factor	Total Power Density (dBm/MHz)	Directional Gain	Max. Limit (dBm/MHz)	Result
38	5190 MHz	4.27	0.30	4.57	6.47	16.53	Complies
46	5230 MHz	3.16	0.30	3.46	6.25	16.75	Complies

Note:

$$5190\text{MHz} = \text{Directional Gain} = 10 \cdot \log \left[\frac{\sum_{j=1}^{N_{SS}} \left\{ \sum_{k=1}^{N_{ANT}} g_{j,k} \right\}^2}{N_{ANT}} \right] = 6.47\text{dBi} > 6\text{dBi}, \text{So } 5190\text{MHz Limit} = 17 - (6.47 - 6) = 16.53 \text{ dBm/MHz}$$

$$5230\text{MHz} = \text{Directional Gain} = 10 \cdot \log \left[\frac{\sum_{j=1}^{N_{SS}} \left\{ \sum_{k=1}^{N_{ANT}} g_{j,k} \right\}^2}{N_{ANT}} \right] = 6.25\text{dBi} > 6\text{dBi}, \text{So } 5230\text{MHz Limit} = 17 - (6.25 - 6) = 16.75 \text{ dBm/MHz}$$

<Nss1MCS0, 1S3T, TXBF>

Channel	Frequency	Power Density (dBm/MHz)	Duty Factor	Total Power Density (dBm/MHz)	Directional Gain	Max. Limit (dBm/MHz)	Result
38	5190 MHz	2.89	0.43	3.32	6.47	16.53	Complies
46	5230 MHz	1.47	0.43	1.90	6.25	16.75	Complies

Note:

$$5190\text{MHz} = \text{Directional Gain} = 10 \cdot \log \left[\frac{\sum_{j=1}^{N_{SS}} \left\{ \sum_{k=1}^{N_{ANT}} g_{j,k} \right\}^2}{N_{ANT}} \right] = 6.47\text{dBi} > 6\text{dBi}, \text{So } 5190\text{MHz Limit} = 17 - (6.47 - 6) = 16.53 \text{ dBm/MHz}$$

$$5230\text{MHz} = \text{Directional Gain} = 10 \cdot \log \left[\frac{\sum_{j=1}^{N_{SS}} \left\{ \sum_{k=1}^{N_{ANT}} g_{j,k} \right\}^2}{N_{ANT}} \right] = 6.25\text{dBi} > 6\text{dBi}, \text{So } 5230\text{MHz Limit} = 17 - (6.25 - 6) = 16.75 \text{ dBm/MHz}$$

<Nss1MCS0, Ant. 1>

Power Density Plot on Configuration IEEE 802.11ac 40MHz / CH 38 / Ant. 1

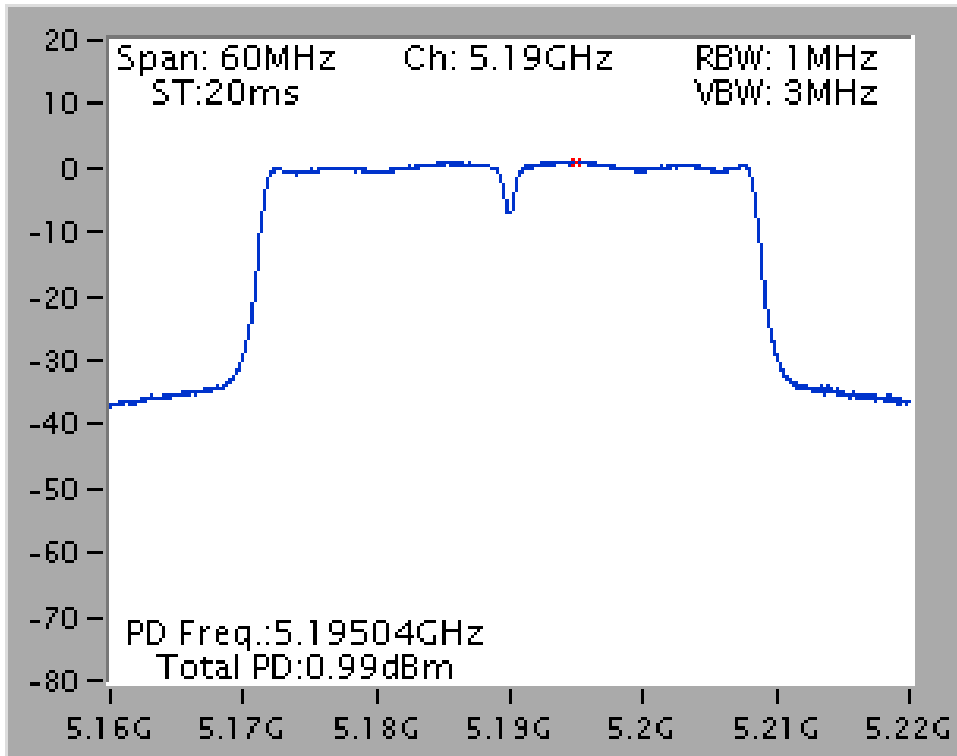

Power Density Plot on Configuration IEEE 802.11ac 40MHz / CH 46 / Ant. 1

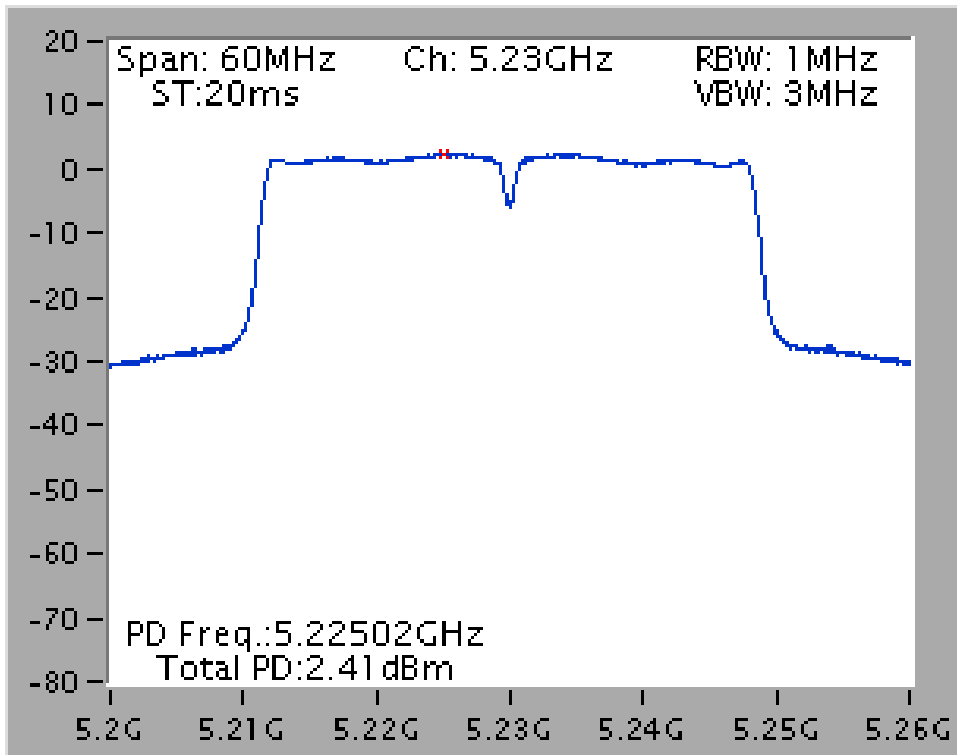

<Nss1MCS0, 1S3T, CDD>:

Power Density Plot on Configuration IEEE 802.11ac 40MHz / CH 38 / 1S3T CDD / Ant. 1+2+3

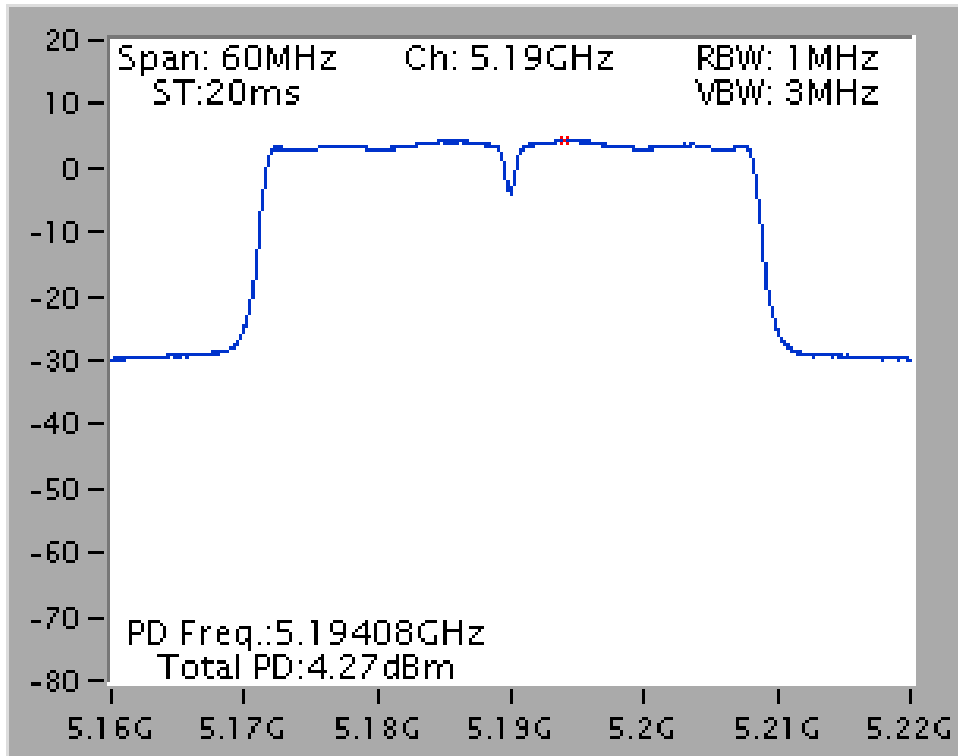

Power Density Plot on Configuration IEEE 802.11ac 40MHz / CH 46 / 1S3T CDD / Ant. 1+2+3

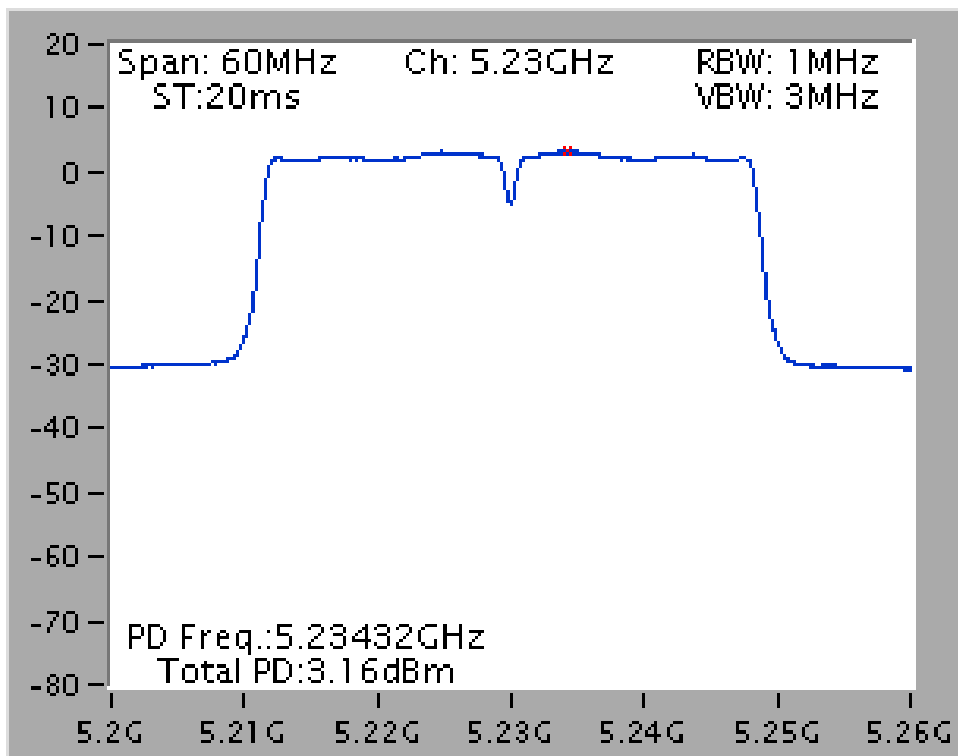

<Nss1MCS0, 1S3T, TXBF>:

Power Density Plot on Configuration IEEE 802.11ac 40MHz / CH 38 / 1S3T TXBF / Ant. 1+2+3

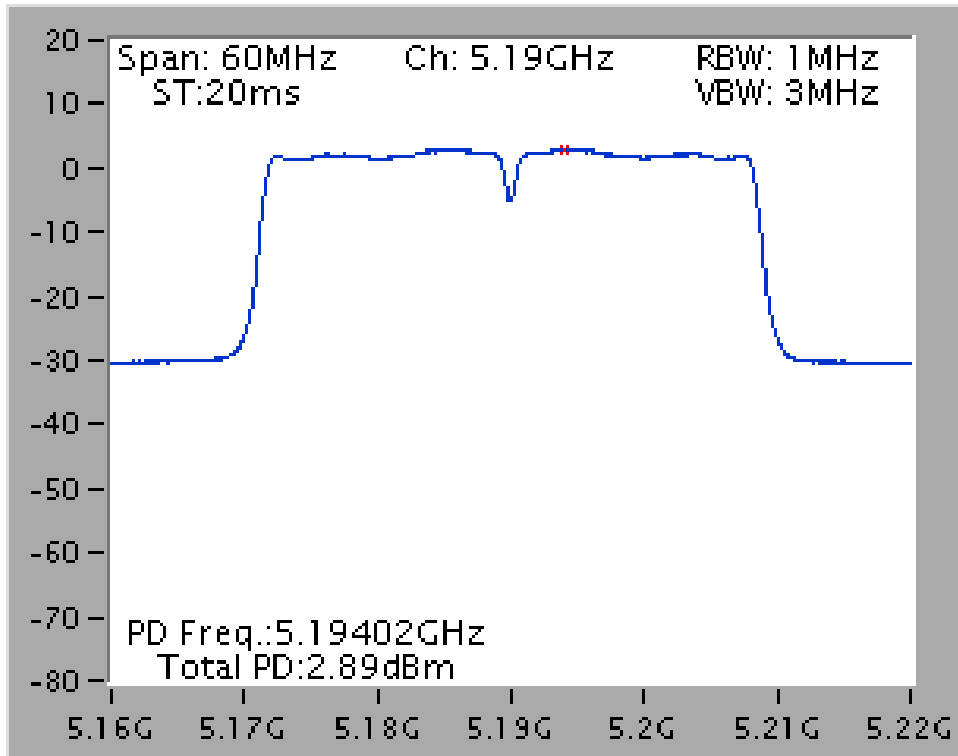

Power Density Plot on Configuration IEEE 802.11ac 40MHz / CH 46 / 1S3T TXBF / Ant. 1+2+3

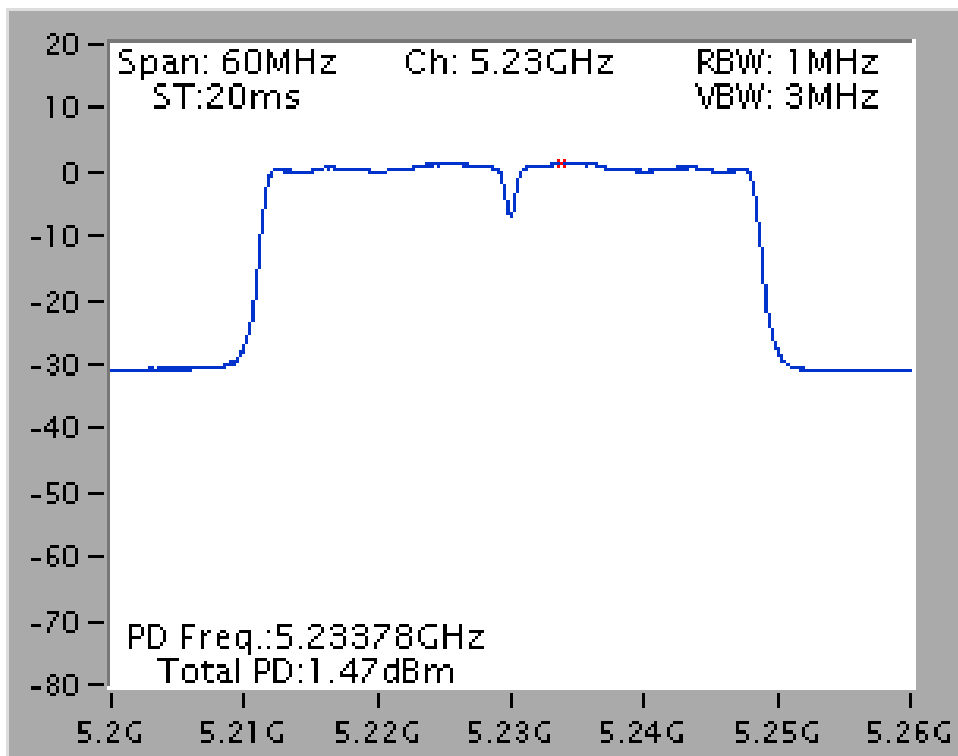

Configuration IEEE 802.11ac 40MHz for U-NII-3 band

<Nss1MCS0, Ant. 1>

Channel	Frequency	Power Density (dBm/MHz)	10log (500kHz /RBW) Factor (dB)	Power Density (dBm/500kHz)	Duty Factor	Total Power Density (dBm/500kHz)	Antenna Gain	Power Density Limit (dBm/500kHz)	Result
151	5755 MHz	-0.69	-3.01	-3.70	0.30	-3.40	4.45	30.00	Complies
159	5795 MHz	0.56	-3.01	-2.45	0.30	-2.15	4.69	30.00	Complies

Note:

$$5755 \text{ MHz} = \text{Directional Gain} = 10 \cdot \log \left[\frac{\sum_{j=1}^{N_{SS}} \left\{ \sum_{k=1}^{N_{ANT}} g_{j,k} \right\}^2}{N_{ANT}} \right] = 4.45 \text{ dBi} < 6\text{dBi}, \text{So } 5755\text{MHz Limit} = 30 \text{ dBm}/500\text{kHz}$$

$$5795 \text{ MHz} = \text{Directional Gain} = 10 \cdot \log \left[\frac{\sum_{j=1}^{N_{SS}} \left\{ \sum_{k=1}^{N_{ANT}} g_{j,k} \right\}^2}{N_{ANT}} \right] = 4.69 \text{ dBi} < 6\text{dBi}, \text{So } 5795\text{MHz Limit} = 30 \text{ dBm}/500\text{kHz}$$

<Nss1MCS0, 1S3T, CDD>

Channel	Frequency	Power Density (dBm/MHz)	10log (500kHz /RBW) Factor (dB)	Power Density (dBm/500kHz)	Duty Factor	Total Power Density (dBm/500kHz)	Directional Gain	Power Density Limit (dBm/500kHz)	Result
151	5755 MHz	3.46	-3.01	0.45	0.30	0.75	6.35	29.65	Complies
159	5795 MHz	4.82	-3.01	1.81	0.30	2.11	6.44	29.56	Complies

Note:

$$5755 \text{ MHz} = \text{Directional Gain} = 10 \cdot \log \left[\frac{\sum_{j=1}^{N_{SS}} \left\{ \sum_{k=1}^{N_{ANT}} g_{j,k} \right\}^2}{N_{ANT}} \right] = 6.35\text{dBi} > 6\text{dBi}, \text{So } 5755\text{MHz Limit} = 30 - (6.35 - 6) = 29.65 \text{ dBm}/500\text{kHz}$$

$$5795 \text{ MHz} = \text{Directional Gain} = 10 \cdot \log \left[\frac{\sum_{j=1}^{N_{SS}} \left\{ \sum_{k=1}^{N_{ANT}} g_{j,k} \right\}^2}{N_{ANT}} \right] = 6.44\text{dBi} > 6\text{dBi}, \text{So } 5795\text{MHz Limit} = 30 - (6.44 - 6) = 29.56 \text{ dBm}/500\text{kHz}$$

<Nss1MCS0, 1S3T, TXBF>

Channel	Frequency	Power Density (dBm/MHz)	10log (500kHz /RBW) Factor (dB)	Power Density (dBm/500kHz)	Duty Factor	Total Power Density (dBm/500kHz)	Directional Gain	Power Density Limit (dBm/500kHz)	Result
151	5755 MHz	2.70	-3.01	-0.31	0.43	0.12	6.35	29.65	Complies
159	5795 MHz	2.28	-3.01	-0.73	0.43	-0.30	6.44	29.56	Complies

Note:

$$5755 \text{ MHz} = \text{Directional Gain} = 10 \cdot \log \left[\frac{\sum_{j=1}^{N_{SS}} \left\{ \sum_{k=1}^{N_{ANT}} g_{j,k} \right\}^2}{N_{ANT}} \right] = 6.35 \text{dBi} > 6 \text{dBi}, \text{So } 5755 \text{MHz Limit} = 30 - (6.35 - 6) = 29.65 \text{ dBm/500kHz}$$

$$5795 \text{ MHz} = \text{Directional Gain} = 10 \cdot \log \left[\frac{\sum_{j=1}^{N_{SS}} \left\{ \sum_{k=1}^{N_{ANT}} g_{j,k} \right\}^2}{N_{ANT}} \right] = 6.44 \text{dBi} > 6 \text{dBi}, \text{So } 5795 \text{MHz Limit} = 30 - (6.44 - 6) = 29.56 \text{ dBm/500kHz}$$

<Nss1MCS0, Ant. 1>:

Power Density Plot on Configuration IEEE 802.11ac 40MHz / CH 151 / Ant. 1

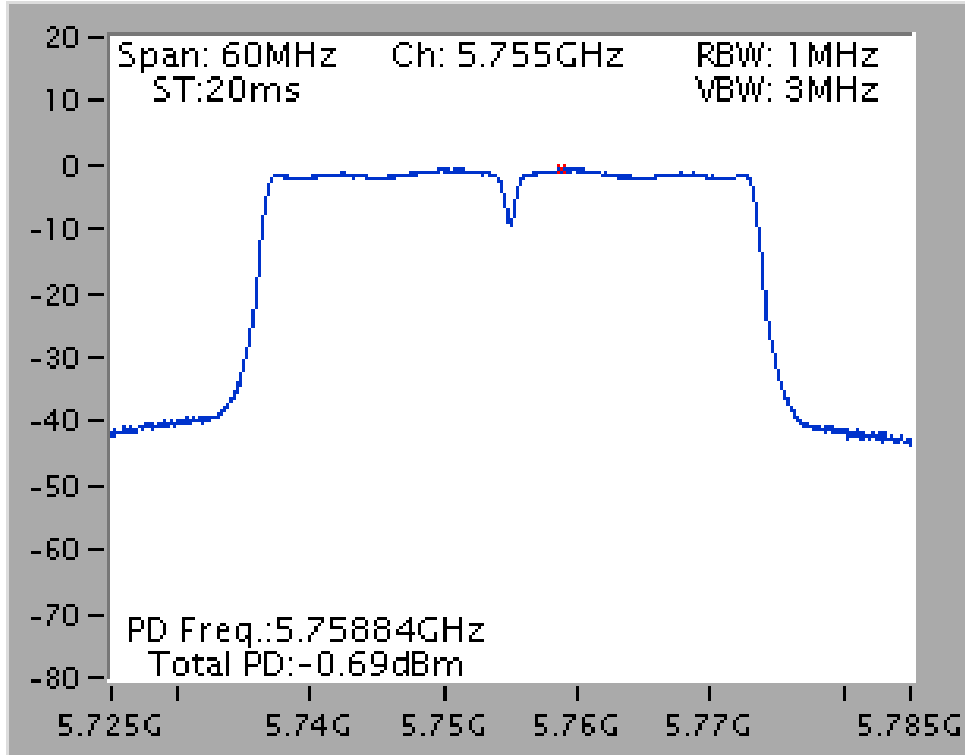

Power Density Plot on Configuration IEEE 802.11ac 40MHz / CH 159 / Ant. 1

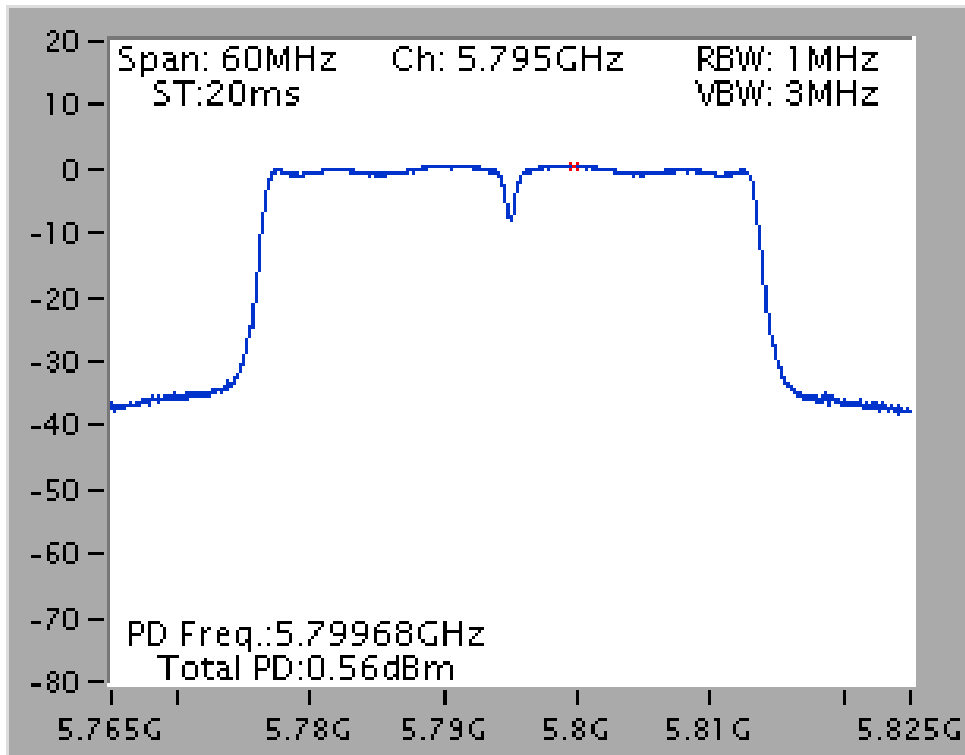

<Nss1MCS0, 1S3T, CDD>:

Power Density Plot on Configuration IEEE 802.11ac 40MHz / CH 151 / 1S3T CDD / Ant. 1+2+3

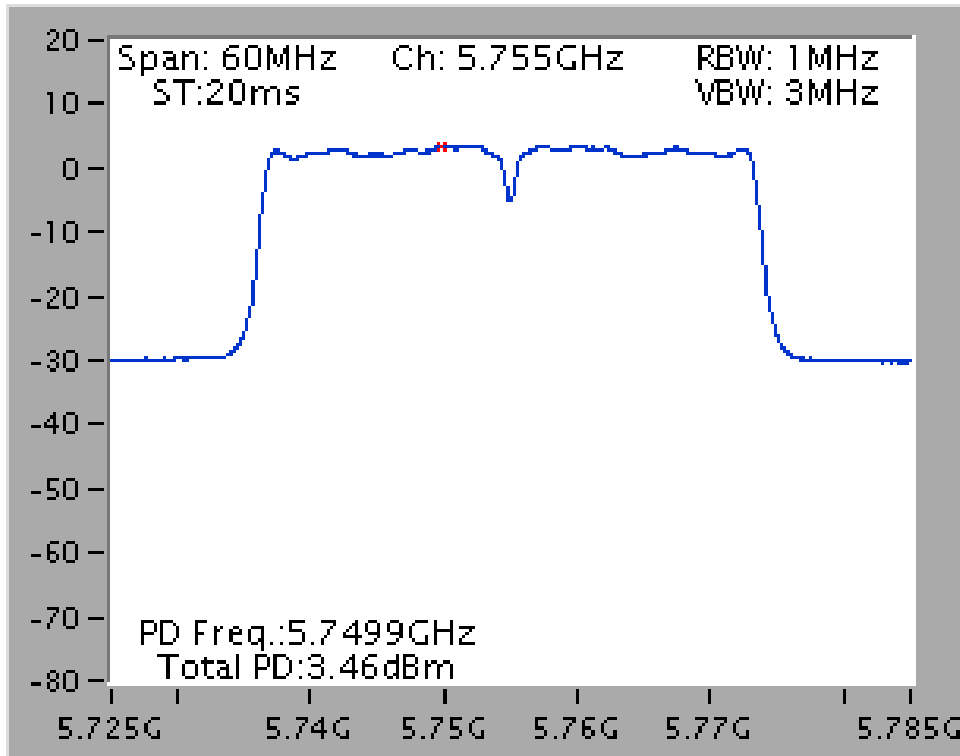

Power Density Plot on Configuration IEEE 802.11ac 40MHz / CH 159 / 1S3T CDD / Ant. 1+2+3

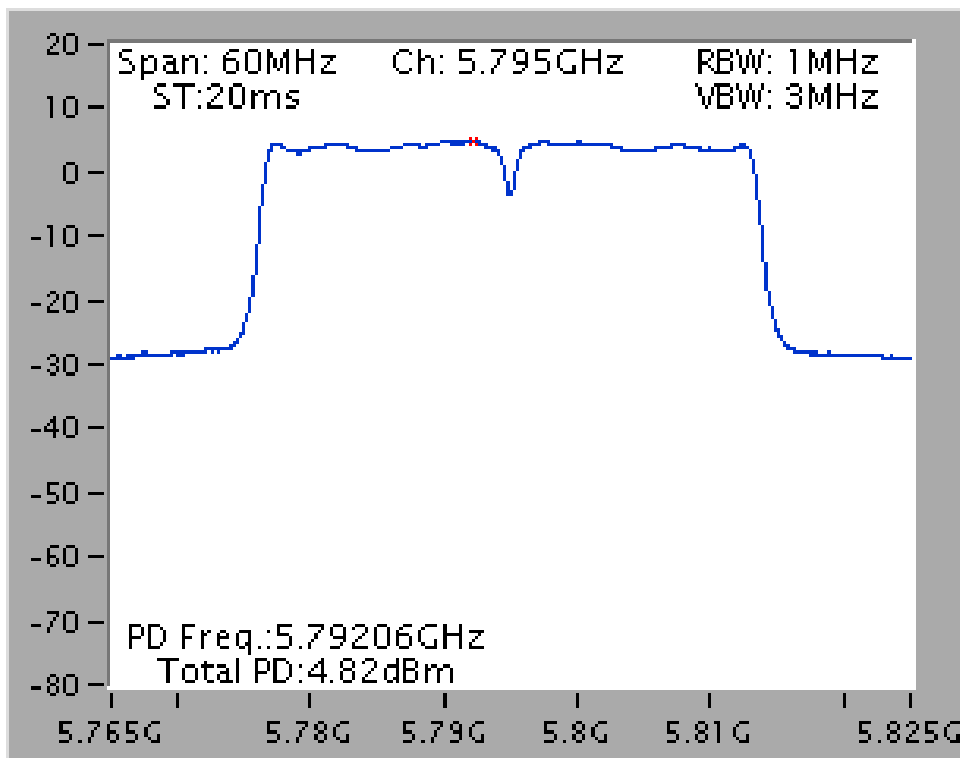

<Nss1MCS0, 1S3T, TXBF>:

Power Density Plot on Configuration IEEE 802.11ac 40MHz / CH 151 / 1S3T TXBF / Ant. 1+2+3

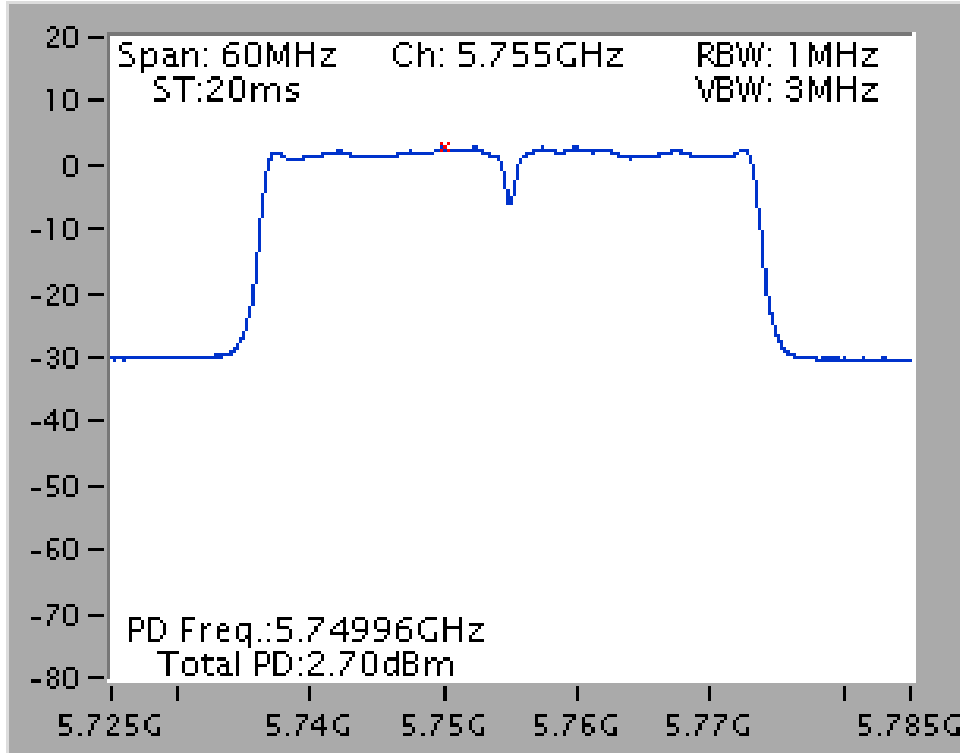

Power Density Plot on Configuration IEEE 802.11ac 40MHz / CH 159 / 1S3T TXBF / Ant. 1+2+3

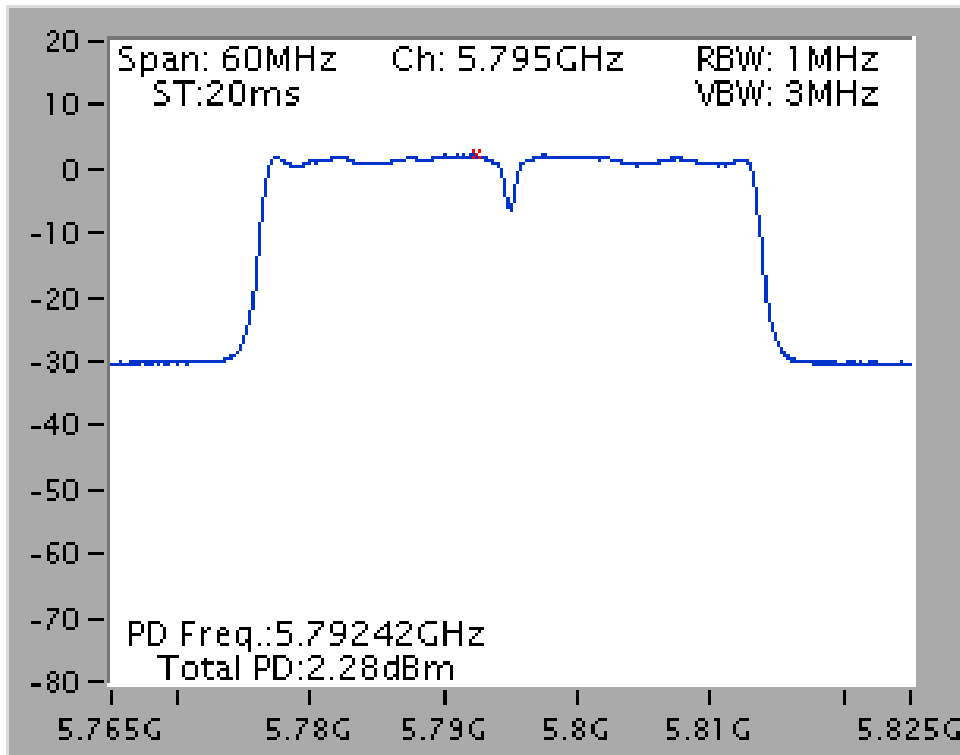

Test date	Mar. 17, 2015~Mar. 25, 2015	Test Site No.	TH01-CB
Temperature	20°C	Humidity	60%
Test Engineer	Mars Lin	Configuration	802.11ac 80MHz
Duty Cycle	<Nss1MCS0, Ant. 1>: 87.12% <Nss1MCS0, 1S3T, CDD>: 87.12% <Nss1MCS0, 1S3T, TXBF>: 79.93%		

Configuration IEEE 802.11ac 80MHz for U-NII-1 band

<Nss1MCS0, Ant. 1>

Channel	Frequency	Power Density (dBm/MHz)	Duty Factor	Total Power Density (dBm/MHz)	Antenna Gain	Max. Limit (dBm/MHz)	Result
42	5210 MHz	-4.11	0.60	-3.51	3.87	17.00	Complies

Note:

$$5210 \text{ MHz} = \text{Directional Gain} = 10 \cdot \log \left[\frac{\sum_{j=1}^{N_{SS}} \left\{ \sum_{k=1}^{N_{ANT}} g_{j,k} \right\}^2}{N_{ANT}} \right] = 3.87 \text{ dBi} < 6\text{dBi}, \text{So } 5210\text{MHz Limit} = 17 \text{ dBm/MHz}$$

<Nss1MCS0, 1S3T, CDD>

Channel	Frequency	Power Density (dBm/MHz)	Duty Factor	Total Power Density (dBm/MHz)	Directional Gain	Max. Limit (dBm/MHz)	Result
42	5210 MHz	-1.59	0.60	-0.99	6.40	16.60	Complies

Note:

$$5210 \text{ MHz} = \text{Directional Gain} = 10 \cdot \log \left[\frac{\sum_{j=1}^{N_{SS}} \left\{ \sum_{k=1}^{N_{ANT}} g_{j,k} \right\}^2}{N_{ANT}} \right] = 6.40\text{dBi} > 6\text{dBi}, \text{So } 5210\text{MHz Limit} = 17 - (6.40 - 6) = 16.60 \text{ dBm/MHz}$$

<Nss1MCS0, 1S3T, TXBF>

Channel	Frequency	Power Density (dBm/MHz)	Duty Factor	Total Power Density (dBm/MHz)	Directional Gain	Max. Limit (dBm/MHz)	Result
42	5210 MHz	-1.11	0.97	-0.14	6.40	16.60	Complies

Note:

$$5210 \text{ MHz} = \text{Directional Gain} = 10 \cdot \log \left[\frac{\sum_{j=1}^{N_{SS}} \left\{ \sum_{k=1}^{N_{ANT}} g_{j,k} \right\}^2}{N_{ANT}} \right] = 6.40\text{dBi} > 6\text{dBi}, \text{So } 5210\text{MHz Limit} = 17 - (6.40 - 6) = 16.60 \text{ dBm/MHz}$$

<Nss1MCS0, Ant. 1>

Power Density Plot on Configuration IEEE 802.11ac 80MHz / CH 42 / Ant. 1

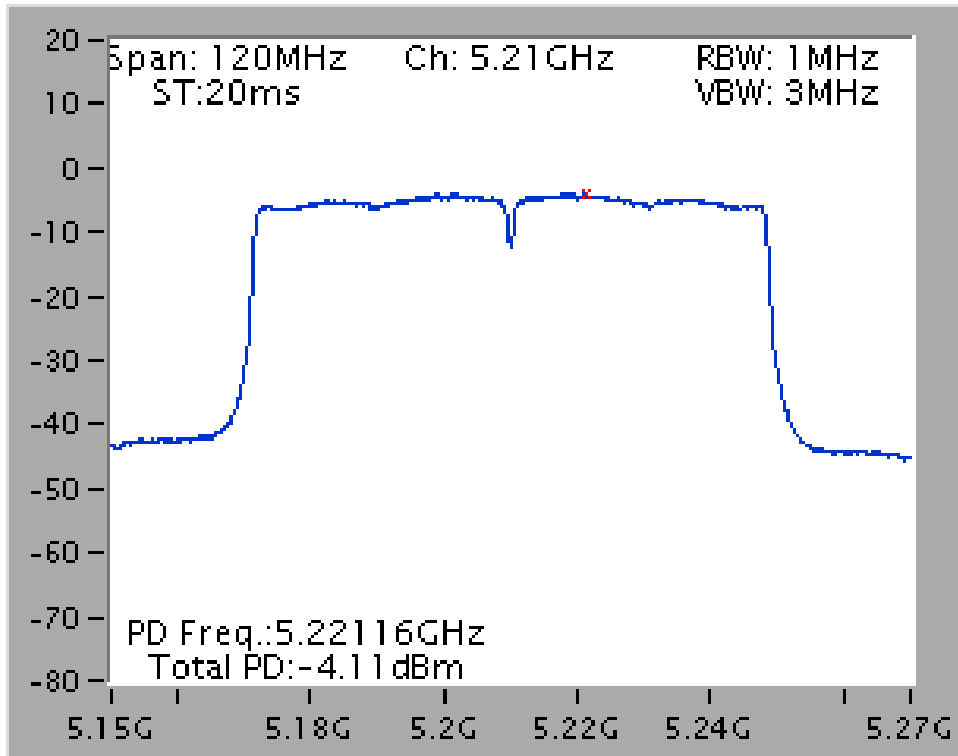

<Nss1MCS0, 1S3T, CDD>

Power Density Plot on Configuration IEEE 802.11ac 80MHz / CH 42 / 1S3T CDD / Ant. 1+2+3

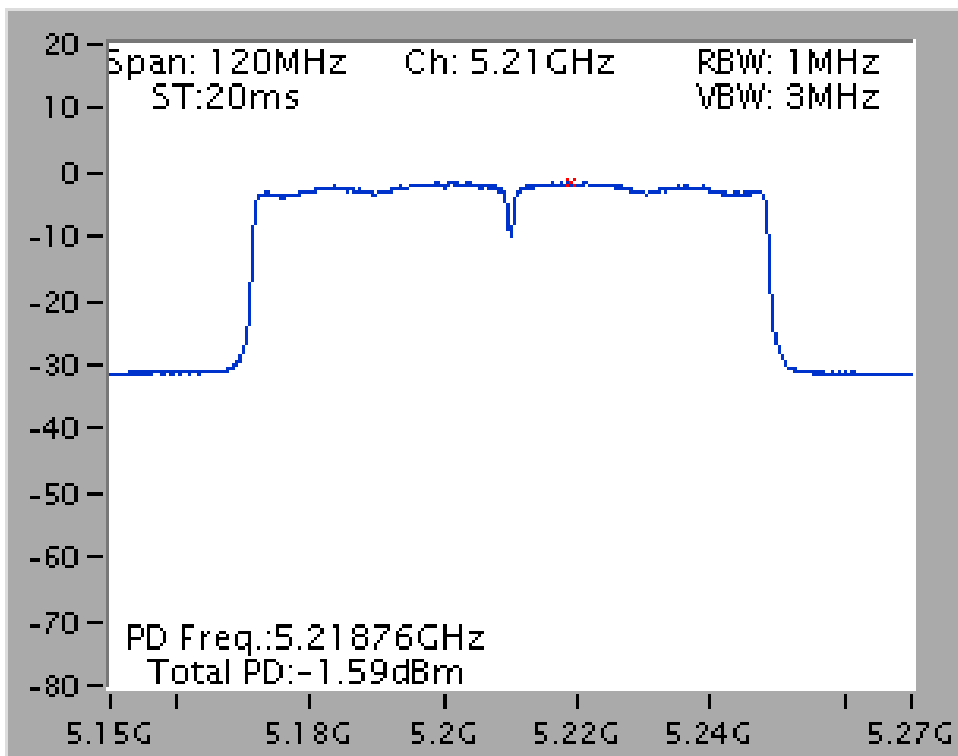

<Nss1MCS0, 1S3T, TXBF>:

Power Density Plot on Configuration IEEE 802.11ac 80MHz / CH 42 / 1S3T TXBF / Ant. 1+2+3

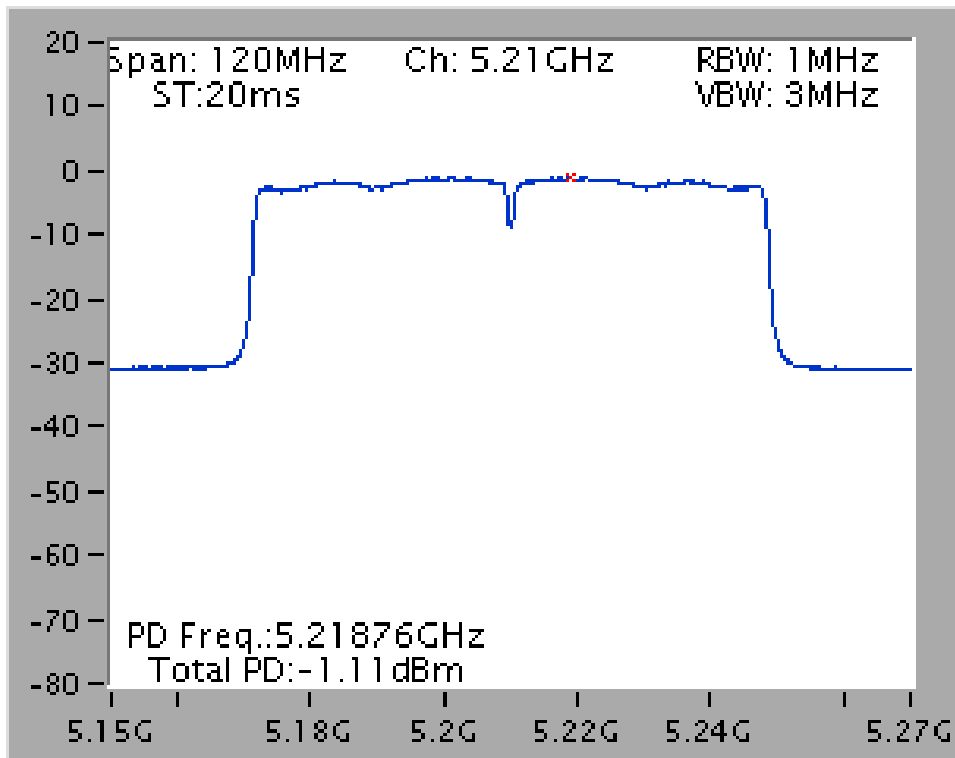

Configuration IEEE 802.11ac 80MHz for U-NII-3 band

<Nss1MCS0, Ant. 1>

Channel	Frequency	Power Density (dBm/MHz)	10log (500kHz /RBW) Factor (dB)	Power Density (dBm/500kHz)	Duty Factor	Total Power Density (dBm/500kHz)	Antenna Gain	Power Density Limit (dBm/500kHz)	Result
155	5775 MHz	-4.92	-3.01	-7.93	0.60	-7.33	4.64	30.00	Complies

Note:

$$5775 \text{ MHz} = \text{Directional Gain} = 10 \cdot \log \left[\frac{\sum_{j=1}^{N_{SS}} \left\{ \sum_{k=1}^{N_{ANT}} g_{j,k} \right\}^2}{N_{ANT}} \right] = 4.64 \text{ dBi} < 6\text{dBi}, \text{ So } 5775\text{MHz Limit} = 30 \text{ dBm}/500\text{kHz}$$

<Nss1MCS0, 1S3T, CDD>

Channel	Frequency	Power Density (dBm/MHz)	10log (500kHz /RBW) Factor (dB)	Power Density (dBm/500kHz)	Duty Factor	Total Power Density (dBm/500kHz)	Directional Gain	Power Density Limit (dBm/500kHz)	Result
155	5775 MHz	-1.65	-3.01	-4.66	0.60	4.06	6.45	29.55	Complies

Note:

$$5775 \text{ MHz} = \text{Directional Gain} = 10 \cdot \log \left[\frac{\sum_{j=1}^{N_{SS}} \left\{ \sum_{k=1}^{N_{ANT}} g_{j,k} \right\}^2}{N_{ANT}} \right] = 6.45\text{dBi} > 6\text{dBi}, \text{ So } 5775\text{MHz Limit} = 30 - (6.45 - 6) = 29.55 \text{ dBm}/500\text{kHz}$$

<Nss1MCS0, 1S3T, TXBF>

Channel	Frequency	Power Density (dBm/MHz)	10log (500kHz /RBW) Factor (dB)	Power Density (dBm/500kHz)	Duty Factor	Total Power Density (dBm/500kHz)	Directional Gain	Power Density Limit (dBm/500kHz)	Result
155	5775 MHz	-1.99	-3.01	-5.00	0.97	-4.03	6.45	29.55	Complies

Note:

$$5775 \text{ MHz} = \text{Directional Gain} = 10 \cdot \log \left[\frac{\sum_{j=1}^{N_{SS}} \left\{ \sum_{k=1}^{N_{ANT}} g_{j,k} \right\}^2}{N_{ANT}} \right] = 6.45\text{dBi} > 6\text{dBi}, \text{ So } 5775\text{MHz Limit} = 30 - (6.45 - 6) = 29.55 \text{ dBm}/500\text{kHz}$$

<Nss1MCS0, Ant. 1>:

Power Density Plot on Configuration IEEE 802.11ac 80MHz / CH 155 / Ant. 1

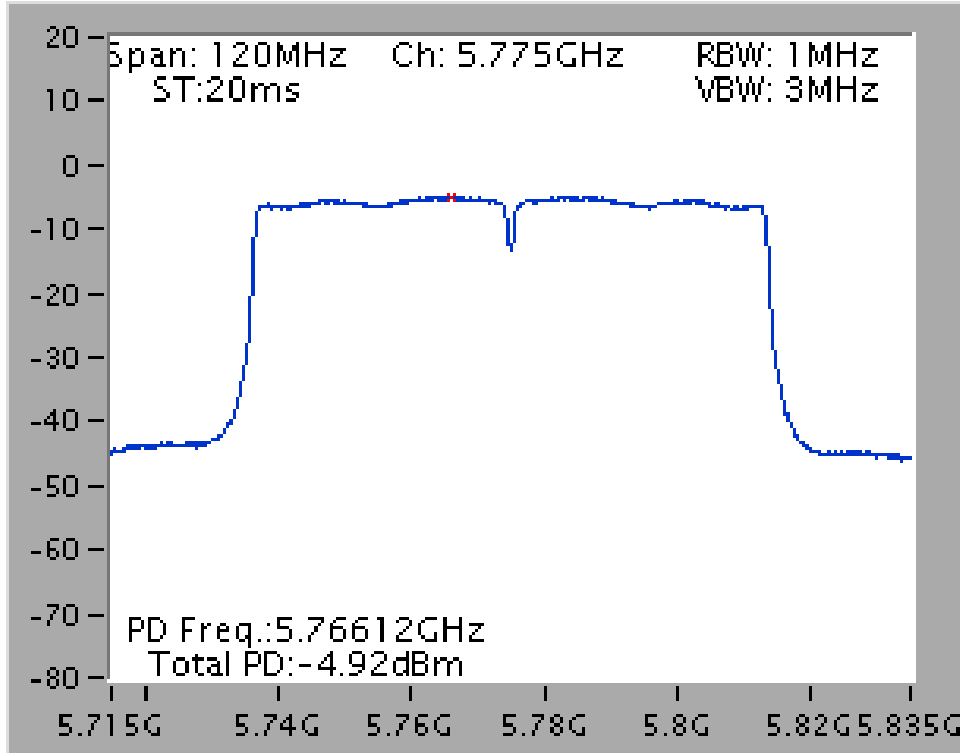

<Nss1MCS0, 1S3T, CDD>:

Power Density Plot on Configuration IEEE 802.11ac 80MHz / CH 155 / 1S3T CDD / Ant. 1+2+3

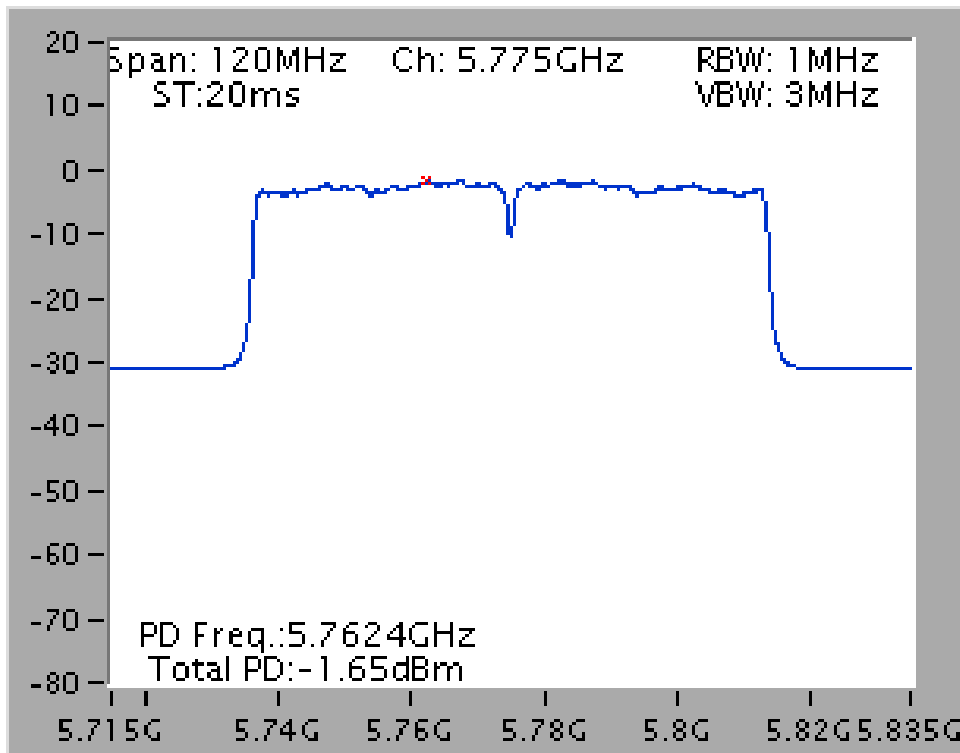

<Nss1MCS0, 1S3T, TXBF>:

Power Density Plot on Configuration IEEE 802.11ac 80MHz / CH 155 / 1S3T TXBF / Ant. 1+2+3

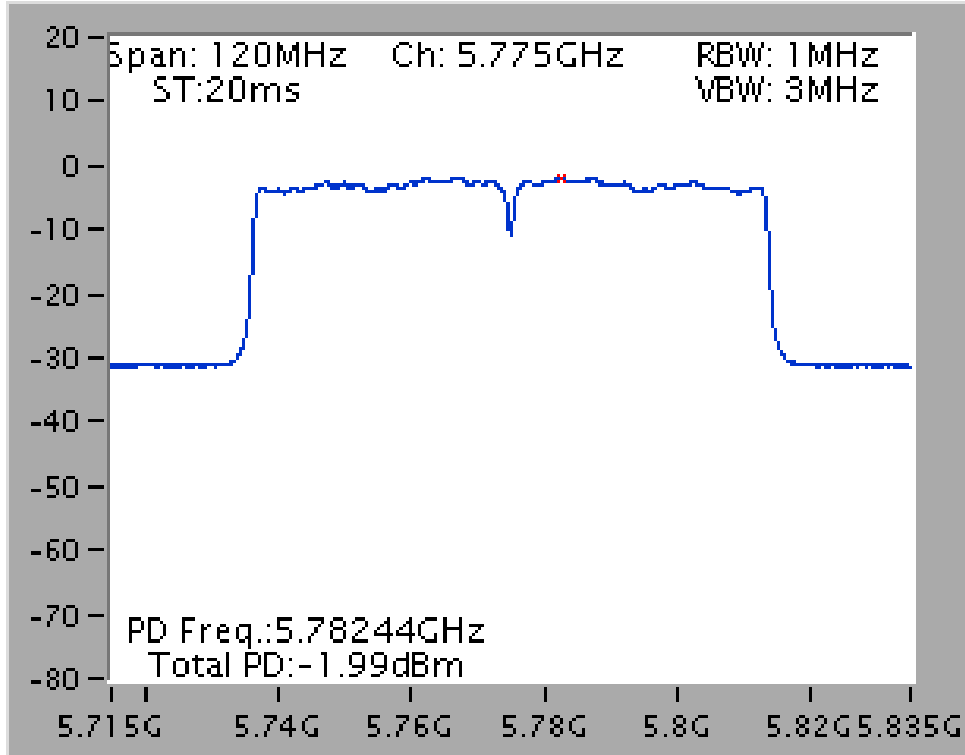

3.5 Radiated Emissions Measurement

3.5.1 Limit of Unwanted emissions in the restricted bands

Radiated emissions which fall within the restricted band specified on 15.205(a) must comply with the radiated emission limits specified as below table:

Frequencies (MHz)	Field Strength (microvolts/meter)	Measurement Distance (meters)
0.009~0.490	2400/F(kHz)	300
0.490~1.705	24000/F(kHz)	30
1.705~30.0	30	30
30~88	100	3
88~216	150	3
216~960	200	3
Above 960	500	3

Note:

1. The lower limit shall apply at the transition frequencies.
2. Emission level (dBµV/m) = 20 log Emission level (µV/m).
3. For frequencies above 1000MHz, the field strength limits are based on average detector, however, the peak field strength of any emission shall not exceed the maximum permitted average limits, specified above by more than 20dB under any condition of modulation.

3.5.2 Limits of Unwanted Emission out of the restricted bands

APPLICABLE TO	EIRP LIMIT (dBm)	EQUIVALENT FIELD STRENGTH AT 3m (dBµV/m)	
U-NII-1 5150~5250MHz	PK: -27 (dBm/MHz)	PK: 68.2 (dBµV/m)	-27dBm/MHz can be substituted by PK: 74 (dBµV/m) AV: 54 (dBµV/m)
U-NII-3 5725~5850MHz	PK: -27 (dBm/MHz) *1 PK: -17 (dBm/MHz) *2	PK: 68.2 (dBµV/m) *1 PK: 78.2 (dBµV/m) *2	

Note: *1 beyond 10MHz of the band edge ; *2 within 10 MHz of band edge

The following formula is used to convert the equipment isotropic radiated power (eirp) to field strength:

$$E = \frac{100000\sqrt{30P}}{3} \mu\text{V/m, where P is the eirp (Watts).}$$

3.5.3 Measuring Instruments and Setting

Please refer to section 4 of equipments list in this report. The following table is the setting of spectrum analyzer and receiver.

Spectrum Parameter	Setting
Attenuation	Auto
Start Frequency	1GHz
Stop Frequency	10th carrier harmonic
RBW / VBW (Emission in restricted band)	1MHz / 3MHz for Peak, 1MHz / 1/T for Average
RBW / VBW (Emission in non-restricted band)	1MHz / 3MHz for peak
Detector	Peak
Trace mode	max hold.

Receiver Parameter	Setting
Attenuation	Auto
Start ~ Stop Frequency	9kHz~150kHz / RBW 200Hz for QP
Start ~ Stop Frequency	150kHz~30MHz / RBW 9kHz for QP
Start ~ Stop Frequency	30MHz~1GHz / RBW 120kHz for QP

3.5.4 Test Procedures

1. Configure the EUT according to ANSI C63.10. The EUT was placed on the top of the turntable 1.5 meter above ground. The phase center of the receiving antenna mounted on the top of a height-variable antenna tower was placed 3 meters far away from the turntable.
2. Power on the EUT and all the supporting units. The turntable was rotated by 360 degrees to determine the position of the highest radiation.
3. The height of the broadband receiving antenna was varied between one meter and four meters above ground to find the maximum emissions field strength of both horizontal and vertical polarization.
4. For each suspected emissions, the antenna tower was scan (from 1 m to 4 m) and then the turntable was rotated (from 0 degree to 360 degrees) to find the maximum reading.
5. Set the test-receiver system to Peak or CISPR quasi-peak Detect Function with specified bandwidth under Maximum Hold Mode.
6. For emissions above 1GHz, use 1MHz VBW and 3MHz RBW for peak reading. Then 1MHz RBW and 1/T VBW for average reading in spectrum analyzer.
7. When the radiated emissions limits are expressed in terms of the average value of the emissions, and pulsed operation is employed, the measurement field strength shall be determined by averaging over one complete pulse train, including blanking intervals, as long as the pulse train does not exceed 0.1 seconds. As an alternative (provided the transmitter operates for longer than 0.1 seconds) or in cases where the pulse train exceeds 0.1 seconds, the measured field strength shall be determined from the average absolute

voltage during a 0.1 second interval during which the field strength is at its maximum value.

8. If the emissions level of the EUT in peak mode was 3 dB lower than the average limit specified, then testing will be stopped and peak values of EUT will be reported, otherwise, the emissions which do not have 3 dB margin will be repeated one by one using the quasi-peak method for below 1GHz.
9. For testing above 1GHz, the emissions level of the EUT in peak mode was lower than average limit (that means the emissions level in peak mode also complies with the limit in average mode), then testing will be stopped and peak values of EUT will be reported, otherwise, the emissions will be measured in average mode again and reported.
10. In case the emission is lower than 30MHz, loop antenna has to be used for measurement and the recorded data should be QP measured by receiver. High – Low scan is not required in this case.

3.5.5 Test Setup Layout

For Radiated Emissions below 1GHz (9kHz~30MHz)

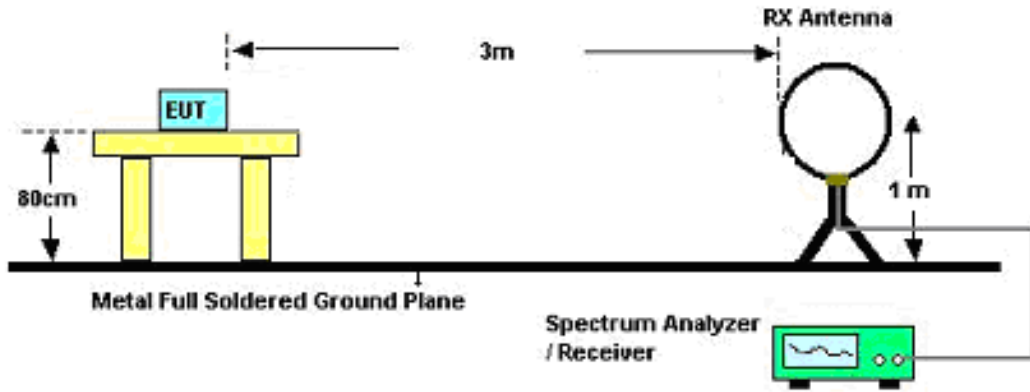

For Radiated Emissions below 1GHz (30MHz~1GHz)

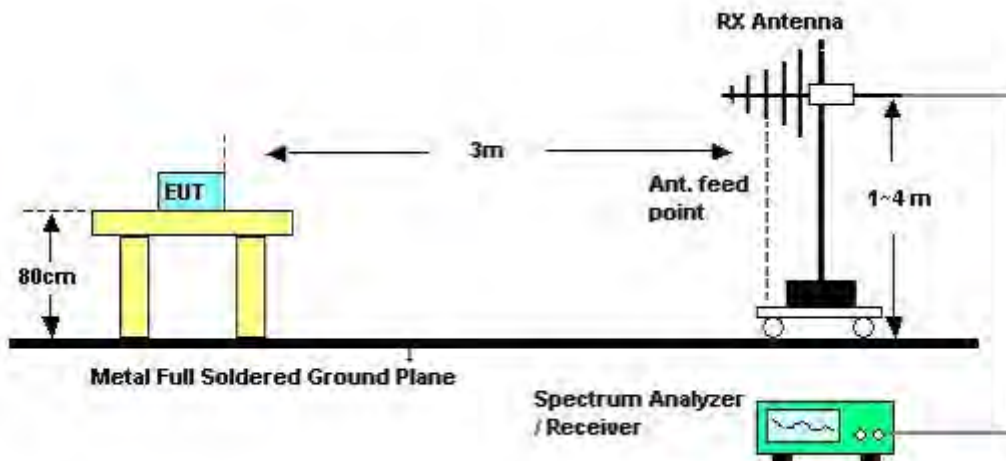

For Radiated Emissions above 1GHz

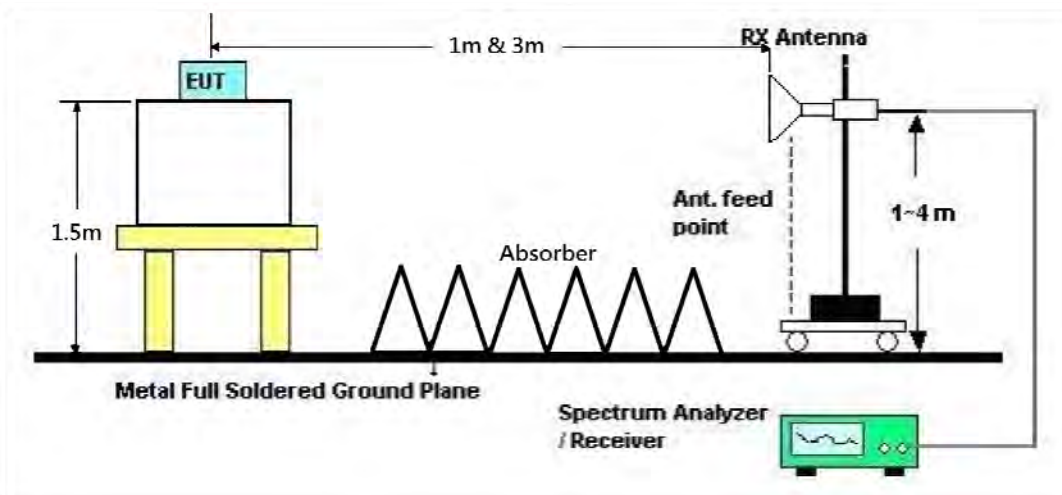

3.5.6 Test Deviation

There is no deviation with the original standard.

3.5.7 EUT Operation during Test

For Non-beamforming mode:

The EUT was programmed to be in continuously transmitting mode.

For beamforming mode:

The EUT was programmed to be in beamforming transmitting mode.

3.5.8 Results of Radiated Emissions (9kHz~30MHz)

Frequency Range	9kHz~30MHz	Test Site No.	03CH01-CB
Temperature	26°C	Humidity	68%
Test Engineer	Brain Sun	Configurations	CTX
Test Date	Mar. 23, 2015		

Freq. (MHz)	Level (dBuV)	Over Limit (dB)	Limit Line (dBuV)	Remark
-	-	-	-	See Note

Note:

The amplitude of spurious emissions that are attenuated by more than 20 dB below the permissible value has no need to be reported.

Distance extrapolation factor = $40 \log(\text{specific distance} / \text{test distance})$ (dB);

Limit line = specific limits (dBuV) + distance extrapolation factor.

3.5.9 Results of Radiated Emissions (30MHz~1GHz)

Frequency Range	30MHz~1GHz	Test Site No.	03CH01-CB
Temperature	26°C	Humidity	68%
Test Engineer	Brain Sun	Configurations	CTX

Horizontal

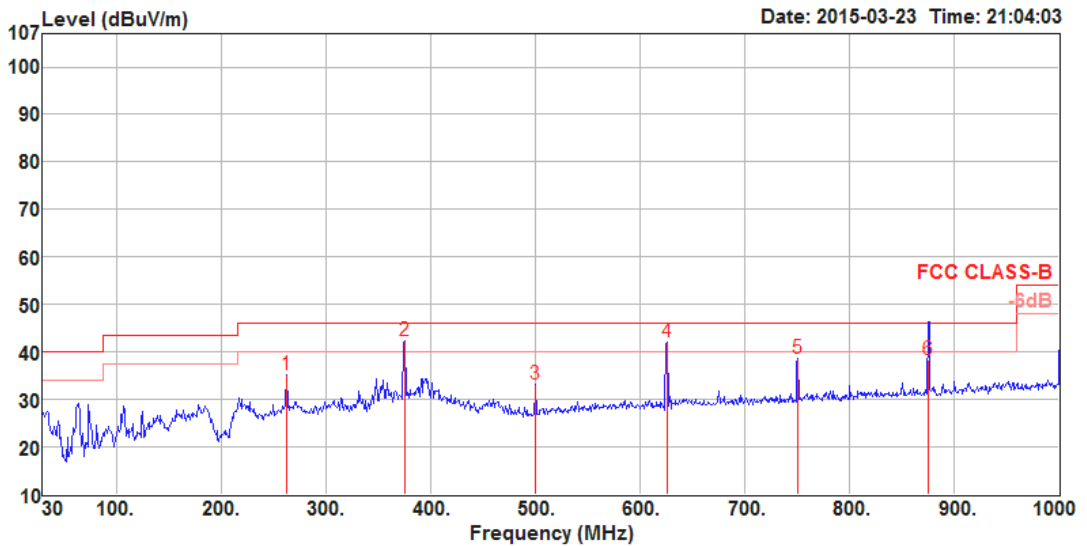

	Freq	Level	Limit Line	Over Limit	ReadAntenna Level	Antenna Factor	Cable Loss	Preamp Factor	A/Pos	T/Pos	Pol/Phase	Remark
	MHz	dBuV/m	dBuV/m	dB	dBuV	dB/m	dB	dB	cm	deg		
1	262.80	35.17	46.00	-10.83	52.15	13.84	1.61	32.43	125	212	HORIZONTAL	Peak
2	375.32	42.39	46.00	-3.61	56.85	15.93	1.93	32.32	100	241	HORIZONTAL	Peak
3	500.45	33.21	46.00	-12.79	45.60	17.81	2.21	32.41	150	260	HORIZONTAL	Peak
4	625.58	42.10	46.00	-3.90	52.91	19.26	2.46	32.53	125	280	HORIZONTAL	Peak
5	750.71	38.62	46.00	-7.38	48.12	20.21	2.71	32.42	100	304	HORIZONTAL	Peak
6	874.87	38.46	46.00	-7.54	46.21	21.35	2.95	32.05	100	292	HORIZONTAL	QP

Note:

The amplitude of spurious emissions which are attenuated by more than 20 dB below the permissible value has no need to be reported.

Emission level (dBuV/m) = 20 log Emission level (uV/m).

Corrected Reading: Antenna Factor + Cable Loss + Read Level - Preamp Factor = Level.

Vertical

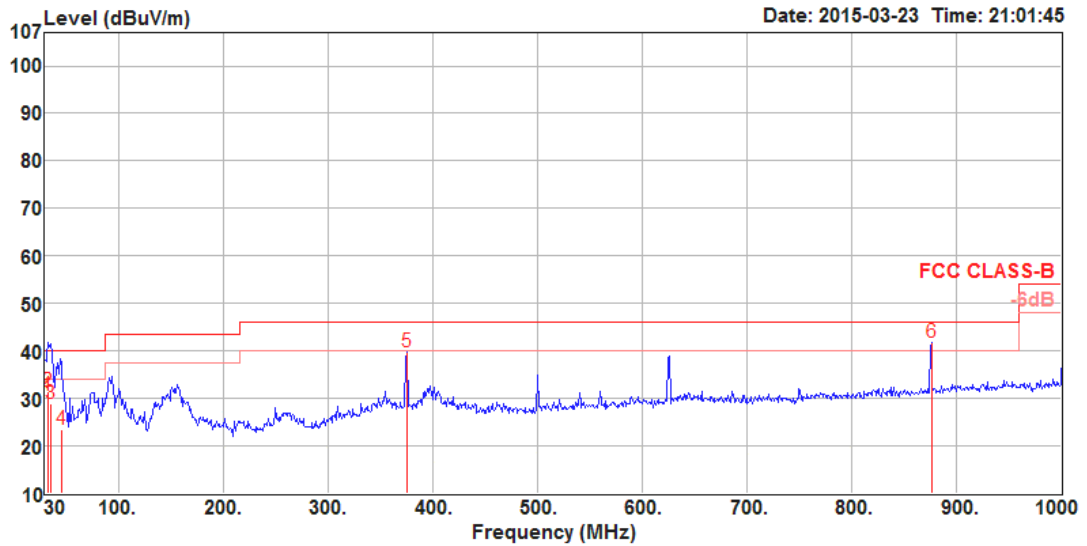

	Freq	Level	Limit	Over	ReadAntenna	Cable	Preamp	A/Pos	T/Pos	Pol/Phase	Remark
	MHz	dBuV/m	dBuV/m	dB	dBuV	dB/m	dB	dB	cm	deg	
1	32.91	30.56	40.00	-9.44	44.21	18.20	0.57	32.42	100	188 VERTICAL	QP
2	32.91	31.47	40.00	-8.53	45.12	18.20	0.57	32.42	100	188 VERTICAL	QP
3	34.85	28.77	40.00	-11.23	43.56	17.00	0.62	32.41	125	193 VERTICAL	QP
4	45.52	23.32	40.00	-16.68	44.23	10.83	0.69	32.43	100	0 VERTICAL	QP
5	375.32	39.89	46.00	-6.11	54.37	15.91	1.93	32.32	125	254 VERTICAL	Peak
6	875.84	41.75	46.00	-4.25	49.49	21.36	2.95	32.05	125	270 VERTICAL	Peak

Note:

The amplitude of spurious emissions which are attenuated by more than 20 dB below the permissible value has no need to be reported.

Emission level (dBuV/m) = 20 log Emission level (uV/m).

Corrected Reading: Antenna Factor + Cable Loss + Read Level - Preamp Factor = Level.

3.5.10 Results of Emission not in Restricted Bands

Following channel(s) was (were) selected for the final test as listed below.

Mode	TX Antenna	Test Channel	Modulation Technology	Modulation Type	Data Rate (Mbps)
802.11a	Ant.1	36, 40, 48 149, 157, 165	OFDM	BPSK	6
802.11a	1S3T, CDD	36, 40, 48 149, 157, 165	OFDM	BPSK	6
802.11ac 20MHz	Ant.1	36, 40, 48 149, 157, 165	OFDM	BPSK	Nss1MCS0 (6.5)
802.11ac 20MHz	1S3T, CDD	36, 40, 48 149, 157, 165	OFDM	BPSK	Nss1MCS0 (6.5)
802.11ac 20MHz	1S3T, TXBF	36, 40, 48 149, 157, 165	OFDM	BPSK	Nss1MCS0 (6.5)
802.11ac 40MHz	Ant.1	38, 46 151, 159	OFDM	BPSK	Nss1MCS0 (13.5)
802.11ac 40MHz	1S3T, CDD	38, 46 151, 159	OFDM	BPSK	Nss1MCS0 (13.5)
802.11ac 40MHz	1S3T, TXBF	38, 46 151, 159	OFDM	BPSK	Nss1MCS0 (13.5)
802.11ac 80MHz	Ant.1	42 155	OFDM	BPSK	Nss1MCS0 (29.5)
802.11ac 80MHz	1S3T, CDD	42 155	OFDM	BPSK	Nss1MCS0 (29.5)
802.11ac 80MHz	1S3T, TXBF	42 155	OFDM	BPSK	Nss1MCS0 (29.5)

Unwanted emissions in the restricted bands (Above 1GHz)			
Operating Mode	IEEE 802.11a 6Mbps / CH36 / Ant. 1		
Temperature	26°C	Humidity	68%
Test Engineer	Brian Sun	Polarization	H

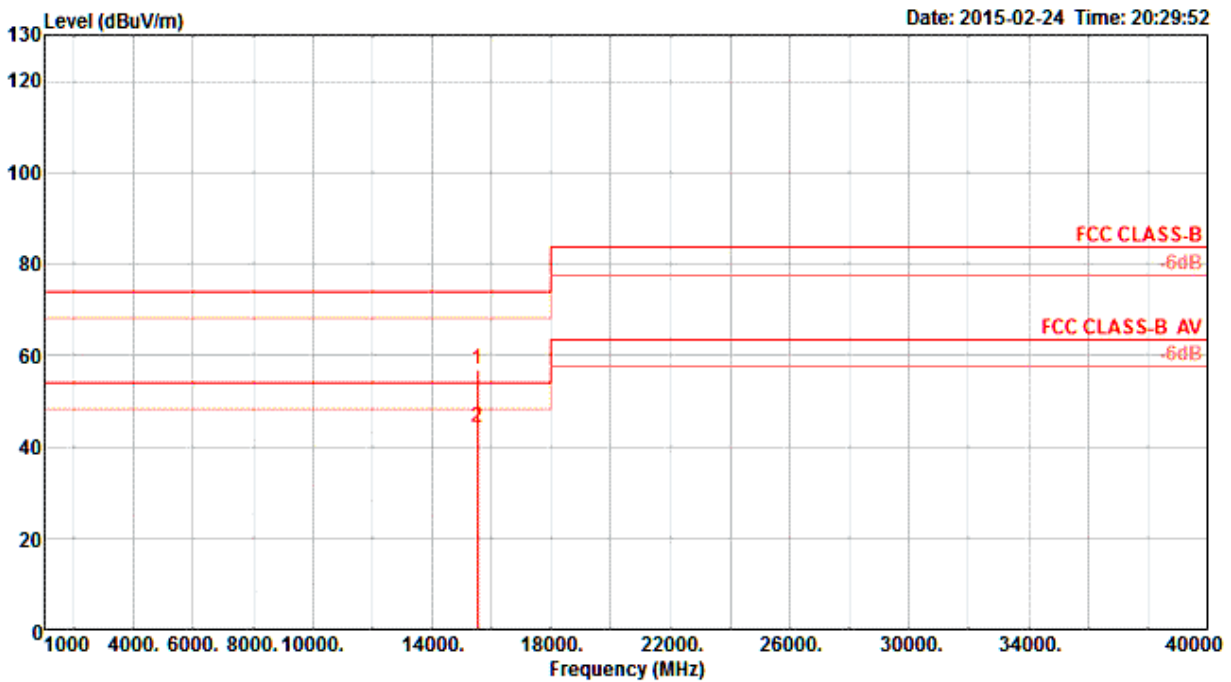

	Freq	Level	Limit	Over	Read	Cable	Antenna	Preamp	T/Pos	A/Pos	Remark	Pol/Phase
	MHz	dBuV/m	dBuV/m	dB	dBuV	dB	dB/m	dB	deg	cm		
1	15532.40	56.79	74.00	-17.21	45.28	7.56	38.67	34.72	336	177	Peak	HORIZONTAL
2	15535.48	44.20	54.00	-9.80	32.69	7.56	38.67	34.72	336	177	Average	HORIZONTAL

Note 1: The amplitude of spurious emissions which are attenuated by more than 20 dB below the permissible value has no need to be reported.
 Note 2: Emission level (dBuV/m) = 20 log Emission level (uV/m).
 Note 3: Corrected Reading: Antenna Factor + Cable Loss + Read Level - Preamp Factor = Level.
 Note 4: Measurement receive antenna polarization: H (Horizontal), V (Vertical)

Unwanted emissions in the restricted bands (Above 1GHz)			
Operating Mode	IEEE 802.11a 6Mbps / CH36 / Ant. 1		
Temperature	26°C	Humidity	68%
Test Engineer	Brian Sun	Polarization	V

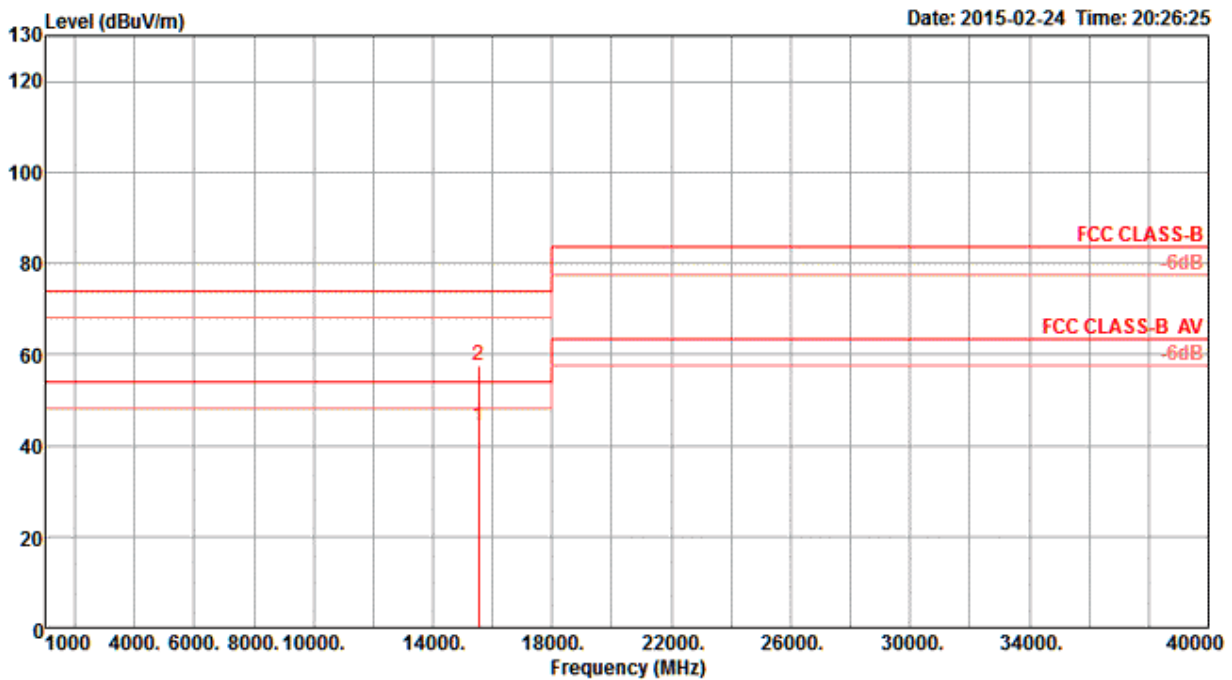

	Freq	Level	Limit	Over	Read	Cable	Antenna	Preamp	T/Pos	A/Pos	Remark	Pol/Phase
	MHz	dBuV/m	dBuV/m	dB	dBuV	dB	dB/m	dB	deg	cm		
1	15534.48	44.19	54.00	-9.81	32.68	7.56	38.67	34.72	37	191	Average	VERTICAL
2	15536.96	57.40	74.00	-16.60	45.89	7.56	38.67	34.72	37	191	Peak	VERTICAL

Note 1: The amplitude of spurious emissions which are attenuated by more than 20 dB below the permissible value has no need to be reported.

Note 2: Emission level (dBuV/m) = 20 log Emission level (uV/m).

Note 3: Corrected Reading: Antenna Factor + Cable Loss + Read Level - Preamp Factor = Level.

Note 4: Measurement receive antenna polarization: H (Horizontal), V (Vertical)

Unwanted emissions in the restricted bands (Above 1GHz)			
Operating Mode	IEEE 802.11a 6Mbps / CH40 / Ant. 1		
Temperature	26°C	Humidity	68%
Test Engineer	Brian Sun	Polarization	H

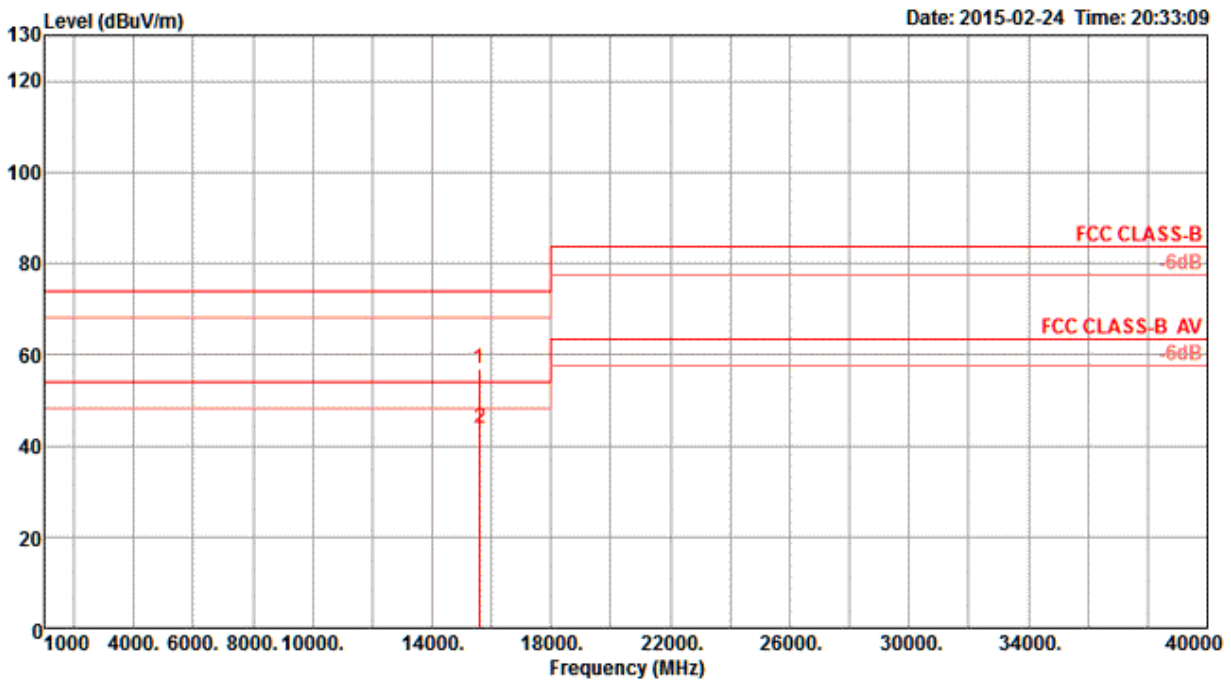

Note 1: The amplitude of spurious emissions which are attenuated by more than 20 dB below the permissible value has no need to be reported.
 Note 2: Emission level (dBuV/m) = 20 log Emission level (uV/m).
 Note 3: Corrected Reading: Antenna Factor + Cable Loss + Read Level - Preamp Factor = Level.
 Note 4: Measurement receive antenna polarization: H (Horizontal), V (Vertical)

Unwanted emissions in the restricted bands (Above 1GHz)			
Operating Mode	IEEE 802.11a 6Mbps / CH40 / Ant. 1		
Temperature	26°C	Humidity	68%
Test Engineer	Brian Sun	Polarization	V

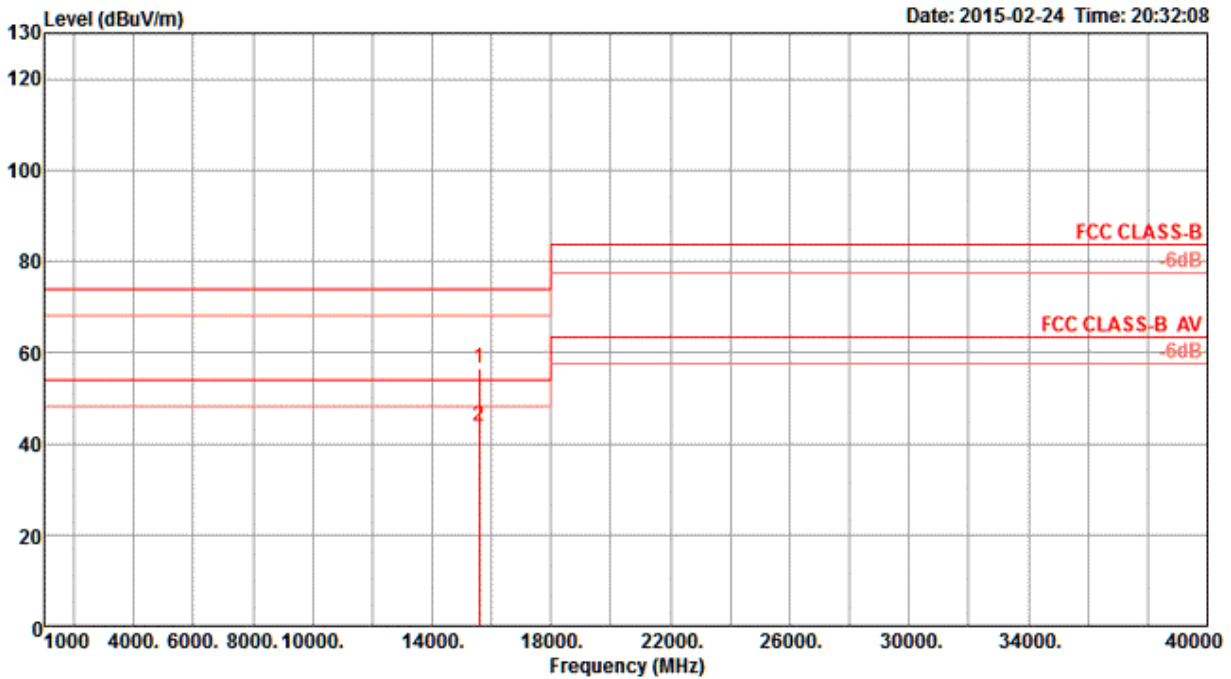

	Freq	Level	Limit	Over	Read	Cable	Antenna	Preamp	T/Pos	A/Pos	Remark	Pol/Phase
	MHz	dBuV/m	dBuV/m	dB	dBuV	dB	dB/m	dB	deg	cm		
1	15598.80	56.40	74.00	-17.60	44.99	7.58	38.62	34.79	11	146	Peak	VERTICAL
2	15599.14	43.94	54.00	-10.06	32.53	7.58	38.62	34.79	11	146	Average	VERTICAL

Note 1: The amplitude of spurious emissions which are attenuated by more than 20 dB below the permissible value has no need to be reported.
 Note 2: Emission level (dBuV/m) = 20 log Emission level (uV/m).
 Note 3: Corrected Reading: Antenna Factor + Cable Loss + Read Level - Preamp Factor = Level.
 Note 4: Measurement receive antenna polarization: H (Horizontal), V (Vertical)

Unwanted emissions in the restricted bands (Above 1GHz)			
Operating Mode	IEEE 802.11a 6Mbps / CH48 / Ant. 1		
Temperature	26°C	Humidity	68%
Test Engineer	Brian Sun	Polarization	H

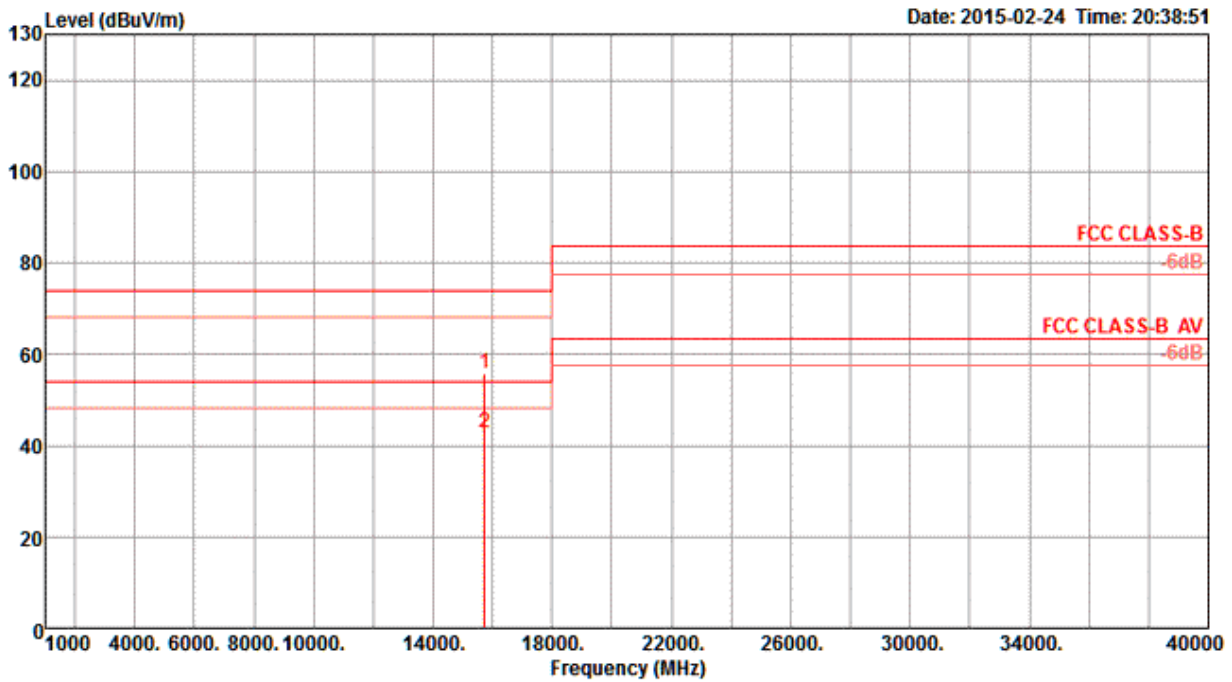

	Freq	Level	Limit	Over	Read	Cable	Antenna	Preamp	T/Pos	A/Pos	Remark	Pol/Phase
	MHz	dBuV/m	dBuV/m	dB	dBuV	dB	dB/m	dB	deg	cm		
1	15716.32	55.73	74.00	-18.27	44.47	7.62	38.52	34.88	216	173	Peak	HORIZONTAL
2	15719.08	42.83	54.00	-11.17	31.57	7.62	38.52	34.88	216	173	Average	HORIZONTAL

Note 1: The amplitude of spurious emissions which are attenuated by more than 20 dB below the permissible value has no need to be reported.
 Note 2: Emission level (dBuV/m) = 20 log Emission level (uV/m).
 Note 3: Corrected Reading: Antenna Factor + Cable Loss + Read Level - Preamp Factor = Level.
 Note 4: Measurement receive antenna polarization: H (Horizontal), V (Vertical)

Unwanted emissions in the restricted bands (Above 1GHz)			
Operating Mode	IEEE 802.11a 6Mbps / CH48 / Ant. 1		
Temperature	26°C	Humidity	68%
Test Engineer	Brian Sun	Polarization	V

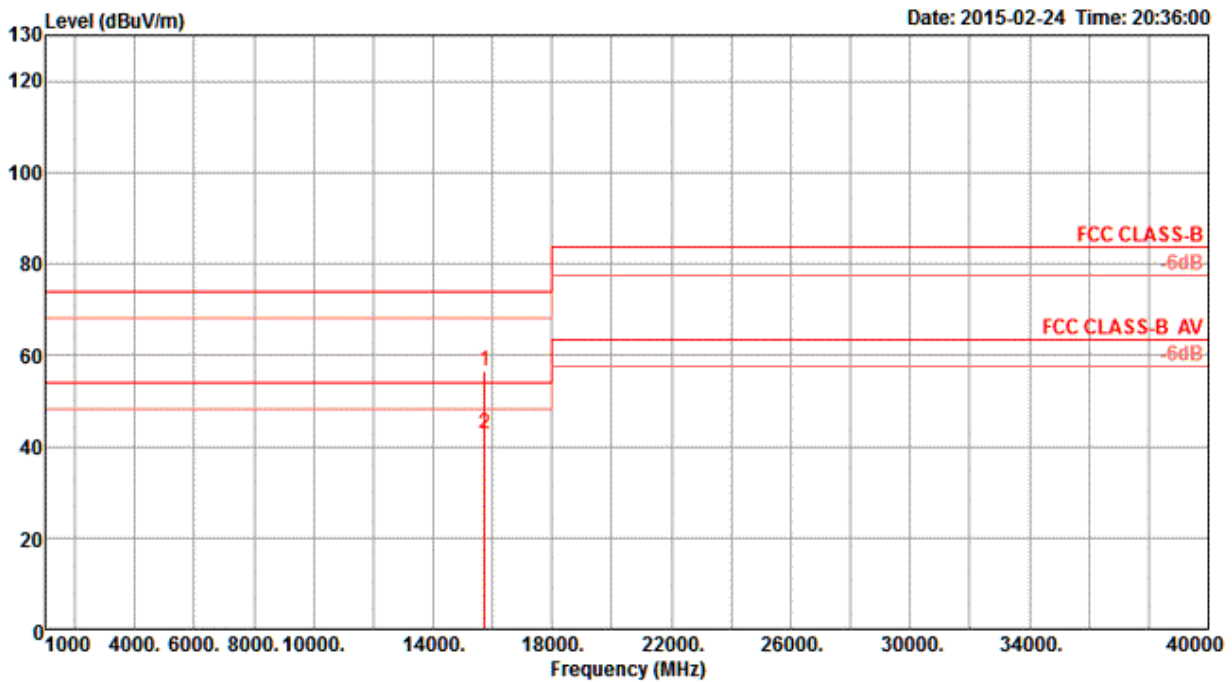

Note 1: The amplitude of spurious emissions which are attenuated by more than 20 dB below the permissible value has no need to be reported.
 Note 2: Emission level (dBuV/m) = 20 log Emission level (uV/m).
 Note 3: Corrected Reading: Antenna Factor + Cable Loss + Read Level - Preamp Factor = Level.
 Note 4: Measurement receive antenna polarization: H (Horizontal), V (Vertical)

Unwanted emissions in the restricted bands (Above 1GHz)			
Operating Mode	IEEE 802.11a 6Mbps / CH149 / Ant. 1		
Temperature	26°C	Humidity	68%
Test Engineer	Brian Sun	Polarization	H

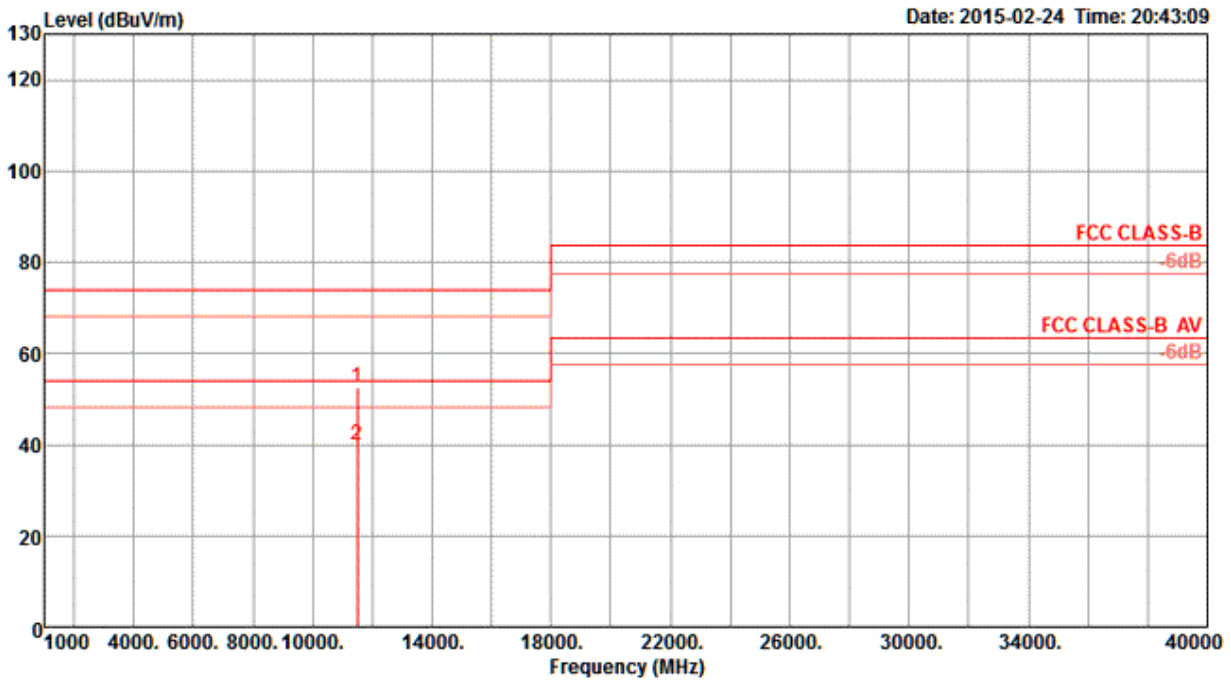

	Freq	Level	Limit	Over	Read	Cable	Antenna	Preamp	T/Pos	A/Pos	Remark	Pol/Phase
	MHz	dBuV/m	dBuV/m	dB	dBuV	dB	dB/m	dB	deg	cm		
1	11483.68	52.42	74.00	-21.58	42.25	6.53	38.30	34.66	161	131	Peak	HORIZONTAL
2	11490.60	39.67	54.00	-14.33	29.50	6.53	38.30	34.66	161	131	Average	HORIZONTAL

Note 1: The amplitude of spurious emissions which are attenuated by more than 20 dB below the permissible value has no need to be reported.
 Note 2: Emission level (dBuV/m) = 20 log Emission level (uV/m).
 Note 3: Corrected Reading: Antenna Factor + Cable Loss + Read Level - Preamp Factor = Level.
 Note 4: Measurement receive antenna polarization: H (Horizontal), V (Vertical)

Unwanted emissions in the restricted bands (Above 1GHz)			
Operating Mode	IEEE 802.11a 6Mbps / CH149 / Ant. 1		
Temperature	26°C	Humidity	68%
Test Engineer	Brian Sun	Polarization	V

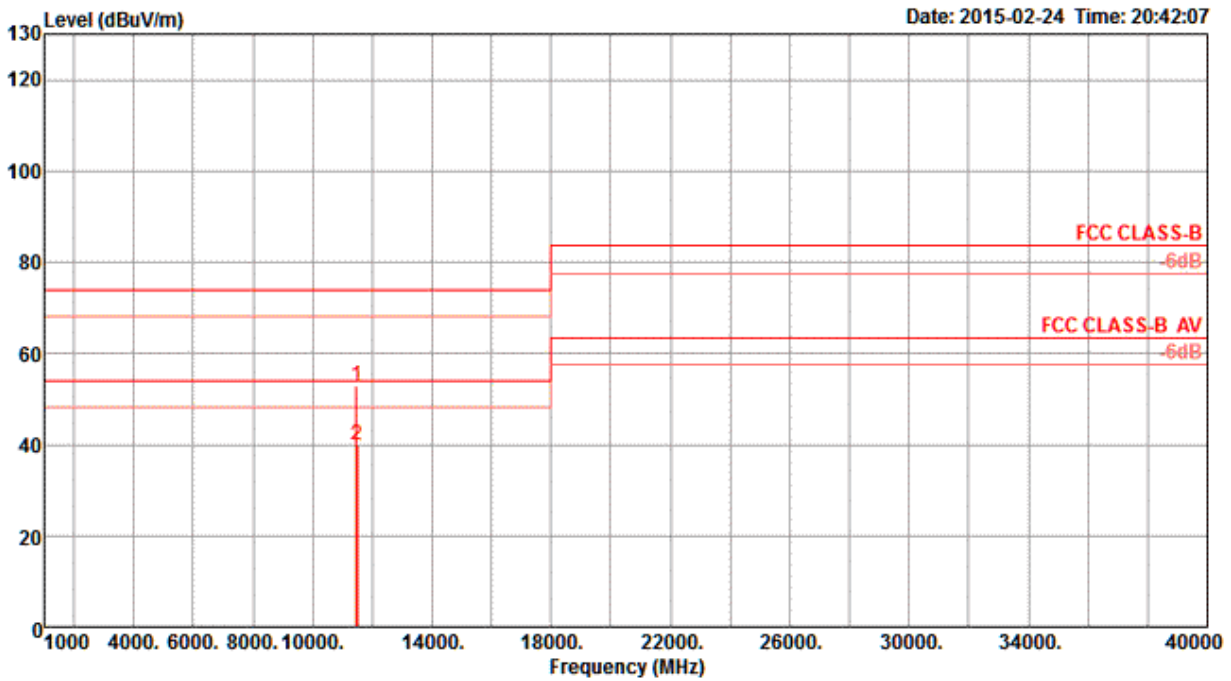

	Freq	Level	Limit	Over	Read	Cable	Antenna	Preamp	T/Pos	A/Pos	Remark	Pol/Phase
	MHz	dBuV/m	dBuV/m	dB	dBuV	dB	dB/m	dB	deg	cm		
1	11480.04	52.84	74.00	-21.16	42.67	6.53	38.30	34.66	132	182	Peak	VERTICAL
2	11491.72	39.77	54.00	-14.23	29.60	6.53	38.30	34.66	132	182	Average	VERTICAL

Note 1: The amplitude of spurious emissions which are attenuated by more than 20 dB below the permissible value has no need to be reported.
 Note 2: Emission level (dBuV/m) = 20 log Emission level (uV/m).
 Note 3: Corrected Reading: Antenna Factor + Cable Loss + Read Level - Preamp Factor = Level.
 Note 4: Measurement receive antenna polarization: H (Horizontal), V (Vertical)

Unwanted emissions in the restricted bands (Above 1GHz)			
Operating Mode	IEEE 802.11a 6Mbps / CH157 / Ant. 1		
Temperature	26°C	Humidity	68%
Test Engineer	Brian Sun	Polarization	H

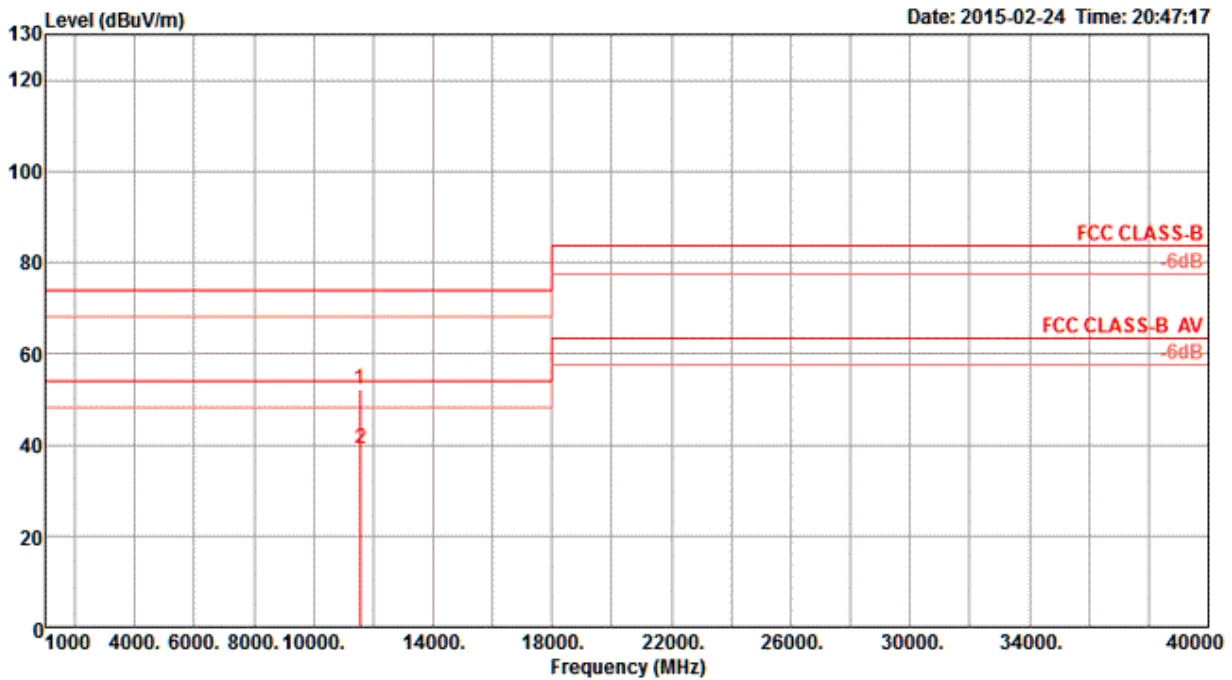

	Freq	Level	Limit	Over	Read	Cable	Antenna	Preamp	T/Pos	A/Pos	Remark	Pol/Phase
	MHz	dBuV/m	dBuV/m	dB	dBuV	dB	dB/m	dB	deg	cm		
1	11561.36	52.17	74.00	-21.83	41.98	6.55	38.32	34.68	221	154	Peak	HORIZONTAL
2	11577.52	39.29	54.00	-14.71	29.10	6.55	38.33	34.69	221	154	Average	HORIZONTAL

Note 1: The amplitude of spurious emissions which are attenuated by more than 20 dB below the permissible value has no need to be reported.
 Note 2: Emission level (dBuV/m) = 20 log Emission level (uV/m).
 Note 3: Corrected Reading: Antenna Factor + Cable Loss + Read Level - Preamp Factor = Level.
 Note 4: Measurement receive antenna polarization: H (Horizontal), V (Vertical)

Unwanted emissions in the restricted bands (Above 1GHz)			
Operating Mode	IEEE 802.11a 6Mbps / CH157 / Ant. 1		
Temperature	26°C	Humidity	68%
Test Engineer	Brian Sun	Polarization	V

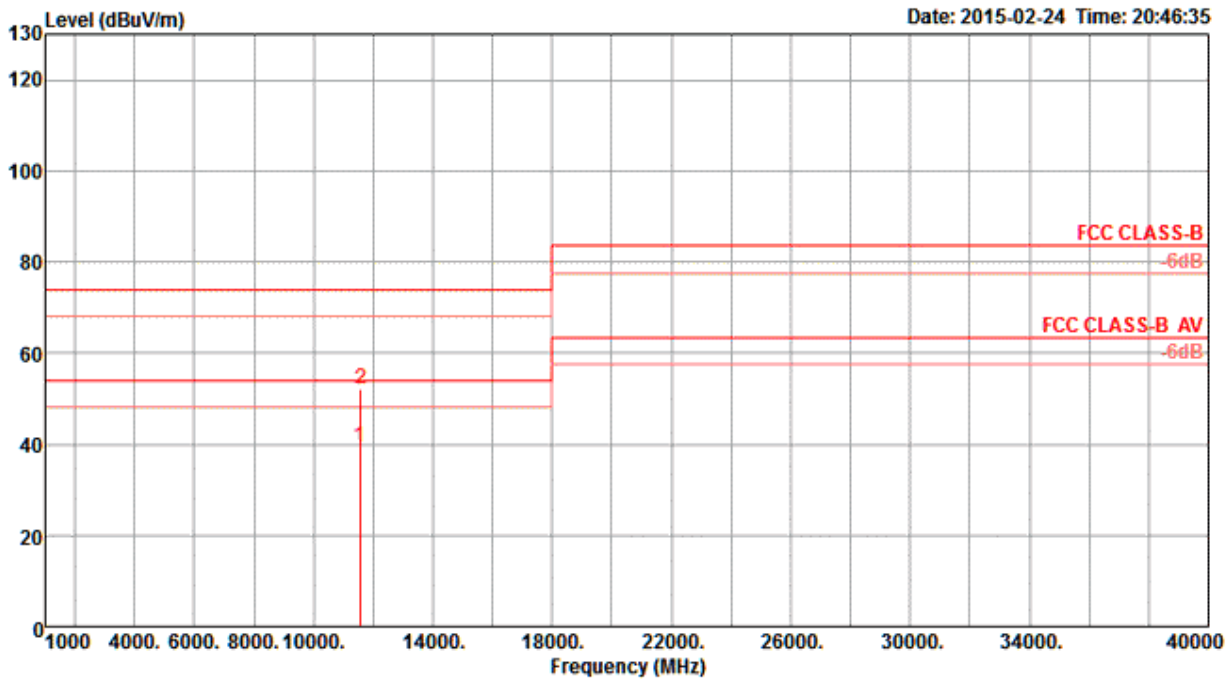

	Freq	Level	Limit	Over	Read	Cable	Antenna	Preamp	T/Pos	A/Pos	Remark	Pol/Phase
	MHz	dBuV/m	dBuV/m	dB	dBuV	dB	dB/m	dB	deg	cm		
1	11562.88	39.37	54.00	-14.63	29.18	6.55	38.32	34.68	278	176	Average	VERTICAL
2	11575.80	52.21	74.00	-21.79	42.02	6.55	38.33	34.69	278	176	Peak	VERTICAL

Note 1: The amplitude of spurious emissions which are attenuated by more than 20 dB below the permissible value has no need to be reported.

Note 2: Emission level (dBuV/m) = 20 log Emission level (uV/m).

Note 3: Corrected Reading: Antenna Factor + Cable Loss + Read Level - Preamp Factor = Level.

Note 4: Measurement receive antenna polarization: H (Horizontal), V (Vertical)

Unwanted emissions in the restricted bands (Above 1GHz)			
Operating Mode	IEEE 802.11a 6Mbps / CH165 / Ant. 1		
Temperature	26°C	Humidity	68%
Test Engineer	Brian Sun	Polarization	H

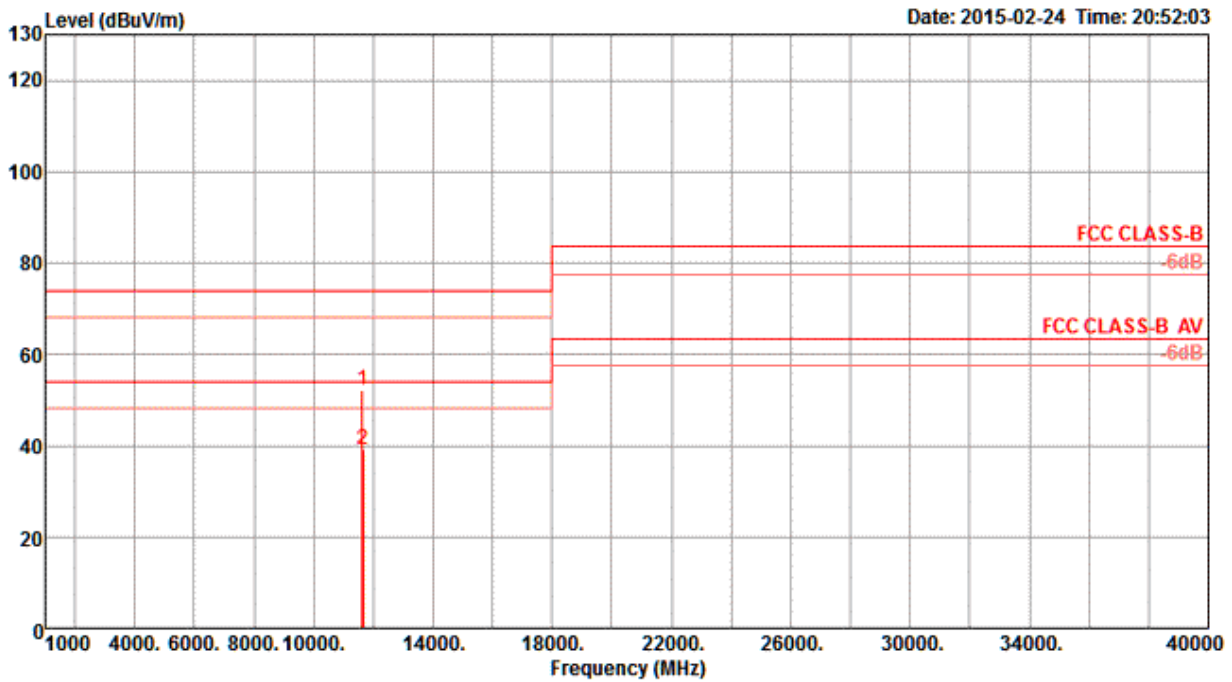

	Freq	Level	Limit	Over	Read	Cable	Antenna	Preamp	T/Pos	A/Pos	Remark	Pol/Phase
	MHz	dBuV/m	dBuV/m	dB	dBuV	dB	dB/m	dB	deg	cm		
1	11640.44	52.13	74.00	-21.87	41.92	6.56	38.36	34.71	246	135	Peak	HORIZONTAL
2	11659.88	39.18	54.00	-14.82	28.98	6.56	38.36	34.72	246	135	Average	HORIZONTAL

Note 1: The amplitude of spurious emissions which are attenuated by more than 20 dB below the permissible value has no need to be reported.
 Note 2: Emission level (dBuV/m) = 20 log Emission level (uV/m).
 Note 3: Corrected Reading: Antenna Factor + Cable Loss + Read Level - Preamp Factor = Level.
 Note 4: Measurement receive antenna polarization: H (Horizontal), V (Vertical)