

FCC RADIO TEST REPORT

according to

47 CFR FCC Part 15 Subpart C § 15.247

Model Name : Cable Modem
Model No. : TC8717C
Filing Type : New Application
FCC ID : G95-TC8717C
Trade Name : technicolor
Applicant : Technicolor USA, Inc
101 West 103rd Street Indianapolis, IN 46290
United States

Statement

Test result included is only for the IEEE 802.11n, IEEE 802.11b/g part and IEEE 802.11a/ac (5725 ~ 5850MHz) of the product.

The test result in this report refers exclusively to the presented test model / sample.

Without written approval of SPORTON International Inc., the test report shall not be reproduced except in full.

The measurements and test results shown in this test report were made in accordance with the procedures and found in compliance with the limit given in **ANSI C63.10-2009, 47 CFR FCC Part 15 Subpart C,**

KDB 558074 D01 v03r01, KDB 662911 D01 v02r01 and KDB644545 D01v01r02.

The test equipment used to perform the test is calibrated and traceable to NML/ROC.



SPORTON International Inc.

No. 52, Hwa Ya 1st Rd., Kwei-Shan Hsiang, Tao Yuan Hsien, Taiwan, R.O.C.

Table of Contents

1. SUMMARY OF THE TEST RESULT 2

- 1.1. Summary of the 2.4G Band test result 2
- 1.2. Summary of the 5G Band 4 (5725~5850MHz) test result 2
- 1.3. Information provided by the manufacturer..... 3
- 1.4. Cabling attached to the equipment..... 3
- 1.5. Cabling Attached to the Equipment..... 3
- 1.6. Panel Drawing 4

2. GENERAL INFORMATION..... 5

- 2.1. Product Details 5
- 2.2. Accessories 6
- 2.3. Table for Filed Antenna 7
- 2.4. Transmit Operating Modes 12
- 2.5. Table for Carrier Frequencies 13
- 2.6. Table for Test Modes 14
- 2.7. Table for Testing Locations 19
- 2.8. Table for Supporting Units..... 19
- 2.9. Table for Parameters of Test Software Setting 20
- 2.10. Test Configuration 25

3. THE 2.4G BAND TEST RESULT..... 28

- 3.1. AC Power Line Conducted Emissions Measurement..... 28
- 3.2. Maximum Conducted Output Power Measurement 32
- 3.3. Power Spectral Density Measurement 39
- 3.4. 6dB Spectrum Bandwidth Measurement..... 61
- 3.5. Radiated Emissions Measurement..... 104
- 3.6. Band Edge and Fundamental Emissions Measurement 171

4. THE 5G BAND 4 (5725~5850MHZ) TEST RESULT 274

- 4.1. AC Power Line Conducted Emissions Measurement..... 274
- 4.2. Maximum Conducted Output Power Measurement 278
- 4.3. Power Spectral Density Measurement 289
- 4.4. 6dB Spectrum Bandwidth Measurement..... 317
- 4.5. Radiated Emissions Measurement..... 376
- 4.6. Band Edge and Fundamental Emissions Measurement 455
- 4.7. Antenna Requirements..... 510

5. LIST OF MEASURING EQUIPMENTS 511

6. MEASUREMENT UNCERTAINTY 513

APPENDIX A. TEST PHOTO A1 ~ A5

APPENDIX B. MAXIMUM PERMISSIBLE EXPOSURE..... B1 ~ B35

APPENDIX C. PHOTOGRAPHS OF EUT C1 ~ C22

History of This Test Report

REPORT NO.	VERSION	DESCRIPTION	ISSUED DATE
FR422438AA	Rev.01	Initial issue of report	Mar. 14, 2014

CERTIFICATE OF COMPLIANCE

according to

47 CFR FCC Part 15 Subpart C § 15.247

Model Name : Cable Modem

Model No. : TC8717C

Trade Name : technicolor

Applicant : Technicolor USA, Inc
101 West 103rd Street Indianapolis, IN 46290 United States

Sporton International as requested by the applicant to evaluate the EMC performance of the product sample received on Jan. 13, 2014 would like to declare that the tested sample has been evaluated and found to be in compliance with the tested rule parts. The data recorded as well as the test configuration specified is true and accurate for showing the sample's EMC nature.



Sam Chen

SPORTON International Inc.

No. 52, Hwa Ya 1st Rd., Kwei-Shan Hsiang, Tao Yuan Hsien, Taiwan, R.O.C.

1. SUMMARY OF THE TEST RESULT

1.1. Summary of the 2.4G Band test result

Applied Standard: 47 CFR FCC Part 15 Subpart C				
Part	Rule Section	Description of Test	Result	Under Limit
3.1	15.207	AC Power Line Conducted Emissions	Complies	8.04 dB
3.2	15.247(b)(3)	Conducted Output Power	Complies	0.74 dB
3.3	15.247(e)	Power Spectral Density	Complies	5.56 dB
3.4	15.247(a)(2)	6dB Spectrum Bandwidth	Complies	-
3.5	15.247(d)	Radiated Emissions	Complies	0.09 dB
3.6	15.247(d)	Band Edge Emissions	Complies	0.01 dB
4.7	15.203	Antenna Requirements	Complies	-

1.2. Summary of the 5G Band 4 (5725~5850MHz) test result

Applied Standard: 47 CFR FCC Part 15 Subpart C				
Part	Rule Section	Description of Test	Result	Under Limit
4.1	15.207	AC Power Line Conducted Emissions	Complies	12.99 dB
4.2	15.247(b)(3)	Conducted Output Power	Complies	1.21 dB
4.3	15.247(e)	Power Spectral Density	Complies	9.02 dB
4.4	15.247(a)(2)	6dB Spectrum Bandwidth	Complies	-
4.5	15.247(d)	Radiated Emissions	Complies	0.90 dB
4.6	15.247(d)	Band Edge Emissions	Complies	-
4.7	15.203	Antenna Requirements	Complies	-

1.3. Information provided by the manufacturer

Model Name: Cable Modem

Model No.: TC8717C

Trade Name: Technicolor

Power Supply: 1. Internal AC-DC power pack, 12Vdc, 3.5A, Manufacturer: AcBel, Model: JSSTD003-AD0G2
 2. Battery, Manufacturer: Getac, Model: BP-TC-8-22 / 2250S, Rating:7.2V 4300mAh

Hardware Version: LAB2

Interface Availability

Interface Model No.	Internal AC-DC power pack Input: 120V Output : 12Vdc3.5A	Battery	Cable modem: DOCSIS 3.0 Cable Modem MoCA: MoCA 2.0 D Band 1125MHz and 1525MHz	Ethernet 10/100/1000 Mbps	USB 2. 0	Line	WLAN IEEE 802.11a/b/g/n/a c(2.4GHz/5GHz 3*3)	DECT
TC8717	●	●	●	●(4 port)	●(2 port)	●(2 port)	●	●

- : Equipped
- : Not Equipped

1.4. Cabling attached to the equipment

US Standard: 47 CFR FCC Part 15 Subpart C § 15.247
 ANSI C63.10-2009
 KDB662911 D01 Multiple Transmitter Output v02r01, 10/31/2013
 KDB558074 D01 DTS Meas Guidance v03r01, 04/09/2013
 KDB644545 D01 Guidance for IEEE 802.11ac v01r02, 10/31/2013

1.5. Cabling Attached to the Equipment

Table 1- Cable and Interconnection

Interface	Cable type	Cable length delivered with the modem	“Real life” Cable length that can be attached to this type of interface	Cable length to be used for testing	Internal/ external connection
Cable & MoCA	coaxial	2 meter	> 10 meter	10 meter	External
Eth1	UTP Cat 5	2 meter	> 10 meter	10 meter	Internal
Line1/2	UTP Cat 3	2 meter	> 10 meter	1 meter flat cable	Internal
USB1/2	STP	1 meter	< 3 meter	1 meter	Internal
AC power					Internal
Battery					Internal

1.6. Panel Drawing

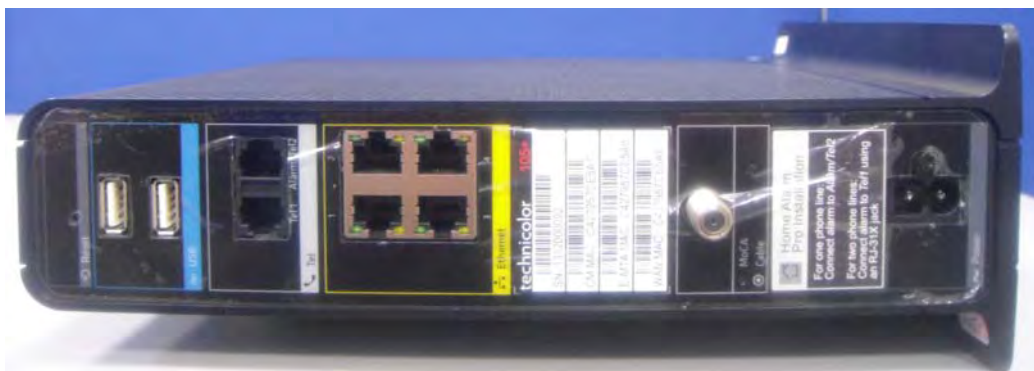

2. GENERAL INFORMATION

2.1. Product Details

Items	Description	
PRODUCT	Stand alone	
MODEL NO.	TC8717C	
FCC ID	G95-TC8717C	
Power Type	Internal power supply and Battery	
EUT Stage	<input checked="" type="checkbox"/> Product Unit	<input type="checkbox"/> Pre-Sample
Antenna Type	Please see Section 2.3	
Operating Band, EIRP power	2400~2483.5MHz	<input checked="" type="checkbox"/> IEEE 802.11b: 27.35 dBm
		<input checked="" type="checkbox"/> IEEE 802.11g: 28.05 dBm
		<input checked="" type="checkbox"/> IEEE 802.11n (20MHz): 29.26 dBm
		<input checked="" type="checkbox"/> IEEE 802.11n (40MHz): 26.27 dBm
Product Type	For IEEE 802.11b: WLAN(1/3TX, 3RX) For IEEE 802.11g: WLAN(1/3TX, 3RX) For IEEE 802.11n: WLAN(1/3TX, 3RX)	
Nominal Channel Bandwidth	20MHz / 40MHz	
Modulation	802.11b: DSSS (DBPSK, DQPSK, CCK) 802.11g: OFDM (BPSK / QPSK / 16QAM / 64QAM) 802.11n: See the below table.	
Data Rate (Mbps)	11b mode :DSSS (1/2/5.5/11) 11g mode :OFDM (6/9/12/18/24/36/48/54) 11n(20MHz) mode(MCS0~MCS23) 11n(40MHz) mode(MCS0~MCS23)	
Operating Band, EIRP power	5725~ 5850 MHz	<input checked="" type="checkbox"/> IEEE 802.11a: 26.40 dBm
		<input checked="" type="checkbox"/> For Non-Beamforming IEEE 802.11ac (20MHz): 28.79 dBm IEEE 802.11ac (40MHz): 27.84 dBm IEEE 802.11ac (80MHz): 26.08 dBm
		<input checked="" type="checkbox"/> For Beamforming IEEE 802.11ac (20MHz): 26.75 dBm IEEE 802.11ac (40MHz): 25.80 dBm IEEE 802.11ac (80MHz): 26.12 dBm

Product Type	For IEEE 802.11a: WLAN(1/3TX, 3RX) For IEEE 802.11n: WLAN(1/3TX, 3RX) For IEEE 802.11ac: WLAN (1/3TX, 3RX)		
Nominal Channel Bandwidth	20MHz / 40MHz / 80MHz		
Modulation	802.11a: OFDM (BPSK / QPSK / 16QAM / 64QAM) 802.11n: (BPSK / QPSK / 16QAM / 64QAM)See the below table. 802.11ac:(BPSK / QPSK / 16QAM / 64QAM/ 256QAM)See the below table		
Data Rate (Mbps)	11a mode :OFDM (6/9/12/18/24/36/48/54) 11n(20MHz) mode(MCS0~MCS23) 11n(40MHz) mode(MCS0~MCS23) 11ac(20MHz) mode (MCS0~MCS9 for NSS1~NSS3) 11ac(40MHz) mode (MCS0~MCS9 for NSS1~NSS3) 11ac(80MHz) mode (MCS0~MCS9 for NSS1~NSS3)		
Beamforming Function	<input checked="" type="checkbox"/>	With Beamforming for IEEE 802.11n/ac	<input type="checkbox"/> Without Beamforming
I/O Ports	LAN Port x 4 USB Host Port x 2 LINE Port x 2 Cable + MoCA Port x 1(Coaxial type)		
Software Version	5.5.10mp1		
Associated Devices	single-range internal AC-DC power pack		

2.2. Accessories

1. AC Power Cord*1, Unshielded 1.8m

2.3. Table for Filed Antenna

For 2400~2483.5MHz

Ant.	Brand	Model Name	Antenna Type	Connector
1	-	-	Printed Antenna	N/A
2	-	-	Printed Antenna	N/A
3	-	-	Printed Antenna	N/A

For 5725~5850MHz

Ant.	Brand	Model Name	Antenna Type	Connector
1	WHAYU	C107-511031-A	PIFA Antenna	I-PEX
2	-	-	Printed Antenna	N/A
3	WHAYU	C107-511033-A	PIFA Antenna	I-PEX

Antenna & Bandwidth for 2400~2483.5MHz

Antenna	1st (TX)		2nd (TX)		3rd (TX)	
	20 MHz	40 MHz	20 MHz	40 MHz	20 MHz	40 MHz
802.11b	V	X	X	X	V	X
802.11g	V	X	X	X	V	X
802.11n	V	V	X	X	V	V

Antenna & Bandwidth for 5725~5850MHz

Antenna	1st (TX)			2nd (TX)			3rd (TX)		
	20 MHz	40 MHz	80 MHz	20 MHz	40 MHz	80 MHz	20 MHz	40 MHz	80MHz
802.11a	V	X	X	X	X	X	V	X	X
802.11n	V	V	X	X	X	X	V	V	X
802.11ac	V	V	V	X	X	X	V	V	V

For 2400~2483.5MHz

Frequency	Antenna Gain (dBi)					
	Ant. 1 (WJ1)		Ant. 2 (WJ2)		Ant. 3 (WJ3)	
	20 MHz	40 MHz	20 MHz	40 MHz	20 MHz	40 MHz
2412MHz	3.61	-	4.3	-	5.34	-
2422MHz	-	3.57	-	4.13	-	5.07
2437MHz	3.51	3.51	3.87	3.87	4.67	4.67
2452MHz	-	3.66	-	3.77	-	4.46
2462MHz	3.76	-	3.74	-	4.35	-

Frequency	Directional Gain (dBi)					
	1 Stream 3TX Ant. 1 + 2 + 3		2 Stream 3TX Ant. 1 + 2 + 3		3 Stream 3TX Ant. 1 + 2 + 3	
	20 MHz	40 MHz	20 MHz	40 MHz	20 MHz	40 MHz
2412MHz	6.06	-	5.06	-	1.88	-
2422MHz	-	5.79	-	4.81	-	1.71
2437MHz	5.44	5.44	4.46	4.46	1.41	1.41
2452MHz	-	5.47	-	4.5	-	1.46
2462MHz	5.62	-	4.63	-	1.52	-

For 5725~5850MHz

Frequency	Antenna Gain (dBi)								
	Ant. 1 (WJ1)			Ant. 2 (WJ2)			Ant. 3 (WJ3)		
	20 MHz	40 MHz	80 MHz	20 MHz	40 MHz	80 MHz	20 MHz	40 MHz	80 MHz
5745MHz	5.65	-	-	4.38	-	-	5.53	-	-
5755MHz	-	5.79	-	-	5.06	-	-	5.4	-
5775MHz	-	-	5.19	-	-	4.42	-	-	5.09
5785MHz	4.93	-	-	3.78	-	-	4.7	-	-
5795MHz	-	5.12	-	-	3.92	-	-	5.2	-
5825MHz	4.18	-	-	3.69	-	-	5.03	-	-

Frequency	Directional Gain (dBi) for Beamforming and CDD mode								
	1 Stream 3TX Ant. 1 + 2 + 3			2 Stream 3TX Ant. 1 + 2 + 3			3 Stream 3TX Ant. 1 + 2 + 3		
	20 MHz	40 MHz	80 MHz	20 MHz	40 MHz	80 MHz	20 MHz	40 MHz	80 MHz
5745MHz	7.25	-	-	6.24	-	-	3.32	-	-
5755MHz	-	7.68	-	-	6.53	-	-	3.62	-
5775MHz	-	-	7.28	-	-	6.04	-	-	3.16
5785MHz	6.8	-	-	5.54	-	-	2.67	-	-
5795MHz	-	7.07	-	-	5.79	-	-	2.95	-
5825MHz	6.68	-	-	5.3	-	-	2.46	-	-

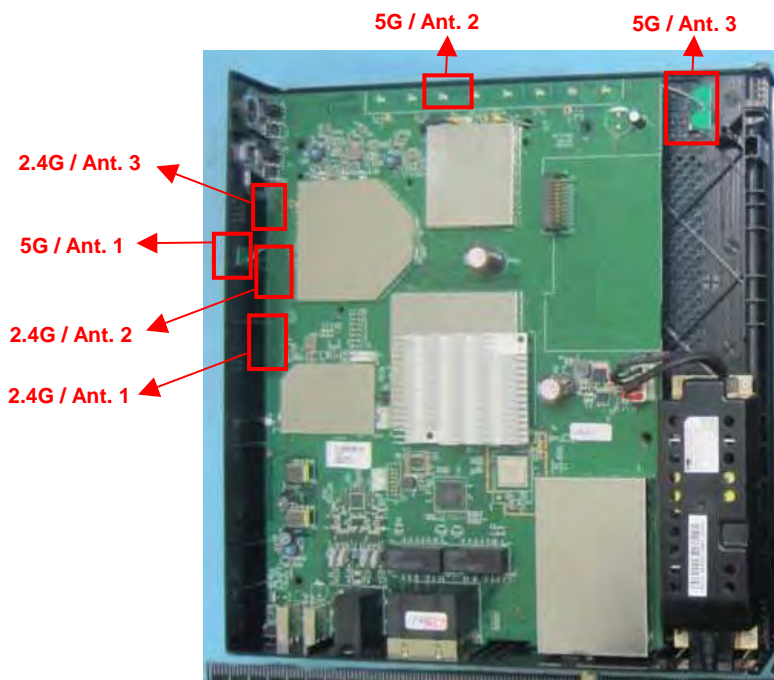

IEEE 802.11n Data Rate spec

Standard	INDEX	Data Rate (Mbps)		Standard	INDEX	Data Rate (Mbps)	
		LGI (800ns)	SIGI (400ns)			LGI (800ns)	SIGI (400ns)
11n 20MHz 1 stream	MCS0	6.5	7.2	11n 40MHz 1 stream	MCS0	13.5	15
	MCS1	13	14.4		MCS1	27	30
	MCS2	19.5	21.7		MCS2	40.5	45
	MCS3	26	28.9		MCS3	54	60
	MCS4	39	43.3		MCS4	81	90
	MCS5	52	57.8		MCS5	108	120
	MCS6	58.5	65		MCS6	121.5	135
	MCS7	65	72.2	MCS7	135	150	
11n 20MHz 2 stream	MCS8	13	14.4	11n 40MHz 2 stream	MCS8	27	30
	MCS9	26	28.9		MCS9	54	60
	MCS10	39	43.3		MCS10	81	90
	MCS11	52	57.8		MCS11	108	120
	MCS12	78	86.7		MCS12	162	180
	MCS13	104	115.6		MCS13	216	240
	MCS14	117	130		MCS14	243	270
	MCS15	130	144.4	MCS15	270	300	
11n 20MHz 3 stream	MCS16	19.5	21.7	11n 40MHz 3 stream	MCS16	40.5	45
	MCS17	39	43.3		MCS17	81	90
	MCS18	58.5	65		MCS18	121.5	135
	MCS19	78	86.7		MCS19	162	180
	MCS20	117	130		MCS20	243	270
	MCS21	156	173.3		MCS21	324	360
	MCS22	175.5	195		MCS22	364.5	405
	MCS23	195	216.7	MCS23	405	450	

IEEE 802.11ac Data Rate spec

Standard	INDEX	Data Rate (Mbps)		Standard	INDEX	Data Rate (Mbps)		Standard	INDEX	Data Rate (Mbps)	
		LGI (800ns)	Sgi (400ns)			LGI (800ns)	Sgi (400ns)			LGI (800ns)	Sgi (400ns)
11ac 20MHz 1 stream	MCS0	6.5	7.2	11ac 40MHz 1 stream	MCS0	13.5	15	11ac 80MHz 1 stream	MCS0	29.3	32.5
	MCS1	13	14.4		MCS1	27	30		MCS1	58.5	65.0
	MCS2	19.5	21.7		MCS2	40.5	45		MCS2	87.8	97.5
	MCS3	26	28.9		MCS3	54	60		MCS3	117.0	130.0
	MCS4	39	43.3		MCS4	81	90		MCS4	175.5	195.0
	MCS5	52	57.8		MCS5	108	120		MCS5	234.0	260.0
	MCS6	58.5	65		MCS6	121.5	135		MCS6	263.3	292.5
	MCS7	65	72.2		MCS7	135	150		MCS7	292.5	325.0
	MCS8	78	86.7		MCS8	162.0	180.0		MCS8	351.0	390.0
	MCS9	Note	Note		MCS9	180.0	200.0		MCS9	390.0	433.3

NOTE: MCS 9 is invalid due to mod(NCBPS/NES, DR) not being equal to 0.

11ac 20MHz 2 stream	MCS0	13.0	14.4	11ac 40MHz 2 stream	MCS0	27.0	30.0	11ac 80MHz 2 stream	MCS0	58.5	65.0
	MCS1	26.0	28.9		MCS1	54.0	60.0		MCS1	117.0	130.0
	MCS2	39.0	43.3		MCS2	81.0	90.0		MCS2	175.5	195.0
	MCS3	52.0	57.8		MCS3	108.-0	120.0		MCS3	234.0	260.0
	MCS4	78.0	86.7		MCS4	162.0	180.0		MCS4	351.0	390.0
	MCS5	104.0	115.6		MCS5	216.0	240.0		MCS5	468.0	520.0
	MCS6	117.0	130.0		MCS6	243.0	270.0		MCS6	526.5	585.0
	MCS7	130.0	144.4		MCS7	270.0	300.0		MCS7	585.0	650.0
	MCS8	156.0	173.3		MCS8	324.0	360.0		MCS8	702.0	780.0
	MCS9	13.0	14.4		MCS9	360.0	400.0		MCS9	780.0	866.7

11ac 20MHz 3 stream	MCS0	19.5	21.7	11ac 40MHz 3 stream	MCS0	40.5	45	11ac 80MHz 3 stream	MCS0	87.8	97.5
	MCS1	39	43.3		MCS1	81	90		MCS1	175.5	195.0
	MCS2	58.5	65		MCS2	121.5	135		MCS2	263.3	292.5
	MCS3	78	86.7		MCS3	162	180		MCS3	351.0	190.0
	MCS4	117	130		MCS4	243	270		MCS4	526.5	585.0
	MCS5	156	173.3		MCS5	324	360		MCS5	702.0	780.0
	MCS6	175.5	195		MCS6	364.5	405		MCS6	Note	Note
	MCS7	195	216.7		MCS7	405	450		MCS7	877.5	975.0
	MCS8	234.0	260.0		MCS8	486.0	540.0		MCS8	1053.0	1170.0
	MCS9	260.0	228.9		MCS9	540.0	600.0		MCS9	1170.0	1300.0

NOTE: MCS 6 is invalid due to mod(NCBPS/NES, DR) not being equal to 0.

2.4. Transmit Operating Modes

For 2400~2483.5MHz

Transmit Operating Mode				Transmit Multiple Antennas			
<input type="checkbox"/>	Operating mode 1 (single antenna)			<input checked="" type="checkbox"/>	1TX		
<input type="checkbox"/>	Operating mode 2 (multiple antenna, no beam forming)			<input checked="" type="checkbox"/>	2TX	<input checked="" type="checkbox"/>	3TX <input type="checkbox"/> 4TX
<input type="checkbox"/>	Operating mode 3 (multiple antenna, with beam forming)			<input type="checkbox"/>	2TX	<input type="checkbox"/>	3TX <input type="checkbox"/> 4TX
<input type="checkbox"/>	802.11b	Operating mode	<input checked="" type="checkbox"/>	1TX	<input checked="" type="checkbox"/>	2TX	<input checked="" type="checkbox"/> 3TX <input type="checkbox"/> Cyclic shift
<input type="checkbox"/>	802.11g	Operating mode	<input checked="" type="checkbox"/>	1TX	<input checked="" type="checkbox"/>	2TX	<input checked="" type="checkbox"/> 3TX <input type="checkbox"/> Cyclic shift
<input type="checkbox"/>	802.11n(HT20)	Operating mode	<input checked="" type="checkbox"/>	1TX	<input checked="" type="checkbox"/>	2TX	<input checked="" type="checkbox"/> 3TX <input type="checkbox"/> Cyclic shift
<input type="checkbox"/>	802.11n(HT40)	Operating mode	<input checked="" type="checkbox"/>	1TX	<input checked="" type="checkbox"/>	2TX	<input checked="" type="checkbox"/> 3TX <input type="checkbox"/> Cyclic shift

Note1: For IEEE802.11n, MCS0~MCS7: 1TX; MCS8~MCS15: 2TX; MCS0~MCS23: 3TX

Note2: For 2 stream 2TX without test due to covered by 2 stream 3TX MCS8

For 5725~5850MHz

Transmit Operating Mode				Transmit Multiple Antennas			
<input type="checkbox"/>	Operating mode 1 (single antenna)			<input checked="" type="checkbox"/>	1TX		
<input type="checkbox"/>	Operating mode 2 (multiple antenna, no beam forming)			<input checked="" type="checkbox"/>	2TX	<input checked="" type="checkbox"/>	3TX <input type="checkbox"/> 4TX
<input type="checkbox"/>	Operating mode 3 (multiple antenna, with beam forming)			<input type="checkbox"/>	2TX	<input checked="" type="checkbox"/>	3TX <input type="checkbox"/> 4TX
<input type="checkbox"/>	802.11a	Operating mode	<input checked="" type="checkbox"/>	1TX	<input type="checkbox"/>	2TX	<input checked="" type="checkbox"/> 3TX <input type="checkbox"/> Cyclic shift
<input type="checkbox"/>	802.11n(HT20)	Operating mode	<input checked="" type="checkbox"/>	1TX	<input checked="" type="checkbox"/>	2TX	<input checked="" type="checkbox"/> 3TX <input type="checkbox"/> Cyclic shift
<input type="checkbox"/>	802.11n(HT40)	Operating mode	<input checked="" type="checkbox"/>	1TX	<input checked="" type="checkbox"/>	2TX	<input checked="" type="checkbox"/> 3TX <input type="checkbox"/> Cyclic shift
<input type="checkbox"/>	802.11ac(VHT20)	Operating mode	<input checked="" type="checkbox"/>	1TX	<input checked="" type="checkbox"/>	2TX	<input checked="" type="checkbox"/> 3TX <input type="checkbox"/> Cyclic shift
<input type="checkbox"/>	802.11ac(VHT40)	Operating mode	<input checked="" type="checkbox"/>	1TX	<input checked="" type="checkbox"/>	2TX	<input checked="" type="checkbox"/> 3TX <input type="checkbox"/> Cyclic shift

Note1: For IEEE802.11n, MCS0~MCS7: 1TX; MCS8~MCS15: 2TX; MCS0~MCS23: 3TX

Note2: For IEEE802.11ac VHT20/40/80, MCS0~MCS9: 1 Stream 3TX; MCS0~MCS9: 2 Stream 3TX;
MCS0~MCS9: 3 Stream 3TX

Note3: For 2 stream 2TX without test due to covered by 2 stream 3TX MCS0 Nss2

2.5. Table for Carrier Frequencies

Eleven channels are provided for 802.11b, 802.11g, 802.11n (20MHz):

Frequency Band	Channel No.	Frequency	Channel No.	Frequency
2400 ~ 2483.5 MHz	1	2412MHz	7	2442MHz
	2	2417MHz	8	2447MHz
	3	2422MHz	9	2452MHz
	4	2427MHz	10	2457MHz
	5	2432MHz	11	2462MHz
	6	2437MHz	-	-

Seven channels are provided for 802.11n (40MHz):

Frequency Band	Channel No.	Frequency	Channel No.	Frequency
2400 ~ 2483.5 MHz	3	2422 MHz	7	2442MHz
	4	2427MHz	8	2447MHz
	5	2432MHz	9	2452MHz
	6	2437MHz	-	-

Five channels are provided for 802.11a, 802.11n, 802.11ac Band4 (20MHz):

Frequency Band	Channel No.	Frequency	Channel No.	Frequency
5725 ~ 5850 MHz	149	5745MHz	161	5805MHz
	153	5765MHz	165	5825MHz
	157	5785MHz	-	-

Two channels are provided for 802.11n, 802.11ac Band4 (40MHz):

Frequency Band	Channel No.	Frequency	Channel No.	Frequency
5725 ~ 5850 MHz	151	5755MHz	159	5795MHz

One channel is provided for 802.11ac Band4 (80MHz):

Frequency Band	Channel No.	Frequency	Channel No.	Frequency
5725 ~ 5850 MHz	155	5775MHz	-	-

2.6. Table for Test Modes

Investigation has been done on all the possible configurations for searching the worst cases.

The following table is a list of the test modes shown in this test report.

Test Items	Mode	Note	Channel	Data Rate	Antenna
AC Power Line Conducted Emissions	CTX	BPSK	-	-	1+2+3(CDD)
Maximum Average Output Power	11b	DSSS/DBPSK	1/6/11	1Mbps	1, 2, 3
				1Mbps	1+2+3(CDD)
	11g	OFDM/BPSK	1/6/11	6Mbps	1, 2, 3
				6Mbps	1+2+3(CDD)
	11n(20MHz)	OFDM/BPSK	1/6/11	MCS0	1, 2, 3
				MCS0	1+2+3(CDD)
				MCS8	1+2+3(CDD)
	11n(40MHz)	OFDM/BPSK	3/6/9	MCS16	1+2+3(SDM)
				MCS0	1, 2, 3
				MCS0	1+2+3(CDD)
				MCS8	1+2+3(CDD)
	Power Spectral Density	11b	DSSS/DBPSK	1/6/11	1Mbps
1Mbps					1+2+3(CDD)
11g		OFDM/BPSK	1/6/11	6Mbps	1
				6Mbps	1+2+3(CDD)
11n(20MHz)		OFDM/BPSK	1/6/11	MCS0	3
			1/6/11	MCS0	1+2+3(CDD)
			1/6/11	MCS8	1+2+3(CDD)
11n(40MHz)		OFDM/BPSK	3/6/9	MCS0	1
			3/6/9	MCS0	1+2+3(CDD)
			3/6/9	MCS8	1+2+3(CDD)
6dB Spectrum Bandwidth	11b	DSSS/DBPSK	1/6/11	1Mbps	1
				1Mbps	1+2+3(CDD)
	11g	OFDM/BPSK	1/6/11	6Mbps	1
				6Mbps	1+2+3(CDD)
	11n(20MHz)	OFDM/BPSK	1/6/11	MCS0	3
			1/6/11	MCS0	1+2+3(CDD)
			1/6/11	MCS8	1+2+3(CDD)
	11n(40MHz)	OFDM/BPSK	3/6/9	MCS0	1
			3/6/9	MCS0	1+2+3(CDD)
			3/6/9	MCS8	1+2+3(CDD)

Band Edge Emissions (Radiated)	11b	DSSS/DBPSK	1/6/11	1Mbps	1	
				1Mbps	1+2+3(CDD)	
	11g	OFDM/BPSK	1/6/11	6Mbps	1	
				6Mbps	1+2+3(CDD)	
	11n(20MHz)		1/6/11	MCS0	1	
			1/6/11	MCS0	1+2+3(CDD)	
			1/6/11	MCS8	1+2+3(CDD)	
			11n(40MHz)	3/6/9	MCS0	3
				3/6/9	MCS0	1+2+3(CDD)
				3/6/9	MCS8	1+2+3(CDD)
Radiated Emissions Above 1GHz (Radiated)	11b	DSSS/DBPSK	1/6/11	1Mbps	1	
				1Mbps	1+2+3(CDD)	
	11g	OFDM/BPSK	1/6/11	6Mbps	1	
				6Mbps	1+2+3(CDD)	
	11n(20MHz)		1/6/11	MCS0	1	
			1/6/11	MCS0	1+2+3(CDD)	
			1/6/11	MCS8	1+2+3(CDD)	
			11n(40MHz)	3/6/9	MCS0	3
				3/6/9	MCS0	1+2+3(CDD)
				3/6/9	MCS8	1+2+3(CDD)
Radiated Emissions Below 1GHz(Radiated)	CTX	BPSK	-	-	1+2+3(CDD)	

Note 1:11n (HT20/40) 3TX MCS16 without test due to covered by 802.11 n HT20/40 3TX MCS0, except maximum average output power

Test Items	Mode	Note	Channel	Data Rate	Antenna
AC Power Line Conducted Emissions	CTX	BPSK	-	-	1+2+3(CDD)
Maximum Average Output Power	11a	OFDM/BPSK	149/157/165	6Mbps	1, 2, 3
				6Mbps	1+2+3(CDD)
	11ac(20MHz)		149/157/165	Nss1 MCS0	1, 2, 3
				Nss1 MCS0	1+2+3(CDD)
				Nss2 MCS0	1+2+3(CDD)
				Nss3 MCS0	1+2+3(SDM)
	11ac(40MHz)		151/159	Nss1 MCS0	1, 2, 3
				Nss1 MCS0	1+2+3(CDD)
				Nss2 MCS0	1+2+3(CDD)
				Nss3 MCS0	1+2+3(SDM)
	11ac(80MHz)		155	Nss1 MCS0	1, 2, 3
				Nss1 MCS0	1+2+3(CDD)
				Nss2 MCS0	1+2+3(CDD)
				Nss3 MCS0	1+2+3(SDM)
	11ac(20MHz) Beamforming		149/157/165	Nss1 MCS0	1+2+3(CDD)
				Nss2 MCS0	1+2+3(CDD)
	11ac(40MHz) Beamforming		151/159	Nss1 MCS0	1+2+3(CDD)
				Nss2 MCS0	1+2+3(CDD)
11ac(80MHz) Beamforming	155	Nss1 MCS0	1+2+3(CDD)		
		Nss2 MCS0	1+2+3(CDD)		
Power Spectral Density	11a	OFDM/BPSK	149/157/165	6Mbps	1
				6Mbps	1+2+3(CDD)
	11ac(20MHz)		149/157/165	Nss1 MCS0	1
				Nss1 MCS0	1+2+3(CDD)
	11ac(20MHz)		149/157/165	Nss2 MCS0	1+2+3(CDD)
				Nss2 MCS0	1+2+3(CDD)
	11ac(40MHz)		151/159	Nss1 MCS0	1
				Nss1 MCS0	1+2+3(CDD)
	11ac(40MHz)		151/159	Nss2 MCS0	1+2+3(CDD)
				Nss2 MCS0	1+2+3(CDD)
	11ac(80MHz)		155	Nss1 MCS0	3
				Nss1 MCS0	1+2+3(CDD)
11ac(80MHz)	155	Nss2 MCS0	1+2+3(CDD)		
		Nss2 MCS0	1+2+3(CDD)		
11ac(20MHz) Beamforming	149/157/165	Nss1 MCS0	1+2+3(CDD)		
		Nss2 MCS0	1+2+3(CDD)		

	11ac(40MHz) Beamforming		151/159	Nss1 MCS0	1+2+3(CDD)
				Nss2 MCS0	1+2+3(CDD)
	11ac(80MHz) Beamforming		155	Nss1 MCS0	1+2+3(CDD)
				Nss2 MCS0	1+2+3(CDD)
6dB Spectrum Bandwidth	11a	OFDM/BPSK	149/157/165	6Mbps	1
				6Mbps	1+2+3(CDD)
	11ac(20MHz)		149/157/165	Nss1 MCS0	1
				Nss1 MCS0	1+2+3(CDD)
				Nss2 MCS0	1+2+3(CDD)
	11ac(40MHz)		151/159	Nss1 MCS0	1
				Nss1 MCS0	1+2+3(CDD)
				Nss2 MCS0	1+2+3(CDD)
	11ac(80MHz)		155	Nss1 MCS0	3
				Nss1 MCS0	1+2+3(CDD)
				Nss2 MCS0	1+2+3(CDD)
	11ac(20MHz) Beamforming		149/157/165	Nss1 MCS0	1+2+3(CDD)
				Nss2 MCS0	1+2+3(CDD)
	11ac(40MHz) Beamforming		151/159	Nss1 MCS0	1+2+3(CDD)
		Nss2 MCS0	1+2+3(CDD)		
11ac(80MHz) Beamforming	155	Nss1 MCS0	1+2+3(CDD)		
		Nss2 MCS0	1+2+3(CDD)		
Band Edge Emissions (Radiated)	11a	OFDM/BPSK	149/157/165	6Mbps	1
				6Mbps	1+2+3(CDD)
	11ac(20MHz)		149/157/165	Nss1 MCS0	1
				Nss1 MCS0	1+2+3(CDD)
				Nss2 MCS0	1+2+3(CDD)
	11ac(40MHz)		151/159	Nss1 MCS0	1
				Nss1 MCS0	1+2+3(CDD)
				Nss2 MCS0	1+2+3(CDD)
	11ac(80MHz)		155	Nss1 MCS0	3
				Nss1 MCS0	1+2+3(CDD)
				Nss2 MCS0	1+2+3(CDD)
	11ac(20MHz) Beamforming		149/157/165	Nss1 MCS0	1+2+3(CDD)
				Nss2 MCS0	1+2+3(CDD)
	11ac(40MHz) Beamforming		151/159	Nss1 MCS0	1+2+3(CDD)
		Nss2 MCS0	1+2+3(CDD)		

	11ac(80MHz) Beamforming		155	Nss1 MCS0	1+2+3(CDD)
				Nss2 MCS0	1+2+3(CDD)
Radiated Emissions Above 1GHz(Radiated)	11a	OFDM/BPSK	149/157/165	6Mbps	1
				6Mbps	1+2+3(CDD)
	11ac(20MHz)		149/157/165	Nss1 MCS0	1
				Nss1 MCS0	1+2+3(CDD)
				Nss2 MCS0	1+2+3(CDD)
	11ac(40MHz)		151/159	Nss1 MCS0	1
				Nss1 MCS0	1+2+3(CDD)
				Nss2 MCS0	1+2+3(CDD)
	11ac(80MHz)		155	Nss1 MCS0	3
				Nss1 MCS0	1+2+3(CDD)
				Nss2 MCS0	1+2+3(CDD)
	11ac(20MHz) Beamforming		149/157/165	Nss1 MCS0	1+2+3(CDD)
	Nss2 MCS0	1+2+3(CDD)			
11ac(40MHz) Beamforming	151/159	Nss1 MCS0	1+2+3(CDD)		
		Nss2 MCS0	1+2+3(CDD)		
11ac(80MHz) Beamforming	155	Nss1 MCS0	1+2+3(CDD)		
		Nss2 MCS0	1+2+3(CDD)		
Radiated Emissions Below 1GHz(Radiated)	CTX	BPSK	-	-	1+2+3(CDD)

Note 1:11n HT20/40 1TX/3TX without test due to covered by 802.11ac VHT20/40 1TX/3TX which are same modulation, bandwidth and frequency.

Note 2:11ac VHT20/40/80 3TX MCS0 Nss3 without test due to covered by 802.11ac VHT20/40/80 3TX MCS0 Nss1, except maximum average output power.

2.7. Table for Testing Locations

Test Site Location					
Address:	No.8, Lane 724, Bo-ai St., Jhubei City, Hsinchu County 302, Taiwan, R.O.C.				
TEL:	886-3-656-9065				
FAX:	886-3-656-9085				
Test Site No.	Site Category	Location	FCC Reg. No.	IC File No.	VCCI Reg. No
03CH01-CB	SAC	Hsin Chu	262045	IC 4086D	-
CO01-CB	Conduction	Hsin Chu	262045	IC 4086D	-
TH01-CB	OVEN Room	Hsin Chu	-	-	-

Open Area Test Site (OATS); Semi Anechoic Chamber (SAC).

2.8. Table for Supporting Units

For Test Site No: CO01-CB and TH01-CB

Support Unit	Brand	Model	FCC ID
Notebook	DELL	E6430	DoC

For Test Site No: 03CH01-CB

For Non-Beamforming

Support Unit	Brand	Model	FCC ID
Notebook	DELL	M1330	DoC

For Beamforming

Support Unit	Brand	Model	FCC ID
Notebook	DELL	M1330	DoC
WLAN ac Dongle	Netgear	A6200	PY31220200
Notebook	DELL	E6430	DoC

2.9. Table for Parameters of Test Software Setting

During testing, Channel & Power Controlling Software provided by the customer was used to control the operating channel as well as the output power level. The RF output power selection is for the setting of RF output power expected by the customer and is going to be fixed on the firmware of the final end product.

The Power Setting Parameter						
Power Level		1				
Test Software Version		MTOOL 2.0.1.0				
Worst Modulation Mode		Number of Transmit Chains (NTX)	Frequency (MHz)	Maximum Output Power (dBm)	Power Setting	Data Rate / MCS
Ant. 1	802.11b	1Stream 1TX	2412	26.09	98	1Mbps
Ant. 1	802.11b	1Stream 1TX	2437	26.12	98	1Mbps
Ant. 1	802.11b	1Stream 1TX	2462	26.08	98	1Mbps
Ant. 2	802.11b	1Stream 1TX	2412	25.88	98	1Mbps
Ant. 2	802.11b	1Stream 1TX	2437	25.87	98	1Mbps
Ant. 2	802.11b	1Stream 1TX	2462	25.92	98	1Mbps
Ant. 3	802.11b	1Stream 1TX	2412	26.01	98	1Mbps
Ant. 3	802.11b	1Stream 1TX	2437	26.02	98	1Mbps
Ant. 3	802.11b	1Stream 1TX	2462	26.11	98	1Mbps
Ant.1+2+3, CDD	802.11b	1Stream 3TX	2412	27.35	86	1Mbps
Ant.1+2+3, CDD	802.11b	1Stream 3TX	2437	27.02	86	1Mbps
Ant.1+2+3, CDD	802.11b	1Stream 3TX	2462	27.10	86	1Mbps
Ant. 1	802.11g	1Stream 1TX	2412	21.78	82	6Mbps
Ant. 1	802.11g	1Stream 1TX	2437	25.57	82	6Mbps
Ant. 1	802.11g	1Stream 1TX	2462	21.41	82	6Mbps
Ant. 2	802.11g	1Stream 1TX	2412	22.04	86	6Mbps
Ant. 2	802.11g	1Stream 1TX	2437	25.39	86	6Mbps
Ant. 2	802.11g	1Stream 1TX	2462	21.83	86	6Mbps
Ant. 3	802.11g	1Stream 1TX	2412	20.92	80	6Mbps
Ant. 3	802.11g	1Stream 1TX	2437	25.50	80	6Mbps
Ant. 3	802.11g	1Stream 1TX	2462	21.61	80	6Mbps
Ant.1+2+3, CDD	802.11g	1Stream 3TX	2412	24.46	75	1Mbps
Ant.1+2+3, CDD	802.11g	1Stream 3TX	2437	28.05	90	1Mbps
Ant.1+2+3, CDD	802.11g	1Stream 3TX	2462	24.07	73	1Mbps
Ant. 1	802.11n 20MHz	1Stream 1TX	2412	20.16	75	MCS0
Ant. 1	802.11n 20MHz	1Stream 1TX	2437	25.54	98	MCS0
Ant. 1	802.11n 20MHz	1Stream 1TX	2462	20.65	78	MCS0
Ant. 2	802.11n 20MHz	1Stream 1TX	2412	21.49	83	MCS0
Ant. 2	802.11n 20MHz	1Stream 1TX	2437	25.31	98	MCS0
Ant. 2	802.11n 20MHz	1Stream 1TX	2462	21.23	82	MCS0
Ant. 3	802.11n 20MHz	1Stream 1TX	2412	19.89	76	MCS0

Ant. 3	802.11n 20MHz	1Stream 1TX	2437	25.58	98	MCS0
Ant. 3	802.11n 20MHz	1Stream 1TX	2462	20.49	78	MCS0
Ant.1+2+3, CDD	802.11n 20MHz	1Stream 3TX	2412	23.75	72	MCS0
Ant.1+2+3, CDD	802.11n 20MHz	1Stream 3TX	2437	27.98	90	MCS0
Ant.1+2+3, CDD	802.11n 20MHz	1Stream 3TX	2462	23.84	72	MCS0
Ant.1+2+3, CDD	802.11n 20MHz	2Stream 3TX	2412	24.18	76	MCS8
Ant.1+2+3, CDD	802.11n 20MHz	2Stream 3TX	2437	29.01	94	MCS8
Ant.1+2+3, CDD	802.11n 20MHz	2Stream 3TX	2462	24.25	76	MCS8
Ant.1+2+3, SDM	802.11n 20MHz	3Stream 3TX	2412	23.35	72	MCS16
Ant.1+2+3, SDM	802.11n 20MHz	3Stream 3TX	2437	29.26	96	MCS16
Ant.1+2+3, SDM	802.11n 20MHz	3Stream 3TX	2462	23.27	72	MCS16
Ant. 1	802.11n 40MHz	1Stream 1TX	2422	19.54	70	MCS0
Ant. 1	802.11n 40MHz	1Stream 1TX	2437	22.60	82	MCS0
Ant. 1	802.11n 40MHz	1Stream 1TX	2452	19.52	70	MCS0
Ant. 2	802.11n 40MHz	1Stream 1TX	2422	19.10	71	MCS0
Ant. 2	802.11n 40MHz	1Stream 1TX	2437	22.35	84	MCS0
Ant. 2	802.11n 40MHz	1Stream 1TX	2452	19.54	72	MCS0
Ant. 3	802.11n 40MHz	1Stream 1TX	2422	19.25	70	MCS0
Ant. 3	802.11n 40MHz	1Stream 1TX	2437	22.02	81	MCS0
Ant. 3	802.11n 40MHz	1Stream 1TX	2452	18.92	68	MCS0
Ant.1+2+3, CDD	802.11n 40MHz	1Stream 3TX	2422	21.56	60	MCS0
Ant.1+2+3, CDD	802.11n 40MHz	1Stream 3TX	2437	24.97	74	MCS0
Ant.1+2+3, CDD	802.11n 40MHz	1Stream 3TX	2452	21.75	61	MCS0
Ant.1+2+3, CDD	802.11n 40MHz	2Stream 3TX	2422	22.52	66	MCS8
Ant.1+2+3, CDD	802.11n 40MHz	2Stream 3TX	2437	26.27	81	MCS8
Ant.1+2+3, CDD	802.11n 40MHz	2Stream 3TX	2452	23.12	68	MCS8
Ant.1+2+3, SDM	802.11n 40MHz	3Stream 3TX	2422	21.21	60	MCS16
Ant.1+2+3, SDM	802.11n 40MHz	3Stream 3TX	2437	24.62	74	MCS16
Ant.1+2+3, SDM	802.11n 40MHz	3Stream 3TX	2452	21.44	61	MCS16

For Non-Beamforming

The Power Setting Parameter						
Power Level		1				
Test Software Version		MTOOL 2.0.1.0				
Worst Modulation Mode		Number of Transmit Chains (NTX)	Frequency (MHz)	Maximum Output Power (dBm)	Power Setting	Data Rate / MCS
Ant. 1	802.11a	1 Stream 1TX	5745	22.27	82	6Mbps
Ant. 1	802.11a	1 Stream 1TX	5785	22.30	82	6Mbps
Ant. 1	802.11a	1 Stream 1TX	5825	22.30	82	6Mbps
Ant. 2	802.11a	1 Stream 1TX	5745	20.73	82	6Mbps
Ant. 2	802.11a	1 Stream 1TX	5785	20.73	82	6Mbps
Ant. 2	802.11a	1 Stream 1TX	5825	20.72	82	6Mbps
Ant. 3	802.11a	1 Stream 1TX	5745	22.38	82	6Mbps
Ant. 3	802.11a	1 Stream 1TX	5785	22.26	82	6Mbps
Ant. 3	802.11a	1 Stream 1TX	5825	22.47	82	6Mbps
Ant.1+2+3, CDD	802.11a	1 Stream 3TX	5745	26.38	82	6Mbps
Ant.1+2+3, CDD	802.11a	1 Stream 3TX	5785	26.30	82	6Mbps
Ant.1+2+3, CDD	802.11a	1 Stream 3TX	5825	26.40	82	6Mbps
Ant. 1	802.11ac20MHz	1 Stream 1TX	5745	22.28	82	Nss1MCS0
Ant. 1	802.11ac20MHz	1 Stream 1TX	5785	22.24	82	Nss1MCS0
Ant. 1	802.11ac20MHz	1 Stream 1TX	5825	22.18	82	Nss1MCS0
Ant. 2	802.11ac20MHz	1 Stream 1TX	5745	20.83	82	Nss1MCS0
Ant. 2	802.11ac20MHz	1 Stream 1TX	5785	20.58	82	Nss1MCS0
Ant. 2	802.11ac20MHz	1 Stream 1TX	5825	20.80	82	Nss1MCS0
Ant. 3	802.11ac20MHz	1 Stream 1TX	5745	22.34	82	Nss1MCS0
Ant. 3	802.11ac20MHz	1 Stream 1TX	5785	22.32	82	Nss1MCS0
Ant. 3	802.11ac20MHz	1 Stream 1TX	5825	22.33	82	Nss1MCS0
Ant.1+2+3, CDD	802.11ac20MHz	1 Stream 3TX	5745	26.29	82	Nss1MCS0
Ant.1+2+3, CDD	802.11ac20MHz	1 Stream 3TX	5785	26.27	82	Nss1MCS0
Ant.1+2+3, CDD	802.11ac20MHz	1 Stream 3TX	5825	26.29	82	Nss1MCS0
Ant.1+2+3, CDD	802.11ac20MHz	2 Stream 3TX	5745	26.27	82	Nss2MCS0
Ant.1+2+3, CDD	802.11ac20MHz	2 Stream 3TX	5785	26.23	82	Nss2MCS0
Ant.1+2+3, CDD	802.11ac20MHz	2 Stream 3TX	5825	26.32	82	Nss2MCS0
Ant.1+2+3, SDM	802.11ac20MHz	3 Stream 3TX	5745	28.79	92	Nss3MCS0
Ant.1+2+3, SDM	802.11ac20MHz	3 Stream 3TX	5785	28.61	92	Nss3MCS0
Ant.1+2+3, SDM	802.11ac20MHz	3 Stream 3TX	5825	28.59	92	Nss3MCS0
Ant. 1	802.11ac40MHz	1 Stream 1TX	5755	21.44	82	Nss1MCS0
Ant. 1	802.11ac40MHz	1 Stream 1TX	5795	21.43	82	Nss1MCS0
Ant. 2	802.11ac40MHz	1 Stream 1TX	5755	19.95	82	Nss1MCS0
Ant. 2	802.11ac40MHz	1 Stream 1TX	5795	19.97	82	Nss1MCS0
Ant. 3	802.11ac40MHz	1 Stream 1TX	5755	21.13	82	Nss1MCS0

FCC TEST REPORT

Report No.: FR422438AA

Ant. 3	802.11ac40MHz	1 Stream 1TX	5795	21.02	82	Nss1MCS0
Ant. 1+2+3, CDD	802.11ac40MHz	1 Stream 3TX	5755	25.35	82	Nss1MCS0
Ant. 1+2+3, CDD	802.11ac40MHz	1 Stream 3TX	5795	25.40	82	Nss1MCS0
Ant. 1+2+3, CDD	802.11ac40MHz	2 Stream 3TX	5755	25.43	82	Nss2MCS0
Ant. 1+2+3, CDD	802.11ac40MHz	2 Stream 3TX	5795	25.40	82	Nss2MCS0
Ant. 1+2+3, SDM	802.11ac40MHz	3 Stream 3TX	5755	27.42	90	Nss3MCS0
Ant. 1+2+3, SDM	802.11ac40MHz	3 Stream 3TX	5795	27.84	92	Nss3MCS0
Ant. 1	802.11ac80MHz	1 Stream 1TX	5775	21.62	82	Nss1MCS0
Ant. 2	802.11ac80MHz	1 Stream 1TX	5775	20.80	82	Nss1MCS0
Ant. 3	802.11ac80MHz	1 Stream 1TX	5775	21.44	82	Nss1MCS0
Ant. 1+2+3, CDD	802.11ac80MHz	1 Stream 3TX	5775	25.88	82	Nss1MCS0
Ant. 1+2+3, CDD	802.11ac80MHz	2 Stream 3TX	5775	25.90	82	Nss2MCS0
Ant. 1+2+3, SDM	802.11ac80MHz	3 Stream 3TX	5775	26.08	82	Nss3MCS0

For Beamforming

The Power Setting Parameter						
Power Level		1				
Test Software Version		MTOOL 2.0.1.0				
Worst Modulation Mode		Number of Transmit Chains (NTX)	Frequency (MHz)	Maximum Output Power (dBm)	Power Setting	Data Rate / MCS
Ant.1+2+3, CDD	802.11ac20MHz	1 Stream 3TX	5745	26.51	82	Nss1MCS0
Ant.1+2+3, CDD	802.11ac20MHz	1 Stream 3TX	5785	26.36	82	Nss1MCS0
Ant.1+2+3, CDD	802.11ac20MHz	1 Stream 3TX	5825	26.40	82	Nss1MCS0
Ant.1+2+3, CDD	802.11ac20MHz	2 Stream 3TX	5745	26.50	82	Nss2MCS0
Ant.1+2+3, CDD	802.11ac20MHz	2 Stream 3TX	5785	26.75	82	Nss2MCS0
Ant.1+2+3, CDD	802.11ac20MHz	2 Stream 3TX	5825	26.64	82	Nss2MCS0
Ant.1+2+3, CDD	802.11ac40MHz	1 Stream 3TX	5755	25.80	82	Nss1MCS0
Ant.1+2+3, CDD	802.11ac40MHz	1 Stream 3TX	5795	25.68	82	Nss1MCS0
Ant.1+2+3, CDD	802.11ac40MHz	2 Stream 3TX	5755	25.64	82	Nss2MCS0
Ant.1+2+3, CDD	802.11ac40MHz	2 Stream 3TX	5795	25.54	82	Nss2MCS0
Ant.1+2+3, CDD	802.11ac80MHz	1 Stream 3TX	5775	26.12	82	Nss1MCS0
Ant.1+2+3, CDD	802.11ac80MHz	2 Stream 3TX	5775	25.96	82	Nss2MCS0

2.10. Test Configuration

2.10.1. AC Power Line Conduction Emissions Test Configuration

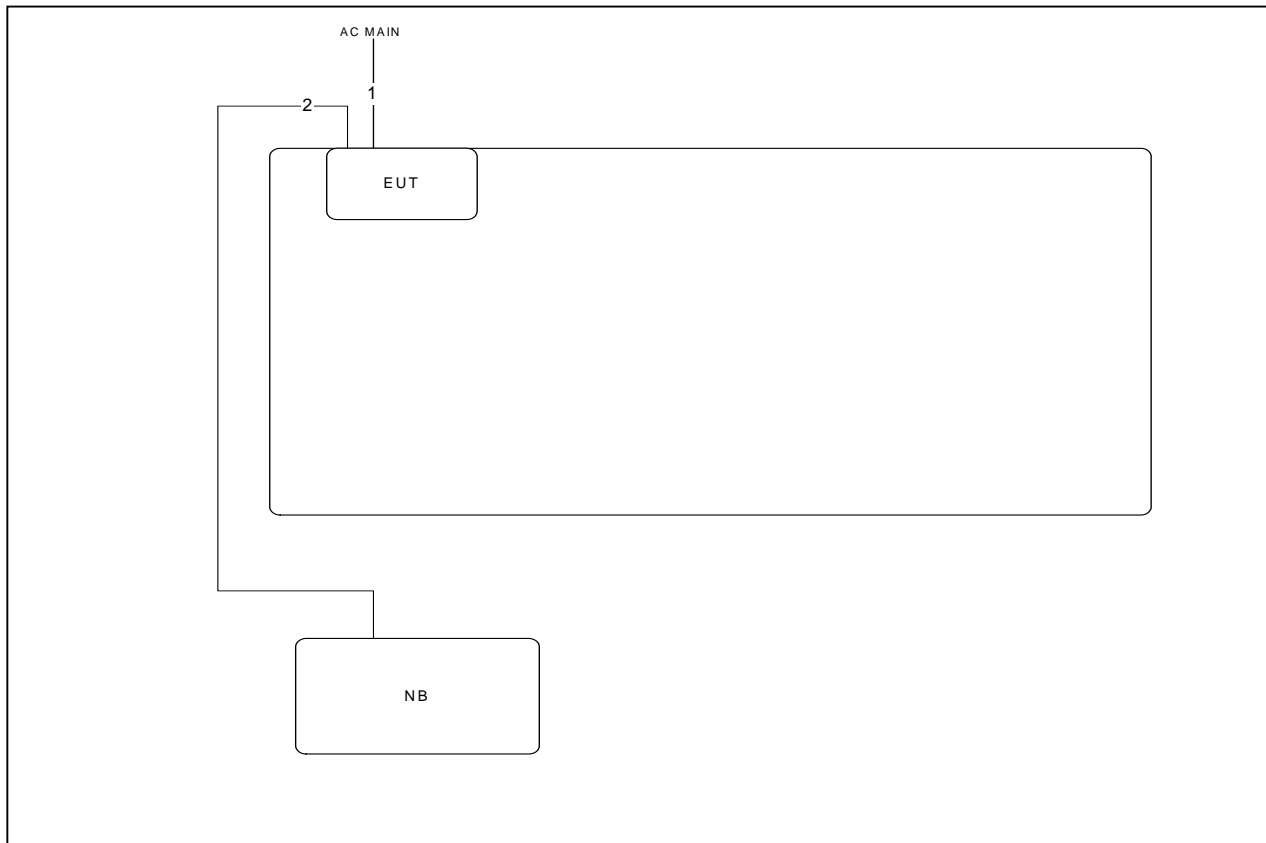

Item	Connection	Shield	Length
1	Power cable	No	1.8M
2	RJ-45 cable	No	10M

2.10.2. Radiation Emissions Test Configuration

For Non-Beamforming

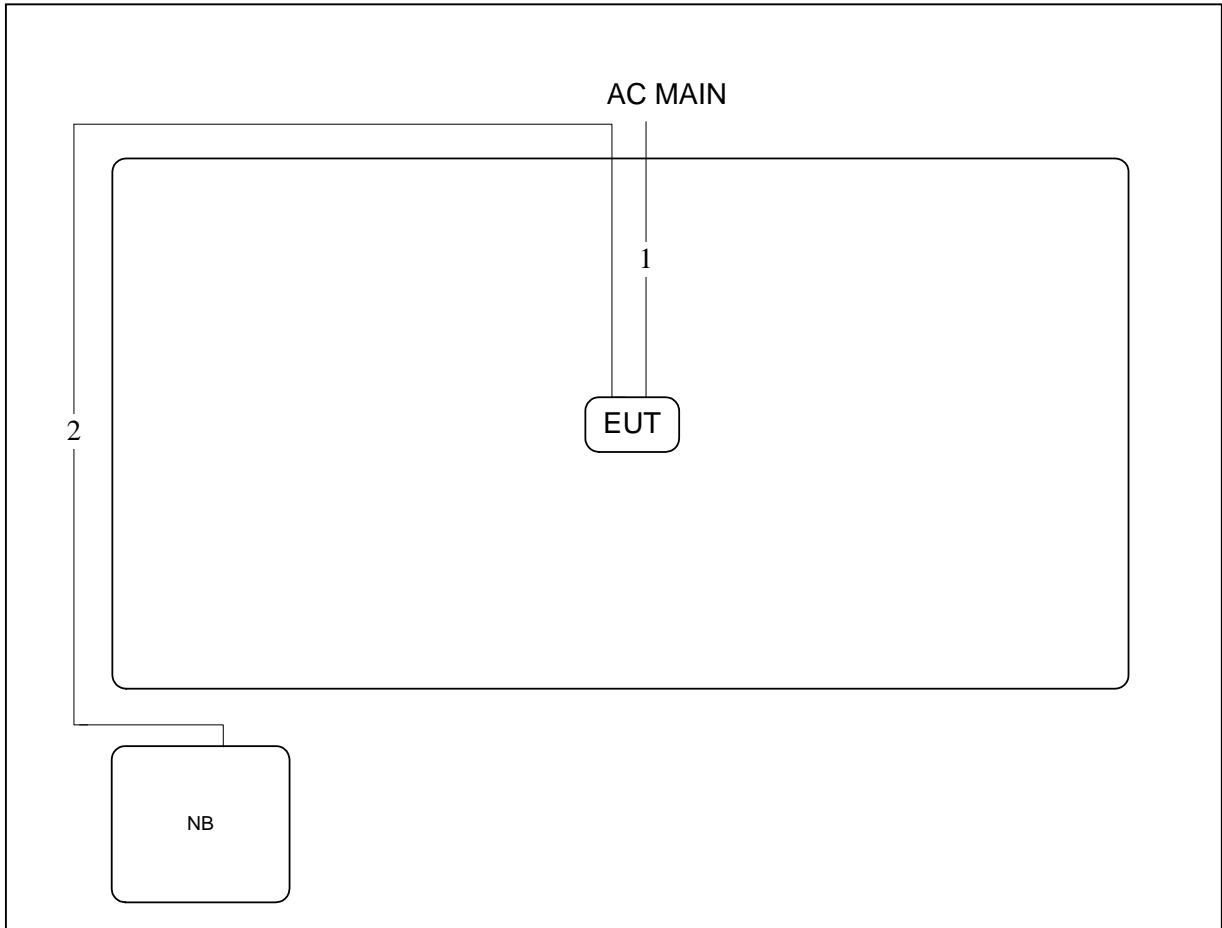

Item	Connection	Shield	Length
1	Power cable	No	1.8M
2	RJ-45 cable	No	10M

For Non-Beamforming

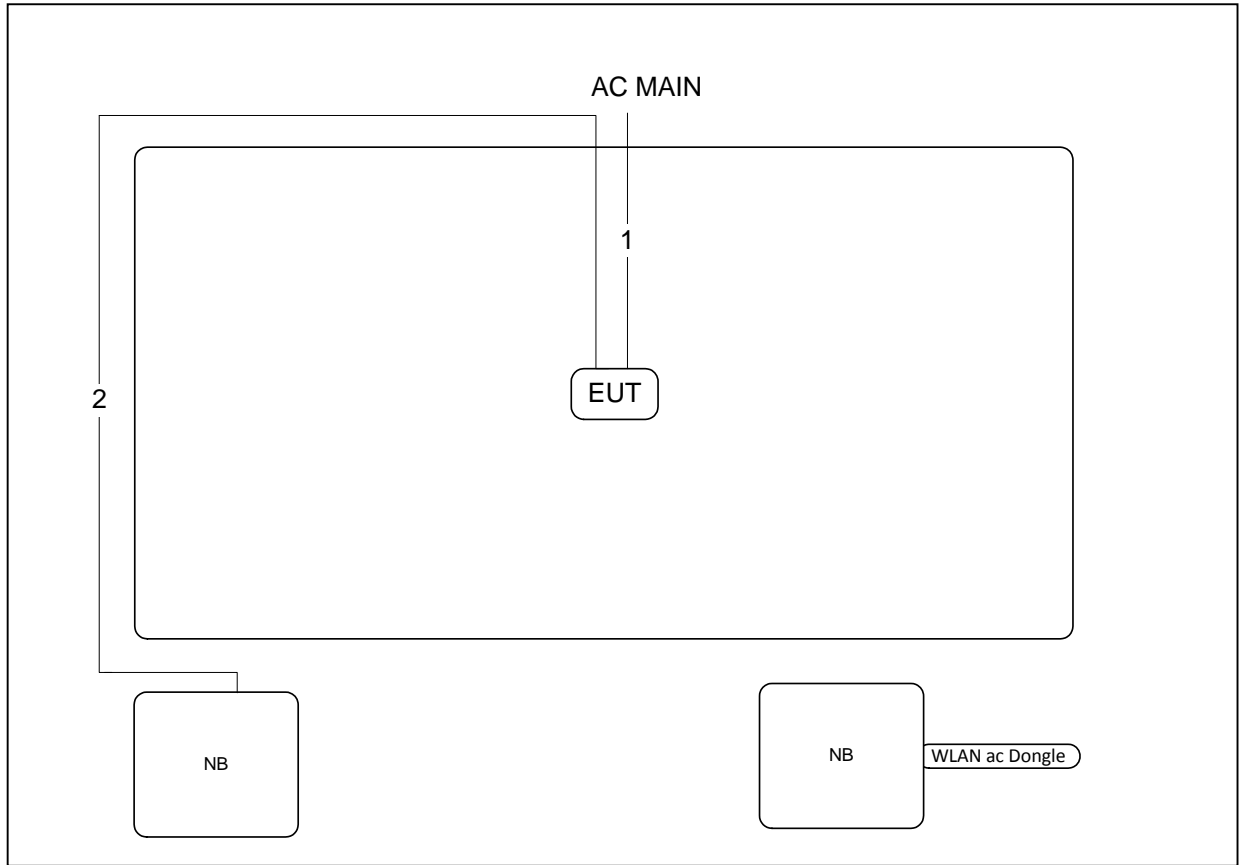

Item	Connection	Shield	Length
1	Power cable	No	1.8M
2	RJ-45 cable	No	10M

3. THE 2.4G BAND TEST RESULT

3.1. AC Power Line Conducted Emissions Measurement

3.1.1. Limit

For this product which is designed to be connected to the AC power line, the radio frequency voltage that is conducted back onto the AC power line on any frequency or frequencies within the band 150 kHz to 30 MHz shall not exceed below limits table.

Frequency (MHz)	QP Limit (dBuV)	AV Limit (dBuV)
0.15~0.5	66~56	56~46
0.5~5	56	46
5~30	60	50

3.1.2. Measuring Instruments and Setting

Please refer to section 6 of equipments list in this report. The following table is the setting of the receiver.

Receiver Parameters	Setting
Attenuation	10 dB
Start Frequency	0.15 MHz
Stop Frequency	30 MHz
IF Bandwidth	9 kHz

3.1.3. Test Procedures

1. Configure the EUT according to ANSI C63.10. The EUT or host of EUT has to be placed 0.4 meter far from the conducting wall of the shielding room and at least 80 centimeters from any other grounded conducting surface.
2. Connect EUT or host of EUT to the power mains through a line impedance stabilization network (LISN).
3. All the support units are connected to the other LISNs. The LISN should provide 50uH/50ohms coupling impedance.
4. The frequency range from 150 kHz to 30 MHz was searched.
5. Set the test-receiver system to Peak Detect Function and Specified Bandwidth with Maximum Hold Mode.
6. The measurement has to be done between each power line and ground at the power terminal.

3.1.4. Test Setup Layout

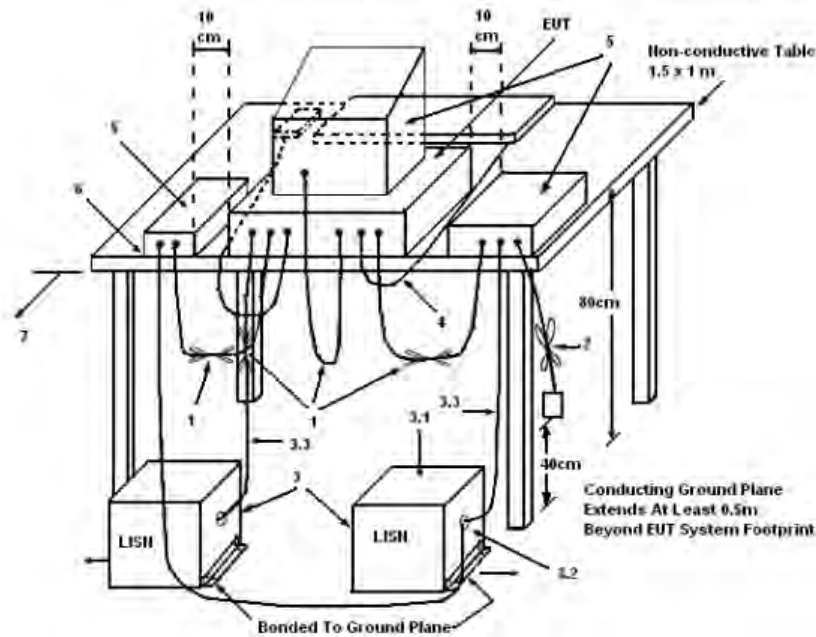

LEGEND:

1. Interconnecting cables that hang closer than 40 cm to the ground plane shall be folded back and forth in the center forming a bundle 30 to 40 cm long.
2. I/O cables that are not connected to a peripheral shall be bundled in the center. The end of the cable may be terminated, if required, using the correct terminating impedance. The overall length shall not exceed 1 m.
3. EUT connected to one LISN. Unused LISN measuring port connectors shall be terminated in 50 Ω. LISN can be placed on top of, or immediately beneath, reference ground plane.
4. All other equipment powered from additional LISN(s).
5. Multiple outlet strip can be used for multiple power cords of non-EUT equipment.
6. LISN at least 80 cm from nearest part of EUT chassis.
7. Cables of hand-operated devices, such as keyboards, mice, etc., shall be placed as for normal use.
8. Non-EUT components of EUT system being tested.
9. Rear of EUT, including peripherals, shall all be aligned and flush with rear of tabletop.
10. Rear of tabletop shall be 40 cm removed from a vertical conducting plane that is bonded to the ground plane.

3.1.5. Test Deviation

There is no deviation with the original standard.

3.1.6. EUT Operation during Test

The EUT was placed on the test table and programmed in normal function.

3.1.7. Results of AC Power Line Conducted Emissions Measurement

Temperature	24°C	Humidity	51%
Test Engineer	Justin Chiu	Phase	Line
Configuration	CTX		

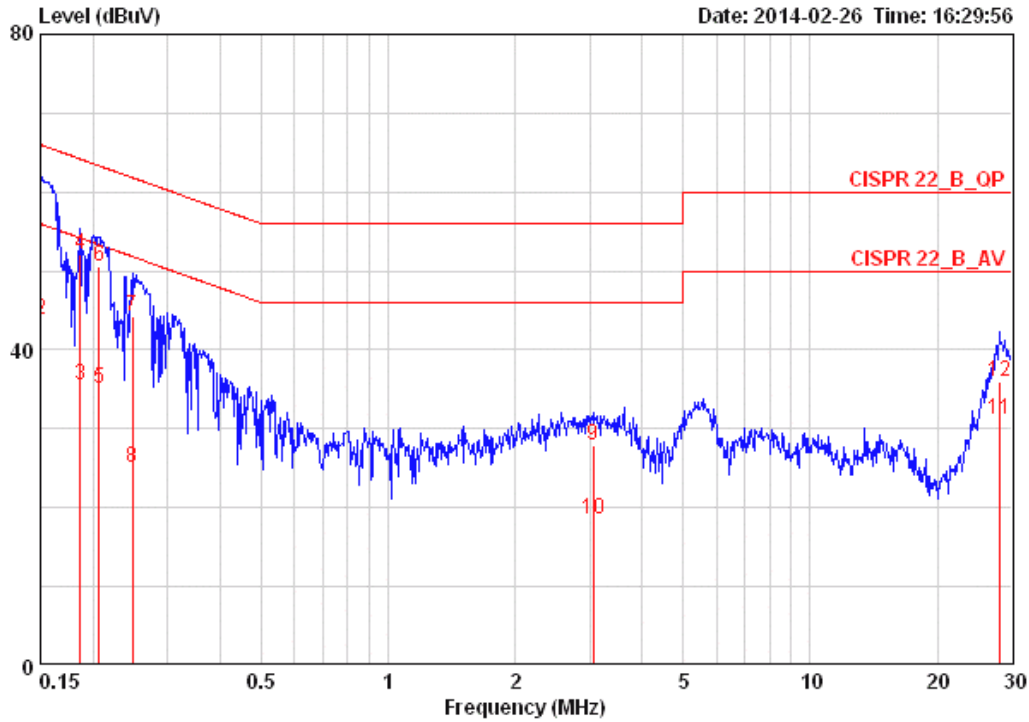

	Freq	Level	Over	Limit	LISN	Read	Cable		Remark
	MHz	dBuV	dB	dBuV	dB	dBuV	dB		
1 @	0.15000	57.96	-8.04	66.00	0.15	57.65	0.16	LINE	QP
2 @	0.15000	43.75	-12.25	56.00	0.15	43.44	0.16	LINE	AVERAGE
3	0.18640	35.45	-18.74	54.20	0.15	35.14	0.16	LINE	AVERAGE
4 @	0.18640	52.10	-12.09	64.20	0.15	51.79	0.16	LINE	QP
5	0.20614	35.20	-18.16	53.36	0.15	34.88	0.17	LINE	AVERAGE
6 @	0.20614	50.68	-12.68	63.36	0.15	50.36	0.17	LINE	QP
7	0.24814	44.17	-17.65	61.82	0.15	43.85	0.17	LINE	QP
8	0.24814	25.09	-26.73	51.82	0.15	24.77	0.17	LINE	AVERAGE
9	3.058	27.85	-28.15	56.00	0.24	27.33	0.28	LINE	QP
10	3.058	18.56	-27.44	46.00	0.24	18.04	0.28	LINE	AVERAGE
11	28.003	31.19	-18.81	50.00	0.85	29.74	0.60	LINE	AVERAGE
12	28.003	36.01	-23.99	60.00	0.85	34.56	0.60	LINE	QP

Note 1: The test was passed at the minimum margin that marked by the frame in the following data
 Note 2: The emission levels of other frequencies were very low against the limit.
 Note 3: Q.P. and AV. are abbreviations of quasi-peak and average individually.
 Note 4: Corrected Reading (dBµV) = LISN Factor + Cable Loss + Read Level = Level
 Note 5: Over Limit value = level - Limit value

Temperature	24°C	Humidity	51%
Test Engineer	Justin Chiu	Phase	Neutral
Configuration	CTX		

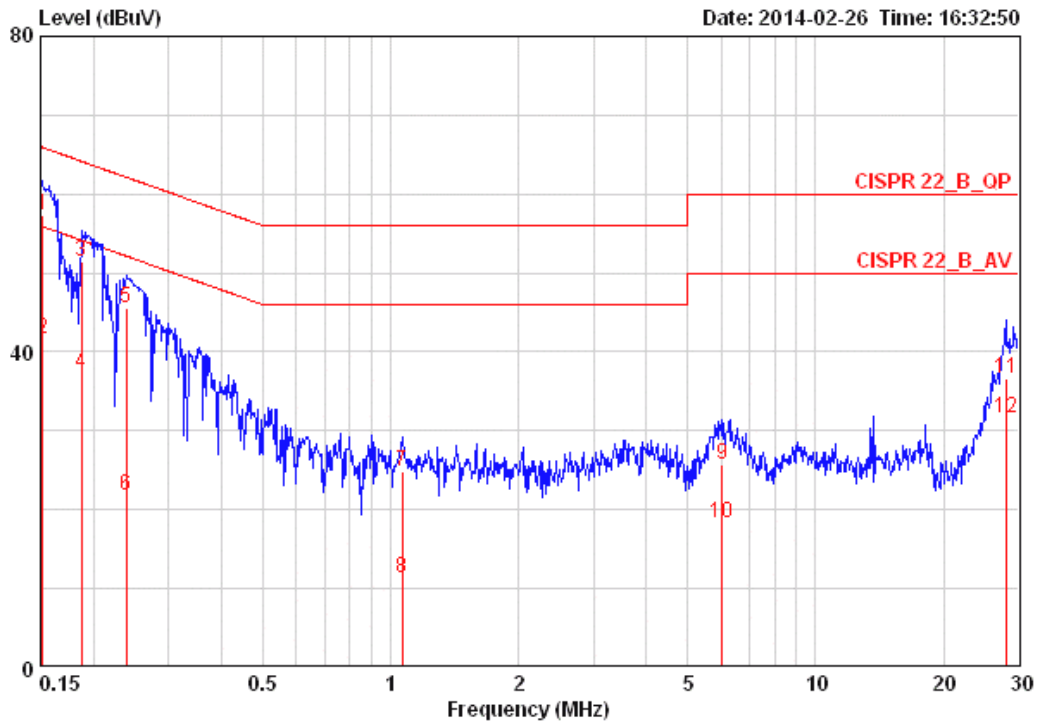

	Freq	Level	Over Limit	Limit Line	LISN Factor	Read Level	Cable Loss	Pol/Phase	Remark
	MHz	dBuV	dB	dBuV	dB	dBuV	dB		
1	0.15160	57.42	-8.49	65.91	0.07	57.19	0.16	NEUTRAL	QP
2	0.15160	41.55	-14.36	55.91	0.07	41.32	0.16	NEUTRAL	AVERAGE
3	0.18739	51.48	-12.67	64.15	0.07	51.25	0.16	NEUTRAL	QP
4	0.18739	37.32	-16.83	54.15	0.07	37.09	0.16	NEUTRAL	AVERAGE
5	0.23910	45.55	-16.58	62.13	0.07	45.31	0.17	NEUTRAL	QP
6	0.23910	21.79	-30.34	52.13	0.07	21.55	0.17	NEUTRAL	AVERAGE
7	1.065	24.80	-31.20	56.00	0.08	24.51	0.20	NEUTRAL	QP
8	1.065	11.25	-34.75	46.00	0.08	10.96	0.20	NEUTRAL	AVERAGE
9	6.024	25.74	-34.26	60.00	0.18	25.23	0.34	NEUTRAL	QP
10	6.024	18.38	-31.62	50.00	0.18	17.87	0.34	NEUTRAL	AVERAGE
11	28.003	36.69	-23.31	60.00	0.78	35.31	0.60	NEUTRAL	QP
12	28.003	31.71	-18.29	50.00	0.78	30.33	0.60	NEUTRAL	AVERAGE

Note 1: The test was passed at the minimum margin that marked by the frame in the following data
 Note 2: The emission levels of other frequencies were very low against the limit.
 Note 3: Q.P. and AV. are abbreviations of quasi-peak and average individually.
 Note 4: Corrected Reading (dBμV) = LISN Factor + Cable Loss + Read Level = Level
 Note 5: Over Limit value = level - Limit value

3.2. Maximum Conducted Output Power Measurement

3.2.1. Limit

For systems using digital modulation in the 2400-2483.5MHz, the limit for peak output power is 30dBm. The limited has to be reduced by the amount in dB that the gain of the antenna exceed 6dBi. In case of point-to-point operation, the limit has to be reduced by 1dB for every 3dB that the directional gain of the antenna exceeds 6dBi.

3.2.2. Measuring Instruments and Setting

Please refer to section 6 of equipments list in this report. The following table is the setting of the power meter.

Power Meter Parameter	Setting
Detector	Average

3.2.3. Test Procedures

1. Test procedures refer KDB 662911 D01 v02r01 section 9.2.2 Measurement using a power meter (PM).
2. This procedure provides an alternative for determining the RMS output power using a broadband RF average power meter with a thermocouple detector.

3.2.4. Test Setup Layout

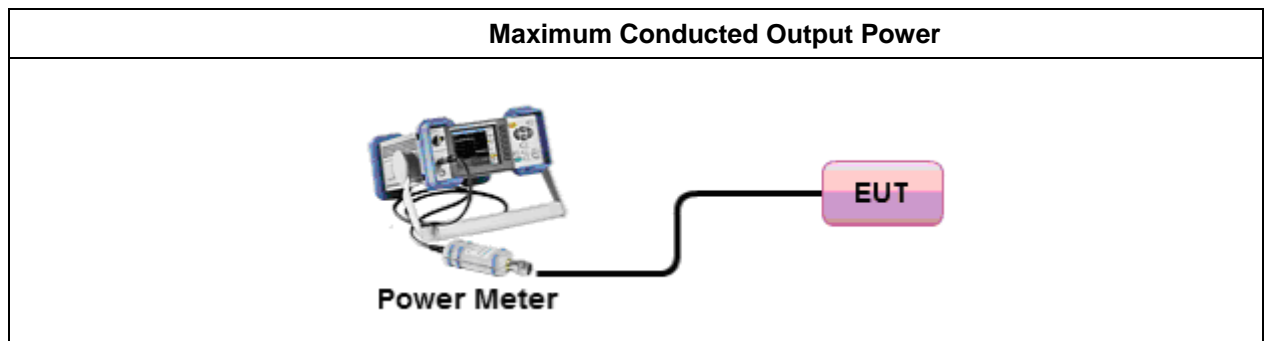

3.2.5. Test Deviation

There is no deviation with the original standard.

3.2.6. EUT Operation during Test

The EUT was programmed to be in continuously transmitting mode.

3.2.7. Test Result for Maximum Conducted Output Power

Test date	Jan. 27, 2014	Test Site No.	TH01-CB
Temperature	26°C	Humidity	63%
Test Engineer	Magic Lai	Configuration	802.11b
Duty Cycle	Ant.1, 2, 3: 100% Ant.1+2+3: 100%		

Configuration IEEE 802.11b

<Ant. 1>

Channel	Frequency	Conducted Power (dBm)	Antenna Gain (dBi)	Max. Limit (dBm)	Result
1	2412 MHz	26.09	3.61	30.00	Complies
6	2437 MHz	26.12	3.51	30.00	Complies
11	2462 MHz	26.08	3.76	30.00	Complies

<Ant. 2>

Channel	Frequency	Conducted Power (dBm)	Antenna Gain (dBi)	Max. Limit (dBm)	Result
1	2412 MHz	25.88	4.30	30.00	Complies
6	2437 MHz	25.87	3.87	30.00	Complies
11	2462 MHz	25.92	3.74	30.00	Complies

<Ant. 3>

Channel	Frequency	Conducted Power (dBm)	Antenna Gain (dBi)	Max. Limit (dBm)	Result
1	2412 MHz	26.01	5.34	30.00	Complies
6	2437 MHz	26.02	4.67	30.00	Complies
11	2462 MHz	26.11	4.35	30.00	Complies

<Ant. 1+2+3, CDD>

Channel	Frequency	Conducted Power (dBm)				Antenna Gain (dBi)	Max. Limit (dBm)	Result
		Ant. 1	Ant. 2	Ant. 3	Total			
1	2412 MHz	22.89	22.36	22.47	27.35	5.34	30.00	Complies
6	2437 MHz	22.44	21.92	22.37	27.02	4.67	30.00	Complies
11	2462 MHz	22.51	22.06	22.41	27.10	4.35	30.00	Complies

Test date	Jan. 27, 2014	Test Site No.	TH01-CB
Temperature	26°C	Humidity	63%
Test Engineer	Magic Lai	Configuration	802.11g
Duty Cycle	Ant.1, 2, 3: 98.56% Ant.1+2+3: 99.04%		

Configuration IEEE 802.11g

<Ant. 1>

Channel	Frequency	Conducted Power (dBm)	Antenna Gain (dBi)	Max. Limit (dBm)	Result
1	2412 MHz	21.78	3.61	30.00	Complies
6	2437 MHz	25.57	3.51	30.00	Complies
11	2462 MHz	21.41	3.76	30.00	Complies

<Ant. 2>

Channel	Frequency	Conducted Power (dBm)	Antenna Gain (dBi)	Max. Limit (dBm)	Result
1	2412 MHz	22.04	4.30	30.00	Complies
6	2437 MHz	25.39	3.87	30.00	Complies
11	2462 MHz	21.83	3.74	30.00	Complies

<Ant. 3>

Channel	Frequency	Conducted Power (dBm)	Antenna Gain (dBi)	Max. Limit (dBm)	Result
1	2412 MHz	20.92	5.34	30.00	Complies
6	2437 MHz	25.50	4.67	30.00	Complies
11	2462 MHz	21.61	4.35	30.00	Complies

<Ant. 1+2+3, CDD>

Channel	Frequency	Conducted Power (dBm)				Antenna Gain (dBi)	Max. Limit (dBm)	Result
		Ant. 1	Ant. 2	Ant. 3	Total			
1	2412 MHz	19.87	19.37	19.69	24.46	5.34	30.00	Complies
6	2437 MHz	23.35	23.20	23.17	28.05	4.67	30.00	Complies
11	2462 MHz	19.41	19.08	19.28	24.07	4.35	30.00	Complies

Test date	Jan. 27, 2014	Test Site No.	TH01-CB
Temperature	26°C	Humidity	63%
Test Engineer	Magic Lai	Configuration	802.11n
Duty Cycle	Ant.1, 2, 3: 98.77% MCS0, Ant.1+2+3, CDD: 98.77% MCS8, Ant.1+2+3, CDD: 97% MCS16, Ant.1+2+3, SDM: 97.10%		

Configuration of IEEE 802.11n 20MHz

< MCS0, Ant. 1 >

Channel	Frequency	Conducted Power (dBm)	Antenna Gain (dBi)	Max. Limit (dBm)	Result
1	2412 MHz	20.16	3.61	30.00	Complies
6	2437 MHz	25.54	3.51	30.00	Complies
11	2462 MHz	20.65	3.76	30.00	Complies

< MCS0, Ant. 2 >

Channel	Frequency	Conducted Power (dBm)	Antenna Gain (dBi)	Max. Limit (dBm)	Result
1	2412 MHz	21.49	4.30	30.00	Complies
6	2437 MHz	25.31	3.87	30.00	Complies
11	2462 MHz	21.23	3.74	30.00	Complies

< MCS0, Ant. 3 >

Channel	Frequency	Conducted Power (dBm)	Antenna Gain (dBi)	Max. Limit (dBm)	Result
1	2412 MHz	19.89	5.34	30.00	Complies
6	2437 MHz	25.58	4.67	30.00	Complies
11	2462 MHz	20.49	4.35	30.00	Complies

< MCS0, Ant. 1+2+3, CDD>

Channel	Frequency	Conducted Power (dBm)				Antenna Gain (dBi)	Max. Limit (dBm)	Result
		Ant. 1	Ant. 2	Ant. 3	Total			
1	2412 MHz	19.15	18.79	18.84	23.75	5.34	30.00	Complies
6	2437 MHz	23.31	22.95	23.21	27.98	4.67	30.00	Complies
11	2462 MHz	19.18	18.68	19.16	23.84	4.35	30.00	Complies

< MCS8, Ant. 1+2+3, CDD>

Channel	Frequency	Conducted Power (dBm)				Antenna Gain (dBi)	Max. Limit (dBm)	Result
		Ant. 1	Ant. 2	Ant. 3	Total			
1	2412 MHz	19.52	18.95	19.36	24.18	5.34	30.00	Complies
6	2437 MHz	24.08	24.23	24.02	29.01	4.67	30.00	Complies
11	2462 MHz	19.51	19.03	19.48	24.25	4.35	30.00	Complies

< MCS16, Ant. 1+2+3, SDM>

Channel	Frequency	Conducted Power (dBm)				Directional Gain (dBi)	Max. Limit (dBm)	Result
		Ant. 1	Ant. 2	Ant. 3	Total			
1	2412 MHz	18.92	18.06	18.33	23.35	1.88	30.00	Complies
6	2437 MHz	24.53	24.11	24.43	29.26	1.41	30.00	Complies
11	2462 MHz	18.62	17.95	18.52	23.27	1.52	30.00	Complies

Test date	Jan. 27, 2014	Test Site No.	TH01-CB
Temperature	26°C	Humidity	63%
Test Engineer	Magic Lai	Configuration	802.11n
Duty Cycle	Ant.1, 2, 3: 96.88% MCS0, Ant.1+2+3, CDD: 97.92% MCS8, Ant.1+2+3, CDD: 94.23% MCS16, Ant.1+2+3, SDM: 92.10%		

Configuration of IEEE 802.11n 40MHz

< MCS0, Ant. 1>

Channel	Frequency	Conducted Power (dBm)	Antenna Gain (dBi)	Max. Limit (dBm)	Result
3	2422 MHz	19.54	3.57	30.00	Complies
6	2437 MHz	22.60	3.51	30.00	Complies
9	2452 MHz	19.52	3.66	30.00	Complies

< MCS0, Ant. 2>

Channel	Frequency	Conducted Power (dBm)	Antenna Gain (dBi)	Max. Limit (dBm)	Result
3	2422 MHz	19.10	4.13	30.00	Complies
6	2437 MHz	22.35	3.87	30.00	Complies
9	2452 MHz	19.54	3.77	30.00	Complies

< MCS0, Ant. 3>

Channel	Frequency	Conducted Power (dBm)	Antenna Gain (dBi)	Max. Limit (dBm)	Result
3	2422 MHz	19.25	5.07	30.00	Complies
6	2437 MHz	22.02	4.67	30.00	Complies
9	2452 MHz	18.92	4.46	30.00	Complies

< MCS0, Ant. 1+2+3, CDD>

Channel	Frequency	Conducted Power (dBm)				Antenna Gain (dBi)	Max. Limit (dBm)	Result
		Ant. 1	Ant. 2	Ant. 3	Total			
3	2422 MHz	16.88	16.46	16.75	21.56	5.07	30.00	Complies
6	2437 MHz	20.44	19.74	20.11	24.97	4.67	30.00	Complies
9	2452 MHz	17.16	16.47	16.99	21.75	4.46	30.00	Complies

< MCS8, Ant. 1+2+3, CDD>

Channel	Frequency	Conducted Power (dBm)				Antenna Gain (dBi)	Max. Limit (dBm)	Result
		Ant. 1	Ant. 2	Ant. 3	Total			
3	2422 MHz	17.96	16.96	17.50	22.52	5.07	30.00	Complies
6	2437 MHz	21.44	20.91	21.36	26.27	4.67	30.00	Complies
9	2452 MHz	18.33	17.75	18.18	23.12	4.46	30.00	Complies

< MCS16, Ant. 1+2+3, SDM>

Channel	Frequency	Conducted Power (dBm)				Directional Gain (dBi)	Max. Limit (dBm)	Result
		Ant. 1	Ant. 2	Ant. 3	Total			
3	2422 MHz	16.64	15.49	16.03	21.21	1.71	30.00	Complies
6	2437 MHz	19.83	19.00	19.61	24.62	1.41	30.00	Complies
9	2452 MHz	16.66	15.74	16.49	21.44	1.46	30.00	Complies

3.3. Power Spectral Density Measurement

3.3.1. Limit

For digitally modulated systems, the power spectral density conducted from the intentional radiator to the antenna shall not be greater than 8 dBm in any 3 kHz band during any time interval of continuous transmission.

3.3.2. Measuring Instruments and Setting

Please refer to section 6 of equipments list in this report. The following table is the setting of Spectrum Analyzer.

Power Meter Parameter	Setting
Attenuation	Auto
Span Frequency	Set span to at least 1.5 times the OBW.
RBW	10 kHz
VBW	30 kHz
Detector	RMS
Trace	Average
Sweep Time	Auto
Trace Average	100 times

3.3.3. Test Procedures

1. The transmitter output (antenna port) was connected RF switch to the spectrum analyzer.
2. Test was performed in accordance with KDB 558074 D01 v03r01 for Compliance Testing of Digital Transmission Systems (DTS) Devices - Part 15, Subpart C => Method AVGPSD-2 (trace averaging across on and off times of the EUT transmissions, followed by duty cycle correction).
3. Multiple antenna systems was performed in accordance KDB 662911 D01 v02 in-Band Power Spectral Density (PSD) Measurements (a) Measure and sum the spectra across the outputs (bin-by-bin summing).
4. When measuring first spectral bin of output 1 is summed with that in the first spectral bin of output 2 and that from the first spectral bin of output 3 and so on up to the Nth output to obtain the value for the first frequency bin of the summed spectrum. The summed spectrum value for each of the other frequency bins is computed in the same way.

3.3.4. Test Setup Layout

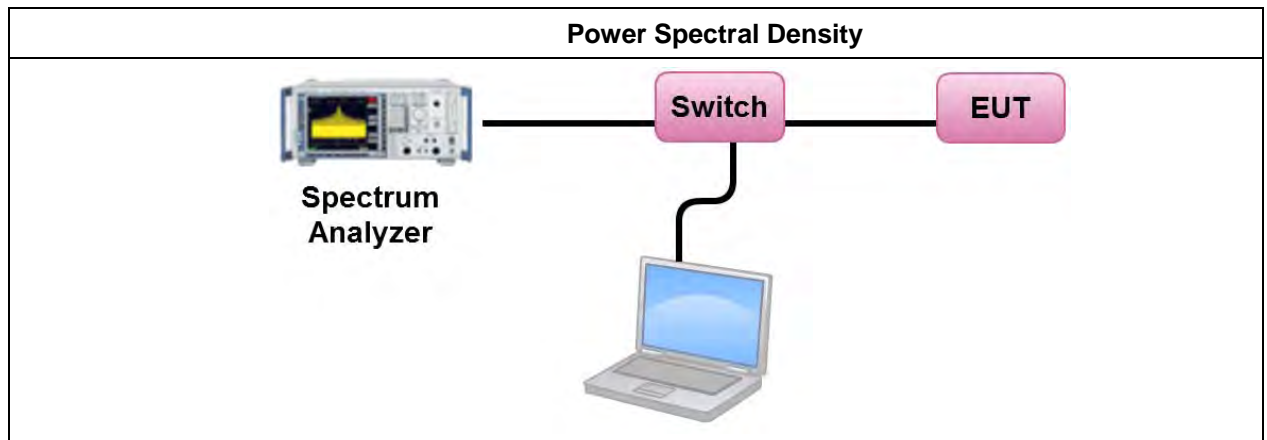

3.3.5. Test Deviation

There is no deviation with the original standard.

3.3.6. EUT Operation during Test

The EUT was programmed to be in continuously transmitting mode.

3.3.7. Test Result of Power Spectral Density

Test date	Jan. 27, 2014	Test Site No.	TH01-CB
Temperature	26°C	Humidity	63%
Test Engineer	Magic Lai	Configuration	802.11b
Duty Cycle	Ant.1, 2, 3: 100% Ant.1+2+3: 100%		

Configuration IEEE 802.11b

<Ant. 1>

Channel	Frequency	Total Power Density (dBm/10kHz)	Antenna Gain (dBi)	Max. Limit (dBm/10kHz)	Result
1	2412 MHz	-2.08	3.61	8.00	Complies
6	2437 MHz	-2.10	3.51	8.00	Complies
11	2462 MHz	-2.44	3.76	8.00	Complies

<Ant. 1+2+3, CDD>

Channel	Frequency	Total Power Density (dBm/10kHz)	Antenna Gain (dBi)	Max. Limit (dBm/10kHz)	Result
1	2412 MHz	2.44	5.34	8.00	Complies
6	2437 MHz	-1.18	4.67	8.00	Complies
11	2462 MHz	-1.23	4.35	8.00	Complies

Power Density Plot on Configuration IEEE 802.11b / CH 1 / Ant. 1

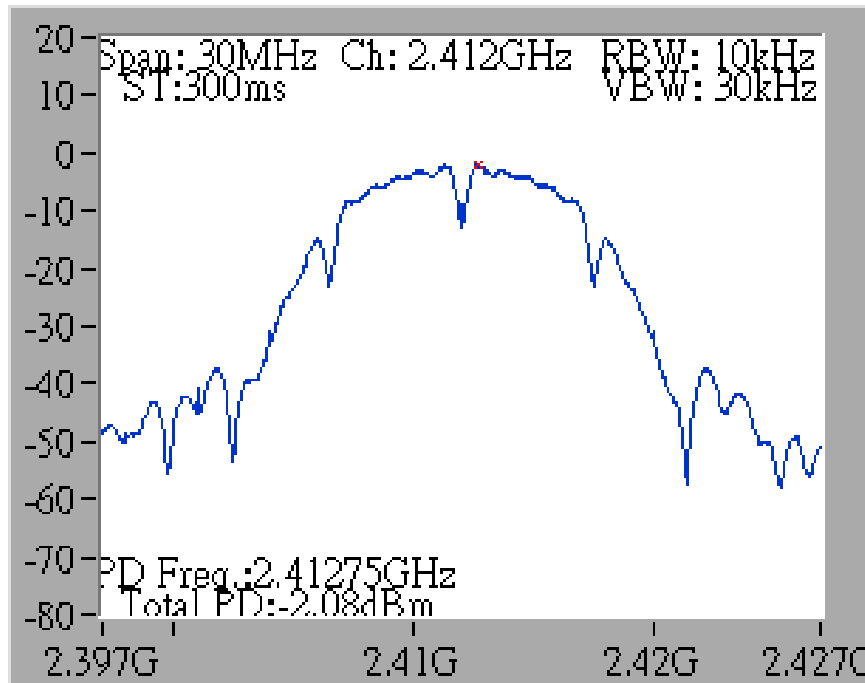

Power Density Plot on Configuration IEEE 802.11b / CH 6 / Ant. 1

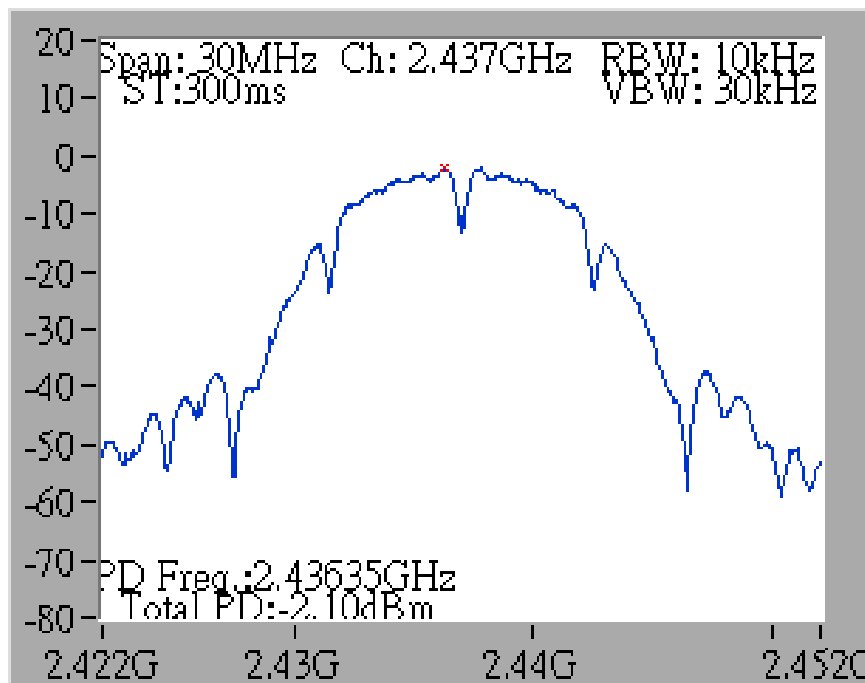

Power Density Plot on Configuration IEEE 802.11b / CH 11 / Ant. 1

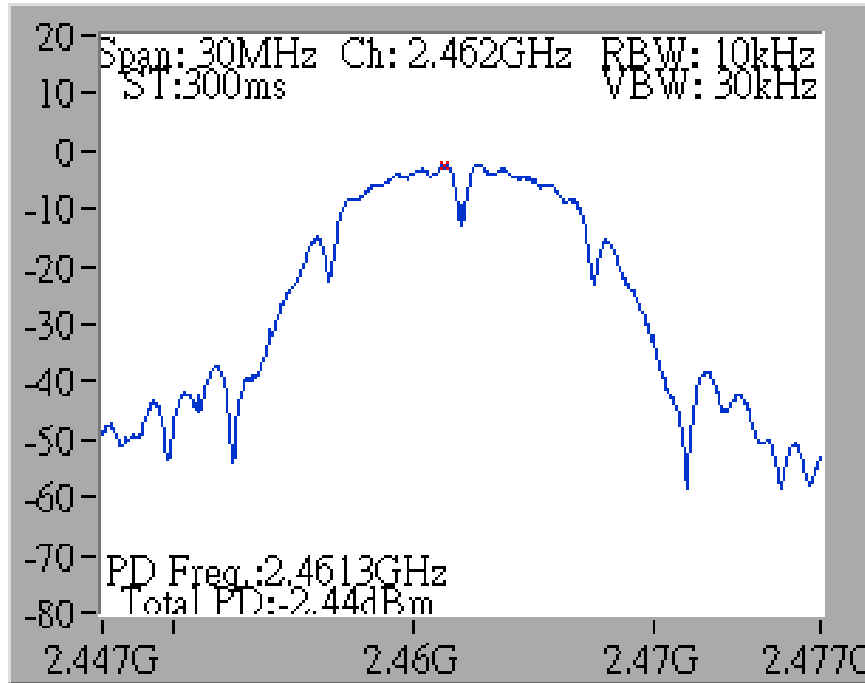

Power Density Plot on Configuration IEEE 802.11b / CH 1 / Ant. 1+2+3

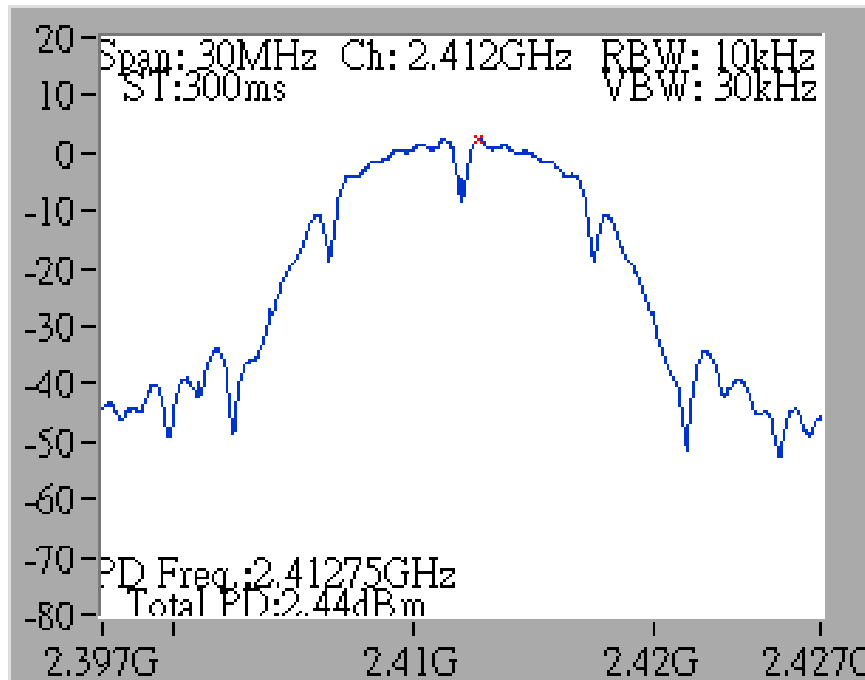

Power Density Plot on Configuration IEEE 802.11b / CH 6 / Ant. 1+2+3

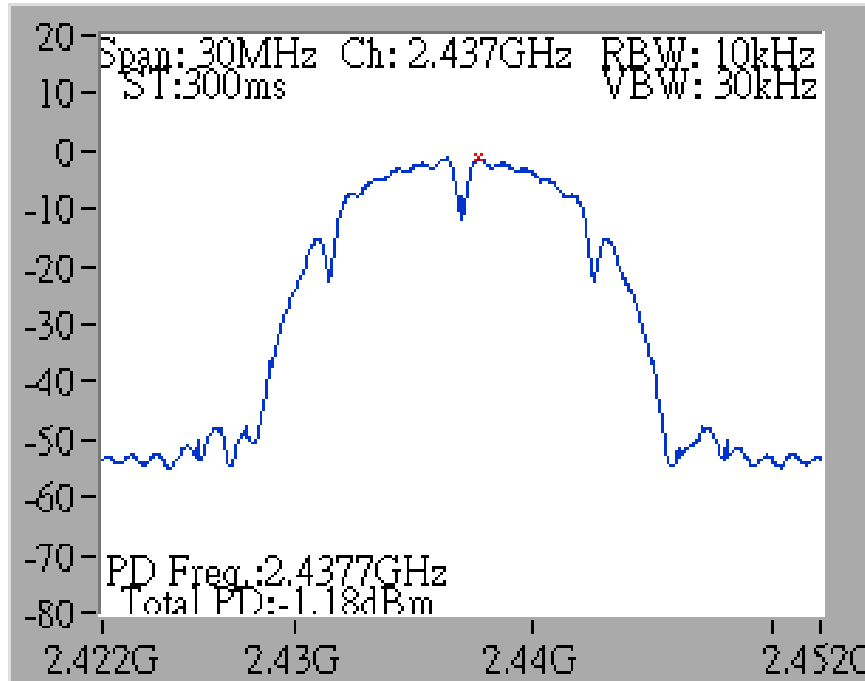

Power Density Plot on Configuration IEEE 802.11b / CH 11 / Ant. 1+2+3

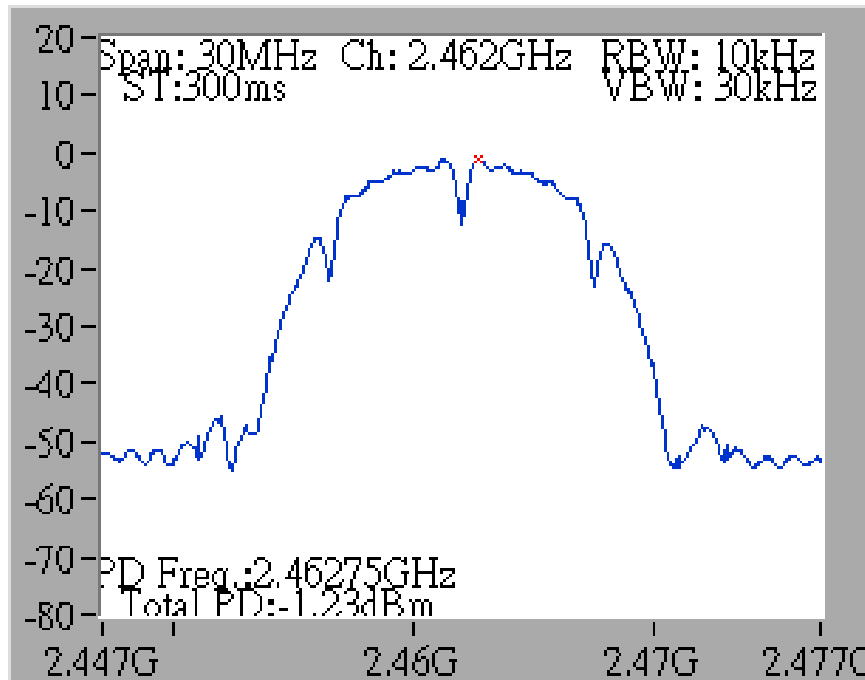

Test date	Jan. 27, 2014	Test Site No.	TH01-CB
Temperature	26°C	Humidity	63%
Test Engineer	Magic Lai	Configuration	802.11g
Duty Cycle	Ant.1, 2, 3: 98.56% Ant.1+2+3: 99.04%		

Configuration IEEE 802.11g

<Ant. 1>

Channel	Frequency	Total Power Density (dBm/10kHz)	Antenna Gain (dBi)	Max. Limit (dBm/10kHz)	Result
1	2412 MHz	-8.58	3.61	8.00	Complies
6	2437 MHz	-4.62	3.51	8.00	Complies
11	2462 MHz	-8.78	3.76	8.00	Complies

<Ant. 1+2+3, CDD>

Channel	Frequency	Total Power Density (dBm/10kHz)	Antenna Gain (dBi)	Max. Limit (dBm/10kHz)	Result
1	2412 MHz	-6.02	5.34	8.00	Complies
6	2437 MHz	-0.64	4.67	8.00	Complies
11	2462 MHz	-6.38	4.35	8.00	Complies

Power Density Plot on Configuration IEEE 802.11g / CH 1 / Ant. 1

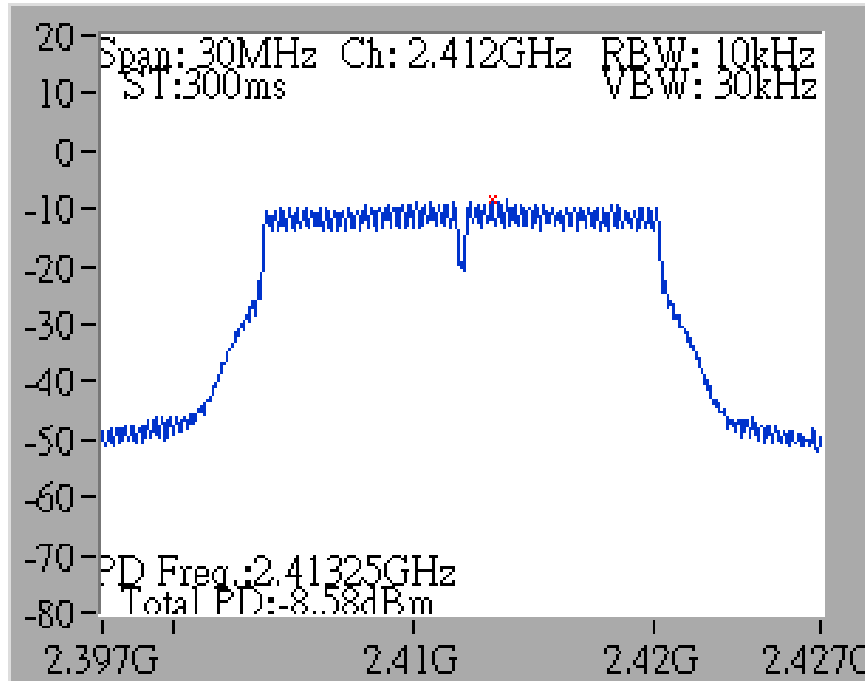

Power Density Plot on Configuration IEEE 802.11g / CH 6 / Ant. 1

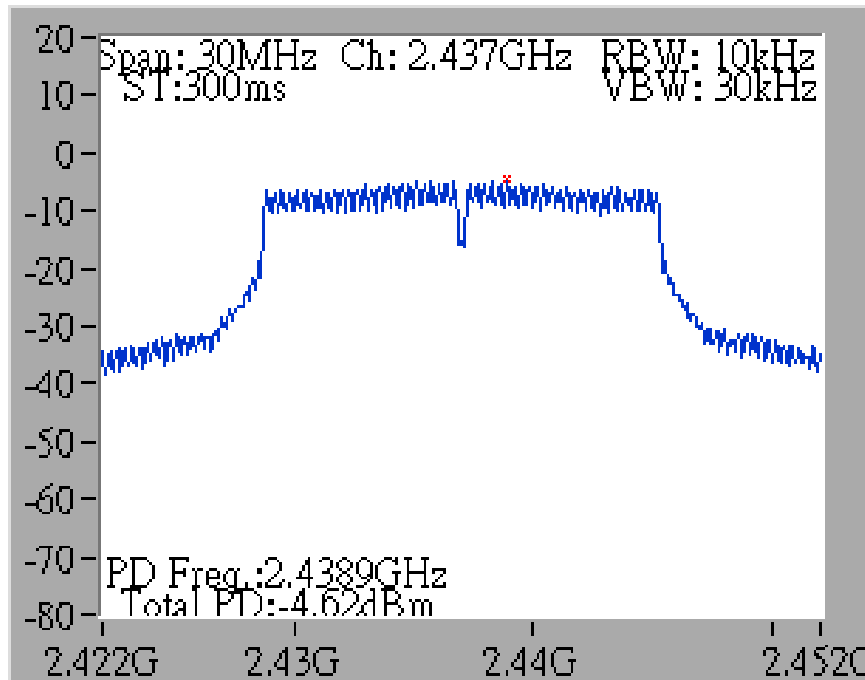

Power Density Plot on Configuration IEEE 802.11g / CH 11 / Ant. 1

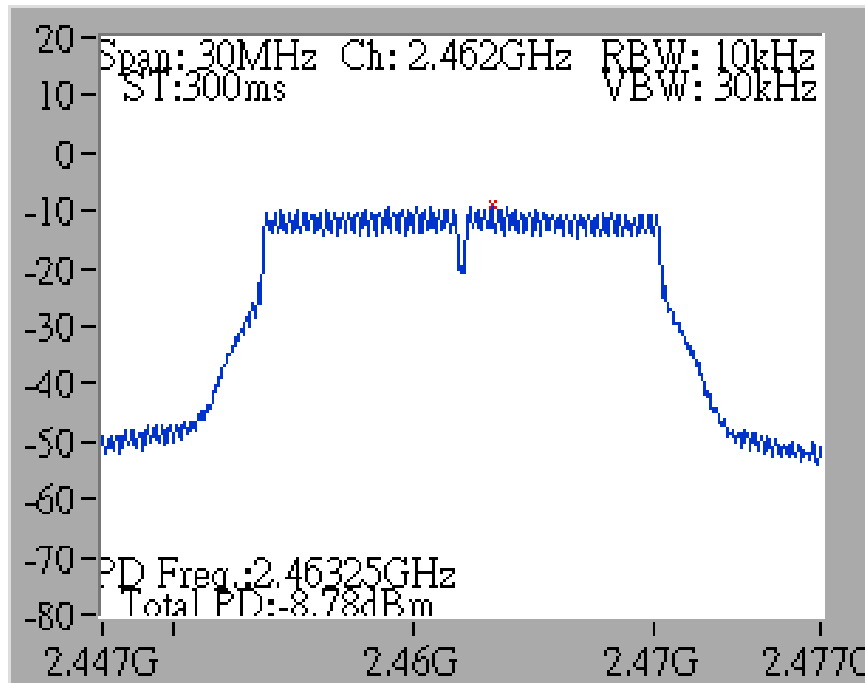

Power Density Plot on Configuration IEEE 802.11g / CH 1 / Ant. 1+2+3

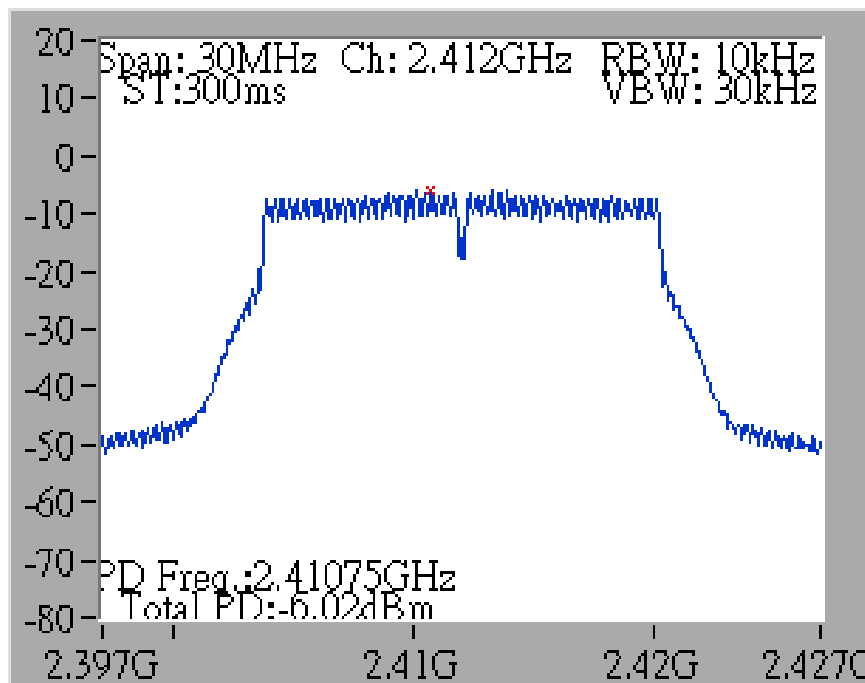

Power Density Plot on Configuration IEEE 802.11g / CH 6 / Ant. 1+2+3

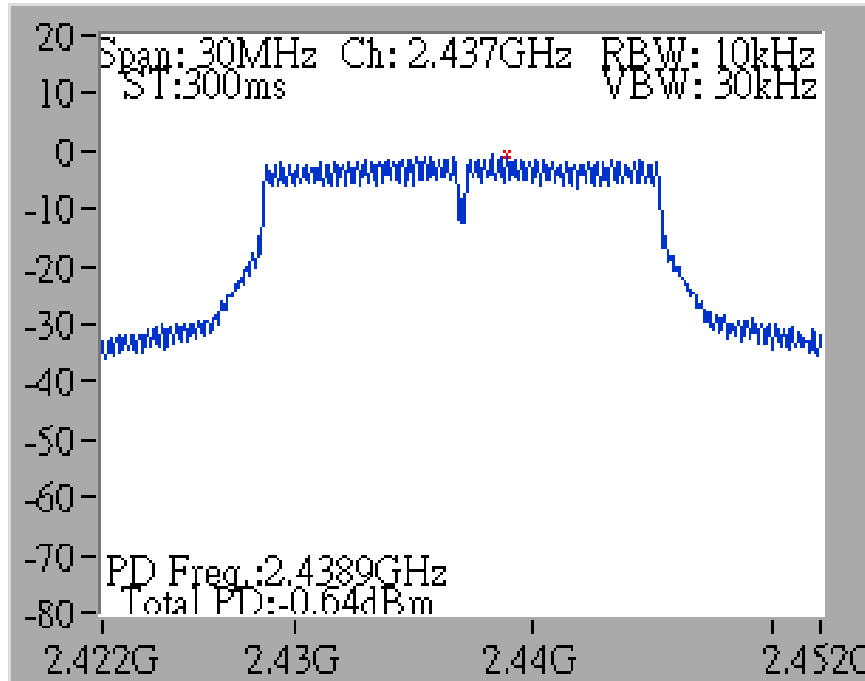

Power Density Plot on Configuration IEEE 802.11g / CH 11 / Ant. 1+2+3

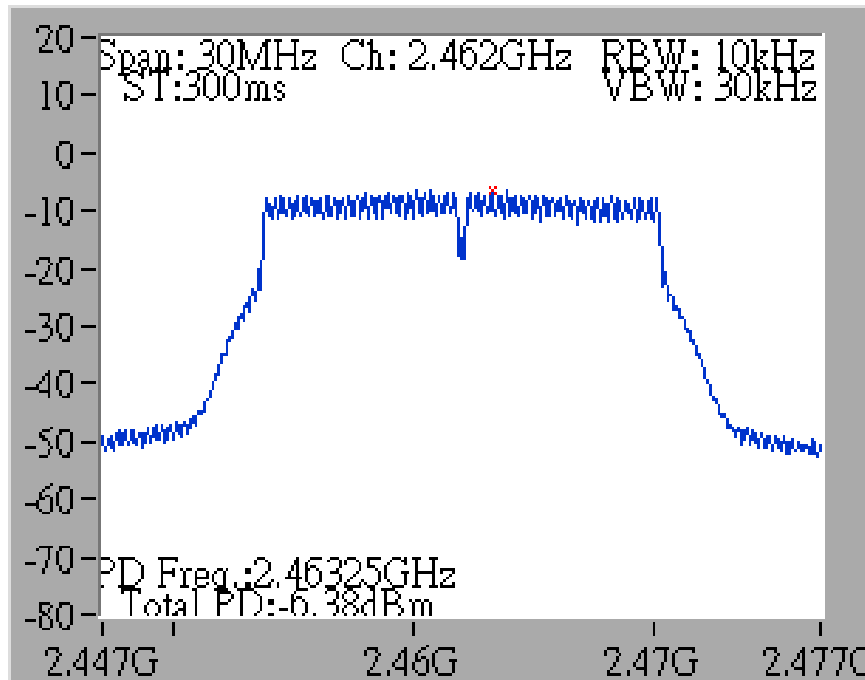

Test date	Jan. 27, 2014	Test Site No.	TH01-CB
Temperature	26°C	Humidity	63%
Test Engineer	Magic Lai	Configuration	802.11n
Duty Cycle	Ant.1, 2, 3: 98.77% MCS0, Ant.1+2+3, CDD: 98.77% MCS8, Ant.1+2+3, CDD: 97%		

Configuration IEEE 802.11n 20MHz

<MCS0, Ant. 3>

Channel	Frequency	Total Power Density (dBm/10kHz)	Antenna Gain (dBi)	Max. Limit (dBm/10kHz)	Result
1	2412 MHz	-11.07	5.34	8.00	Complies
6	2437 MHz	-5.34	4.67	8.00	Complies
11	2462 MHz	-10.71	4.35	8.00	Complies

<MCS0, Ant. 1+2+3, CDD>

Channel	Frequency	Total Power Density (dBm/10kHz)	Antenna Gain (dBi)	Max. Limit (dBm/10kHz)	Result
1	2412 MHz	-7.40	5.34	8.00	Complies
6	2437 MHz	-1.37	4.67	8.00	Complies
11	2462 MHz	-7.63	4.35	8.00	Complies

<MCS8, Ant. 1+2+3, CDD>

Channel	Frequency	Total Power Density (dBm/10kHz)	Antenna Gain (dBi)	Max. Limit (dBm/10kHz)	Result
1	2412 MHz	-6.36	5.34	8.00	Complies
6	2437 MHz	-0.78	4.67	8.00	Complies
11	2462 MHz	-6.43	4.35	8.00	Complies

Power Density Plot on Configuration of IEEE 802.11n 20MHz MCS0 / CH 1 / Ant. 3

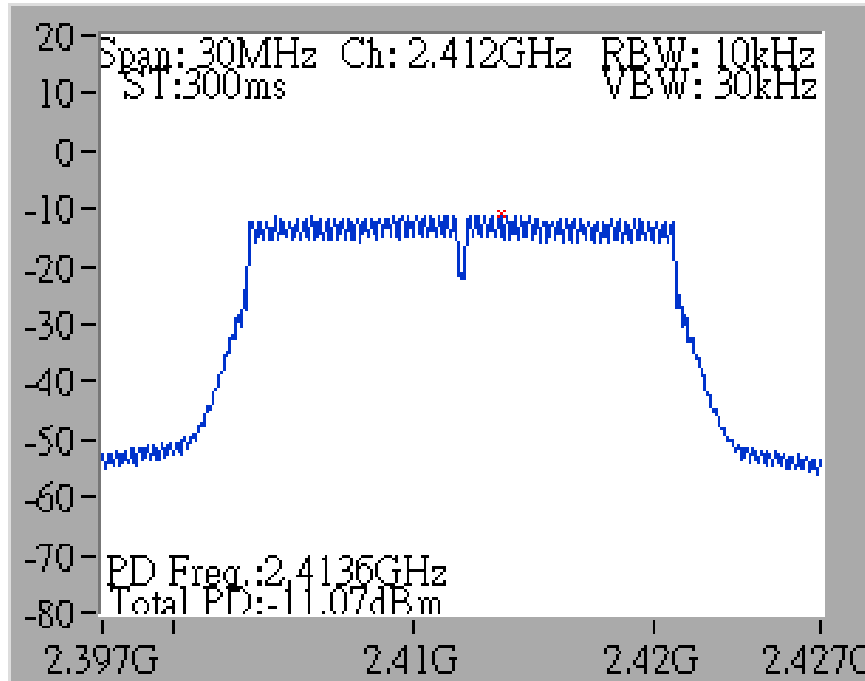

Power Density Plot on Configuration of IEEE 802.11n 20MHz MCS0 / CH 6 / Ant. 3

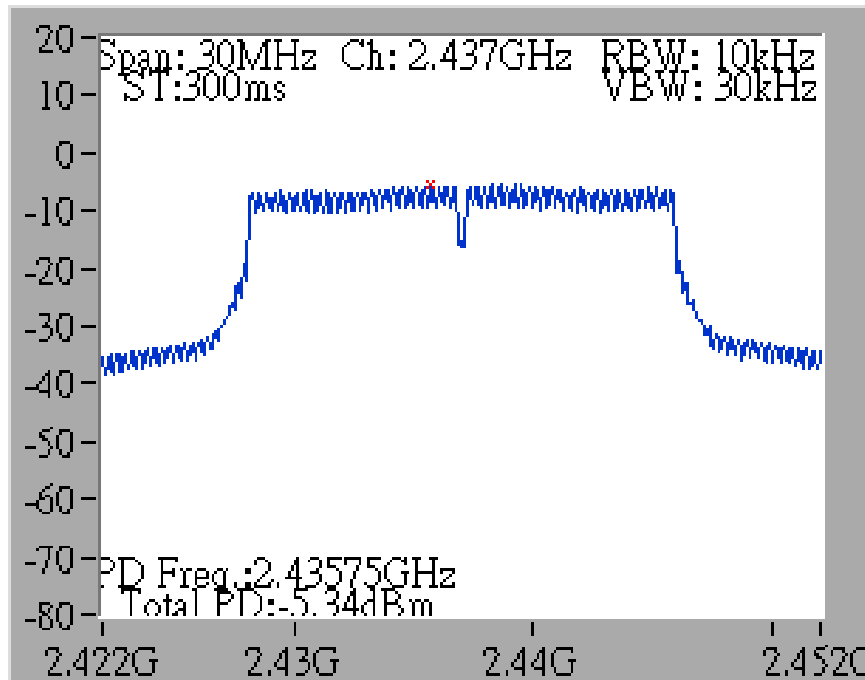

Power Density Plot on Configuration of IEEE 802.11n 20MHz MCS0 / CH 11 / Ant. 3

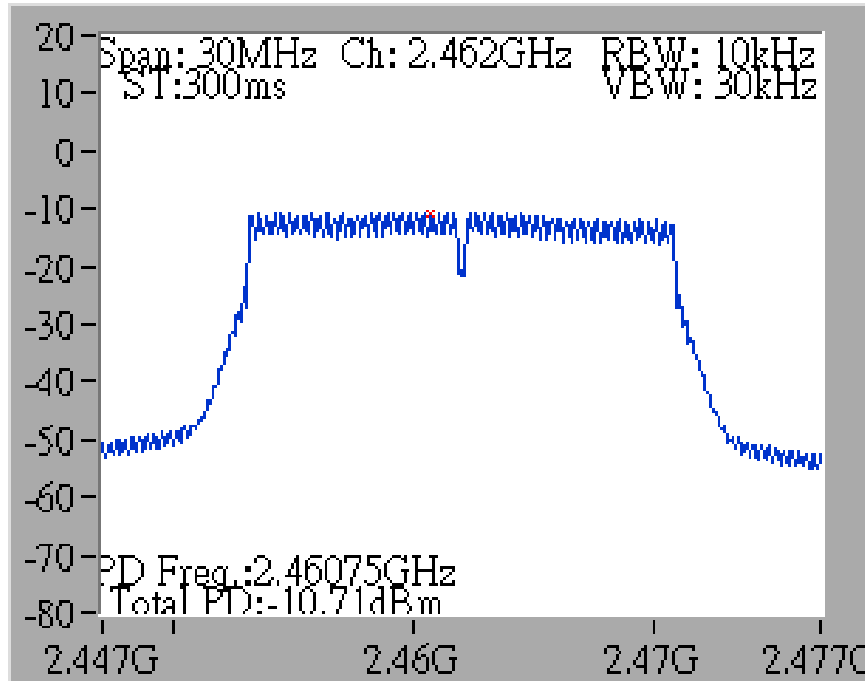

Power Density Plot on Configuration of IEEE 802.11n 20MHz MCS0 / CH 1 / Ant. 1+2+3

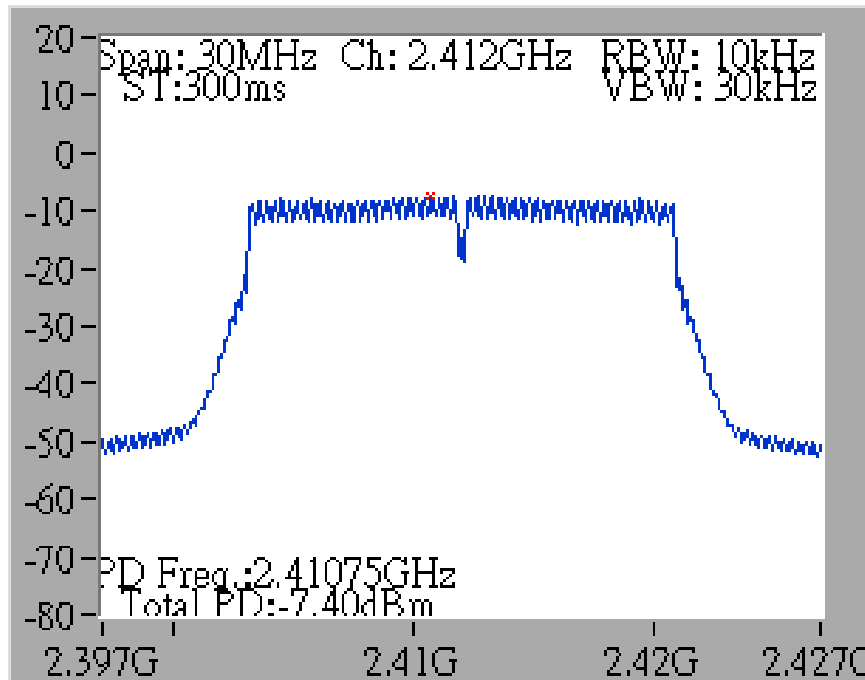

Power Density Plot on Configuration of IEEE 802.11n 20MHz MCS0 / CH 6 / Ant. 1+2+3

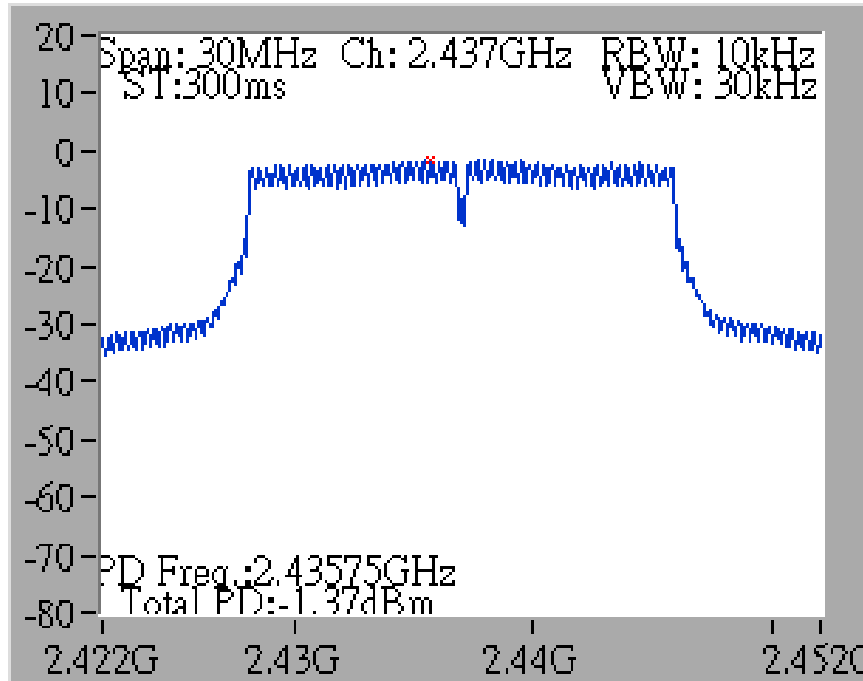

Power Density Plot on Configuration of IEEE 802.11n 20MHz MCS0 / CH 11 / Ant. 1+2+3

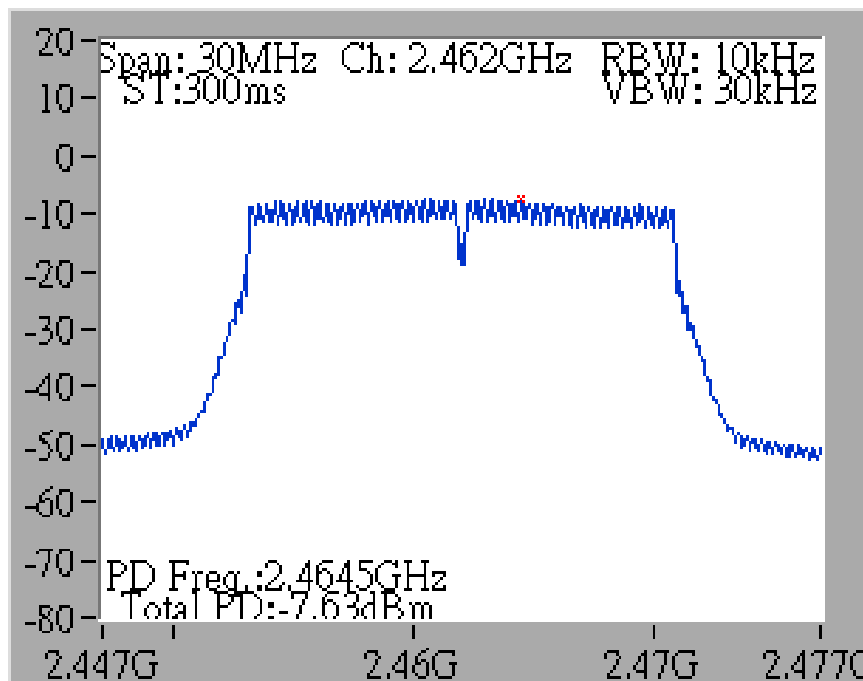

Power Density Plot on Configuration of IEEE 802.11n 20MHz MCS8 / CH 1 / Ant. 1+2+3

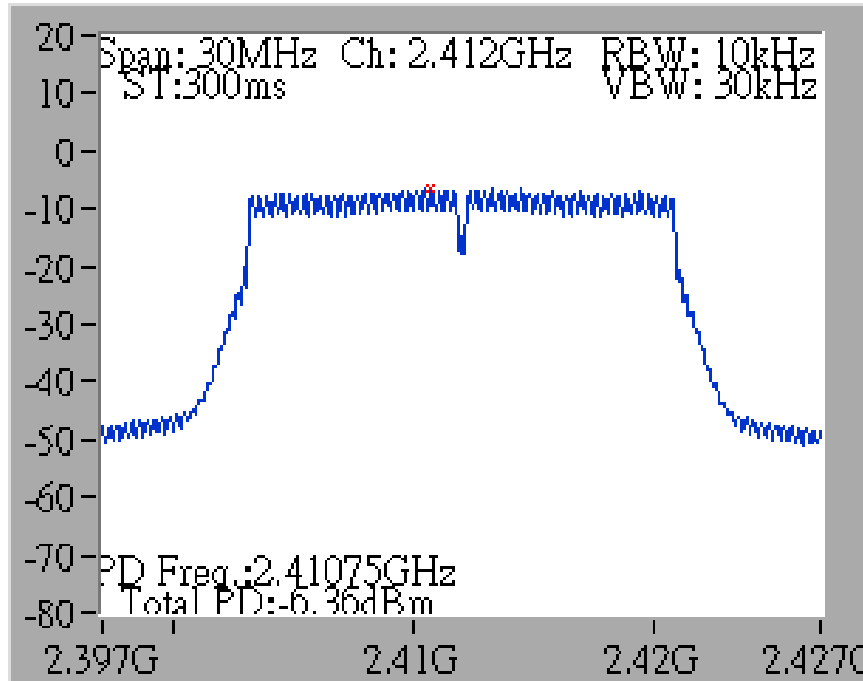

Power Density Plot on Configuration of IEEE 802.11n 20MHz MCS8 / CH 6 / Ant. 1+2+3

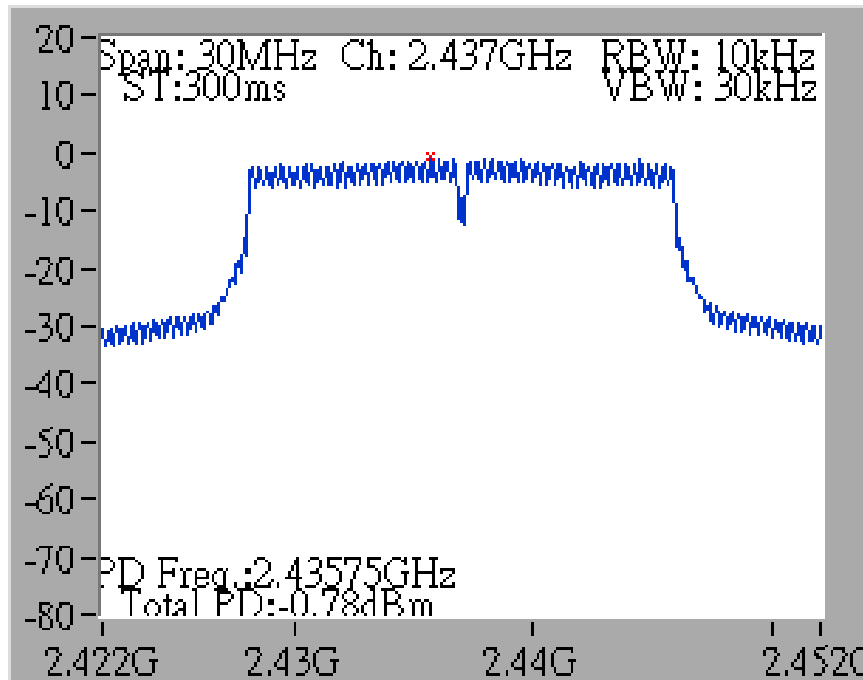

Power Density Plot on Configuration of IEEE 802.11n 20MHz MCS8 / CH 11 / Ant. 1+2+3

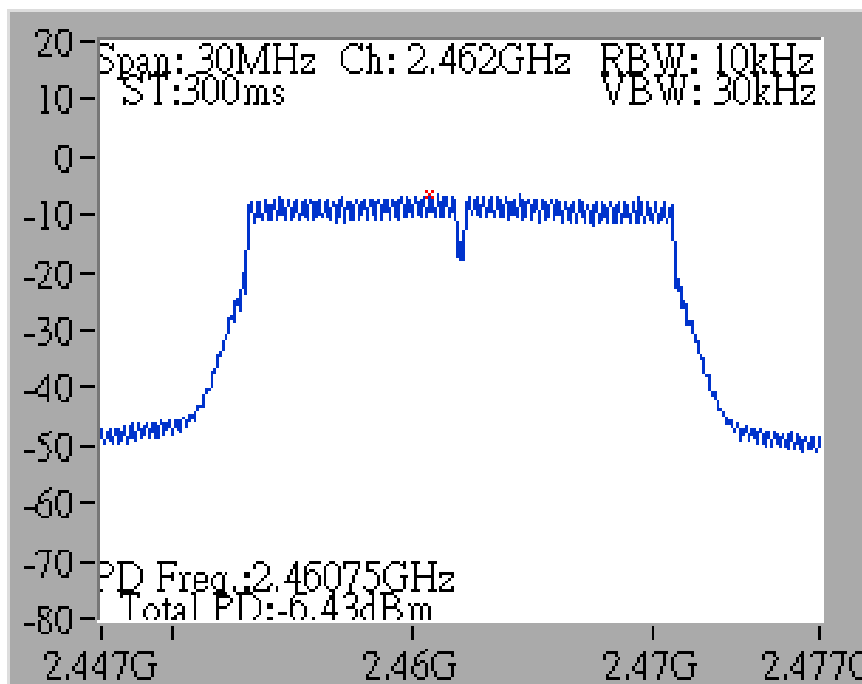

Test date	Jan. 27, 2014	Test Site No.	TH01-CB
Temperature	26°C	Humidity	63%
Test Engineer	Magic Lai	Configuration	802.11n
Duty Cycle	Ant.1, 2, 3: 96.88% MCS0, Ant.1+2+3, CDD: 97.92% MCS8, Ant.1+2+3, CDD: 94.23%		

Configuration IEEE 802.11n 40MHz

<MCS0, Ant. 1>

Channel	Frequency	Total Power Density (dBm/10kHz)	Antenna Gain (dBi)	Max. Limit (dBm/10kHz)	Result
3	2422 MHz	-14.80	3.57	8.00	Complies
6	2437 MHz	-11.62	3.51	8.00	Complies
9	2452 MHz	-14.42	3.66	8.00	Complies

<MCS0, Ant. 1+2+3, CDD>

Channel	Frequency	Total Power Density (dBm/10kHz)	Antenna Gain (dBi)	Max. Limit (dBm/10kHz)	Result
3	2422 MHz	-12.63	5.07	8.00	Complies
6	2437 MHz	-9.02	4.67	8.00	Complies
9	2452 MHz	-12.39	4.46	8.00	Complies

<MCS8, Ant. 1+2+3, CDD>

Channel	Frequency	Total Power Density (dBm/10kHz)	Antenna Gain (dBi)	Max. Limit (dBm/10kHz)	Result
3	2422 MHz	-10.63	5.07	8.00	Complies
6	2437 MHz	-7.02	4.67	8.00	Complies
9	2452 MHz	-10.29	4.46	8.00	Complies

Power Density Plot on Configuration of IEEE 802.11n 40MHz MCS0 / CH 3 / Ant. 1

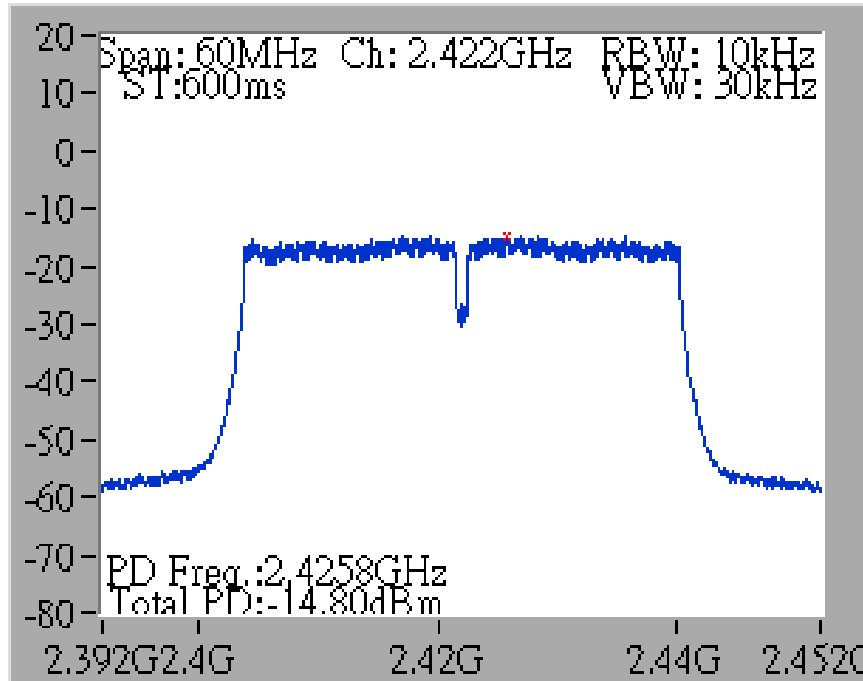

Power Density Plot on Configuration of IEEE 802.11n 40MHz MCS0 / CH 6 / Ant. 1

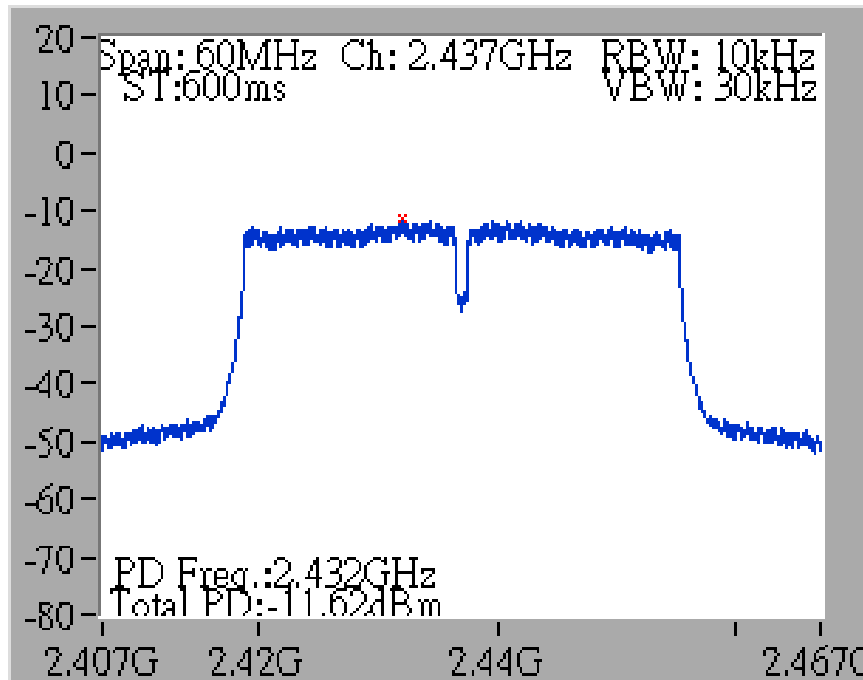

Power Density Plot on Configuration of IEEE 802.11n 40MHz MCS0 / CH 9 / Ant. 1

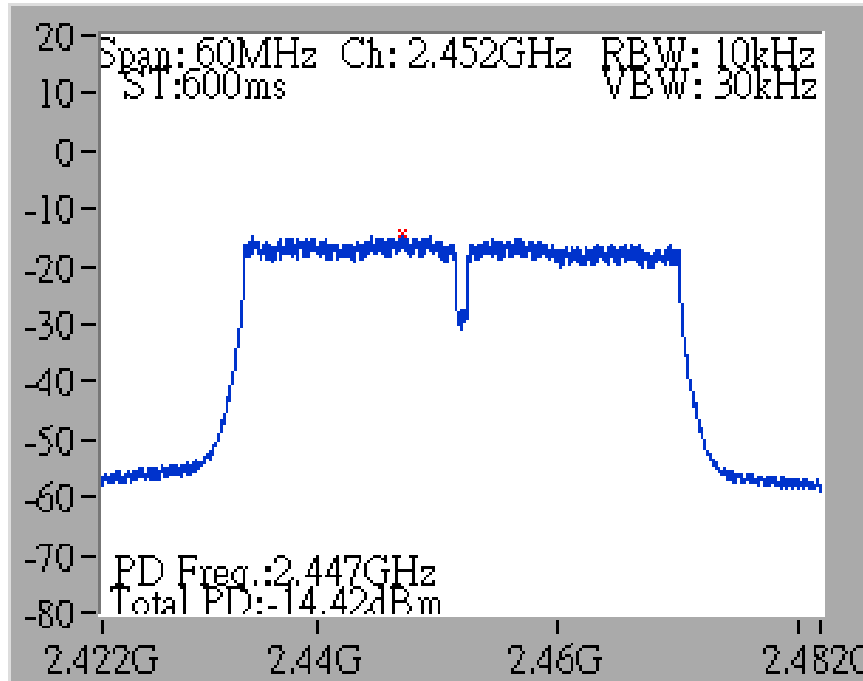

Power Density Plot on Configuration of IEEE 802.11n 40MHz MCS0 / CH 3 / Ant. 1+2+3

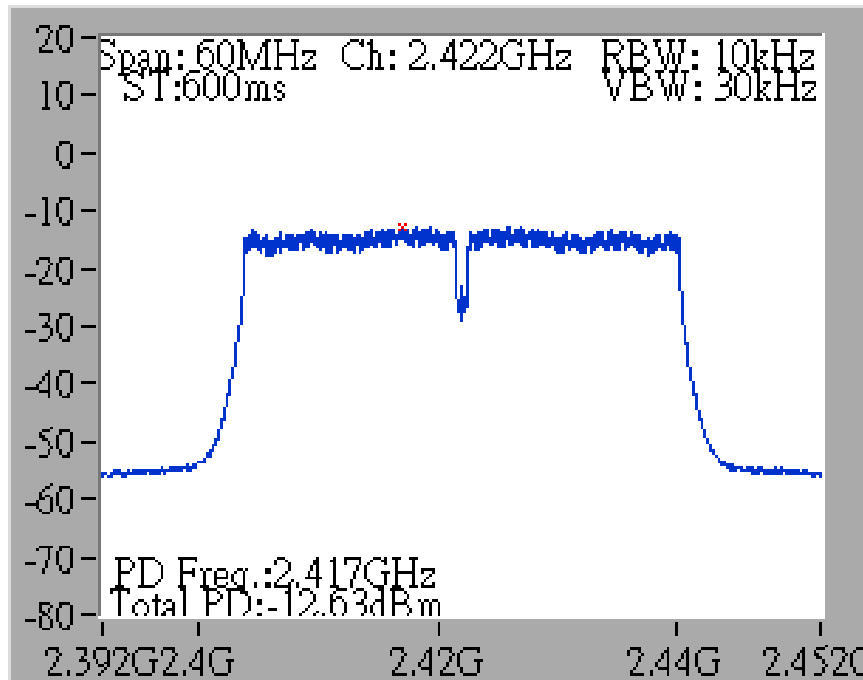

Power Density Plot on Configuration of IEEE 802.11n 40MHz MCS0 / CH 6 / Ant. 1+2+3

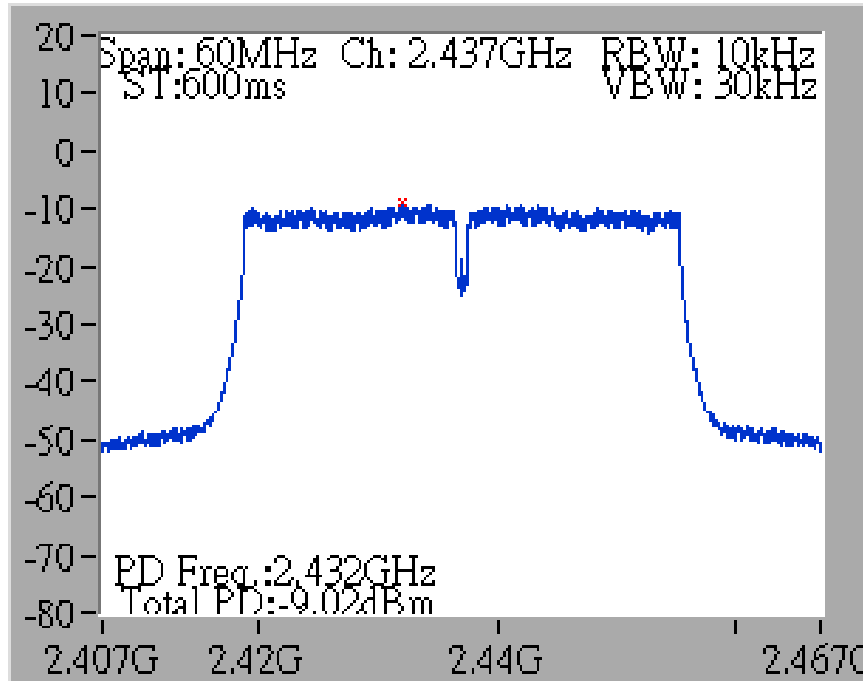

Power Density Plot on Configuration of IEEE 802.11n 40MHz MCS0 / CH 9 / Ant. 1+2+3

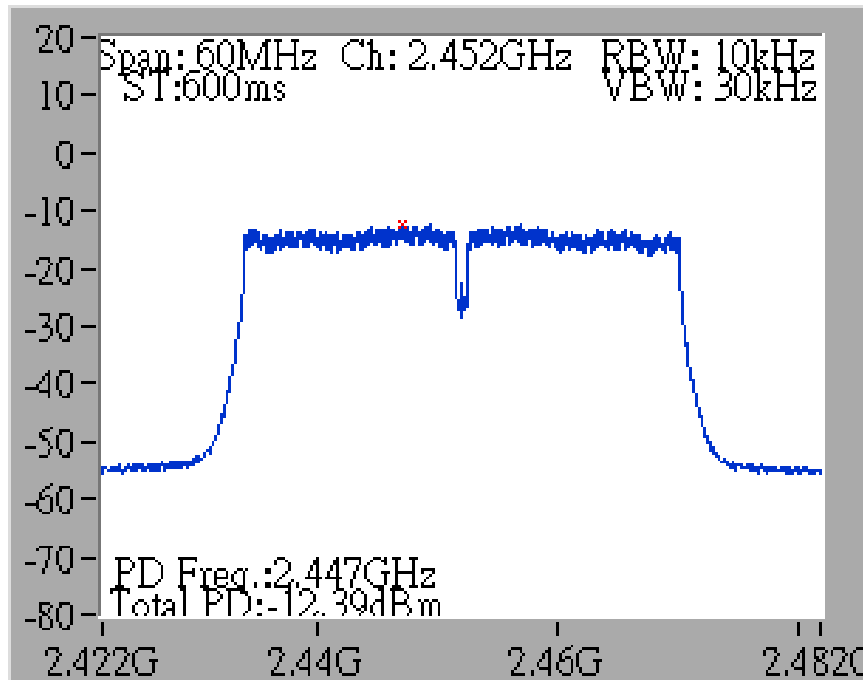

Power Density Plot on Configuration of IEEE 802.11n 40MHz MCS8 / CH 3 / Ant. 1+2+3

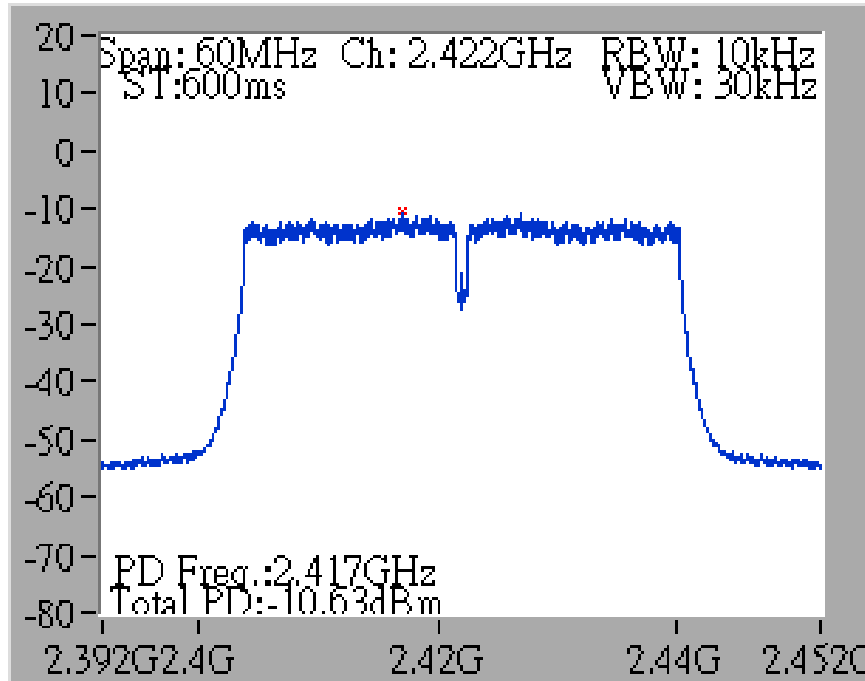

Power Density Plot on Configuration of IEEE 802.11n 40MHz MCS8 / CH 6 / Ant. 1+2+3

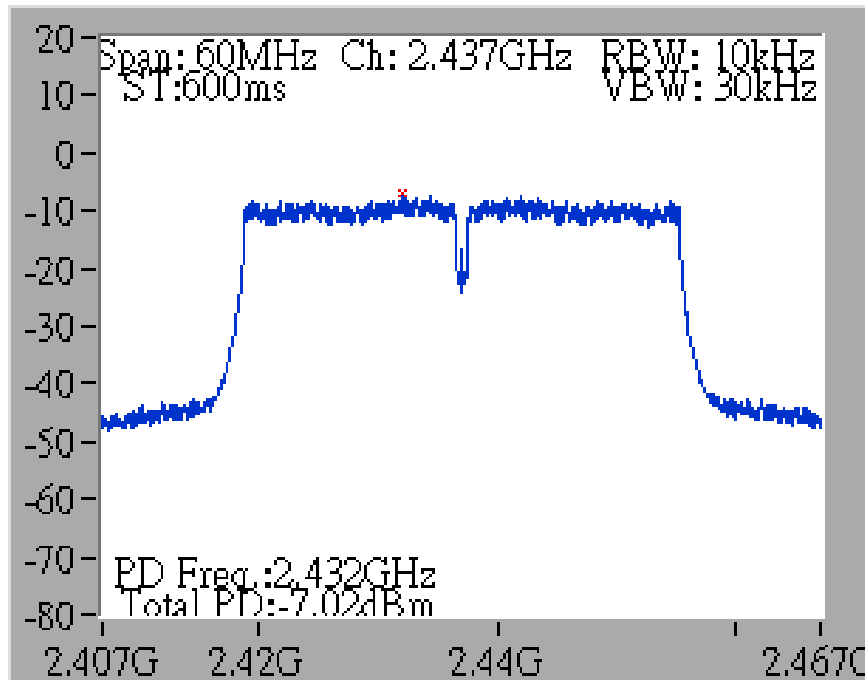

Power Density Plot on Configuration of IEEE 802.11n 40MHz MCS8 / CH 9 / Ant. 1+2+3

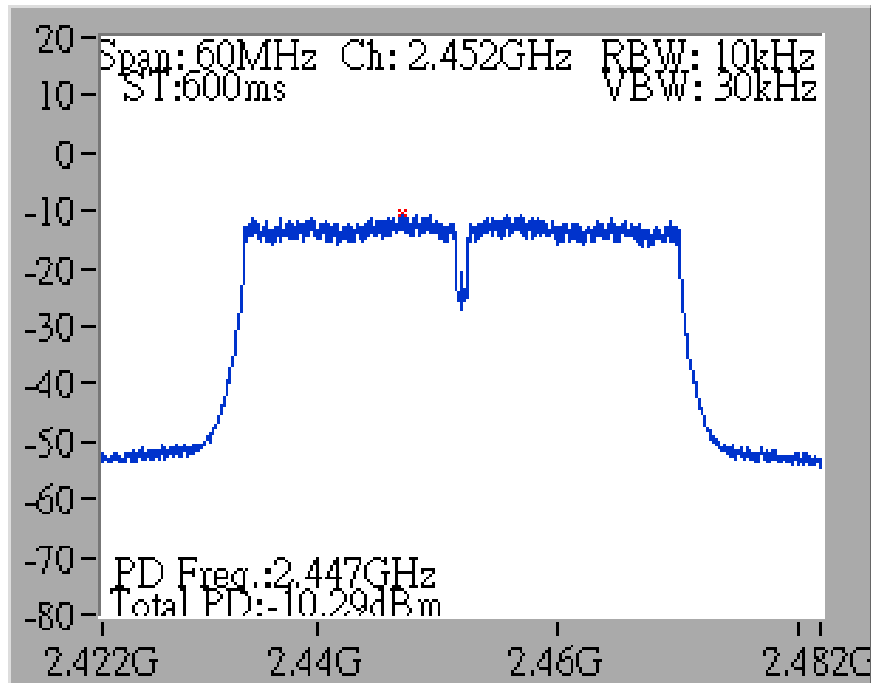

3.4. 6dB Spectrum Bandwidth Measurement

3.4.1. Limit

For digital modulation systems, the minimum 6dB bandwidth shall be at least 500 kHz.

3.4.2. Measuring Instruments and Setting

The following table is the setting of the spectrum analyzer.

Spectrum Parameters	Setting
Attenuation	Auto
Span Frequency	> 6dB Bandwidth
RBW	1-5 % of the emission bandwidth (EBW)
VBW	≥ 3 x RBW
Detector	Peak
Trace	Max Hold
Sweep Time	Auto

3.4.3. Test Procedures

1. The transmitter output (antenna port) was connected to the spectrum analyzer in peak hold mode.
2. The resolution bandwidth of 1-5 % of the emission bandwidth (EBW) and the video bandwidth of ≥ 3 x RBW were used.
3. Measured the spectrum width with power higher than 6d account by this measurement.

3.4.4. Test Setup Layout

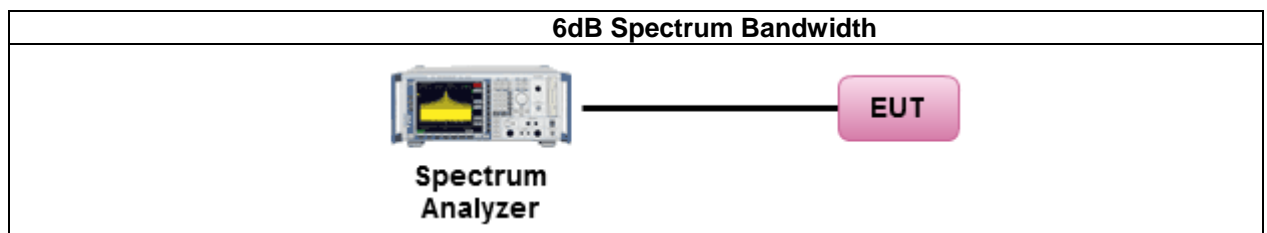

3.4.5. Test Deviation

There is no deviation with the original standard.

3.4.6. EUT Operation during Test

The EUT was programmed to be in continuously transmitting mode.

3.4.7. Test Result of 6dB Spectrum Bandwidth

Test date	Jan. 27, 2014	Test Site No.	TH01-CB
Temperature	26°C	Humidity	63%
Test Engineer	Magic Lai	Configuration	802.11b
Duty Cycle	Ant.1, 2, 3: 100% Ant.1+2+3: 100%		

Configuration IEEE 802.11b

<Ant. 1>

Channel	Frequency	6dB Bandwidth (MHz)	99% Occupied Bandwidth (MHz)	Min. Limit (kHz)	Test Result
1	2412 MHz	8.16	12.08	500	Complies
6	2437 MHz	8.64	12.08	500	Complies
11	2462 MHz	8.64	12.16	500	Complies

<Ant. 1+2+3, CDD>

Channel	Frequency	6dB Bandwidth (MHz)			99% Occupied Bandwidth (MHz)			Min. Limit (kHz)	Test Result
		Ant. 1	Ant. 2	Ant. 3	Ant. 1	Ant. 2	Ant. 3		
1	2412 MHz	8.56	8.48	8.08	12.08	11.92	12.00	500	Complies
6	2437 MHz	8.56	8.16	8.56	11.76	11.76	11.76	500	Complies
11	2462 MHz	9.04	8.56	8.56	11.84	11.76	11.92	500	Complies

For <Ant. 1>

6 dB Bandwidth Plot on Configuration IEEE 802.11b / CH 1 / Ant. 1

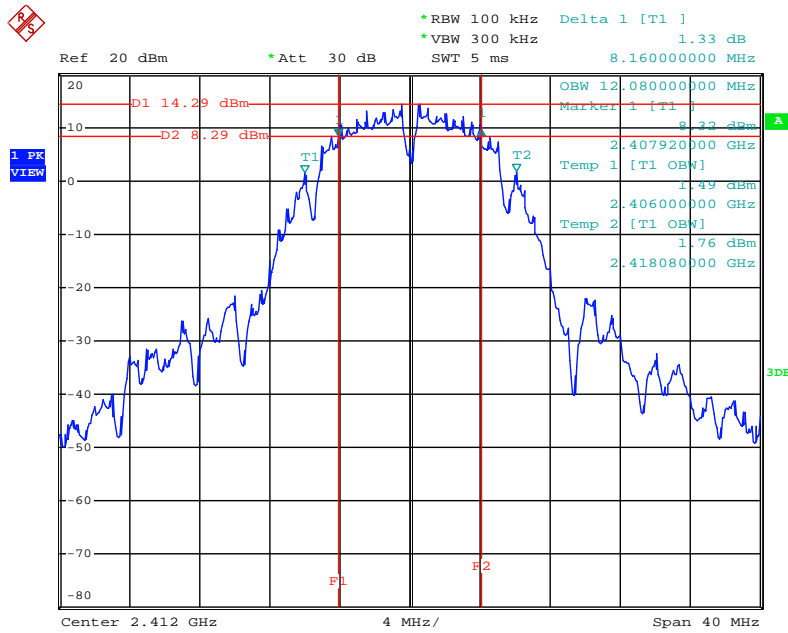

Date: 27.JAN.2014 09:50:55

6 dB Bandwidth Plot on Configuration IEEE 802.11b / CH 6 / Ant. 1

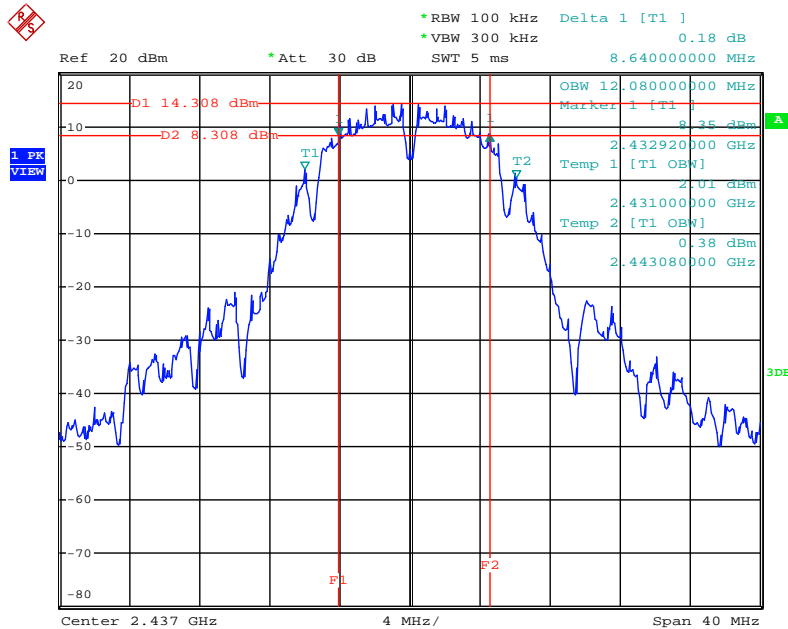

Date: 27.JAN.2014 09:52:12

6 dB Bandwidth Plot on Configuration IEEE 802.11b / CH 11 / Ant. 1

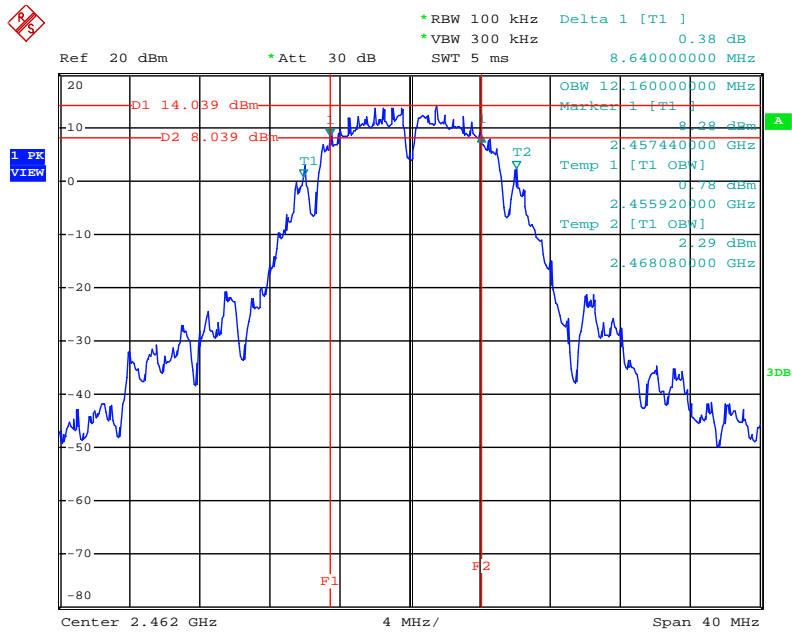

Date: 27.JAN.2014 09:53:01

For <Ant. 1+2+3, CDD>

6 dB Bandwidth Plot on Configuration IEEE 802.11b / CH 1 / Ant. 1

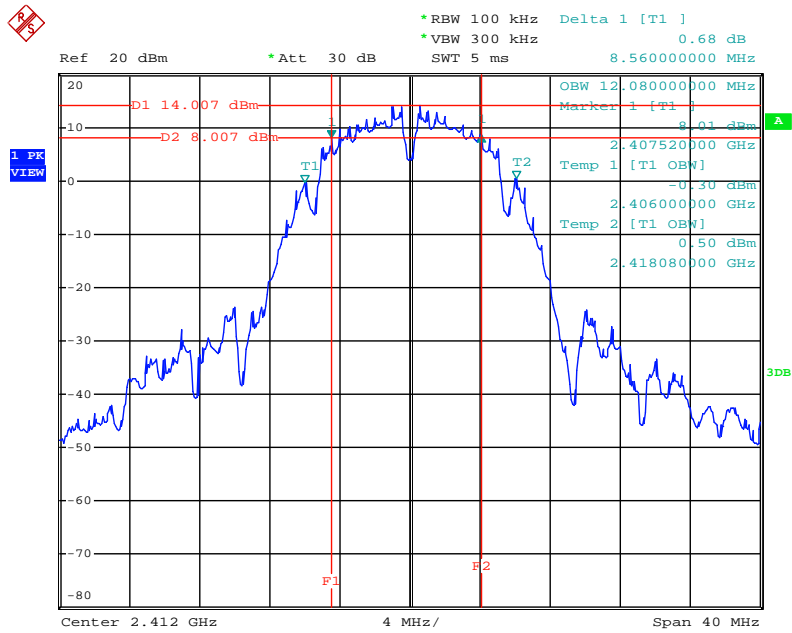

Date: 27.JAN.2014 10:03:01

6 dB Bandwidth Plot on Configuration IEEE 802.11b / CH 6 / Ant. 1

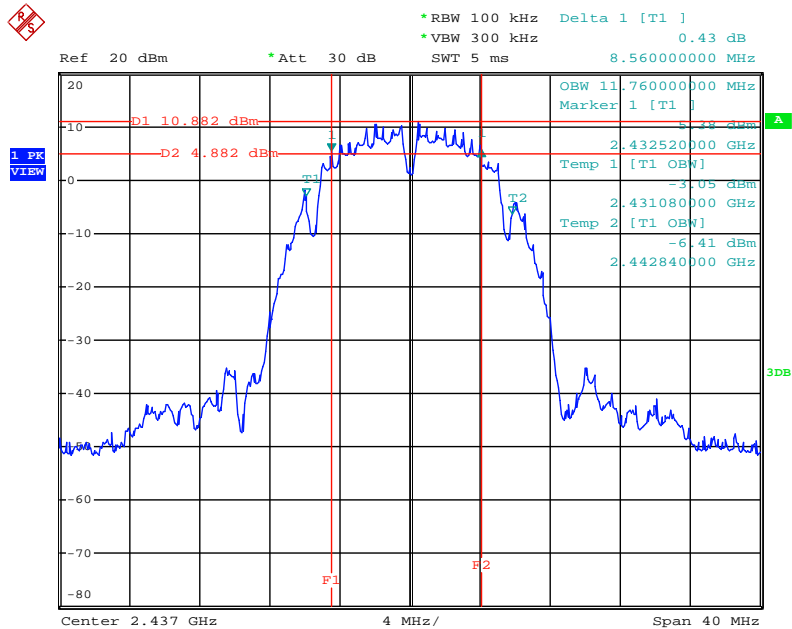

Date: 27.JAN.2014 10:07:59

6 dB Bandwidth Plot on Configuration IEEE 802.11b / CH 11 / Ant. 1

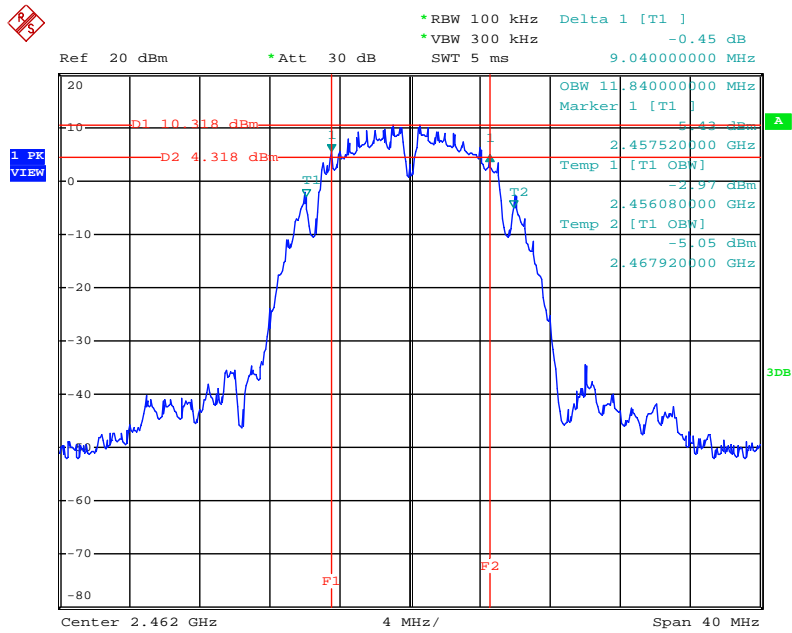

Date: 27.JAN.2014 10:08:51

6 dB Bandwidth Plot on Configuration IEEE 802.11b / CH 1 / Ant. 2

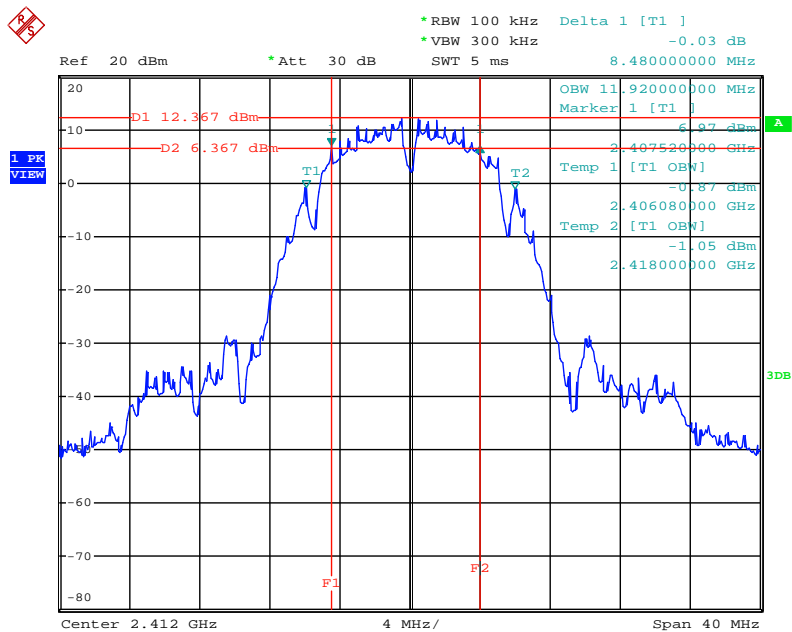

Date: 27.JAN.2014 10:03:43

6 dB Bandwidth Plot on Configuration IEEE 802.11b / CH 6 / Ant. 2

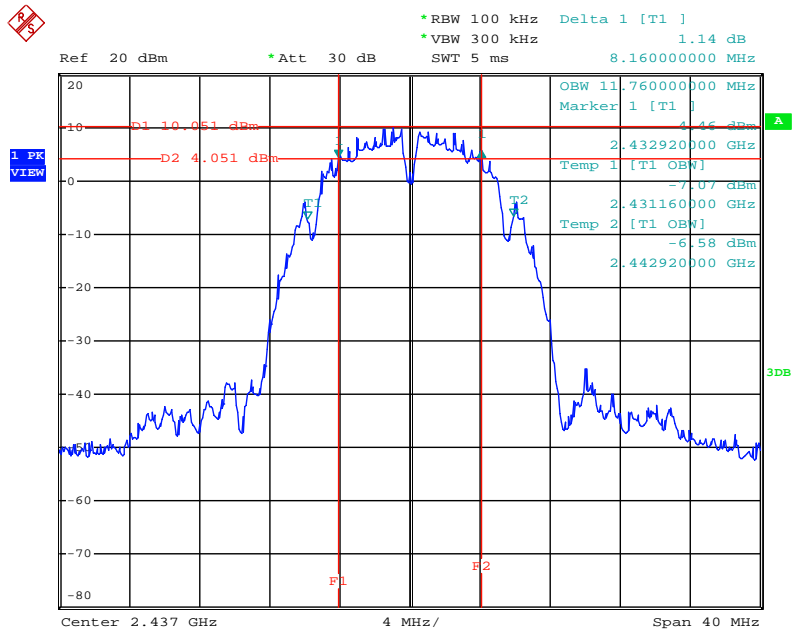

Date: 27.JAN.2014 10:06:12

6 dB Bandwidth Plot on Configuration IEEE 802.11b / CH 11 / Ant. 2

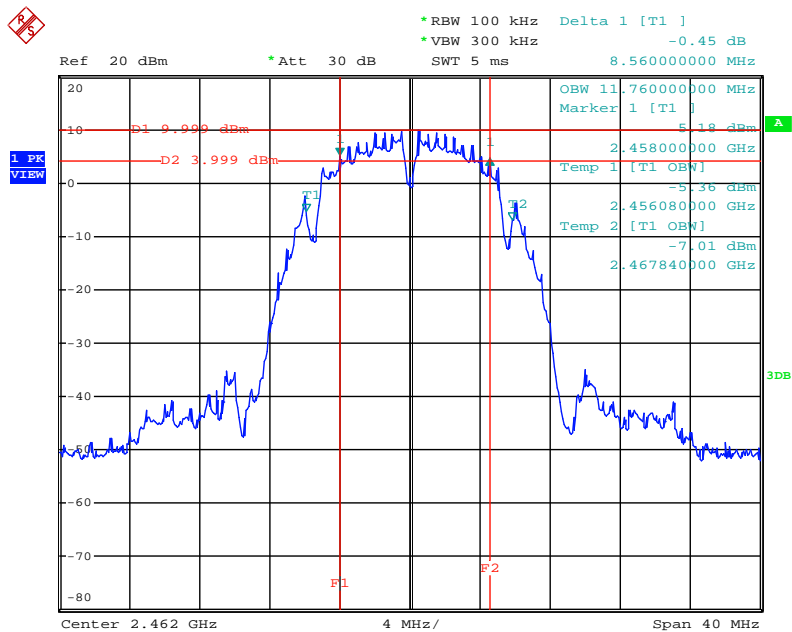

Date: 27.JAN.2014 10:09:32

6 dB Bandwidth Plot on Configuration IEEE 802.11b / CH 1 / Ant. 3

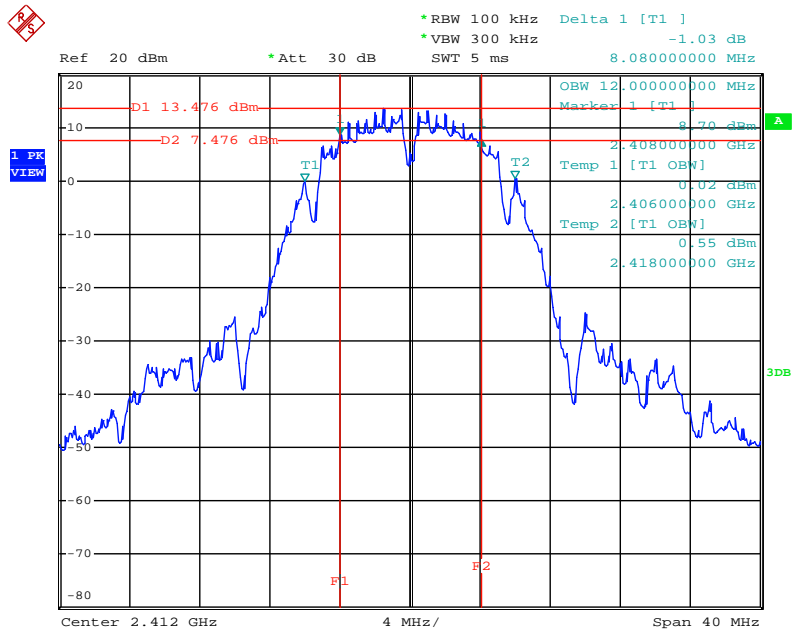

Date: 27.JAN.2014 10:04:23

6 dB Bandwidth Plot on Configuration IEEE 802.11b / CH 6 / Ant. 3

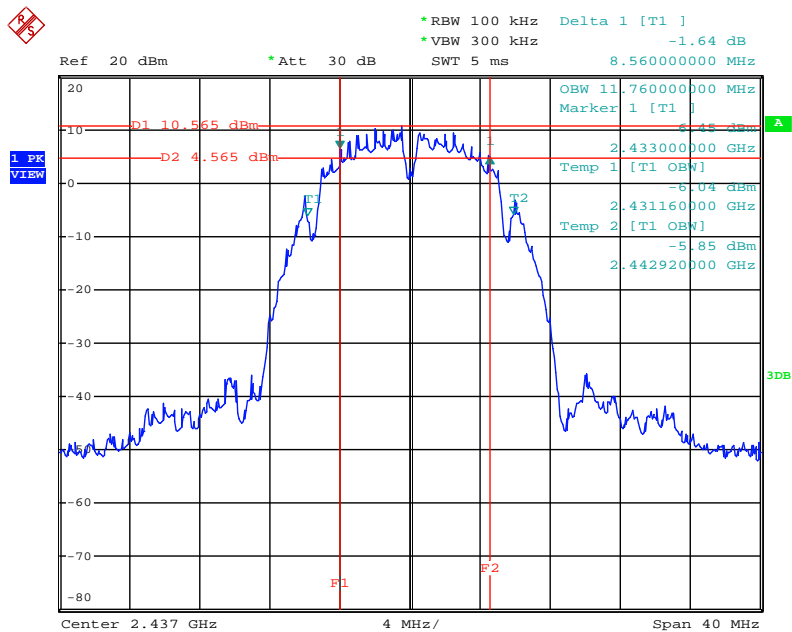

Date: 27.JAN.2014 10:05:39

6 dB Bandwidth Plot on Configuration IEEE 802.11b / CH 11 / Ant. 3

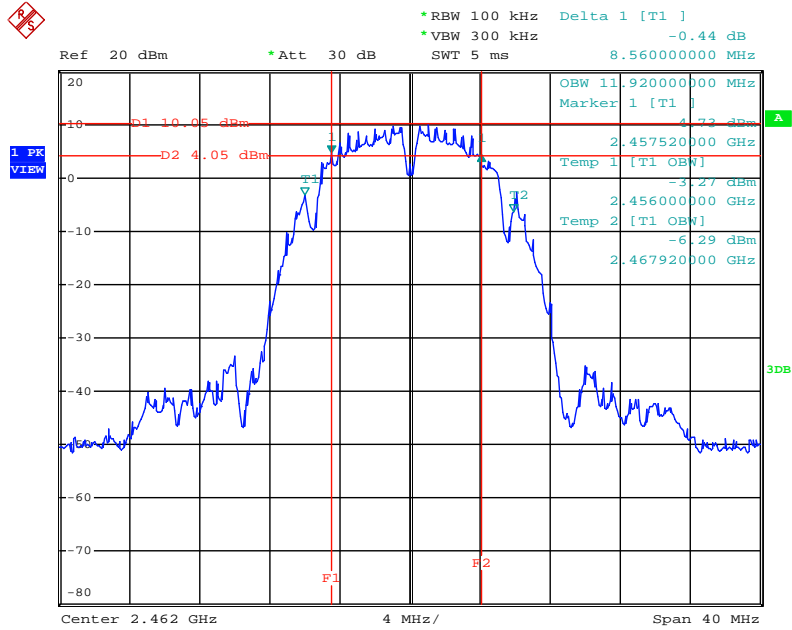

Date: 27.JAN.2014 10:10:08

Test date	Jan. 27, 2014	Test Site No.	TH01-CB
Temperature	26°C	Humidity	63%
Test Engineer	Magic Lai	Configuration	802.11g
Duty Cycle	Ant.1, 2, 3: 98.56% Ant.1+2+3: 99.04%		

Configuration IEEE 802.11g

<Ant. 1>

Channel	Frequency	6dB Bandwidth (MHz)	99% Occupied Bandwidth (MHz)	Min. Limit (kHz)	Test Result
1	2412 MHz	16.40	16.56	500	Complies
6	2437 MHz	16.32	16.72	500	Complies
11	2462 MHz	16.32	16.56	500	Complies

<Ant. 1+2+3, CDD>

Channel	Frequency	6dB Bandwidth (MHz)			99% Occupied Bandwidth (MHz)			Min. Limit (kHz)	Test Result
		Ant. 1	Ant. 2	Ant. 3	Ant. 1	Ant. 2	Ant. 3		
1	2412 MHz	16.40	16.40	16.40	16.56	16.48	16.56	500	Complies
6	2437 MHz	16.32	16.40	16.40	16.72	16.56	16.64	500	Complies
11	2462 MHz	16.40	16.40	16.32	16.48	16.56	16.48	500	Complies

For <Ant. 1>

6 dB Bandwidth Plot on Configuration IEEE 802.11g / CH 1 / Ant. 1

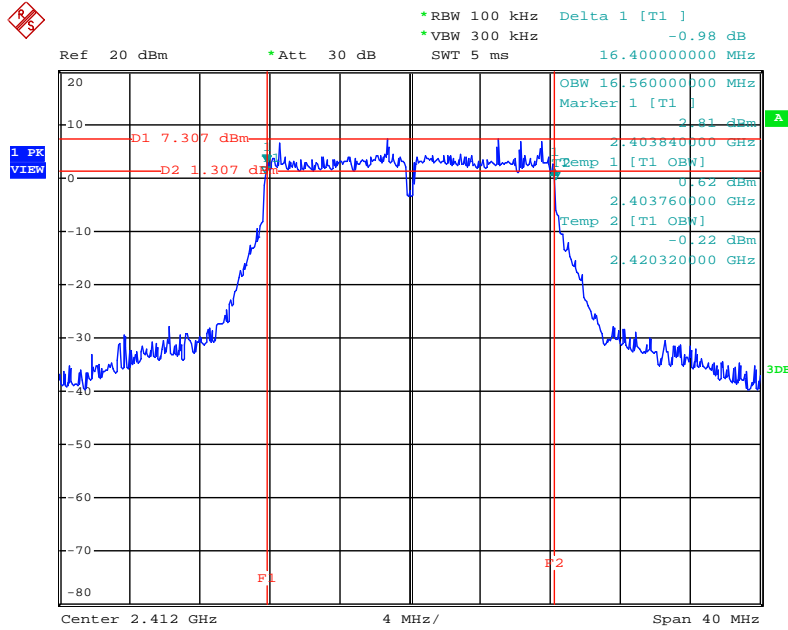

Date: 27.JAN.2014 09:54:24

6 dB Bandwidth Plot on Configuration IEEE 802.11g / CH 6 / Ant. 1

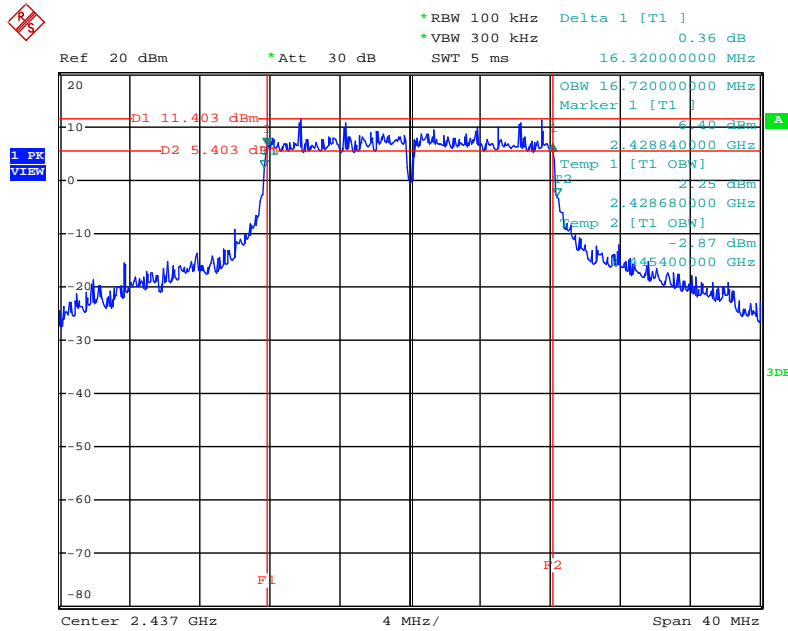

Date: 27.JAN.2014 09:55:32

6 dB Bandwidth Plot on Configuration IEEE 802.11g / CH 11 / Ant. 1

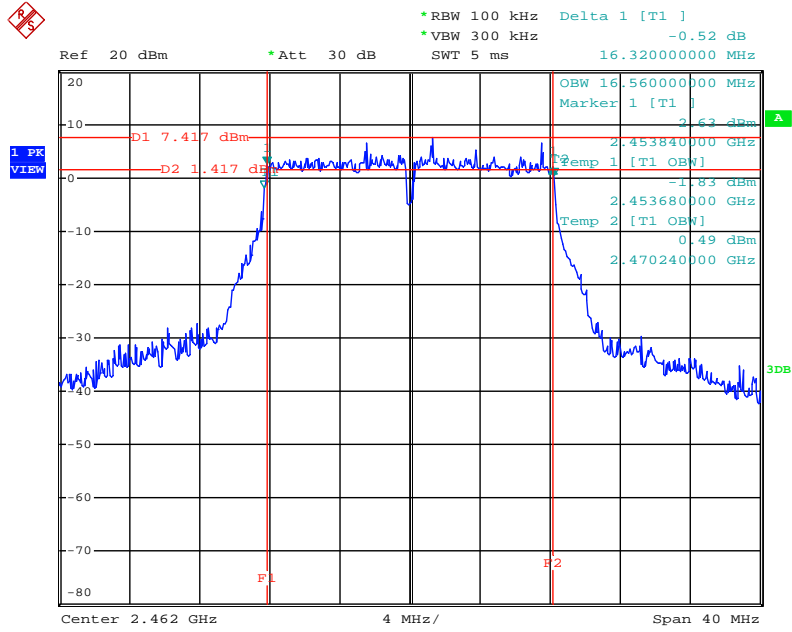

Date: 27.JAN.2014 09:56:21

For <Ant. 1+2+3, CDD>

6 dB Bandwidth Plot on Configuration IEEE 802.11g / CH 1 / Ant. 1

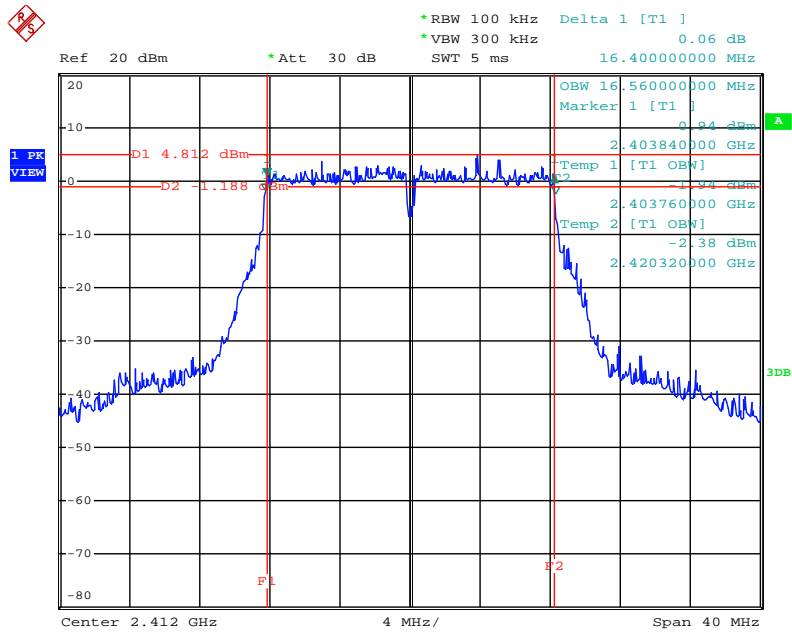

Date: 27.JAN.2014 10:13:00

6 dB Bandwidth Plot on Configuration IEEE 802.11g / CH 6 / Ant. 1

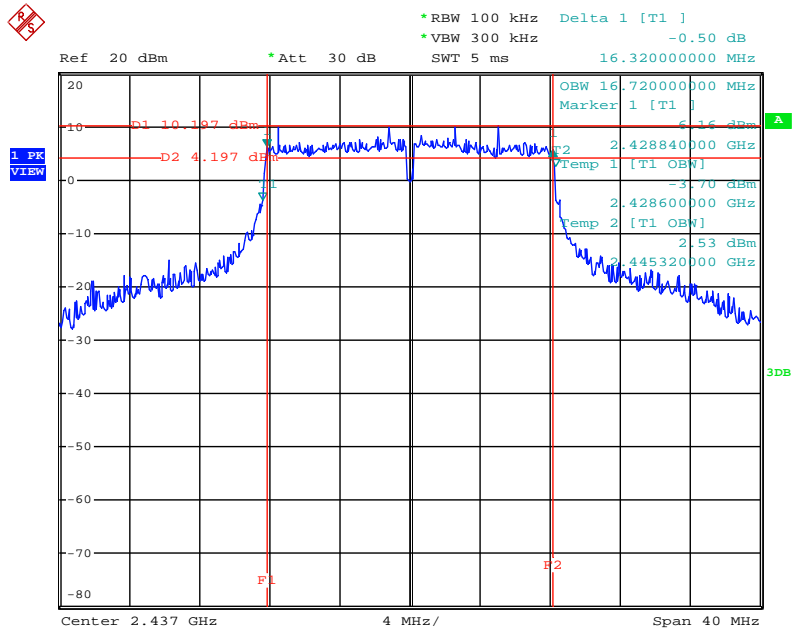

Date: 27.JAN.2014 10:16:15

6 dB Bandwidth Plot on Configuration IEEE 802.11g / CH 11 / Ant. 1

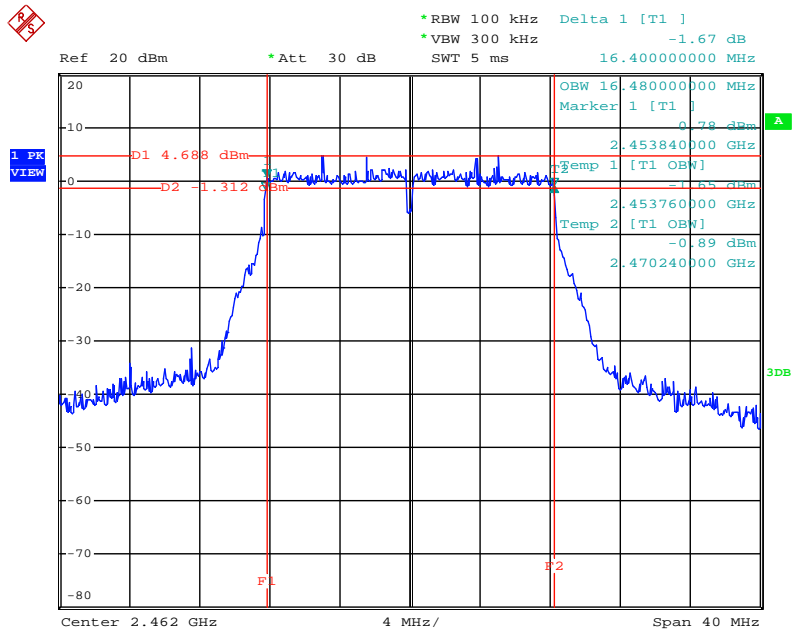

Date: 27.JAN.2014 10:17:14

6 dB Bandwidth Plot on Configuration IEEE 802.11g / CH 1 / Ant. 2

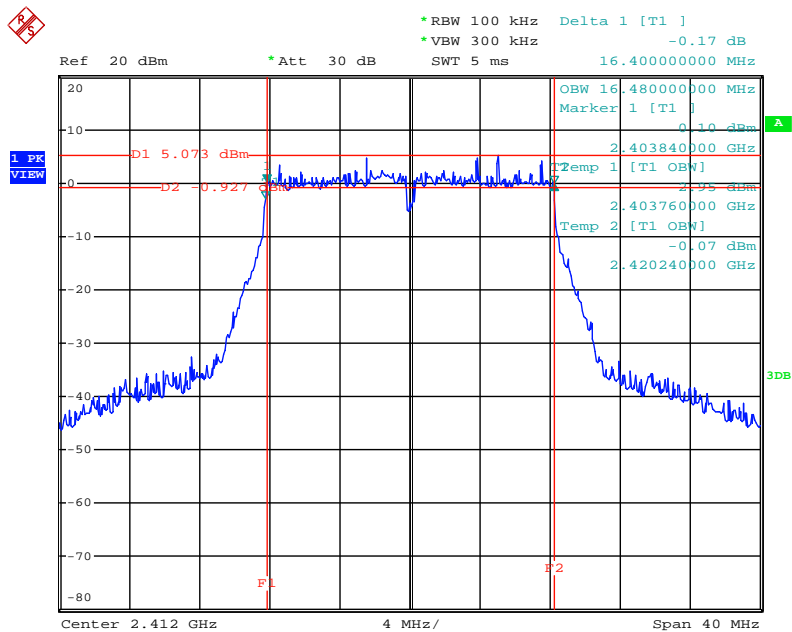

Date: 27.JAN.2014 10:12:28

6 dB Bandwidth Plot on Configuration IEEE 802.11g / CH 6 / Ant. 2

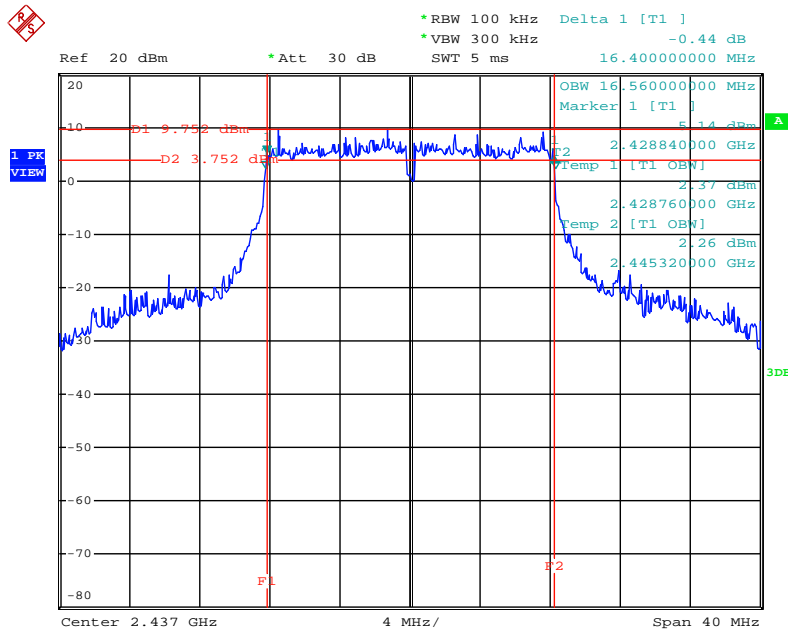

Date: 27.JAN.2014 10:15:29

6 dB Bandwidth Plot on Configuration IEEE 802.11g / CH 11 / Ant. 2

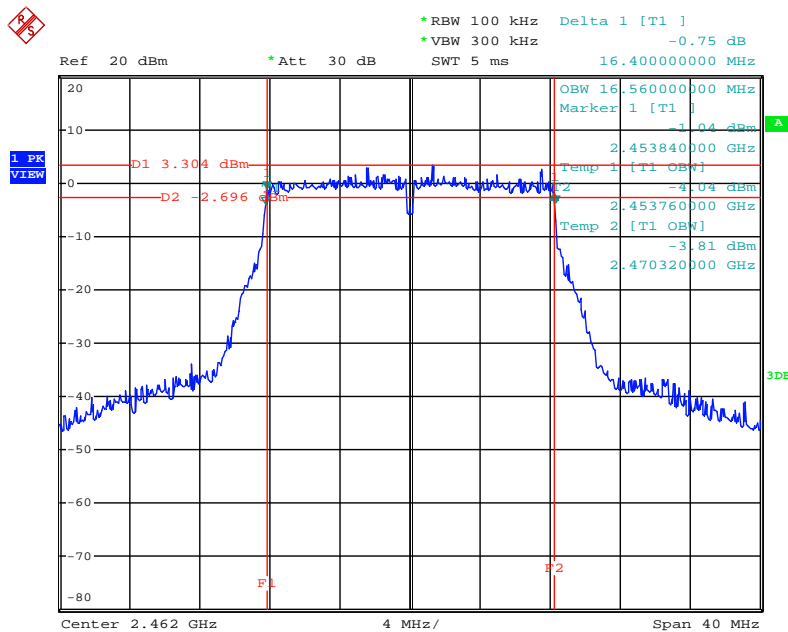

Date: 27.JAN.2014 10:18:03

6 dB Bandwidth Plot on Configuration IEEE 802.11g / CH 1 / Ant. 3

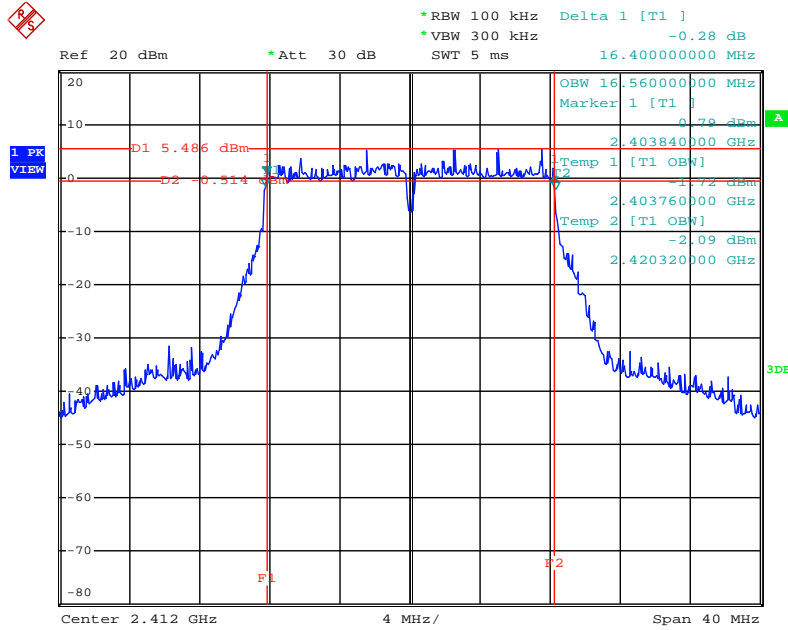

Date: 27.JAN.2014 10:11:49

6 dB Bandwidth Plot on Configuration IEEE 802.11g / CH 6 / Ant. 3

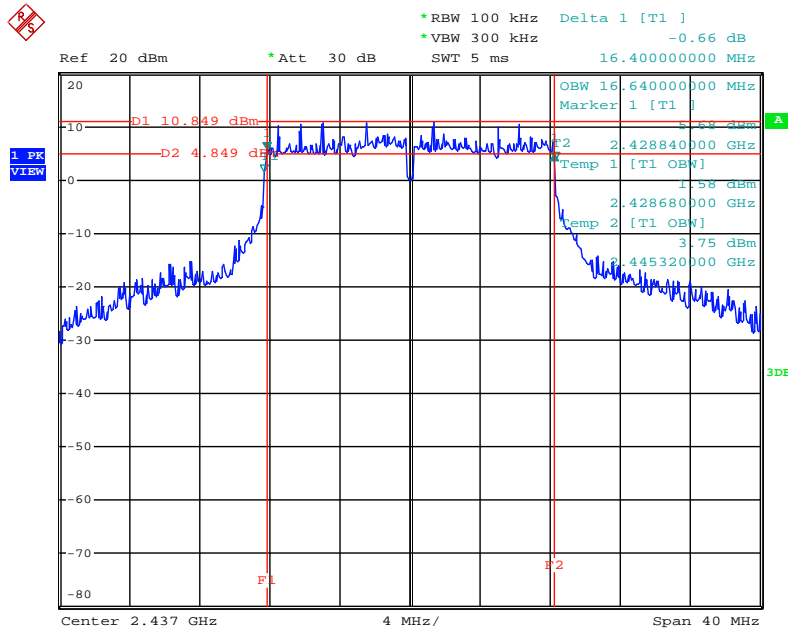

Date: 27.JAN.2014 10:14:21

6 dB Bandwidth Plot on Configuration IEEE 802.11g / CH 11 / Ant. 3

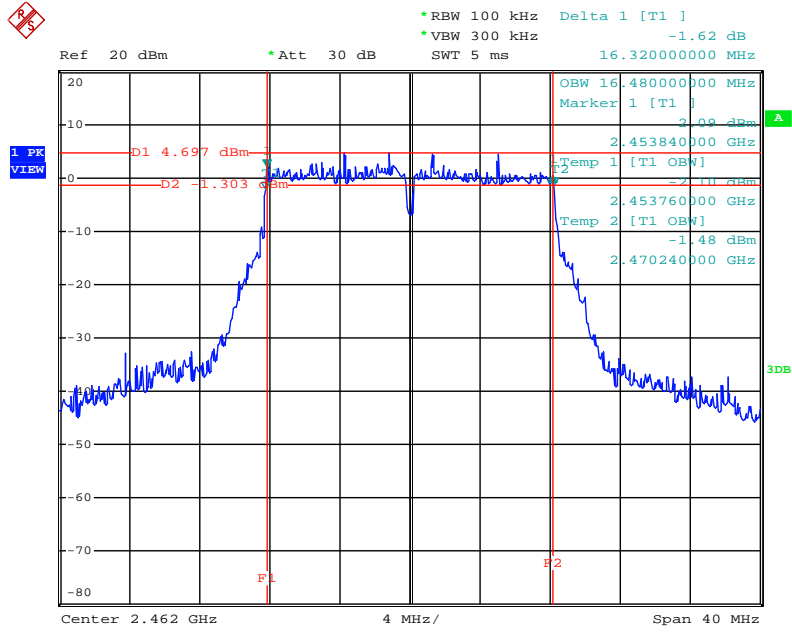

Date: 27.JAN.2014 10:18:42

Test date	Jan. 27, 2014	Test Site No.	TH01-CB
Temperature	26°C	Humidity	63%
Test Engineer	Magic Lai	Configuration	802.11n
Duty Cycle	Ant.1, 2, 3: 98.77% MCS0, Ant.1+2+3, CDD: 98.77% MCS8, Ant.1+2+3, CDD: 97%		

Configuration IEEE 802.11n 20MHz

<MCS0, Ant. 3>

Channel	Frequency	6dB Bandwidth (MHz)	99% Occupied Bandwidth (MHz)	Min. Limit (kHz)	Test Result
1	2412 MHz	17.60	17.76	500	Complies
6	2437 MHz	17.60	17.84	500	Complies
11	2462 MHz	17.60	17.76	500	Complies

<MCS0, Ant. 1+2+3, CDD>

Channel	Frequency	6dB Bandwidth (MHz)			99% Occupied Bandwidth (MHz)			Min. Limit (kHz)	Test Result
		Ant. 1	Ant. 2	Ant. 3	Ant. 1	Ant. 2	Ant. 3		
1	2412 MHz	17.60	17.60	17.60	17.68	17.68	17.76	500	Complies
6	2437 MHz	17.60	17.60	17.68	17.84	17.76	17.84	500	Complies
11	2462 MHz	17.60	17.68	17.60	17.76	17.68	17.76	500	Complies

<MCS8, Ant. 1+2+3, CDD>

Channel	Frequency	6dB Bandwidth (MHz)			99% Occupied Bandwidth (MHz)			Min. Limit (kHz)	Test Result
		Ant. 1	Ant. 2	Ant. 3	Ant. 1	Ant. 2	Ant. 3		
1	2412 MHz	17.68	17.60	17.60	17.76	17.68	17.76	500	Complies
6	2437 MHz	17.60	17.60	17.68	17.84	17.76	17.84	500	Complies
11	2462 MHz	17.60	17.60	17.60	17.76	17.68	17.76	500	Complies

For <Ant. 3>

6 dB Bandwidth Plot on Configuration of IEEE 802.11n 20MHz MCS0 / CH1 / Ant. 3

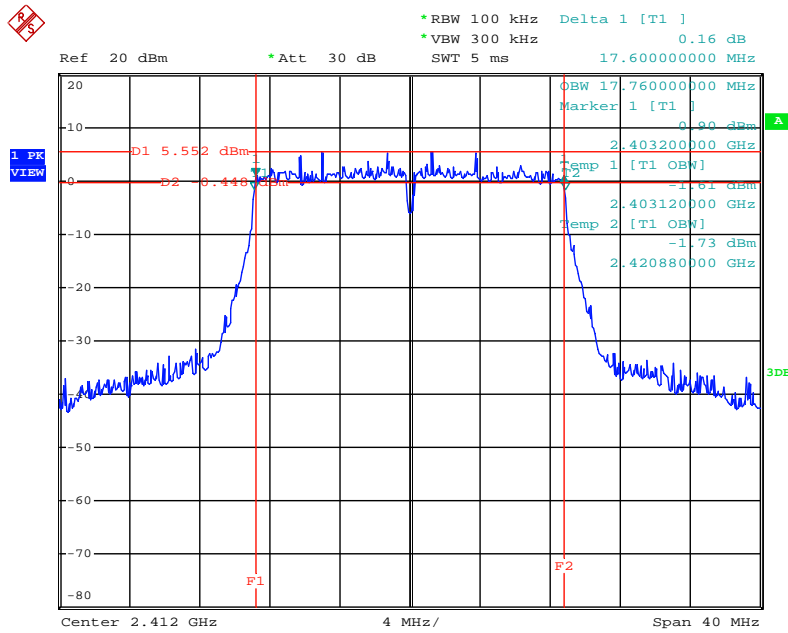

Date: 27.JAN.2014 11:02:47

6 dB Bandwidth Plot on Configuration of IEEE 802.11n 20MHz MCS0 / CH 6 / Ant. 3

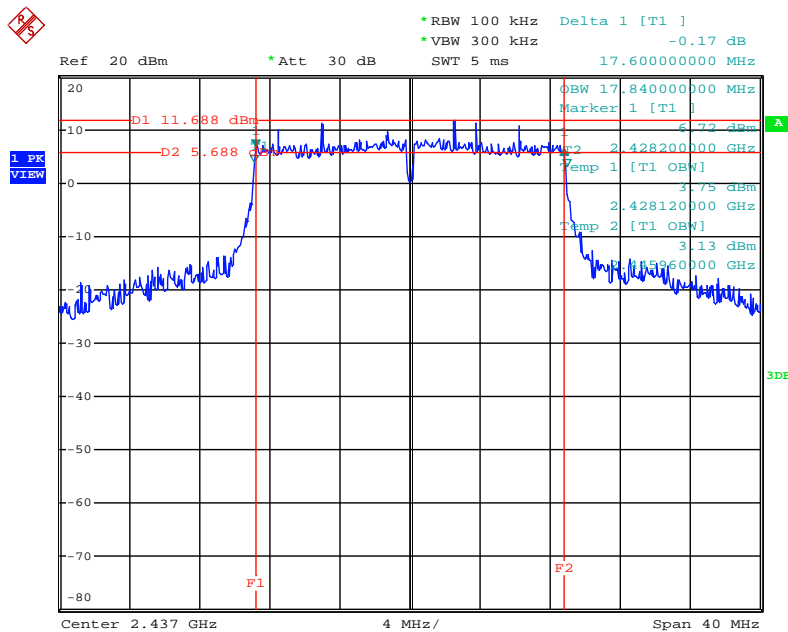

Date: 27.JAN.2014 11:03:40

6 dB Bandwidth Plot on Configuration of IEEE 802.11n 20MHz MCS0 / CH 11 / Ant. 3

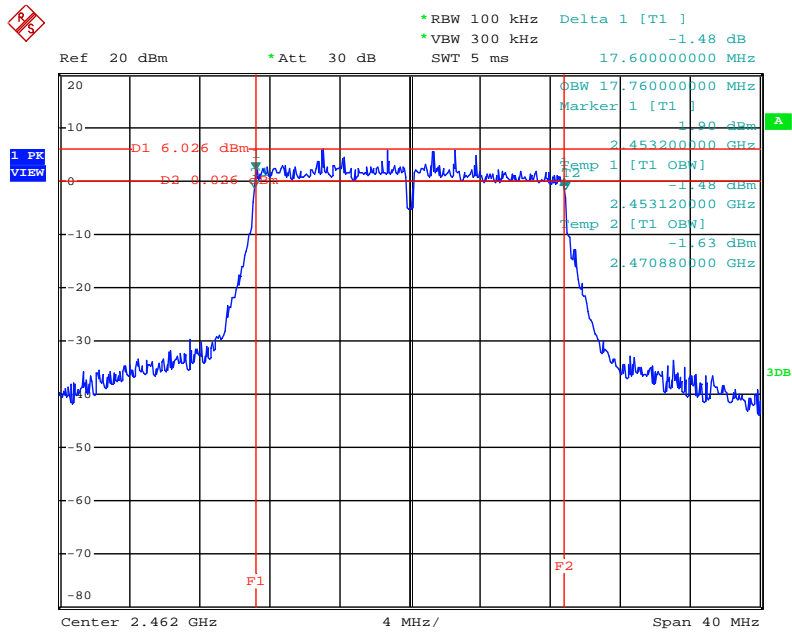

Date: 27.JAN.2014 11:04:38

<MCS0, Ant. 1+2+3, CDD>

6 dB Bandwidth Plot on Configuration of IEEE 802.11n 20MHz MCS0 / CH 1 / Ant. 1

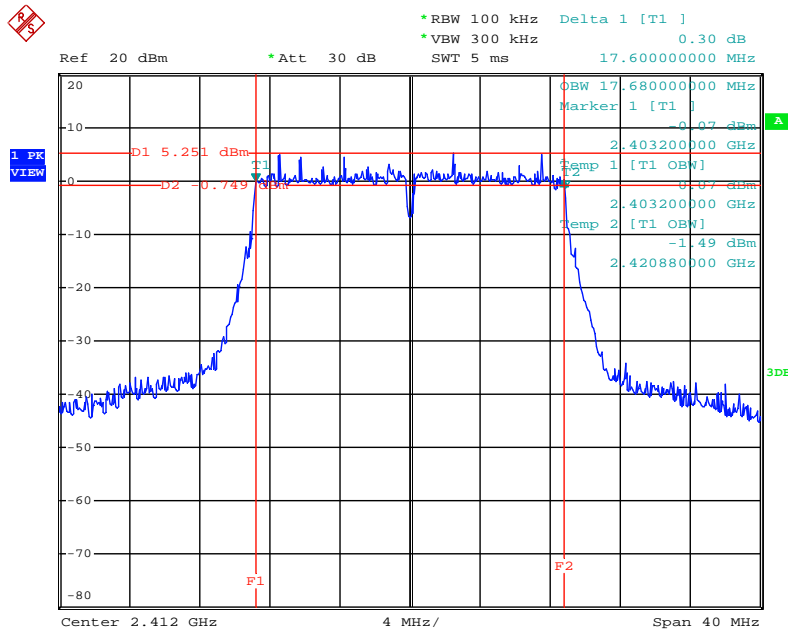

Date: 27.JAN.2014 11:19:34

6 dB Bandwidth Plot on Configuration of IEEE 802.11n 20MHz MCS0 / CH 6 / Ant. 1

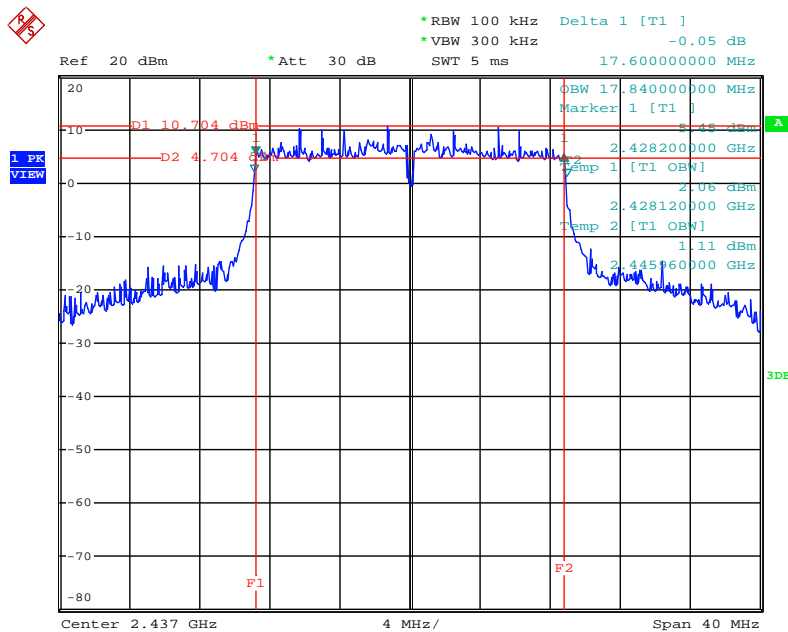

Date: 27.JAN.2014 11:23:38

6 dB Bandwidth Plot on Configuration of IEEE 802.11n 20MHz MCS0 / CH 11 / Ant. 1

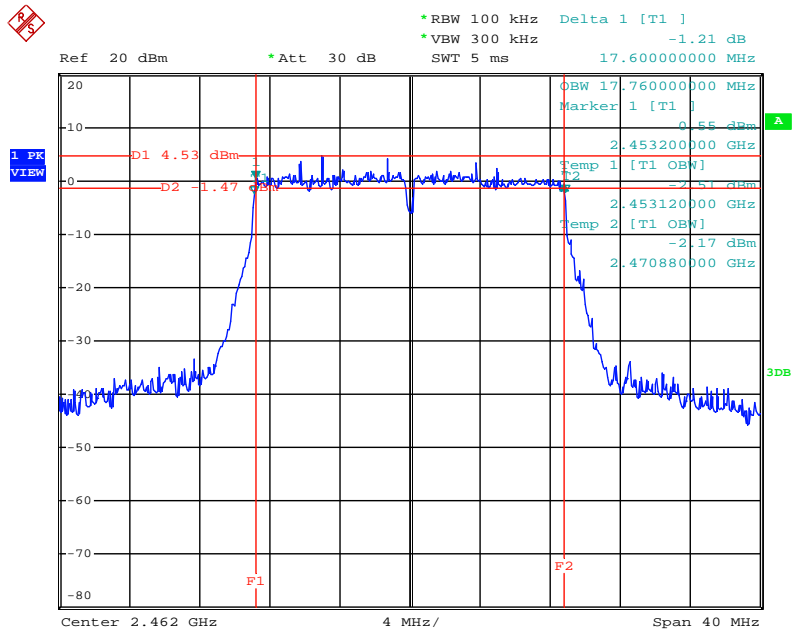

Date: 27.JAN.2014 11:25:16

6 dB Bandwidth Plot on Configuration of IEEE 802.11n 20MHz MCS0 / CH 1 / Ant. 2

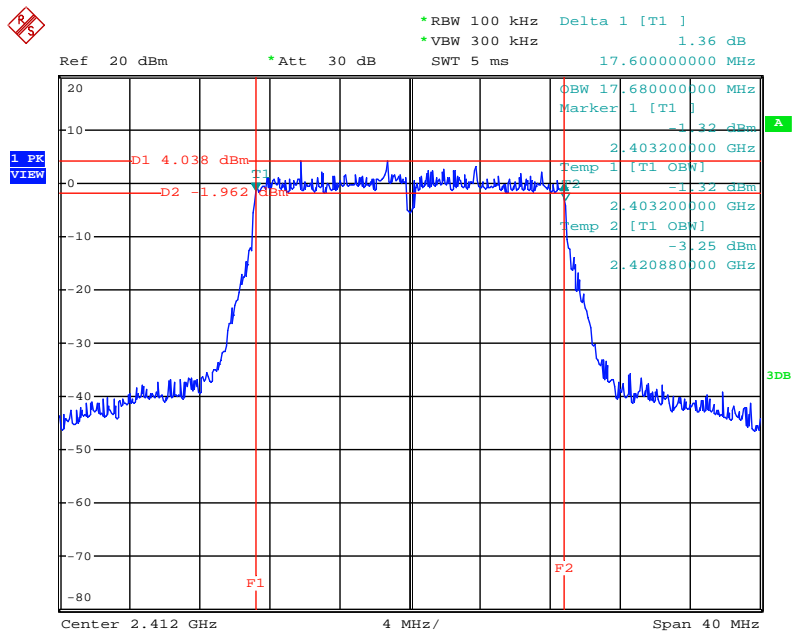

Date: 27.JAN.2014 11:20:15

6 dB Bandwidth Plot on Configuration of IEEE 802.11n 20MHz MCS0 / CH 6 / Ant. 2

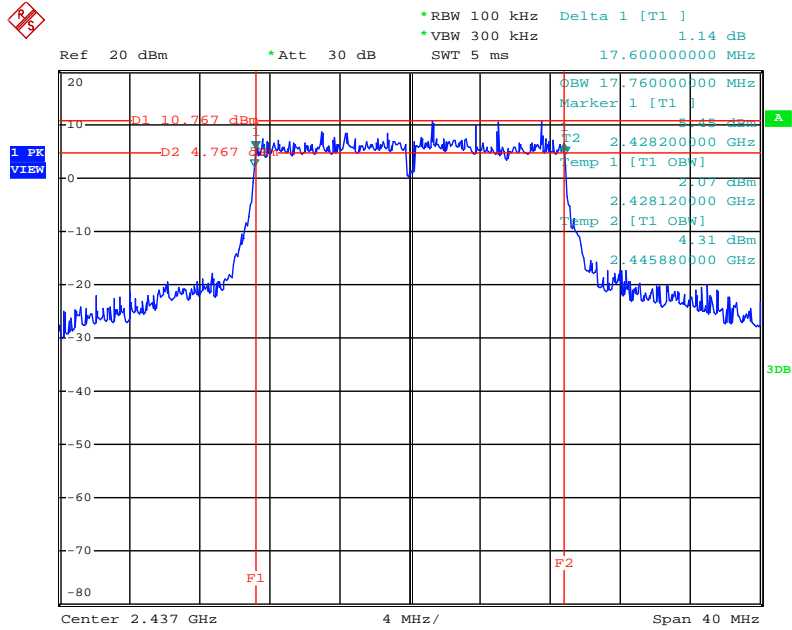

Date: 27.JAN.2014 11:22:59

6 dB Bandwidth Plot on Configuration of IEEE 802.11n 20MHz MCS0 / CH 11 / Ant. 2

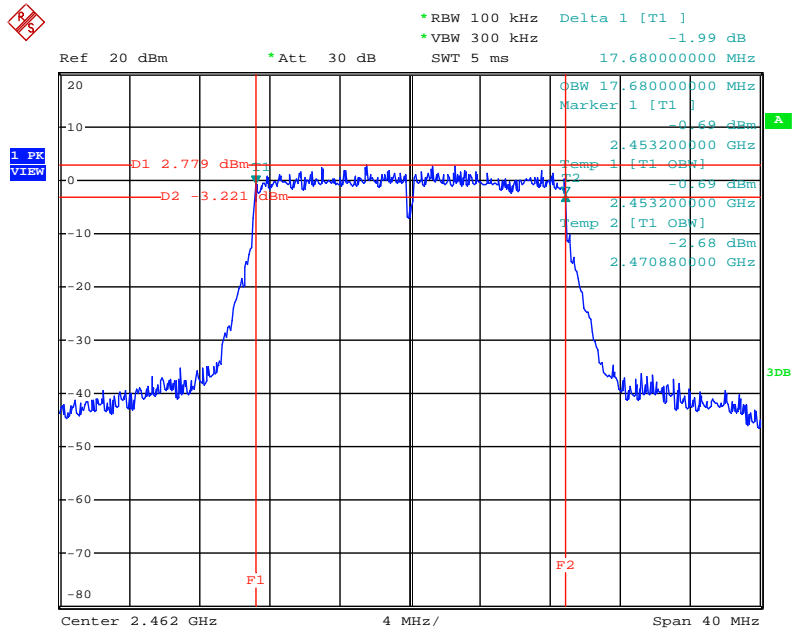

Date: 27.JAN.2014 11:26:12

6 dB Bandwidth Plot on Configuration of IEEE 802.11n 20MHz MCS0 / CH 1 / Ant. 3

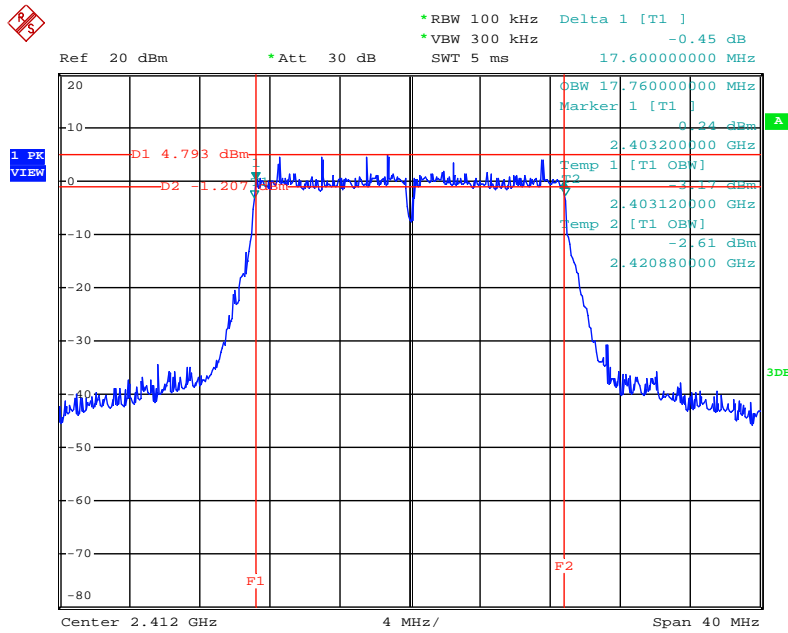

Date: 27.JAN.2014 11:20:52

6 dB Bandwidth Plot on Configuration of IEEE 802.11n 20MHz MCS0 / CH 6 / Ant. 3

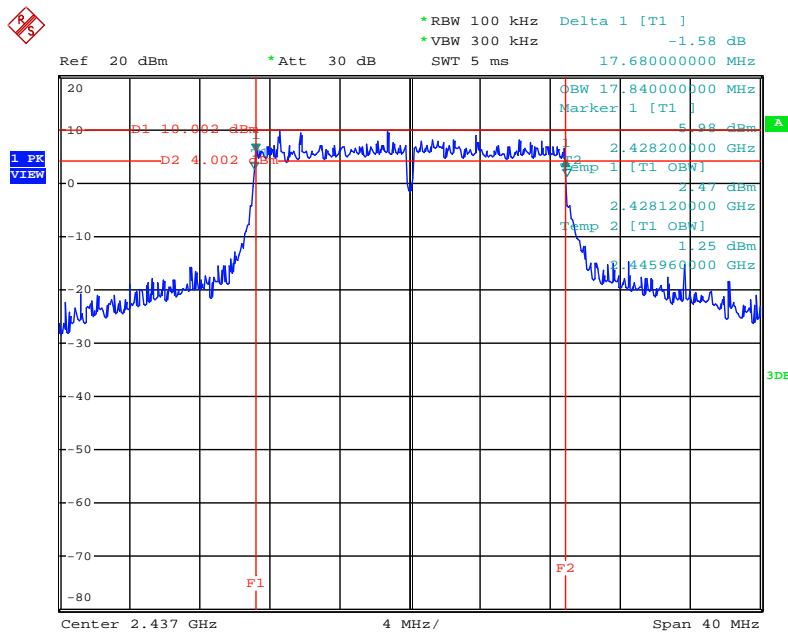

Date: 27.JAN.2014 11:22:10

6 dB Bandwidth Plot on Configuration of IEEE 802.11n 20MHz MCS0 / CH 11 / Ant. 3

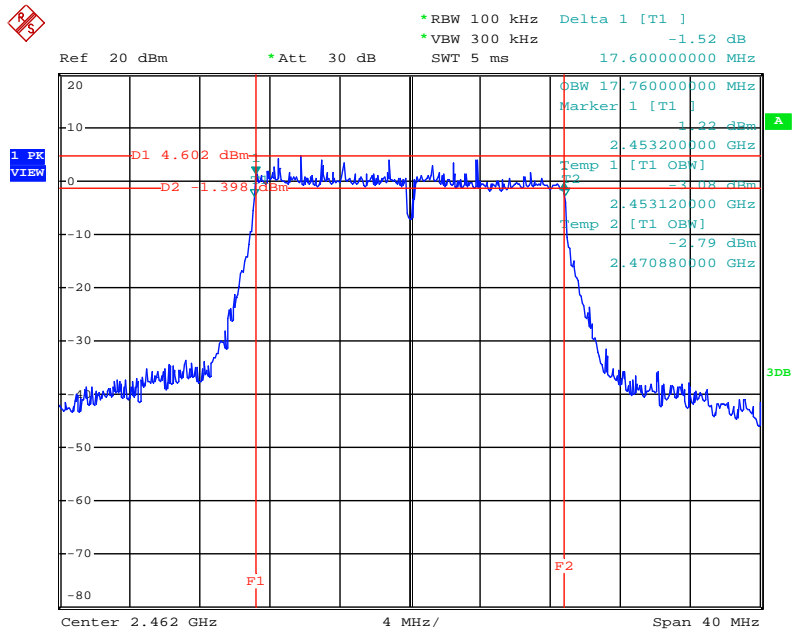

Date: 27.JAN.2014 11:27:11

<MCS8, Ant. 1+2+3, CDD>

6 dB Bandwidth Plot on Configuration of IEEE 802.11n 20MHz MCS8 / CH 1 / Ant. 1

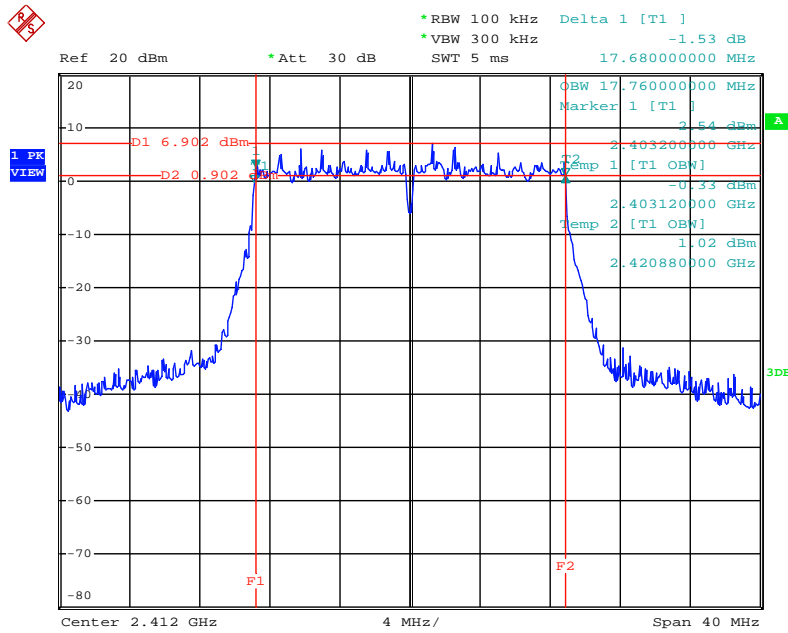

Date: 27.JAN.2014 10:36:05

6 dB Bandwidth Plot on Configuration of IEEE 802.11n 20MHz MCS8 / CH 6 / Ant. 1

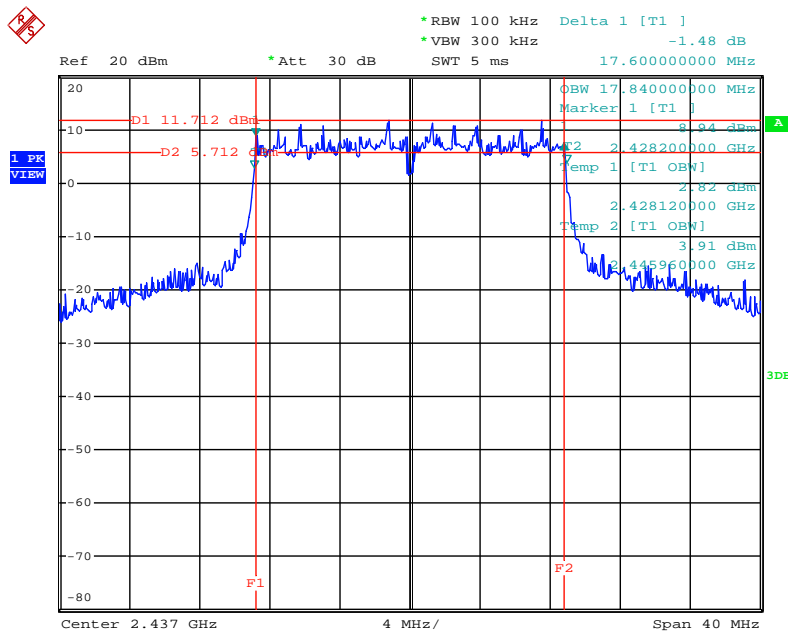

Date: 27.JAN.2014 10:40:52

6 dB Bandwidth Plot on Configuration of IEEE 802.11n 20MHz MCS8 / CH 11 / Ant. 1

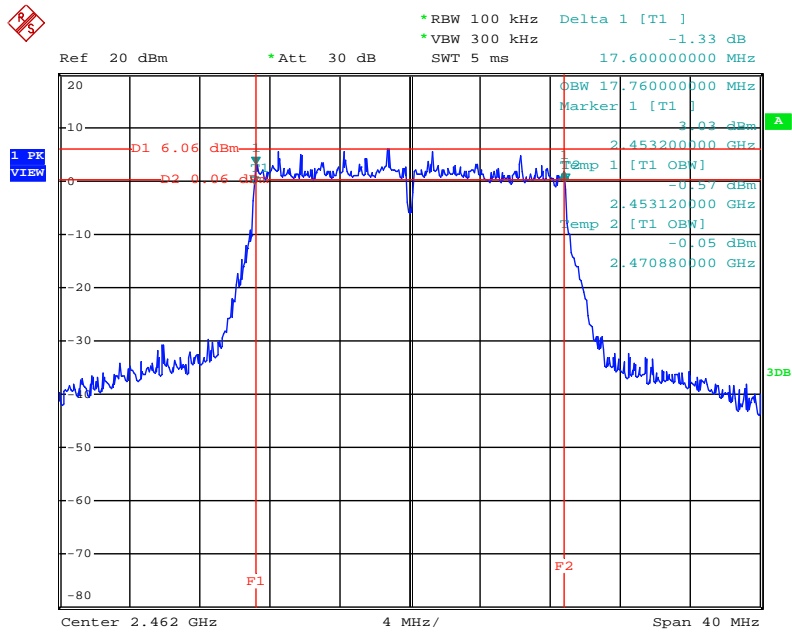

Date: 27.JAN.2014 10:43:32

6 dB Bandwidth Plot on Configuration of IEEE 802.11n 20MHz MCS8 / CH 1 / Ant. 2

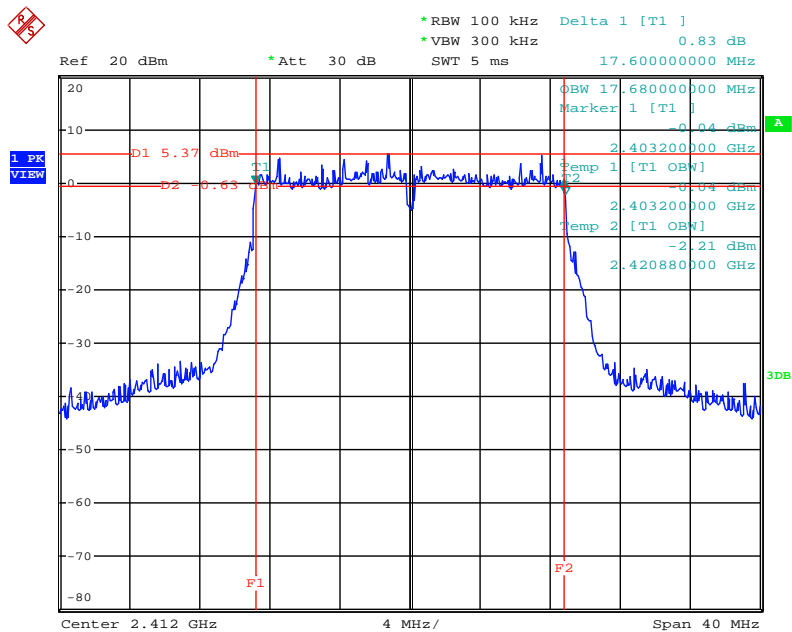

Date: 27.JAN.2014 10:36:59

6 dB Bandwidth Plot on Configuration of IEEE 802.11n 20MHz MCS8 / CH 6 / Ant. 2

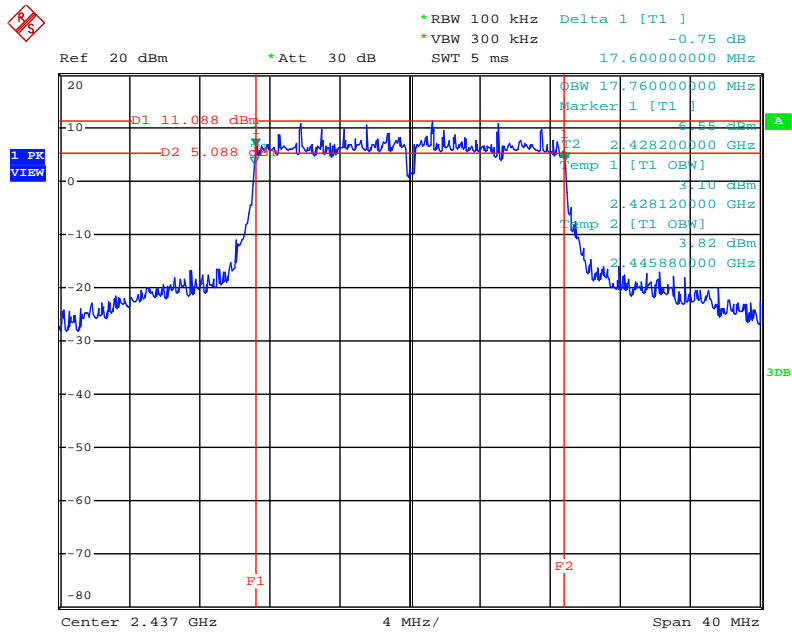

Date: 27.JAN.2014 10:39:23

6 dB Bandwidth Plot on Configuration of IEEE 802.11n 20MHz MCS8 / CH 11 / Ant. 2

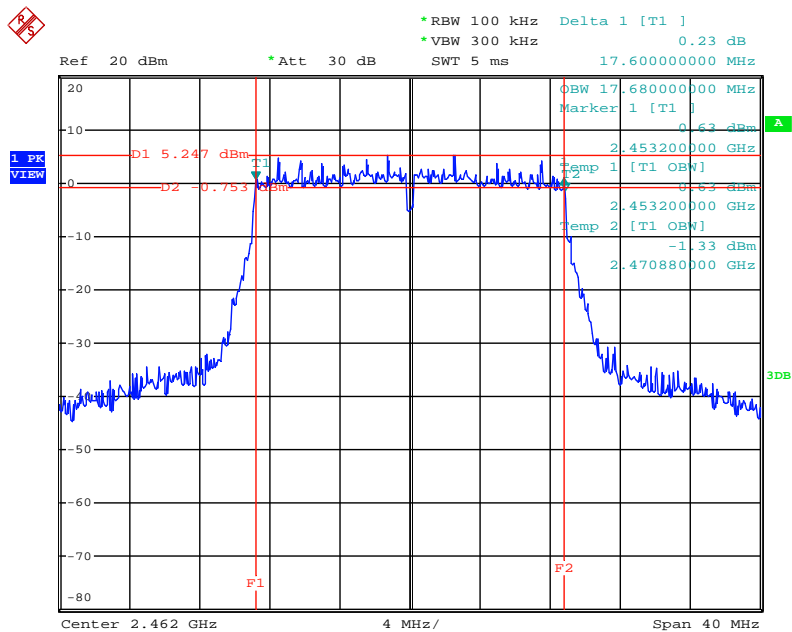

Date: 27.JAN.2014 10:43:04

6 dB Bandwidth Plot on Configuration of IEEE 802.11n 20MHz MCS8 / CH 1 / Ant. 3

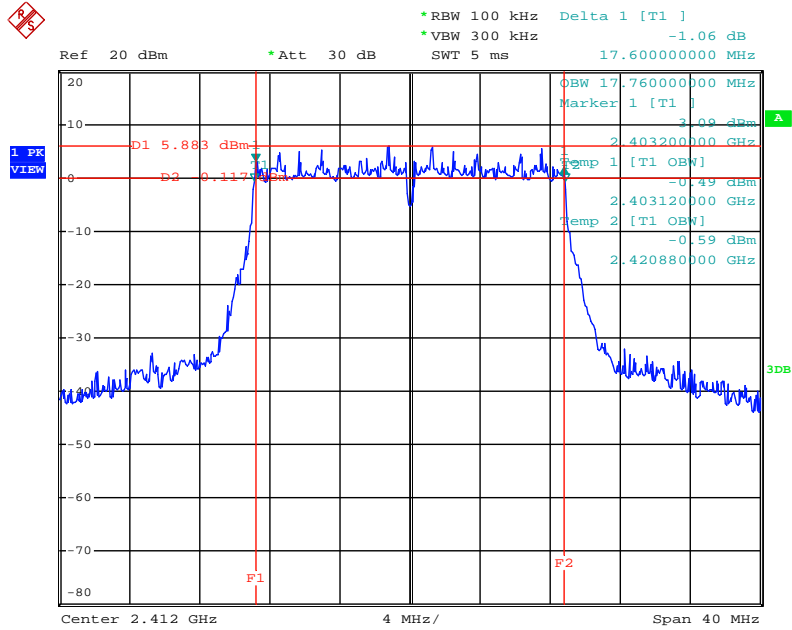

Date: 27.JAN.2014 10:37:45

6 dB Bandwidth Plot on Configuration of IEEE 802.11n 20MHz MCS8 / CH 6 / Ant. 3

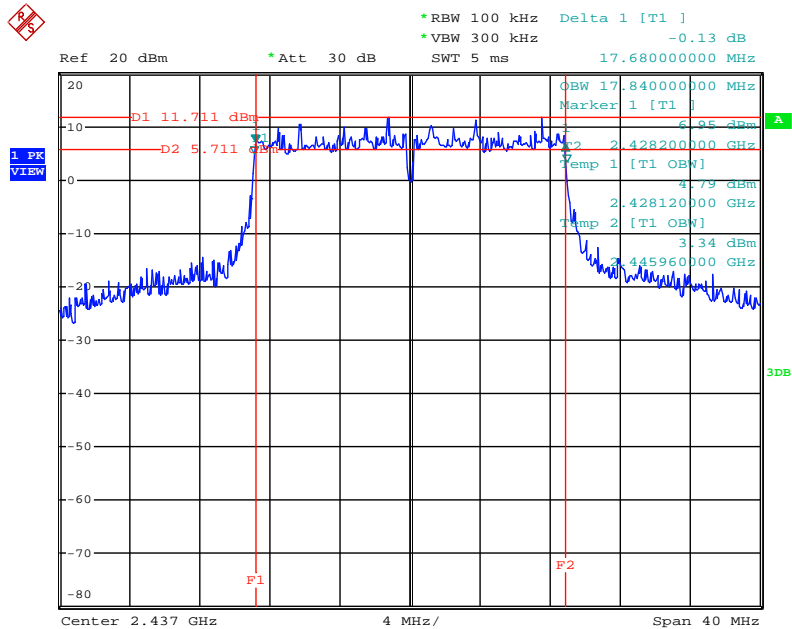

Date: 27.JAN.2014 10:38:45

6 dB Bandwidth Plot on Configuration of IEEE 802.11n 20MHz MCS8 / CH 11 / Ant. 3

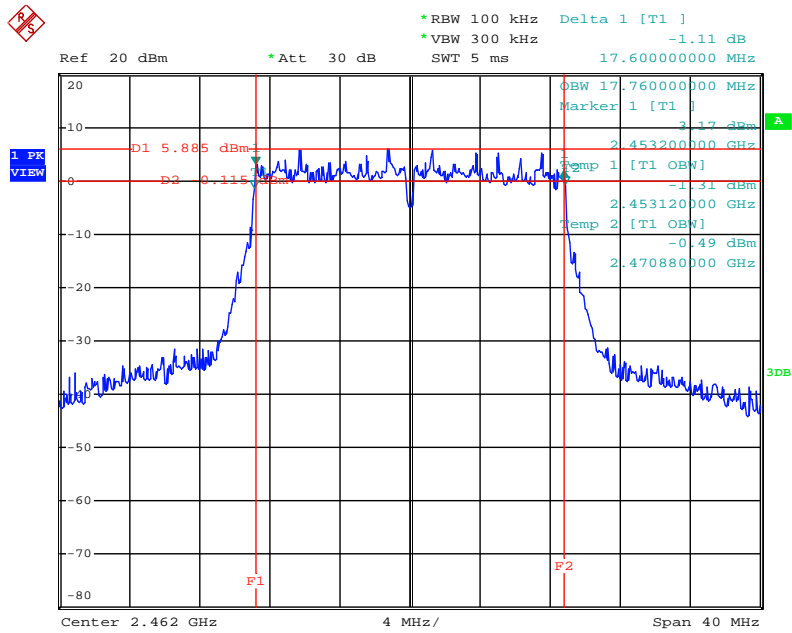

Date: 27.JAN.2014 10:42:16

Test date	Jan. 27, 2014	Test Site No.	TH01-CB
Temperature	26°C	Humidity	63%
Test Engineer	Magic Lai	Configuration	802.11n
Duty Cycle	Ant.1, 2, 3: 96.88% MCS0, Ant.1+2+3, CDD: 97.92% MCS8, Ant.1+2+3, CDD: 94.23%		

Configuration IEEE 802.11n 40MHz

<MCS0, Ant. 1>

Channel	Frequency	6dB Bandwidth (MHz)	99% Occupied Bandwidth (MHz)	Min. Limit (kHz)	Test Result
3	2422 MHz	36.16	36.32	500	Complies
6	2437 MHz	35.84	36.32	500	Complies
9	2452 MHz	36.00	36.16	500	Complies

<MCS0, Ant. 1+2+3, CDD>

Channel	Frequency	6dB Bandwidth (MHz)			99% Occupied Bandwidth (MHz)			Min. Limit (kHz)	Test Result
		Ant. 1	Ant. 2	Ant. 3	Ant. 1	Ant. 2	Ant. 3		
3	2422 MHz	36.16	36.32	36.32	36.32	36.32	36.32	500	Complies
6	2437 MHz	36.32	36.48	36.32	36.32	36.32	36.16	500	Complies
9	2452 MHz	36.32	35.52	36.00	36.32	36.32	36.16	500	Complies

<MCS8, Ant. 1+2+3, CDD>

Channel	Frequency	6dB Bandwidth (MHz)			99% Occupied Bandwidth (MHz)			Min. Limit (kHz)	Test Result
		Ant. 1	Ant. 2	Ant. 3	Ant. 1	Ant. 2	Ant. 3		
3	2422 MHz	36.16	36.32	36.16	36.32	36.32	36.32	500	Complies
6	2437 MHz	35.68	36.32	36.16	36.16	36.32	36.16	500	Complies
9	2452 MHz	36.00	35.84	36.00	36.16	36.32	36.16	500	Complies

For <Ant. 1>

6 dB Bandwidth Plot on Configuration of IEEE 802.11n 40MHz MCS0 / CH3 / Ant. 1

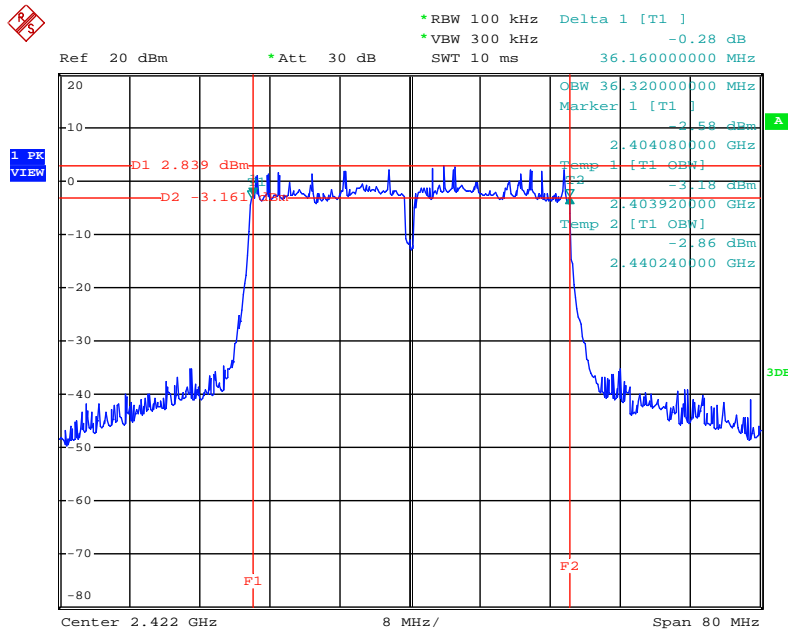

Date: 27.JAN.2014 11:07:53

6 dB Bandwidth Plot on Configuration of IEEE 802.11n 40MHz MCS0 / CH 6 / Ant. 1

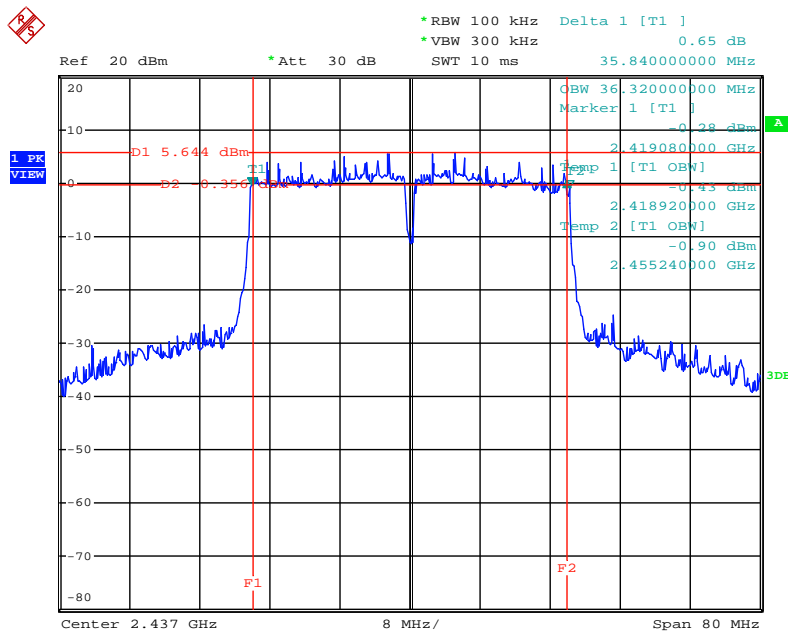

Date: 27.JAN.2014 11:09:28

6 dB Bandwidth Plot on Configuration of IEEE 802.11n 40MHz MCS0 / CH 9 / Ant. 1

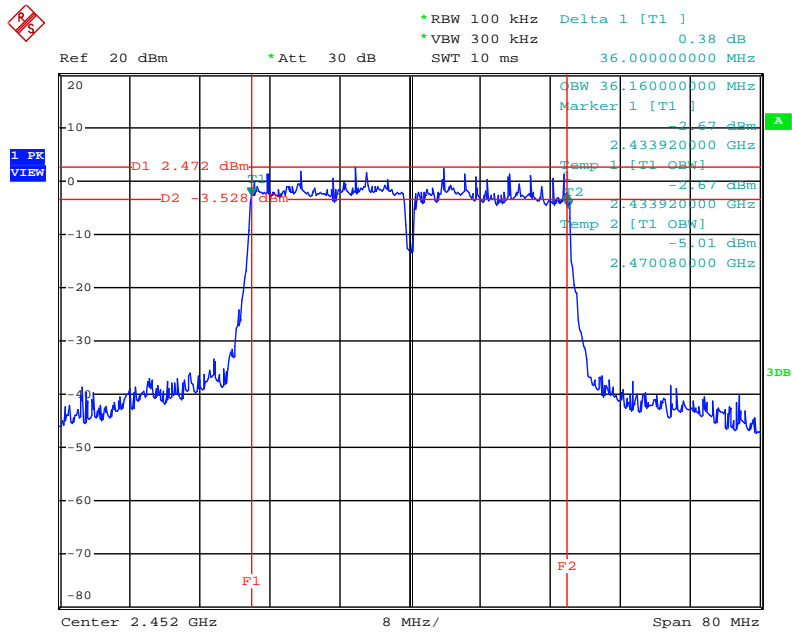

Date: 27.JAN.2014 11:10:21

<MCS0, Ant. 1+2+3, CDD>

6 dB Bandwidth Plot on Configuration of IEEE 802.11n 40MHz MCS0 / CH 3 / Ant. 1

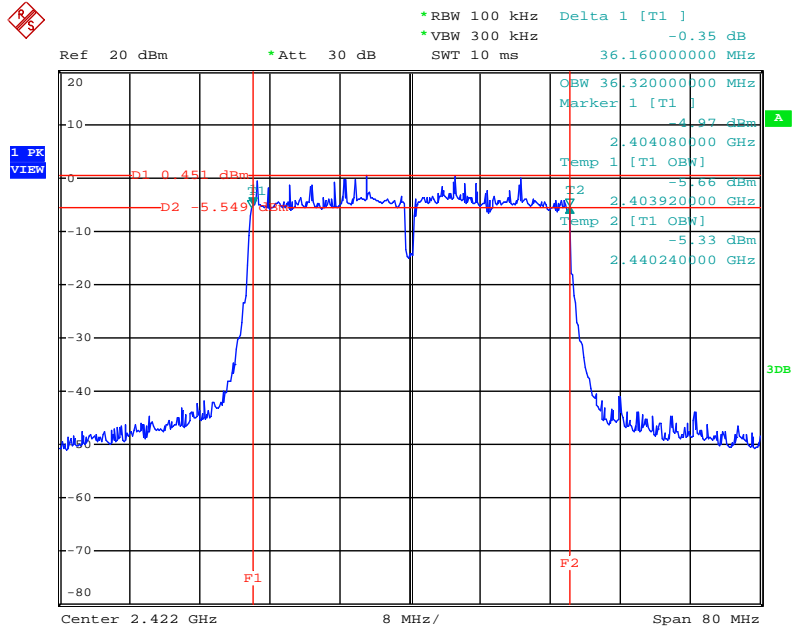

Date: 27.JAN.2014 11:29:32

6 dB Bandwidth Plot on Configuration of IEEE 802.11n 40MHz MCS0 / CH 6 / Ant. 1

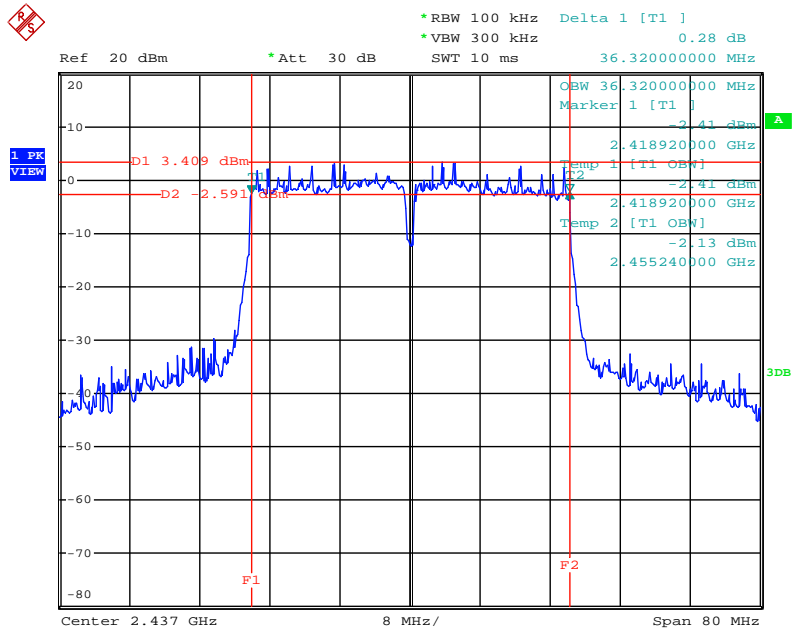

Date: 27.JAN.2014 11:35:53

6 dB Bandwidth Plot on Configuration of IEEE 802.11n 40MHz MCS0 / CH 9 / Ant. 1

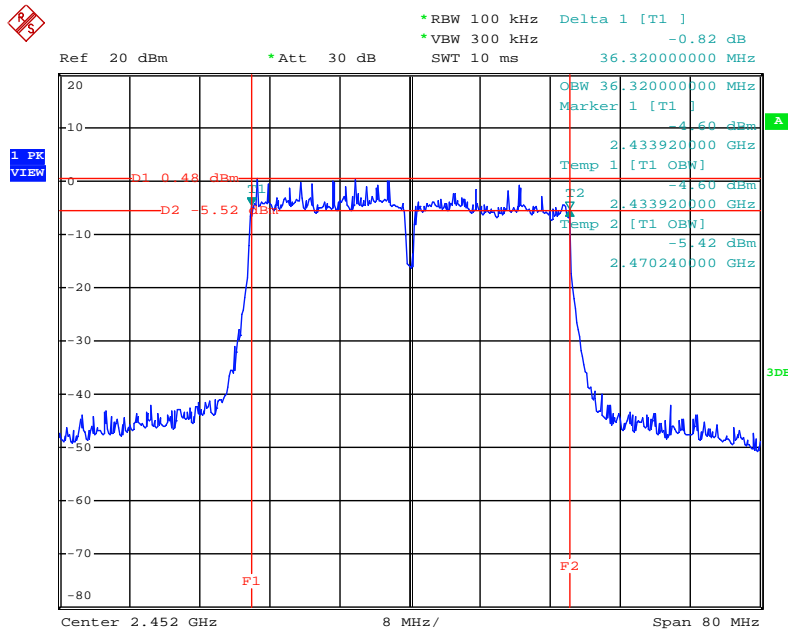

Date: 27.JAN.2014 11:37:09

6 dB Bandwidth Plot on Configuration of IEEE 802.11n 40MHz MCS0 / CH 3 / Ant. 2

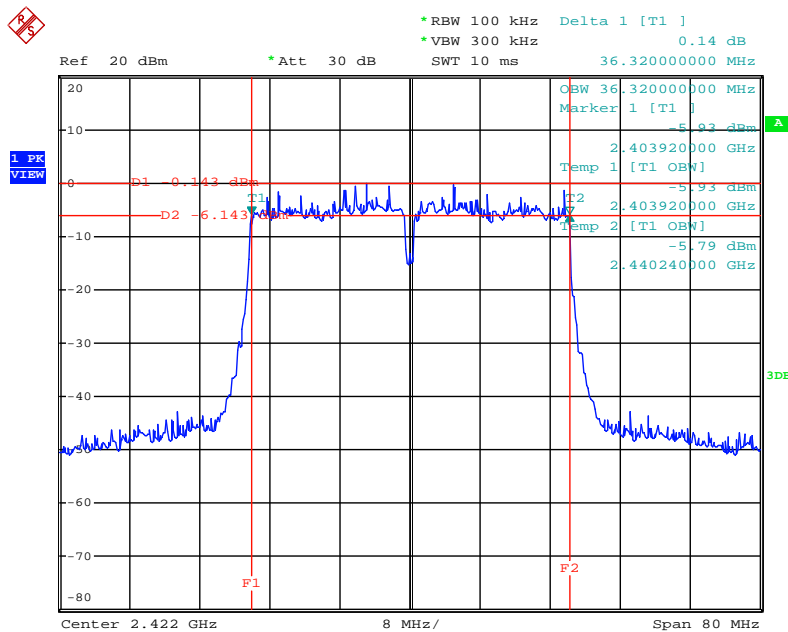

Date: 27.JAN.2014 11:30:31

6 dB Bandwidth Plot on Configuration of IEEE 802.11n 40MHz MCS0 / CH 6 / Ant. 2

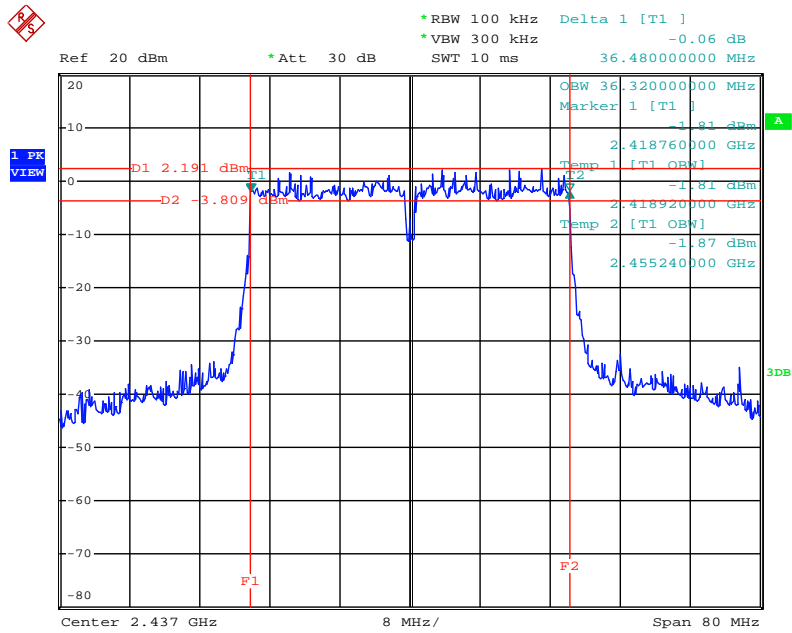

Date: 27.JAN.2014 11:34:47

6 dB Bandwidth Plot on Configuration of IEEE 802.11n 40MHz MCS0 / CH 9 / Ant. 2

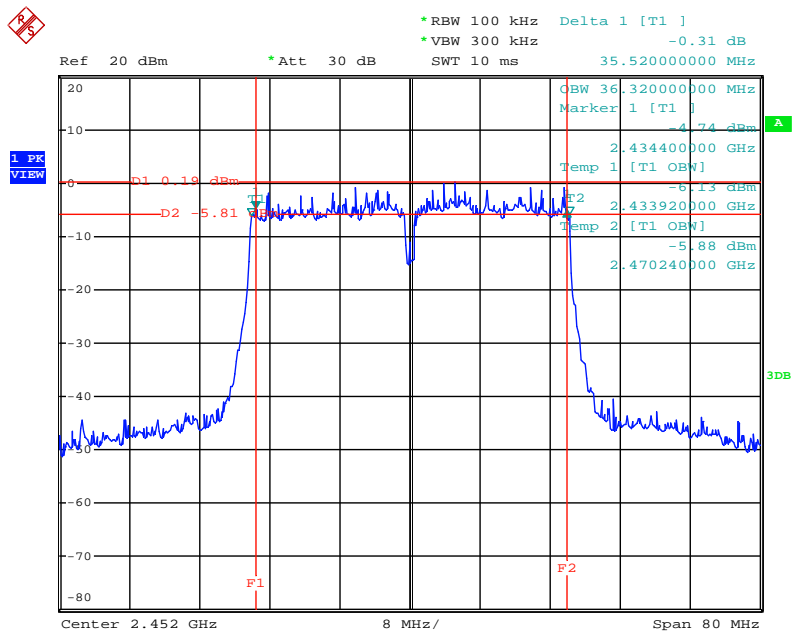

Date: 27.JAN.2014 11:37:56

6 dB Bandwidth Plot on Configuration of IEEE 802.11n 40MHz MCS0 / CH 3 / Ant. 3

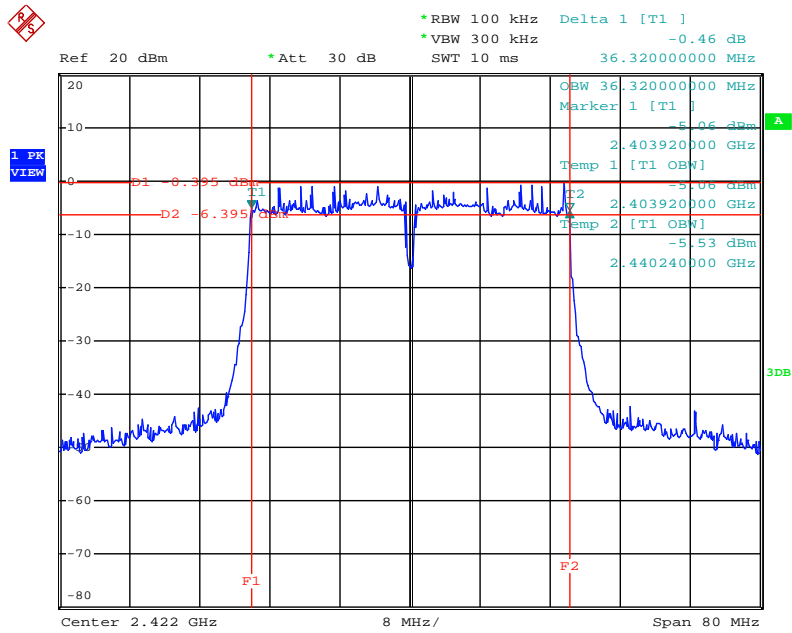

Date: 27.JAN.2014 11:31:17

6 dB Bandwidth Plot on Configuration of IEEE 802.11n 40MHz MCS0 / CH 6 / Ant. 3

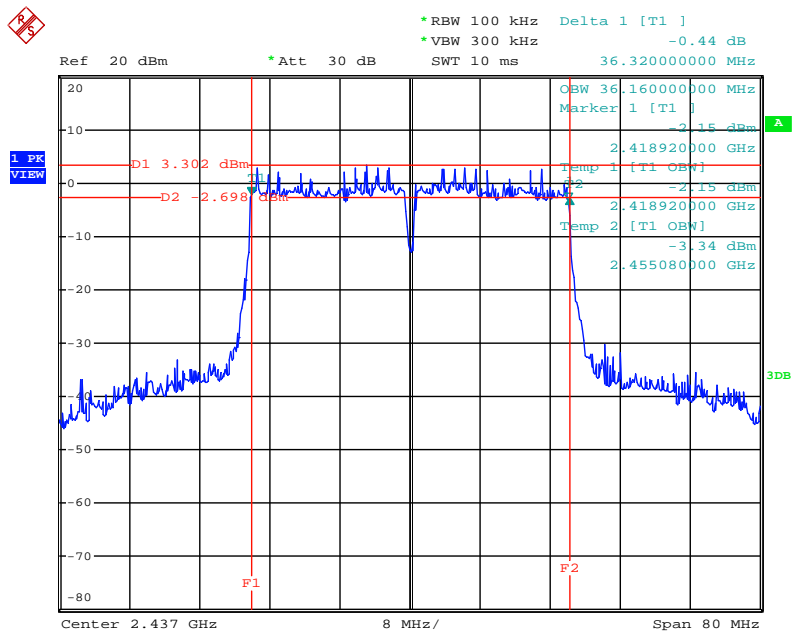

Date: 27.JAN.2014 11:33:59

6 dB Bandwidth Plot on Configuration of IEEE 802.11n 40MHz MCS0 / CH 9 / Ant. 3

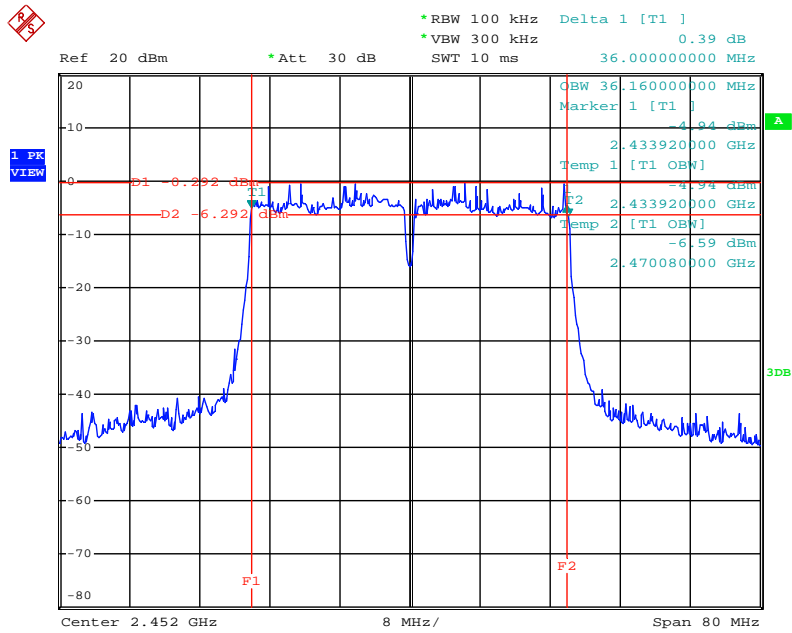

Date: 27.JAN.2014 11:38:42

<MCS8, Ant. 1+2+3, CDD>

6 dB Bandwidth Plot on Configuration of IEEE 802.11n 40MHz MCS8 / CH 3 / Ant. 1

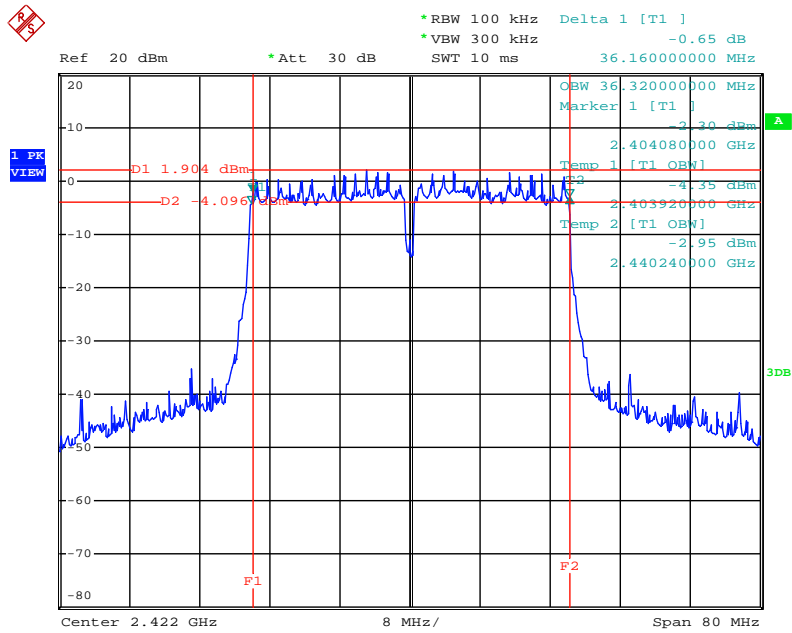

Date: 27.JAN.2014 10:45:28

6 dB Bandwidth Plot on Configuration of IEEE 802.11n 40MHz MCS8 / CH 6 / Ant. 1

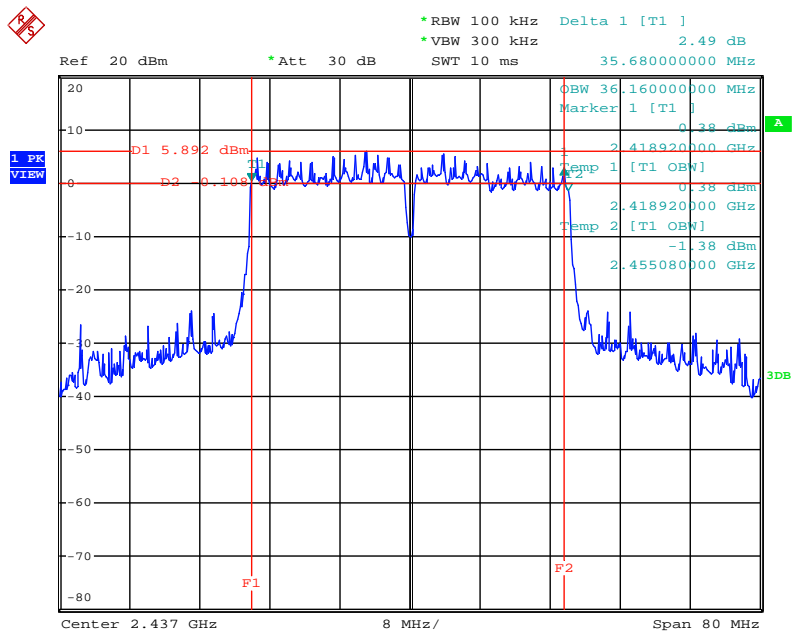

Date: 27.JAN.2014 10:49:53

6 dB Bandwidth Plot on Configuration of IEEE 802.11n 40MHz MCS8 / CH 9 / Ant. 1

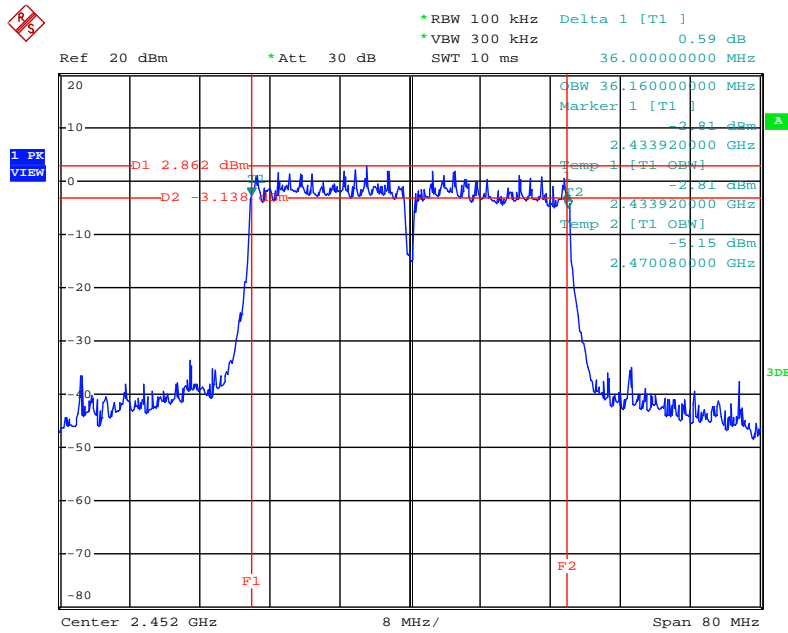

Date: 27.JAN.2014 10:50:57

6 dB Bandwidth Plot on Configuration of IEEE 802.11n 40MHz MCS8 / CH 3 / Ant. 2

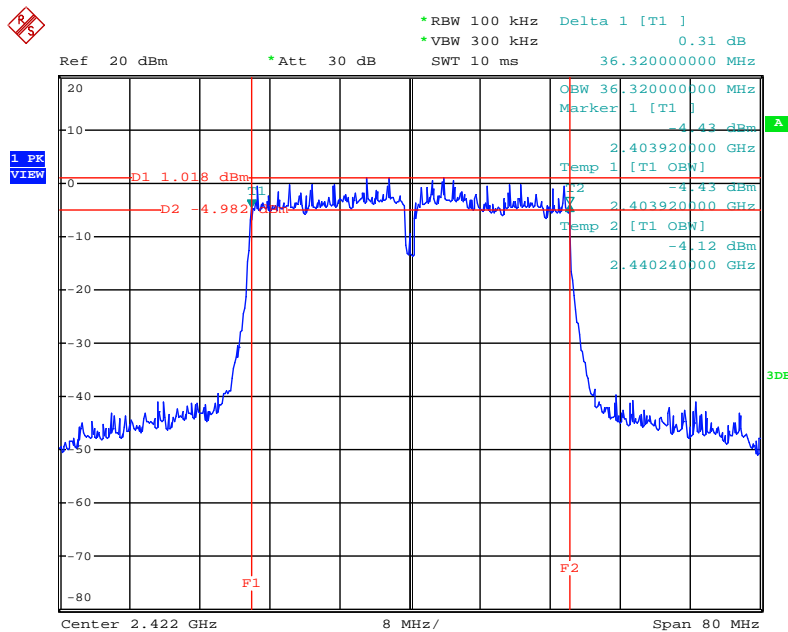

Date: 27.JAN.2014 10:46:08

6 dB Bandwidth Plot on Configuration of IEEE 802.11n 40MHz MCS8 / CH 6 / Ant. 2

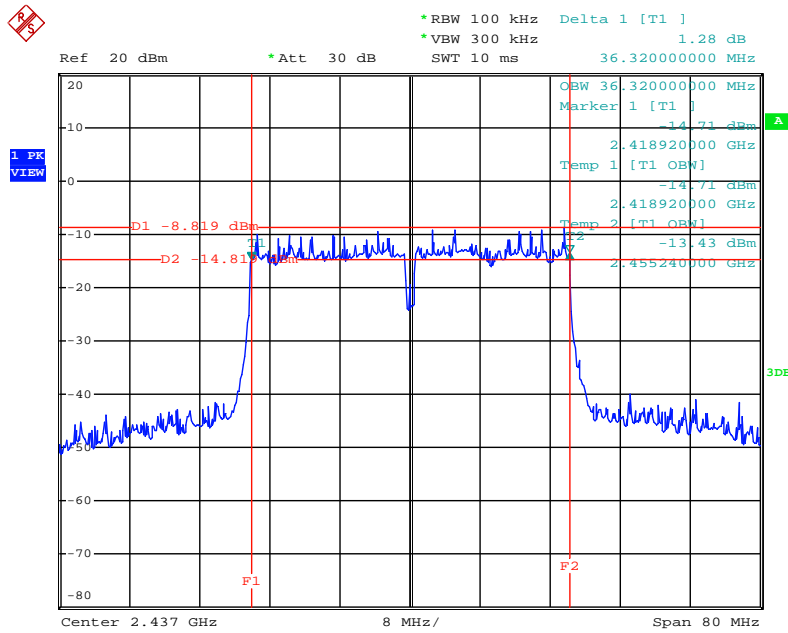

Date: 27.JAN.2014 10:49:04

6 dB Bandwidth Plot on Configuration of IEEE 802.11n 40MHz MCS8 / CH 9 / Ant. 2

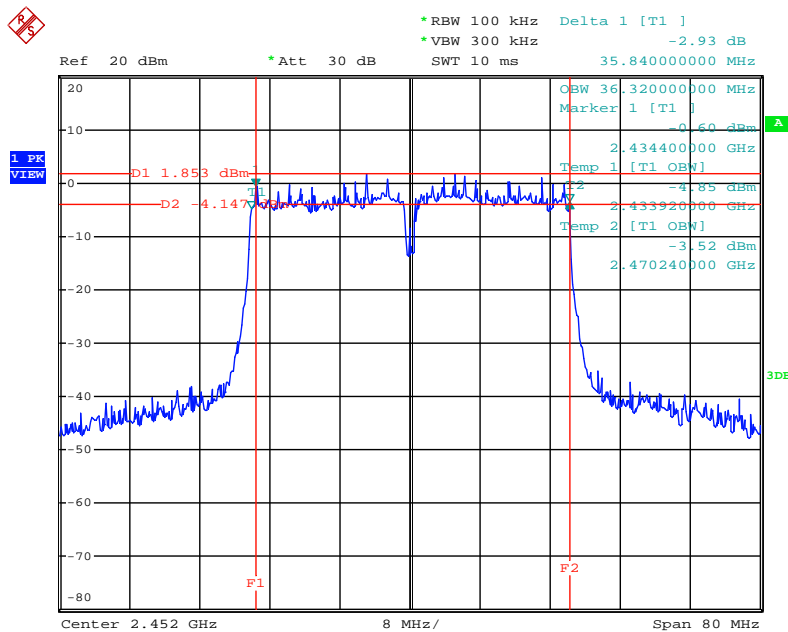

Date: 27.JAN.2014 10:51:48

6 dB Bandwidth Plot on Configuration of IEEE 802.11n 40MHz MCS8 / CH 3 / Ant. 3

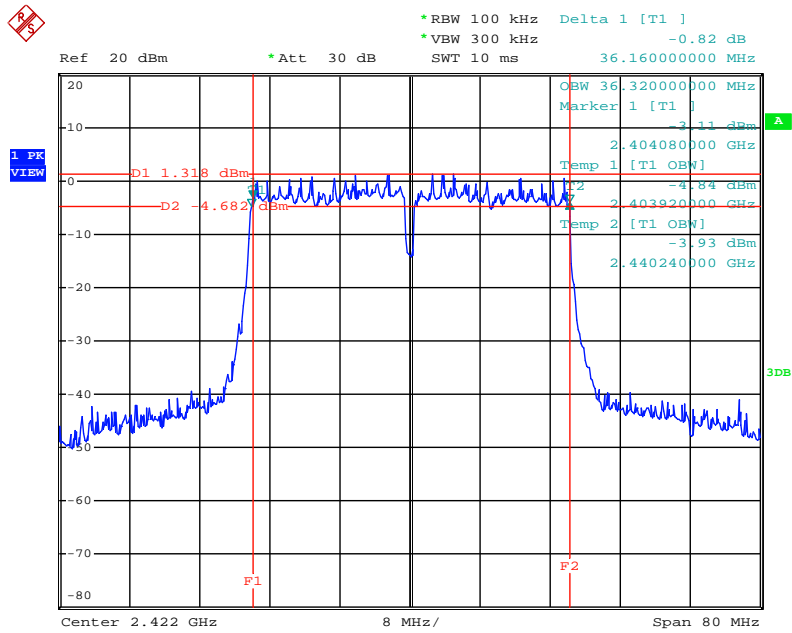

Date: 27.JAN.2014 10:46:49

6 dB Bandwidth Plot on Configuration of IEEE 802.11n 40MHz MCS8 / CH 6 / Ant. 3

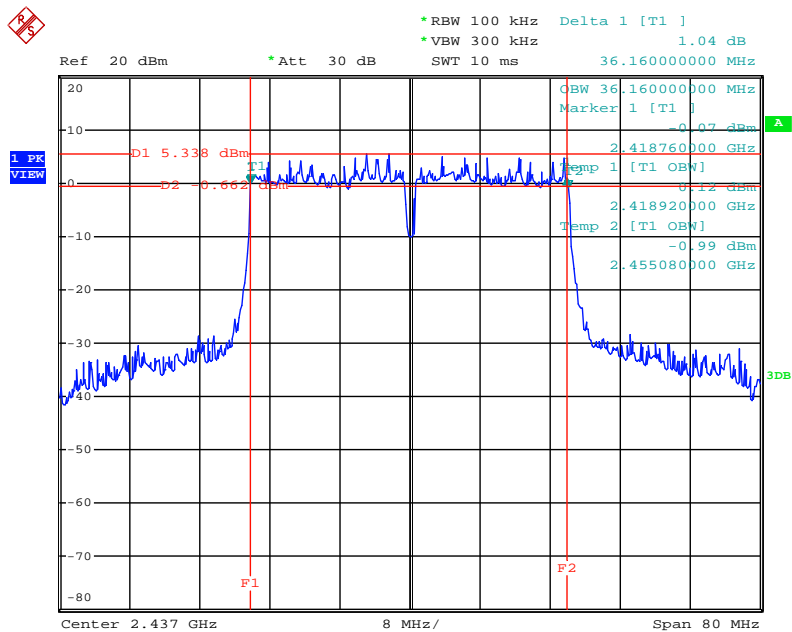

Date: 27.JAN.2014 10:48:26

6 dB Bandwidth Plot on Configuration of IEEE 802.11n 40MHz MCS8 / CH 9 / Ant. 3

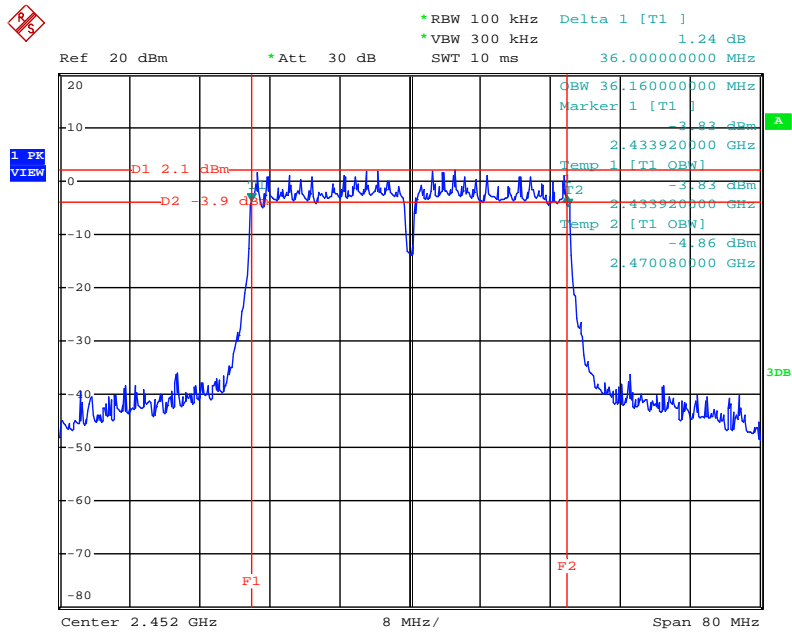

Date: 27.JAN.2014 10:52:28

3.5. Radiated Emissions Measurement

3.5.1. Limit

30dBc in any 100 kHz bandwidth outside the operating frequency band. In case the emission fall within the restricted band specified on 15.205(a), then the 15.209(a) limit in the table below has to be followed.

Frequencies (MHz)	Field Strength (microvolt/meter)	Measurement Distance (meters)
0.009~0.490	2400/F(kHz)	300
0.490~1.705	24000/F(kHz)	30
1.705~30.0	30	30
30~88	100	3
88~216	150	3
216~960	200	3
Above 960	500	3

3.5.2. Measuring Instruments and Setting

Please refer to section 6 of equipments list in this report. The following table is the setting of spectrum analyzer and receiver.

Spectrum Parameter	Setting
Attenuation	Auto
Start Frequency	1GHz
Stop Frequency	10th carrier harmonic
RBW / VBW (Emission in restricted band)	1MHz / 3MHz for Peak, 1MHz / 10Hz for Average
RBW / VBW (Emission in non-restricted band)	100kHz / 300kHz for peak

Receiver Parameter	Setting
Attenuation	Auto
Start ~ Stop Frequency	9kHz~150kHz / RBW 200Hz for QP
Start ~ Stop Frequency	150kHz~30MHz / RBW 9kHz for QP
Start ~ Stop Frequency	30MHz~1GHz / RBW 120kHz for QP

3.5.3. Test Procedures

1. Configure the EUT according to ANSI C63.10. The EUT was placed on the top of the turntable 0.8 meter above ground. The phase center of the receiving antenna mounted on the top of a height-variable antenna tower was placed 3 meters far away from the turntable.
2. Power on the EUT and all the supporting units. The turntable was rotated by 360 degrees to determine the position of the highest radiation.
3. The height of the broadband receiving antenna was varied between one meter and four meters above ground to find the maximum emissions field strength of both horizontal and vertical polarization.
4. For each suspected emissions, the antenna tower was scan (from 1 m to 4 m) and then the turntable was rotated (from 0 degree to 360 degrees) to find the maximum reading.
5. Set the test-receiver system to Peak or CISPR quasi-peak Detect Function with specified bandwidth under Maximum Hold Mode.
6. For emissions above 1GHz, use 1MHz VBW and 3MHz RBW for peak reading. Then 1MHz RBW and 10Hz VBW for average reading in spectrum analyzer.
7. When the radiated emissions limits are expressed in terms of the average value of the emissions, and pulsed operation is employed, the measurement field strength shall be determined by averaging over one complete pulse train, including blanking intervals, as long as the pulse train does not exceed 0.1 seconds. As an alternative (provided the transmitter operates for longer than 0.1 seconds) or in cases where the pulse train exceeds 0.1 seconds, the measured field strength shall be determined from the average absolute voltage during a 0.1 second interval during which the field strength is at its maximum value.
8. If the emissions level of the EUT in peak mode was 3 dB lower than the average limit specified, then testing will be stopped and peak values of EUT will be reported, otherwise, the emissions which do not have 3 dB margin will be repeated one by one using the quasi-peak method for below 1GHz.
9. For testing above 1GHz, the emissions level of the EUT in peak mode was lower than average limit (that means the emissions level in peak mode also complies with the limit in average mode), then testing will be stopped and peak values of EUT will be reported, otherwise, the emissions will be measured in average mode again and reported.
10. In case the emission is lower than 30MHz, loop antenna has to be used for measurement and the recorded data should be QP measured by receiver. High – Low scan is not required in this case.

3.5.4. Test Setup Layout

For Radiated Emissions below 1GHz (9kHz~30MHz)

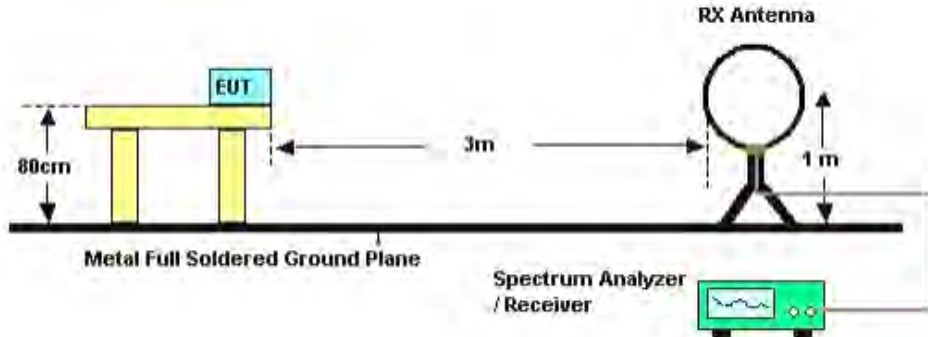

For Radiated Emissions below 1GHz (30MHz~1GHz)

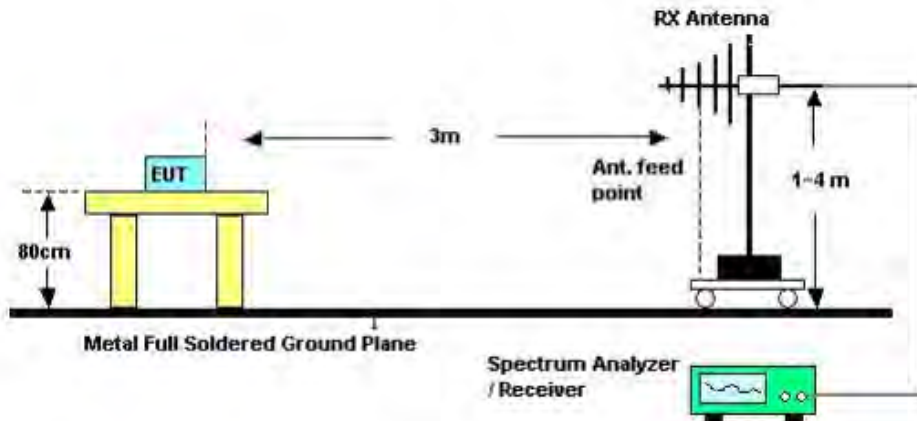

For Radiated Emissions above 1GHz

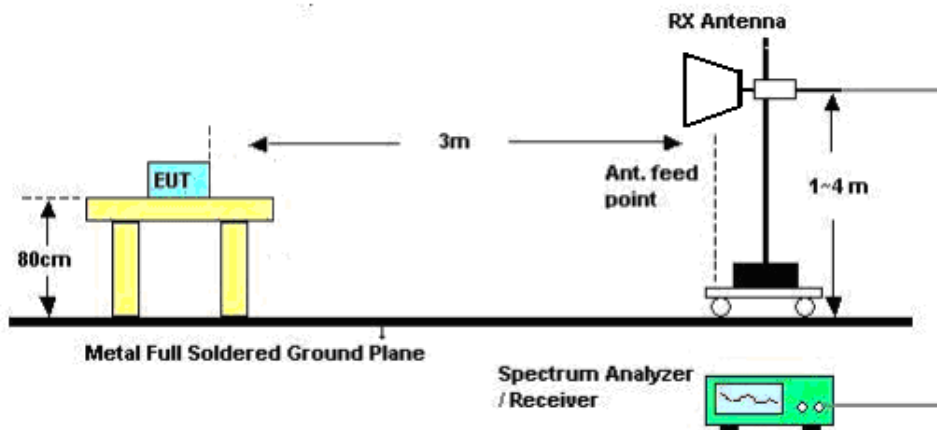

3.5.5. Test Deviation

There are no deviations with the original standard.

3.5.6. EUT Operation during Test

The EUT was programmed to be in continuously transmitting mode.

3.5.7. Results of Radiated Emissions (9kHz~30MHz)

Frequency Range	9kHz~30MHz	Test Site No.	03CH01-CB
Temperature	24°C	Humidity	55%
Test Engineer	David Tseng	Configurations	CTX
Test Date	Feb. 26, 2014		

Freq. (MHz)	Level (dBuV)	Over Limit (dB)	Limit Line (dBuV)	Remark
-	-	-	-	See Note

Note:

The amplitude of spurious emissions that are attenuated by more than 20 dB below the permissible value has no need to be reported.

Distance extrapolation factor = $40 \log(\text{specific distance} / \text{test distance})$ (dB);

Limit line = specific limits (dBuV) + distance extrapolation factor.

3.5.8. Results of Radiated Emissions (30MHz~1GHz)

Frequency Range	30MHz~1GHz	Test Site No.	03CH01-CB
Temperature	24°C	Humidity	55%
Test Engineer	David Tseng	Configurations	CTX

Horizontal

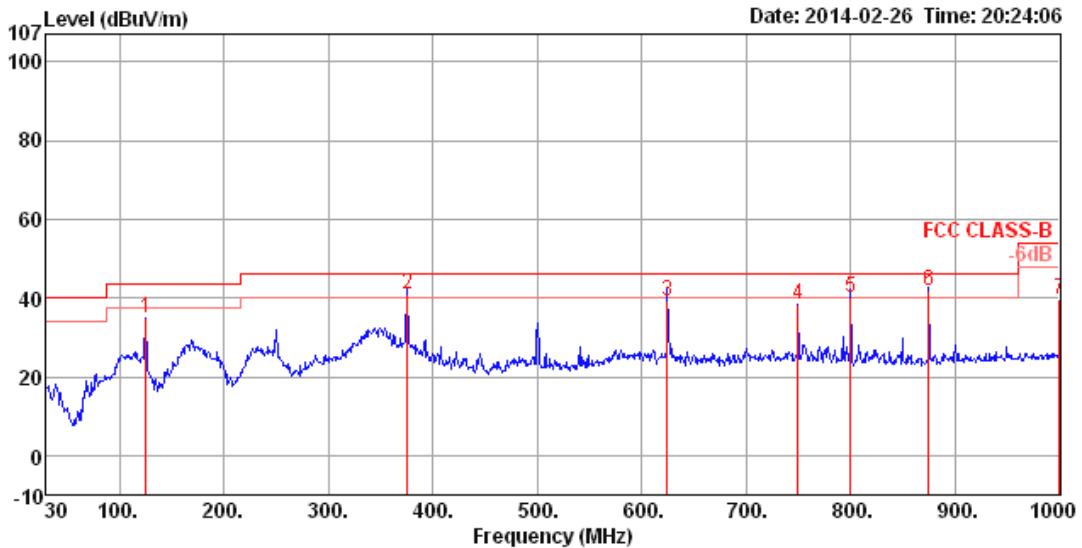

	Freq	Level	Limit	Over	Read	CableAntenna	Preamp	A/Pos	T/Pos	Pol/Phase	Remark
	MHz	dBuV/m	dBuV/m	dB	dBuV	dB	dB/m	dB	cm	deg	
1	125.06	34.73	43.50	-8.77	53.24	1.33	11.73	31.57	150	265	HORIZONTAL Peak
2	375.32	40.78	46.00	-5.22	54.84	2.44	14.93	31.43	100	226	HORIZONTAL QP
3	624.61	39.01	46.00	-6.99	48.62	3.18	18.61	31.40	124	286	HORIZONTAL QP
4	749.74	38.21	46.00	-7.79	46.36	3.53	19.69	31.37	100	332	HORIZONTAL Peak
5	800.18	40.12	46.00	-5.88	47.96	3.67	19.76	31.27	100	73	HORIZONTAL QP
6	874.87	42.02	46.00	-3.98	49.04	3.89	20.24	31.15	100	296	HORIZONTAL QP
7	1000.00	39.65	54.00	-14.35	45.18	4.21	21.44	31.18	125	332	HORIZONTAL Peak

Note:

The amplitude of spurious emissions which are attenuated by more than 20 dB below the permissible value has no need to be reported.

Emission level (dBuV/m) = 20 log Emission level (uV/m).

Corrected Reading: Antenna Factor + Cable Loss + Read Level - Preamp Factor = Level.

Vertical

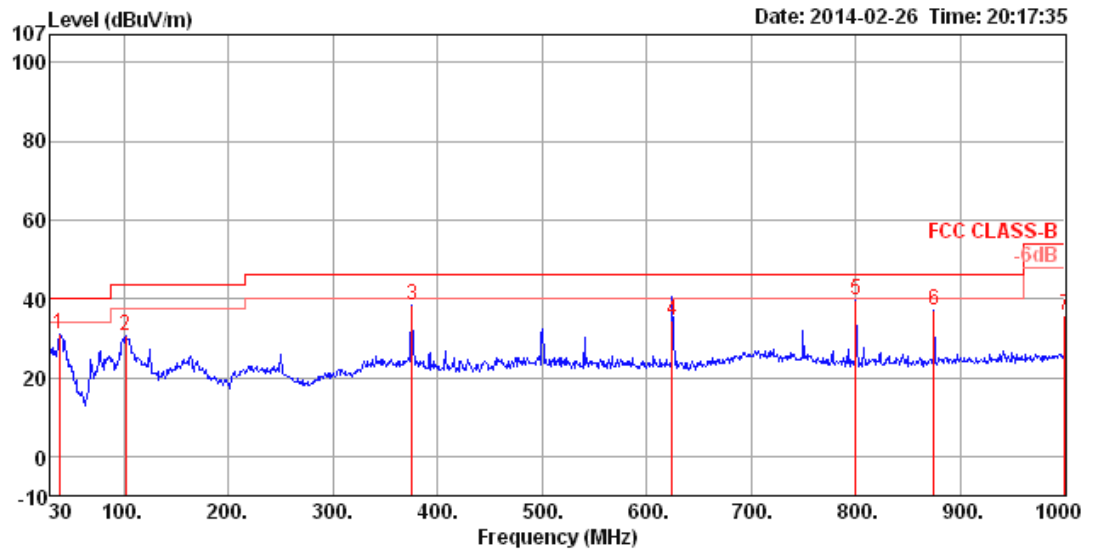

	Freq	Level	Limit	Over	Read	CableAntenna	Preamp	A/Pos	T/Pos	Pol/Phase	Remark
	MHz	dBuV/m	dBuV/m	dB	dBuV	dB	dB/m	dB	cm	deg	
1	38.73	31.16	40.00	-8.84	49.21	0.73	13.10	31.88	125	341	VERTICAL Peak
2	101.78	30.80	43.50	-12.70	50.65	1.19	10.56	31.60	100	358	VERTICAL Peak
3	375.32	38.38	46.00	-7.62	52.44	2.44	14.93	31.43	150	96	VERTICAL Peak
4	624.61	34.45	46.00	-11.55	44.06	3.18	18.61	31.40	100	80	VERTICAL QP
5	800.18	39.72	46.00	-6.28	47.56	3.67	19.76	31.27	125	89	VERTICAL Peak
6	874.87	36.97	46.00	-9.03	43.99	3.89	20.24	31.15	125	303	VERTICAL Peak
7	1000.00	35.96	54.00	-18.04	41.49	4.21	21.44	31.18	100	294	VERTICAL Peak

Note:

The amplitude of spurious emissions which are attenuated by more than 20 dB below the permissible value has no need to be reported.

Emission level (dBuV/m) = 20 log Emission level (uV/m).

Corrected Reading: Antenna Factor + Cable Loss + Read Level - Preamp Factor = Level.

3.5.9. Results for Radiated Emissions (1GHz~10th Harmonic)

Following channel(s) was (were) selected for the final test as listed below.

MODE	TX Chain	TESTED CHANNEL	MODULATION TECHNOLOGY	MODULATION TYPE	DATA RATE (Mbps)
802.11b	Ant.1	1, 6, 11	DSSS	DBPSK	1
802.11b	Ant.1+2+3, CDD	1, 6, 11	DSSS	DBPSK	1
802.11g	Ant.1	1, 6, 11	OFDM	BPSK	6
802.11g	Ant.1+2+3, CDD	1, 6, 11	OFDM	BPSK	6
802.11n 20MHz	Ant.1	1, 6, 11	OFDM	BPSK	MCS0 (6.5)
802.11n 20MHz	Ant.1+2+3, CDD	1, 6, 11	OFDM	BPSK	MCS0 (6.5)
802.11n 20MHz	Ant.1+2+3, CDD	1, 6, 11	OFDM	BPSK	MCS8 (13)
802.11n 40MHz	Ant.3	3, 6, 9	OFDM	BPSK	MCS0 (13)
802.11n 40MHz	Ant.1+2+3, CDD	3, 6, 9	OFDM	BPSK	MCS0 (13)
802.11n 40MHz	Ant.1+2+3, CDD	3, 6, 9	OFDM	BPSK	MCS8 (27)

Transmitter Radiated Emissions (1GHz~10th Harmonic)					
Operating Mode	IEEE 802.11b CH 1 / Ant. 1			Polarization	H
Temperature	24°C	Humidity	55%	Test Engineer	David Tseng

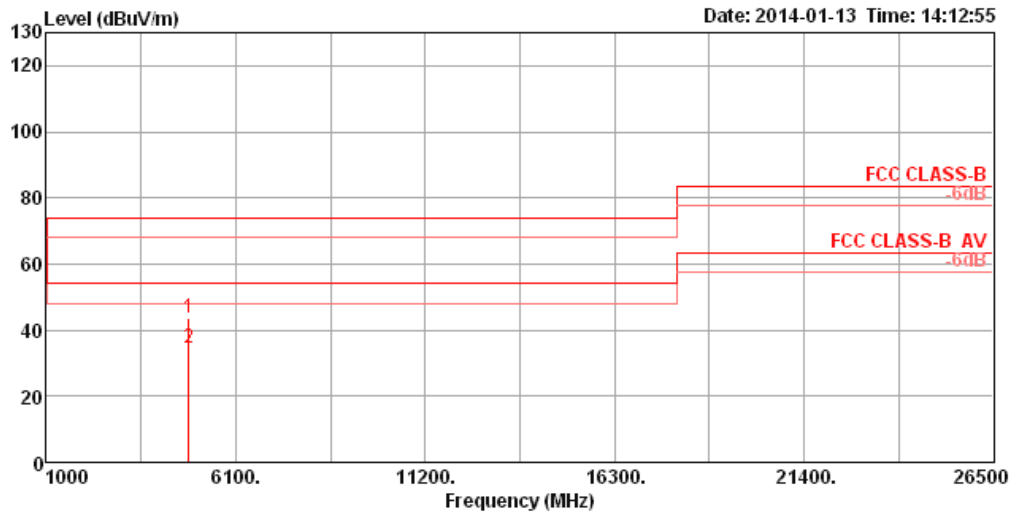

	Freq	Level	Limit	Over	Read	Cable	Antenna	Preamp	Remark	A/Pos	T/Pos	Pol/Phase
	MHz	dBuV/m	dBuV/m	dB	dBuV	dB	dB/m	dB		cm	deg	
1	4823.85	43.87	74.00	-30.13	42.53	3.31	33.06	35.03	Peak	100	307	HORIZONTAL
2	4823.95	34.59	54.00	-19.41	33.25	3.31	33.06	35.03	Average	100	307	HORIZONTAL

Note 1: The amplitude of spurious emissions which are attenuated by more than 20 dB below the permissible value has no need to be reported.
 Note 2: Emission level (dBuV/m) = 20 log Emission level (uV/m).
 Note 3: Corrected Reading: Antenna Factor + Cable Loss + Read Level - Preamp Factor = Level.
 Note 4: Measurement receive antenna polarization: H (Horizontal), V (Vertical)

Transmitter Radiated Emissions (1GHz~10th Harmonic)					
Operating Mode	IEEE 802.11b CH 1 / Ant. 1			Polarization	V
Temperature	24°C	Humidity	55%	Test Engineer	David Tseng

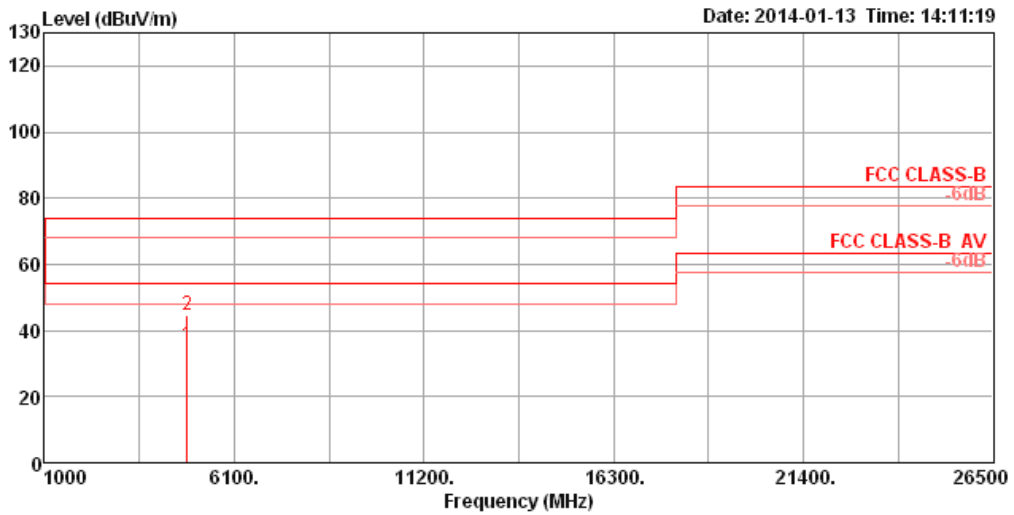

	Freq	Level	Limit	Over	Read	Cable	Antenna	Preamp	Remark	A/Pos	T/Pos	Pol/Phase
	MHz	dBuV/m	dBuV/m	dB	dBuV	dB	dB/m	dB		cm	deg	
1	4823.95	35.51	54.00	-18.49	34.17	3.31	33.06	35.03	Average	100	279	VERTICAL
2	4823.97	44.70	74.00	-29.30	43.36	3.31	33.06	35.03	Peak	100	279	VERTICAL

Note 1: The amplitude of spurious emissions which are attenuated by more than 20 dB below the permissible value has no need to be reported.
 Note 2: Emission level (dBuV/m) = 20 log Emission level (uV/m).
 Note 3: Corrected Reading: Antenna Factor + Cable Loss + Read Level - Preamp Factor = Level.
 Note 4: Measurement receive antenna polarization: H (Horizontal), V (Vertical)

Transmitter Radiated Emissions (1GHz~10th Harmonic)					
Operating Mode	IEEE 802.11b CH 6 / Ant. 1			Polarization	H
Temperature	24°C	Humidity	55%	Test Engineer	David Tseng

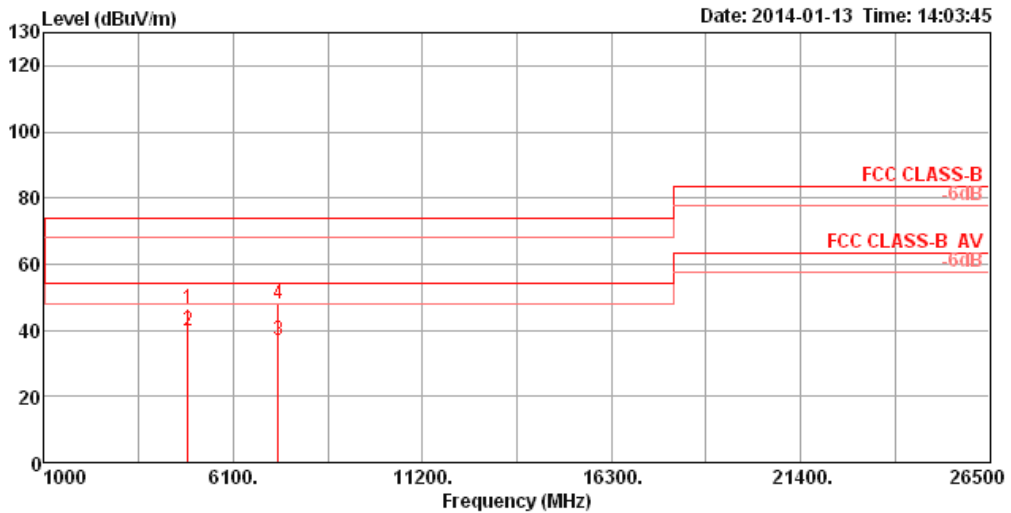

	Freq	Level	Limit	Over	Read	Cable	Antenna	Preamp	Remark	A/Pos	T/Pos	Pol/Phase
	MHz	dBuV/m	dBuV/m	dB	dBuV	dB	dB/m	dB		cm	deg	
1	4873.99	46.53	74.00	-27.47	45.07	3.33	33.16	35.03	Peak	100	360	HORIZONTAL
2	4874.04	39.62	54.00	-14.38	38.16	3.33	33.16	35.03	Average	100	360	HORIZONTAL
3	7310.24	36.80	54.00	-17.20	32.18	4.06	35.96	35.40	Average	137	0	HORIZONTAL
4	7312.11	48.08	74.00	-25.92	43.46	4.06	35.96	35.40	Peak	137	0	HORIZONTAL

Note 1: The amplitude of spurious emissions which are attenuated by more than 20 dB below the permissible value has no need to be reported.
 Note 2: Emission level (dBuV/m) = 20 log Emission level (uV/m).
 Note 3: Corrected Reading: Antenna Factor + Cable Loss + Read Level - Preamp Factor = Level.
 Note 4: Measurement receive antenna polarization: H (Horizontal), V (Vertical)

Transmitter Radiated Emissions (1GHz~10th Harmonic)					
Operating Mode	IEEE 802.11b CH 6 / Ant. 1			Polarization	V
Temperature	24°C	Humidity	55%	Test Engineer	David Tseng

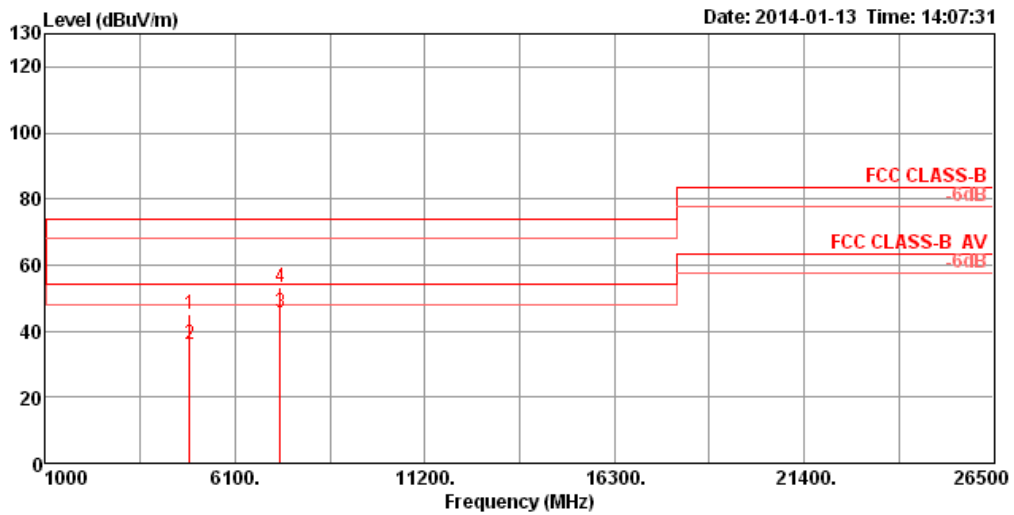

	Freq	Level	Limit	Over	Read	Cable	Antenna	Preamp	Remark	A/Pos	T/Pos	Pol/Phase
	MHz	dBuV/m	dBuV/m	dB	dBuV	dB	dB/m	dB		cm	deg	
1	4873.89	44.99	74.00	-29.01	43.53	3.33	33.16	35.03	Peak	100	281	VERTICAL
2	4874.02	35.99	54.00	-18.01	34.53	3.33	33.16	35.03	Average	100	281	VERTICAL
3	7310.30	45.66	54.00	-8.34	41.04	4.06	35.96	35.40	Average	115	275	VERTICAL
4	7312.03	53.15	74.00	-20.85	48.53	4.06	35.96	35.40	Peak	115	275	VERTICAL

Note 1: The amplitude of spurious emissions which are attenuated by more than 20 dB below the permissible value has no need to be reported.

Note 2: Emission level (dBuV/m) = 20 log Emission level (uV/m).

Note 3: Corrected Reading: Antenna Factor + Cable Loss + Read Level - Preamp Factor = Level.

Note 4: Measurement receive antenna polarization: H (Horizontal), V (Vertical)

Transmitter Radiated Emissions (1GHz~10th Harmonic)					
Operating Mode	IEEE 802.11b CH 11 / Ant. 1			Polarization	H
Temperature	24°C	Humidity	55%	Test Engineer	David Tseng

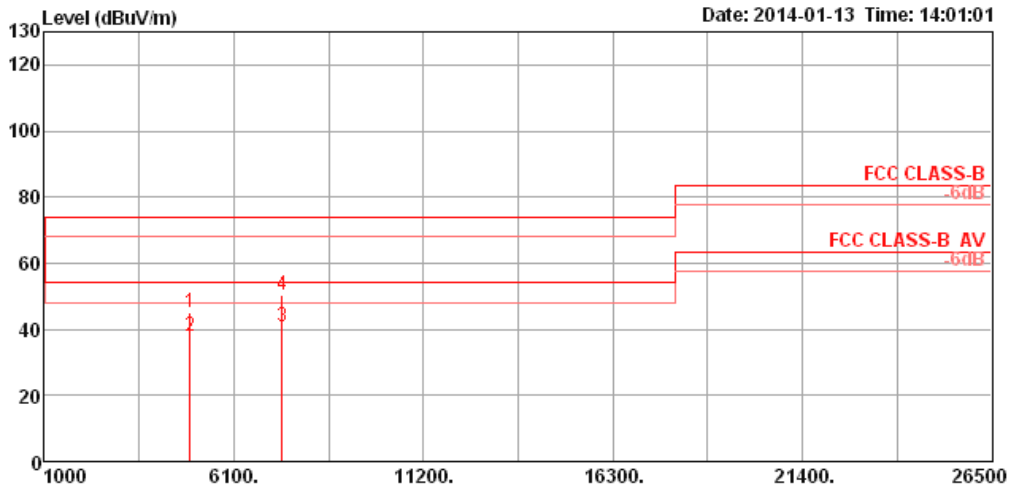

	Freq	Level	Limit Line	Over Limit	Read Level	Cable Loss	Antenna Factor	Preamp Factor	Remark	A/Pos	T/Pos	Pol/Phase
	MHz	dBuV/m	dBuV/m	dB	dBuV	dB	dB/m	dB		cm	deg	
1	4924.01	44.93	74.00	-29.07	43.33	3.35	33.26	35.01	Peak	100	2	HORIZONTAL
2	4924.03	37.66	54.00	-16.34	36.06	3.35	33.26	35.01	Average	100	2	HORIZONTAL
3	7385.30	41.01	54.00	-12.99	36.26	4.06	36.09	35.40	Average	109	259	HORIZONTAL
4	7385.75	50.16	74.00	-23.84	45.41	4.06	36.09	35.40	Peak	109	259	HORIZONTAL

Note 1: The amplitude of spurious emissions which are attenuated by more than 20 dB below the permissible value has no need to be reported.

Note 2: Emission level (dBuV/m) = 20 log Emission level (uV/m).

Note 3: Corrected Reading: Antenna Factor + Cable Loss + Read Level - Preamp Factor = Level.

Note 4: Measurement receive antenna polarization: H (Horizontal), V (Vertical)

Transmitter Radiated Emissions (1GHz~10th Harmonic)					
Operating Mode	IEEE 802.11b CH 11 / Ant. 1			Polarization	V
Temperature	24°C	Humidity	55%	Test Engineer	David Tseng

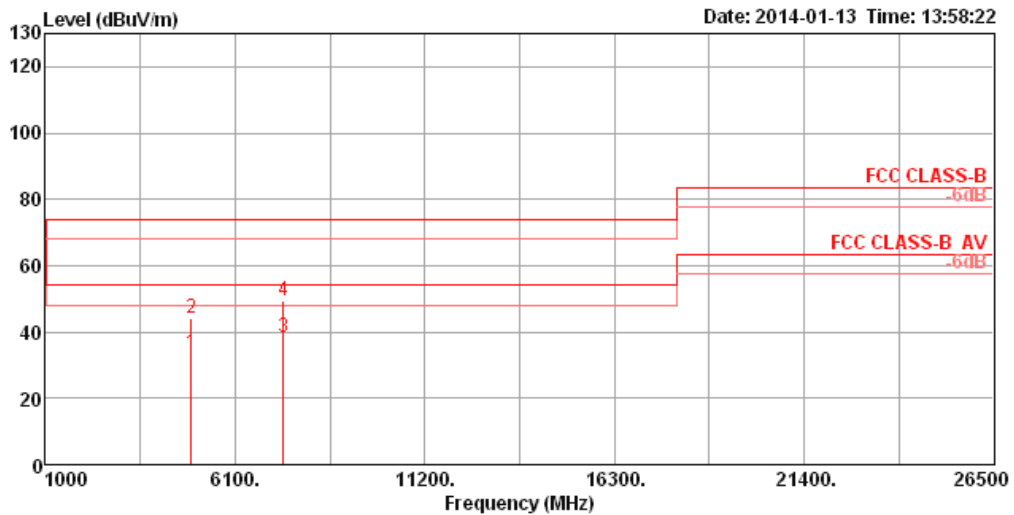

	Freq	Level	Limit	Over	Read	Cable	Antenna	Preamp	Remark	A/Pos	T/Pos	Pol/Phase
	MHz	dBuV/m	dBuV/m	dB	dBuV	dB	dB/m	dB		cm	deg	
1	4923.97	33.37	54.00	-20.63	31.77	3.35	33.26	35.01	Average	100	66	VERTICAL
2	4924.20	44.04	74.00	-29.96	42.44	3.35	33.26	35.01	Peak	100	66	VERTICAL
3	7385.37	38.38	54.00	-15.62	33.63	4.06	36.09	35.40	Average	100	309	VERTICAL
4	7386.86	49.42	74.00	-24.58	44.67	4.06	36.09	35.40	Peak	100	309	VERTICAL

Note 1: The amplitude of spurious emissions which are attenuated by more than 20 dB below the permissible value has no need to be reported.
 Note 2: Emission level (dBuV/m) = 20 log Emission level (uV/m).
 Note 3: Corrected Reading: Antenna Factor + Cable Loss + Read Level - Preamp Factor = Level.
 Note 4: Measurement receive antenna polarization: H (Horizontal), V (Vertical)

Transmitter Radiated Emissions (1GHz~10th Harmonic)					
Operating Mode	IEEE 802.11b CH 1 / Ant. 1+2+3			Polarization	H
Temperature	24°C	Humidity	55%	Test Engineer	David Tseng

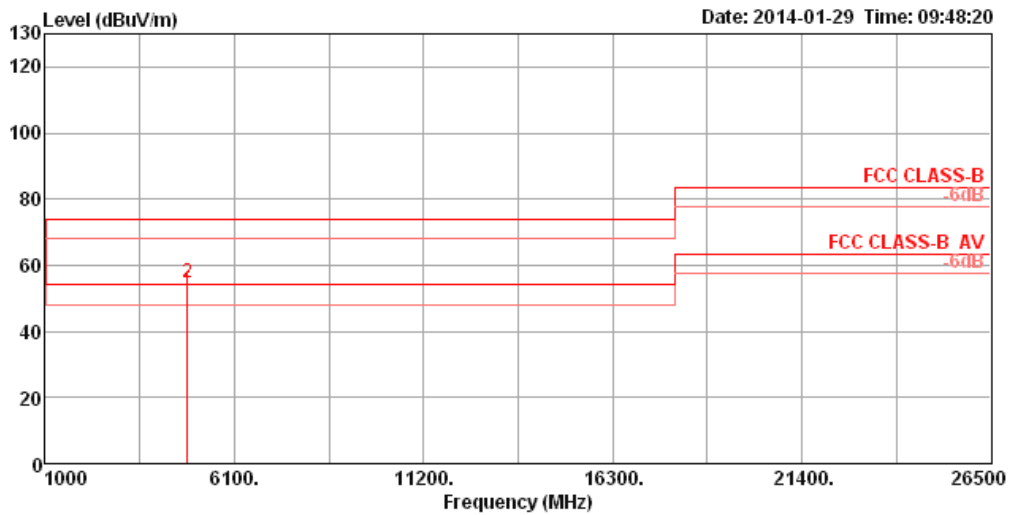

	Freq	Level	Limit	Over	Read	Cable	Antenna	Preamp	Remark	A/Pos	T/Pos	Pol/Phase
	MHz	dBuV/m	dBuV/m	dB	dBuV	dB	dB/m	dB		cm	deg	
1	4824.00	52.44	54.00	-1.56	51.10	3.31	33.06	35.03	Average	100	0	HORIZONTAL
2	4824.04	54.83	74.00	-19.17	53.49	3.31	33.06	35.03	Peak	100	0	HORIZONTAL

Note 1: The amplitude of spurious emissions which are attenuated by more than 20 dB below the permissible value has no need to be reported.
 Note 2: Emission level (dBuV/m) = 20 log Emission level (uV/m).
 Note 3: Corrected Reading: Antenna Factor + Cable Loss + Read Level - Preamp Factor = Level.
 Note 4: Measurement receive antenna polarization: H (Horizontal), V (Vertical)

Transmitter Radiated Emissions (1GHz~10th Harmonic)					
Operating Mode	IEEE 802.11b CH 1 / Ant. 1+2+3			Polarization	V
Temperature	24°C	Humidity	55%	Test Engineer	David Tseng

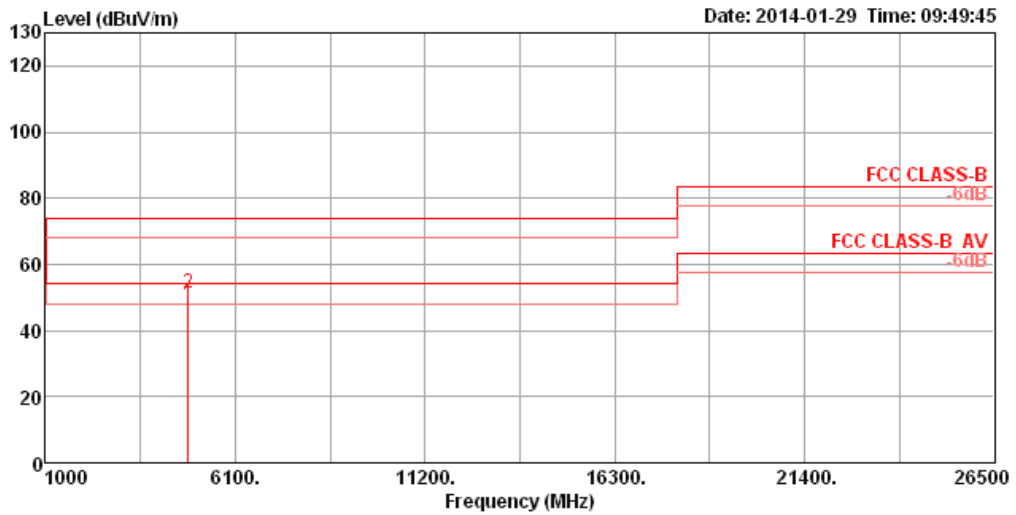

	Freq	Level	Limit	Over	Read	Cable	Antenna	Preamp	Remark	A/Pos	T/Pos	Pol/Phase
	MHz	dBuV/m	dBuV/m	dB	dBuV	dB	dB/m	dB		cm	deg	
1	4823.99	47.81	54.00	-6.19	46.47	3.31	33.06	35.03	Average	100	266	VERTICAL
2	4824.00	51.20	74.00	-22.80	49.86	3.31	33.06	35.03	Peak	100	266	VERTICAL

Note 1: The amplitude of spurious emissions which are attenuated by more than 20 dB below the permissible value has no need to be reported.
 Note 2: Emission level (dBuV/m) = 20 log Emission level (uV/m).
 Note 3: Corrected Reading: Antenna Factor + Cable Loss + Read Level - Preamp Factor = Level.
 Note 4: Measurement receive antenna polarization: H (Horizontal), V (Vertical)

Transmitter Radiated Emissions (1GHz~10th Harmonic)					
Operating Mode	IEEE 802.11b CH 6 / Ant. 1+2+3			Polarization	H
Temperature	24°C	Humidity	55%	Test Engineer	David Tseng

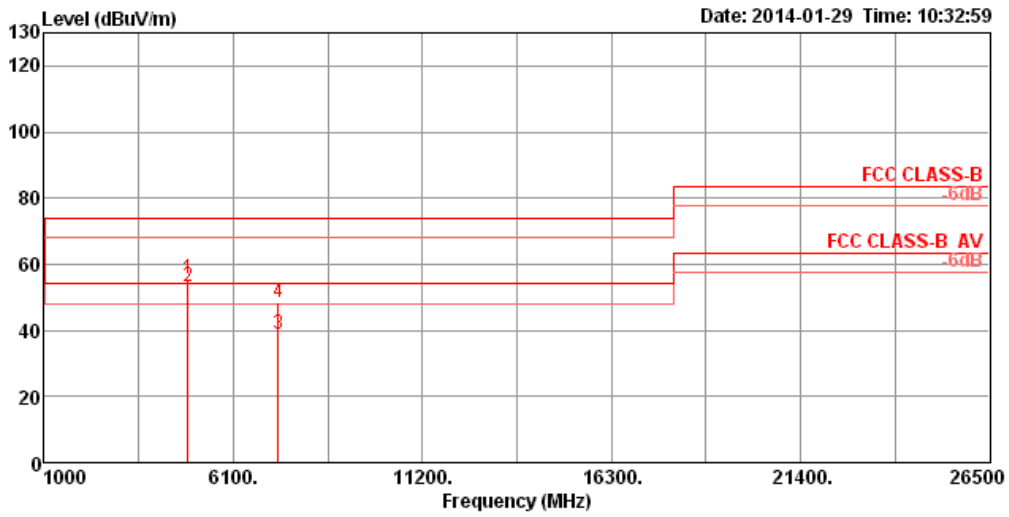

	Freq	Level	Limit Line	Over Limit	Read Level	Cable Loss	Antenna Factor	Preamp Factor	Remark	A/Pos	T/Pos	Pol/Phase
	MHz	dBuV/m	dBuV/m	dB	dBuV	dB	dB/m	dB		cm	deg	
1	4873.98	55.50	74.00	-18.50	54.04	3.33	33.16	35.03	Peak	100	352	HORIZONTAL
2	4874.01	53.42	54.00	-0.58	51.96	3.33	33.16	35.03	Average	100	352	HORIZONTAL
3	7310.26	39.02	54.00	-14.98	34.40	4.06	35.96	35.40	Average	100	173	HORIZONTAL
4	7310.58	48.64	74.00	-25.36	44.02	4.06	35.96	35.40	Peak	100	173	HORIZONTAL

Note 1: The amplitude of spurious emissions which are attenuated by more than 20 dB below the permissible value has no need to be reported.

Note 2: Emission level (dBuV/m) = 20 log Emission level (uV/m).

Note 3: Corrected Reading: Antenna Factor + Cable Loss + Read Level - Preamp Factor = Level.

Note 4: Measurement receive antenna polarization: H (Horizontal), V (Vertical)

Transmitter Radiated Emissions (1GHz~10th Harmonic)					
Operating Mode	IEEE 802.11b CH 6 / Ant. 1+2+3			Polarization	V
Temperature	24°C	Humidity	55%	Test Engineer	David Tseng

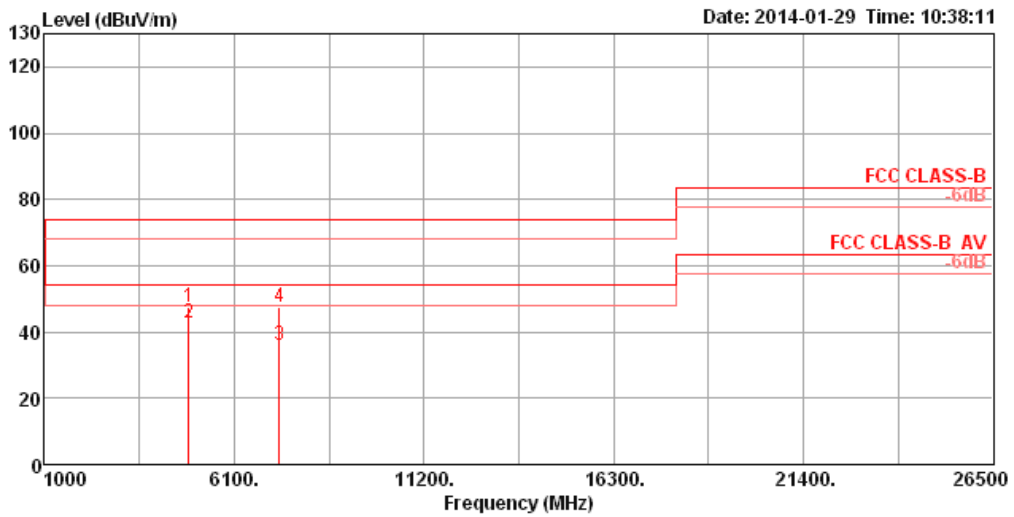

	Freq	Level	Limit Line	Over Limit	Read Level	Cable Loss	Antenna Factor	Preamp Factor	Remark	A/Pos	T/Pos	Pol/Phase
	MHz	dBuV/m	dBuV/m	dB	dBuV	dB	dB/m	dB		cm	deg	
1	4873.96	47.40	74.00	-26.60	45.94	3.33	33.16	35.03	Peak	100	65	VERTICAL
2	4874.07	42.84	54.00	-11.16	41.38	3.33	33.16	35.03	Average	100	65	VERTICAL
3	7310.20	35.87	54.00	-18.13	31.25	4.06	35.96	35.40	Average	100	34	VERTICAL
4	7311.13	47.60	74.00	-26.40	42.98	4.06	35.96	35.40	Peak	100	34	VERTICAL

Note 1: The amplitude of spurious emissions which are attenuated by more than 20 dB below the permissible value has no need to be reported.
 Note 2: Emission level (dBuV/m) = 20 log Emission level (uV/m).
 Note 3: Corrected Reading: Antenna Factor + Cable Loss + Read Level - Preamp Factor = Level.
 Note 4: Measurement receive antenna polarization: H (Horizontal), V (Vertical)

Transmitter Radiated Emissions (1GHz~10th Harmonic)					
Operating Mode	IEEE 802.11b CH 11 / Ant. 1+2+3			Polarization	H
Temperature	24°C	Humidity	55%	Test Engineer	David Tseng

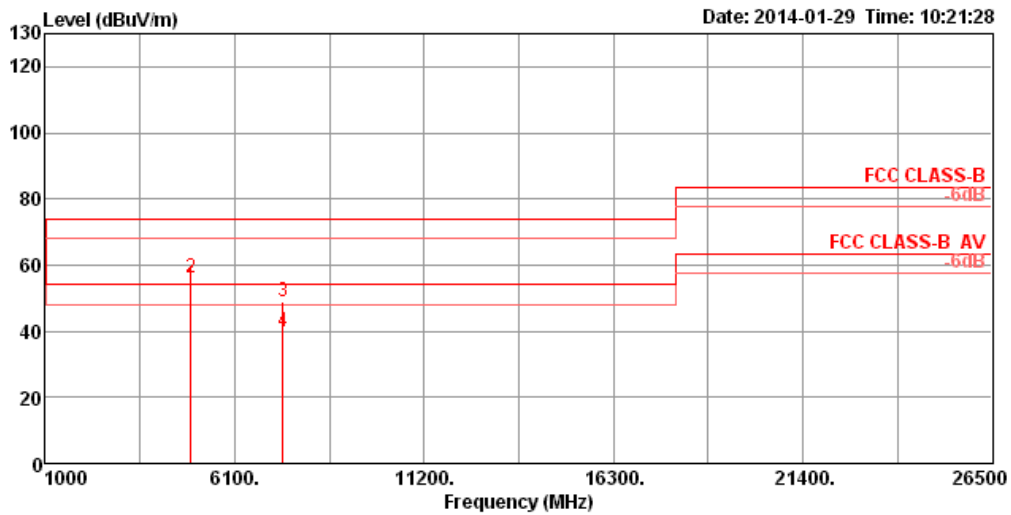

Freq	Level	Limit Line	Over Limit	Read Level	Cable Loss	Antenna Factor	Preamp Factor	Remark	A/Pos	T/Pos	Pol/Phase	
MHz	dBuV/m	dBuV/m	dB	dBuV	dB	dB/m	dB		cm	deg		
1	4923.98	53.91	54.00	-0.09	52.31	3.35	33.26	35.01	Average	100	1	HORIZONTAL
2	4924.05	56.07	74.00	-17.93	54.47	3.35	33.26	35.01	Peak	100	1	HORIZONTAL
3	7385.25	49.13	74.00	-24.87	44.38	4.06	36.09	35.40	Peak	100	321	HORIZONTAL
4	7386.80	39.61	54.00	-14.39	34.86	4.06	36.09	35.40	Average	100	321	HORIZONTAL

Note 1: The amplitude of spurious emissions which are attenuated by more than 20 dB below the permissible value has no need to be reported.

Note 2: Emission level (dBuV/m) = 20 log Emission level (uV/m).

Note 3: Corrected Reading: Antenna Factor + Cable Loss + Read Level - Preamp Factor = Level.

Note 4: Measurement receive antenna polarization: H (Horizontal), V (Vertical)

Transmitter Radiated Emissions (1GHz~10th Harmonic)					
Operating Mode	IEEE 802.11b CH 11 / Ant. 1+2+3			Polarization	V
Temperature	24°C	Humidity	55%	Test Engineer	David Tseng

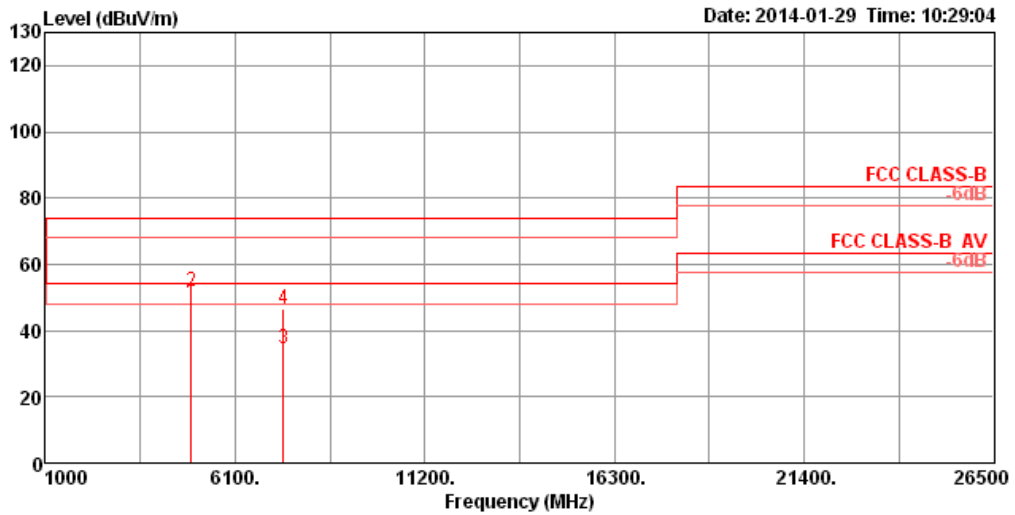

	Freq	Level	Limit Line	Over Limit	Read Level	Cable Loss	Antenna Factor	Preamp Factor	Remark	A/Pos	T/Pos	Pol/Phase
	MHz	dBuV/m	dBuV/m	dB	dBuV	dB	dB/m	dB		cm	deg	
1	4924.00	48.56	54.00	-5.44	46.96	3.35	33.26	35.01	Average	102	82	VERTICAL
2	4924.07	51.88	74.00	-22.12	50.28	3.35	33.26	35.01	Peak	102	82	VERTICAL
3	7385.42	34.74	54.00	-19.26	29.99	4.06	36.09	35.40	Average	100	279	VERTICAL
4	7390.17	46.32	74.00	-27.68	41.57	4.06	36.09	35.40	Peak	100	279	VERTICAL

Note 1: The amplitude of spurious emissions which are attenuated by more than 20 dB below the permissible value has no need to be reported.
 Note 2: Emission level (dBuV/m) = 20 log Emission level (uV/m).
 Note 3: Corrected Reading: Antenna Factor + Cable Loss + Read Level - Preamp Factor = Level.
 Note 4: Measurement receive antenna polarization: H (Horizontal), V (Vertical)

Transmitter Radiated Emissions (1GHz~10th Harmonic)					
Operating Mode	IEEE 802.11g CH 1 / Ant. 1			Polarization	H
Temperature	24°C	Humidity	55%	Test Engineer	David Tseng

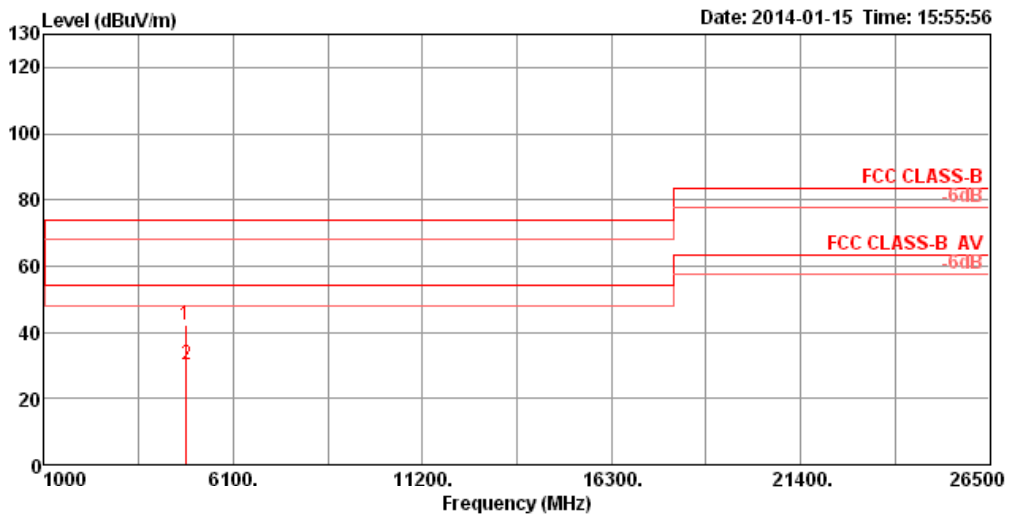

	Freq	Level	Limit	Over	Read	Cable	Antenna	Preamp	Remark	A/Pos	T/Pos	Pol/Phase
	MHz	dBuV/m	dBuV/m	dB	dBuV	dB	dB/m	dB		cm	deg	
1	4815.83	42.27	74.00	-31.73	40.98	3.31	33.02	35.04	Peak	100	123	HORIZONTAL
2	4822.69	30.25	54.00	-23.75	28.91	3.31	33.06	35.03	Average	100	123	HORIZONTAL

Note 1: The amplitude of spurious emissions which are attenuated by more than 20 dB below the permissible value has no need to be reported.
 Note 2: Emission level (dBuV/m) = 20 log Emission level (uV/m).
 Note 3: Corrected Reading: Antenna Factor + Cable Loss + Read Level - Preamp Factor = Level.
 Note 4: Measurement receive antenna polarization: H (Horizontal), V (Vertical)

Transmitter Radiated Emissions (1GHz~10th Harmonic)					
Operating Mode	IEEE 802.11g CH 1 / Ant. 1			Polarization	V
Temperature	24°C	Humidity	55%	Test Engineer	David Tseng

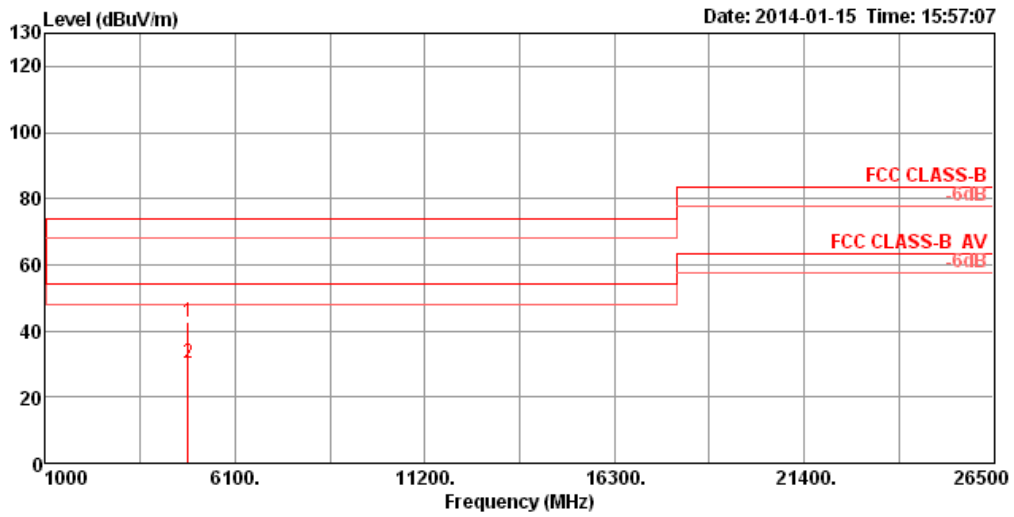

Freq	Level	Line	Limit	Level	Cable Loss	Antenna Factor	Preamp Factor	Remark	A/Pos	T/Pos	Pol/Phase	
MHz	dBuV/m	dBuV/m	dB	dBuV	dB	dB/m	dB		cm	deg		
1	4826.15	42.89	74.00	-31.11	41.55	3.31	33.06	35.03	Peak	100	325	VERTICAL
2	4831.56	30.14	54.00	-23.86	28.80	3.31	33.06	35.03	Average	100	325	VERTICAL

Note 1: The amplitude of spurious emissions which are attenuated by more than 20 dB below the permissible value has no need to be reported.
 Note 2: Emission level (dBuV/m) = 20 log Emission level (uV/m).
 Note 3: Corrected Reading: Antenna Factor + Cable Loss + Read Level - Preamp Factor = Level.
 Note 4: Measurement receive antenna polarization: H (Horizontal), V (Vertical)

Transmitter Radiated Emissions (1GHz~10th Harmonic)					
Operating Mode	IEEE 802.11g CH 6 / Ant. 1			Polarization	H
Temperature	24°C	Humidity	55%	Test Engineer	David Tseng

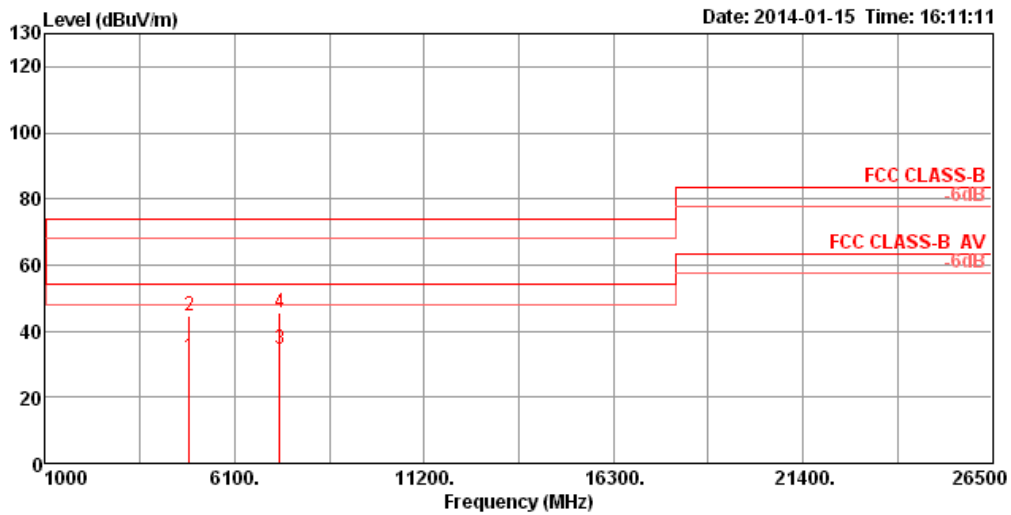

	Freq	Level	Limit	Over	Read	Cable	Antenna	Preamp	Remark	A/Pos	T/Pos	Pol/Phase
	MHz	dBuV/m	dBuV/m	dB	dBuV	dB	dB/m	dB		cm	deg	
1	4873.62	32.23	54.00	-21.77	30.77	3.33	33.16	35.03	Average	100	360	HORIZONTAL
2	4873.78	44.76	74.00	-29.24	43.30	3.33	33.16	35.03	Peak	100	360	HORIZONTAL
3	7313.40	34.38	54.00	-19.62	29.76	4.06	35.96	35.40	Average	100	7	HORIZONTAL
4	7316.45	45.57	74.00	-28.43	40.95	4.06	35.96	35.40	Peak	100	7	HORIZONTAL

Note 1: The amplitude of spurious emissions which are attenuated by more than 20 dB below the permissible value has no need to be reported.
 Note 2: Emission level (dBuV/m) = 20 log Emission level (uV/m).
 Note 3: Corrected Reading: Antenna Factor + Cable Loss + Read Level - Preamp Factor = Level.
 Note 4: Measurement receive antenna polarization: H (Horizontal), V (Vertical)

Transmitter Radiated Emissions (1GHz~10th Harmonic)					
Operating Mode	IEEE 802.11g CH 6 / Ant. 1			Polarization	V
Temperature	24°C	Humidity	55%	Test Engineer	David Tseng

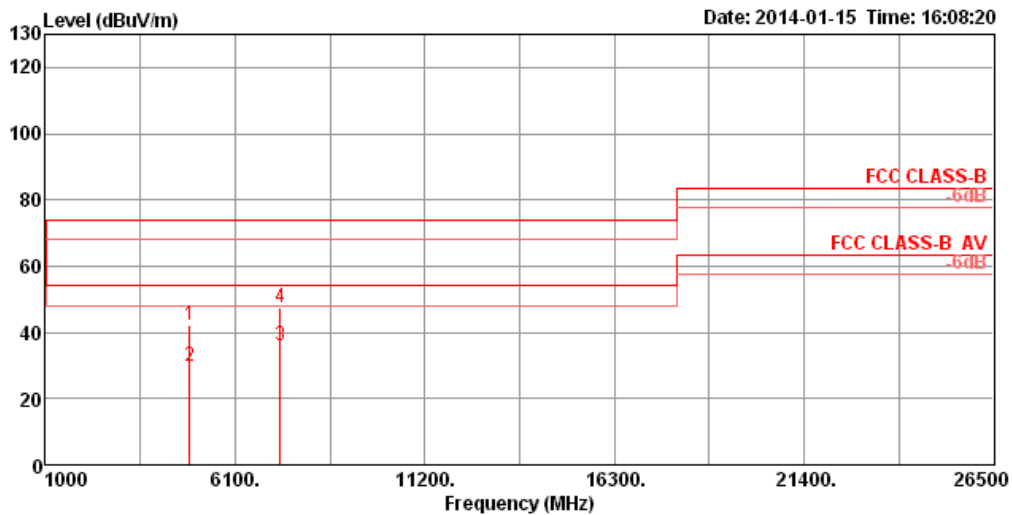

	Freq	Level	Limit	Over	Read	Cable	Antenna	Preamp	Remark	A/Pos	T/Pos	Pol/Phase
	MHz	dBuV/m	dBuV/m	dB	dBuV	dB	dB/m	dB		cm	deg	
1	4872.96	42.42	74.00	-31.58	40.96	3.33	33.16	35.03	Peak	100	92	VERTICAL
2	4875.06	29.93	54.00	-24.07	28.47	3.33	33.16	35.03	Average	100	92	VERTICAL
3	7311.10	35.99	54.00	-18.01	31.37	4.06	35.96	35.40	Average	100	312	VERTICAL
4	7313.53	47.62	74.00	-26.38	43.00	4.06	35.96	35.40	Peak	100	312	VERTICAL

Note 1: The amplitude of spurious emissions which are attenuated by more than 20 dB below the permissible value has no need to be reported.

Note 2: Emission level (dBuV/m) = 20 log Emission level (uV/m).

Note 3: Corrected Reading: Antenna Factor + Cable Loss + Read Level - Preamp Factor = Level.

Note 4: Measurement receive antenna polarization: H (Horizontal), V (Vertical)

Transmitter Radiated Emissions (1GHz~10th Harmonic)					
Operating Mode	IEEE 802.11g CH 11 / Ant. 1			Polarization	H
Temperature	24°C	Humidity	55%	Test Engineer	David Tseng

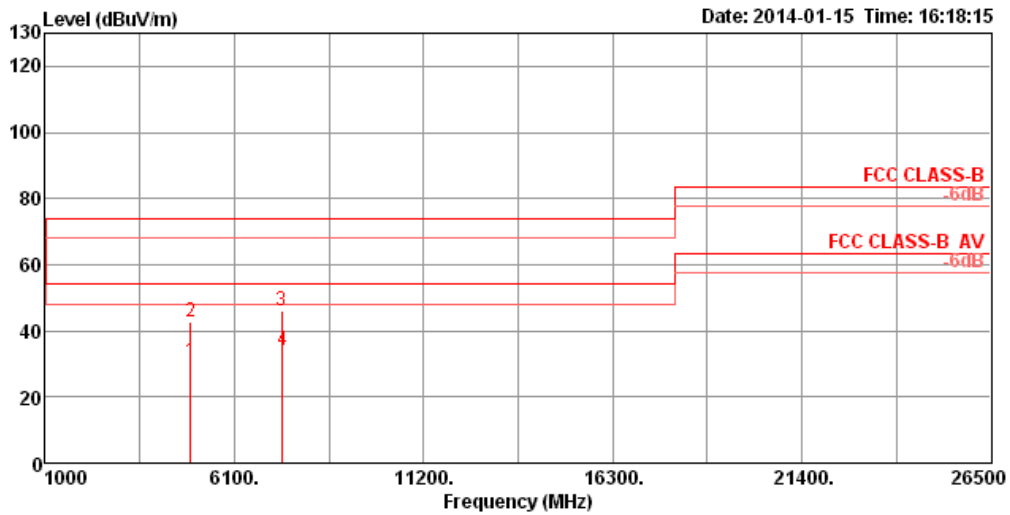

	Freq	Level	Limit	Over	Read	Cable	Antenna	Preamp	Remark	A/Pos	T/Pos	Pol/Phase
	MHz	dBuV/m	dBuV/m	dB	dBuV	dB	dB/m	dB		cm	deg	
1	4920.80	30.57	54.00	-23.43	29.00	3.35	33.23	35.01	Average	100	125	HORIZONTAL
2	4922.33	42.72	74.00	-31.28	41.12	3.35	33.26	35.01	Peak	100	125	HORIZONTAL
3	7381.51	45.87	74.00	-28.13	41.12	4.06	36.09	35.40	Peak	100	327	HORIZONTAL
4	7386.16	34.00	54.00	-20.00	29.25	4.06	36.09	35.40	Average	100	327	HORIZONTAL

Note 1: The amplitude of spurious emissions which are attenuated by more than 20 dB below the permissible value has no need to be reported.
 Note 2: Emission level (dBuV/m) = 20 log Emission level (uV/m).
 Note 3: Corrected Reading: Antenna Factor + Cable Loss + Read Level - Preamp Factor = Level.
 Note 4: Measurement receive antenna polarization: H (Horizontal), V (Vertical)

Transmitter Radiated Emissions (1GHz~10th Harmonic)					
Operating Mode	IEEE 802.11g CH 11 / Ant. 1			Polarization	V
Temperature	24°C	Humidity	55%	Test Engineer	David Tseng

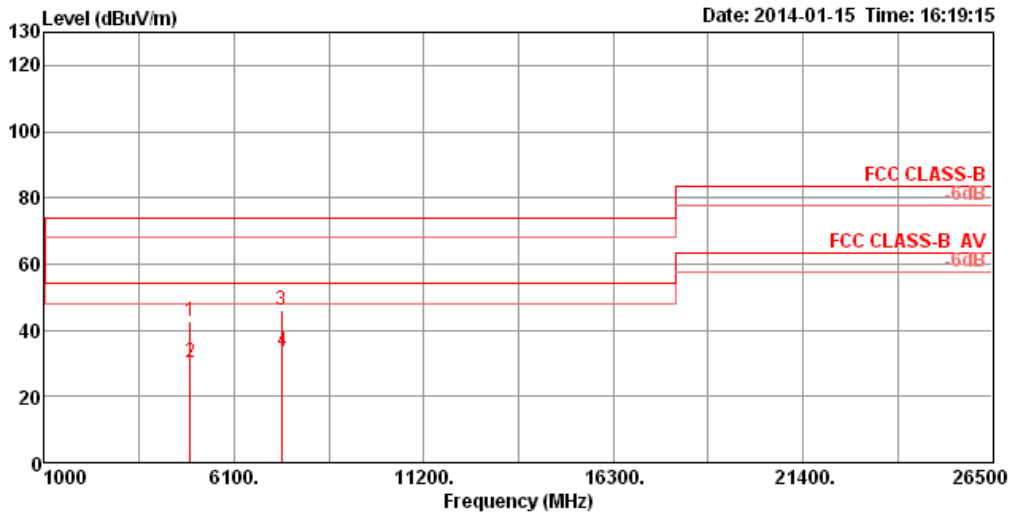

	Freq	Level	Limit	Over	Read	Cable	Antenna	Preamp	Remark	A/Pos	T/Pos	Pol/Phase
	MHz	dBuV/m	dBuV/m	dB	dBuV	dB	dB/m	dB		cm	deg	
1	4921.12	42.46	74.00	-31.54	40.89	3.35	33.23	35.01	Peak	100	3	VERTICAL
2	4922.21	30.17	54.00	-23.83	28.57	3.35	33.26	35.01	Average	100	3	VERTICAL
3	7383.47	46.10	74.00	-27.90	41.35	4.06	36.09	35.40	Peak	100	207	VERTICAL
4	7385.87	33.40	54.00	-20.60	28.65	4.06	36.09	35.40	Average	100	207	VERTICAL

Note 1: The amplitude of spurious emissions which are attenuated by more than 20 dB below the permissible value has no need to be reported.
 Note 2: Emission level (dBuV/m) = 20 log Emission level (uV/m).
 Note 3: Corrected Reading: Antenna Factor + Cable Loss + Read Level - Preamp Factor = Level.
 Note 4: Measurement receive antenna polarization: H (Horizontal), V (Vertical)

Transmitter Radiated Emissions (1GHz~10th Harmonic)					
Operating Mode	IEEE 802.11g CH 1 / Ant. 1+2+3			Polarization	H
Temperature	24°C	Humidity	55%	Test Engineer	David Tseng

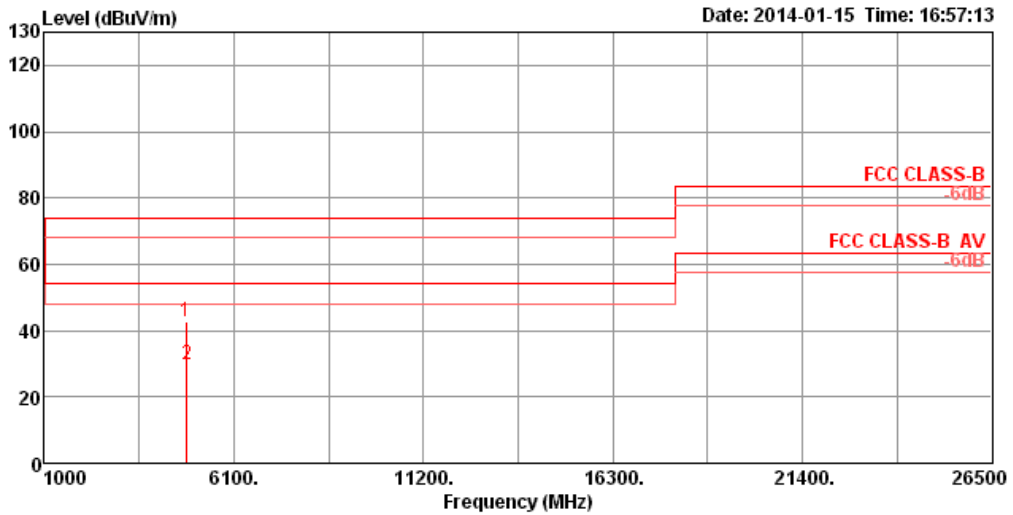

	Freq	Level	Limit Line	Over Limit	Read Level	Cable Loss	Antenna Factor	Preamp Factor	Remark	A/Pos	T/Pos	Pol/Phase
	MHz	dBuV/m	dBuV/m	dB	dBuV	dB	dB/m	dB		cm	deg	
1	4819.90	42.60	74.00	-31.40	41.26	3.31	33.06	35.03	Peak	100	244	HORIZONTAL
2	4821.95	29.81	54.00	-24.19	28.47	3.31	33.06	35.03	Average	100	244	HORIZONTAL

Note 1: The amplitude of spurious emissions which are attenuated by more than 20 dB below the permissible value has no need to be reported.
 Note 2: Emission level (dBuV/m) = 20 log Emission level (uV/m).
 Note 3: Corrected Reading: Antenna Factor + Cable Loss + Read Level - Preamp Factor = Level.
 Note 4: Measurement receive antenna polarization: H (Horizontal), V (Vertical)

Transmitter Radiated Emissions (1GHz~10th Harmonic)					
Operating Mode	IEEE 802.11g CH 1 / Ant. 1+2+3			Polarization	V
Temperature	24°C	Humidity	55%	Test Engineer	David Tseng

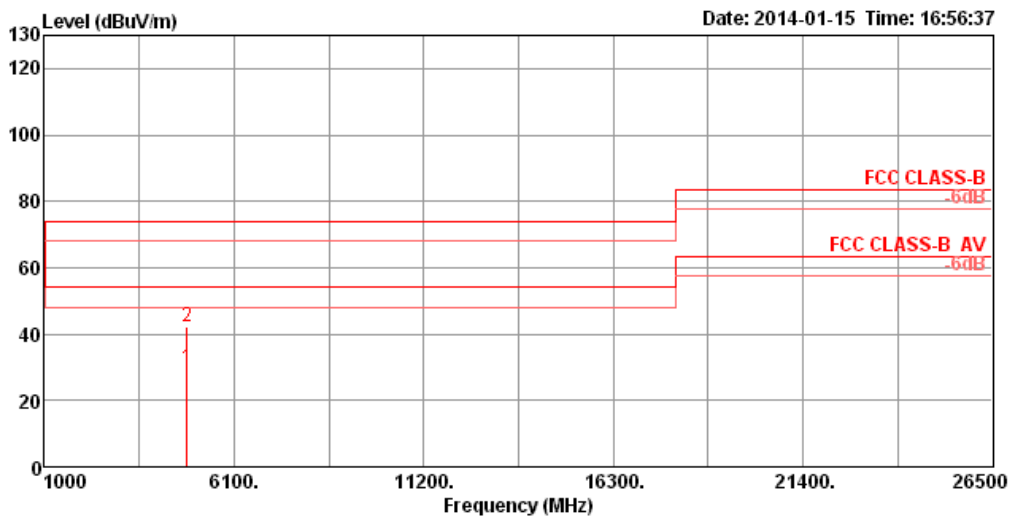

	Freq	Level	Limit Line	Over Limit	Read Level	Cable Loss	Antenna Factor	Preamp Factor	Remark	A/Pos	T/Pos	Pol/Phase
	MHz	dBuV/m	dBuV/m	dB	dBuV	dB	dB/m	dB		cm	deg	
1	4823.78	29.77	54.00	-24.23	28.43	3.31	33.06	35.03	Average	100	202	VERTICAL
2	4827.46	42.10	74.00	-31.90	40.76	3.31	33.06	35.03	Peak	100	202	VERTICAL

Note 1: The amplitude of spurious emissions which are attenuated by more than 20 dB below the permissible value has no need to be reported.
 Note 2: Emission level (dBuV/m) = 20 log Emission level (uV/m).
 Note 3: Corrected Reading: Antenna Factor + Cable Loss + Read Level - Preamp Factor = Level.
 Note 4: Measurement receive antenna polarization: H (Horizontal), V (Vertical)

Transmitter Radiated Emissions (1GHz~10th Harmonic)					
Operating Mode	IEEE 802.11g CH 6 / Ant. 1+2+3			Polarization	H
Temperature	24°C	Humidity	55%	Test Engineer	David Tseng

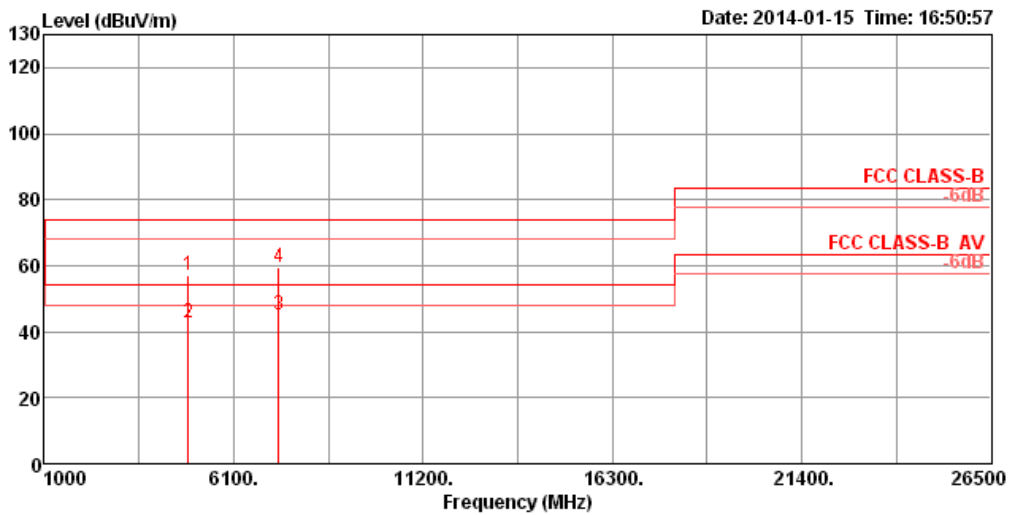

	Freq	Level	Limit Line	Over Limit	Read Level	Cable Loss	Antenna Factor	Preamp Factor	Remark	A/Pos	T/Pos	Pol/Phase
	MHz	dBuV/m	dBuV/m	dB	dBuV	dB	dB/m	dB		cm	deg	
1	4873.94	56.85	74.00	-17.15	55.39	3.33	33.16	35.03	Peak	100	1	HORIZONTAL
2	4875.38	42.85	54.00	-11.15	41.39	3.33	33.16	35.03	Average	100	1	HORIZONTAL
3	7312.96	45.22	54.00	-8.78	40.60	4.06	35.96	35.40	Average	111	274	HORIZONTAL
4	7313.95	59.44	74.00	-14.56	54.82	4.06	35.96	35.40	Peak	111	274	HORIZONTAL

Note 1: The amplitude of spurious emissions which are attenuated by more than 20 dB below the permissible value has no need to be reported.
 Note 2: Emission level (dBuV/m) = 20 log Emission level (uV/m).
 Note 3: Corrected Reading: Antenna Factor + Cable Loss + Read Level - Preamp Factor = Level.
 Note 4: Measurement receive antenna polarization: H (Horizontal), V (Vertical)

Transmitter Radiated Emissions (1GHz~10th Harmonic)					
Operating Mode	IEEE 802.11g CH 6 / Ant. 1+2+3			Polarization	V
Temperature	24°C	Humidity	55%	Test Engineer	David Tseng

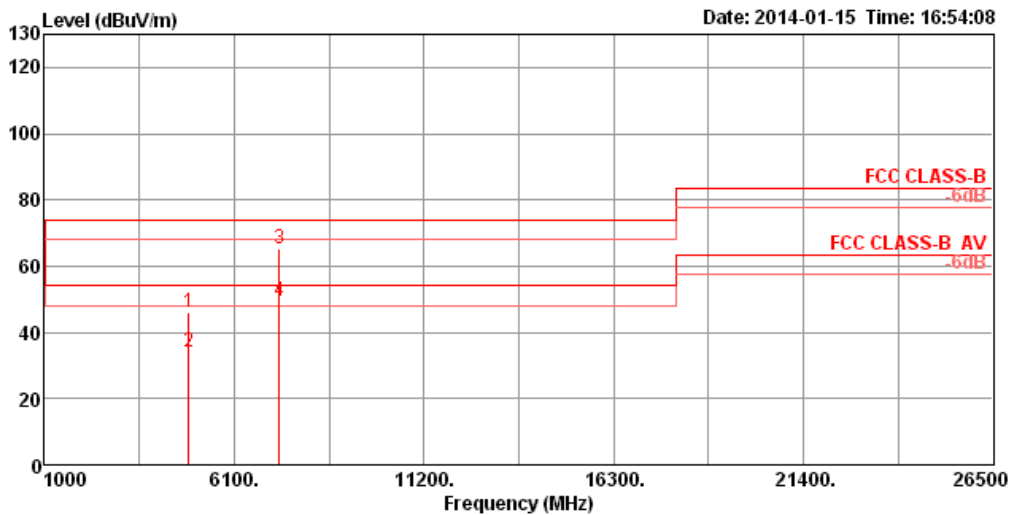

	Freq	Level	Limit	Over	Read	Cable	Antenna	Preamp	Remark	A/Pos	T/Pos	Pol/Phase
	MHz	dBuV/m	dBuV/m	dB	dBuV	dB	dB/m	dB		cm	deg	
1	4873.62	46.25	74.00	-27.75	44.79	3.33	33.16	35.03	Peak	100	188	VERTICAL
2	4873.81	33.94	54.00	-20.06	32.48	3.33	33.16	35.03	Average	100	188	VERTICAL
3	7314.37	65.38	74.00	-8.62	60.76	4.06	35.96	35.40	Peak	131	275	VERTICAL
4	7314.65	49.53	54.00	-4.47	44.91	4.06	35.96	35.40	Average	131	275	VERTICAL

Note 1: The amplitude of spurious emissions which are attenuated by more than 20 dB below the permissible value has no need to be reported.
 Note 2: Emission level (dBuV/m) = 20 log Emission level (uV/m).
 Note 3: Corrected Reading: Antenna Factor + Cable Loss + Read Level - Preamp Factor = Level.
 Note 4: Measurement receive antenna polarization: H (Horizontal), V (Vertical)

Transmitter Radiated Emissions (1GHz~10th Harmonic)					
Operating Mode	IEEE 802.11g CH 11 / Ant. 1+2+3			Polarization	H
Temperature	24°C	Humidity	55%	Test Engineer	David Tseng

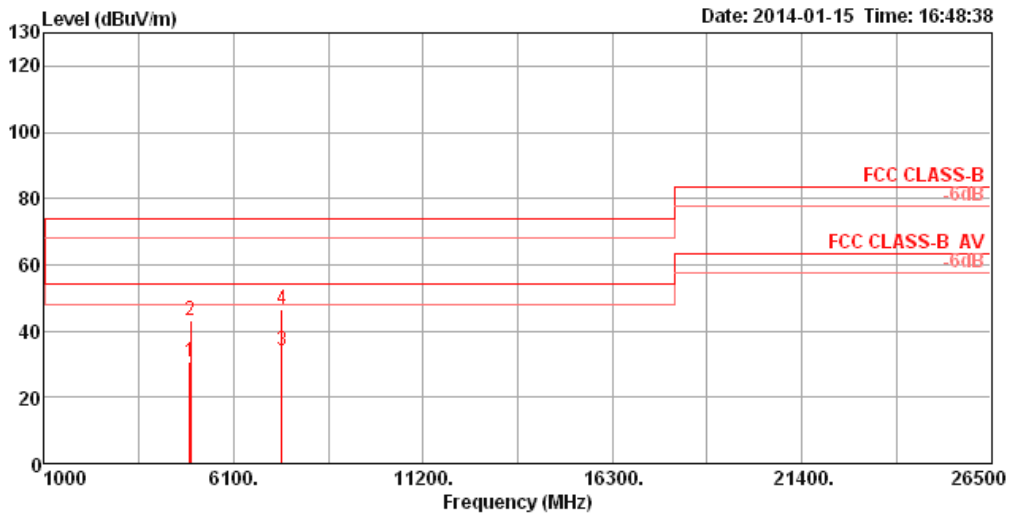

	Freq	Level	Limit	Over	Read	Cable	Antenna	Preamp	Remark	A/Pos	T/Pos	Pol/Phase
	MHz	dBuV/m	dBuV/m	dB	dBuV	dB	dB/m	dB		cm	deg	
1	4924.80	30.63	54.00	-23.37	29.03	3.35	33.26	35.01	Average	100	330	HORIZONTAL
2	4926.82	43.03	74.00	-30.97	41.43	3.35	33.26	35.01	Peak	100	330	HORIZONTAL
3	7385.94	34.18	54.00	-19.82	29.43	4.06	36.09	35.40	Average	100	257	HORIZONTAL
4	7388.12	46.44	74.00	-27.56	41.69	4.06	36.09	35.40	Peak	100	257	HORIZONTAL

Note 1: The amplitude of spurious emissions which are attenuated by more than 20 dB below the permissible value has no need to be reported.
 Note 2: Emission level (dBuV/m) = 20 log Emission level (uV/m).
 Note 3: Corrected Reading: Antenna Factor + Cable Loss + Read Level - Preamp Factor = Level.
 Note 4: Measurement receive antenna polarization: H (Horizontal), V (Vertical)

Transmitter Radiated Emissions (1GHz~10th Harmonic)					
Operating Mode	IEEE 802.11g CH 11 / Ant. 1+2+3			Polarization	V
Temperature	24°C	Humidity	55%	Test Engineer	David Tseng

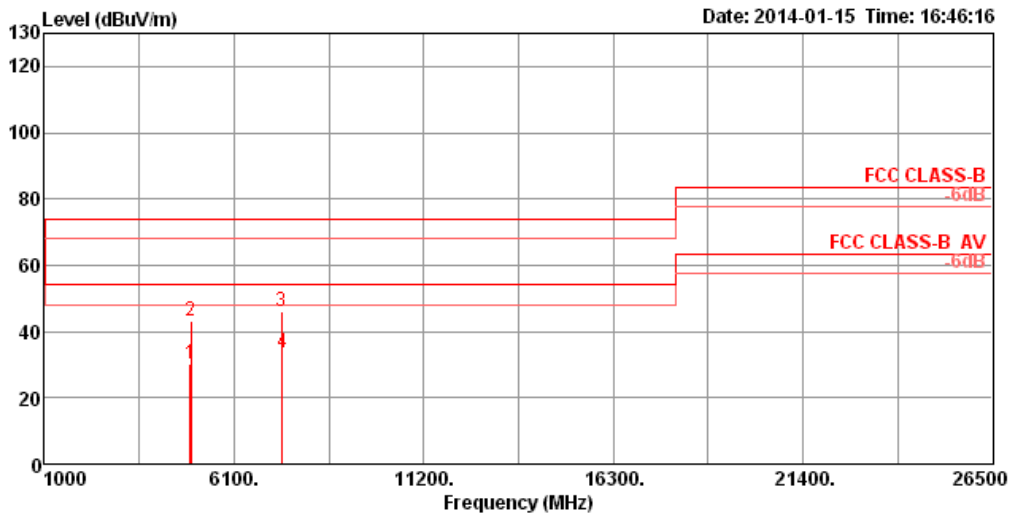

	Freq	Level	Limit	Over	Read	Cable	Antenna	Preamp	Remark	A/Pos	T/Pos	Pol/Phase
	MHz	dBuV/m	dBuV/m	dB	dBuV	dB	dB/m	dB		cm	deg	
1	4920.47	30.24	54.00	-23.76	28.67	3.35	33.23	35.01	Average	100	8	VERTICAL
2	4932.62	43.11	74.00	-30.89	41.51	3.35	33.26	35.01	Peak	100	8	VERTICAL
3	7376.16	45.99	74.00	-28.01	41.24	4.06	36.09	35.40	Peak	100	331	VERTICAL
4	7388.69	33.74	54.00	-20.26	28.99	4.06	36.09	35.40	Average	100	331	VERTICAL

Note 1: The amplitude of spurious emissions which are attenuated by more than 20 dB below the permissible value has no need to be reported.

Note 2: Emission level (dBuV/m) = 20 log Emission level (uV/m).

Note 3: Corrected Reading: Antenna Factor + Cable Loss + Read Level - Preamp Factor = Level.

Note 4: Measurement receive antenna polarization: H (Horizontal), V (Vertical)

Transmitter Radiated Emissions (1GHz~10th Harmonic)					
Operating Mode	IEEE 802.11n 20MHz MCS0 CH 1 / Ant. 1			Polarization	H
Temperature	24°C	Humidity	55%	Test Engineer	David Tseng

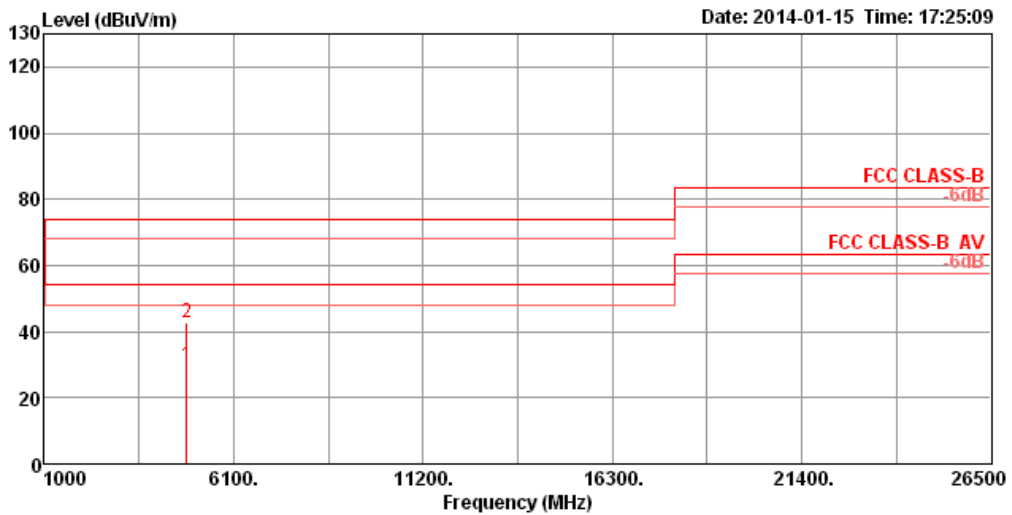

	Freq	Level	Limit	Over	Read	Cable	Antenna	Preamp	Remark	A/Pos	T/Pos	Pol/Phase
	MHz	dBuV/m	dBuV/m	dB	dBuV	dB	dB/m	dB		cm	deg	
1	4822.21	29.54	54.00	-24.46	28.20	3.31	33.06	35.03	Average	100	329	HORIZONTAL
2	4833.33	42.91	74.00	-31.09	41.57	3.31	33.06	35.03	Peak	100	329	HORIZONTAL

Note 1: The amplitude of spurious emissions which are attenuated by more than 20 dB below the permissible value has no need to be reported.
 Note 2: Emission level (dBuV/m) = 20 log Emission level (uV/m).
 Note 3: Corrected Reading: Antenna Factor + Cable Loss + Read Level - Preamp Factor = Level.
 Note 4: Measurement receive antenna polarization: H (Horizontal), V (Vertical)

Transmitter Radiated Emissions (1GHz~10th Harmonic)					
Operating Mode	IEEE 802.11n 20MHz MCS0 CH 1 / Ant. 1			Polarization	V
Temperature	24°C	Humidity	55%	Test Engineer	David Tseng

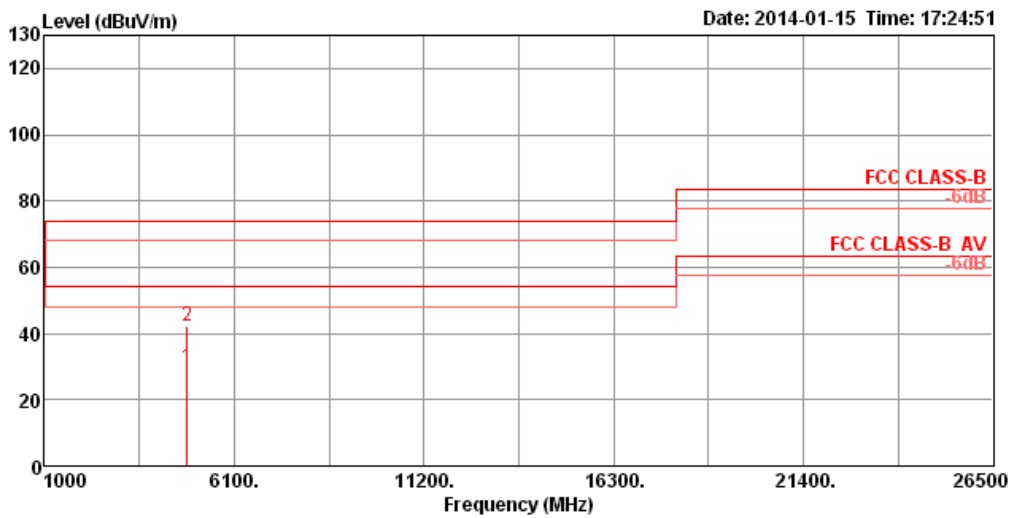

	Freq	Level	Limit Line	Over Limit	Read Level	Cable Loss	Antenna Factor	Preamp Factor	Remark	A/Pos	T/Pos	Pol/Phase
	MHz	dBuV/m	dBuV/m	dB	dBuV	dB	dB/m	dB		cm	deg	
1	4821.34	29.81	54.00	-24.19	28.47	3.31	33.06	35.03	Average	100	207	VERTICAL
2	4823.46	42.05	74.00	-31.95	40.71	3.31	33.06	35.03	Peak	100	207	VERTICAL

Note 1: The amplitude of spurious emissions which are attenuated by more than 20 dB below the permissible value has no need to be reported.

Note 2: Emission level (dBuV/m) = 20 log Emission level (uV/m).

Note 3: Corrected Reading: Antenna Factor + Cable Loss + Read Level - Preamp Factor = Level.

Note 4: Measurement receive antenna polarization: H (Horizontal), V (Vertical)

Transmitter Radiated Emissions (1GHz~10th Harmonic)					
Operating Mode	IEEE 802.11n 20MHz MCS0 CH 6 / Ant. 1			Polarization	H
Temperature	24°C	Humidity	55%	Test Engineer	David Tseng

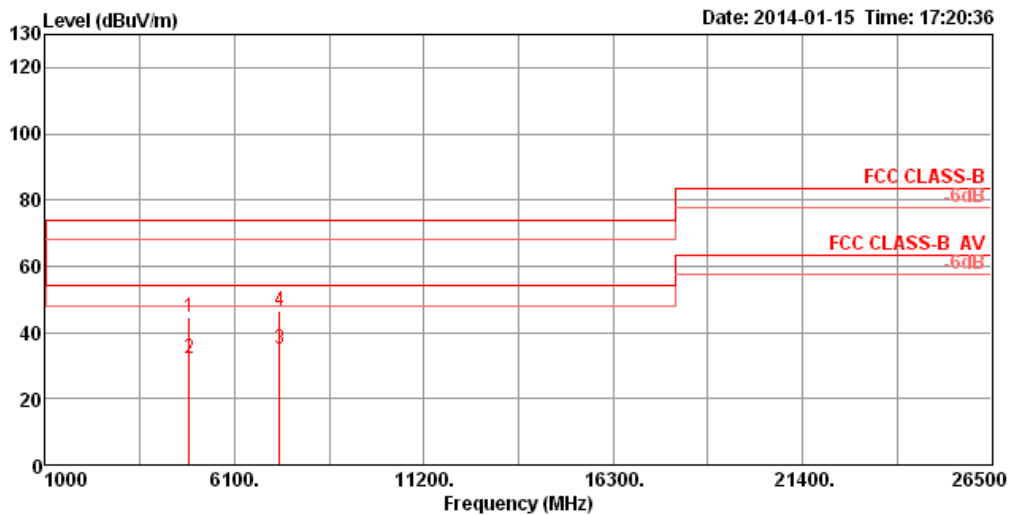

	Freq	Level	Limit Line	Over Limit	Read Level	Cable Loss	Antenna Factor	Preamp Factor	Remark	A/Pos	T/Pos	Pol/Phase
	MHz	dBuV/m	dBuV/m	dB	dBuV	dB	dB/m	dB		cm	deg	
1	4870.44	44.54	74.00	-29.46	43.12	3.33	33.12	35.03	Peak	100	1	HORIZONTAL
2	4872.91	32.00	54.00	-22.00	30.54	3.33	33.16	35.03	Average	100	1	HORIZONTAL
3	7310.58	35.07	54.00	-18.93	30.45	4.06	35.96	35.40	Average	100	311	HORIZONTAL
4	7314.11	46.76	74.00	-27.24	42.14	4.06	35.96	35.40	Peak	100	311	HORIZONTAL

Note 1: The amplitude of spurious emissions which are attenuated by more than 20 dB below the permissible value has no need to be reported.
 Note 2: Emission level (dBuV/m) = 20 log Emission level (uV/m).
 Note 3: Corrected Reading: Antenna Factor + Cable Loss + Read Level - Preamp Factor = Level.
 Note 4: Measurement receive antenna polarization: H (Horizontal), V (Vertical)

Transmitter Radiated Emissions (1GHz~10th Harmonic)					
Operating Mode	IEEE 802.11n 20MHz MCS0 CH 6 / Ant. 1			Polarization	V
Temperature	24°C	Humidity	55%	Test Engineer	David Tseng

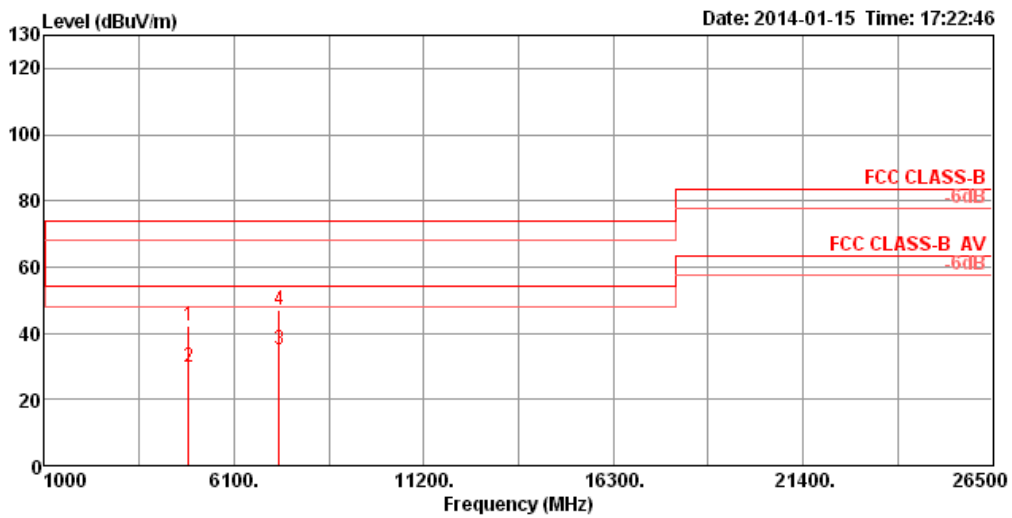

	Freq	Level	Limit	Over	Read	Cable	Antenna	Preamp	Remark	A/Pos	T/Pos	Pol/Phase
	MHz	dBuV/m	dBuV/m	dB	dBuV	dB	dB/m	dB		cm	deg	
1	4868.94	42.15	74.00	-31.85	40.73	3.33	33.12	35.03	Peak	100	5	VERTICAL
2	4874.93	29.84	54.00	-24.16	28.38	3.33	33.16	35.03	Average	100	5	VERTICAL
3	7311.55	34.98	54.00	-19.02	30.36	4.06	35.96	35.40	Average	100	256	VERTICAL
4	7313.82	47.16	74.00	-26.84	42.54	4.06	35.96	35.40	Peak	100	256	VERTICAL

Note 1: The amplitude of spurious emissions which are attenuated by more than 20 dB below the permissible value has no need to be reported.

Note 2: Emission level (dBuV/m) = 20 log Emission level (uV/m).

Note 3: Corrected Reading: Antenna Factor + Cable Loss + Read Level - Preamp Factor = Level.

Note 4: Measurement receive antenna polarization: H (Horizontal), V (Vertical)

Transmitter Radiated Emissions (1GHz~10th Harmonic)					
Operating Mode	IEEE 802.11n 20MHz MCS0 CH 11 / Ant. 1			Polarization	H
Temperature	24°C	Humidity	55%	Test Engineer	David Tseng

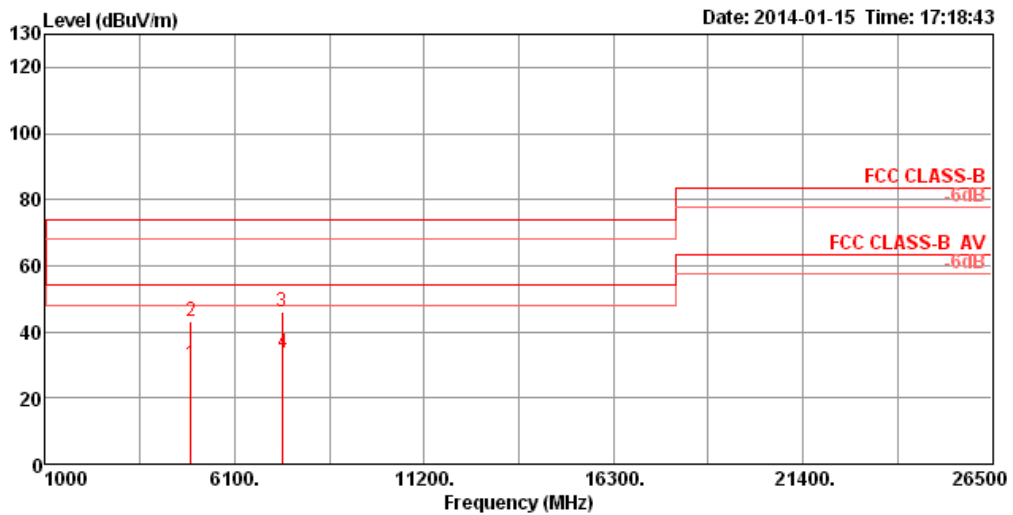

	Freq	Level	Limit	Over	Read	Cable	Antenna	Preamp	Remark	A/Pos	T/Pos	Pol/Phase
	MHz	dBuV/m	dBuV/m	dB	dBuV	dB	dB/m	dB		cm	deg	
1	4918.62	30.00	54.00	-24.00	28.44	3.35	33.23	35.02	Average	100	241	HORIZONTAL
2	4920.19	43.01	74.00	-30.99	41.44	3.35	33.23	35.01	Peak	100	241	HORIZONTAL
3	7382.80	46.02	74.00	-27.98	41.27	4.06	36.09	35.40	Peak	100	95	HORIZONTAL
4	7386.06	33.64	54.00	-20.36	28.89	4.06	36.09	35.40	Average	100	95	HORIZONTAL

Note 1: The amplitude of spurious emissions which are attenuated by more than 20 dB below the permissible value has no need to be reported.
 Note 2: Emission level (dBuV/m) = 20 log Emission level (uV/m).
 Note 3: Corrected Reading: Antenna Factor + Cable Loss + Read Level - Preamp Factor = Level.
 Note 4: Measurement receive antenna polarization: H (Horizontal), V (Vertical)

Transmitter Radiated Emissions (1GHz~10th Harmonic)					
Operating Mode	IEEE 802.11n 20MHz MCS0 CH 11 / Ant. 1			Polarization	V
Temperature	24°C	Humidity	55%	Test Engineer	David Tseng

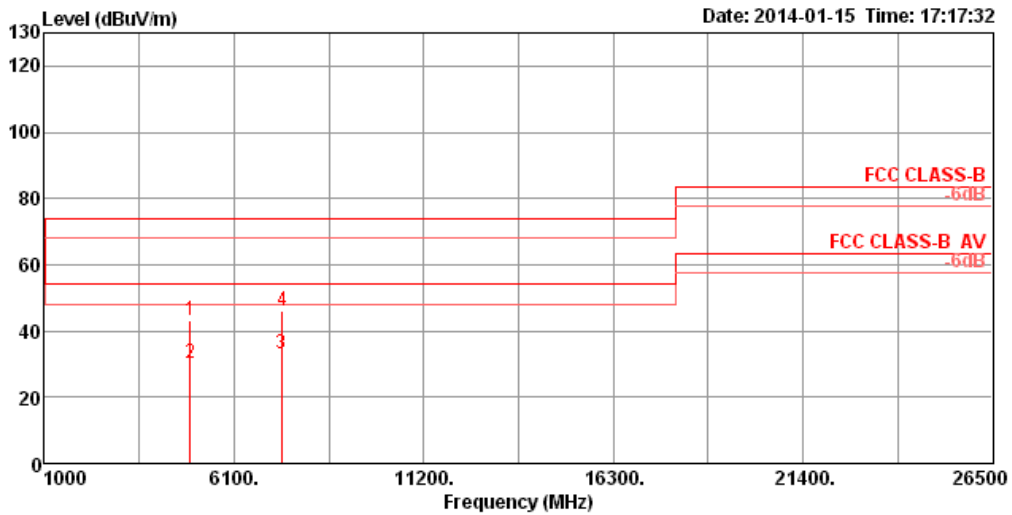

	Freq	Level	Limit Line	Over Limit	Read Level	Cable Loss	Antenna Factor	Preamp Factor	Remark	A/Pos	T/Pos	Pol/Phase
	MHz	dBuV/m	dBuV/m	dB	dBuV	dB	dB/m	dB		cm	deg	
1	4915.92	43.26	74.00	-30.74	41.70	3.35	33.23	35.02	Peak	100	9	VERTICAL
2	4918.68	30.13	54.00	-23.87	28.57	3.35	33.23	35.02	Average	100	9	VERTICAL
3	7376.93	33.25	54.00	-20.75	28.50	4.06	36.09	35.40	Average	100	323	VERTICAL
4	7383.69	45.93	74.00	-28.07	41.18	4.06	36.09	35.40	Peak	100	323	VERTICAL

Note 1: The amplitude of spurious emissions which are attenuated by more than 20 dB below the permissible value has no need to be reported.
 Note 2: Emission level (dBuV/m) = 20 log Emission level (uV/m).
 Note 3: Corrected Reading: Antenna Factor + Cable Loss + Read Level - Preamp Factor = Level.
 Note 4: Measurement receive antenna polarization: H (Horizontal), V (Vertical)

Transmitter Radiated Emissions (1GHz~10th Harmonic)					
Operating Mode	IEEE 802.11n 20MHz MCS0 CH 1 / Ant. 1+2+3			Polarization	H
Temperature	24°C	Humidity	55%	Test Engineer	David Tseng

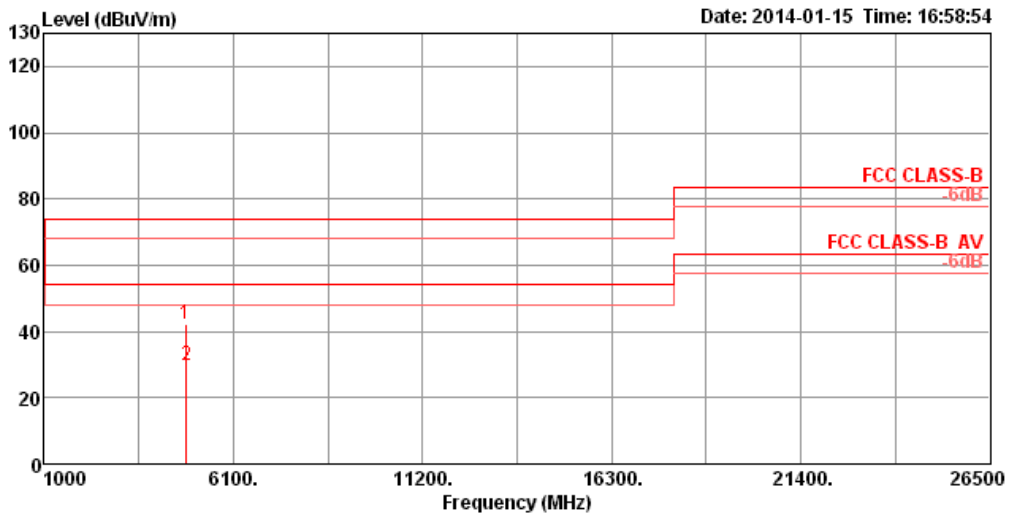

	Freq	Level	Limit	Over	Read	Cable	Antenna	Preamp	Remark	A/Pos	T/Pos	Pol/Phase
	MHz	dBuV/m	dBuV/m	dB	dBuV	dB	dB/m	dB		cm	deg	
1	4815.31	42.09	74.00	-31.91	40.80	3.31	33.02	35.04	Peak	100	122	HORIZONTAL
2	4825.41	29.68	54.00	-24.32	28.34	3.31	33.06	35.03	Average	100	122	HORIZONTAL

- Note 1: The amplitude of spurious emissions which are attenuated by more than 20 dB below the permissible value has no need to be reported.
- Note 2: Emission level (dBuV/m) = 20 log Emission level (uV/m).
- Note 3: Corrected Reading: Antenna Factor + Cable Loss + Read Level - Preamp Factor = Level.
- Note 4: Measurement receive antenna polarization: H (Horizontal), V (Vertical)

Transmitter Radiated Emissions (1GHz~10th Harmonic)					
Operating Mode	IEEE 802.11n 20MHz MCS0 CH 1 / Ant. 1+2+3			Polarization	V
Temperature	24°C	Humidity	55%	Test Engineer	David Tseng

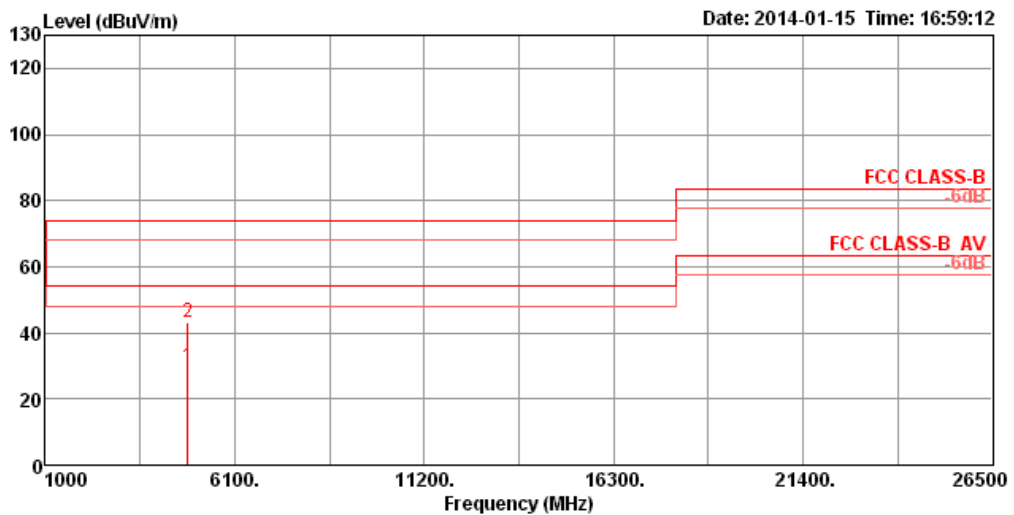

	Freq	Level	Limit	Over	Read	Cable	Antenna	Preamp	Remark	A/Pos	T/Pos	Pol/Phase
	MHz	dBuV/m	dBuV/m	dB	dBuV	dB	dB/m	dB		cm	deg	
1	4820.47	29.59	54.00	-24.41	28.25	3.31	33.06	35.03	Average	100	255	VERTICAL
2	4820.99	42.98	74.00	-31.02	41.64	3.31	33.06	35.03	Peak	100	255	VERTICAL

Note 1: The amplitude of spurious emissions which are attenuated by more than 20 dB below the permissible value has no need to be reported.
 Note 2: Emission level (dBuV/m) = 20 log Emission level (uV/m).
 Note 3: Corrected Reading: Antenna Factor + Cable Loss + Read Level - Preamp Factor = Level.
 Note 4: Measurement receive antenna polarization: H (Horizontal), V (Vertical)

Transmitter Radiated Emissions (1GHz~10th Harmonic)					
Operating Mode	IEEE 802.11n 20MHz MCS0 CH 6 / Ant. 1+2+3			Polarization	H
Temperature	24°C	Humidity	55%	Test Engineer	David Tseng

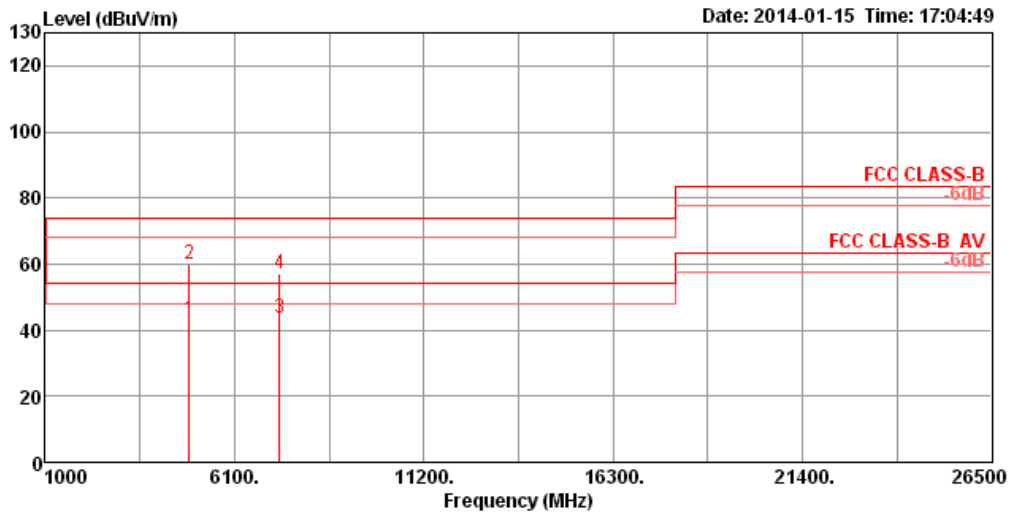

	Freq	Level	Limit	Over	Read	Cable	Antenna	Preamp	Remark	A/Pos	T/Pos	Pol/Phase
	MHz	dBuV/m	dBuV/m	dB	dBuV	dB	dB/m	dB		cm	deg	
1	4874.48	43.36	54.00	-10.64	41.90	3.33	33.16	35.03	Average	101	7	HORIZONTAL
2	4874.58	59.85	74.00	-14.15	58.39	3.33	33.16	35.03	Peak	101	7	HORIZONTAL
3	7309.56	43.53	54.00	-10.47	38.91	4.06	35.96	35.40	Average	147	341	HORIZONTAL
4	7310.17	56.88	74.00	-17.12	52.26	4.06	35.96	35.40	Peak	147	341	HORIZONTAL

Note 1: The amplitude of spurious emissions which are attenuated by more than 20 dB below the permissible value has no need to be reported.

Note 2: Emission level (dBuV/m) = 20 log Emission level (uV/m).

Note 3: Corrected Reading: Antenna Factor + Cable Loss + Read Level - Preamp Factor = Level.

Note 4: Measurement receive antenna polarization: H (Horizontal), V (Vertical)

Transmitter Radiated Emissions (1GHz~10th Harmonic)					
Operating Mode	IEEE 802.11n 20MHz MCS0 CH 6 / Ant. 1+2+3			Polarization	V
Temperature	24°C	Humidity	55%	Test Engineer	David Tseng

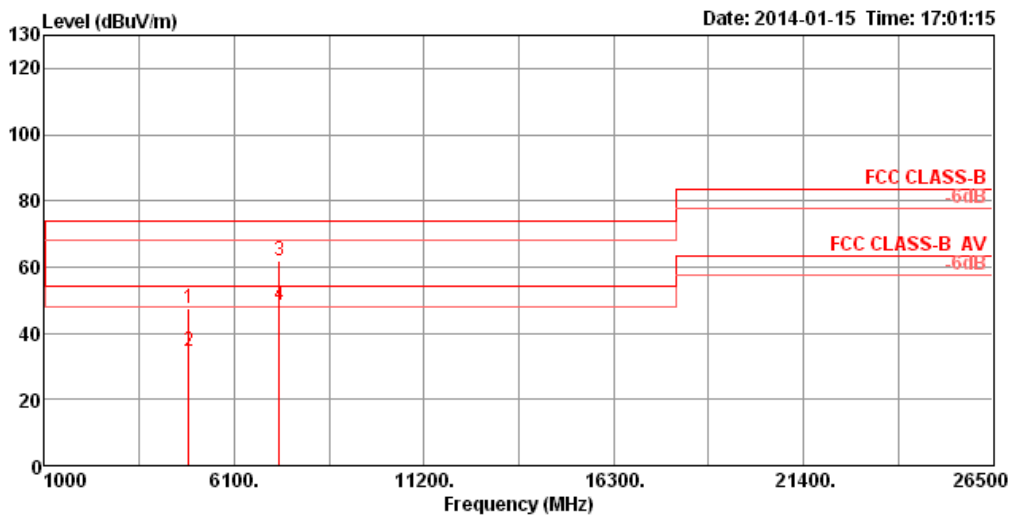

	Freq	Level	Limit	Over	Read	Cable	Antenna	Preamp	Remark	A/Pos	T/Pos	Pol/Phase
	MHz	dBuV/m	dBuV/m	dB	dBuV	dB	dB/m	dB		cm	deg	
1	4874.35	47.68	74.00	-26.32	46.22	3.33	33.16	35.03	Peak	100	197	VERTICAL
2	4874.42	34.47	54.00	-19.53	33.01	3.33	33.16	35.03	Average	100	197	VERTICAL
3	7309.78	61.88	74.00	-12.12	57.26	4.06	35.96	35.40	Peak	113	266	VERTICAL
4	7314.69	48.61	54.00	-5.39	43.99	4.06	35.96	35.40	Average	113	266	VERTICAL

Note 1: The amplitude of spurious emissions which are attenuated by more than 20 dB below the permissible value has no need to be reported.

Note 2: Emission level (dBuV/m) = 20 log Emission level (uV/m).

Note 3: Corrected Reading: Antenna Factor + Cable Loss + Read Level - Preamp Factor = Level.

Note 4: Measurement receive antenna polarization: H (Horizontal), V (Vertical)

Transmitter Radiated Emissions (1GHz~10th Harmonic)					
Operating Mode	IEEE 802.11n 20MHz MCS0 CH 11 / Ant. 1+2+3			Polarization	H
Temperature	24°C	Humidity	55%	Test Engineer	David Tseng

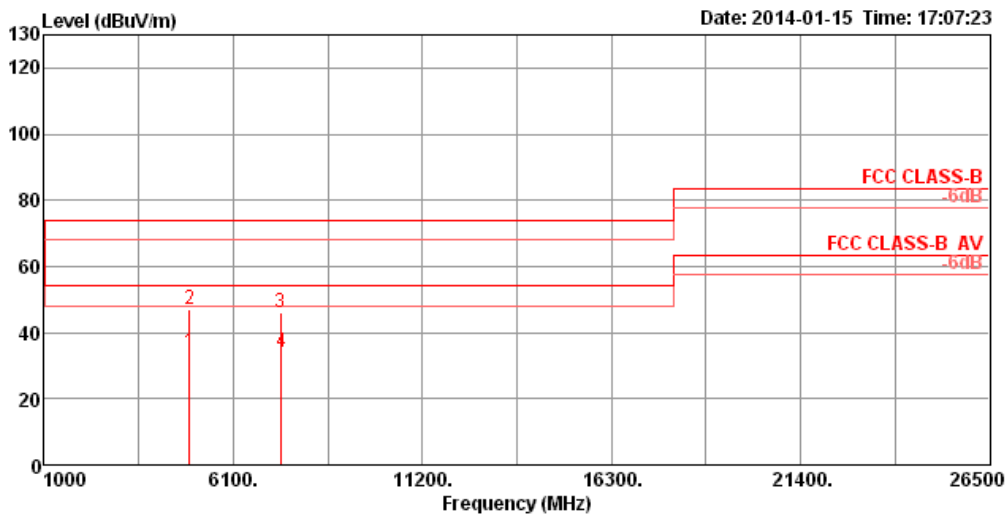

	Freq	Level	Limit Line	Over Limit	Read Level	Cable Loss	Antenna Factor	Preamp Factor	Remark	A/Pos	T/Pos	Pol/Phase
	MHz	dBuV/m	dBuV/m	dB	dBuV	dB	dB/m	dB		cm	deg	
1	4924.80	34.03	54.00	-19.97	32.43	3.35	33.26	35.01	Average	123	359	HORIZONTAL
2	4925.19	46.96	74.00	-27.04	45.36	3.35	33.26	35.01	Peak	123	359	HORIZONTAL
3	7377.73	46.21	74.00	-27.79	41.46	4.06	36.09	35.40	Peak	100	99	HORIZONTAL
4	7386.06	34.08	54.00	-19.92	29.33	4.06	36.09	35.40	Average	100	99	HORIZONTAL

Note 1: The amplitude of spurious emissions which are attenuated by more than 20 dB below the permissible value has no need to be reported.
 Note 2: Emission level (dBuV/m) = 20 log Emission level (uV/m).
 Note 3: Corrected Reading: Antenna Factor + Cable Loss + Read Level - Preamp Factor = Level.
 Note 4: Measurement receive antenna polarization: H (Horizontal), V (Vertical)

Transmitter Radiated Emissions (1GHz~10th Harmonic)					
Operating Mode	IEEE 802.11n 20MHz MCS0 CH 11 / Ant. 1+2+3			Polarization	V
Temperature	24°C	Humidity	55%	Test Engineer	David Tseng

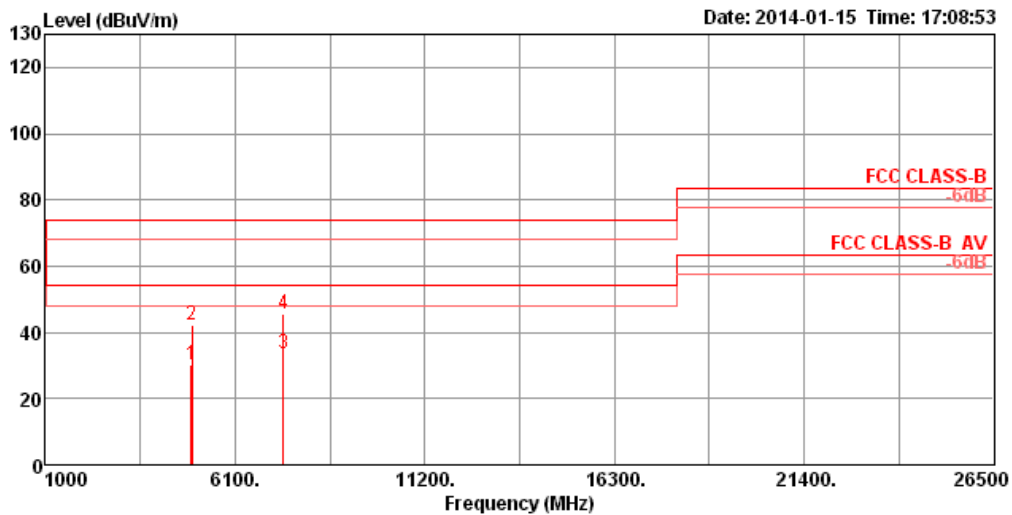

	Freq	Level	Limit Line	Over Limit	Read Level	Cable Loss	Antenna Factor	Preamp Factor	Remark	A/Pos	T/Pos	Pol/Phase
	MHz	dBuV/m	dBuV/m	dB	dBuV	dB	dB/m	dB		cm	deg	
1	4920.19	30.30	54.00	-23.70	28.73	3.35	33.23	35.01	Average	100	146	VERTICAL
2	4928.78	42.21	74.00	-31.79	40.61	3.35	33.26	35.01	Peak	100	146	VERTICAL
3	7384.46	33.39	54.00	-20.61	28.64	4.06	36.09	35.40	Average	100	324	VERTICAL
4	7390.90	45.41	74.00	-28.59	40.66	4.06	36.09	35.40	Peak	100	324	VERTICAL

Note 1: The amplitude of spurious emissions which are attenuated by more than 20 dB below the permissible value has no need to be reported.

Note 2: Emission level (dBuV/m) = 20 log Emission level (uV/m).

Note 3: Corrected Reading: Antenna Factor + Cable Loss + Read Level - Preamp Factor = Level.

Note 4: Measurement receive antenna polarization: H (Horizontal), V (Vertical)

Transmitter Radiated Emissions (1GHz~10th Harmonic)					
Operating Mode	IEEE 802.11n 20MHz MCS8 CH 1 / Ant. 1+2+3			Polarization	H
Temperature	24°C	Humidity	55%	Test Engineer	David Tseng

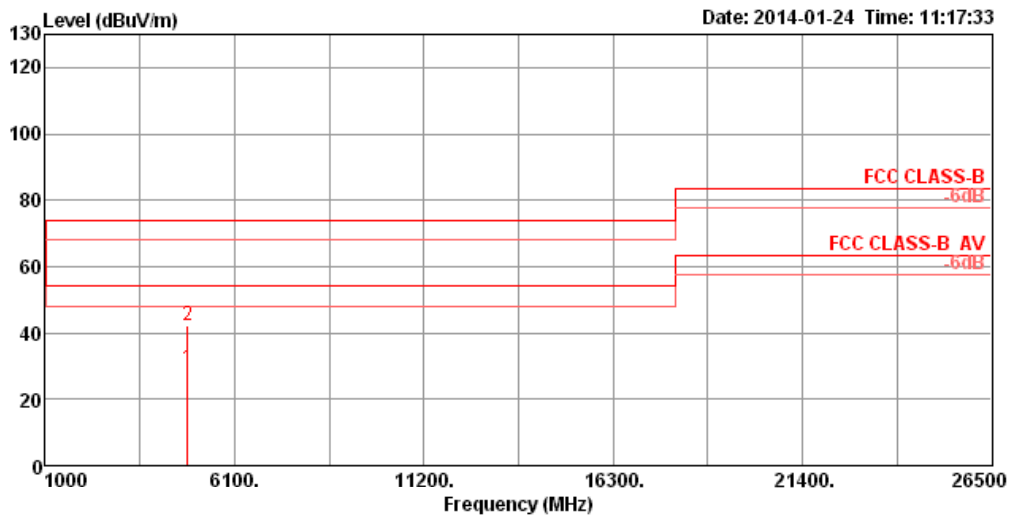

	Freq	Level	Limit	Over	Read	Cable	Antenna	Preamp	Remark	A/Pos	T/Pos	Pol/Phase
	MHz	dBuV/m	dBuV/m	dB	dBuV	dB	dB/m	dB		cm	deg	
1	4823.20	29.50	54.00	-24.50	28.16	3.31	33.06	35.03	Average	100	249	HORIZONTAL
2	4823.37	42.34	74.00	-31.66	41.00	3.31	33.06	35.03	Peak	100	249	HORIZONTAL

Note 1: The amplitude of spurious emissions which are attenuated by more than 20 dB below the permissible value has no need to be reported.
 Note 2: Emission level (dBuV/m) = 20 log Emission level (uV/m).
 Note 3: Corrected Reading: Antenna Factor + Cable Loss + Read Level - Preamp Factor = Level.
 Note 4: Measurement receive antenna polarization: H (Horizontal), V (Vertical)

Transmitter Radiated Emissions (1GHz~10th Harmonic)					
Operating Mode	IEEE 802.11n 20MHz MCS8 CH 1 / Ant. 1+2+3			Polarization	V
Temperature	24°C	Humidity	55%	Test Engineer	David Tseng

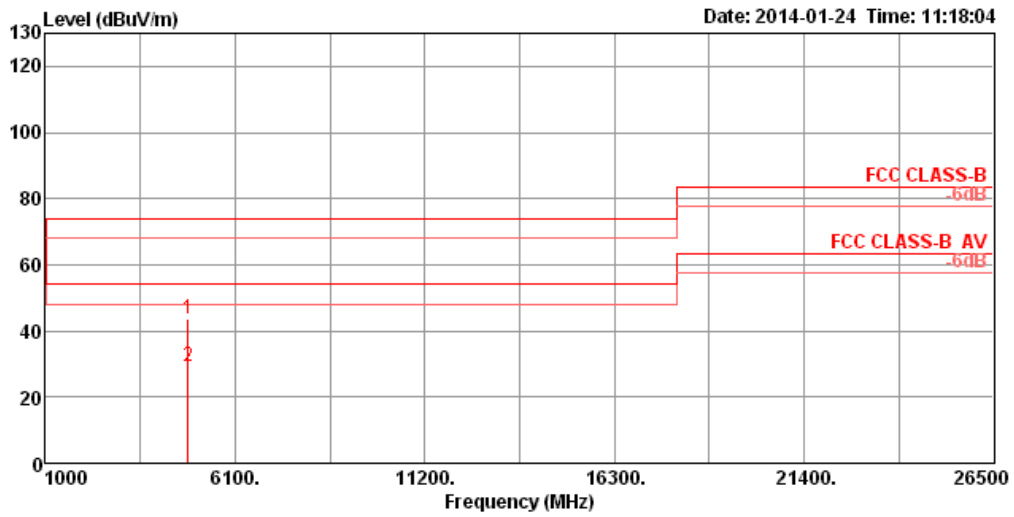

	Freq	Level	Limit	Over	Read	Cable	Antenna	Preamp	Remark	A/Pos	T/Pos	Pol/Phase
	MHz	dBuV/m	dBuV/m	dB	dBuV	dB	dB/m	dB		cm	deg	
1	4823.16	43.76	74.00	-30.24	42.42	3.31	33.06	35.03	Peak	100	24	VERTICAL
2	4823.47	29.45	54.00	-24.55	28.11	3.31	33.06	35.03	Average	100	24	VERTICAL

Note 1: The amplitude of spurious emissions which are attenuated by more than 20 dB below the permissible value has no need to be reported.
 Note 2: Emission level (dBuV/m) = 20 log Emission level (uV/m).
 Note 3: Corrected Reading: Antenna Factor + Cable Loss + Read Level - Preamp Factor = Level.
 Note 4: Measurement receive antenna polarization: H (Horizontal), V (Vertical)

Transmitter Radiated Emissions (1GHz~10th Harmonic)					
Operating Mode	IEEE 802.11n 20MHz MCS8 CH 6 / Ant. 1+2+3			Polarization	H
Temperature	24°C	Humidity	55%	Test Engineer	David Tseng

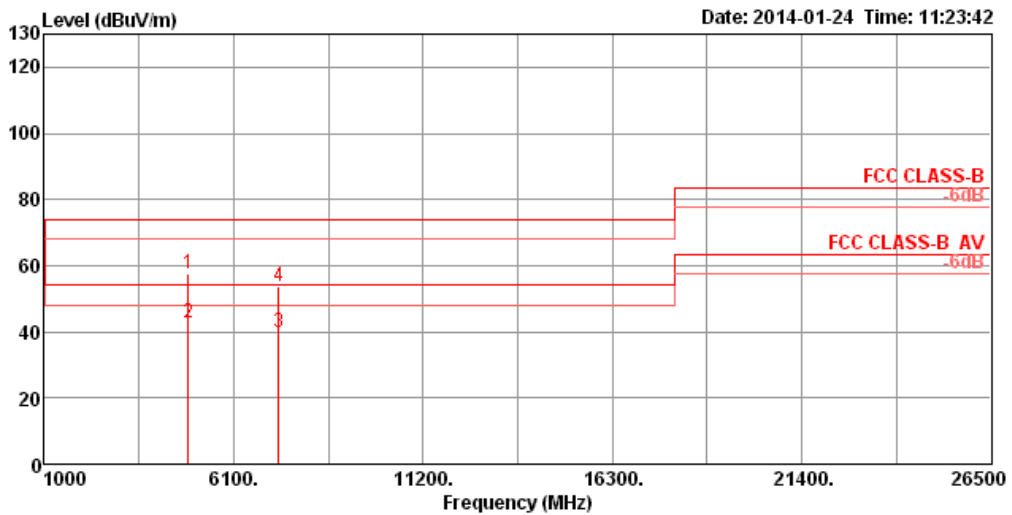

	Freq	Level	Limit	Over	Read	Cable	Antenna	Preamp	Remark	A/Pos	T/Pos	Pol/Phase
	MHz	dBuV/m	dBuV/m	dB	dBuV	dB	dB/m	dB		cm	deg	
1	4874.81	57.59	74.00	-16.41	56.13	3.33	33.16	35.03	Peak	100	357	HORIZONTAL
2	4874.97	42.55	54.00	-11.45	41.09	3.33	33.16	35.03	Average	100	357	HORIZONTAL
3	7310.23	39.60	54.00	-14.40	34.98	4.06	35.96	35.40	Average	117	273	HORIZONTAL
4	7310.86	53.95	74.00	-20.05	49.33	4.06	35.96	35.40	Peak	117	273	HORIZONTAL

Note 1: The amplitude of spurious emissions which are attenuated by more than 20 dB below the permissible value has no need to be reported.
 Note 2: Emission level (dBuV/m) = 20 log Emission level (uV/m).
 Note 3: Corrected Reading: Antenna Factor + Cable Loss + Read Level - Preamp Factor = Level.
 Note 4: Measurement receive antenna polarization: H (Horizontal), V (Vertical)

Transmitter Radiated Emissions (1GHz~10th Harmonic)					
Operating Mode	IEEE 802.11n 20MHz MCS8 CH 6 / Ant. 1+2+3			Polarization	V
Temperature	24°C	Humidity	55%	Test Engineer	David Tseng

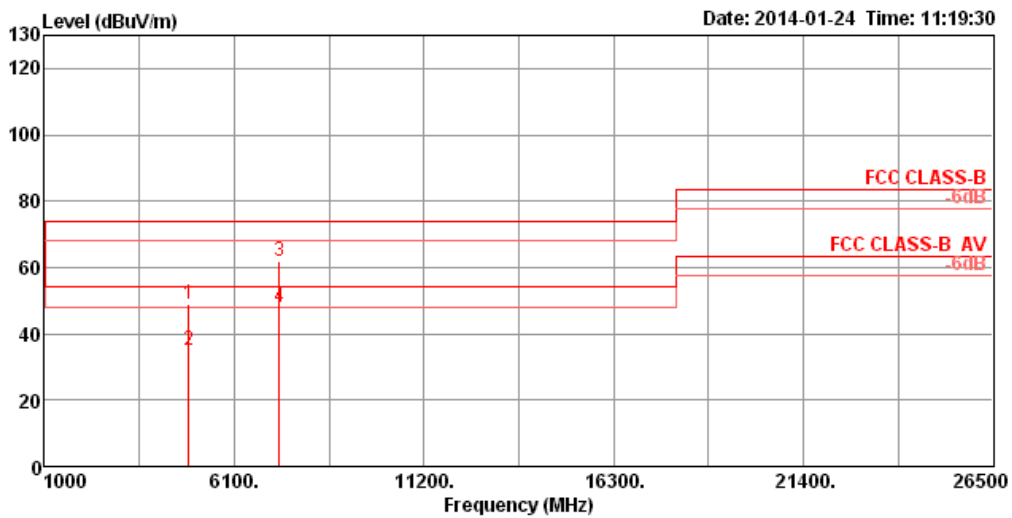

	Freq	Level	Limit Line	Over Limit	Read Level	Cable Loss	Antenna Factor	Preamp Factor	Remark	A/Pos	T/Pos	Pol/Phase
	MHz	dBuV/m	dBuV/m	dB	dBuV	dB	dB/m	dB		cm	deg	
1	4874.22	48.96	74.00	-25.04	47.50	3.33	33.16	35.03	Peak	100	260	VERTICAL
2	4874.64	34.80	54.00	-19.20	33.34	3.33	33.16	35.03	Average	100	260	VERTICAL
3	7310.62	62.00	74.00	-12.00	57.38	4.06	35.96	35.40	Peak	104	272	VERTICAL
4	7311.99	48.02	54.00	-5.98	43.40	4.06	35.96	35.40	Average	104	272	VERTICAL

Note 1: The amplitude of spurious emissions which are attenuated by more than 20 dB below the permissible value has no need to be reported.
 Note 2: Emission level (dBuV/m) = 20 log Emission level (uV/m).
 Note 3: Corrected Reading: Antenna Factor + Cable Loss + Read Level - Preamp Factor = Level.
 Note 4: Measurement receive antenna polarization: H (Horizontal), V (Vertical)

Transmitter Radiated Emissions (1GHz~10th Harmonic)					
Operating Mode	IEEE 802.11n 20MHz MCS8 CH 11 / Ant. 1+2+3			Polarization	H
Temperature	24°C	Humidity	55%	Test Engineer	David Tseng

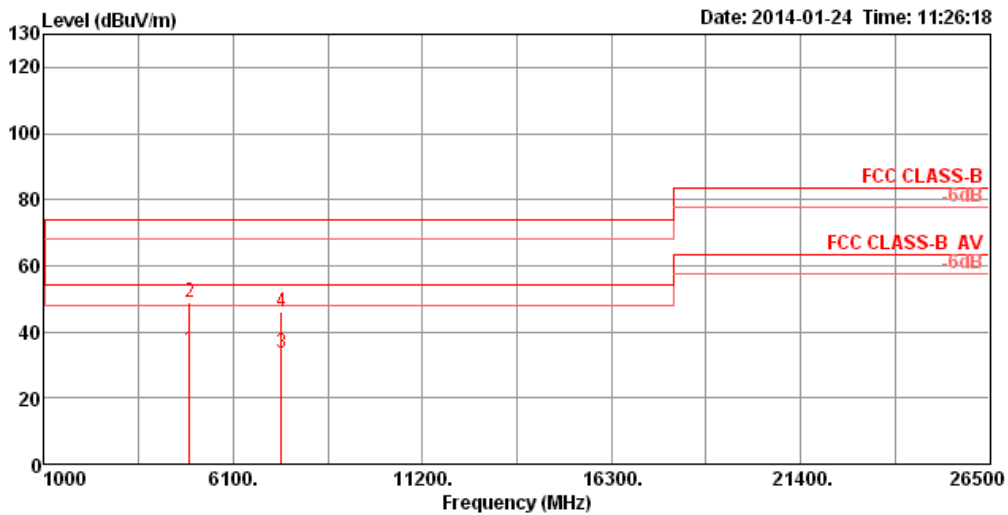

	Freq	Level	Limit Line	Over Limit	Read Level	Cable Loss	Antenna Factor	Preamp Factor	Remark	A/Pos	T/Pos	Pol/Phase
	MHz	dBuV/m	dBuV/m	dB	dBuV	dB	dB/m	dB		cm	deg	
1	4923.55	34.50	54.00	-19.50	32.90	3.35	33.26	35.01	Average	100	3	HORIZONTAL
2	4924.69	48.81	74.00	-25.19	47.21	3.35	33.26	35.01	Peak	100	3	HORIZONTAL
3	7385.48	33.46	54.00	-20.54	28.71	4.06	36.09	35.40	Average	100	197	HORIZONTAL
4	7386.51	46.26	74.00	-27.74	41.51	4.06	36.09	35.40	Peak	100	197	HORIZONTAL

Note 1: The amplitude of spurious emissions which are attenuated by more than 20 dB below the permissible value has no need to be reported.
 Note 2: Emission level (dBuV/m) = 20 log Emission level (uV/m).
 Note 3: Corrected Reading: Antenna Factor + Cable Loss + Read Level - Preamp Factor = Level.
 Note 4: Measurement receive antenna polarization: H (Horizontal), V (Vertical)

Transmitter Radiated Emissions (1GHz~10th Harmonic)					
Operating Mode	IEEE 802.11n 20MHz MCS8 CH 11 / Ant. 1+2+3			Polarization	V
Temperature	24°C	Humidity	55%	Test Engineer	David Tseng

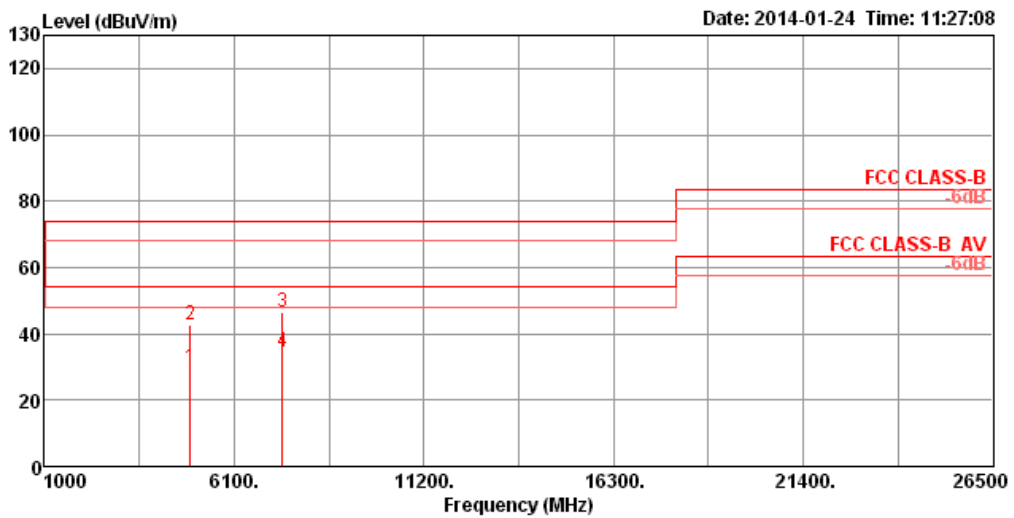

	Freq	Level	Limit	Over	Read	Cable	Antenna	Preamp	Remark	A/Pos	T/Pos	Pol/Phase
	MHz	dBuV/m	dBuV/m	dB	dBuV	dB	dB/m	dB		cm	deg	
1	4923.77	29.91	54.00	-24.09	28.31	3.35	33.26	35.01	Average	100	126	VERTICAL
2	4924.49	42.86	74.00	-31.14	41.26	3.35	33.26	35.01	Peak	100	126	VERTICAL
3	7385.76	46.75	74.00	-27.25	42.00	4.06	36.09	35.40	Peak	100	301	VERTICAL
4	7386.04	34.61	54.00	-19.39	29.86	4.06	36.09	35.40	Average	100	301	VERTICAL

Note 1: The amplitude of spurious emissions which are attenuated by more than 20 dB below the permissible value has no need to be reported.

Note 2: Emission level (dBuV/m) = 20 log Emission level (uV/m).

Note 3: Corrected Reading: Antenna Factor + Cable Loss + Read Level - Preamp Factor = Level.

Note 4: Measurement receive antenna polarization: H (Horizontal), V (Vertical)

Transmitter Radiated Emissions (1GHz~10th Harmonic)					
Operating Mode	IEEE 802.11n 40MHz MCS0 CH 3 / Ant. 3			Polarization	H
Temperature	24°C	Humidity	55%	Test Engineer	David Tseng

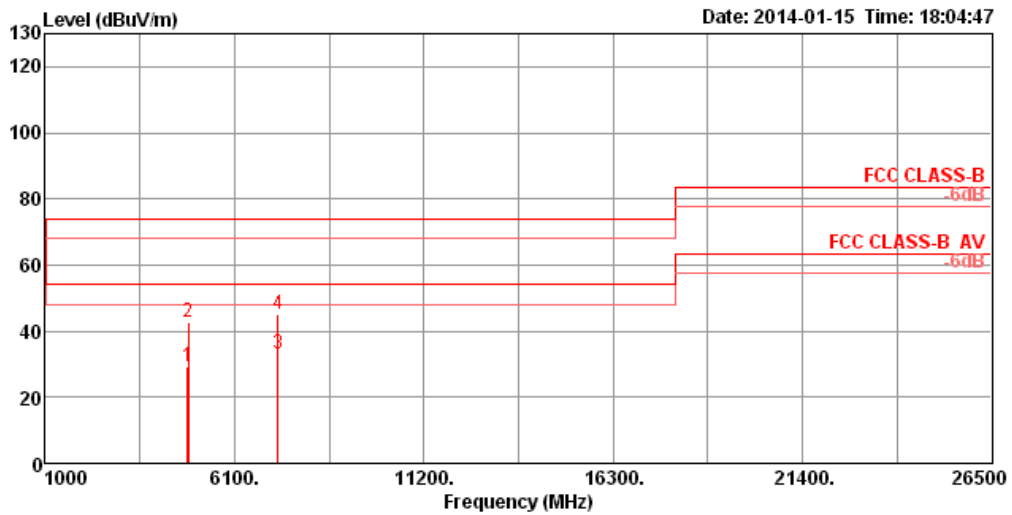

	Freq	Level	Limit	Over	Read	Cable	Antenna	Preamp	Remark	A/Pos	T/Pos	Pol/Phase
	MHz	dBuV/m	dBuV/m	dB	dBuV	dB	dB/m	dB		cm	deg	
1	4835.70	29.20	54.00	-24.80	27.86	3.31	33.06	35.03	Average	100	184	HORIZONTAL
2	4848.17	42.49	74.00	-31.51	41.11	3.32	33.09	35.03	Peak	100	184	HORIZONTAL
3	7261.96	32.94	54.00	-21.06	28.43	4.06	35.85	35.40	Average	100	268	HORIZONTAL
4	7275.10	45.31	74.00	-28.69	40.76	4.06	35.89	35.40	Peak	100	268	HORIZONTAL

Note 1: The amplitude of spurious emissions which are attenuated by more than 20 dB below the permissible value has no need to be reported.
 Note 2: Emission level (dBuV/m) = 20 log Emission level (uV/m).
 Note 3: Corrected Reading: Antenna Factor + Cable Loss + Read Level - Preamp Factor = Level.
 Note 4: Measurement receive antenna polarization: H (Horizontal), V (Vertical)

Transmitter Radiated Emissions (1GHz~10th Harmonic)					
Operating Mode	IEEE 802.11n 40MHz MCS0 CH 3 / Ant. 3			Polarization	V
Temperature	24°C	Humidity	55%	Test Engineer	David Tseng

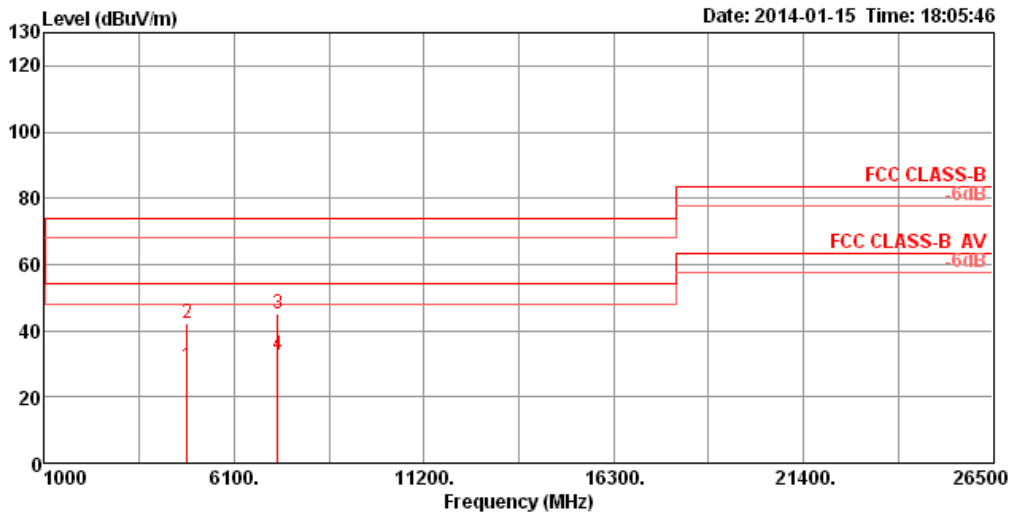

	Freq	Level	Limit	Over	Read	Cable	Antenna	Preamp	Remark	A/Pos	T/Pos	Pol/Phase
	MHz	dBuV/m	dBuV/m	dB	dBuV	dB	dB/m	dB		cm	deg	
1	4834.96	29.22	54.00	-24.78	27.88	3.31	33.06	35.03	Average	100	252	VERTICAL
2	4835.25	42.32	74.00	-31.68	40.98	3.31	33.06	35.03	Peak	100	252	VERTICAL
3	7259.72	44.94	74.00	-29.06	40.43	4.06	35.85	35.40	Peak	100	38	VERTICAL
4	7264.56	32.79	54.00	-21.21	28.28	4.06	35.85	35.40	Average	100	38	VERTICAL

Note 1: The amplitude of spurious emissions which are attenuated by more than 20 dB below the permissible value has no need to be reported.
 Note 2: Emission level (dBuV/m) = 20 log Emission level (uV/m).
 Note 3: Corrected Reading: Antenna Factor + Cable Loss + Read Level - Preamp Factor = Level.
 Note 4: Measurement receive antenna polarization: H (Horizontal), V (Vertical)

Transmitter Radiated Emissions (1GHz~10th Harmonic)					
Operating Mode	IEEE 802.11n 40MHz MCS0 CH 6 / Ant. 3			Polarization	H
Temperature	24°C	Humidity	55%	Test Engineer	David Tseng

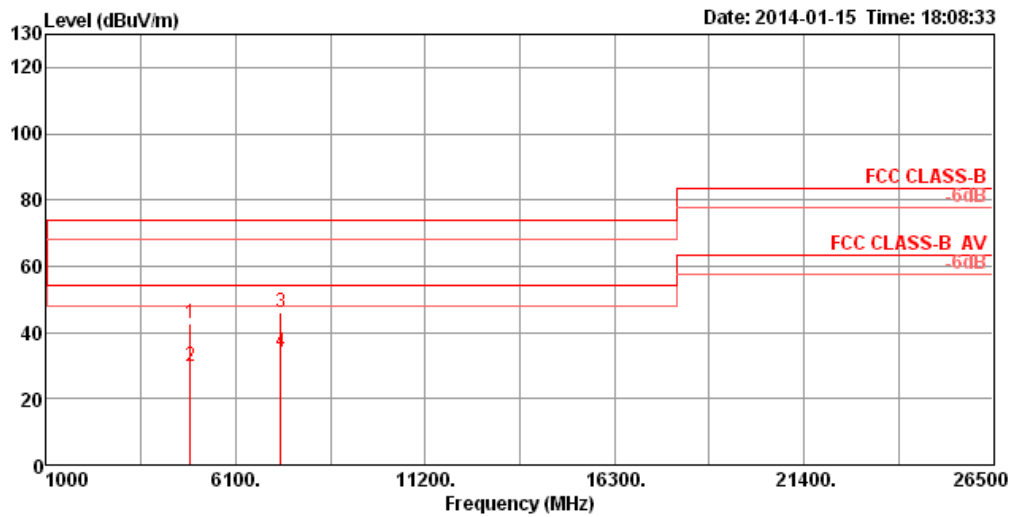

	Freq	Level	Limit	Over	Read	Cable	Antenna	Preamp	Remark	A/Pos	T/Pos	Pol/Phase
	MHz	dBuV/m	dBuV/m	dB	dBuV	dB	dB/m	dB		cm	deg	
1	4867.05	42.89	74.00	-31.11	41.47	3.33	33.12	35.03	Peak	100	301	HORIZONTAL
2	4869.87	29.90	54.00	-24.10	28.48	3.33	33.12	35.03	Average	100	301	HORIZONTAL
3	7307.41	45.99	74.00	-28.01	41.37	4.06	35.96	35.40	Peak	100	164	HORIZONTAL
4	7311.29	33.95	54.00	-20.05	29.33	4.06	35.96	35.40	Average	100	164	HORIZONTAL

Note 1: The amplitude of spurious emissions which are attenuated by more than 20 dB below the permissible value has no need to be reported.
 Note 2: Emission level (dBuV/m) = 20 log Emission level (uV/m).
 Note 3: Corrected Reading: Antenna Factor + Cable Loss + Read Level - Preamp Factor = Level.
 Note 4: Measurement receive antenna polarization: H (Horizontal), V (Vertical)

Transmitter Radiated Emissions (1GHz~10th Harmonic)					
Operating Mode	IEEE 802.11n 40MHz MCS0 CH 6 / Ant. 3			Polarization	V
Temperature	24°C	Humidity	55%	Test Engineer	David Tseng

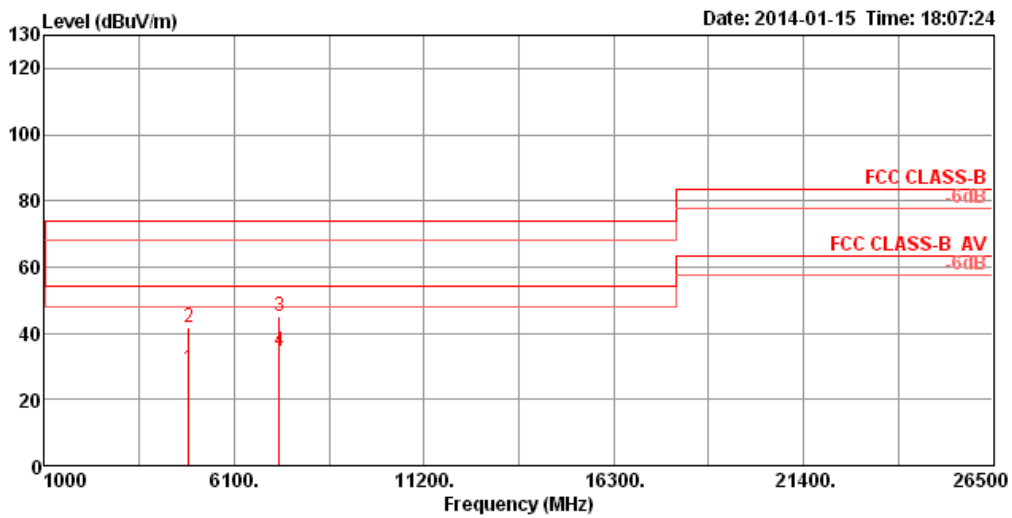

	Freq	Level	Limit	Over	Read	Cable	Antenna	Preamp	Remark	A/Pos	T/Pos	Pol/Phase
	MHz	dBuV/m	dBuV/m	dB	dBuV	dB	dB/m	dB		cm	deg	
1	4869.35	29.40	54.00	-24.60	27.98	3.33	33.12	35.03	Average	100	121	VERTICAL
2	4880.80	41.97	74.00	-32.03	40.51	3.33	33.16	35.03	Peak	100	121	VERTICAL
3	7307.83	45.19	74.00	-28.81	40.57	4.06	35.96	35.40	Peak	100	342	VERTICAL
4	7311.06	34.43	54.00	-19.57	29.81	4.06	35.96	35.40	Average	100	342	VERTICAL

Note 1: The amplitude of spurious emissions which are attenuated by more than 20 dB below the permissible value has no need to be reported.

Note 2: Emission level (dBUV/m) = 20 log Emission level (uV/m).

Note 3: Corrected Reading: Antenna Factor + Cable Loss + Read Level - Preamp Factor = Level.

Note 4: Measurement receive antenna polarization: H (Horizontal), V (Vertical)

Transmitter Radiated Emissions (1GHz~10th Harmonic)					
Operating Mode	IEEE 802.11n 40MHz MCS0 CH 9 / Ant. 3			Polarization	H
Temperature	24°C	Humidity	55%	Test Engineer	David Tseng

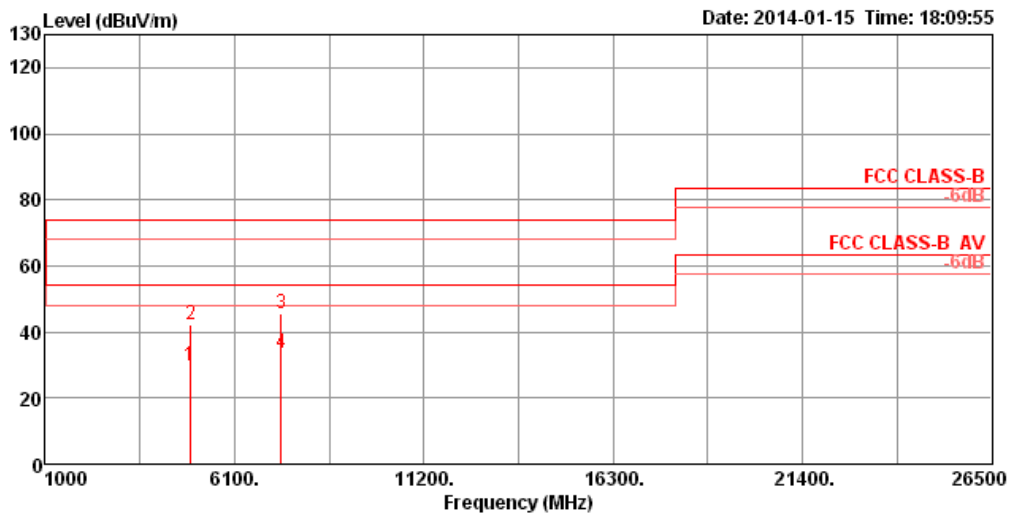

	Freq	Level	Limit	Over	Read	Cable	Antenna	Preamp	Remark	A/Pos	T/Pos	Pol/Phase
	MHz	dBuV/m	dBuV/m	dB	dBuV	dB	dB/m	dB		cm	deg	
1	4897.85	29.75	54.00	-24.25	28.24	3.34	33.19	35.02	Average	100	197	HORIZONTAL
2	4913.90	42.24	74.00	-31.76	40.69	3.34	33.23	35.02	Peak	100	197	HORIZONTAL
3	7348.85	45.77	74.00	-28.23	41.09	4.06	36.02	35.40	Peak	100	294	HORIZONTAL
4	7356.03	33.34	54.00	-20.66	28.66	4.06	36.02	35.40	Average	100	294	HORIZONTAL

Note 1: The amplitude of spurious emissions which are attenuated by more than 20 dB below the permissible value has no need to be reported.
 Note 2: Emission level (dBuV/m) = 20 log Emission level (uV/m).
 Note 3: Corrected Reading: Antenna Factor + Cable Loss + Read Level - Preamp Factor = Level.
 Note 4: Measurement receive antenna polarization: H (Horizontal), V (Vertical)

Transmitter Radiated Emissions (1GHz~10th Harmonic)					
Operating Mode	IEEE 802.11n 40MHz MCS0 CH 9 / Ant. 3			Polarization	V
Temperature	24°C	Humidity	55%	Test Engineer	David Tseng

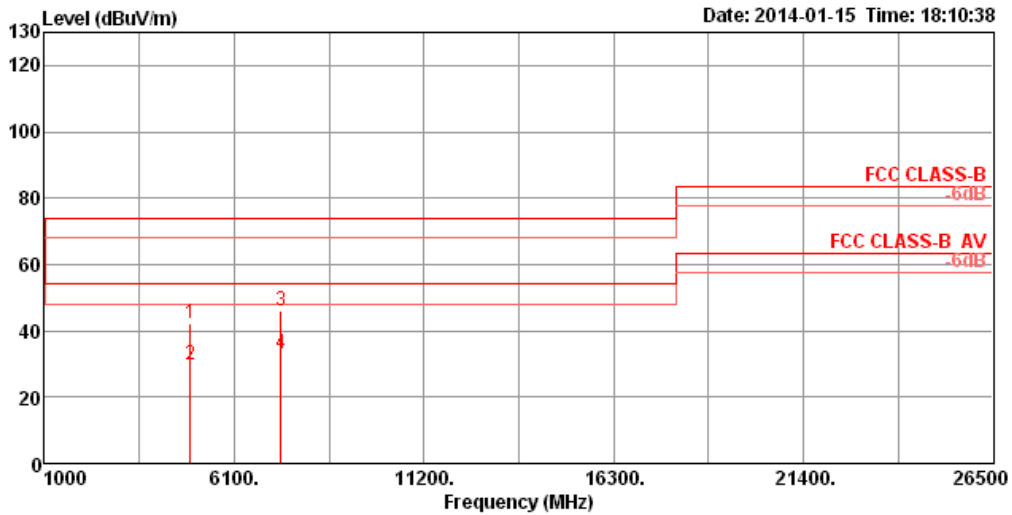

	Freq	Level	Limit Line	Over Limit	Read Level	Cable Loss	Antenna Factor	Preamp Factor	Remark	A/Pos	T/Pos	Pol/Phase
	MHz	dBuV/m	dBuV/m	dB	dBuV	dB	dB/m	dB		cm	deg	
1	4906.72	42.31	74.00	-31.69	40.76	3.34	33.23	35.02	Peak	100	309	VERTICAL
2	4907.85	29.72	54.00	-24.28	28.17	3.34	33.23	35.02	Average	100	309	VERTICAL
3	7351.19	46.01	74.00	-27.99	41.33	4.06	36.02	35.40	Peak	100	139	VERTICAL
4	7356.39	33.17	54.00	-20.83	28.49	4.06	36.02	35.40	Average	100	139	VERTICAL

Note 1: The amplitude of spurious emissions which are attenuated by more than 20 dB below the permissible value has no need to be reported.
 Note 2: Emission level (dBuV/m) = 20 log Emission level (uV/m).
 Note 3: Corrected Reading: Antenna Factor + Cable Loss + Read Level - Preamp Factor = Level.
 Note 4: Measurement receive antenna polarization: H (Horizontal), V (Vertical)

Transmitter Radiated Emissions (1GHz~10th Harmonic)					
Operating Mode	IEEE 802.11n 40MHz MCS0 CH 3 / Ant. 1+2+3			Polarization	H
Temperature	24°C	Humidity	55%	Test Engineer	David Tseng

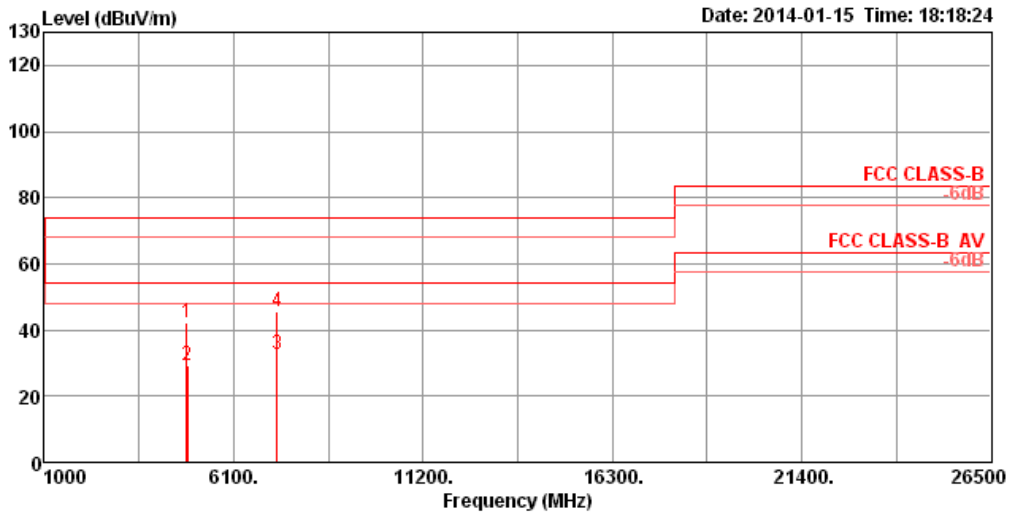

	Freq	Level	Limit	Over	Read	Cable	Antenna	Preamp	Remark	A/Pos	T/Pos	Pol/Phase
	MHz	dBuV/m	dBuV/m	dB	dBuV	dB	dB/m	dB		cm	deg	
1	4834.87	42.07	74.00	-31.93	40.73	3.31	33.06	35.03	Peak	100	162	HORIZONTAL
2	4845.35	29.22	54.00	-24.78	27.84	3.32	33.09	35.03	Average	100	162	HORIZONTAL
3	7256.61	32.67	54.00	-21.33	28.16	4.06	35.85	35.40	Average	100	285	HORIZONTAL
4	7268.47	45.73	74.00	-28.27	41.22	4.06	35.85	35.40	Peak	100	285	HORIZONTAL

Note 1: The amplitude of spurious emissions which are attenuated by more than 20 dB below the permissible value has no need to be reported.
 Note 2: Emission level (dBuV/m) = 20 log Emission level (uV/m).
 Note 3: Corrected Reading: Antenna Factor + Cable Loss + Read Level - Preamp Factor = Level.
 Note 4: Measurement receive antenna polarization: H (Horizontal), V (Vertical)

Transmitter Radiated Emissions (1GHz~10th Harmonic)					
Operating Mode	IEEE 802.11n 40MHz MCS0 CH 3 / Ant. 1+2+3			Polarization	V
Temperature	24°C	Humidity	55%	Test Engineer	David Tseng

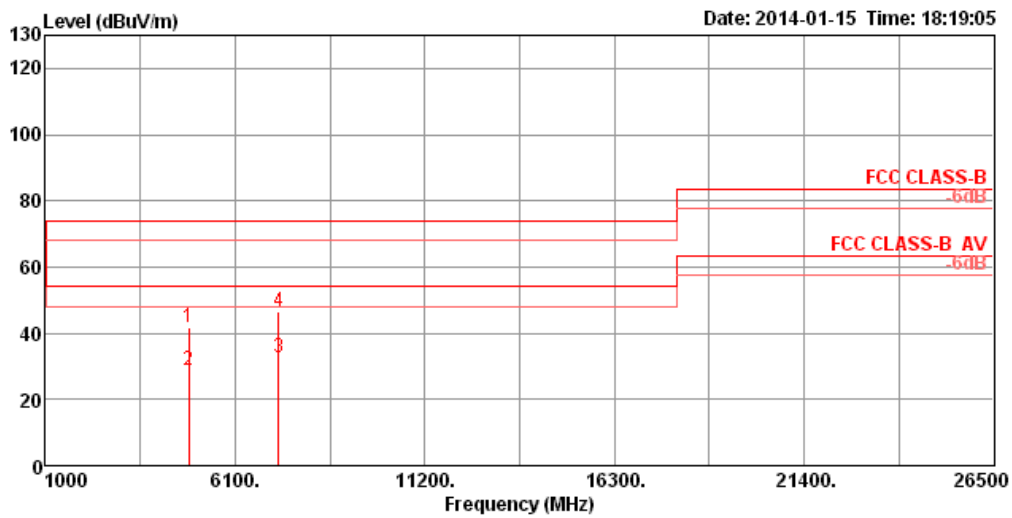

	Freq	Level	Limit	Over	Read	Cable	Antenna	Preamp	Remark	A/Pos	T/Pos	Pol/Phase
	MHz	dBuV/m	dBuV/m	dB	dBuV	dB	dB/m	dB		cm	deg	
1	4846.24	41.56	74.00	-32.44	40.18	3.32	33.09	35.03	Peak	100	212	VERTICAL
2	4852.69	29.02	54.00	-24.98	27.64	3.32	33.09	35.03	Average	100	212	VERTICAL
3	7258.15	32.70	54.00	-21.30	28.19	4.06	35.85	35.40	Average	100	349	VERTICAL
4	7262.41	46.53	74.00	-27.47	42.02	4.06	35.85	35.40	Peak	100	349	VERTICAL

Note 1: The amplitude of spurious emissions which are attenuated by more than 20 dB below the permissible value has no need to be reported.

Note 2: Emission level (dBuV/m) = 20 log Emission level (uV/m).

Note 3: Corrected Reading: Antenna Factor + Cable Loss + Read Level - Preamp Factor = Level.

Note 4: Measurement receive antenna polarization: H (Horizontal), V (Vertical)

Transmitter Radiated Emissions (1GHz~10th Harmonic)					
Operating Mode	IEEE 802.11n 40MHz MCS0 CH 6 / Ant. 1+2+3			Polarization	H
Temperature	24°C	Humidity	55%	Test Engineer	David Tseng

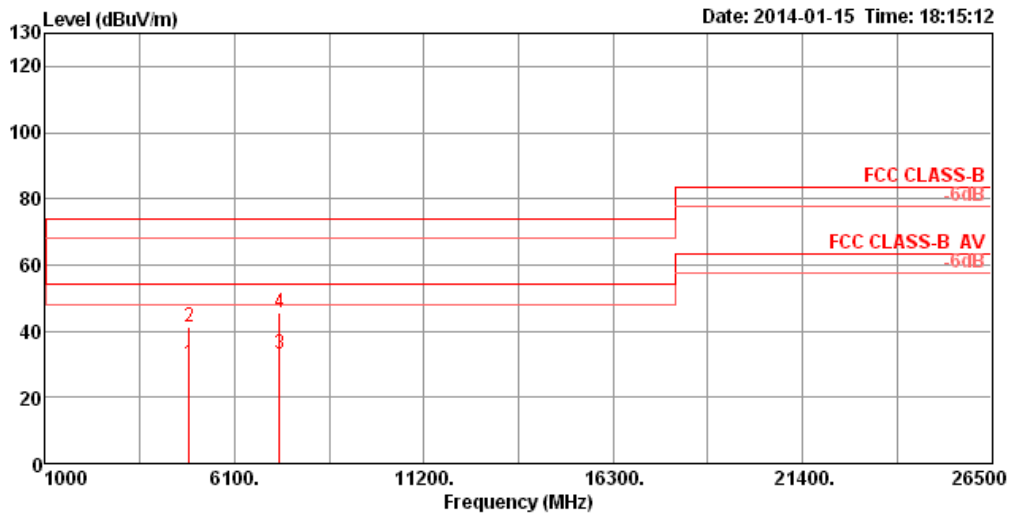

	Freq	Level	Limit	Over	Read	Cable	Antenna	Preamp	Remark	A/Pos	T/Pos	Pol/Phase
	MHz	dBuV/m	dBuV/m	dB	dBuV	dB	dB/m	dB		cm	deg	
1	4869.35	30.19	54.00	-23.81	28.77	3.33	33.12	35.03	Average	100	290	HORIZONTAL
2	4873.14	41.46	74.00	-32.54	40.00	3.33	33.16	35.03	Peak	100	290	HORIZONTAL
3	7314.49	33.30	54.00	-20.70	28.68	4.06	35.96	35.40	Average	100	87	HORIZONTAL
4	7315.90	45.55	74.00	-28.45	40.93	4.06	35.96	35.40	Peak	100	87	HORIZONTAL

Note 1: The amplitude of spurious emissions which are attenuated by more than 20 dB below the permissible value has no need to be reported.

Note 2: Emission level (dBuV/m) = 20 log Emission level (uV/m).

Note 3: Corrected Reading: Antenna Factor + Cable Loss + Read Level - Preamp Factor = Level.

Note 4: Measurement receive antenna polarization: H (Horizontal), V (Vertical)

Transmitter Radiated Emissions (1GHz~10th Harmonic)					
Operating Mode	IEEE 802.11n 40MHz MCS0 CH 6 / Ant. 1+2+3			Polarization	V
Temperature	24°C	Humidity	55%	Test Engineer	David Tseng

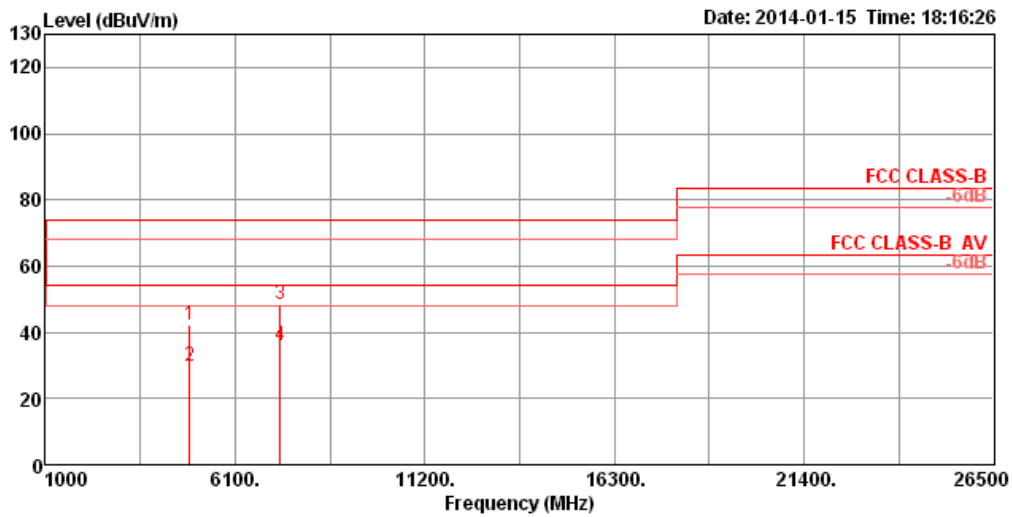

	Freq	Level	Limit	Over	Read	Cable	Antenna	Preamp	Remark	A/Pos	T/Pos	Pol/Phase
	MHz	dBuV/m	dBuV/m	dB	dBuV	dB	dB/m	dB		cm	deg	
1	4870.76	42.16	74.00	-31.84	40.70	3.33	33.16	35.03	Peak	100	82	VERTICAL
2	4875.25	29.58	54.00	-24.42	28.12	3.33	33.16	35.03	Average	100	82	VERTICAL
3	7313.98	48.64	74.00	-25.36	44.02	4.06	35.96	35.40	Peak	123	270	VERTICAL
4	7314.85	36.08	54.00	-17.92	31.46	4.06	35.96	35.40	Average	123	270	VERTICAL

Note 1: The amplitude of spurious emissions which are attenuated by more than 20 dB below the permissible value has no need to be reported.
 Note 2: Emission level (dBuV/m) = 20 log Emission level (uV/m).
 Note 3: Corrected Reading: Antenna Factor + Cable Loss + Read Level - Preamp Factor = Level.
 Note 4: Measurement receive antenna polarization: H (Horizontal), V (Vertical)

Transmitter Radiated Emissions (1GHz~10th Harmonic)					
Operating Mode	IEEE 802.11n 40MHz MCS0 CH 9 / Ant. 1+2+3			Polarization	H
Temperature	24°C	Humidity	55%	Test Engineer	David Tseng

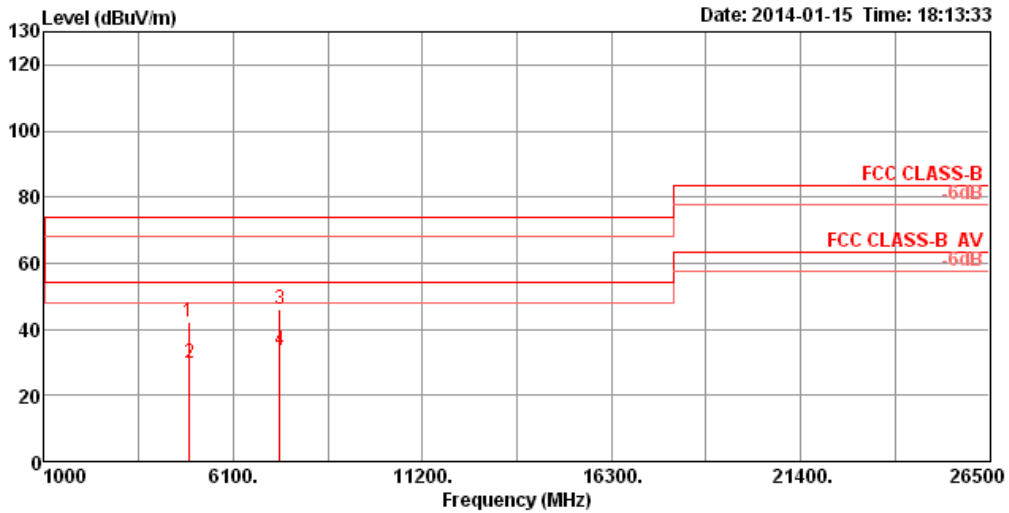

	Freq	Level	Limit	Over	Read	Cable	Antenna	Preamp	Remark	A/Pos	T/Pos	Pol/Phase
	MHz	dBuV/m	dBuV/m	dB	dBuV	dB	dB/m	dB		cm	deg	
1	4895.31	42.32	74.00	-31.68	40.81	3.34	33.19	35.02	Peak	100	55	HORIZONTAL
2	4909.48	29.84	54.00	-24.16	28.29	3.34	33.23	35.02	Average	100	55	HORIZONTAL
3	7355.42	46.21	74.00	-27.79	41.53	4.06	36.02	35.40	Peak	100	307	HORIZONTAL
4	7356.03	33.41	54.00	-20.59	28.73	4.06	36.02	35.40	Average	100	307	HORIZONTAL

Note 1: The amplitude of spurious emissions which are attenuated by more than 20 dB below the permissible value has no need to be reported.
 Note 2: Emission level (dBuV/m) = 20 log Emission level (uV/m).
 Note 3: Corrected Reading: Antenna Factor + Cable Loss + Read Level - Preamp Factor = Level.
 Note 4: Measurement receive antenna polarization: H (Horizontal), V (Vertical)

Transmitter Radiated Emissions (1GHz~10th Harmonic)					
Operating Mode	IEEE 802.11n 40MHz MCS0 CH 9 / Ant. 1+2+3			Polarization	V
Temperature	24°C	Humidity	55%	Test Engineer	David Tseng

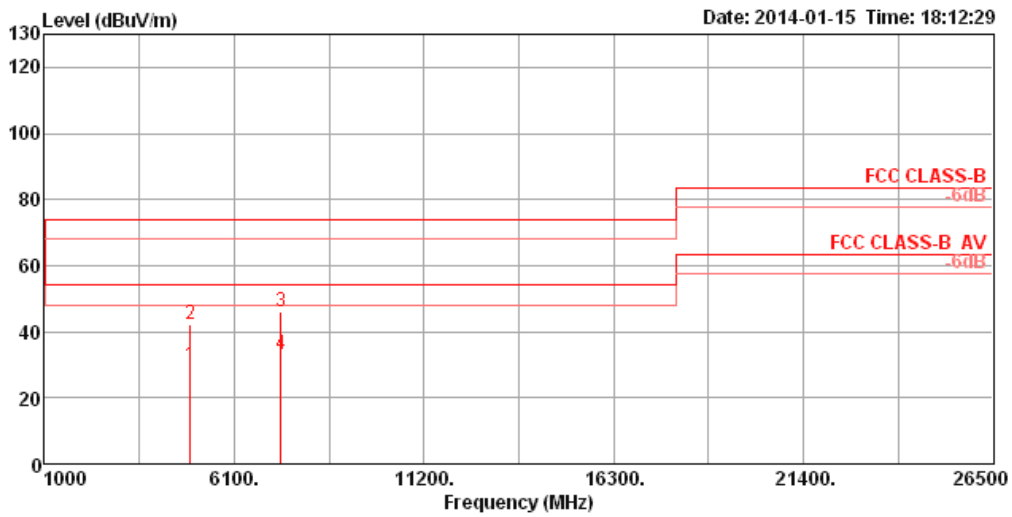

	Freq	Level	Limit	Over	Read	Cable	Antenna	Preamp	Remark	A/Pos	T/Pos	Pol/Phase
	MHz	dBuV/m	dBuV/m	dB	dBuV	dB	dB/m	dB		cm	deg	
1	4906.63	29.73	54.00	-24.27	28.18	3.34	33.23	35.02	Average	100	8	VERTICAL
2	4913.62	42.43	74.00	-31.57	40.88	3.34	33.23	35.02	Peak	100	8	VERTICAL
3	7358.34	46.16	74.00	-27.84	41.48	4.06	36.02	35.40	Peak	100	183	VERTICAL
4	7358.72	33.13	54.00	-20.87	28.41	4.06	36.06	35.40	Average	100	183	VERTICAL

Note 1: The amplitude of spurious emissions which are attenuated by more than 20 dB below the permissible value has no need to be reported.
 Note 2: Emission level (dBuV/m) = 20 log Emission level (uV/m).
 Note 3: Corrected Reading: Antenna Factor + Cable Loss + Read Level - Preamp Factor = Level.
 Note 4: Measurement receive antenna polarization: H (Horizontal), V (Vertical)

Transmitter Radiated Emissions (1GHz~10th Harmonic)					
Operating Mode	IEEE 802.11n 40MHz MCS8 CH 3 / Ant. 1+2+3			Polarization	H
Temperature	24°C	Humidity	55%	Test Engineer	David Tseng

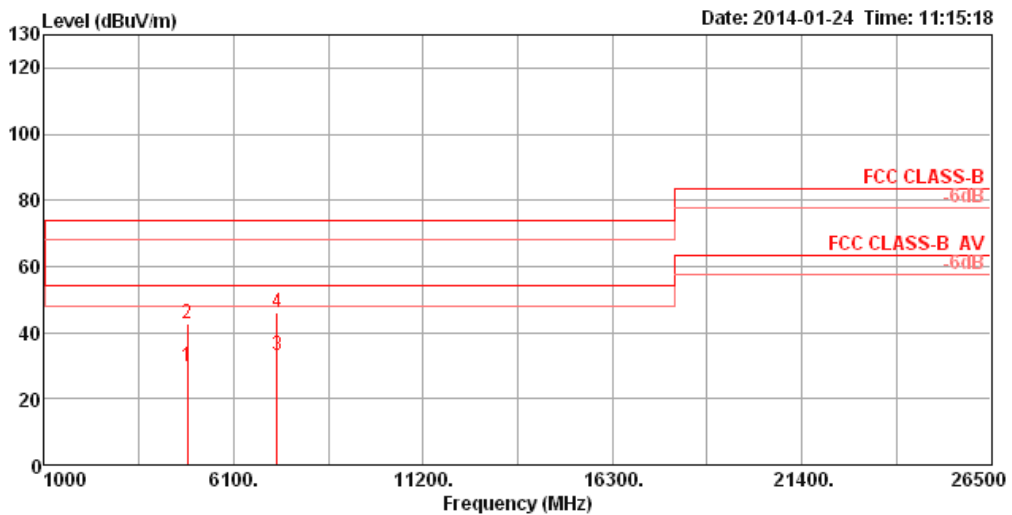

	Freq	Level	Limit	Over	Read	Cable	Antenna	Preamp	Remark	A/Pos	T/Pos	Pol/Phase
	MHz	dBuV/m	dBuV/m	dB	dBuV	dB	dB/m	dB		cm	deg	
1	4843.90	29.69	54.00	-24.31	28.31	3.32	33.09	35.03	Average	100	102	HORIZONTAL
2	4844.20	42.72	74.00	-31.28	41.34	3.32	33.09	35.03	Peak	100	102	HORIZONTAL
3	7265.86	33.12	54.00	-20.88	28.61	4.06	35.85	35.40	Average	100	344	HORIZONTAL
4	7266.32	45.98	74.00	-28.02	41.47	4.06	35.85	35.40	Peak	100	344	HORIZONTAL

Note 1: The amplitude of spurious emissions which are attenuated by more than 20 dB below the permissible value has no need to be reported.
 Note 2: Emission level (dBuV/m) = 20 log Emission level (uV/m).
 Note 3: Corrected Reading: Antenna Factor + Cable Loss + Read Level - Preamp Factor = Level.
 Note 4: Measurement receive antenna polarization: H (Horizontal), V (Vertical)

Transmitter Radiated Emissions (1GHz~10th Harmonic)					
Operating Mode	IEEE 802.11n 40MHz MCS8 CH 3 / Ant. 1+2+3			Polarization	V
Temperature	24°C	Humidity	55%	Test Engineer	David Tseng

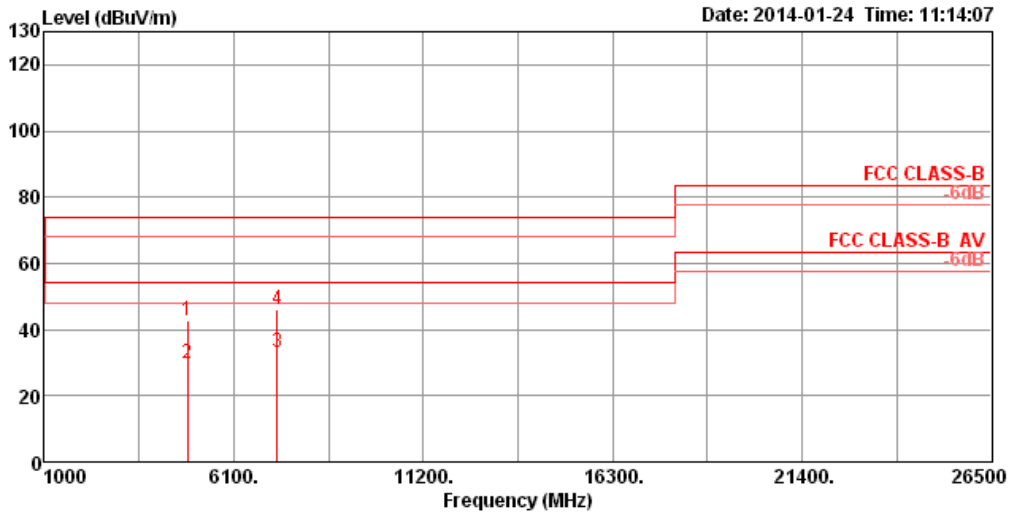

	Freq	Level	Limit	Over	Read	Cable	Antenna	Preamp	Remark	A/Pos	T/Pos	Pol/Phase
	MHz	dBuV/m	dBuV/m	dB	dBuV	dB	dB/m	dB		cm	deg	
1	4843.92	42.62	74.00	-31.38	41.24	3.32	33.09	35.03	Peak	100	19	VERTICAL
2	4844.01	29.69	54.00	-24.31	28.31	3.32	33.09	35.03	Average	100	19	VERTICAL
3	7265.86	33.06	54.00	-20.94	28.55	4.06	35.85	35.40	Average	100	245	VERTICAL
4	7266.99	46.26	74.00	-27.74	41.75	4.06	35.85	35.40	Peak	100	245	VERTICAL

Note 1: The amplitude of spurious emissions which are attenuated by more than 20 dB below the permissible value has no need to be reported.

Note 2: Emission level (dBuV/m) = 20 log Emission level (uV/m).

Note 3: Corrected Reading: Antenna Factor + Cable Loss + Read Level - Preamp Factor = Level.

Note 4: Measurement receive antenna polarization: H (Horizontal), V (Vertical)

Transmitter Radiated Emissions (1GHz~10th Harmonic)					
Operating Mode	IEEE 802.11n 40MHz MCS8 CH 6 / Ant. 1+2+3			Polarization	H
Temperature	24°C	Humidity	55%	Test Engineer	David Tseng

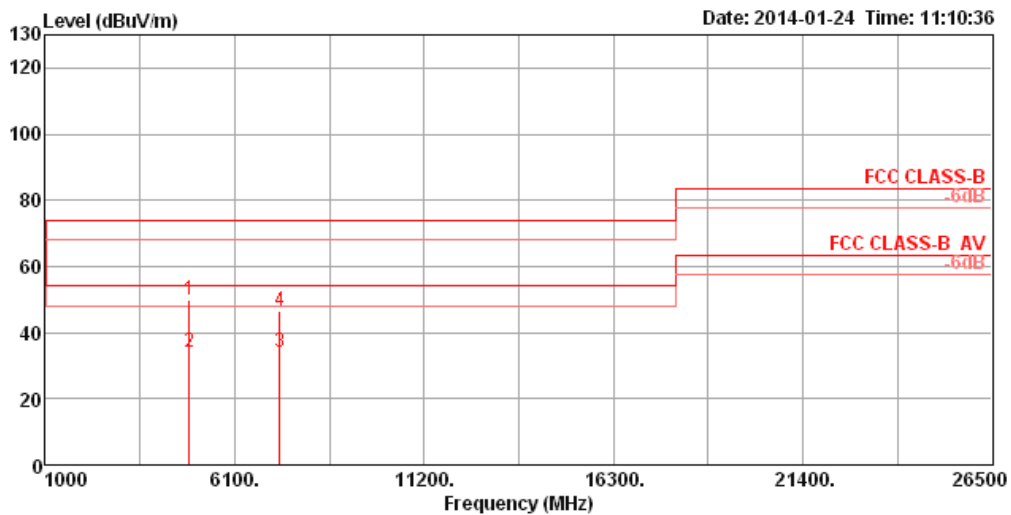

	Freq	Level	Limit	Over	Read	Cable	Antenna	Preamp	Remark	A/Pos	T/Pos	Pol/Phase
	MHz	dBuV/m	dBuV/m	dB	dBuV	dB	dB/m	dB		cm	deg	
1	4874.21	49.84	74.00	-24.16	48.38	3.33	33.16	35.03	Peak	100	354	HORIZONTAL
2	4874.66	34.07	54.00	-19.93	32.61	3.33	33.16	35.03	Average	100	354	HORIZONTAL
3	7311.13	33.98	54.00	-20.02	29.36	4.06	35.96	35.40	Average	100	22	HORIZONTAL
4	7311.28	46.52	74.00	-27.48	41.90	4.06	35.96	35.40	Peak	100	22	HORIZONTAL

Note 1: The amplitude of spurious emissions which are attenuated by more than 20 dB below the permissible value has no need to be reported.
 Note 2: Emission level (dBuV/m) = 20 log Emission level (uV/m).
 Note 3: Corrected Reading: Antenna Factor + Cable Loss + Read Level - Preamp Factor = Level.
 Note 4: Measurement receive antenna polarization: H (Horizontal), V (Vertical)

Transmitter Radiated Emissions (1GHz~10th Harmonic)					
Operating Mode	IEEE 802.11n 40MHz MCS8 CH 6 / Ant. 1+2+3			Polarization	V
Temperature	24°C	Humidity	55%	Test Engineer	David Tseng

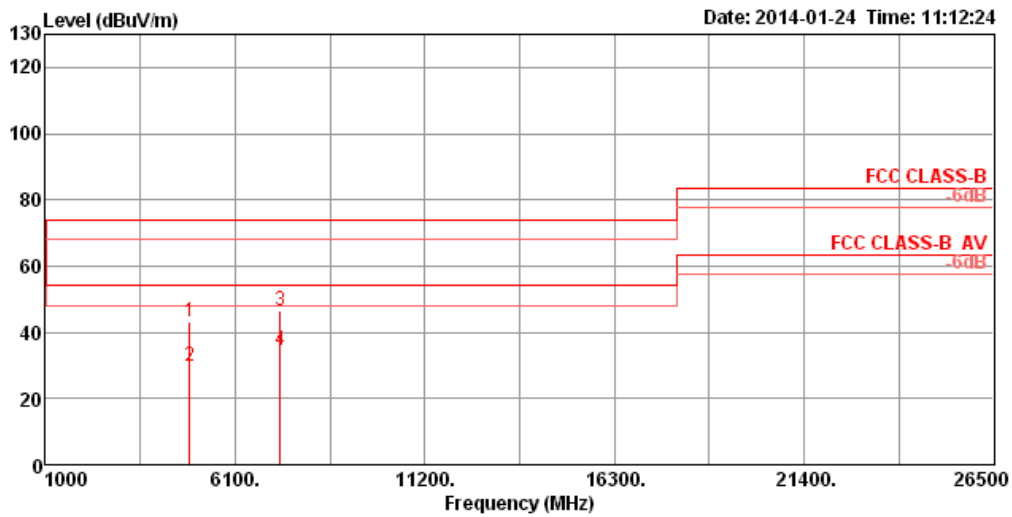

	Freq	Level	Limit	Over	Read	Cable	Antenna	Preamp	Remark	A/Pos	T/Pos	Pol/Phase
	MHz	dBuV/m	dBuV/m	dB	dBuV	dB	dB/m	dB		cm	deg	
1	4874.48	43.04	74.00	-30.96	41.58	3.33	33.16	35.03	Peak	100	193	VERTICAL
2	4874.70	29.76	54.00	-24.24	28.30	3.33	33.16	35.03	Average	100	193	VERTICAL
3	7310.12	46.32	74.00	-27.68	41.70	4.06	35.96	35.40	Peak	100	309	VERTICAL
4	7310.58	34.46	54.00	-19.54	29.84	4.06	35.96	35.40	Average	100	309	VERTICAL

Note 1: The amplitude of spurious emissions which are attenuated by more than 20 dB below the permissible value has no need to be reported.

Note 2: Emission level (dBuV/m) = 20 log Emission level (uV/m).

Note 3: Corrected Reading: Antenna Factor + Cable Loss + Read Level - Preamp Factor = Level.

Note 4: Measurement receive antenna polarization: H (Horizontal), V (Vertical)

Transmitter Radiated Emissions (1GHz~10th Harmonic)					
Operating Mode	IEEE 802.11n 40MHz MCS8 CH 9 / Ant. 1+2+3			Polarization	H
Temperature	24°C	Humidity	55%	Test Engineer	David Tseng

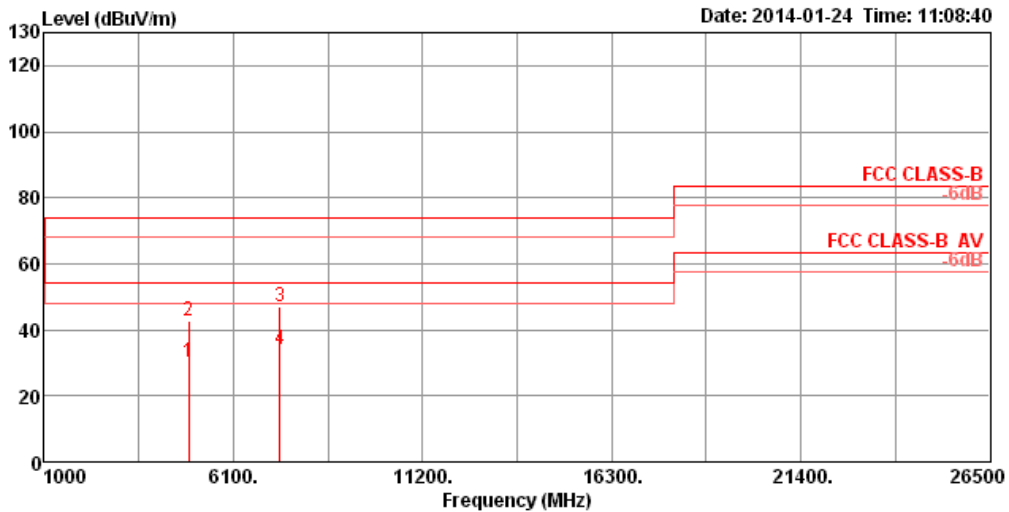

	Freq	Level	Limit	Over	Read	Cable	Antenna	Preamp	Remark	A/Pos	T/Pos	Pol/Phase
	MHz	dBuV/m	dBuV/m	dB	dBuV	dB	dB/m	dB		cm	deg	
1	4904.66	30.22	54.00	-23.78	28.71	3.34	33.19	35.02	Average	100	147	HORIZONTAL
2	4904.77	42.71	74.00	-31.29	41.16	3.34	33.23	35.02	Peak	100	147	HORIZONTAL
3	7355.28	46.81	74.00	-27.19	42.13	4.06	36.02	35.40	Peak	100	273	HORIZONTAL
4	7356.06	34.07	54.00	-19.93	29.39	4.06	36.02	35.40	Average	100	273	HORIZONTAL

Note 1: The amplitude of spurious emissions which are attenuated by more than 20 dB below the permissible value has no need to be reported.
 Note 2: Emission level (dBuV/m) = 20 log Emission level (uV/m).
 Note 3: Corrected Reading: Antenna Factor + Cable Loss + Read Level - Preamp Factor = Level.
 Note 4: Measurement receive antenna polarization: H (Horizontal), V (Vertical)

Transmitter Radiated Emissions (1GHz~10th Harmonic)					
Operating Mode	IEEE 802.11n 40MHz MCS8 CH 9 / Ant. 1+2+3			Polarization	V
Temperature	24°C	Humidity	55%	Test Engineer	David Tseng

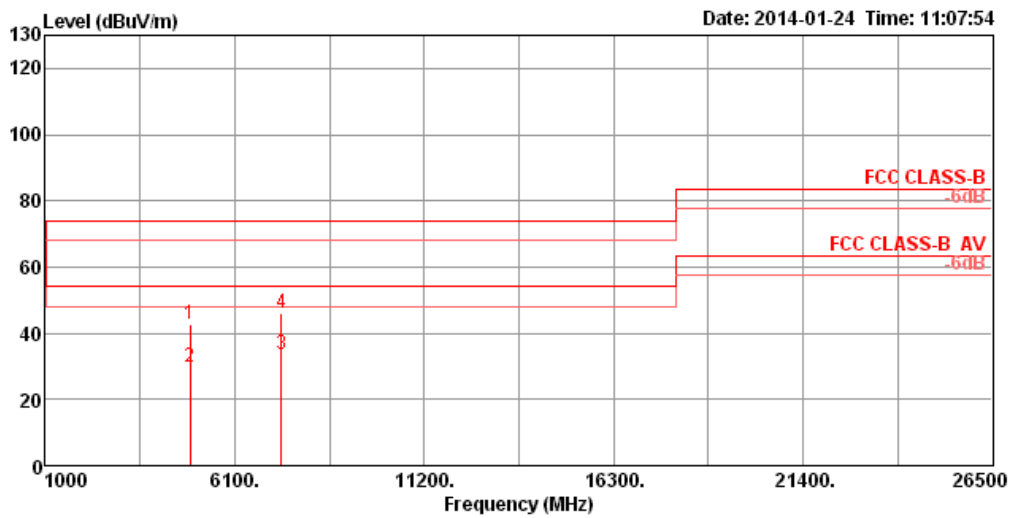

	Freq	Level	Limit	Over	Read	Cable	Antenna	Preamp	Remark	A/Pos	T/Pos	Pol/Phase
	MHz	dBuV/m	dBuV/m	dB	dBuV	dB	dB/m	dB		cm	deg	
1	4903.64	42.64	74.00	-31.36	41.13	3.34	33.19	35.02	Peak	100	16	VERTICAL
2	4904.35	29.86	54.00	-24.14	28.35	3.34	33.19	35.02	Average	100	16	VERTICAL
3	7355.86	33.39	54.00	-20.61	28.71	4.06	36.02	35.40	Average	100	152	VERTICAL
4	7356.78	46.11	74.00	-27.89	41.43	4.06	36.02	35.40	Peak	100	152	VERTICAL

Note 1: The amplitude of spurious emissions which are attenuated by more than 20 dB below the permissible value has no need to be reported.

Note 2: Emission level (dBuV/m) = 20 log Emission level (uV/m).

Note 3: Corrected Reading: Antenna Factor + Cable Loss + Read Level - Preamp Factor = Level.

Note 4: Measurement receive antenna polarization: H (Horizontal), V (Vertical)

3.6. Band Edge and Fundamental Emissions Measurement

3.6.1. Limit

20dBc in any 100 kHz bandwidth outside the operating frequency band. In case the emission fall within the restricted band specified on 15.205(a), then the 15.209(a) limit in the table below has to be followed.

Frequencies (MHz)	Field Strength (microvolt/meter)	Measurement Distance (meters)
0.009~0.490	2400/F(kHz)	300
0.490~1.705	24000/F(kHz)	30
1.705~30.0	30	30
30~88	100	3
88~216	150	3
216~960	200	3
Above 960	500	3

3.6.2. Measuring Instruments and Setting

Please refer to section 6 of equipments list in this report. The following table is the setting of the spectrum analyzer.

Spectrum Analyzer	Setting
Attenuation	Auto
Span Frequency	100 MHz
RBW / VBW (Emission in restricted band)	1MHz / 3MHz for Peak, 1MHz / 10Hz for Average
RBW / VBW (Emission in non-restricted band)	100 kHz /300 kHz for Peak

3.6.3. Test Procedures

1. The test procedure is the same as section 3.5.3, only the frequency range investigated is limited to 100MHz around bandedges.
2. In case the emission is fail due to the used RBW/VBW is too wide, marker-delta method of FCC Public Notice DA00-705 will be followed.

3.6.4. Test Setup Layout

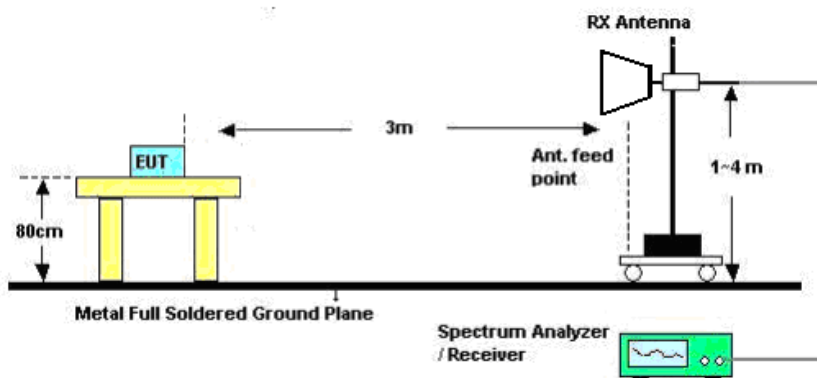

3.6.5. Test Deviation

There is no deviation with the original standard.

3.6.6. EUT Operation during Test

The EUT was programmed to be in continuously transmitting mode.

3.6.7. Test Result of Band Edge and Fundamental Emissions

Following channel(s) was (were) selected for the final test as listed below.

MODE	TX Chain	TESTED CHANNEL	MODULATION TECHNOLOGY	MODULATION TYPE	DATA RATE (Mbps)
802.11b	Ant.1	1, 6, 11	DSSS	DBPSK	1
802.11b	Ant.1+2+3, CDD	1, 6, 11	DSSS	DBPSK	1
802.11g	Ant.1	1, 6, 11	OFDM	BPSK	6
802.11g	Ant.1+2+3, CDD	1, 6, 11	OFDM	BPSK	6
802.11n 20MHz	Ant.1	1, 6, 11	OFDM	BPSK	MCS0 (6.5)
802.11n 20MHz	Ant.1+2+3, CDD	1, 6, 11	OFDM	BPSK	MCS0 (6.5)
802.11n 20MHz	Ant.1+2+3, CDD	1, 6, 11	OFDM	BPSK	MCS8 (13)
802.11n 40MHz	Ant.3	3, 6, 9	OFDM	BPSK	MCS0 (13)
802.11n 40MHz	Ant.1+2+3, CDD	3, 6, 9	OFDM	BPSK	MCS0 (13)
802.11n 40MHz	Ant.1+2+3, CDD	3, 6, 9	OFDM	BPSK	MCS8 (27)

Band Edge and Fundamental Emissions						
Operating Mode	IEEE 802.11b CH 1 / Ant. 1				Polarization	H
Temperature	24°C	Humidity	55%	Test Engineer	David Tseng	

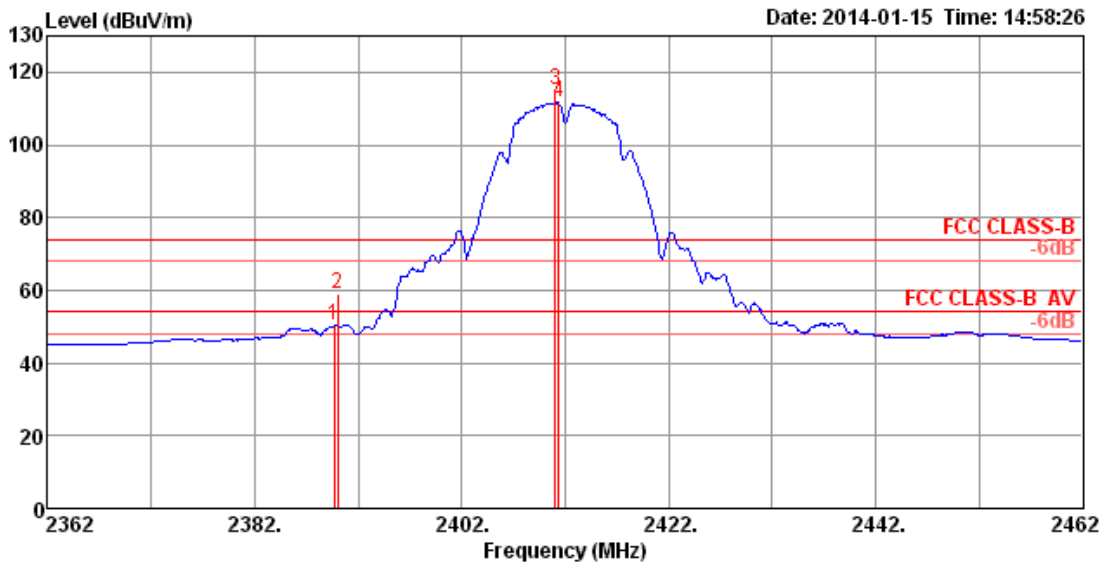

	Freq	Level	Limit Line	Over Limit	Read Level	Cable Loss	Antenna Factor	Preamp Factor	Remark	A/Pos	T/Pos	Pol/Phase
	MHz	dBuV/m	dBuV/m	dB	dBuV	dB	dB/m	dB		cm	deg	
1	2389.68	50.16	54.00	-3.84	19.78	2.21	28.17	0.00	Average	138	277	HORIZONTAL
2	2390.00	58.78	74.00	-15.22	28.39	2.22	28.17	0.00	Peak	138	277	HORIZONTAL
3	2411.04	115.37			84.94	2.22	28.21	0.00	Peak	138	277	HORIZONTAL
4	2411.36	111.66			81.23	2.22	28.21	0.00	Average	138	277	HORIZONTAL

Note 1: Item 3, 4 are the fundamental frequency at 2412 MHz
 Note 2: Emission level (dBuV/m) = 20 log Emission level (uV/m).
 Note 3: Corrected Reading: Antenna Factor + Cable Loss + Read Level - Preamp Factor = Level.
 Note 4: Measurement receive antenna polarization: H (Horizontal), V (Vertical)

Band Edge and Fundamental Emissions						
Operating Mode	IEEE 802.11b CH 1 / Ant. 1			Polarization	V	
Temperature	24°C	Humidity	55%	Test Engineer	David Tseng	

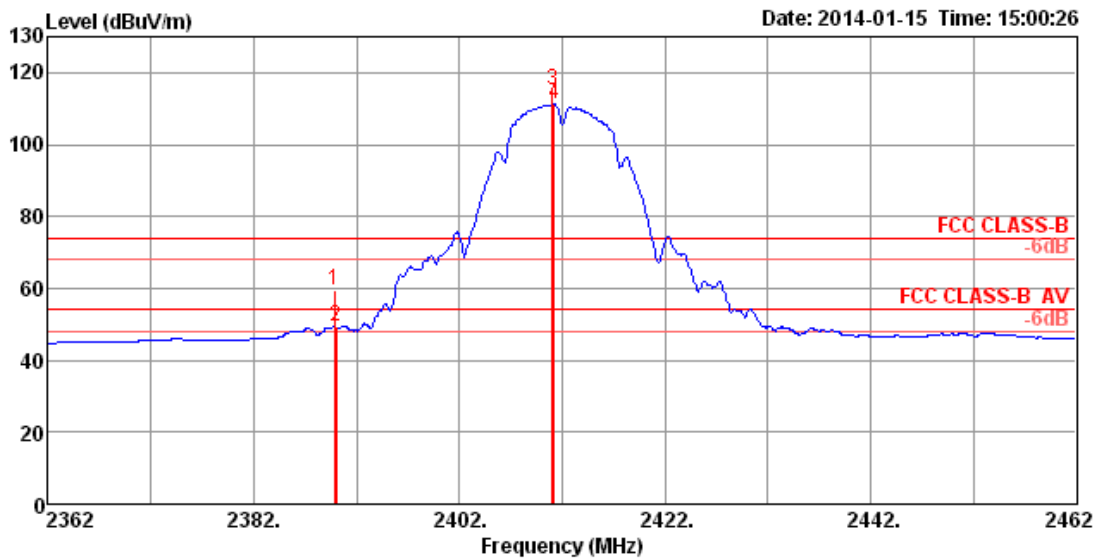

	Freq	Level	Limit	Over	Read	Cable	Antenna	Preamp	Remark	A/Pos	T/Pos	Pol/Phase
	MHz	dBuV/m	dBuV/m	dB	dBuV	dB	dB/m	dB		cm	deg	
1	2389.84	59.40	74.00	-14.60	29.01	2.22	28.17	0.00	Peak	164	190	VERTICAL
2	2390.00	49.38	54.00	-4.62	18.99	2.22	28.17	0.00	Average	164	190	VERTICAL
3	2411.04	114.97			84.54	2.22	28.21	0.00	Peak	164	190	VERTICAL
4	2411.20	111.12			80.69	2.22	28.21	0.00	Average	164	190	VERTICAL

Note 1: Item 3, 4 are the fundamental frequency at 2412 MHz
 Note 2: Emission level (dBuV/m) = 20 log Emission level (uV/m).
 Note 3: Corrected Reading: Antenna Factor + Cable Loss + Read Level - Preamp Factor = Level.
 Note 4: Measurement receive antenna polarization: H (Horizontal), V (Vertical)

Band Edge and Fundamental Emissions						
Operating Mode	IEEE 802.11b CH 6 / Ant. 1				Polarization	H
Temperature	24°C	Humidity	55%	Test Engineer	David Tseng	

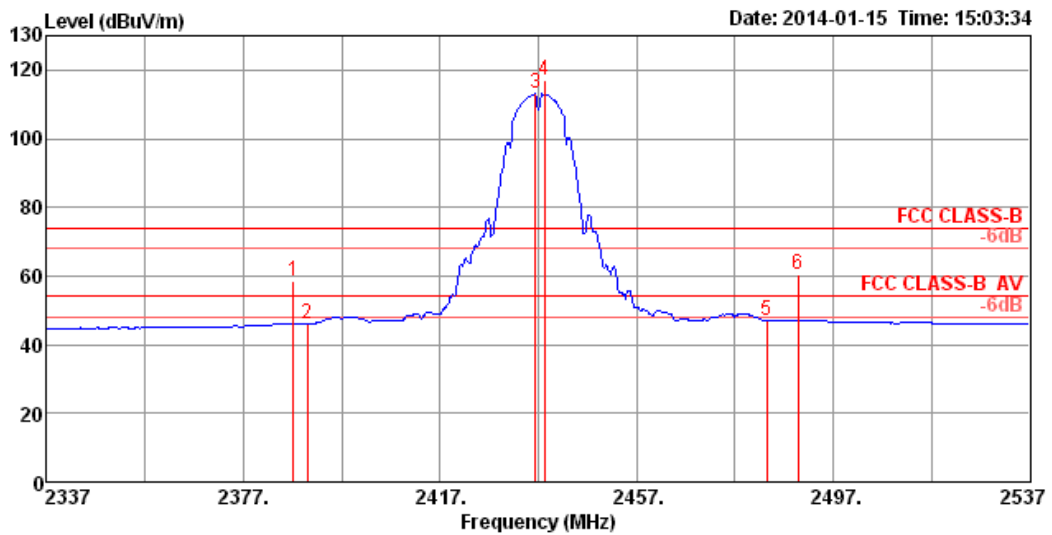

	Freq	Level	Limit	Over	Read	Cable	Antenna	Preamp	Remark	A/Pos	T/Pos	Pol/Phase
	MHz	dBuV/m	Line	Limit	Level	Loss	Factor	Factor		cm	deg	
1	2387.12	58.35	74.00	-15.65	27.97	2.21	28.17	0.00	Peak	112	276	HORIZONTAL
2	2390.00	46.04	54.00	-7.96	15.65	2.22	28.17	0.00	Average	112	276	HORIZONTAL
3	2436.36	112.99			82.47	2.23	28.29	0.00	Average	112	276	HORIZONTAL
4	2438.28	116.89			86.37	2.23	28.29	0.00	Peak	112	276	HORIZONTAL
5	2483.50	46.96	54.00	-7.04	16.32	2.26	28.38	0.00	Average	112	276	HORIZONTAL
6	2489.91	60.32	74.00	-13.68	29.64	2.26	28.42	0.00	Peak	112	276	HORIZONTAL

Note 1: Item 3, 4 are the fundamental frequency at 2437 MHz
 Note 2: Emission level (dBUV/m) = 20 log Emission level (uV/m).
 Note 3: Corrected Reading: Antenna Factor + Cable Loss + Read Level - Preamp Factor = Level.
 Note 4: Measurement receive antenna polarization: H (Horizontal), V (Vertical)

Band Edge and Fundamental Emissions					
Operating Mode	IEEE 802.11b CH 6 / Ant. 1			Polarization	V
Temperature	24°C	Humidity	55%	Test Engineer	David Tseng

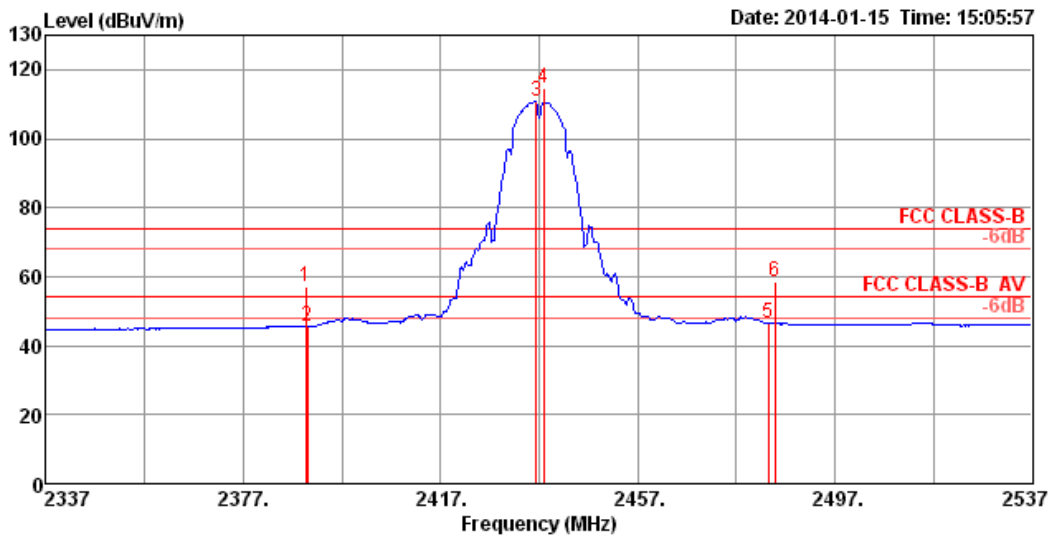

	Freq	Level	Limit Line	Over Limit	Read Level	Cable Loss	Antenna Factor	Preamp Factor	Remark	A/Pos	T/Pos	Pol/Phase
	MHz	dBuV/m	dBuV/m	dB	dBuV	dB	dB/m	dB		cm	deg	
1	2389.68	57.11	74.00	-16.89	26.73	2.21	28.17	0.00	Peak	137	193	VERTICAL
2	2390.00	45.58	54.00	-8.42	15.19	2.22	28.17	0.00	Average	137	193	VERTICAL
3	2436.36	110.78			80.26	2.23	28.29	0.00	Average	137	193	VERTICAL
4	2437.96	114.55			84.03	2.23	28.29	0.00	Peak	137	193	VERTICAL
5	2483.50	46.54	54.00	-7.46	15.91	2.26	28.37	0.00	Average	137	193	VERTICAL
6	2484.78	58.60	74.00	-15.40	27.97	2.26	28.37	0.00	Peak	137	193	VERTICAL

Note 1: Item 3, 4 are the fundamental frequency at 2437 MHz
 Note 2: Emission level (dBuV/m) = 20 log Emission level (uV/m).
 Note 3: Corrected Reading: Antenna Factor + Cable Loss + Read Level - Preamp Factor = Level.
 Note 4: Measurement receive antenna polarization: H (Horizontal), V (Vertical)

Band Edge and Fundamental Emissions						
Operating Mode	IEEE 802.11b CH 11 / Ant. 1				Polarization	H
Temperature	24°C	Humidity	55%	Test Engineer	David Tseng	

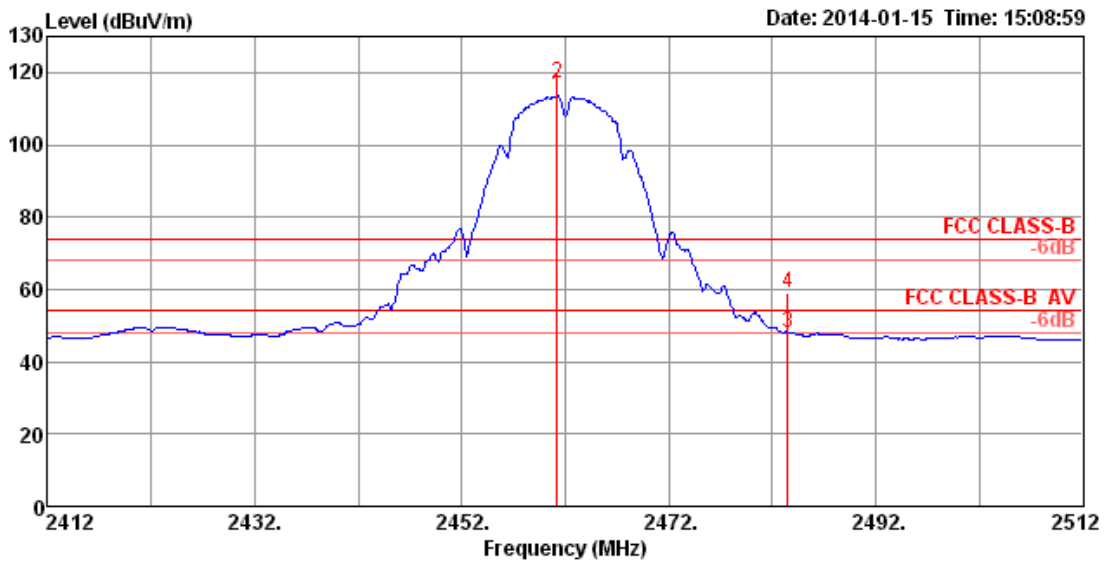

	Freq	Level	Limit Line	Over Limit	Read Level	Cable Loss	Antenna Factor	Preamp Factor	Remark	A/Pos	T/Pos	Pol/Phase
	MHz	dBuV/m	dBuV/m	dB	dBuV	dB	dB/m	dB		cm	deg	
1	2461.20	113.48			82.91	2.24	28.33	0.00	Average	158	139	HORIZONTAL
2	2461.20	117.21			86.64	2.24	28.33	0.00	Peak	158	139	HORIZONTAL
3	2483.50	48.10	54.00	-5.90	17.46	2.26	28.38	0.00	Average	158	139	HORIZONTAL
4	2483.50	59.22	74.00	-14.78	28.58	2.26	28.38	0.00	Peak	158	139	HORIZONTAL

Note 1: Item 1, 2 are the fundamental frequency at 2462 MHz
 Note 2: Emission level (dBUV/m) = 20 log Emission level (uV/m).
 Note 3: Corrected Reading: Antenna Factor + Cable Loss + Read Level - Preamp Factor = Level.
 Note 4: Measurement receive antenna polarization: H (Horizontal), V (Vertical)

Band Edge and Fundamental Emissions						
Operating Mode	IEEE 802.11b CH 11 / Ant. 1			Polarization	V	
Temperature	24°C	Humidity	55%	Test Engineer	David Tseng	

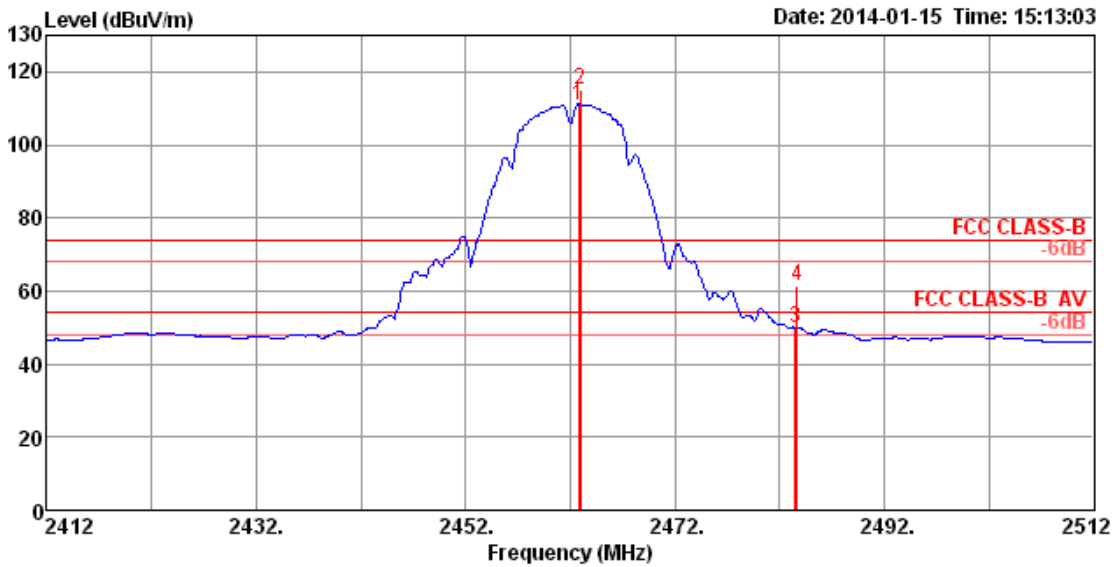

	Freq	Level	Limit	Over	Read	Cable	Antenna	Preamp	Remark	A/Pos	T/Pos	Pol/Phase
	MHz	dBuV/m	dBuV/m	dB	dBuV	dB	dB/m	dB		cm	deg	
1	2462.80	111.05			80.48	2.24	28.33	0.00	Average	183	182	VERTICAL
2	2462.96	115.02			84.45	2.24	28.33	0.00	Peak	183	182	VERTICAL
3	2483.50	49.83	54.00	-4.17	19.20	2.26	28.37	0.00	Average	183	182	VERTICAL
4	2483.66	61.48	74.00	-12.52	30.85	2.26	28.37	0.00	Peak	183	182	VERTICAL

Note 1: Item 1, 2 are the fundamental frequency at 2462 MHz
 Note 2: Emission level (dBuV/m) = 20 log Emission level (uV/m).
 Note 3: Corrected Reading: Antenna Factor + Cable Loss + Read Level - Preamp Factor = Level.
 Note 4: Measurement receive antenna polarization: H (Horizontal), V (Vertical)

Band Edge and Fundamental Emissions						
Operating Mode	IEEE 802.11b CH 1 / Ant. 1+2+3			Polarization	H	
Temperature	24°C	Humidity	55%	Test Engineer	David Tseng	

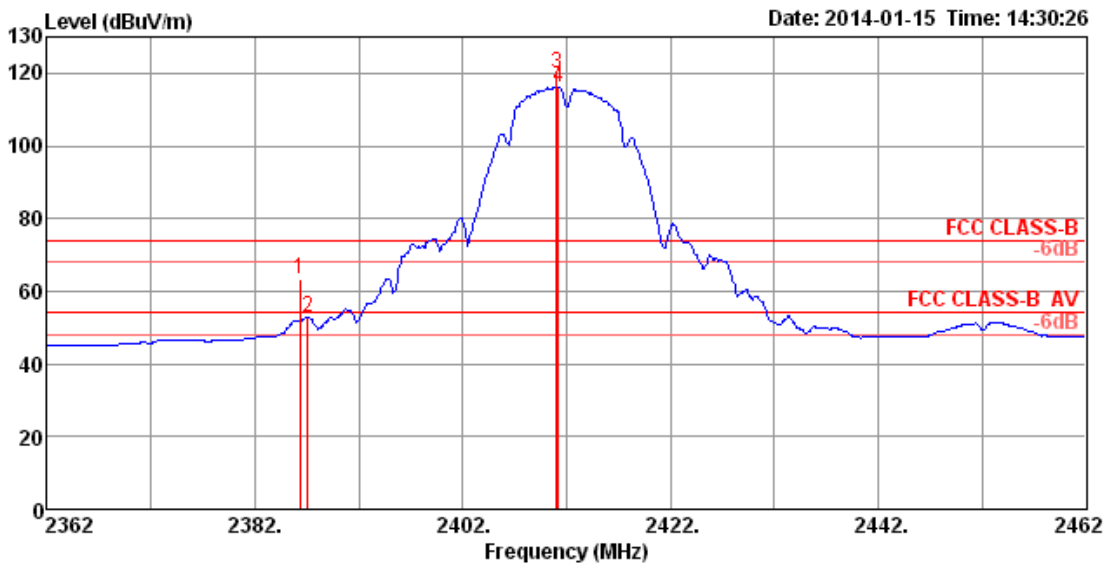

	Freq	Level	Limit	Over	Read	Cable	Antenna	Preamp	Remark	A/Pos	T/Pos	Pol/Phase
	MHz	dBuV/m	dBuV/m	dB	dBuV	dB	dB/m	dB		cm	deg	
1	2386.31	63.30	74.00	-10.70	32.92	2.21	28.17	0.00	Peak	135	251	HORIZONTAL
2	2387.12	52.98	54.00	-1.02	22.60	2.21	28.17	0.00	Average	135	251	HORIZONTAL
3	2411.04	119.80			89.37	2.22	28.21	0.00	Peak	135	251	HORIZONTAL
4	2411.20	116.00			85.57	2.22	28.21	0.00	Average	135	251	HORIZONTAL

Note 1: Item 3, 4 are the fundamental frequency at 2412 MHz
 Note 2: Emission level (dBuV/m) = 20 log Emission level (uV/m).
 Note 3: Corrected Reading: Antenna Factor + Cable Loss + Read Level - Preamp Factor = Level.
 Note 4: Measurement receive antenna polarization: H (Horizontal), V (Vertical)

Band Edge and Fundamental Emissions						
Operating Mode	IEEE 802.11b CH 1 / Ant. 1+2+3			Polarization	V	
Temperature	24°C	Humidity	55%	Test Engineer	David Tseng	

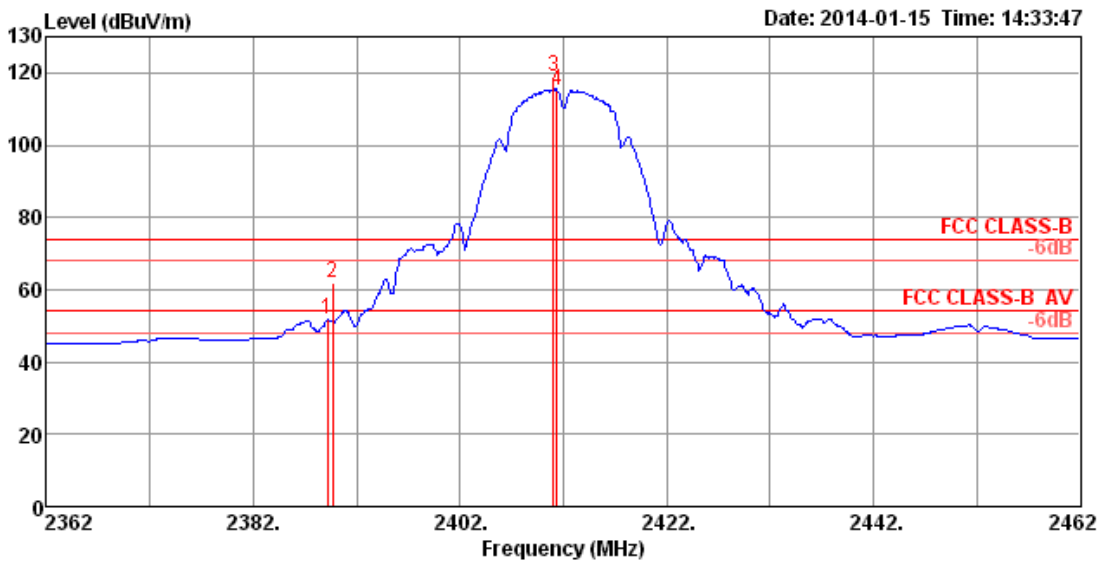

	Freq	Level	Limit Line	Over Limit	Read Level	Cable Loss	Antenna Factor	Preamp Factor	Remark	A/Pos	T/Pos	Pol/Phase
	MHz	dBuV/m	dBuV/m	dB	dBuV	dB	dB/m	dB		cm	deg	
1	2389.20	51.71	54.00	-2.29	21.33	2.21	28.17	0.00	Average	113	2	VERTICAL
2	2389.68	61.80	74.00	-12.20	31.42	2.21	28.17	0.00	Peak	113	2	VERTICAL
3	2411.04	119.17			88.74	2.22	28.21	0.00	Peak	113	2	VERTICAL
4	2411.36	115.37			84.94	2.22	28.21	0.00	Average	113	2	VERTICAL

Note 1: Item 3, 4 are the fundamental frequency at 2412 MHz
 Note 2: Emission level (dBuV/m) = 20 log Emission level (uV/m).
 Note 3: Corrected Reading: Antenna Factor + Cable Loss + Read Level - Preamp Factor = Level.
 Note 4: Measurement receive antenna polarization: H (Horizontal), V (Vertical)

Band Edge and Fundamental Emissions						
Operating Mode	IEEE 802.11b CH 6 / Ant. 1+2+3			Polarization	H	
Temperature	24°C	Humidity	55%	Test Engineer	David Tseng	

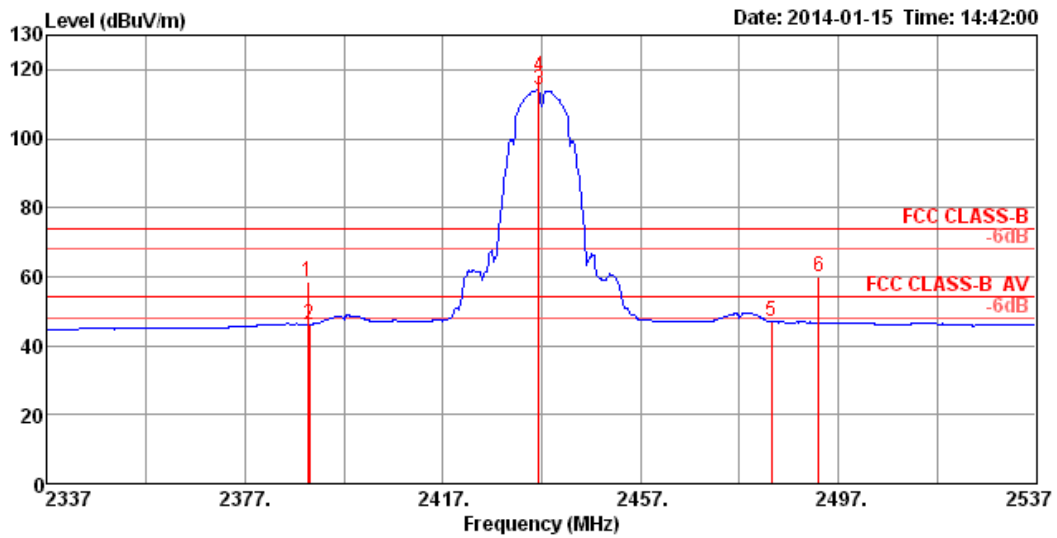

	Freq	Level	Limit Line	Over Limit	Read Level	Cable Loss	Antenna Factor	Preamp Factor	Remark	A/Pos	T/Pos	Pol/Phase
	MHz	dBuV/m	dBuV/m	dB	dBuV	dB	dB/m	dB		cm	deg	
1	2389.68	58.72	74.00	-15.28	28.34	2.21	28.17	0.00	Peak	113	279	HORIZONTAL
2	2390.00	46.18	54.00	-7.82	15.79	2.22	28.17	0.00	Average	113	279	HORIZONTAL
3	2436.36	114.09			83.57	2.23	28.29	0.00	Average	113	279	HORIZONTAL
4	2436.36	117.87			87.35	2.23	28.29	0.00	Peak	113	279	HORIZONTAL
5	2483.50	46.92	54.00	-7.08	16.28	2.26	28.38	0.00	Average	113	279	HORIZONTAL
6	2493.12	59.94	74.00	-14.06	29.25	2.27	28.42	0.00	Peak	113	279	HORIZONTAL

Note 1: Item 3, 4 are the fundamental frequency at 2437 MHz
 Note 2: Emission level (dBuV/m) = 20 log Emission level (uV/m).
 Note 3: Corrected Reading: Antenna Factor + Cable Loss + Read Level - Preamp Factor = Level.
 Note 4: Measurement receive antenna polarization: H (Horizontal), V (Vertical)

Band Edge and Fundamental Emissions						
Operating Mode	IEEE 802.11b CH 6 / Ant. 1+2+3			Polarization	V	
Temperature	24°C	Humidity	55%	Test Engineer	David Tseng	

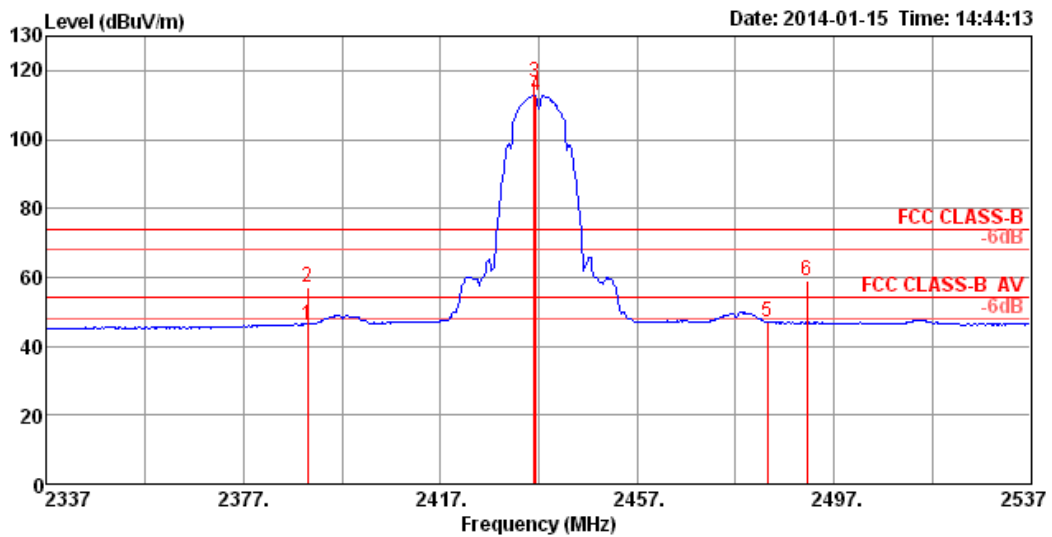

	Freq	Level	Limit Line	Over Limit	Read Level	Cable Loss	Antenna Factor	Preamp Factor	Remark	A/Pos	T/Pos	Pol/Phase
	MHz	dBuV/m	dBuV/m	dB	dBuV	dB	dB/m	dB		cm	deg	
1	2390.00	46.28	54.00	-7.72	15.89	2.22	28.17	0.00	Average	115	2	VERTICAL
2	2390.00	57.11	74.00	-16.89	26.72	2.22	28.17	0.00	Peak	115	2	VERTICAL
3	2436.04	116.40			85.88	2.23	28.29	0.00	Peak	115	2	VERTICAL
4	2436.36	112.92			82.40	2.23	28.29	0.00	Average	115	2	VERTICAL
5	2483.50	46.94	54.00	-7.06	16.31	2.26	28.37	0.00	Average	115	2	VERTICAL
6	2491.51	59.10	74.00	-14.90	28.43	2.26	28.41	0.00	Peak	115	2	VERTICAL

Note 1: Item 3, 4 are the fundamental frequency at 2437 MHz
 Note 2: Emission level (dBuV/m) = 20 log Emission level (uV/m).
 Note 3: Corrected Reading: Antenna Factor + Cable Loss + Read Level - Preamp Factor = Level.
 Note 4: Measurement receive antenna polarization: H (Horizontal), V (Vertical)

Band Edge and Fundamental Emissions						
Operating Mode	IEEE 802.11b CH 11 / Ant. 1+2+3			Polarization	H	
Temperature	24°C	Humidity	55%	Test Engineer	David Tseng	

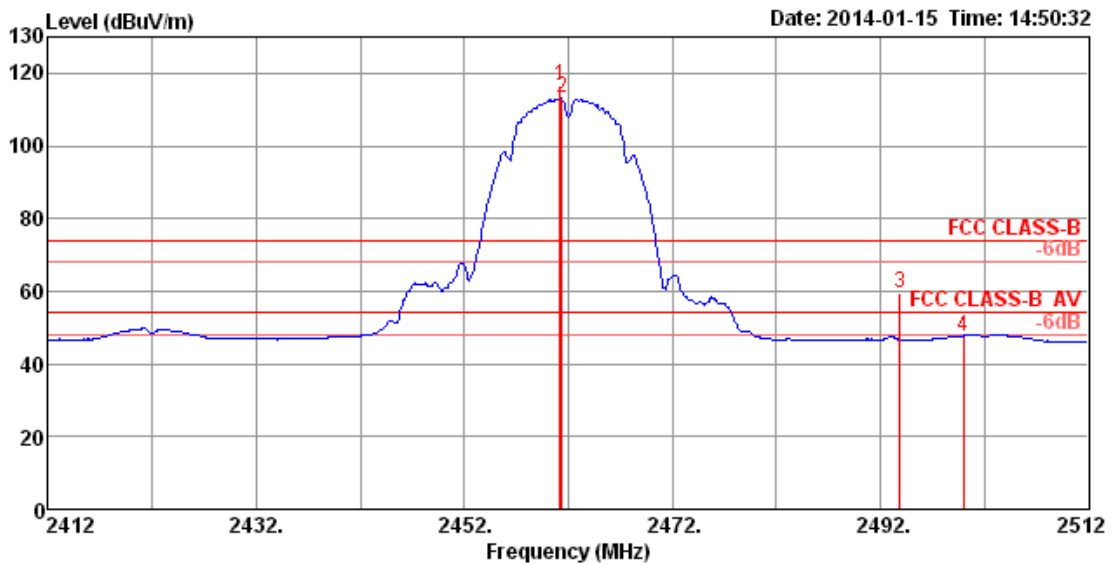

	Freq	Level	Limit	Over	Read	Cable	Antenna	Preamp	Remark	A/Pos	T/Pos	Pol/Phase
	MHz	dBuV/m	dBuV/m	dB	dBuV	dB	dB/m	dB		cm	deg	
1	2461.20	116.79			86.22	2.24	28.33	0.00	Peak	159	279	HORIZONTAL
2	2461.36	113.13			82.56	2.24	28.33	0.00	Average	159	279	HORIZONTAL
3	2493.92	59.47	74.00	-14.53	28.78	2.27	28.42	0.00	Peak	159	279	HORIZONTAL
4	2500.00	47.68	54.00	-6.32	16.99	2.27	28.42	0.00	Average	159	279	HORIZONTAL

Note 1: Item 1, 2 are the fundamental frequency at 2462 MHz
 Note 2: Emission level (dBuV/m) = 20 log Emission level (uV/m).
 Note 3: Corrected Reading: Antenna Factor + Cable Loss + Read Level - Preamp Factor = Level.
 Note 4: Measurement receive antenna polarization: H (Horizontal), V (Vertical)

Band Edge and Fundamental Emissions					
Operating Mode	IEEE 802.11b CH 11 / Ant. 1+2+3			Polarization	V
Temperature	24°C	Humidity	55%	Test Engineer	David Tseng

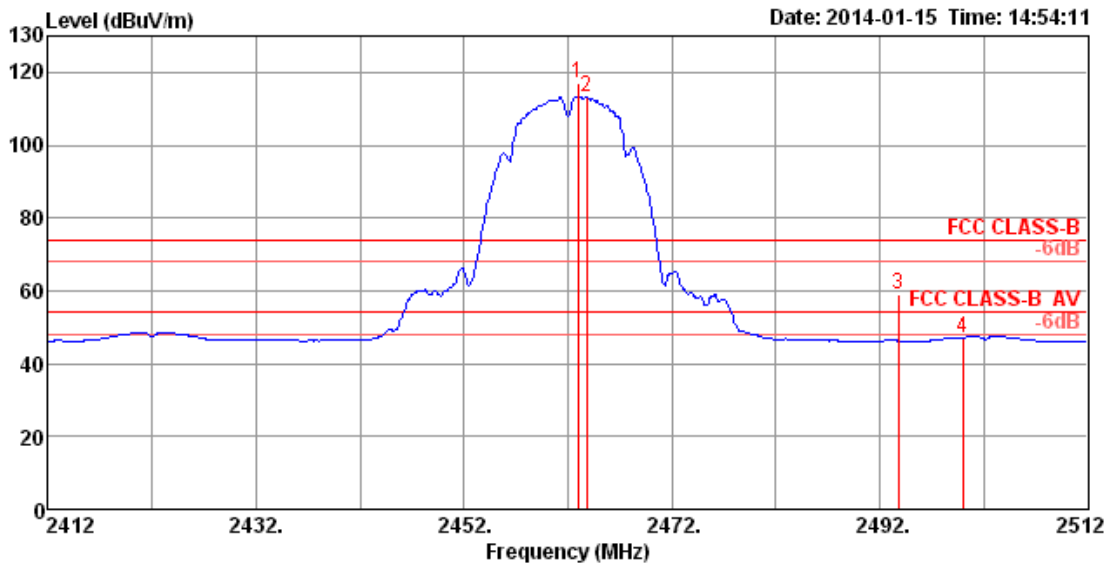

	Freq	Level	Limit	Over	Read	Cable	Antenna	Preamp	Remark	A/Pos	T/Pos	Pol/Phase
	MHz	dBuV/m	dBuV/m	dB	dBuV	dB	dB/m	dB		cm	deg	
1	2462.96	117.19			86.62	2.24	28.33	0.00	Peak	132	5	VERTICAL
2	2463.76	113.21			82.64	2.24	28.33	0.00	Average	132	5	VERTICAL
3	2493.76	59.23	74.00	-14.77	28.55	2.27	28.41	0.00	Peak	132	5	VERTICAL
4	2500.00	47.16	54.00	-6.84	16.48	2.27	28.41	0.00	Average	132	5	VERTICAL

Note 1: Item 1, 2 are the fundamental frequency at 2462 MHz
 Note 2: Emission level (dBUV/m) = 20 log Emission level (uV/m).
 Note 3: Corrected Reading: Antenna Factor + Cable Loss + Read Level - Preamp Factor = Level.
 Note 4: Measurement receive antenna polarization: H (Horizontal), V (Vertical)

Band Edge and Fundamental Emissions						
Operating Mode	IEEE 802.11g CH 1 / Ant. 1				Polarization	H
Temperature	24°C	Humidity	55%	Test Engineer	David Tseng	

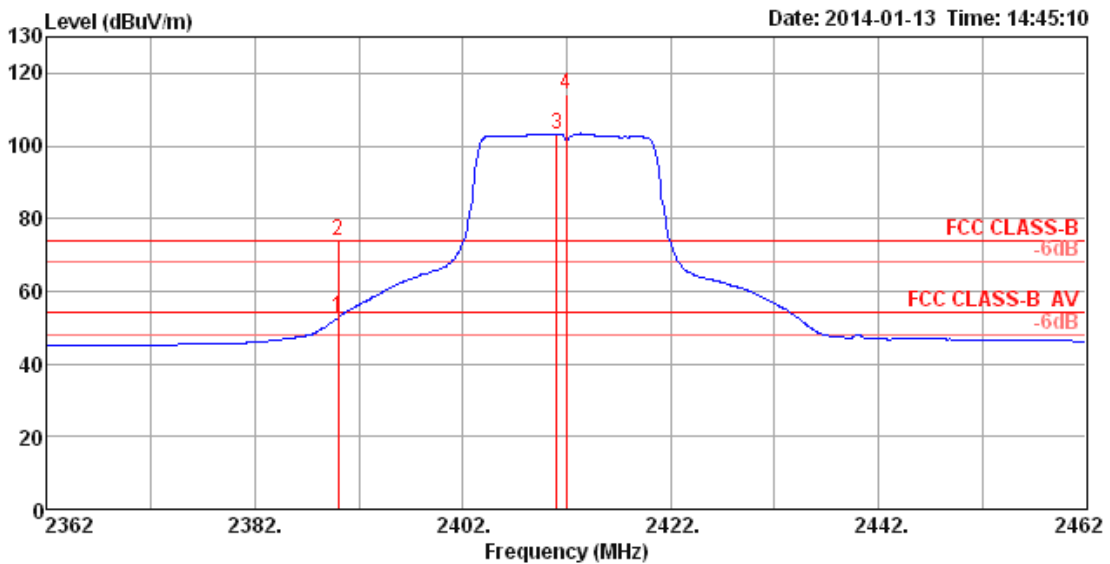

	Freq	Level	Limit	Over	Read	Cable	Antenna	Preamp	Remark	A/Pos	T/Pos	Pol/Phase
	MHz	dBuV/m	dBuV/m	dB	dBuV	Loss	Factor	Factor		cm	deg	
1	2390.00	52.74	54.00	-1.26	22.35	2.22	28.17	0.00	Average	115	274	HORIZONTAL
2	2390.00	73.93	74.00	-0.07	43.54	2.22	28.17	0.00	Peak	115	274	HORIZONTAL
3	2411.04	103.32			72.89	2.22	28.21	0.00	Average	115	274	HORIZONTAL
4	2412.00	114.02			83.59	2.22	28.21	0.00	Peak	115	274	HORIZONTAL

Note 1: Item 3, 4 are the fundamental frequency at 2412 MHz
 Note 2: Emission level (dBUV/m) = 20 log Emission level (uV/m).
 Note 3: Corrected Reading: Antenna Factor + Cable Loss + Read Level - Preamp Factor = Level.
 Note 4: Measurement receive antenna polarization: H (Horizontal), V (Vertical)

Band Edge and Fundamental Emissions					
Operating Mode	IEEE 802.11g CH 1 / Ant. 1			Polarization	V
Temperature	24°C	Humidity	55%	Test Engineer	David Tseng

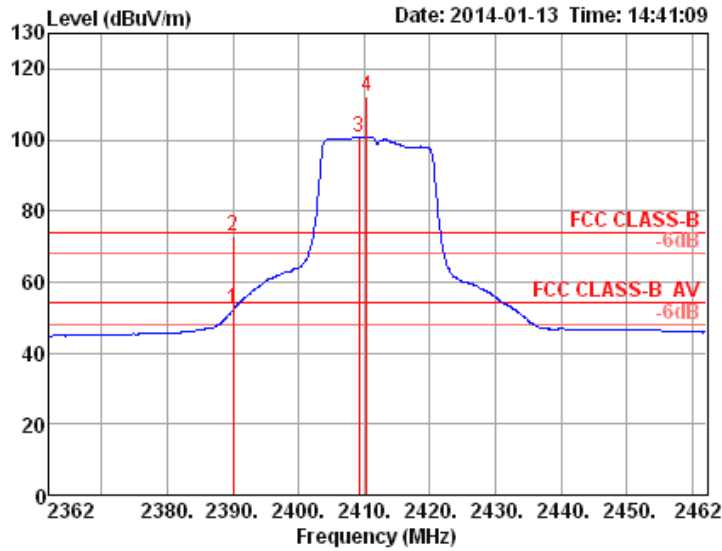

	Freq	Level	Limit	Over	Read	Cable	Antenna	Preamp	Remark	A/Pos	T/Pos	Pol/Phase
	MHz	dBuV/m	dBuV/m	dB	dBuV	dB	dB/m	dB		cm	deg	
1	2390.00	52.13	54.00	-1.87	21.74	2.22	28.17	0.00	Average	114	180	VERTICAL
2	2390.00	72.94	74.00	-1.06	42.55	2.22	28.17	0.00	Peak	114	180	VERTICAL
3	2409.28	100.85			70.42	2.22	28.21	0.00	Average	114	180	VERTICAL
4	2410.40	112.04			81.61	2.22	28.21	0.00	Peak	114	180	VERTICAL

Note 1: Item 3, 4 are the fundamental frequency at 2412 MHz
 Note 2: Emission level (dBuV/m) = 20 log Emission level (uV/m).
 Note 3: Corrected Reading: Antenna Factor + Cable Loss + Read Level - Preamp Factor = Level.
 Note 4: Measurement receive antenna polarization: H (Horizontal), V (Vertical)

Band Edge and Fundamental Emissions						
Operating Mode	IEEE 802.11g CH 6 / Ant. 1				Polarization	H
Temperature	24°C	Humidity	55%	Test Engineer	David Tseng	

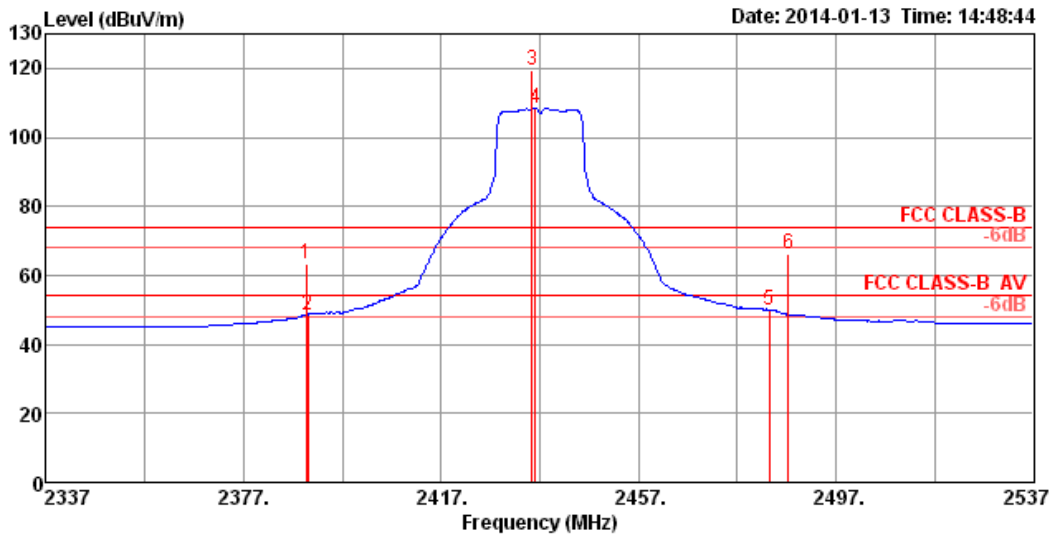

	Freq	Level	Limit	Over	Read	Cable	Antenna	Preamp	Remark	A/Pos	T/Pos	Pol/Phase
	MHz	dBuV/m	dBuV/m	dB	dBuV	dB	dB/m	dB		cm	deg	
1	2389.68	63.45	74.00	-10.55	33.07	2.21	28.17	0.00	Peak	130	137	HORIZONTAL
2	2390.00	48.61	54.00	-5.39	18.22	2.22	28.17	0.00	Average	130	137	HORIZONTAL
3	2435.40	119.24			88.72	2.23	28.29	0.00	Peak	130	137	HORIZONTAL
4	2436.04	108.26			77.74	2.23	28.29	0.00	Average	130	137	HORIZONTAL
5	2483.50	50.06	54.00	-3.94	19.42	2.26	28.38	0.00	Average	130	137	HORIZONTAL
6	2487.35	66.28	74.00	-7.72	35.60	2.26	28.42	0.00	Peak	130	137	HORIZONTAL

Note 1: Item 3, 4 are the fundamental frequency at 2437 MHz
 Note 2: Emission level (dBUV/m) = 20 log Emission level (uV/m).
 Note 3: Corrected Reading: Antenna Factor + Cable Loss + Read Level - Preamp Factor = Level.
 Note 4: Measurement receive antenna polarization: H (Horizontal), V (Vertical)

Band Edge and Fundamental Emissions					
Operating Mode	IEEE 802.11g CH 6 / Ant. 1			Polarization	V
Temperature	24°C	Humidity	55%	Test Engineer	David Tseng

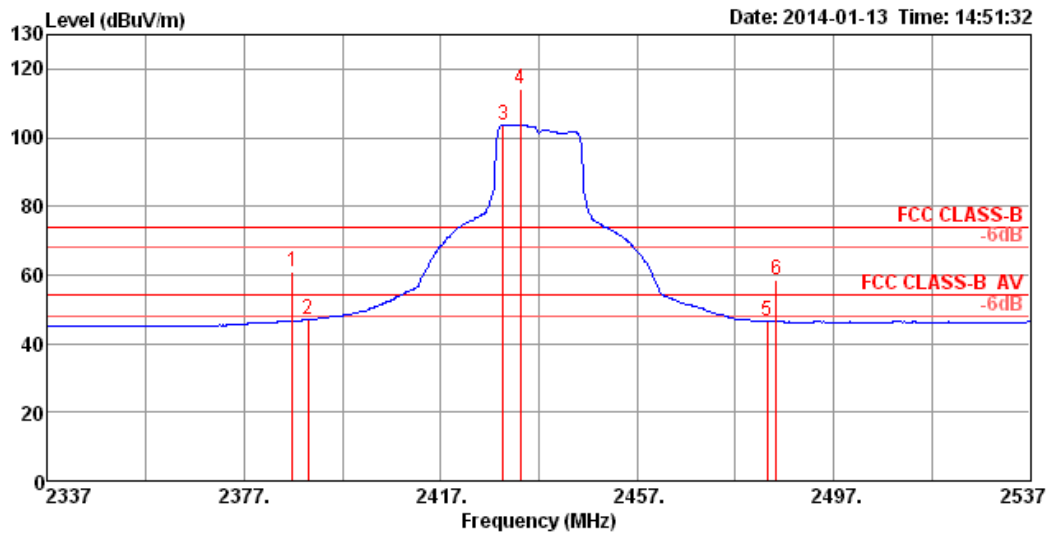

	Freq	Level	Limit Line	Over Limit	Read Level	Cable Loss	Antenna Factor	Preamp Factor	Remark	A/Pos	T/Pos	Pol/Phase
	MHz	dBuV/m	dBuV/m	dB	dBuV	dB	dB/m	dB		cm	deg	
1	2386.80	60.87	74.00	-13.13	30.49	2.21	28.17	0.00	Peak	100	192	VERTICAL
2	2390.00	46.87	54.00	-7.13	16.48	2.22	28.17	0.00	Average	100	192	VERTICAL
3	2429.63	103.80			73.32	2.23	28.25	0.00	Average	100	192	VERTICAL
4	2433.15	114.37			83.89	2.23	28.25	0.00	Peak	100	192	VERTICAL
5	2483.50	46.62	54.00	-7.38	15.99	2.26	28.37	0.00	Average	100	192	VERTICAL
6	2485.42	58.33	74.00	-15.67	27.66	2.26	28.41	0.00	Peak	100	192	VERTICAL

Note 1: Item 3, 4 are the fundamental frequency at 2437 MHz
 Note 2: Emission level (dBuV/m) = 20 log Emission level (uV/m).
 Note 3: Corrected Reading: Antenna Factor + Cable Loss + Read Level - Preamp Factor = Level.
 Note 4: Measurement receive antenna polarization: H (Horizontal), V (Vertical)

Band Edge and Fundamental Emissions					
Operating Mode	IEEE 802.11g CH 11 / Ant. 1			Polarization	H
Temperature	24°C	Humidity	55%	Test Engineer	David Tseng

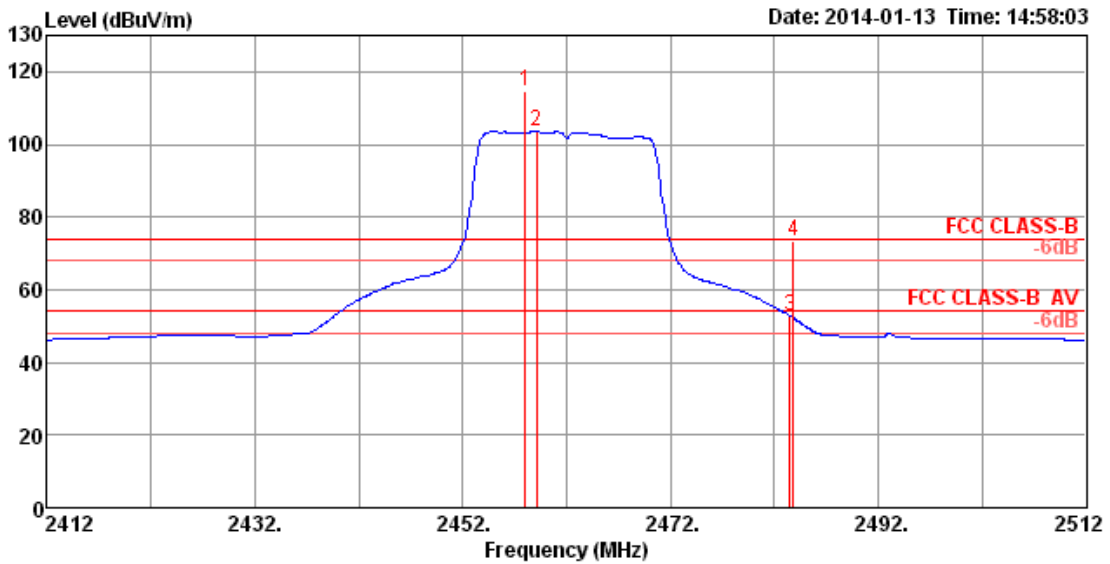

	Freq	Level	Limit	Over	Read	Cable	Antenna	Preamp	Remark	A/Pos	T/Pos	Pol/Phase
	MHz	dBuV/m	dBuV/m	dB	dBuV	dB	dB/m	dB		cm	deg	
1	2457.99	114.67			84.10	2.24	28.33	0.00	Peak	155	140	HORIZONTAL
2	2459.12	103.43			72.86	2.24	28.33	0.00	Average	155	140	HORIZONTAL
3	2483.50	52.72	54.00	-1.28	22.08	2.26	28.38	0.00	Average	155	140	HORIZONTAL
4	2483.82	73.19	74.00	-0.81	42.55	2.26	28.38	0.00	Peak	155	140	HORIZONTAL

Note 1: Item 1, 2 are the fundamental frequency at 2462 MHz
 Note 2: Emission level (dBUV/m) = 20 log Emission level (uV/m).
 Note 3: Corrected Reading: Antenna Factor + Cable Loss + Read Level - Preamp Factor = Level.
 Note 4: Measurement receive antenna polarization: H (Horizontal), V (Vertical)

Band Edge and Fundamental Emissions						
Operating Mode	IEEE 802.11g CH 11 / Ant. 1				Polarization	V
Temperature	24°C	Humidity	55%	Test Engineer	David Tseng	

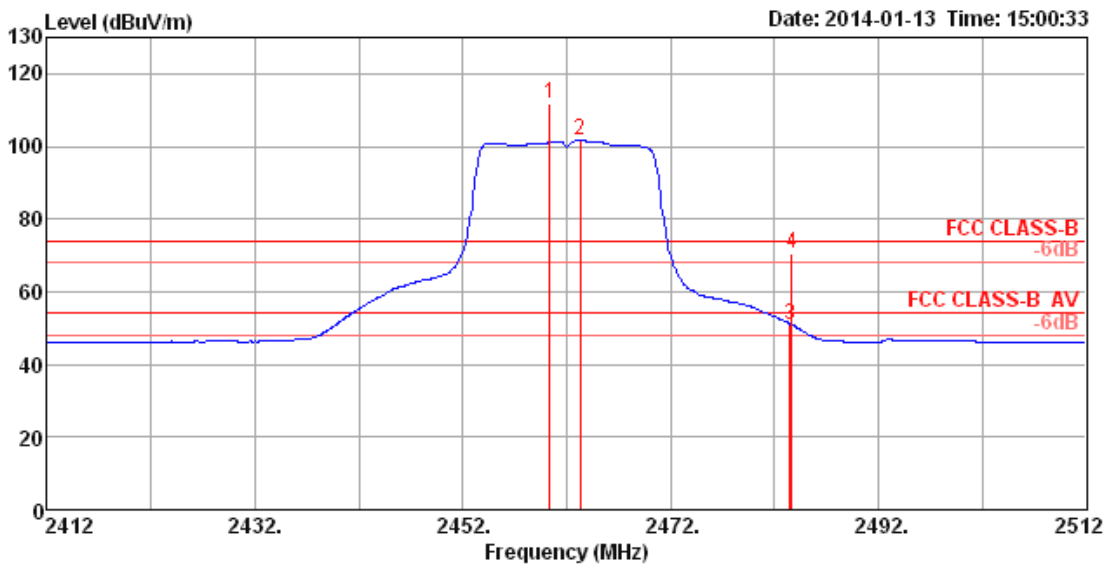

	Freq	Level	Limit	Over	Read	Cable	Antenna	Preamp	Remark	A/Pos	T/Pos	Pol/Phase
	MHz	dBuV/m	dBuV/m	dB	dBuV	dB	dB/m	dB		cm	deg	
1	2460.40	112.00			81.43	2.24	28.33	0.00	Peak	116	185	VERTICAL
2	2463.28	101.65			71.08	2.24	28.33	0.00	Average	116	185	VERTICAL
3	2483.50	51.03	54.00	-2.97	20.40	2.26	28.37	0.00	Average	116	185	VERTICAL
4	2483.66	70.74	74.00	-3.26	40.11	2.26	28.37	0.00	Peak	116	185	VERTICAL

Note 1: Item 1, 2 are the fundamental frequency at 2462 MHz
 Note 2: Emission level (dBuV/m) = 20 log Emission level (uV/m).
 Note 3: Corrected Reading: Antenna Factor + Cable Loss + Read Level - Preamp Factor = Level.
 Note 4: Measurement receive antenna polarization: H (Horizontal), V (Vertical)

Band Edge and Fundamental Emissions					
Operating Mode	IEEE 802.11g CH 1 / Ant. 1+2+3			Polarization	H
Temperature	24°C	Humidity	55%	Test Engineer	David Tseng

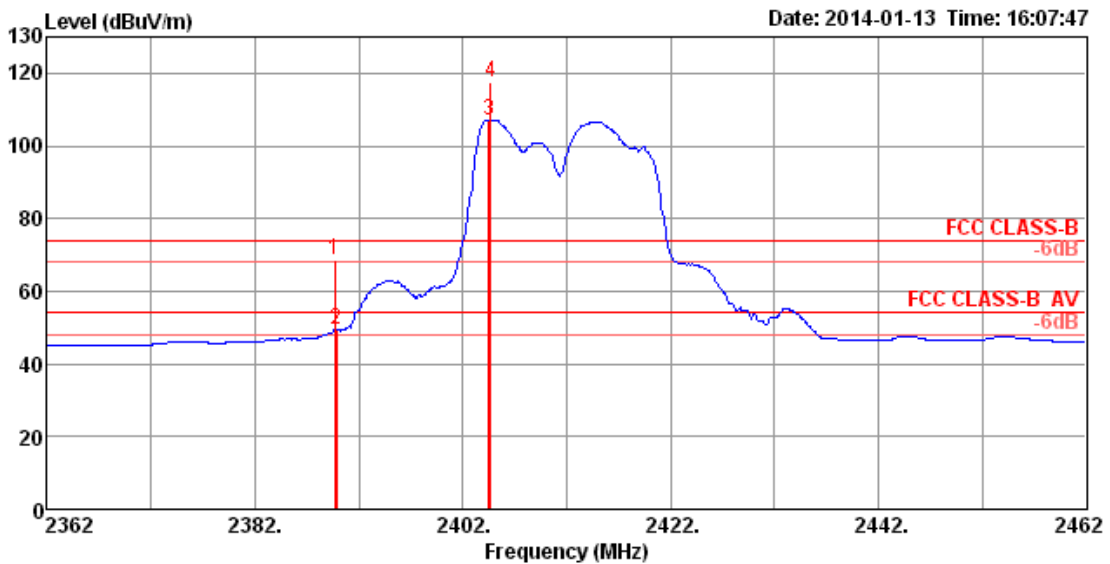

	Freq	Level	Limit	Over	Read	Cable	Antenna	Preamp	Remark	A/Pos	T/Pos	Pol/Phase
	MHz	dBUV/m	dBUV/m	dB	dBUV	Loss	Factor	Factor		cm	deg	
1	2389.68	68.70	74.00	-5.30	38.32	2.21	28.17	0.00	Peak	128	56	HORIZONTAL
2	2389.84	49.39	54.00	-4.61	19.00	2.22	28.17	0.00	Average	128	56	HORIZONTAL
3	2404.47	107.19			76.76	2.22	28.21	0.00	Average	128	56	HORIZONTAL
4	2404.63	117.71			87.28	2.22	28.21	0.00	Peak	128	56	HORIZONTAL

Note 1: Item 3, 4 are the fundamental frequency at 2412 MHz
 Note 2: Emission level (dBUV/m) = 20 log Emission level (uV/m).
 Note 3: Corrected Reading: Antenna Factor + Cable Loss + Read Level - Preamp Factor = Level.
 Note 4: Measurement receive antenna polarization: H (Horizontal), V (Vertical)

Band Edge and Fundamental Emissions						
Operating Mode	IEEE 802.11g CH 1 / Ant. 1+2+3			Polarization	V	
Temperature	24°C	Humidity	55%	Test Engineer	David Tseng	

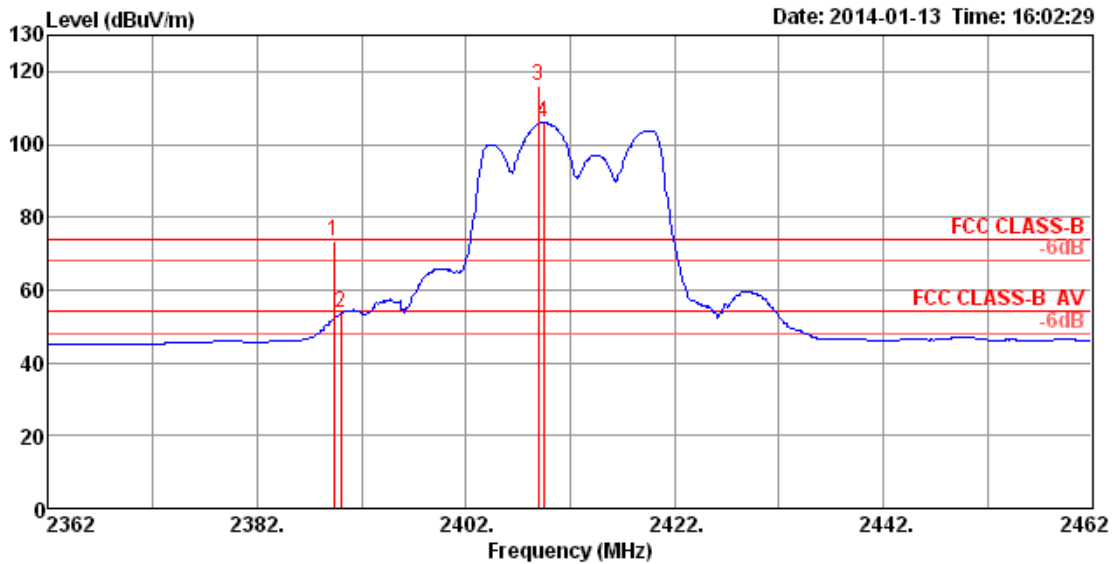

	Freq	Level	Limit	Over	Read	Cable	Antenna	Preamp	Remark	A/Pos	T/Pos	Pol/Phase
	MHz	dBuV/m	dBuV/m	dB	dBuV	dB	dB/m	dB		cm	deg	
1	2389.36	73.33	74.00	-0.67	42.95	2.21	28.17	0.00	Peak	113	178	VERTICAL
2	2390.00	53.55	54.00	-0.45	23.16	2.22	28.17	0.00	Average	113	178	VERTICAL
3	2408.96	116.22			85.79	2.22	28.21	0.00	Peak	113	178	VERTICAL
4	2409.44	106.09			75.66	2.22	28.21	0.00	Average	113	178	VERTICAL

Note 1: Item 3, 4 are the fundamental frequency at 2412 MHz
 Note 2: Emission level (dBUV/m) = 20 log Emission level (uV/m).
 Note 3: Corrected Reading: Antenna Factor + Cable Loss + Read Level - Preamp Factor = Level.
 Note 4: Measurement receive antenna polarization: H (Horizontal), V (Vertical)

Band Edge and Fundamental Emissions					
Operating Mode	IEEE 802.11g CH 6 / Ant. 1+2+3			Polarization	H
Temperature	24°C	Humidity	55%	Test Engineer	David Tseng

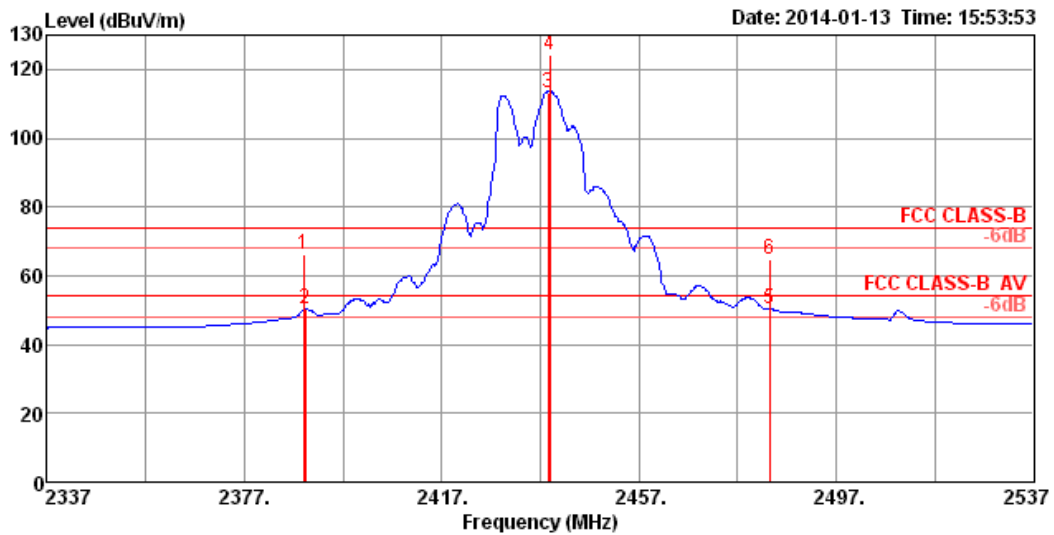

	Freq	Level	Limit Line	Over Limit	Read Level	Cable Loss	Antenna Factor	Preamp Factor	Remark	A/Pos	T/Pos	Pol/Phase
	MHz	dBuV/m	dBuV/m	dB	dBuV	dB	dB/m	dB		cm	deg	
1	2389.04	66.35	74.00	-7.65	35.97	2.21	28.17	0.00	Peak	125	48	HORIZONTAL
2	2389.36	50.21	54.00	-3.79	19.83	2.21	28.17	0.00	Average	125	48	HORIZONTAL
3	2438.60	113.39			82.87	2.23	28.29	0.00	Average	125	48	HORIZONTAL
4	2438.92	124.05			93.53	2.23	28.29	0.00	Peak	125	48	HORIZONTAL
5	2483.50	50.35	54.00	-3.65	19.71	2.26	28.38	0.00	Average	125	48	HORIZONTAL
6	2483.50	64.99	74.00	-9.01	34.35	2.26	28.38	0.00	Peak	125	48	HORIZONTAL

Note 1: Item 3, 4 are the fundamental frequency at 2437 MHz
 Note 2: Emission level (dBuV/m) = 20 log Emission level (uV/m).
 Note 3: Corrected Reading: Antenna Factor + Cable Loss + Read Level - Preamp Factor = Level.
 Note 4: Measurement receive antenna polarization: H (Horizontal), V (Vertical)

Band Edge and Fundamental Emissions						
Operating Mode	IEEE 802.11g CH 6 / Ant. 1+2+3			Polarization	V	
Temperature	24°C	Humidity	55%	Test Engineer	David Tseng	

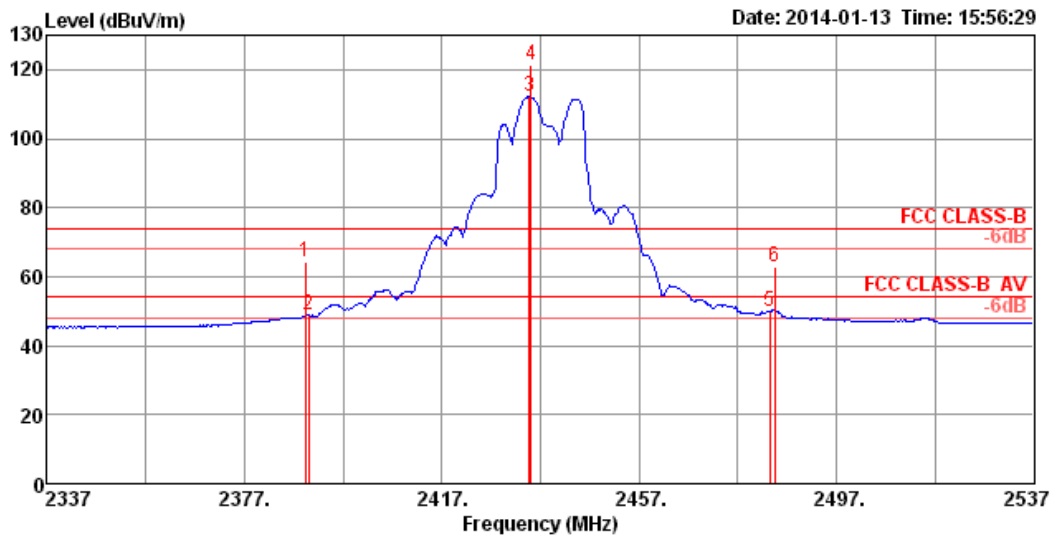

	Limit	Over	Read	Cable	Antenna	Preamp		A/Pos	T/Pos	
Freq	Line	Limit	Level	Loss	Factor	Factor	Remark			Pol/Phase
MHz	dBuV/m	dBuV/m	dB	dB	dB/m	dB		cm	deg	
1	2389.36	64.13	74.00	-9.87	33.75	2.21	28.17	0.00	Peak	134 172 VERTICAL
2	2390.00	48.87	54.00	-5.13	18.48	2.22	28.17	0.00	Average	134 172 VERTICAL
3	2434.76	112.12			81.60	2.23	28.29	0.00	Average	134 172 VERTICAL
4	2435.08	121.25			90.73	2.23	28.29	0.00	Peak	134 172 VERTICAL
5	2483.50	49.91	54.00	-4.09	19.28	2.26	28.37	0.00	Average	134 172 VERTICAL
6	2484.46	62.92	74.00	-11.08	32.29	2.26	28.37	0.00	Peak	134 172 VERTICAL

Note 1: Item 3, 4 are the fundamental frequency at 2437 MHz
 Note 2: Emission level (dBuV/m) = 20 log Emission level (uV/m).
 Note 3: Corrected Reading: Antenna Factor + Cable Loss + Read Level - Preamp Factor = Level.
 Note 4: Measurement receive antenna polarization: H (Horizontal), V (Vertical)

Band Edge and Fundamental Emissions						
Operating Mode	IEEE 802.11g CH 11 / Ant. 1+2+3			Polarization	H	
Temperature	24°C	Humidity	55%	Test Engineer	David Tseng	

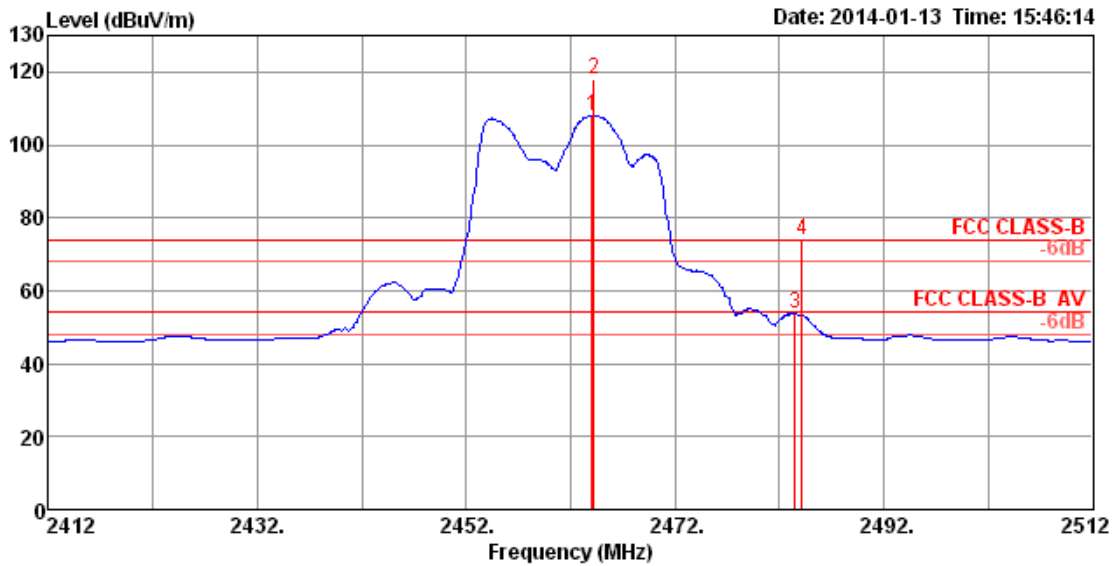

	Freq	Level	Limit	Over	Read	Cable	Antenna	Preamp	Remark	A/Pos	T/Pos	Pol/Phase
	MHz	dBuV/m	dBuV/m	dB	dBuV	dB	dB/m	dB		cm	deg	
1	2464.08	108.04			77.47	2.24	28.33	0.00	Average	100	50	HORIZONTAL
2	2464.24	118.19			87.62	2.24	28.33	0.00	Peak	100	50	HORIZONTAL
3	2483.50	53.81	54.00	-0.19	23.17	2.26	28.38	0.00	Average	100	50	HORIZONTAL
4	2484.14	73.89	74.00	-0.11	43.25	2.26	28.38	0.00	Peak	100	50	HORIZONTAL

Note 1: Item 1, 2 are the fundamental frequency at 2462 MHz
 Note 2: Emission level (dBuV/m) = 20 log Emission level (uV/m).
 Note 3: Corrected Reading: Antenna Factor + Cable Loss + Read Level - Preamp Factor = Level.
 Note 4: Measurement receive antenna polarization: H (Horizontal), V (Vertical)

Band Edge and Fundamental Emissions						
Operating Mode	IEEE 802.11g CH 11 / Ant. 1+2+3			Polarization	V	
Temperature	24°C	Humidity	55%	Test Engineer	David Tseng	

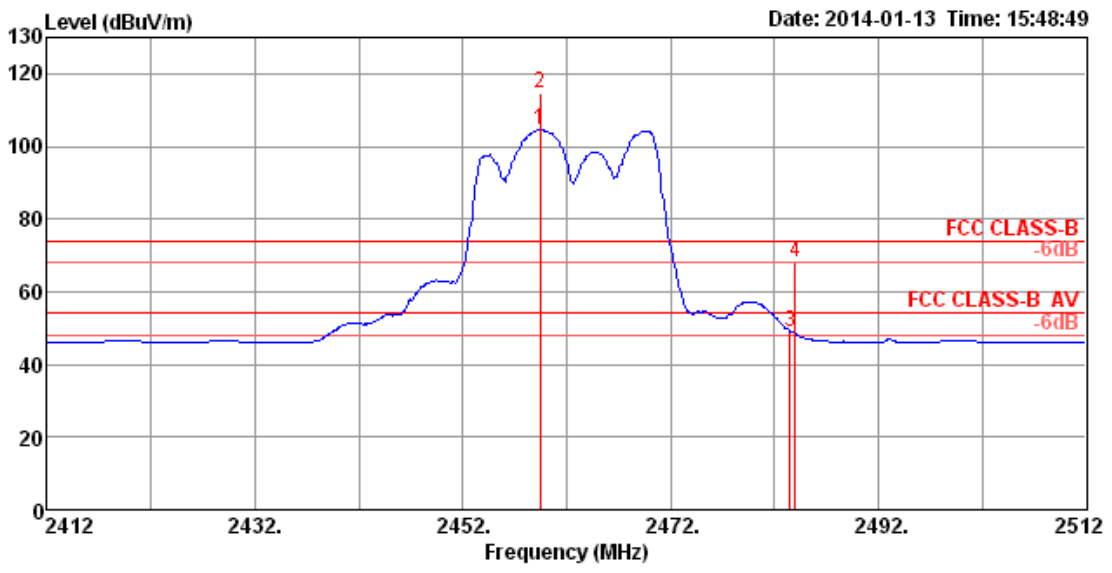

	Freq	Level	Limit	Over	Read	Cable	Antenna	Preamp	Remark	A/Pos	T/Pos	Pol/Phase
	MHz	dBuV/m	dBuV/m	dB	dBuV	dB	dB/m	dB		cm	deg	
1	2459.44	104.40			73.83	2.24	28.33	0.00	Average	109	186	VERTICAL
2	2459.44	114.77			84.20	2.24	28.33	0.00	Peak	109	186	VERTICAL
3	2483.50	48.99	54.00	-5.01	18.36	2.26	28.37	0.00	Average	109	186	VERTICAL
4	2483.98	68.07	74.00	-5.93	37.44	2.26	28.37	0.00	Peak	109	186	VERTICAL

Note 1: Item 1, 2 are the fundamental frequency at 2462 MHz
 Note 2: Emission level (dBuV/m) = 20 log Emission level (uV/m).
 Note 3: Corrected Reading: Antenna Factor + Cable Loss + Read Level - Preamp Factor = Level.
 Note 4: Measurement receive antenna polarization: H (Horizontal), V (Vertical)

Band Edge and Fundamental Emissions						
Operating Mode	IEEE 802.11n 20MHz MCS0 CH 1 / Ant. 1			Polarization	H	
Temperature	24°C	Humidity	55%	Test Engineer	David Tseng	

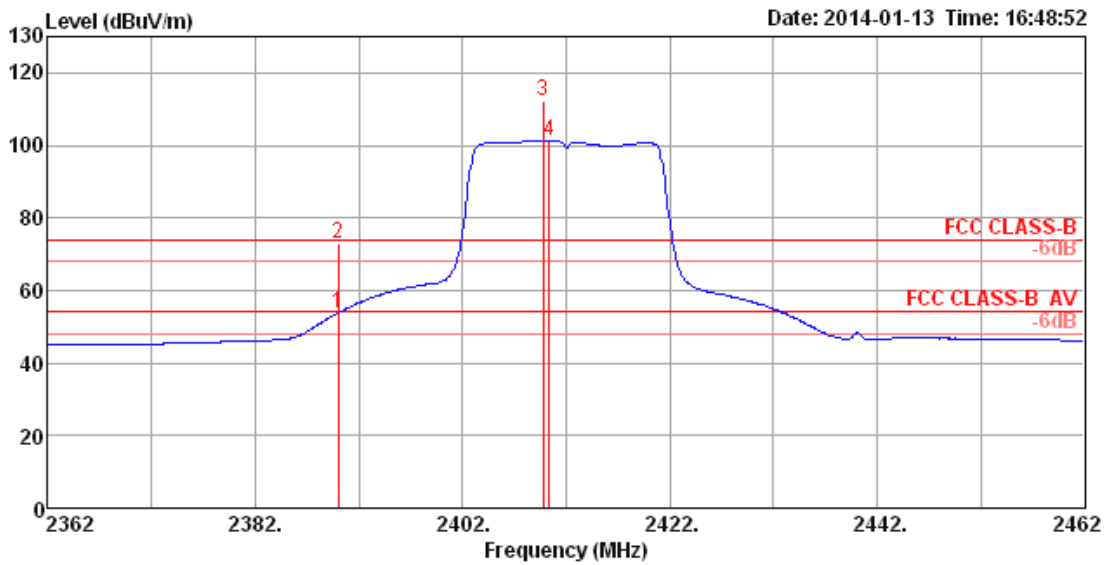

	Freq	Level	Limit	Over	Read	Cable	Antenna	Preamp	Remark	A/Pos	T/Pos	Pol/Phase
	MHz	dBuV/m	dBuV/m	dB	dBuV	dB	dB/m	dB		cm	deg	
1	2390.00	53.86	54.00	-0.14	23.47	2.22	28.17	0.00	Average	108	131	HORIZONTAL
2	2390.00	72.76	74.00	-1.24	42.37	2.22	28.17	0.00	Peak	108	131	HORIZONTAL
3	2409.76	112.48			82.05	2.22	28.21	0.00	Peak	108	131	HORIZONTAL
4	2410.40	101.36			70.93	2.22	28.21	0.00	Average	108	131	HORIZONTAL

Note 1: Item 3, 4 are the fundamental frequency at 2412 MHz
 Note 2: Emission level (dBuV/m) = 20 log Emission level (uV/m).
 Note 3: Corrected Reading: Antenna Factor + Cable Loss + Read Level - Preamp Factor = Level.
 Note 4: Measurement receive antenna polarization: H (Horizontal), V (Vertical)

Band Edge and Fundamental Emissions					
Operating Mode	IEEE 802.11n 20MHz MCS0 CH 1 / Ant. 1			Polarization	V
Temperature	24°C	Humidity	55%	Test Engineer	David Tseng

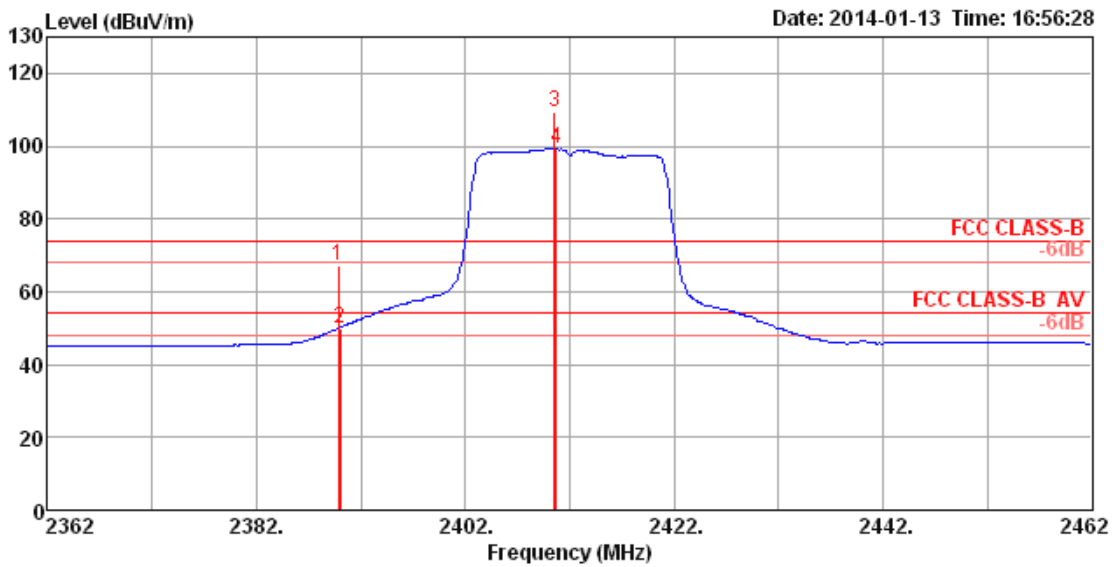

	Freq	Level	Limit	Over	Read	Cable	Antenna	Preamp	Remark	A/Pos	T/Pos	Pol/Phase
	MHz	dBuV/m	dBuV/m	dB	dBuV	dB	dB/m	dB		cm	deg	
1	2389.84	67.04	74.00	-6.96	36.65	2.22	28.17	0.00	Peak	163	171	VERTICAL
2	2390.00	49.79	54.00	-4.21	19.40	2.22	28.17	0.00	Average	163	171	VERTICAL
3	2410.56	109.38			78.95	2.22	28.21	0.00	Peak	163	171	VERTICAL
4	2410.72	99.26			68.83	2.22	28.21	0.00	Average	163	171	VERTICAL

Note 1: Item 3, 4 are the fundamental frequency at 2412 MHz
 Note 2: Emission level (dBuV/m) = 20 log Emission level (uV/m).
 Note 3: Corrected Reading: Antenna Factor + Cable Loss + Read Level - Preamp Factor = Level.
 Note 4: Measurement receive antenna polarization: H (Horizontal), V (Vertical)

Band Edge and Fundamental Emissions						
Operating Mode	IEEE 802.11n 20MHz MCS0 CH 6 / Ant. 1			Polarization	H	
Temperature	24°C	Humidity	55%	Test Engineer	David Tseng	

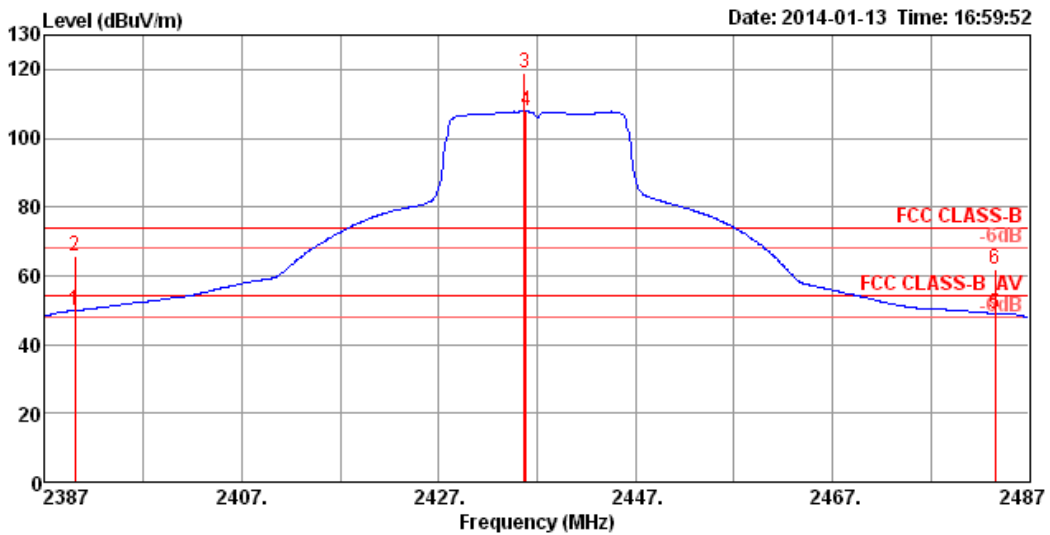

	Freq	Level	Limit Line	Over Limit	Read Level	Cable Loss	Antenna Factor	Preamp Factor	Remark	A/Pos	T/Pos	Pol/Phase
	MHz	dBuV/m	dBuV/m	dB	dBuV	dB	dB/m	dB		cm	deg	
1	2390.00	49.85	54.00	-4.15	19.46	2.22	28.17	0.00	Average	106	132	HORIZONTAL
2	2390.00	65.79	74.00	-8.21	35.40	2.22	28.17	0.00	Peak	106	132	HORIZONTAL
3	2435.72	119.08			88.56	2.23	28.29	0.00	Peak	106	132	HORIZONTAL
4	2435.88	107.77			77.25	2.23	28.29	0.00	Average	106	132	HORIZONTAL
5	2483.50	49.07	54.00	-4.93	18.43	2.26	28.38	0.00	Average	106	132	HORIZONTAL
6	2483.50	61.73	74.00	-12.27	31.09	2.26	28.38	0.00	Peak	106	132	HORIZONTAL

Note 1: Item 3, 4 are the fundamental frequency at 2437 MHz
 Note 2: Emission level (dBuV/m) = 20 log Emission level (uV/m).
 Note 3: Corrected Reading: Antenna Factor + Cable Loss + Read Level - Preamp Factor = Level.
 Note 4: Measurement receive antenna polarization: H (Horizontal), V (Vertical)

Band Edge and Fundamental Emissions						
Operating Mode	IEEE 802.11n 20MHz MCS0 CH 6 / Ant. 1			Polarization	V	
Temperature	24°C	Humidity	55%	Test Engineer	David Tseng	

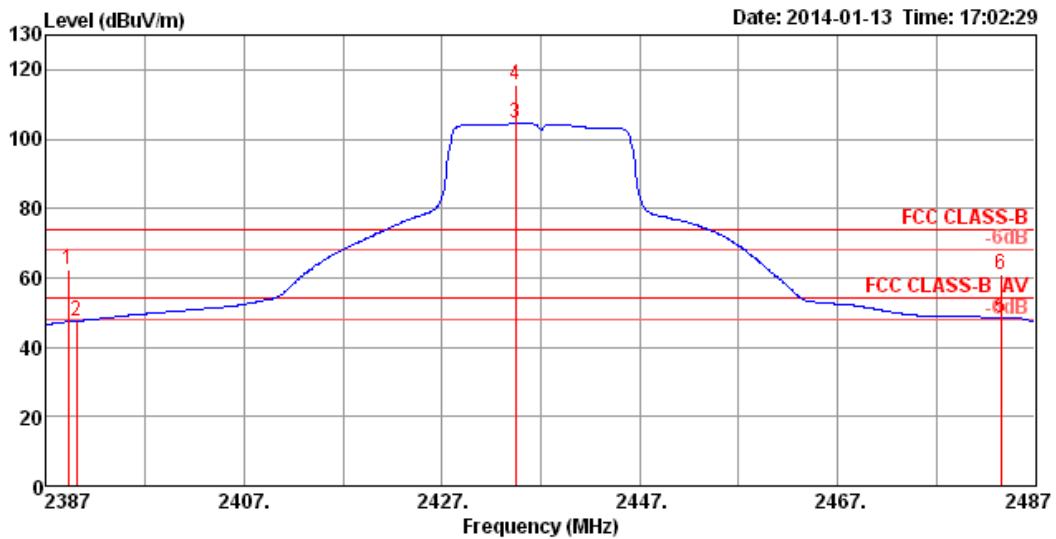

	Freq	Level	Limit Line	Over Limit	Read Level	Cable Loss	Antenna Factor	Preamp Factor	Remark	A/Pos	T/Pos	Pol/Phase
	MHz	dBuV/m	dBuV/m	dB	dBuV	dB	dB/m	dB		cm	deg	
1	2389.20	62.32	74.00	-11.68	31.94	2.21	28.17	0.00	Peak	133	172	VERTICAL
2	2390.00	47.52	54.00	-6.48	17.13	2.22	28.17	0.00	Average	133	172	VERTICAL
3	2434.44	104.51			73.99	2.23	28.29	0.00	Average	133	172	VERTICAL
4	2434.44	115.41			84.89	2.23	28.29	0.00	Peak	133	172	VERTICAL
5	2483.50	48.36	54.00	-5.64	17.73	2.26	28.37	0.00	Average	133	172	VERTICAL
6	2483.50	61.00	74.00	-13.00	30.37	2.26	28.37	0.00	Peak	133	172	VERTICAL

Note 1: Item 3, 4 are the fundamental frequency at 2437 MHz
 Note 2: Emission level (dBuV/m) = 20 log Emission level (uV/m).
 Note 3: Corrected Reading: Antenna Factor + Cable Loss + Read Level - Preamp Factor = Level.
 Note 4: Measurement receive antenna polarization: H (Horizontal), V (Vertical)

Band Edge and Fundamental Emissions					
Operating Mode	IEEE 802.11n 20MHz MCS0 CH 11 / Ant. 1			Polarization	H
Temperature	24°C	Humidity	55%	Test Engineer	David Tseng

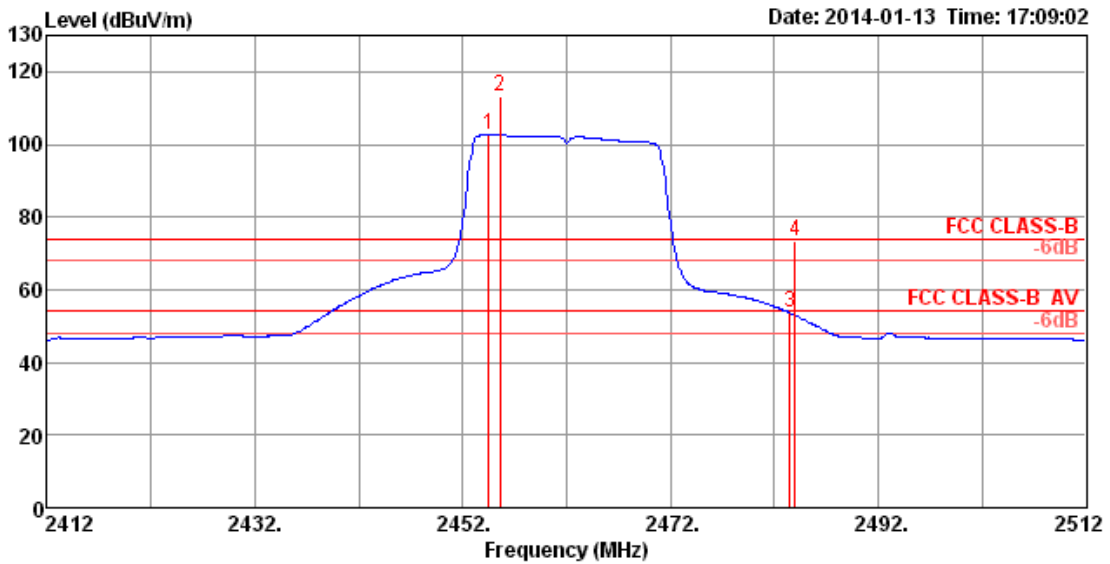

	Freq	Level	Limit	Over	Read	Cable	Antenna	Preamp	Remark	A/Pos	T/Pos	Pol/Phase
	MHz	dBuV/m	dBuV/m	dB	dBuV	dB	dB/m	dB		cm	deg	
1	2454.47	102.82			72.25	2.24	28.33	0.00	Average	106	143	HORIZONTAL
2	2455.59	113.16			82.59	2.24	28.33	0.00	Peak	106	143	HORIZONTAL
3	2483.50	53.59	54.00	-0.41	22.95	2.26	28.38	0.00	Average	106	143	HORIZONTAL
4	2483.98	73.31	74.00	-0.69	42.67	2.26	28.38	0.00	Peak	106	143	HORIZONTAL

Note 1: Item 1, 2 are the fundamental frequency at 2462 MHz
 Note 2: Emission level (dBUV/m) = 20 log Emission level (uV/m).
 Note 3: Corrected Reading: Antenna Factor + Cable Loss + Read Level - Preamp Factor = Level.
 Note 4: Measurement receive antenna polarization: H (Horizontal), V (Vertical)

Band Edge and Fundamental Emissions					
Operating Mode	IEEE 802.11n 20MHz MCS0 CH 11 / Ant. 1			Polarization	V
Temperature	24°C	Humidity	55%	Test Engineer	David Tseng

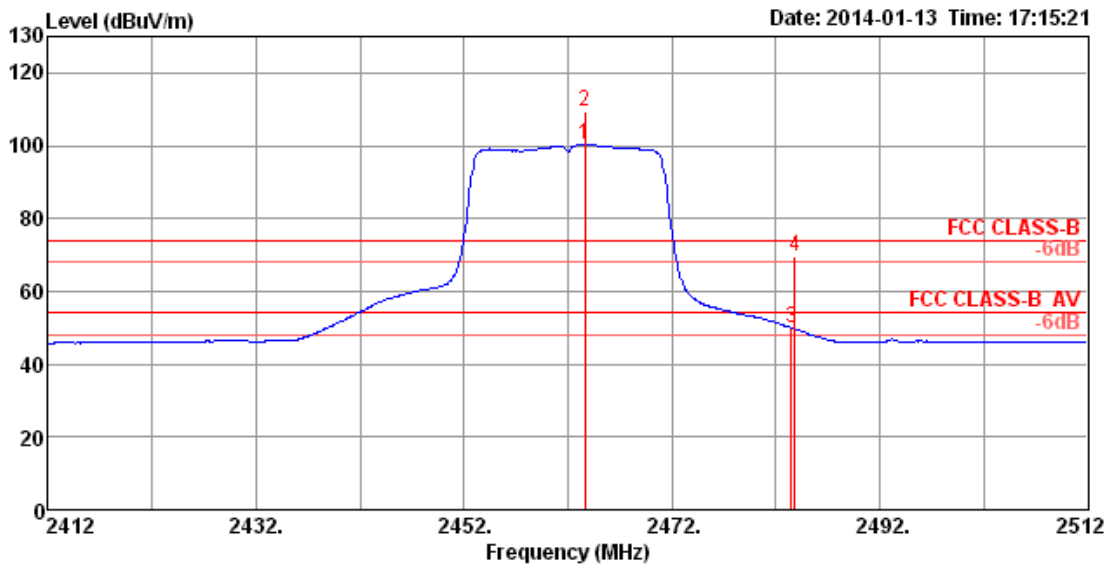

	Freq	Level	Limit	Over	Read	Cable	Antenna	Preamp	Remark	A/Pos	T/Pos	Pol/Phase
	MHz	dBuV/m	dBuV/m	dB	dBuV	dB	dB/m	dB		cm	deg	
1	2463.60	100.19			69.62	2.24	28.33	0.00	Average	116	193	VERTICAL
2	2463.60	109.22			78.65	2.24	28.33	0.00	Peak	116	193	VERTICAL
3	2483.50	49.91	54.00	-4.09	19.28	2.26	28.37	0.00	Average	116	193	VERTICAL
4	2483.82	69.41	74.00	-4.59	38.78	2.26	28.37	0.00	Peak	116	193	VERTICAL

Note 1: Item 1, 2 are the fundamental frequency at 2462 MHz
 Note 2: Emission level (dBuV/m) = 20 log Emission level (uV/m).
 Note 3: Corrected Reading: Antenna Factor + Cable Loss + Read Level - Preamp Factor = Level.
 Note 4: Measurement receive antenna polarization: H (Horizontal), V (Vertical)

Band Edge and Fundamental Emissions						
Operating Mode	IEEE 802.11n 20MHz MCS0 CH 1 / Ant. 1+2+3			Polarization	H	
Temperature	24°C	Humidity	55%	Test Engineer	David Tseng	

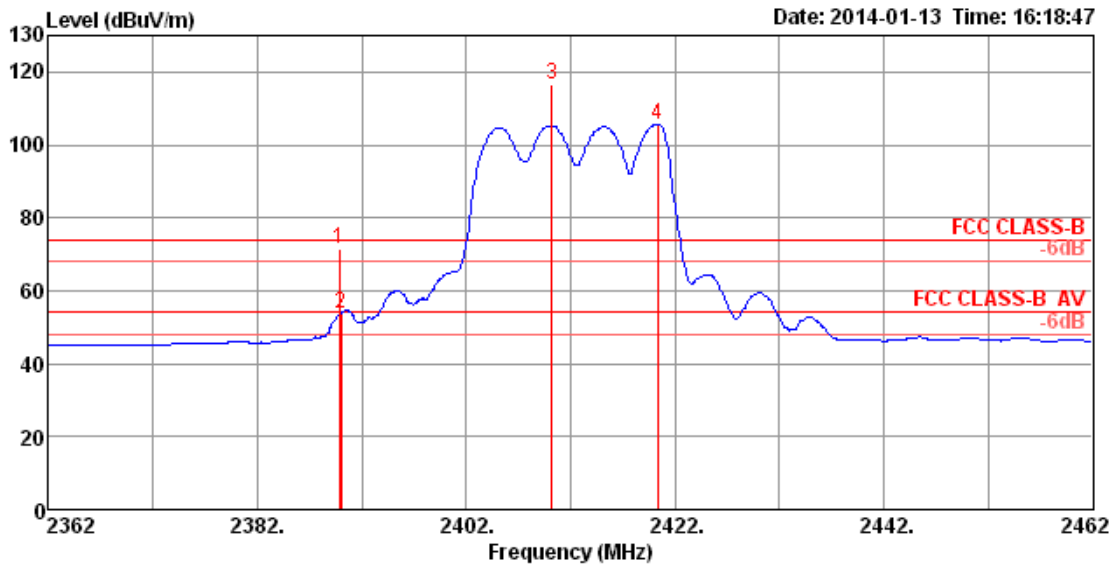

	Freq	Level	Limit	Over	Read	Cable	Antenna	Preamp	Remark	A/Pos	T/Pos	Pol/Phase
	MHz	dBuV/m	dBuV/m	dB	dBuV	dB	dB/m	dB		cm	deg	
1	2389.84	71.47	74.00	-2.53	41.08	2.22	28.17	0.00	Peak	126	64	HORIZONTAL
2	2390.00	53.89	54.00	-0.11	23.50	2.22	28.17	0.00	Average	126	64	HORIZONTAL
3	2410.24	116.51			86.08	2.22	28.21	0.00	Peak	126	64	HORIZONTAL
4	2420.33	105.62			75.14	2.23	28.25	0.00	Average	126	64	HORIZONTAL

Note 1: Item 3, 4 are the fundamental frequency at 2412 MHz
 Note 2: Emission level (dBuV/m) = 20 log Emission level (uV/m).
 Note 3: Corrected Reading: Antenna Factor + Cable Loss + Read Level - Preamp Factor = Level.
 Note 4: Measurement receive antenna polarization: H (Horizontal), V (Vertical)

Band Edge and Fundamental Emissions					
Operating Mode	IEEE 802.11n 20MHz MCS0 CH 1 / Ant. 1+2+3			Polarization	V
Temperature	24°C	Humidity	55%	Test Engineer	David Tseng

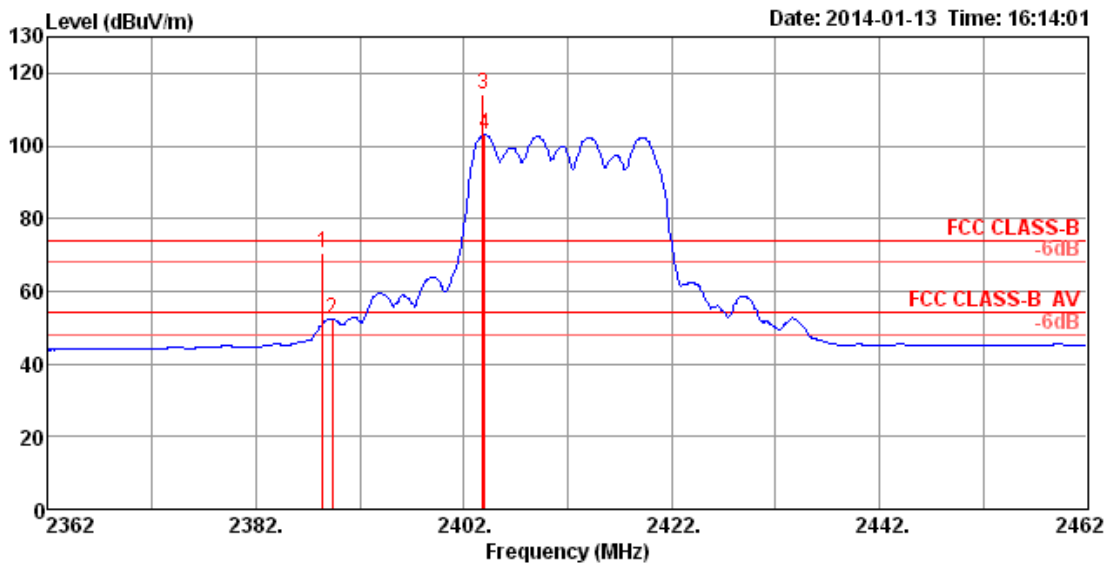

	Freq	Level	Limit Line	Over Limit	Read Level	Cable Loss	Antenna Loss	Preamp Factor	Remark	A/Pos	T/Pos	Pol/Phase
	MHz	dBuV/m	dBuV/m	dB	dBuV	dB	dB/m	dB		cm	deg	
1	2388.40	70.31	74.00	-3.69	39.93	2.21	28.17	0.00	Peak	161	186	VERTICAL
2	2389.36	52.48	54.00	-1.52	22.10	2.21	28.17	0.00	Average	161	186	VERTICAL
3	2403.83	114.01			83.58	2.22	28.21	0.00	Peak	161	186	VERTICAL
4	2403.99	103.15			72.72	2.22	28.21	0.00	Average	161	186	VERTICAL

Note 1: Item 3, 4 are the fundamental frequency at 2412 MHz
 Note 2: Emission level (dBUV/m) = 20 log Emission level (uV/m).
 Note 3: Corrected Reading: Antenna Factor + Cable Loss + Read Level - Preamp Factor = Level.
 Note 4: Measurement receive antenna polarization: H (Horizontal), V (Vertical)

Band Edge and Fundamental Emissions					
Operating Mode	IEEE 802.11n 20MHz MCS0 CH 6 / Ant. 1+2+3			Polarization	H
Temperature	24°C	Humidity	55%	Test Engineer	David Tseng

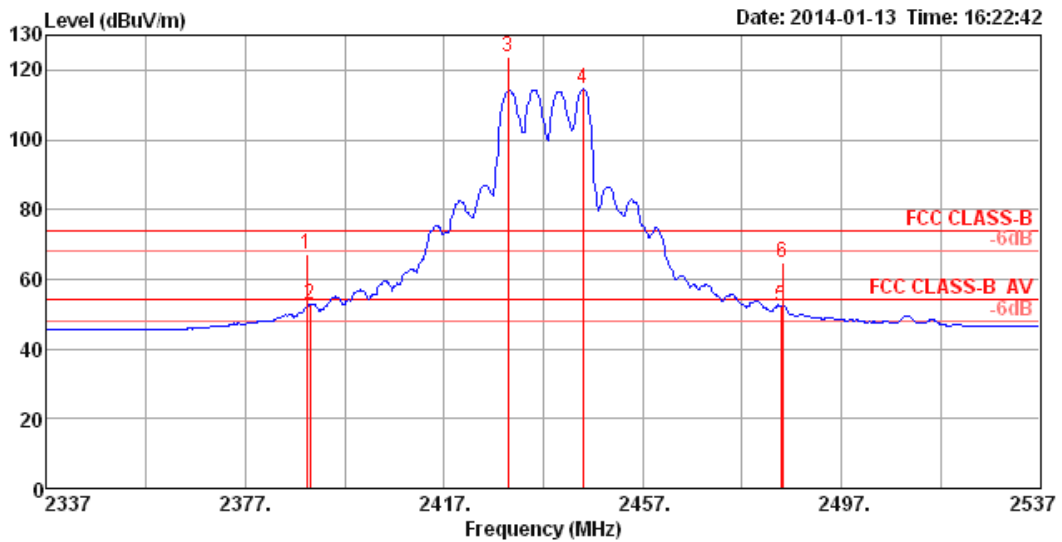

	Freq	Level	Limit Line	Over Limit	Read Level	Cable Loss	Antenna Factor	Preamp Factor	Remark	A/Pos	T/Pos	Pol/Phase
	MHz	dBuV/m	dBuV/m	dB	dBuV	dB	dB/m	dB		cm	deg	
1	2389.36	67.04	74.00	-6.96	36.66	2.21	28.17	0.00	Peak	105	61	HORIZONTAL
2	2390.00	52.74	54.00	-1.26	22.35	2.22	28.17	0.00	Average	105	61	HORIZONTAL
3	2429.95	124.00			93.52	2.23	28.25	0.00	Peak	105	61	HORIZONTAL
4	2445.01	114.46			83.93	2.24	28.29	0.00	Average	105	61	HORIZONTAL
5	2484.78	52.37	54.00	-1.63	21.73	2.26	28.38	0.00	Average	105	61	HORIZONTAL
6	2485.10	64.94	74.00	-9.06	34.26	2.26	28.42	0.00	Peak	105	61	HORIZONTAL

Note 1: Item 3, 4 are the fundamental frequency at 2437 MHz
 Note 2: Emission level (dBUV/m) = 20 log Emission level (uV/m).
 Note 3: Corrected Reading: Antenna Factor + Cable Loss + Read Level - Preamp Factor = Level.
 Note 4: Measurement receive antenna polarization: H (Horizontal), V (Vertical)

Band Edge and Fundamental Emissions						
Operating Mode	IEEE 802.11n 20MHz MCS0 CH 6 / Ant. 1+2+3			Polarization	V	
Temperature	24°C	Humidity	55%	Test Engineer	David Tseng	

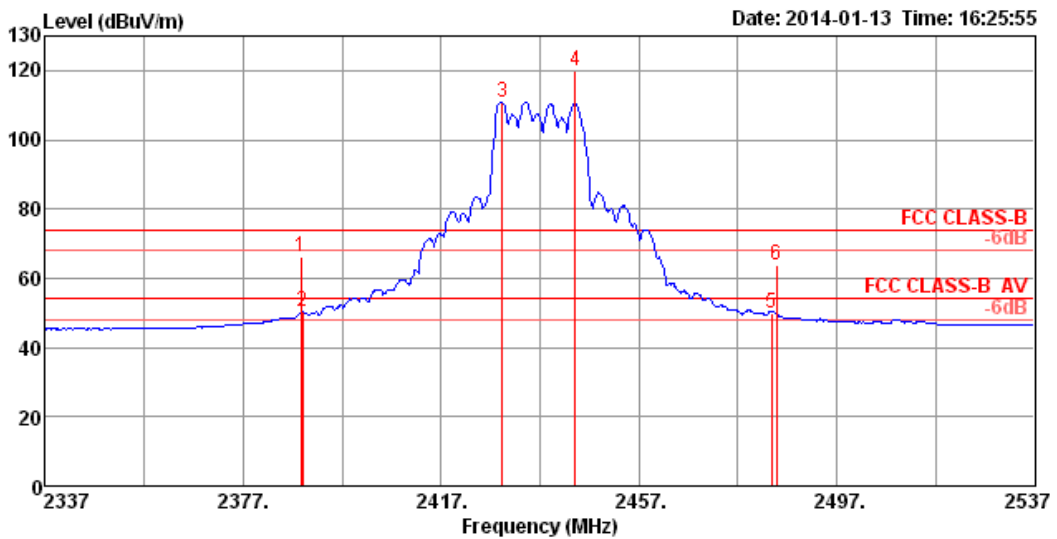

	Freq	Level	Limit Line	Over Limit	Read Level	Cable Loss	Antenna Factor	Preamp Factor	Remark	A/Pos	T/Pos	Pol/Phase
	MHz	dBuV/m	dBuV/m	dB	dBuV	dB	dB/m	dB		cm	deg	
1	2388.72	66.09	74.00	-7.91	35.71	2.21	28.17	0.00	Peak	135	175	VERTICAL
2	2389.04	50.23	54.00	-3.77	19.85	2.21	28.17	0.00	Average	135	175	VERTICAL
3	2429.31	110.88			80.40	2.23	28.25	0.00	Average	135	175	VERTICAL
4	2444.05	120.12			89.59	2.24	28.29	0.00	Peak	135	175	VERTICAL
5	2483.82	50.05	54.00	-3.95	19.42	2.26	28.37	0.00	Average	135	175	VERTICAL
6	2484.78	63.62	74.00	-10.38	32.99	2.26	28.37	0.00	Peak	135	175	VERTICAL

Note 1: Item 3, 4 are the fundamental frequency at 2437 MHz
 Note 2: Emission level (dBuV/m) = 20 log Emission level (uV/m).
 Note 3: Corrected Reading: Antenna Factor + Cable Loss + Read Level - Preamp Factor = Level.
 Note 4: Measurement receive antenna polarization: H (Horizontal), V (Vertical)

Band Edge and Fundamental Emissions					
Operating Mode	IEEE 802.11n 20MHz MCS0 CH 11 / Ant. 1+2+3			Polarization	H
Temperature	24°C	Humidity	55%	Test Engineer	David Tseng

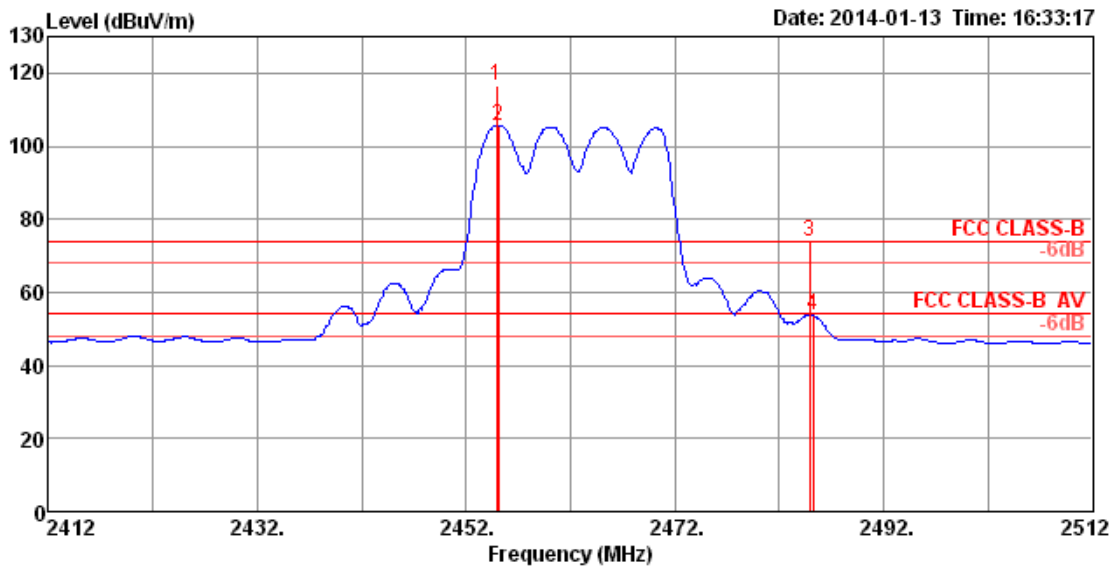

	Freq	Level	Limit	Over	Read	Cable	Antenna	Preamp	Remark	A/Pos	T/Pos	Pol/Phase
	MHz	dBuV/m	dBuV/m	dB	dBuV	dB	dB/m	dB		cm	deg	
1	2454.95	116.35			85.78	2.24	28.33	0.00	Peak	126	65	HORIZONTAL
2	2455.11	105.74			75.17	2.24	28.33	0.00	Average	126	65	HORIZONTAL
3	2484.94	73.90	74.00	-0.10	43.26	2.26	28.38	0.00	Peak	126	65	HORIZONTAL
4	2485.26	53.60	54.00	-0.40	22.92	2.26	28.42	0.00	Average	126	65	HORIZONTAL

Note 1: Item 1, 2 are the fundamental frequency at 2462 MHz
 Note 2: Emission level (dBuV/m) = 20 log Emission level (uV/m).
 Note 3: Corrected Reading: Antenna Factor + Cable Loss + Read Level - Preamp Factor = Level.
 Note 4: Measurement receive antenna polarization: H (Horizontal), V (Vertical)

Band Edge and Fundamental Emissions					
Operating Mode	IEEE 802.11n 20MHz MCS0 CH 11 / Ant. 1+2+3			Polarization	V
Temperature	24°C	Humidity	55%	Test Engineer	David Tseng

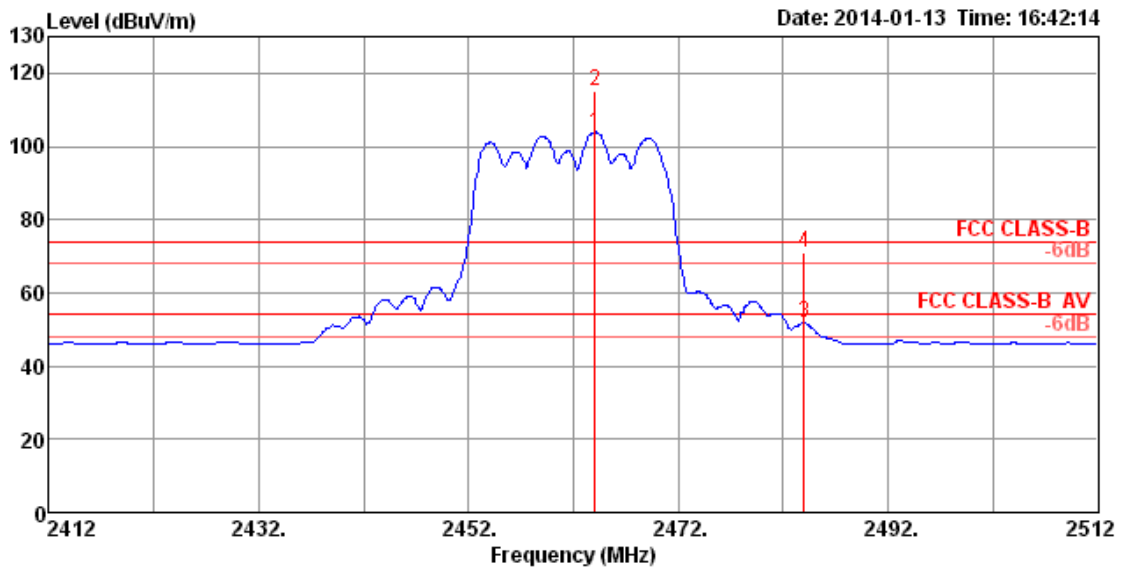

	Freq	Level	Limit	Over	Read	Cable	Antenna	Preamp	Remark	A/Pos	T/Pos	Pol/Phase
	MHz	dBuV/m	dBuV/m	dB	dBuV	dB	dB/m	dB		cm	deg	
1	2464.08	103.79			73.22	2.24	28.33	0.00	Average	178	177	VERTICAL
2	2464.08	115.06			84.49	2.24	28.33	0.00	Peak	178	177	VERTICAL
3	2483.98	51.82	54.00	-2.18	21.19	2.26	28.37	0.00	Average	178	177	VERTICAL
4	2483.98	70.84	74.00	-3.16	40.21	2.26	28.37	0.00	Peak	178	177	VERTICAL

Note 1: Item 1, 2 are the fundamental frequency at 2462 MHz
 Note 2: Emission level (dBuV/m) = 20 log Emission level (uV/m).
 Note 3: Corrected Reading: Antenna Factor + Cable Loss + Read Level - Preamp Factor = Level.
 Note 4: Measurement receive antenna polarization: H (Horizontal), V (Vertical)

Band Edge and Fundamental Emissions					
Operating Mode	IEEE 802.11n 20MHz MCS8 CH 1 / Ant. 1+2+3			Polarization	H
Temperature	24°C	Humidity	55%	Test Engineer	David Tseng

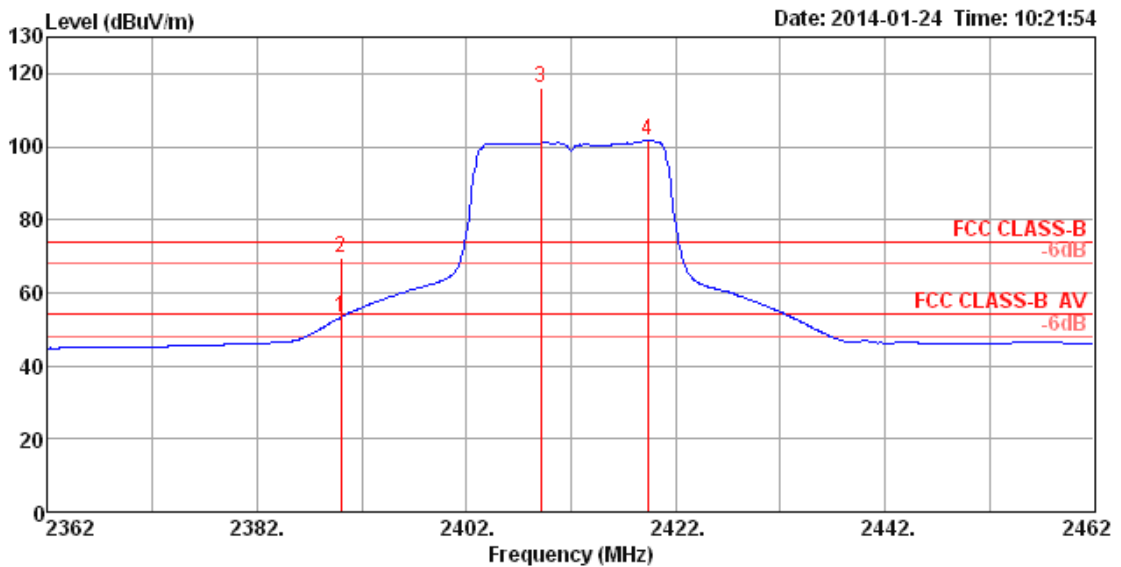

	Freq	Level	Limit	Over	Read	Cable	Antenna	Preamp	Remark	A/Pos	T/Pos	Pol/Phase
	MHz	dBuV/m	dBuV/m	dB	dBuV	dB	dB/m	dB		cm	deg	
1	2390.00	53.30	54.00	-0.70	22.91	2.22	28.17	0.00	Average	135	149	HORIZONTAL
2	2390.00	69.36	74.00	-4.64	38.97	2.22	28.17	0.00	Peak	135	149	HORIZONTAL
3	2409.12	116.17			85.74	2.22	28.21	0.00	Peak	135	149	HORIZONTAL
4	2419.37	101.57			71.09	2.23	28.25	0.00	Average	135	149	HORIZONTAL

Note 1: Item 3, 4 are the fundamental frequency at 2412 MHz
 Note 2: Emission level (dBuV/m) = 20 log Emission level (uV/m).
 Note 3: Corrected Reading: Antenna Factor + Cable Loss + Read Level - Preamp Factor = Level.
 Note 4: Measurement receive antenna polarization: H (Horizontal), V (Vertical)

Band Edge and Fundamental Emissions					
Operating Mode	IEEE 802.11n 20MHz MCS8 CH 1 / Ant. 1+2+3			Polarization	V
Temperature	24°C	Humidity	55%	Test Engineer	David Tseng

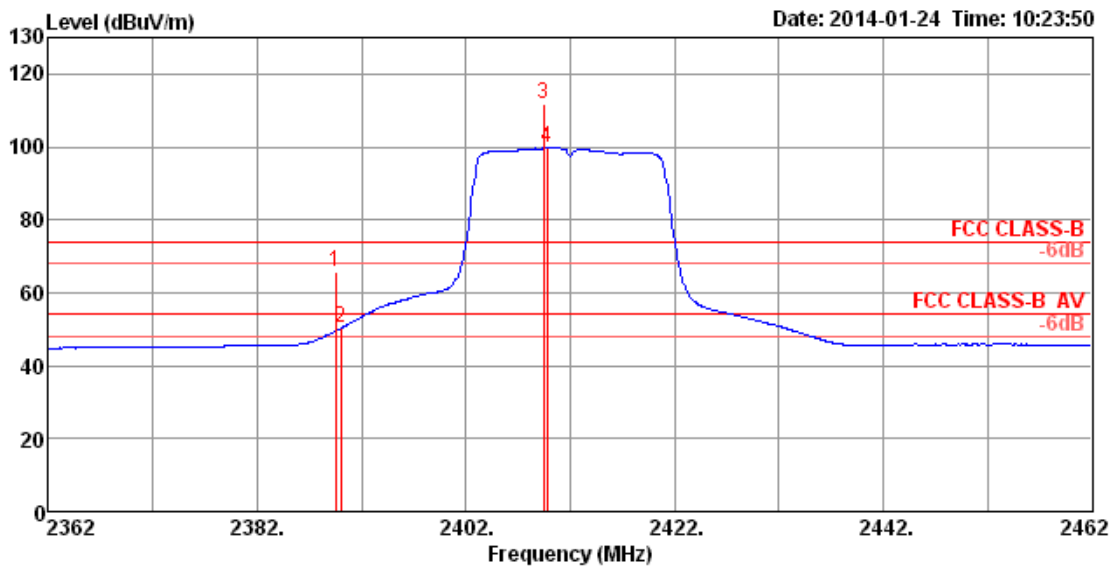

	Freq	Level	Limit	Over	Read	Cable	Antenna	Preamp	Remark	A/Pos	T/Pos	Pol/Phase
	MHz	dBuV/m	dBuV/m	dB	dBuV	dB	dB/m	dB		cm	deg	
1	2389.52	65.81	74.00	-8.19	35.43	2.21	28.17	0.00	Peak	100	361	VERTICAL
2	2390.00	50.24	54.00	-3.76	19.85	2.22	28.17	0.00	Average	100	361	VERTICAL
3	2409.44	111.69			81.26	2.22	28.21	0.00	Peak	100	361	VERTICAL
4	2409.76	99.68			69.25	2.22	28.21	0.00	Average	100	361	VERTICAL

Note 1: Item 3, 4 are the fundamental frequency at 2412 MHz
 Note 2: Emission level (dBuV/m) = 20 log Emission level (uV/m).
 Note 3: Corrected Reading: Antenna Factor + Cable Loss + Read Level - Preamp Factor = Level.
 Note 4: Measurement receive antenna polarization: H (Horizontal), V (Vertical)

Band Edge and Fundamental Emissions					
Operating Mode	IEEE 802.11n 20MHz MCS8 CH 6 / Ant. 1+2+3			Polarization	H
Temperature	24°C	Humidity	55%	Test Engineer	David Tseng

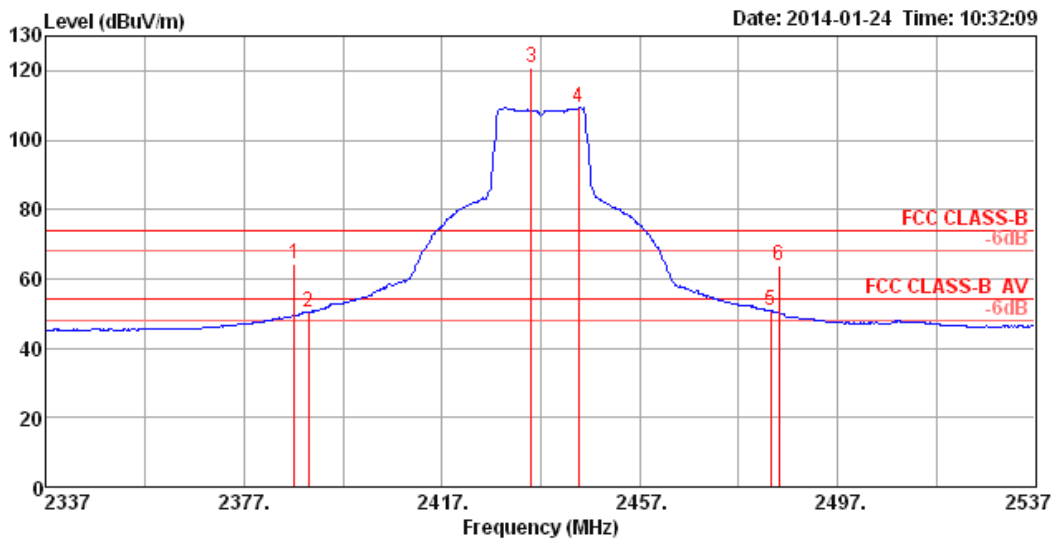

	Freq	Level	Limit	Over	Read	Cable	Antenna	Preamp	Remark	A/Pos	T/Pos	Pol/Phase
	MHz	dBuV/m	dBuV/m	dB	dBuV	dB	dB/m	dB		cm	deg	
1	2387.12	64.32	74.00	-9.68	33.94	2.21	28.17	0.00	Peak	112	158	HORIZONTAL
2	2390.00	50.37	54.00	-3.63	19.98	2.22	28.17	0.00	Average	112	158	HORIZONTAL
3	2435.08	121.05			90.53	2.23	28.29	0.00	Peak	112	158	HORIZONTAL
4	2444.69	109.17			78.64	2.24	28.29	0.00	Average	112	158	HORIZONTAL
5	2483.50	50.93	54.00	-3.07	20.29	2.26	28.38	0.00	Average	112	158	HORIZONTAL
6	2485.10	63.69	74.00	-10.31	33.01	2.26	28.42	0.00	Peak	112	158	HORIZONTAL

Note 1: Item 3, 4 are the fundamental frequency at 2437 MHz
 Note 2: Emission level (dBuV/m) = 20 log Emission level (uV/m).
 Note 3: Corrected Reading: Antenna Factor + Cable Loss + Read Level - Preamp Factor = Level.
 Note 4: Measurement receive antenna polarization: H (Horizontal), V (Vertical)

Band Edge and Fundamental Emissions					
Operating Mode	IEEE 802.11n 20MHz MCS8 CH 6 / Ant. 1+2+3			Polarization	V
Temperature	24°C	Humidity	55%	Test Engineer	David Tseng

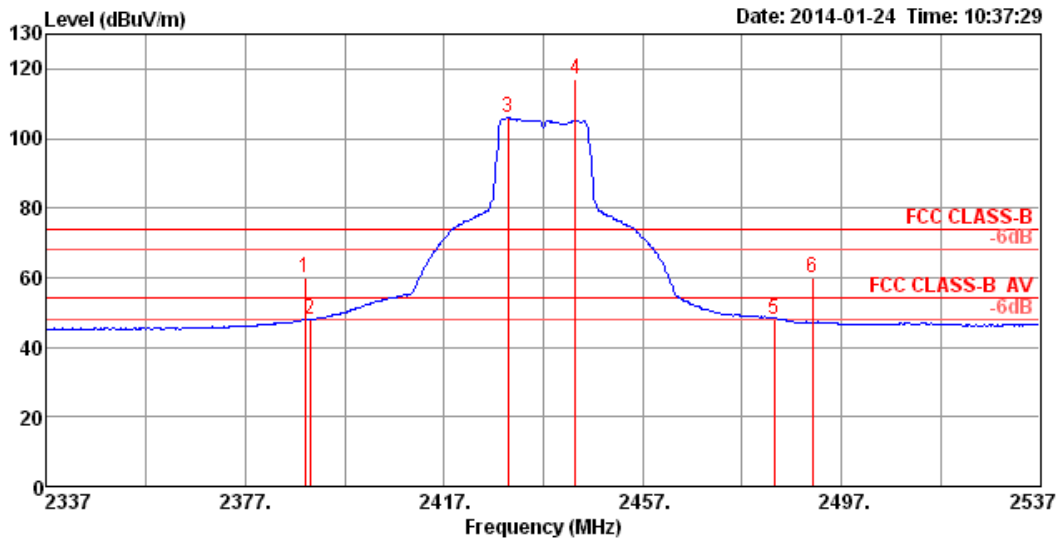

	Freq	Level	Limit Line	Over Limit	Read Level	Cable Loss	Antenna Factor	Preamp Factor	Remark	A/Pos	T/Pos	Pol/Phase
	MHz	dBuV/m	dBuV/m	dB	dBuV	dB	dB/m	dB		cm	deg	
1	2389.04	59.78	74.00	-14.22	29.40	2.21	28.17	0.00	Peak	155	159	VERTICAL
2	2390.00	48.10	54.00	-5.90	17.71	2.22	28.17	0.00	Average	155	159	VERTICAL
3	2429.95	105.86			75.38	2.23	28.25	0.00	Average	155	159	VERTICAL
4	2443.41	117.23			86.70	2.24	28.29	0.00	Peak	155	159	VERTICAL
5	2483.50	48.20	54.00	-5.80	17.57	2.26	28.37	0.00	Average	155	159	VERTICAL
6	2491.19	59.85	74.00	-14.15	29.18	2.26	28.41	0.00	Peak	155	159	VERTICAL

Note 1: Item 3, 4 are the fundamental frequency at 2437 MHz
 Note 2: Emission level (dBUV/m) = 20 log Emission level (uV/m).
 Note 3: Corrected Reading: Antenna Factor + Cable Loss + Read Level - Preamp Factor = Level.
 Note 4: Measurement receive antenna polarization: H (Horizontal), V (Vertical)

Band Edge and Fundamental Emissions					
Operating Mode	IEEE 802.11n 20MHz MCS8 CH 11 / Ant. 1+2+3			Polarization	H
Temperature	24°C	Humidity	55%	Test Engineer	David Tseng

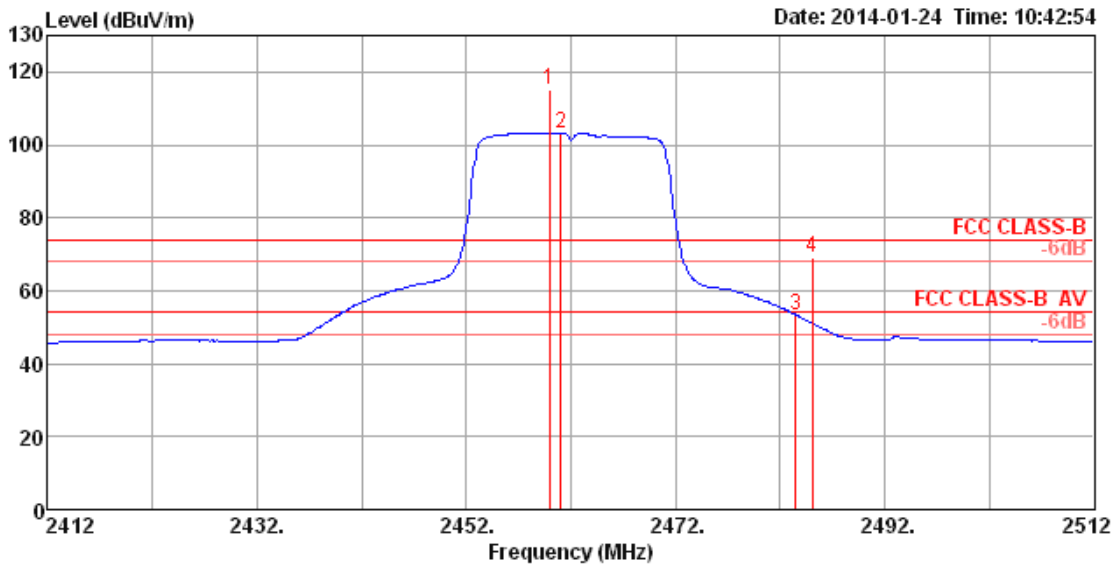

	Freq	Level	Limit	Over	Read	Cable	Antenna	Preamp	Remark	A/Pos	T/Pos	Pol/Phase
	MHz	dBuV/m	dBuV/m	dB	dBuV	dB	dB/m	dB		cm	deg	
1	2459.92	115.27			84.70	2.24	28.33	0.00	Peak	179	90	HORIZONTAL
2	2461.04	103.26			72.69	2.24	28.33	0.00	Average	179	90	HORIZONTAL
3	2483.50	53.40	54.00	-0.60	22.76	2.26	28.38	0.00	Average	179	90	HORIZONTAL
4	2485.10	68.85	74.00	-5.15	38.17	2.26	28.42	0.00	Peak	179	90	HORIZONTAL

Note 1: Item 1, 2 are the fundamental frequency at 2462 MHz
 Note 2: Emission level (dBUV/m) = 20 log Emission level (uV/m).
 Note 3: Corrected Reading: Antenna Factor + Cable Loss + Read Level - Preamp Factor = Level.
 Note 4: Measurement receive antenna polarization: H (Horizontal), V (Vertical)

Band Edge and Fundamental Emissions					
Operating Mode	IEEE 802.11n 20MHz MCS8 CH 11 / Ant. 1+2+3			Polarization	V
Temperature	24°C	Humidity	55%	Test Engineer	David Tseng

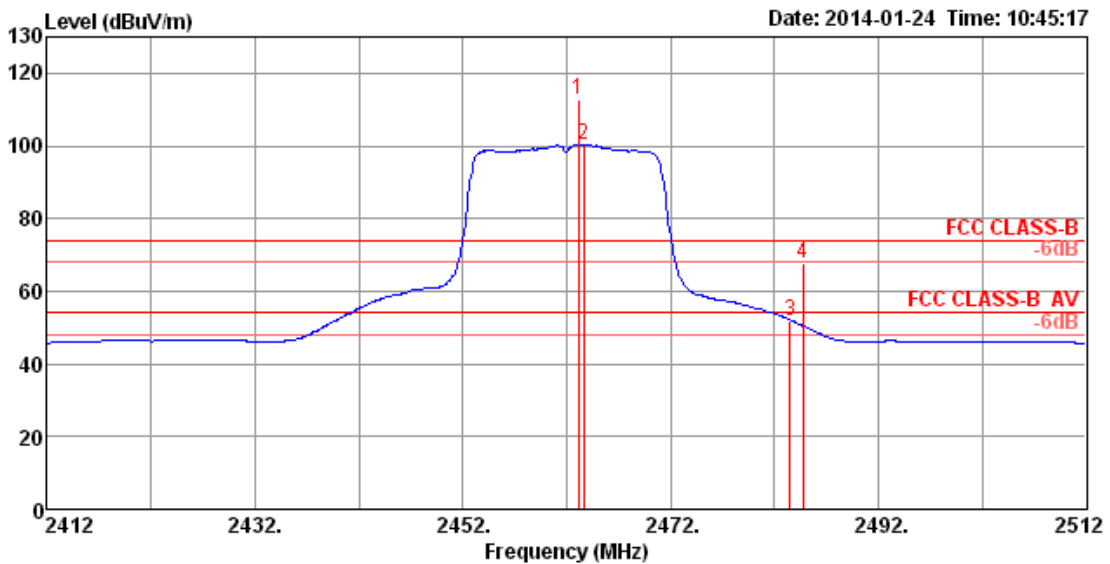

	Freq	Level	Limit	Over	Read	Cable	Antenna	Preamp	Remark	A/Pos	T/Pos	Pol/Phase
	MHz	dBuV/m	dBuV/m	dB	dBuV	dB	dB/m	dB		cm	deg	
1	2463.12	112.60			82.03	2.24	28.33	0.00	Peak	159	356	VERTICAL
2	2463.60	100.41			69.84	2.24	28.33	0.00	Average	159	356	VERTICAL
3	2483.50	51.99	54.00	-2.01	21.36	2.26	28.37	0.00	Average	159	356	VERTICAL
4	2484.78	67.49	74.00	-6.51	36.86	2.26	28.37	0.00	Peak	159	356	VERTICAL

Note 1: Item 1, 2 are the fundamental frequency at 2462 MHz
 Note 2: Emission level (dBuV/m) = 20 log Emission level (uV/m).
 Note 3: Corrected Reading: Antenna Factor + Cable Loss + Read Level - Preamp Factor = Level.
 Note 4: Measurement receive antenna polarization: H (Horizontal), V (Vertical)

Band Edge and Fundamental Emissions					
Operating Mode	IEEE 802.11n 40MHz MCS0 CH 3 / Ant. 3			Polarization	H
Temperature	24°C	Humidity	55%	Test Engineer	David Tseng

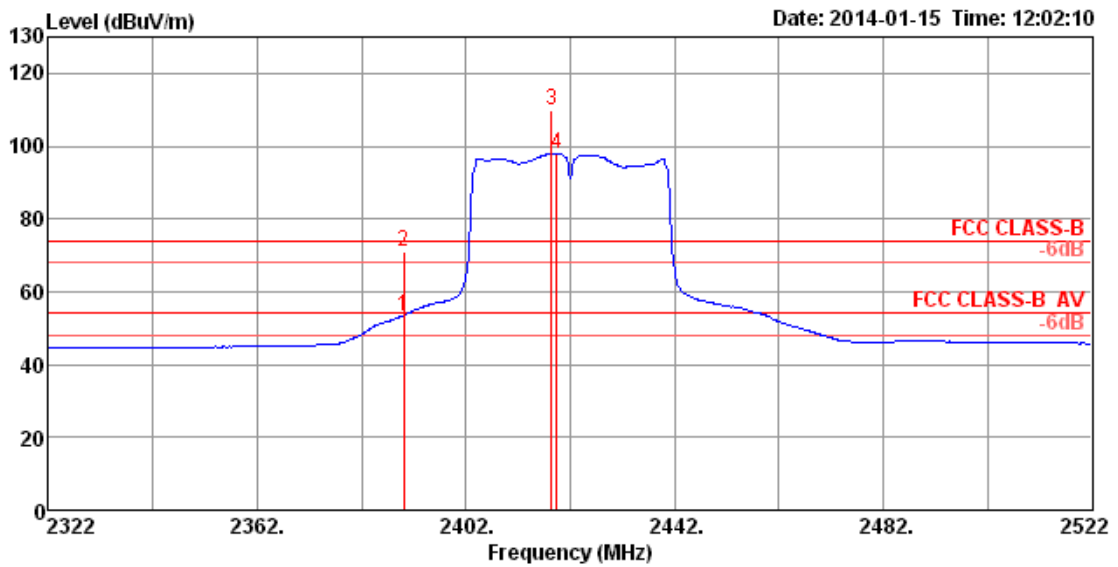

	Freq	Level	Limit	Over	Read	Cable	Antenna	Preamp	Remark	A/Pos	T/Pos	Pol/Phase
	MHz	dBuV/m	dBuV/m	dB	dBuV	dB	dB/m	dB		cm	deg	
1	2390.00	53.47	54.00	-0.53	23.08	2.22	28.17	0.00	Average	133	289	HORIZONTAL
2	2390.00	70.90	74.00	-3.10	40.51	2.22	28.17	0.00	Peak	133	289	HORIZONTAL
3	2418.47	109.94			79.46	2.23	28.25	0.00	Peak	133	289	HORIZONTAL
4	2419.44	97.99			67.51	2.23	28.25	0.00	Average	133	289	HORIZONTAL

Note 1: Item 3, 4 are the fundamental frequency at 2422 MHz
 Note 2: Emission level (dBuV/m) = 20 log Emission level (uV/m).
 Note 3: Corrected Reading: Antenna Factor + Cable Loss + Read Level - Preamp Factor = Level.
 Note 4: Measurement receive antenna polarization: H (Horizontal), V (Vertical)

Band Edge and Fundamental Emissions					
Operating Mode	IEEE 802.11n 40MHz MCS0 CH 3 / Ant. 3			Polarization	V
Temperature	24°C	Humidity	55%	Test Engineer	David Tseng

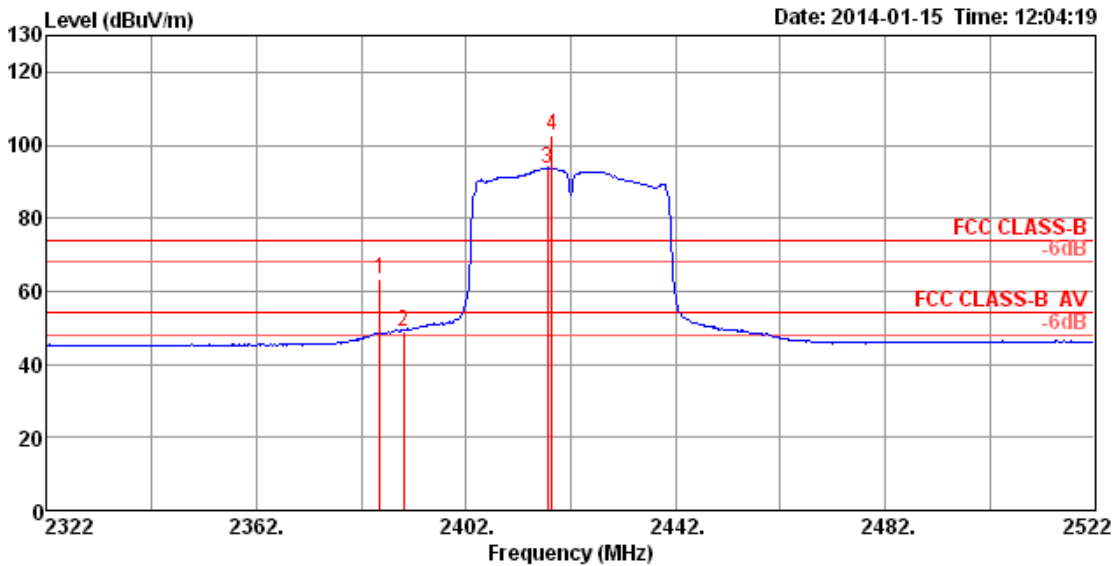

	Freq	Level	Limit	Over	Read	Cable	Antenna	Preamp	Remark	A/Pos	T/Pos	Pol/Phase
	MHz	dBuV/m	dBuV/m	dB	dBuV	dB	dB/m	dB		cm	deg	
1	2385.51	63.11	74.00	-10.89	32.73	2.21	28.17	0.00	Peak	139	171	VERTICAL
2	2390.00	49.16	54.00	-4.84	18.77	2.22	28.17	0.00	Average	139	171	VERTICAL
3	2417.51	93.67			63.19	2.23	28.25	0.00	Average	139	171	VERTICAL
4	2418.47	102.52			72.04	2.23	28.25	0.00	Peak	139	171	VERTICAL

Note 1: Item 3, 4 are the fundamental frequency at 2422 MHz
 Note 2: Emission level (dBuV/m) = 20 log Emission level (uV/m).
 Note 3: Corrected Reading: Antenna Factor + Cable Loss + Read Level - Preamp Factor = Level.
 Note 4: Measurement receive antenna polarization: H (Horizontal), V (Vertical)

Band Edge and Fundamental Emissions					
Operating Mode	IEEE 802.11n 40MHz MCS0 CH 6 / Ant. 3			Polarization	H
Temperature	24°C	Humidity	55%	Test Engineer	David Tseng

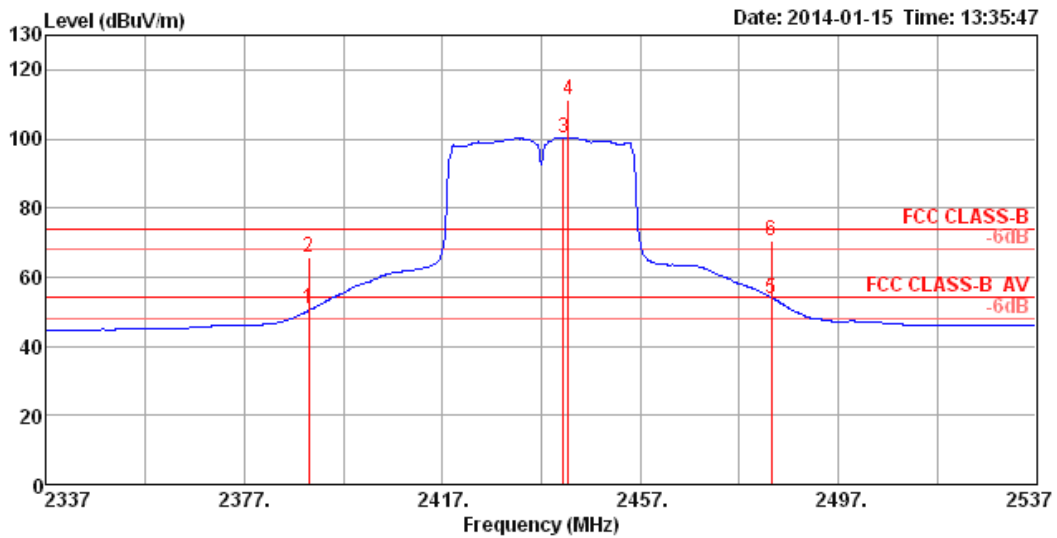

	Freq	Level	Limit Line	Over Limit	Read Level	Cable Loss	Antenna Factor	Preamp Factor	Remark	A/Pos	T/Pos	Pol/Phase
	MHz	dBuV/m	dBuV/m	dB	dBuV	dB	dB/m	dB		cm	deg	
1	2390.00	50.72	54.00	-3.28	20.33	2.22	28.17	0.00	Average	110	78	HORIZONTAL
2	2390.00	65.83	74.00	-8.17	35.44	2.22	28.17	0.00	Peak	110	78	HORIZONTAL
3	2441.49	100.43			69.90	2.24	28.29	0.00	Average	110	78	HORIZONTAL
4	2442.45	111.34			80.81	2.24	28.29	0.00	Peak	110	78	HORIZONTAL
5	2483.50	53.94	54.00	-0.06	23.30	2.26	28.38	0.00	Average	110	78	HORIZONTAL
6	2483.50	70.34	74.00	-3.66	39.70	2.26	28.38	0.00	Peak	110	78	HORIZONTAL

Note 1: Item 3, 4 are the fundamental frequency at 2437 MHz
 Note 2: Emission level (dBuV/m) = 20 log Emission level (uV/m).
 Note 3: Corrected Reading: Antenna Factor + Cable Loss + Read Level - Preamp Factor = Level.
 Note 4: Measurement receive antenna polarization: H (Horizontal), V (Vertical)

Band Edge and Fundamental Emissions					
Operating Mode	IEEE 802.11n 40MHz MCS0 CH 6 / Ant. 3			Polarization	V
Temperature	24°C	Humidity	55%	Test Engineer	David Tseng

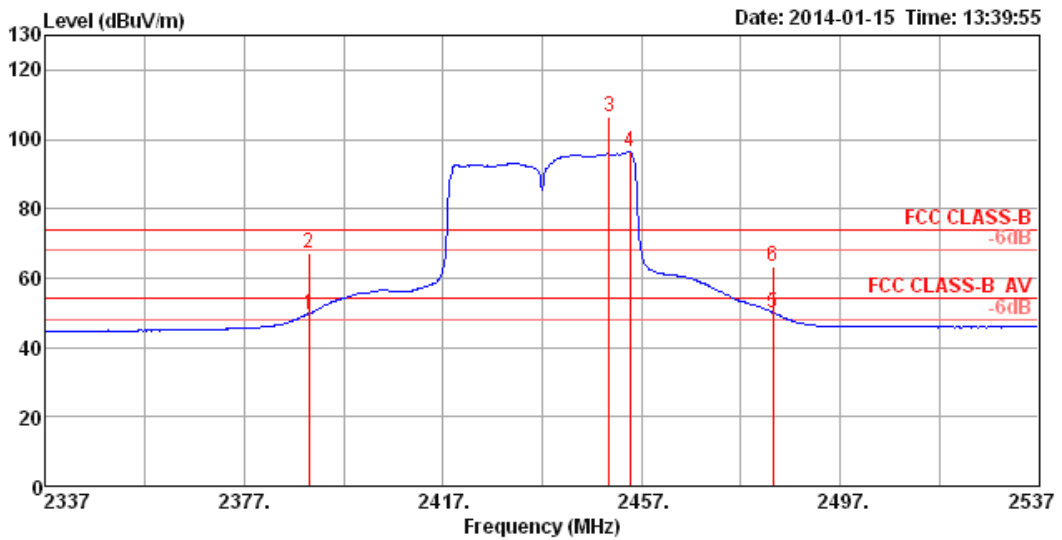

	Freq	Level	Limit Line	Over Limit	Read Level	Cable Loss	Antenna Factor	Preamp Factor	Remark	A/Pos	T/Pos	Pol/Phase
	MHz	dBUV/m	dBUV/m	dB	dBuV	dB	dB/m	dB		cm	deg	
1	2390.00	49.64	54.00	-4.36	19.25	2.22	28.17	0.00	Average	139	353	VERTICAL
2	2390.00	67.37	74.00	-6.63	36.98	2.22	28.17	0.00	Peak	139	353	VERTICAL
3	2450.46	106.55			76.02	2.24	28.29	0.00	Peak	139	353	VERTICAL
4	2454.63	96.37			65.80	2.24	28.33	0.00	Average	139	353	VERTICAL
5	2483.50	50.04	54.00	-3.96	19.41	2.26	28.37	0.00	Average	139	353	VERTICAL
6	2483.50	63.13	74.00	-10.87	32.50	2.26	28.37	0.00	Peak	139	353	VERTICAL

Note 1: Item 3, 4 are the fundamental frequency at 2437 MHz
 Note 2: Emission level (dBUV/m) = 20 log Emission level (uV/m).
 Note 3: Corrected Reading: Antenna Factor + Cable Loss + Read Level - Preamp Factor = Level.
 Note 4: Measurement receive antenna polarization: H (Horizontal), V (Vertical)

Band Edge and Fundamental Emissions						
Operating Mode	IEEE 802.11n 40MHz MCS0 CH 9 / Ant. 3			Polarization	H	
Temperature	24°C	Humidity	55%	Test Engineer	David Tseng	

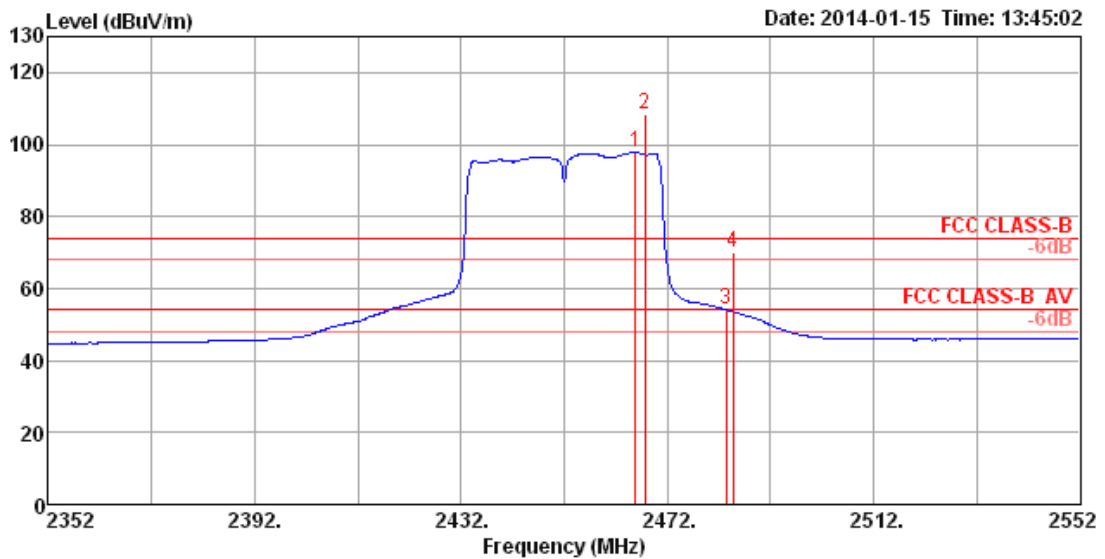

	Freq	Level	Limit	Over	Read	Cable	Antenna	Preamp	Remark	A/Pos	T/Pos	Pol/Phase
	MHz	dBUV/m	dBUV/m	dB	dBuV	dB	dB/m	dB		cm	deg	
1	2465.78	97.79			67.22	2.24	28.33	0.00	Average	109	68	HORIZONTAL
2	2467.71	108.24			77.65	2.26	28.33	0.00	Peak	109	68	HORIZONTAL
3	2483.50	53.99	54.00	-0.01	23.35	2.26	28.38	0.00	Average	109	68	HORIZONTAL
4	2484.78	70.04	74.00	-3.96	39.40	2.26	28.38	0.00	Peak	109	68	HORIZONTAL

Note 1: Item 1, 2 are the fundamental frequency at 2452 MHz
 Note 2: Emission level (dBUV/m) = 20 log Emission level (uV/m).
 Note 3: Corrected Reading: Antenna Factor + Cable Loss + Read Level - Preamp Factor = Level.
 Note 4: Measurement receive antenna polarization: H (Horizontal), V (Vertical)

Band Edge and Fundamental Emissions					
Operating Mode	IEEE 802.11n 40MHz MCS0 CH 9 / Ant. 3			Polarization	V
Temperature	24°C	Humidity	55%	Test Engineer	David Tseng

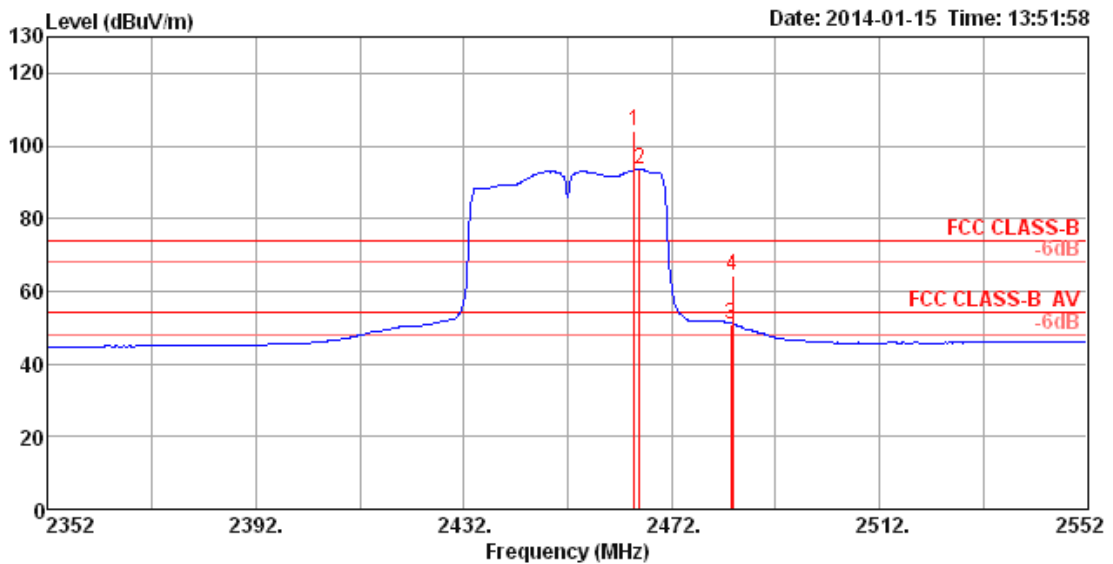

	Freq	Level	Limit Line	Over Limit	Read Level	Cable Loss	Antenna Factor	Preamp Factor	Remark	A/Pos	T/Pos	Pol/Phase
	MHz	dBuV/m	dBuV/m	dB	dBuV	dB	dB/m	dB		cm	deg	
1	2464.82	104.04			73.47	2.24	28.33	0.00	Peak	113	341	VERTICAL
2	2465.78	93.55			62.98	2.24	28.33	0.00	Average	113	341	VERTICAL
3	2483.50	51.07	54.00	-2.93	20.44	2.26	28.37	0.00	Average	113	341	VERTICAL
4	2483.82	64.37	74.00	-9.63	33.74	2.26	28.37	0.00	Peak	113	341	VERTICAL

Note 1: Item 1, 2 are the fundamental frequency at 2452 MHz
 Note 2: Emission level (dBuV/m) = 20 log Emission level (uV/m).
 Note 3: Corrected Reading: Antenna Factor + Cable Loss + Read Level - Preamp Factor = Level.
 Note 4: Measurement receive antenna polarization: H (Horizontal), V (Vertical)

Band Edge and Fundamental Emissions						
Operating Mode	IEEE 802.11n 40MHz MCS0 CH 3 / Ant. 1+2+3			Polarization	H	
Temperature	24°C	Humidity	55%	Test Engineer	David Tseng	

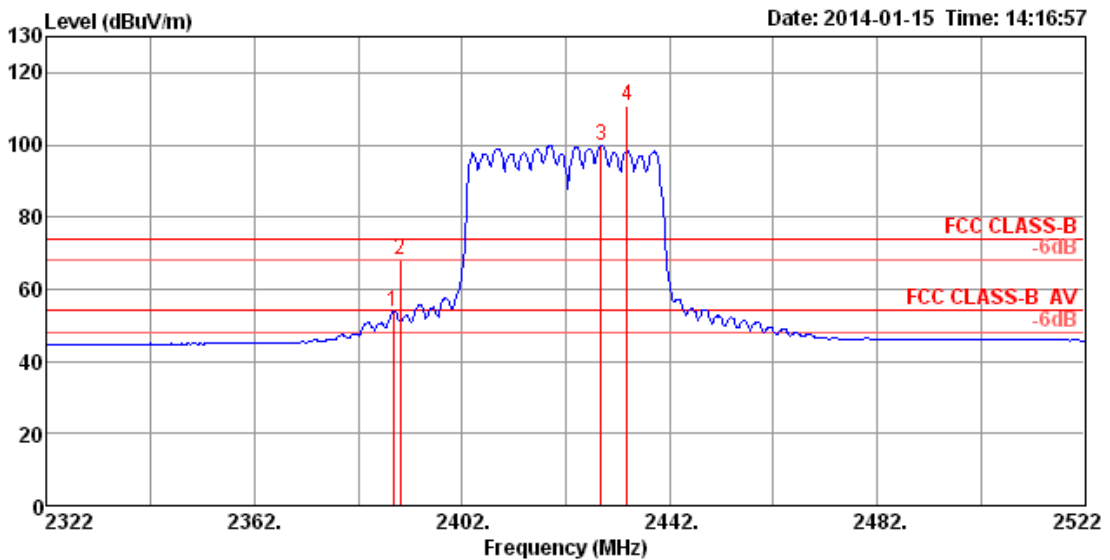

	Freq	Level	Limit Line	Over Limit	Read Level	Cable Loss	Antenna Factor	Preamp Factor	Remark	A/Pos	T/Pos	Pol/Phase
	MHz	dBuV/m	dBuV/m	dB	dBuV	dB	dB/m	dB		cm	deg	
1	2388.72	53.64	54.00	-0.36	23.26	2.21	28.17	0.00	Average	113	155	HORIZONTAL
2	2390.00	68.11	74.00	-5.89	37.72	2.22	28.17	0.00	Peak	113	155	HORIZONTAL
3	2428.73	99.95			69.47	2.23	28.25	0.00	Average	113	155	HORIZONTAL
4	2433.86	110.94			80.46	2.23	28.25	0.00	Peak	113	155	HORIZONTAL

Note 1: Item 3, 4 are the fundamental frequency at 2422 MHz
 Note 2: Emission level (dBuV/m) = 20 log Emission level (uV/m).
 Note 3: Corrected Reading: Antenna Factor + Cable Loss + Read Level - Preamp Factor = Level.
 Note 4: Measurement receive antenna polarization: H (Horizontal), V (Vertical)

Band Edge and Fundamental Emissions					
Operating Mode	IEEE 802.11n 40MHz MCS0 CH 3 / Ant. 1+2+3			Polarization	V
Temperature	24°C	Humidity	55%	Test Engineer	David Tseng

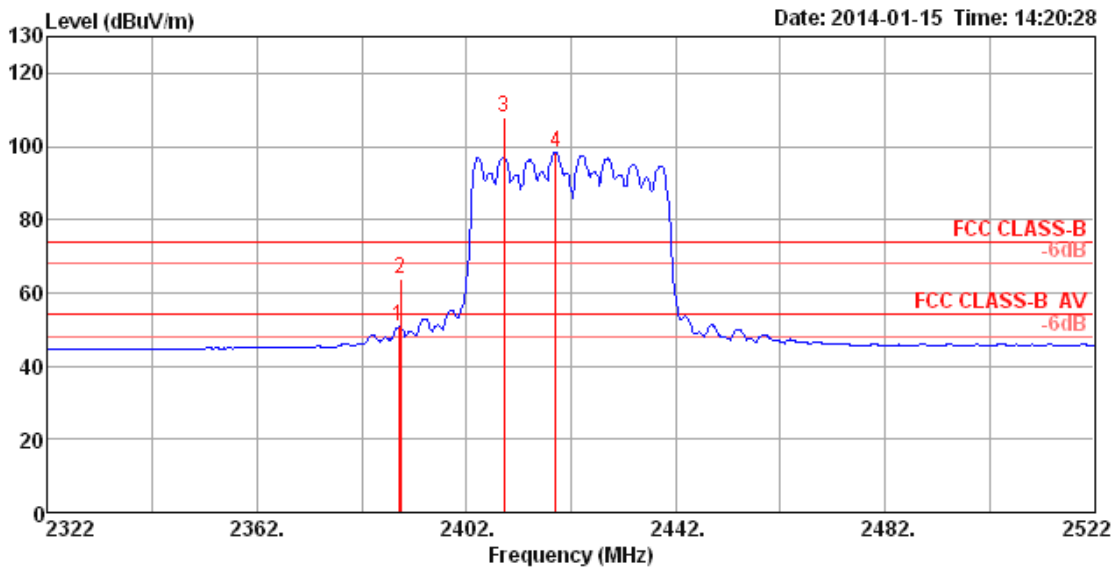

	Freq	Level	Limit	Over	Read	Cable	Antenna	Preamp	Remark	A/Pos	T/Pos	Pol/Phase
	MHz	dBuV/m	dBuV/m	dB	dBuV	dB	dB/m	dB		cm	deg	
1	2389.04	50.67	54.00	-3.33	20.29	2.21	28.17	0.00	Average	144	194	VERTICAL
2	2389.36	63.88	74.00	-10.12	33.50	2.21	28.17	0.00	Peak	144	194	VERTICAL
3	2409.18	108.12			77.69	2.22	28.21	0.00	Peak	144	194	VERTICAL
4	2419.12	98.35			67.87	2.23	28.25	0.00	Average	144	194	VERTICAL

Note 1: Item 3, 4 are the fundamental frequency at 2422 MHz
 Note 2: Emission level (dBuV/m) = 20 log Emission level (uV/m).
 Note 3: Corrected Reading: Antenna Factor + Cable Loss + Read Level - Preamp Factor = Level.
 Note 4: Measurement receive antenna polarization: H (Horizontal), V (Vertical)

Band Edge and Fundamental Emissions						
Operating Mode	IEEE 802.11n 40MHz MCS0 CH 6 / Ant. 1+2+3			Polarization	H	
Temperature	24°C	Humidity	55%	Test Engineer	David Tseng	

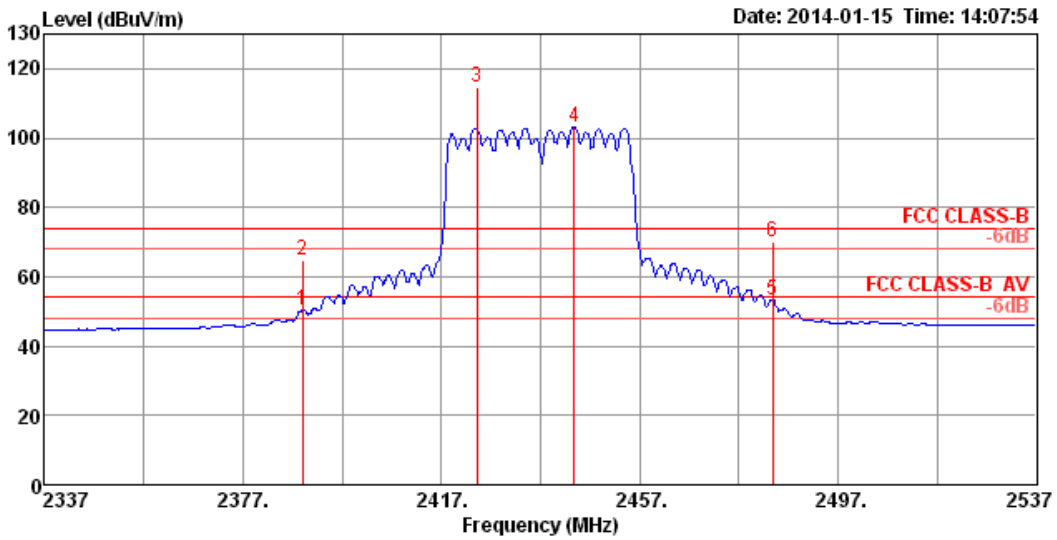

	Freq	Level	Limit Line	Over Limit	Read Level	Cable Loss	Antenna Factor	Preamp Factor	Remark	A/Pos	T/Pos	Pol/Phase
	MHz	dBuV/m	dBuV/m	dB	dBuV	dB	dB/m	dB		cm	deg	
1	2389.04	50.48	54.00	-3.52	20.10	2.21	28.17	0.00	Average	108	157	HORIZONTAL
2	2389.04	64.55	74.00	-9.45	34.17	2.21	28.17	0.00	Peak	108	157	HORIZONTAL
3	2424.18	114.47			83.99	2.23	28.25	0.00	Peak	108	157	HORIZONTAL
4	2443.73	103.25			72.72	2.24	28.29	0.00	Average	108	157	HORIZONTAL
5	2483.82	53.38	54.00	-0.62	22.74	2.26	28.38	0.00	Average	108	157	HORIZONTAL
6	2483.82	69.85	74.00	-4.15	39.21	2.26	28.38	0.00	Peak	108	157	HORIZONTAL

Note 1: Item 3, 4 are the fundamental frequency at 2437 MHz
 Note 2: Emission level (dBuV/m) = 20 log Emission level (uV/m).
 Note 3: Corrected Reading: Antenna Factor + Cable Loss + Read Level - Preamp Factor = Level.
 Note 4: Measurement receive antenna polarization: H (Horizontal), V (Vertical)

Band Edge and Fundamental Emissions					
Operating Mode	IEEE 802.11n 40MHz MCS0 CH 6 / Ant. 1+2+3			Polarization	V
Temperature	24°C	Humidity	55%	Test Engineer	David Tseng

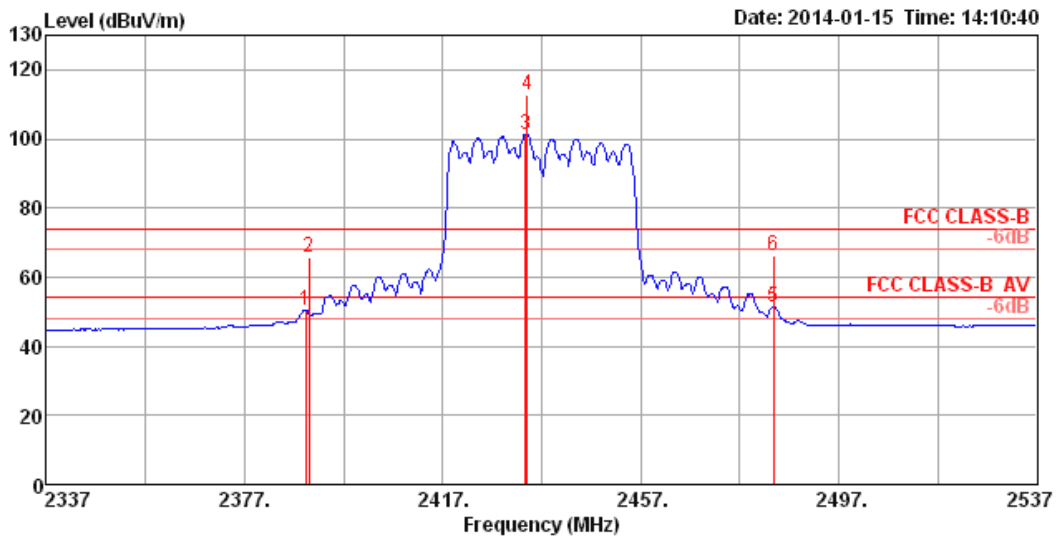

	Freq	Level	Limit Line	Over Limit	Read Level	Cable Loss	Antenna Factor	Preamp Factor	Remark	A/Pos	T/Pos	Pol/Phase
	MHz	dBuV/m	dBuV/m	dB	dBuV	dB	dB/m	dB		cm	deg	
1	2389.36	50.40	54.00	-3.60	20.02	2.21	28.17	0.00	Average	118	186	VERTICAL
2	2390.00	65.87	74.00	-8.13	35.48	2.22	28.17	0.00	Peak	118	186	VERTICAL
3	2433.80	101.30			70.82	2.23	28.25	0.00	Average	118	186	VERTICAL
4	2434.12	112.59			82.07	2.23	28.29	0.00	Peak	118	186	VERTICAL
5	2483.82	51.21	54.00	-2.79	20.58	2.26	28.37	0.00	Average	118	186	VERTICAL
6	2483.82	66.40	74.00	-7.60	35.77	2.26	28.37	0.00	Peak	118	186	VERTICAL

Note 1: Item 3, 4 are the fundamental frequency at 2437 MHz
 Note 2: Emission level (dBuV/m) = 20 log Emission level (uV/m).
 Note 3: Corrected Reading: Antenna Factor + Cable Loss + Read Level - Preamp Factor = Level.
 Note 4: Measurement receive antenna polarization: H (Horizontal), V (Vertical)

Band Edge and Fundamental Emissions					
Operating Mode	IEEE 802.11n 40MHz MCS0 CH 9 / Ant. 1+2+3			Polarization	H
Temperature	24°C	Humidity	55%	Test Engineer	David Tseng

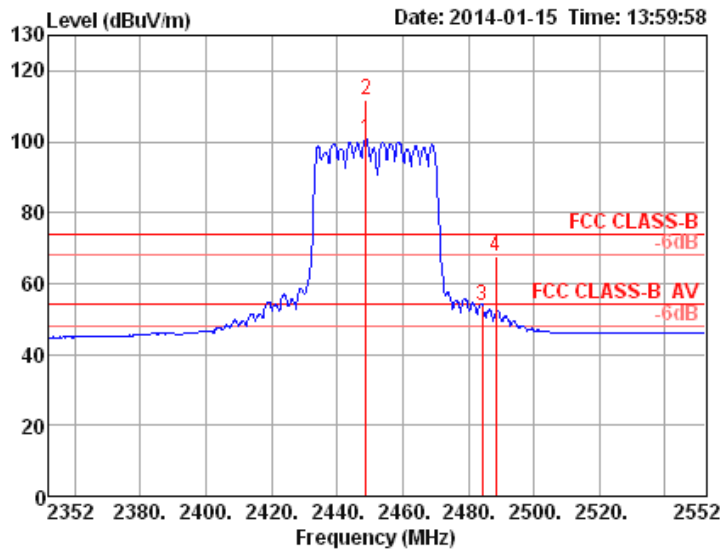

	Freq	Level	Limit	Over	Read	Cable	Antenna	Preamp	Remark	A/Pos	T/Pos	Pol/Phase
	MHz	dBuV/m	dBuV/m	dB	dBuV	dB	dB/m	dB		cm	deg	
1	2448.80	100.73			70.20	2.24	28.29	0.00	Average	109	158	HORIZONTAL
2	2448.80	111.97			109.73	2.24	0.00	0.00	Peak	109	158	HORIZONTAL
3	2484.14	53.94	54.00	-0.06	23.30	2.26	28.38	0.00	Average	109	158	HORIZONTAL
4	2488.31	67.69	74.00	-6.31	65.43	2.26	0.00	0.00	Peak	109	158	HORIZONTAL

Note 1: Item 1, 2 are the fundamental frequency at 2452 MHz
 Note 2: Emission level (dBuV/m) = 20 log Emission level (uV/m).
 Note 3: Corrected Reading: Antenna Factor + Cable Loss + Read Level - Preamp Factor = Level.
 Note 4: Measurement receive antenna polarization: H (Horizontal), V (Vertical)

Band Edge and Fundamental Emissions					
Operating Mode	IEEE 802.11n 40MHz MCS0 CH 9 / Ant. 1+2+3			Polarization	V
Temperature	24°C	Humidity	55%	Test Engineer	David Tseng

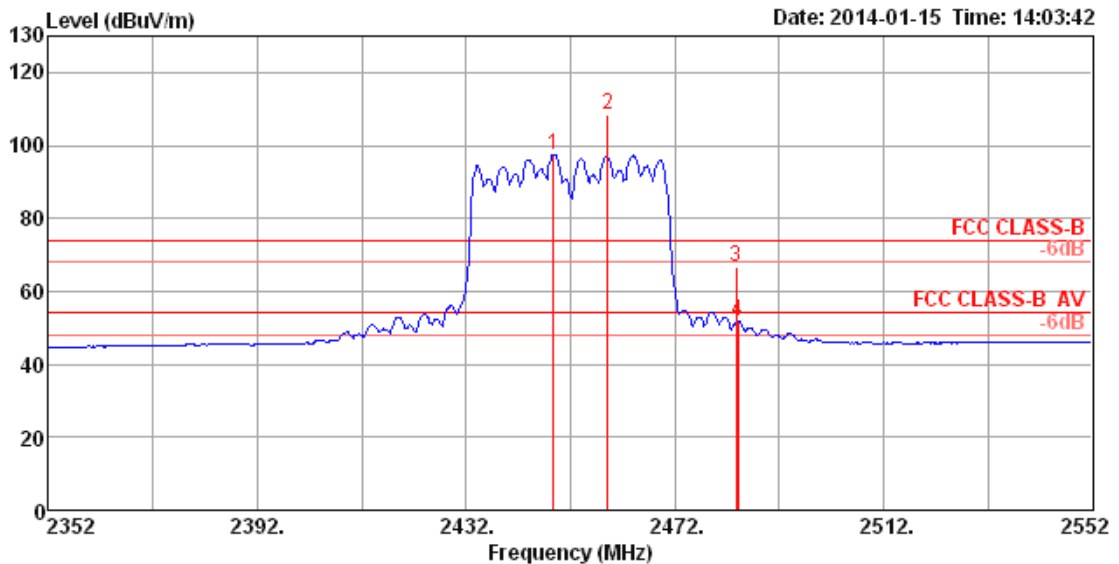

	Freq	Level	Limit	Over	Read	Cable	Antenna	Preamp	Remark	A/Pos	T/Pos	Pol/Phase
	MHz	dBuV/m	dBuV/m	dB	dBuV	dB	dB/m	dB		cm	deg	
1	2448.80	97.47			66.94	2.24	28.29	0.00	Average	179	181	VERTICAL
2	2459.05	108.22			77.65	2.24	28.33	0.00	Peak	179	181	VERTICAL
3	2483.82	66.62	74.00	-7.38	35.99	2.26	28.37	0.00	Peak	179	181	VERTICAL
4	2484.14	51.95	54.00	-2.05	21.32	2.26	28.37	0.00	Average	179	181	VERTICAL

Note 1: Item 1, 2 are the fundamental frequency at 2452 MHz
 Note 2: Emission level (dBuV/m) = 20 log Emission level (uV/m).
 Note 3: Corrected Reading: Antenna Factor + Cable Loss + Read Level - Preamp Factor = Level.
 Note 4: Measurement receive antenna polarization: H (Horizontal), V (Vertical)

Band Edge and Fundamental Emissions					
Operating Mode	IEEE 802.11n 40MHz MCS8 CH 3 / Ant. 1+2+3			Polarization	H
Temperature	24°C	Humidity	55%	Test Engineer	David Tseng

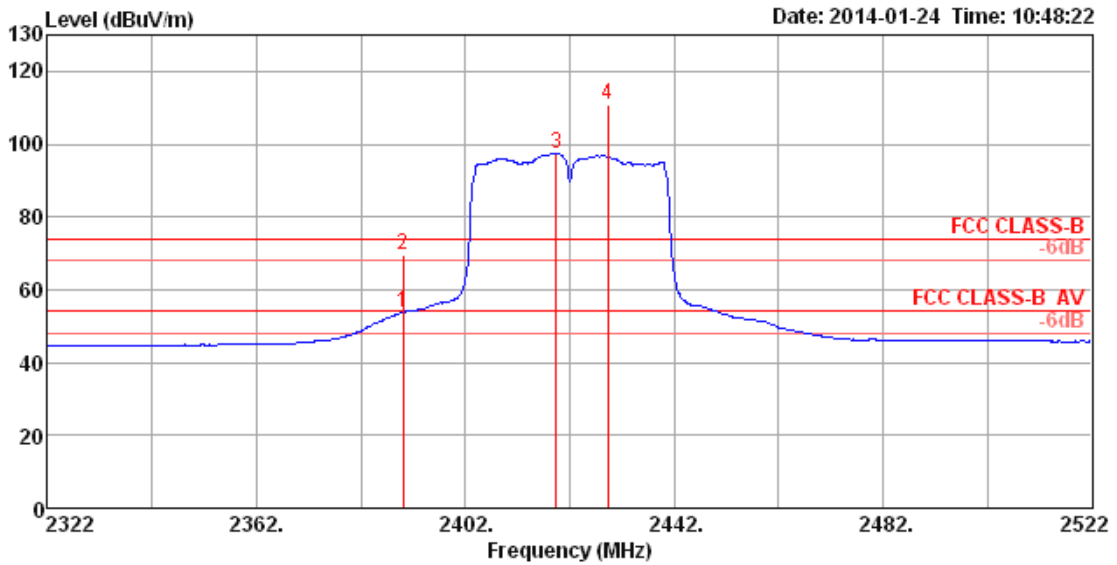

	Freq	Level	Limit	Over	Read	Cable	Antenna	Preamp	Remark	A/Pos	T/Pos	Pol/Phase
	MHz	dBuV/m	dBuV/m	dB	dBuV	dB	dB/m	dB		cm	deg	
1	2390.00	53.59	54.00	-0.41	23.20	2.22	28.17	0.00	Average	112	153	HORIZONTAL
2	2390.00	69.76	74.00	-4.24	39.37	2.22	28.17	0.00	Peak	112	153	HORIZONTAL
3	2419.44	97.34			66.86	2.23	28.25	0.00	Average	112	153	HORIZONTAL
4	2429.37	110.97			80.49	2.23	28.25	0.00	Peak	112	153	HORIZONTAL

Note 1: Item 3, 4 are the fundamental frequency at 2422 MHz
 Note 2: Emission level (dBuV/m) = 20 log Emission level (uV/m).
 Note 3: Corrected Reading: Antenna Factor + Cable Loss + Read Level - Preamp Factor = Level.
 Note 4: Measurement receive antenna polarization: H (Horizontal), V (Vertical)

Band Edge and Fundamental Emissions					
Operating Mode	IEEE 802.11n 40MHz MCS8 CH 3 / Ant. 1+2+3			Polarization	V
Temperature	24°C	Humidity	55%	Test Engineer	David Tseng

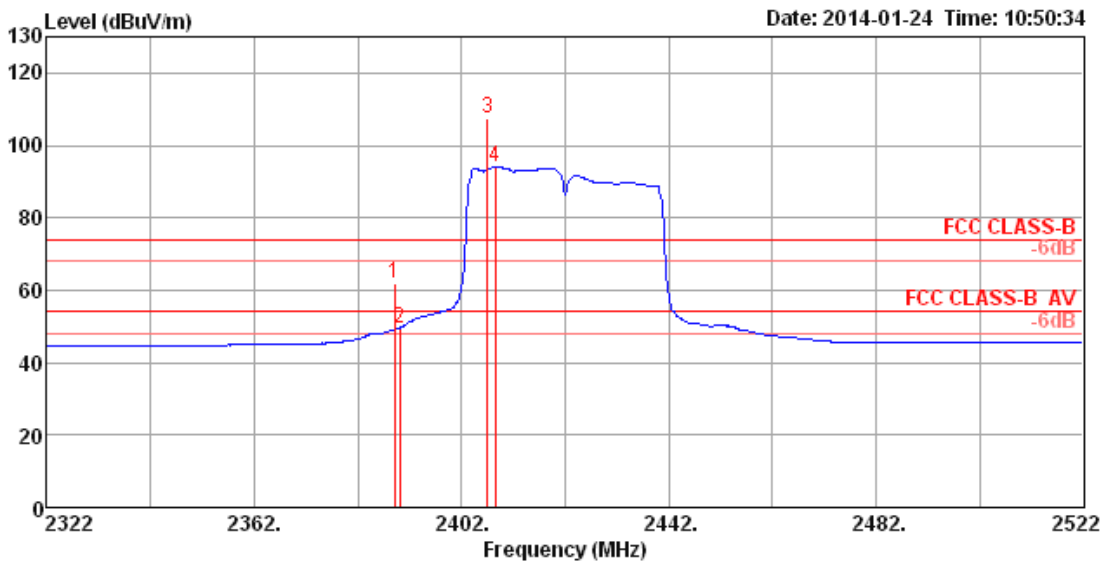

	Freq	Level	Limit	Over	Read	Cable	Antenna	Preamp	Remark	A/Pos	T/Pos	Pol/Phase
	MHz	dBuV/m	dBuV/m	dB	dBuV	dB	dB/m	dB		cm	deg	
1	2389.04	61.75	74.00	-12.25	31.37	2.21	28.17	0.00	Peak	100	361	VERTICAL
2	2390.00	49.52	54.00	-4.48	19.13	2.22	28.17	0.00	Average	100	361	VERTICAL
3	2406.94	107.45			77.02	2.22	28.21	0.00	Peak	100	361	VERTICAL
4	2408.54	94.20			63.77	2.22	28.21	0.00	Average	100	361	VERTICAL

Note 1: Item 3, 4 are the fundamental frequency at 2422 MHz
 Note 2: Emission level (dBuV/m) = 20 log Emission level (uV/m).
 Note 3: Corrected Reading: Antenna Factor + Cable Loss + Read Level - Preamp Factor = Level.
 Note 4: Measurement receive antenna polarization: H (Horizontal), V (Vertical)

Band Edge and Fundamental Emissions					
Operating Mode	IEEE 802.11n 40MHz MCS8 CH 6 / Ant. 1+2+3			Polarization	H
Temperature	24°C	Humidity	55%	Test Engineer	David Tseng

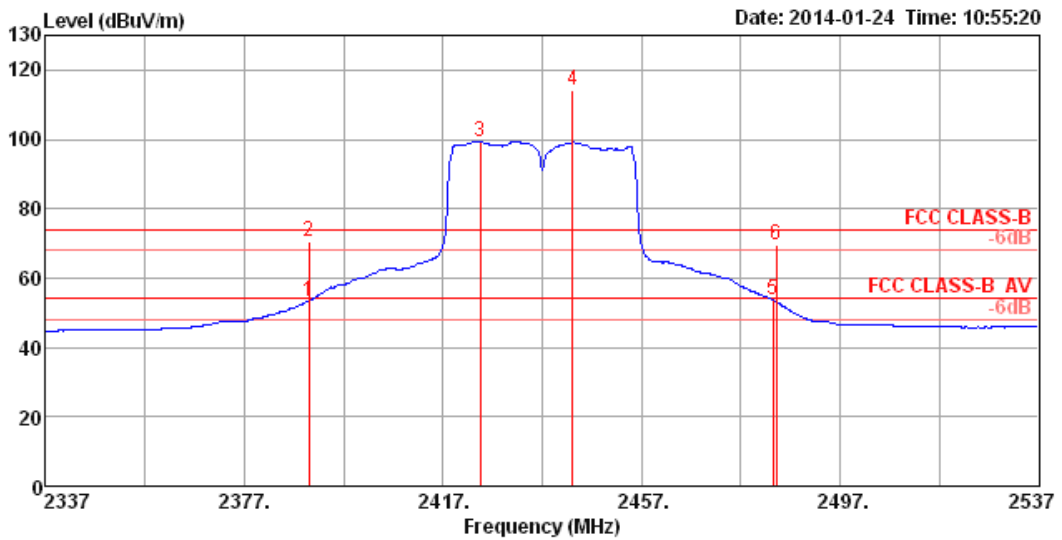

	Freq	Level	Limit Line	Over Limit	Read Level	Cable Loss	Antenna Factor	Preamp Factor	Remark	A/Pos	T/Pos	Pol/Phase
	MHz	dBUV/m	dBUV/m	dB	dBuV	dB	dB/m	dB		cm	deg	
1	2390.00	53.44	54.00	-0.56	23.05	2.22	28.17	0.00	Average	114	147	HORIZONTAL
2	2390.00	70.59	74.00	-3.41	40.20	2.22	28.17	0.00	Peak	114	147	HORIZONTAL
3	2424.50	99.39			68.91	2.23	28.25	0.00	Average	114	147	HORIZONTAL
4	2443.09	114.07			83.54	2.24	28.29	0.00	Peak	114	147	HORIZONTAL
5	2483.50	53.58	54.00	-0.42	22.94	2.26	28.38	0.00	Average	114	147	HORIZONTAL
6	2484.14	69.69	74.00	-4.31	39.05	2.26	28.38	0.00	Peak	114	147	HORIZONTAL

Note 1: Item 3, 4 are the fundamental frequency at 2437 MHz
 Note 2: Emission level (dBUV/m) = 20 log Emission level (uV/m).
 Note 3: Corrected Reading: Antenna Factor + Cable Loss + Read Level - Preamp Factor = Level.
 Note 4: Measurement receive antenna polarization: H (Horizontal), V (Vertical)

Band Edge and Fundamental Emissions					
Operating Mode	IEEE 802.11n 40MHz MCS8 CH 6 / Ant. 1+2+3			Polarization	V
Temperature	24°C	Humidity	55%	Test Engineer	David Tseng

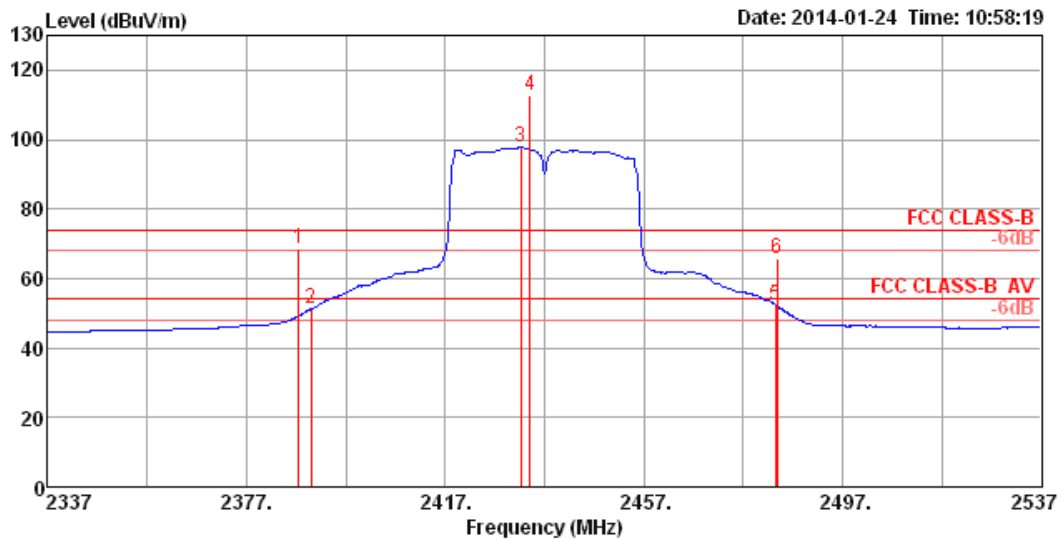

	Freq	Level	Limit Line	Over Limit	Read Level	Cable Loss	Antenna Factor	Preamp Factor	Remark	A/Pos	T/Pos	Pol/Phase
	MHz	dBuV/m	dBuV/m	dB	dBuV	dB	dB/m	dB		cm	deg	
1	2387.44	68.46	74.00	-5.54	38.08	2.21	28.17	0.00	Peak	116	357	VERTICAL
2	2390.00	51.09	54.00	-2.91	20.70	2.22	28.17	0.00	Average	116	357	VERTICAL
3	2432.19	97.74			67.26	2.23	28.25	0.00	Average	116	357	VERTICAL
4	2434.12	112.57			82.05	2.23	28.29	0.00	Peak	116	357	VERTICAL
5	2483.50	52.07	54.00	-1.93	21.44	2.26	28.37	0.00	Average	116	357	VERTICAL
6	2483.82	65.82	74.00	-8.18	35.19	2.26	28.37	0.00	Peak	116	357	VERTICAL

Note 1: Item 3, 4 are the fundamental frequency at 2437 MHz
 Note 2: Emission level (dBuV/m) = 20 log Emission level (uV/m).
 Note 3: Corrected Reading: Antenna Factor + Cable Loss + Read Level - Preamp Factor = Level.
 Note 4: Measurement receive antenna polarization: H (Horizontal), V (Vertical)

Band Edge and Fundamental Emissions					
Operating Mode	IEEE 802.11n 40MHz MCS8 CH 9 / Ant. 1+2+3			Polarization	H
Temperature	24°C	Humidity	55%	Test Engineer	David Tseng

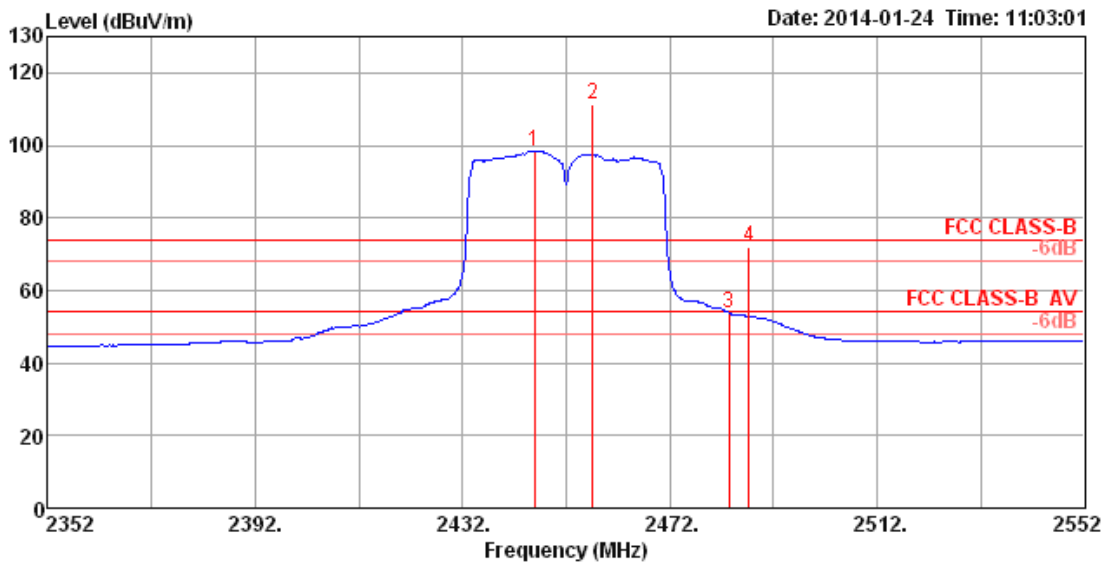

	Freq	Level	Limit	Over	Read	Cable	Antenna	Preamp	Remark	A/Pos	T/Pos	Pol/Phase
	MHz	dBuV/m	dBuV/m	dB	dBuV	dB	dB/m	dB		cm	deg	
1	2445.91	98.53			68.00	2.24	28.29	0.00	Average	182	82	HORIZONTAL
2	2457.13	111.23			80.66	2.24	28.33	0.00	Peak	182	82	HORIZONTAL
3	2483.50	53.76	54.00	-0.24	23.12	2.26	28.38	0.00	Average	182	82	HORIZONTAL
4	2487.35	71.79	74.00	-2.21	41.11	2.26	28.42	0.00	Peak	182	82	HORIZONTAL

Note 1: Item 1, 2 are the fundamental frequency at 2452 MHz
 Note 2: Emission level (dBuV/m) = 20 log Emission level (uV/m).
 Note 3: Corrected Reading: Antenna Factor + Cable Loss + Read Level - Preamp Factor = Level.
 Note 4: Measurement receive antenna polarization: H (Horizontal), V (Vertical)

Band Edge and Fundamental Emissions					
Operating Mode	IEEE 802.11n 40MHz MCS8 CH 9 / Ant. 1+2+3			Polarization	V
Temperature	24°C	Humidity	55%	Test Engineer	David Tseng

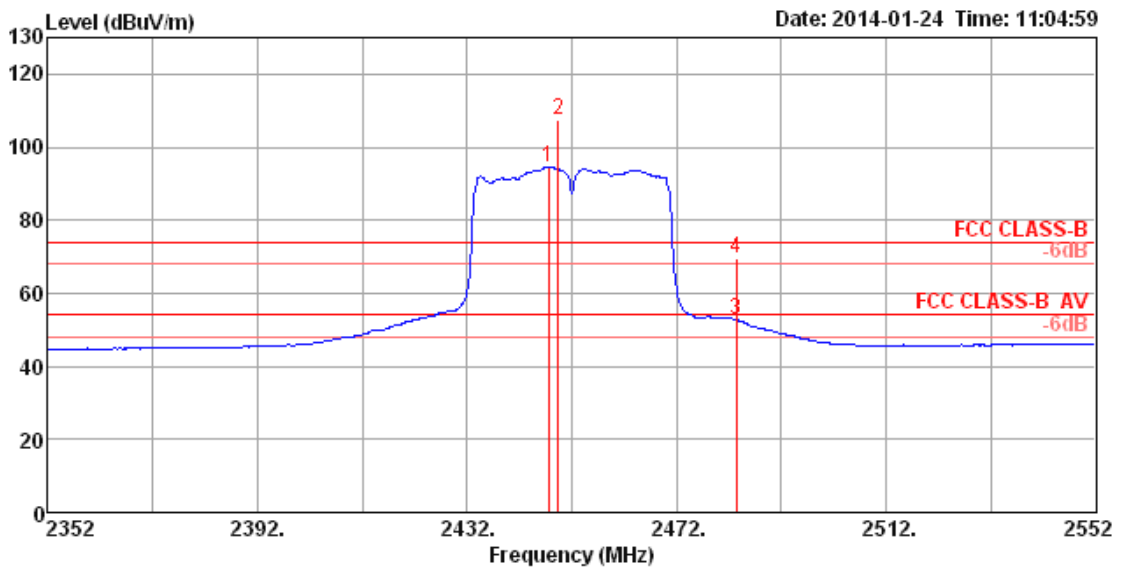

	Freq	Level	Limit	Over	Read	Cable	Antenna	Preamp	Remark	A/Pos	T/Pos	Pol/Phase
	MHz	dBuV/m	dBuV/m	dB	dBuV	dB	dB/m	dB		cm	deg	
1	2447.51	94.56			64.03	2.24	28.29	0.00	Average	109	359	VERTICAL
2	2449.44	107.37			76.84	2.24	28.29	0.00	Peak	109	359	VERTICAL
3	2483.50	52.79	54.00	-1.21	22.16	2.26	28.37	0.00	Average	109	359	VERTICAL
4	2483.50	69.47	74.00	-4.53	38.84	2.26	28.37	0.00	Peak	109	359	VERTICAL

Note 1: Item 1, 2 are the fundamental frequency at 2452 MHz
 Note 2: Emission level (dBuV/m) = 20 log Emission level (uV/m).
 Note 3: Corrected Reading: Antenna Factor + Cable Loss + Read Level - Preamp Factor = Level.
 Note 4: Measurement receive antenna polarization: H (Horizontal), V (Vertical)

3.6.8. Results of Emission not in Restricted Band

Following channel(s) was (were) selected for the final test as listed below.

MODE	TX Chain	TESTED CHANNEL	MODULATION TECHNOLOGY	MODULATION TYPE	DATA RATE (Mbps)
802.11b	Ant.1	1, 6, 11	DSSS	DBPSK	1
802.11b	Ant.1+2+3, CDD	1, 6, 11	DSSS	DBPSK	1
802.11g	Ant.1	1, 6, 11	OFDM	BPSK	6
802.11g	Ant.1+2+3, CDD	1, 6, 11	OFDM	BPSK	6
802.11n 20MHz	Ant.1	1, 6, 11	OFDM	BPSK	MCS0 (6.5)
802.11n 20MHz	Ant.1+2+3, CDD	1, 6, 11	OFDM	BPSK	MCS0 (6.5)
802.11n 20MHz	Ant.1+2+3, CDD	1, 6, 11	OFDM	BPSK	MCS8 (13)
802.11n 40MHz	Ant.3	3, 6, 9	OFDM	BPSK	MCS0 (13)
802.11n 40MHz	Ant.1+2+3, CDD	3, 6, 9	OFDM	BPSK	MCS0 (13)
802.11n 40MHz	Ant.1+2+3, CDD	3, 6, 9	OFDM	BPSK	MCS8 (27)

Low Band Edge Plot on Configuration IEEE 802.11b / Reference Level / Ant. 1

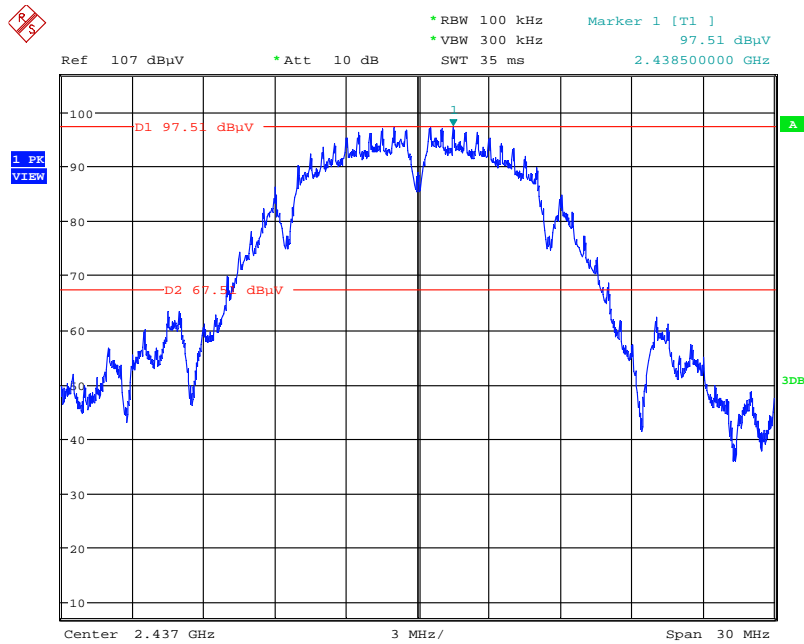

Date: 21.JAN.2014 11:13:29

Low Band Edge Plot on Configuration IEEE 802.11b / CH 1 / Ant. 1

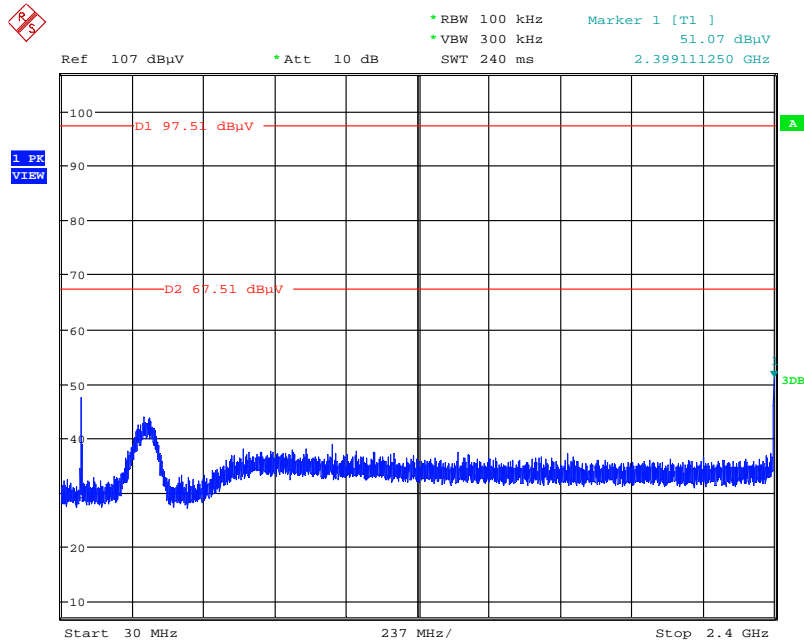

Date: 21.JAN.2014 11:14:12

Low Band Edge Plot on Configuration IEEE 802.11b / CH 1 / Ant. 1

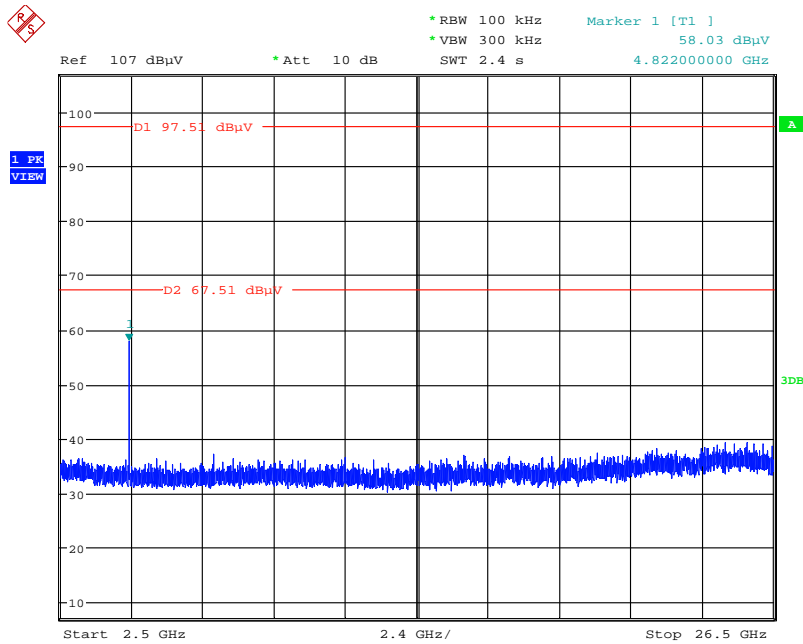

Date: 21.JAN.2014 11:14:36

Low Band Edge Plot on Configuration IEEE 802.11b / CH 6 / Ant. 1

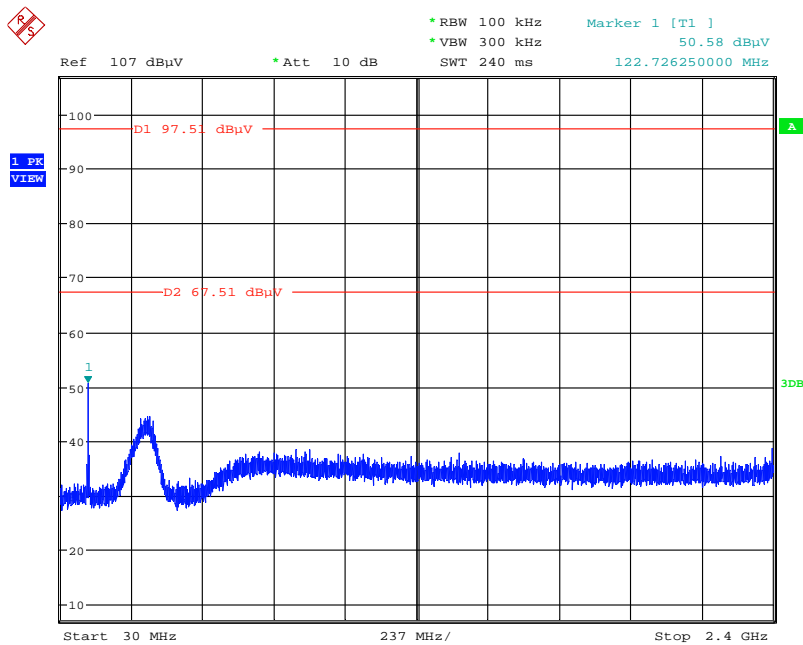

Date: 29.JAN.2014 17:53:49

Low Band Edge Plot on Configuration IEEE 802.11b / CH 6 / Ant. 1

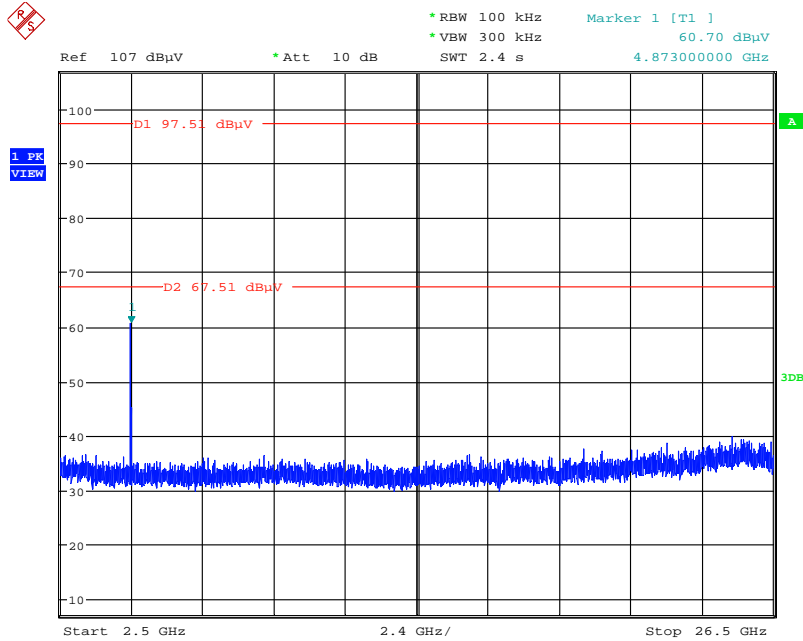

Date: 29.JAN.2014 17:54:25

Low Band Edge Plot on Configuration IEEE 802.11b / CH 11 / Ant. 1

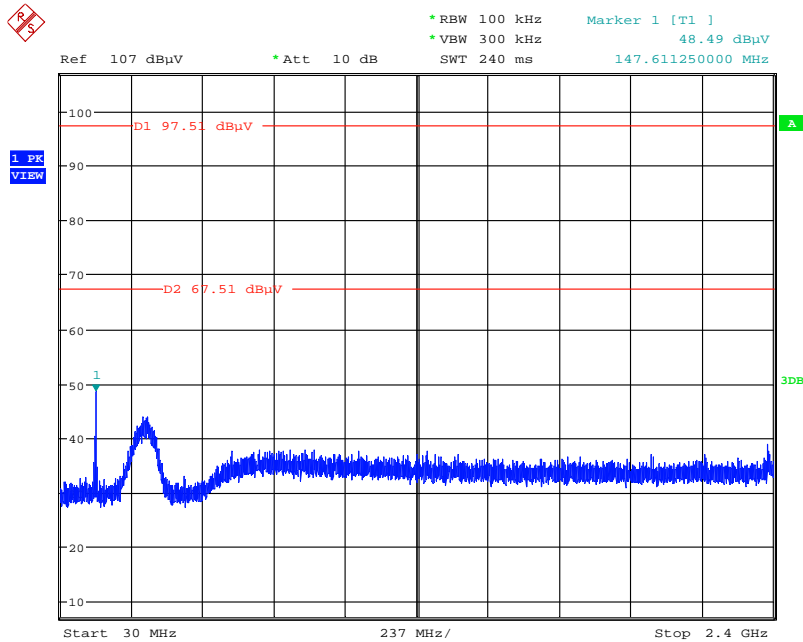

Date: 21.JAN.2014 11:15:36

Low Band Edge Plot on Configuration IEEE 802.11b / CH 11 / Ant. 1

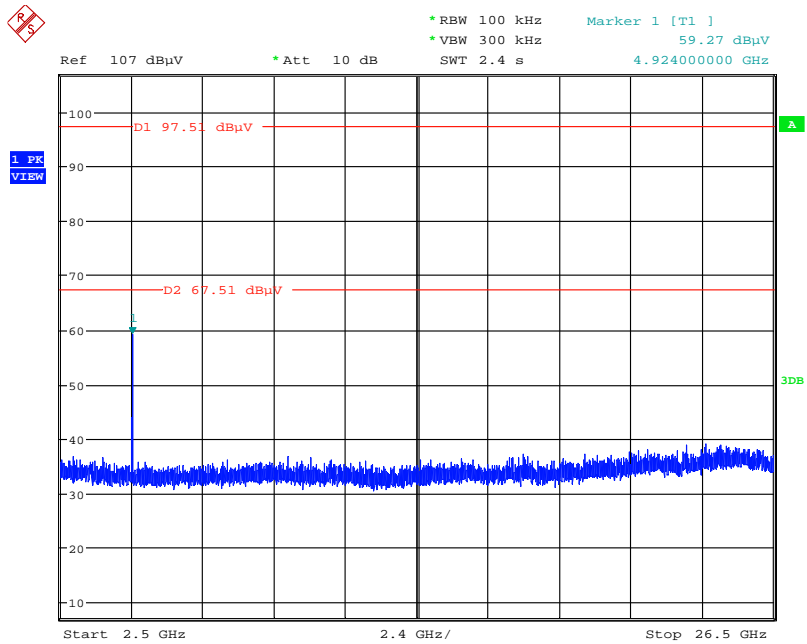

Date: 21.JAN.2014 11:15:18

Low Band Edge Plot on Configuration IEEE 802.11b / Reference Level / Ant. 1+2+3

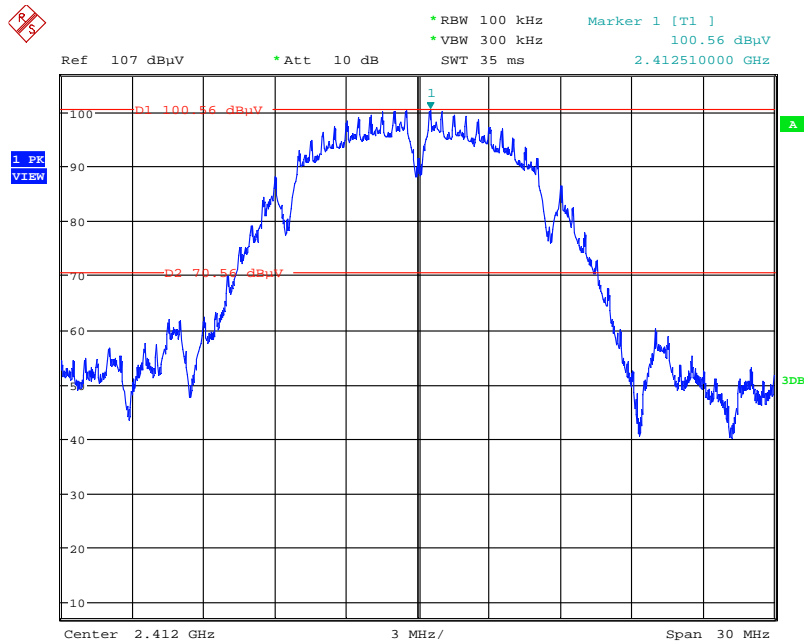

Date: 29.JAN.2014 17:44:34

Low Band Edge Plot on Configuration IEEE 802.11b / CH 1 / Ant. 1+2+3

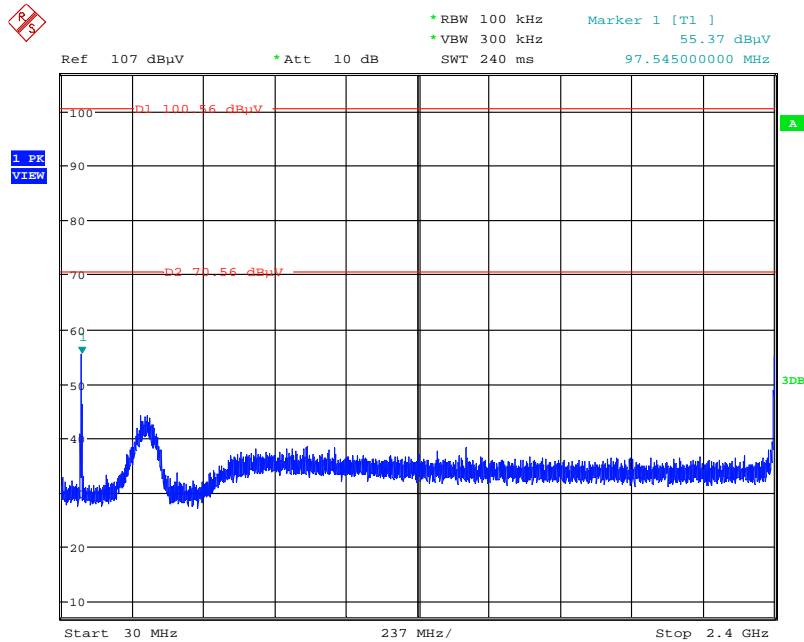

Date: 29.JAN.2014 17:45:03

Low Band Edge Plot on Configuration IEEE 802.11b / CH 1 / Ant. 1+2+3

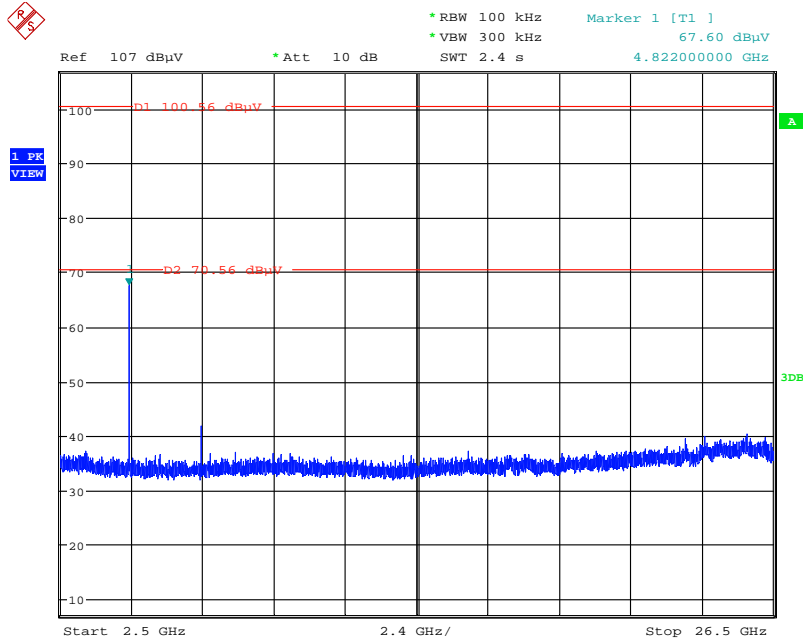

Date: 29.JAN.2014 17:46:10

Low Band Edge Plot on Configuration IEEE 802.11b / CH 6 / Ant. 1+2+3

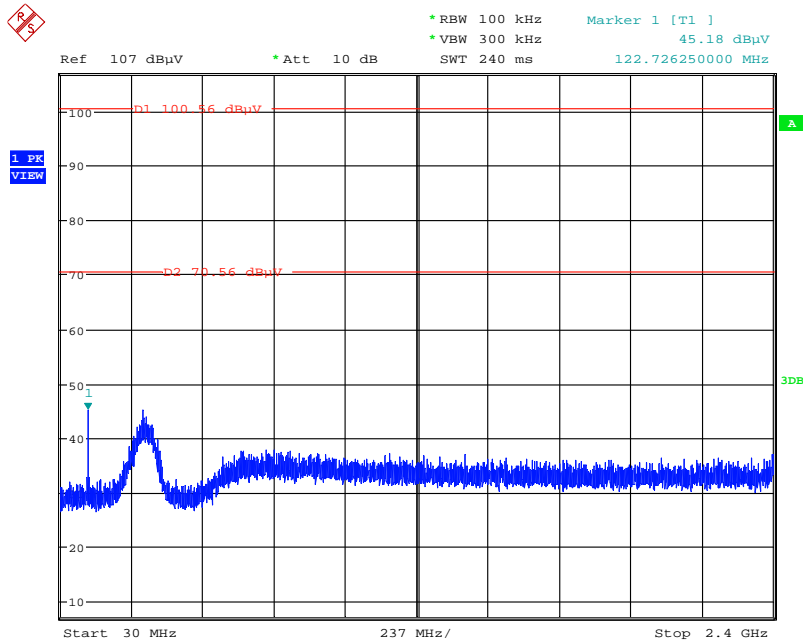

Date: 29.JAN.2014 17:48:21

Low Band Edge Plot on Configuration IEEE 802.11b / CH 6 / Ant. 1+2+3

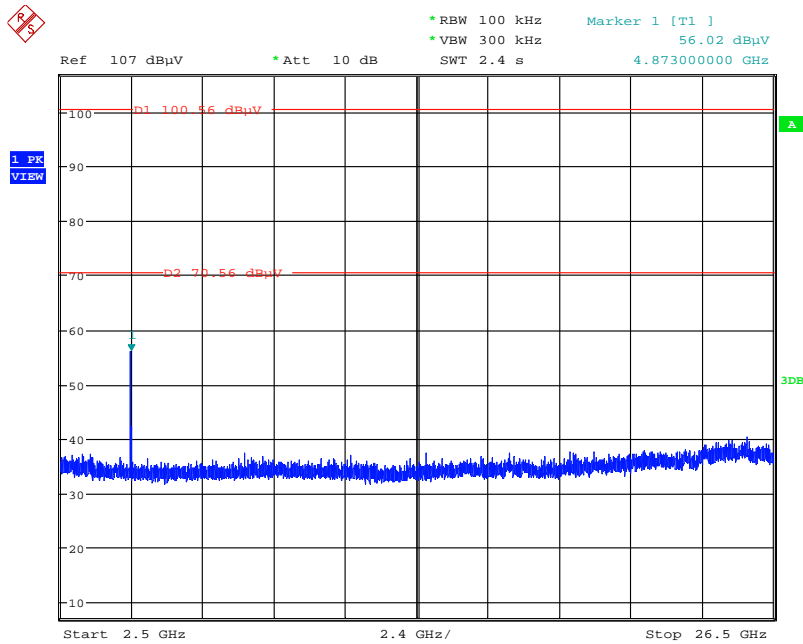

Date: 29.JAN.2014 17:47:58

Low Band Edge Plot on Configuration IEEE 802.11b / CH 11 / Ant. 1+2+3

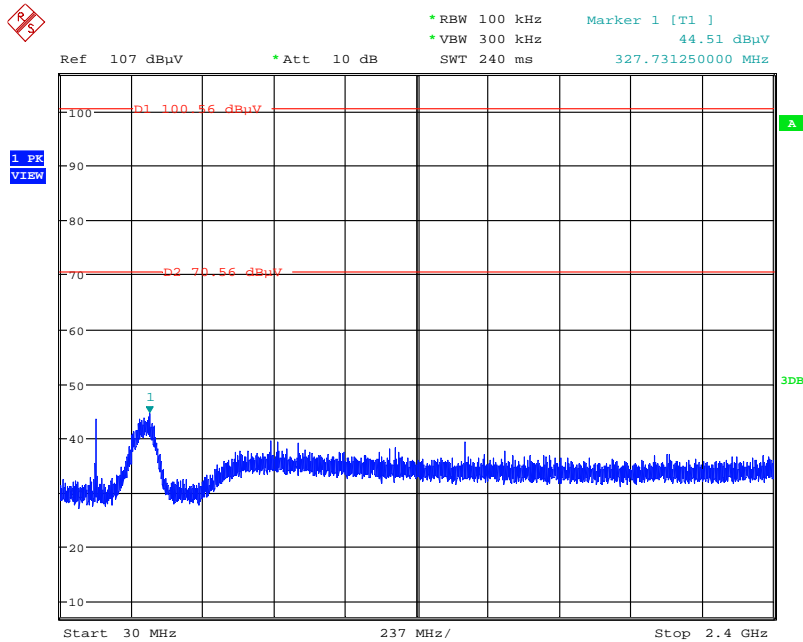

Date: 29.JAN.2014 17:49:11

Low Band Edge Plot on Configuration IEEE 802.11b / CH 11 / Ant. 1+2+3

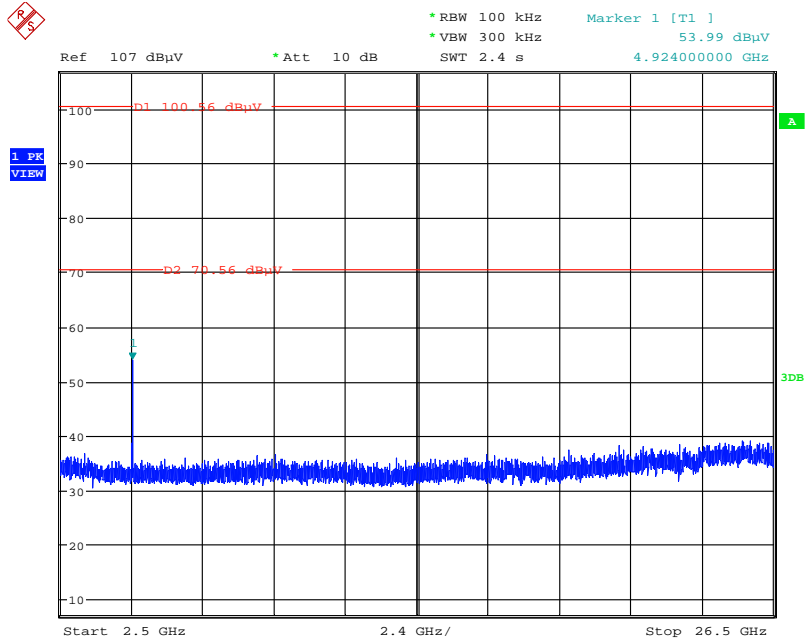

Date: 29.JAN.2014 17:49:36

Low Band Edge Plot on Configuration IEEE 802.11g / Reference Level / Ant. 1

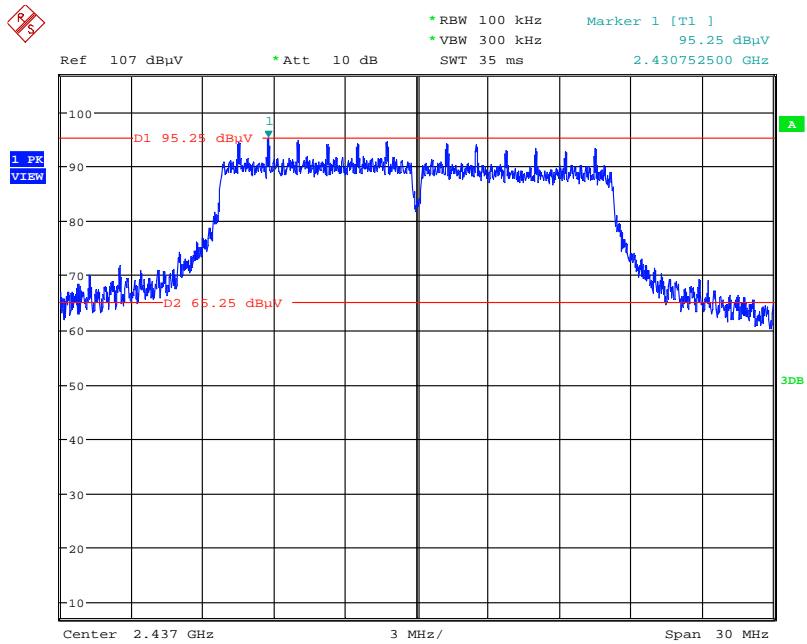

Date: 21.JAN.2014 14:06:08

Low Band Edge Plot on Configuration IEEE 802.11g / CH 1 / Ant. 1

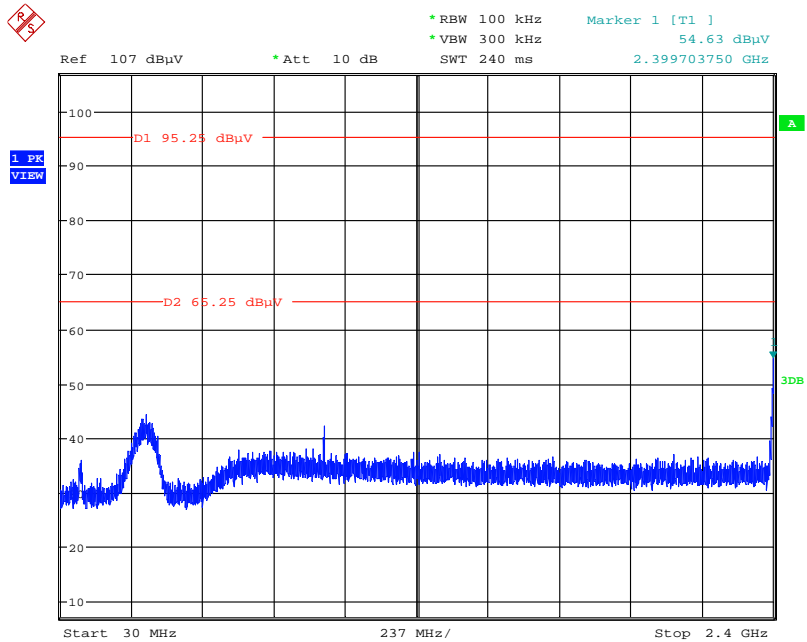

Date: 21.JAN.2014 14:07:22

Low Band Edge Plot on Configuration IEEE 802.11g / CH 1 / Ant. 1

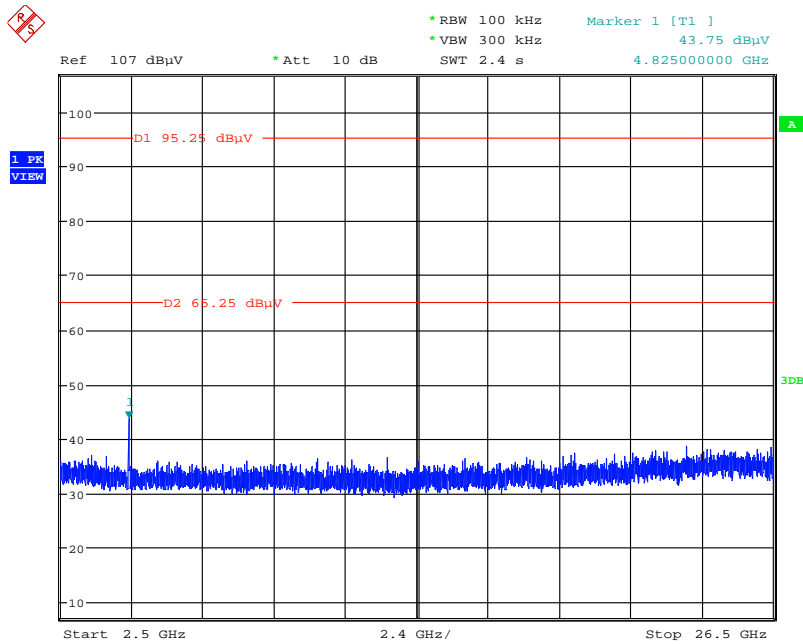

Date: 21.JAN.2014 14:07:37

Low Band Edge Plot on Configuration IEEE 802.11g / CH 6 / Ant. 1

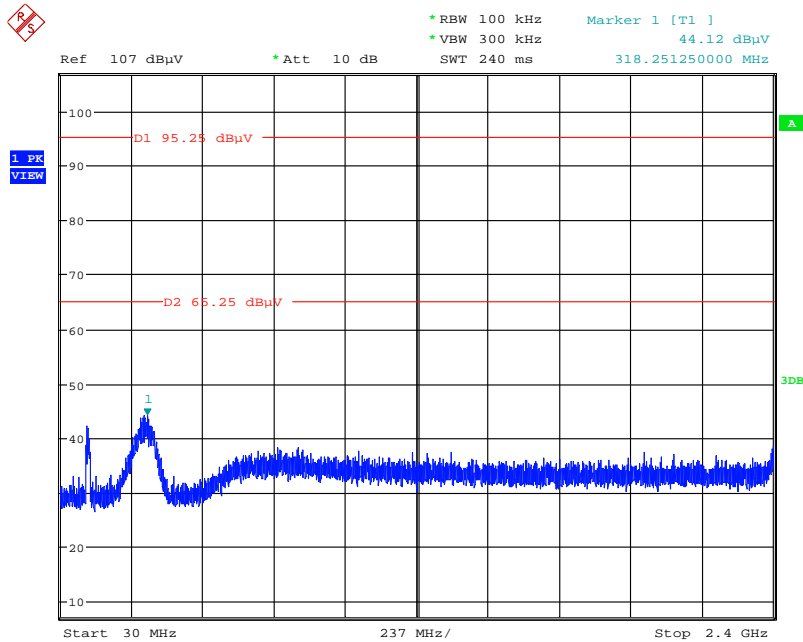

Date: 5.FEB.2014 09:20:21

Low Band Edge Plot on Configuration IEEE 802.11g / CH 6 / Ant. 1

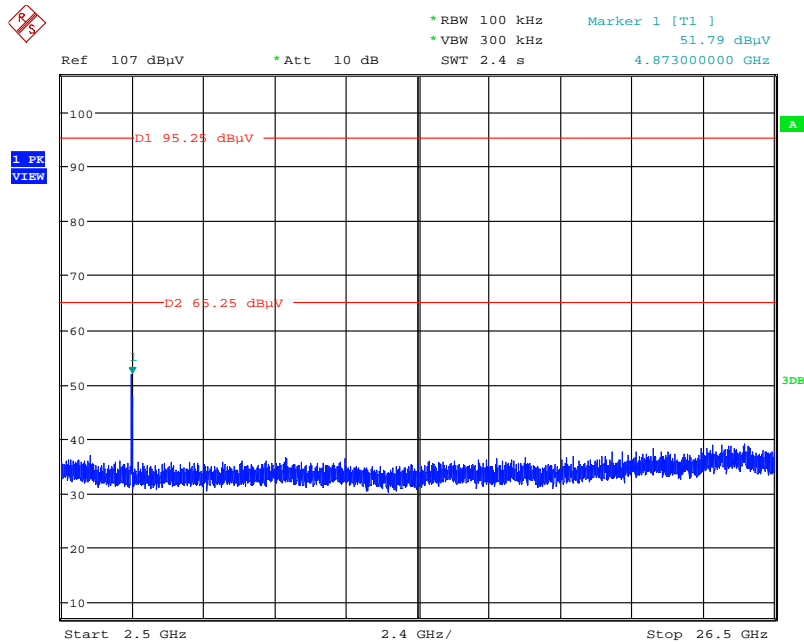

Date: 5.FEB.2014 09:20:55

Low Band Edge Plot on Configuration IEEE 802.11g / CH 11 / Ant. 1

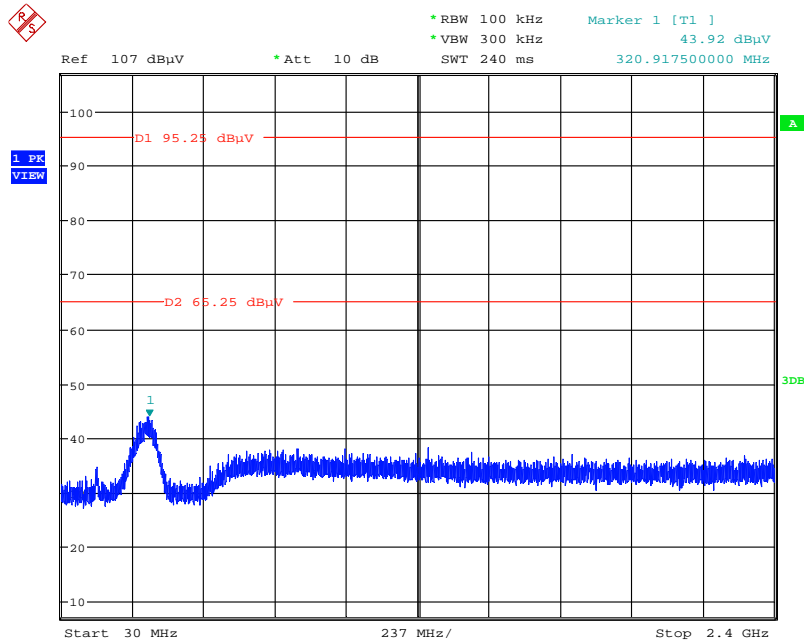

Date: 21.JAN.2014 14:08:40

Low Band Edge Plot on Configuration IEEE 802.11g / CH 11 / Ant. 1

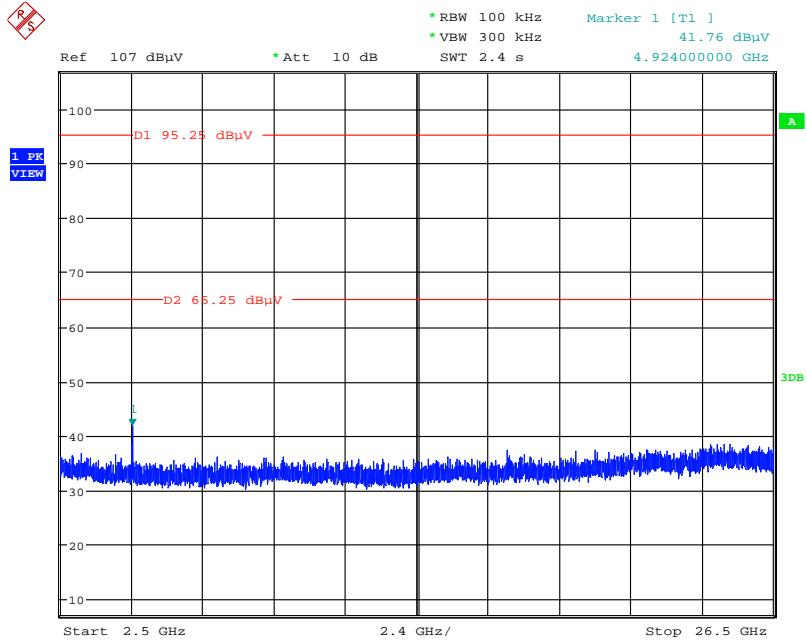

Date: 21.JAN.2014 14:08:21

Low Band Edge Plot on Configuration IEEE 802.11g / Reference Level / Ant. 1+2+3

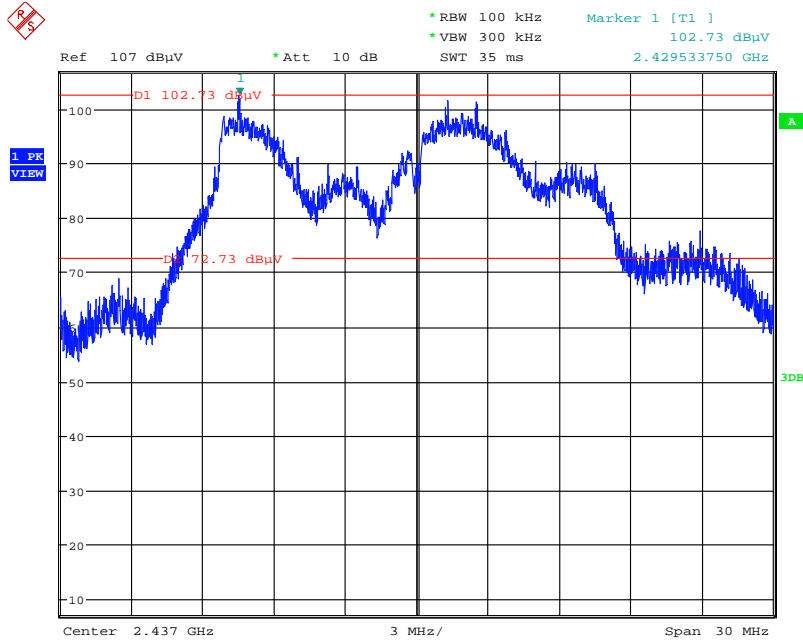

Date: 29.JAN.2014 13:49:31

Low Band Edge Plot on Configuration IEEE 802.11g / CH 1 / Ant. 1+2+3

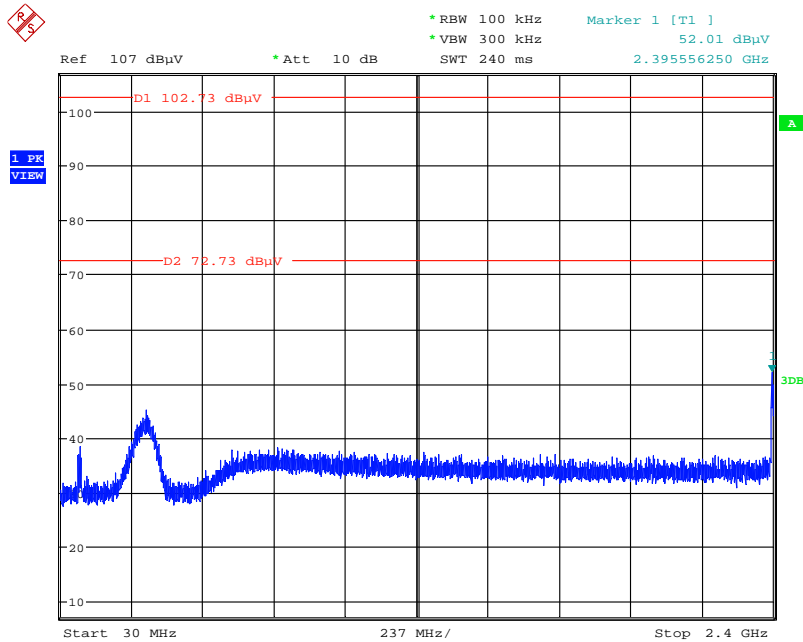

Date: 29.JAN.2014 13:55:17

Low Band Edge Plot on Configuration IEEE 802.11g / CH 1 / Ant. 1+2+3

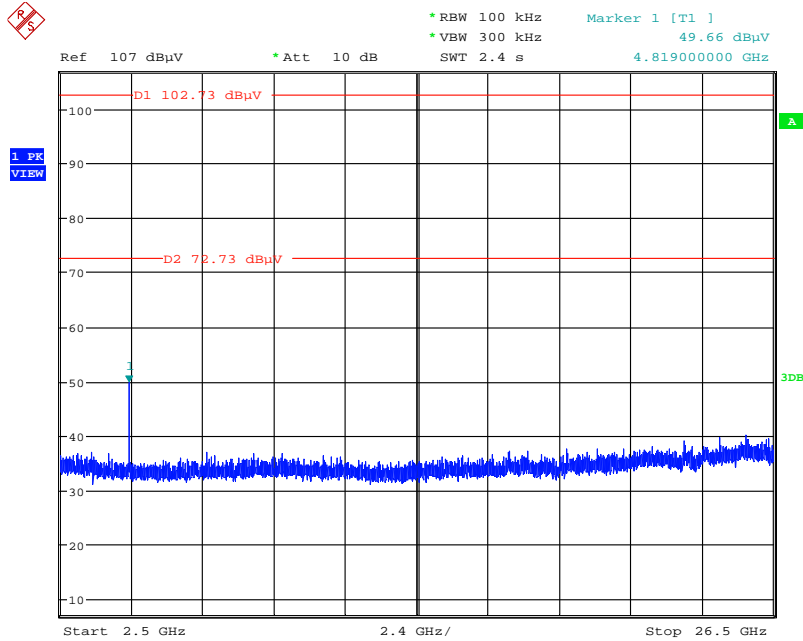

Date: 29.JAN.2014 13:53:12

Low Band Edge Plot on Configuration IEEE 802.11g / CH 6 / Ant. 1+2+3

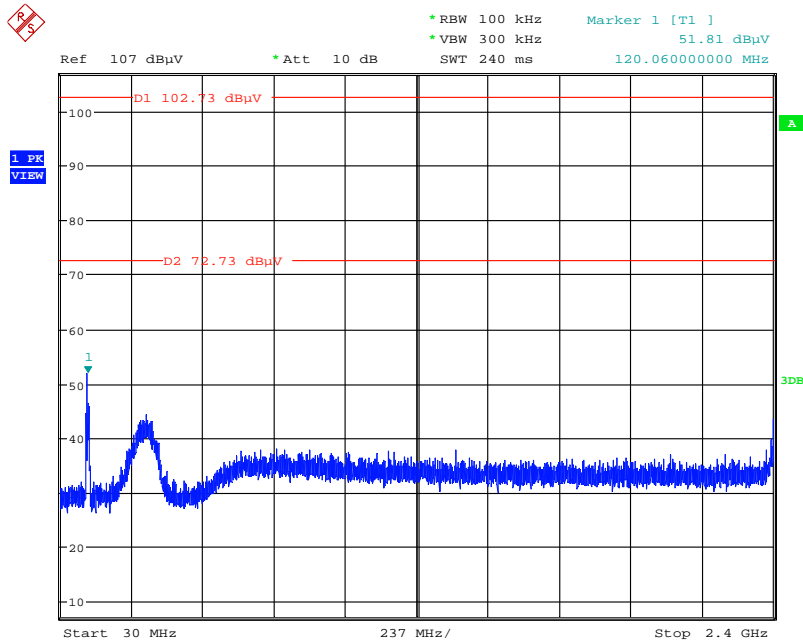

Date: 29.JAN.2014 13:50:08

Low Band Edge Plot on Configuration IEEE 802.11g / CH 6 / Ant. 1+2+3

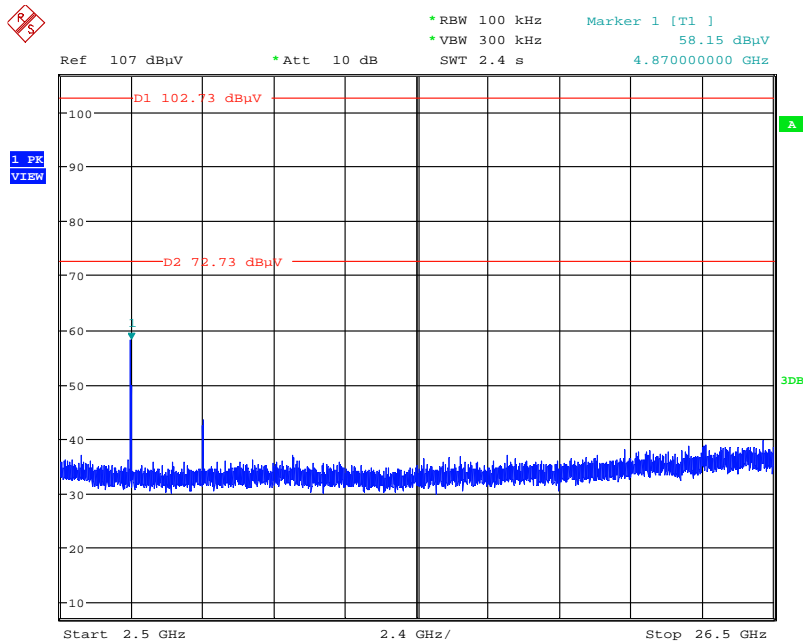

Date: 29.JAN.2014 13:50:58

Low Band Edge Plot on Configuration IEEE 802.11g / CH 11 / Ant. 1+2+3

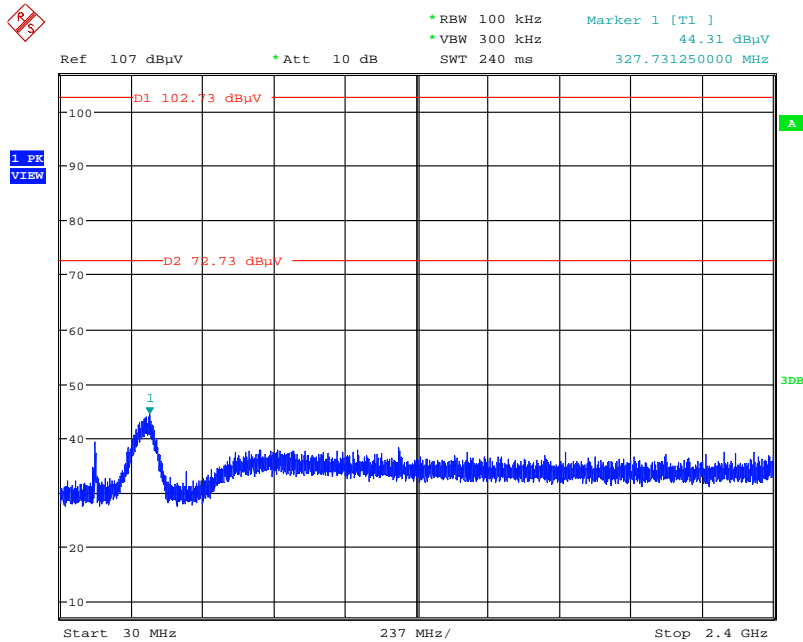

Date: 29.JAN.2014 13:57:00

Low Band Edge Plot on Configuration IEEE 802.11g / CH 11 / Ant. 1+2+3

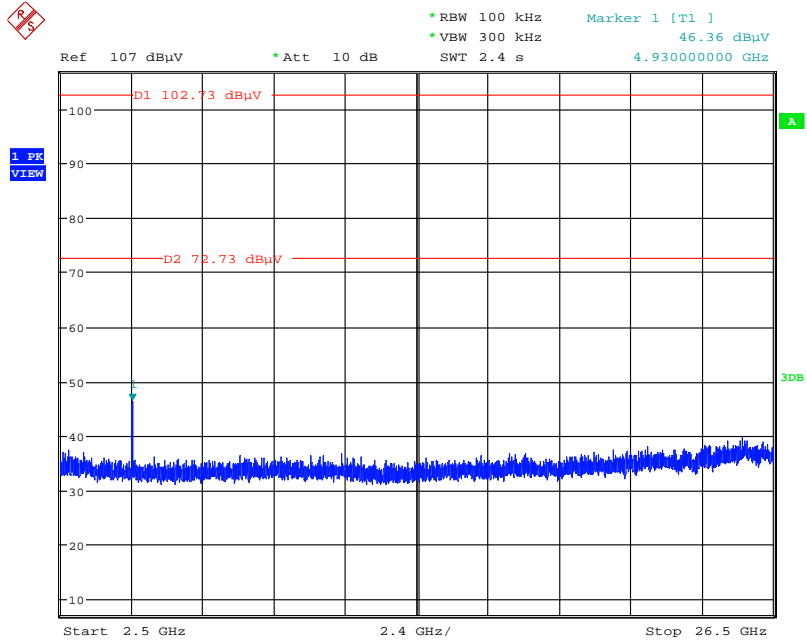

Date: 29.JAN.2014 13:57:38

Low Band Edge Plot on Configuration IEEE 802.11n 20MHz MCS0 / Reference Level / Ant. 1

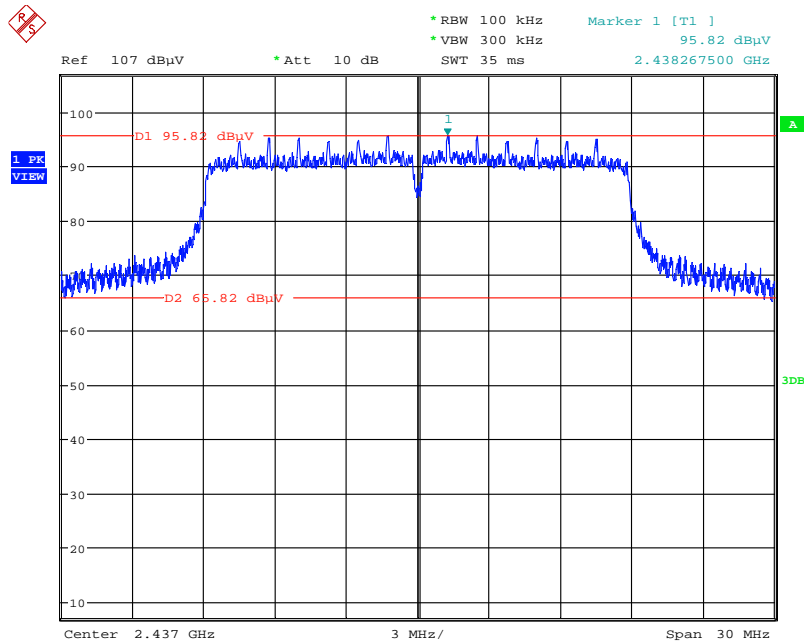

Date: 5.FEB.2014 09:57:18

Low Band Edge Plot on Configuration IEEE 802.11n 20MHz MCS0 / CH1 / Ant. 1

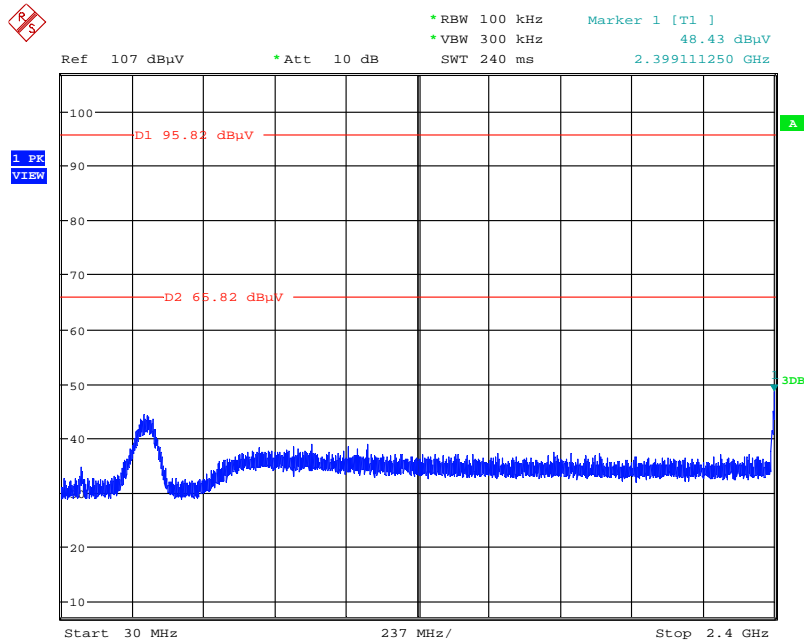

Date: 5.FEB.2014 10:13:08

Low Band Edge Plot on Configuration IEEE 802.11n 20MHz MCS0 / CH1 / Ant. 1

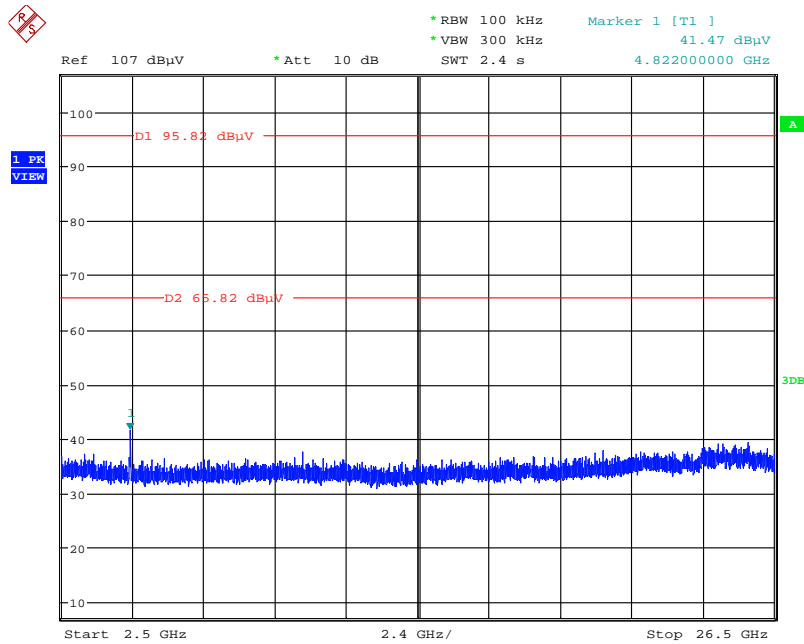

Date: 5.FEB.2014 10:13:48

Low Band Edge Plot on Configuration IEEE 802.11n 20MHz MCS0 / CH6 / Ant. 1

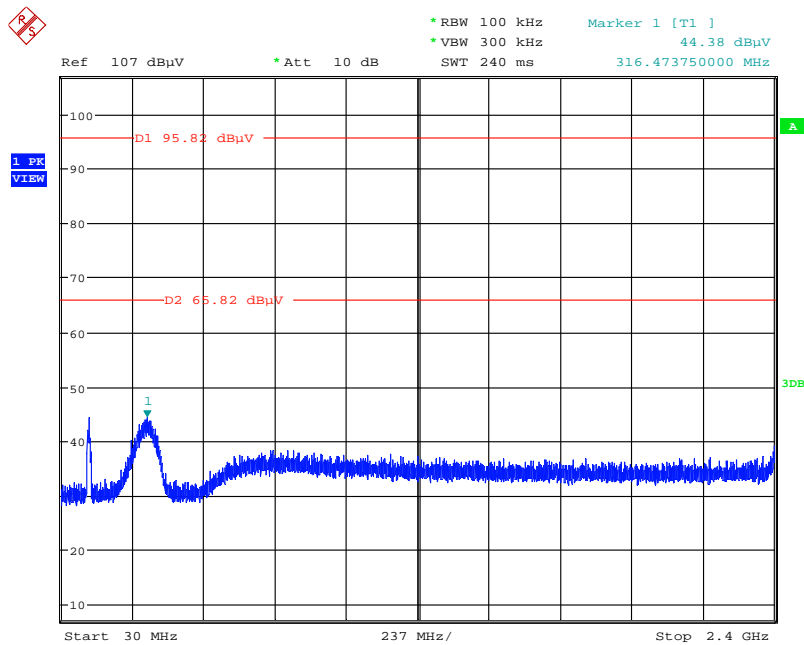

Date: 5.FEB.2014 09:59:00

Low Band Edge Plot on Configuration IEEE 802.11n 20MHz MCS0 / CH6 / Ant. 1

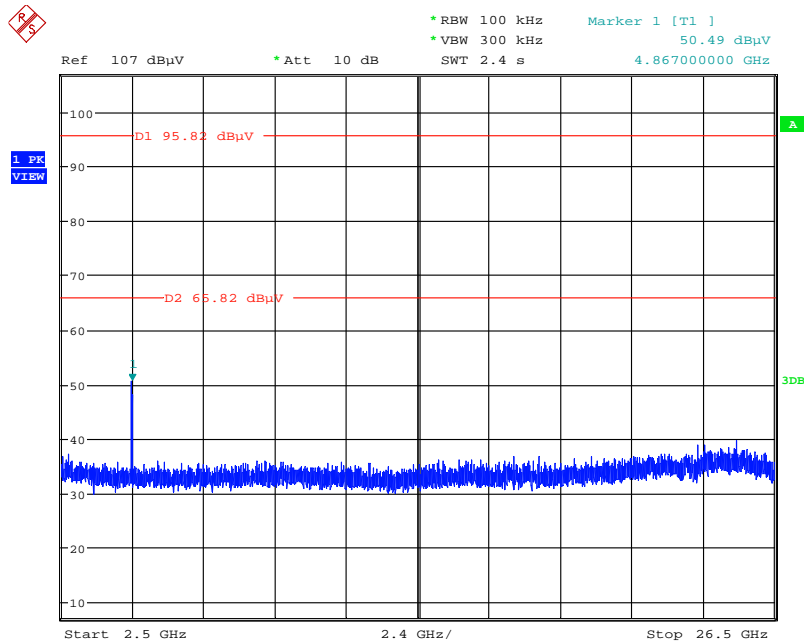

Date: 5.FEB.2014 09:59:22

Low Band Edge Plot on Configuration IEEE 802.11n 20MHz MCS0 / CH11 / Ant. 1

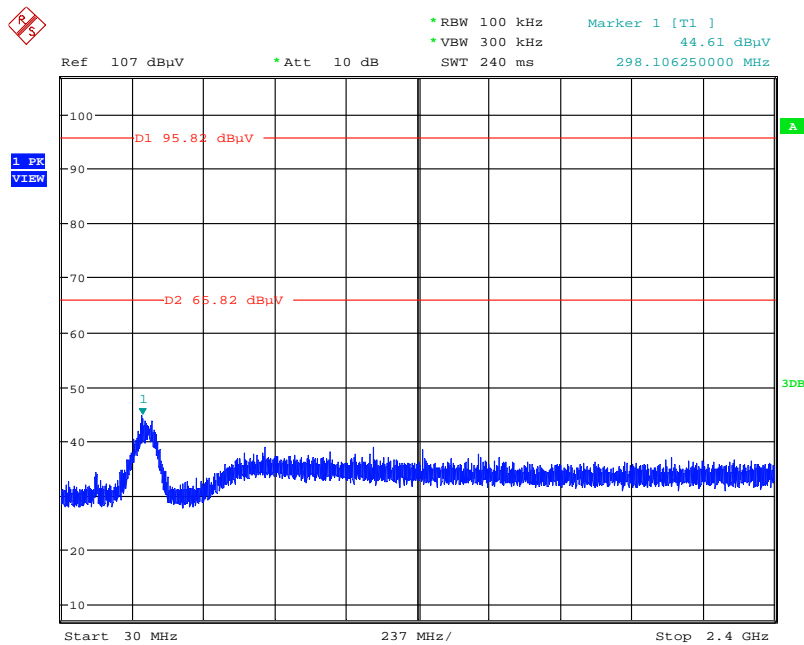

Date: 5.FEB.2014 10:15:24

Low Band Edge Plot on Configuration IEEE 802.11n 20MHz MCS0 / CH11 / Ant. 1

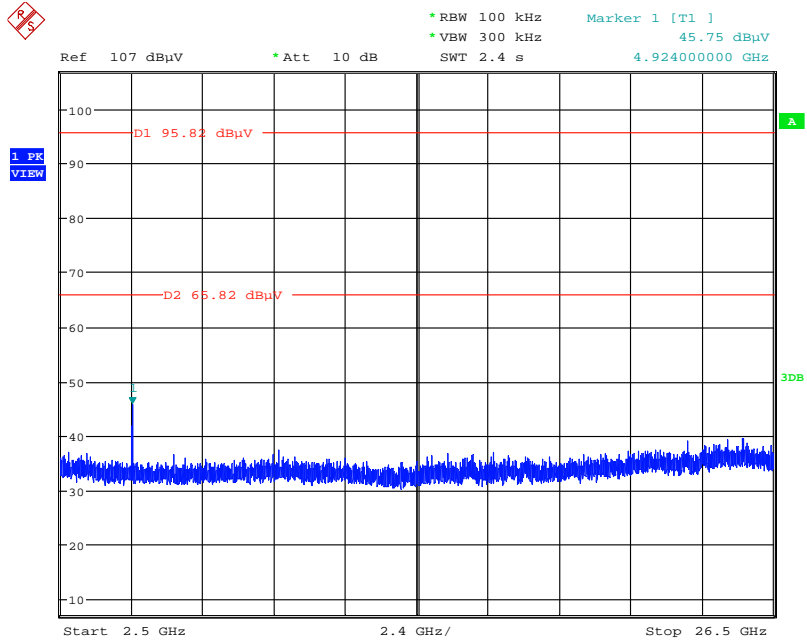

Date: 5.FEB.2014 10:17:53

Low Band Edge Plot on Configuration IEEE 802.11n 20MHz MCS0 / Reference Level / Ant. 1+2+3

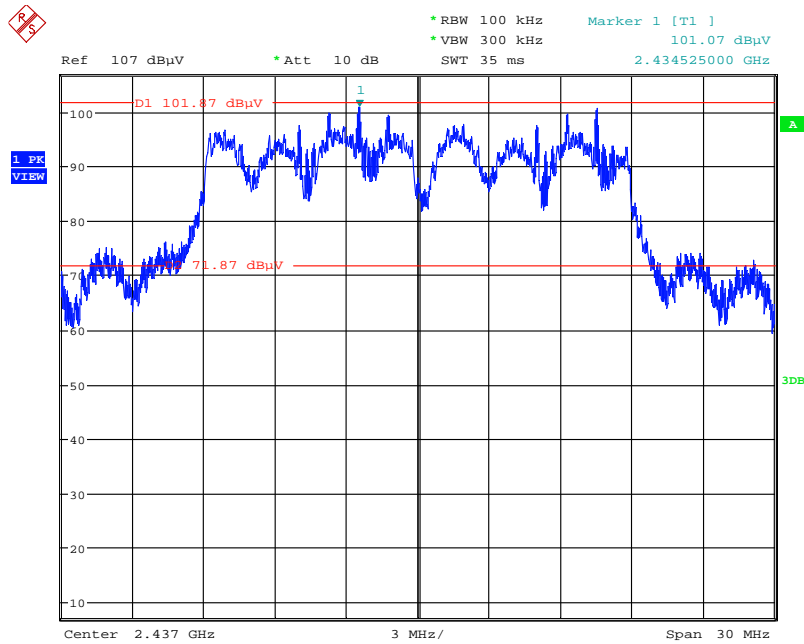

Date: 21.JAN.2014 11:28:43

Low Band Edge Plot on Configuration IEEE 802.11n 20MHz MCS0 / CH 1 / Ant. 1+2+3

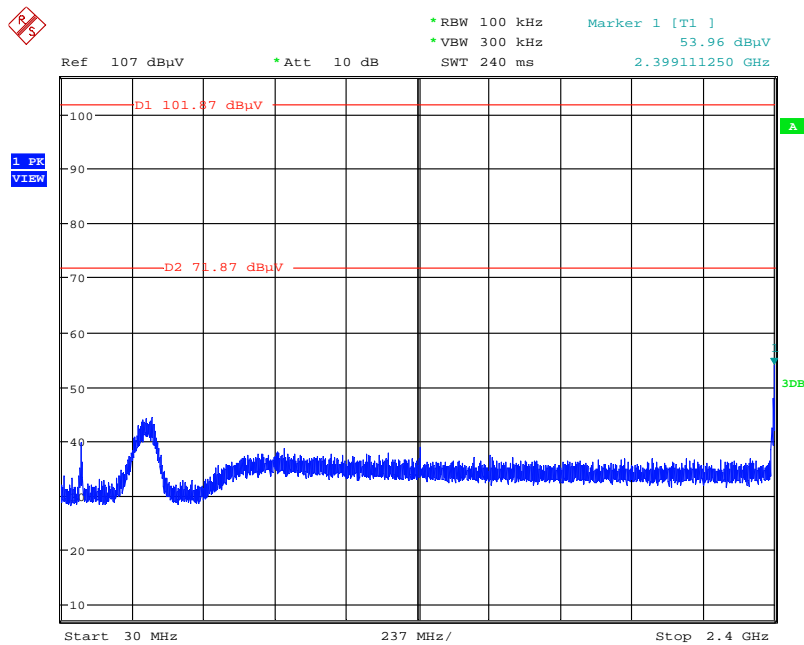

Date: 21.JAN.2014 11:29:55

Low Band Edge Plot on Configuration IEEE 802.11n 20MHz MCS0 / CH 1 / Ant. 1+2+3

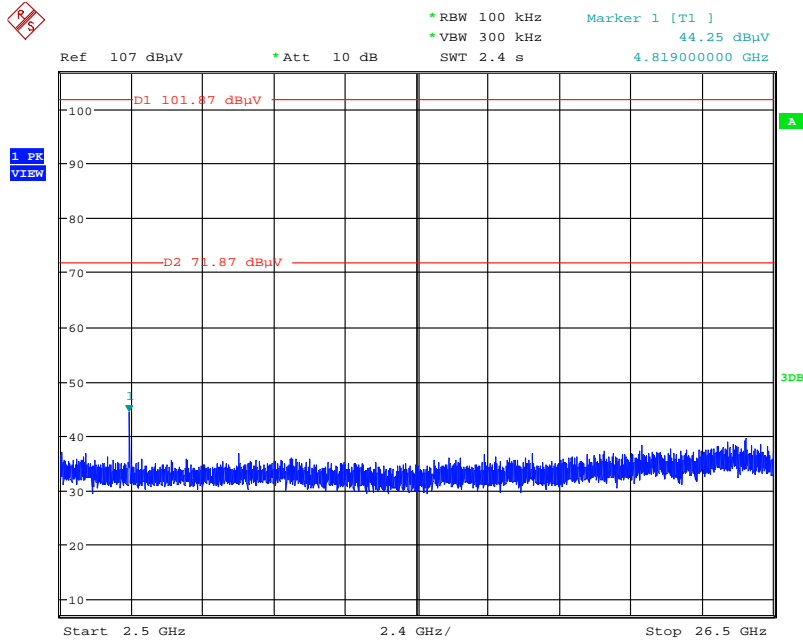

Date: 21.JAN.2014 11:30:14

Low Band Edge Plot on Configuration IEEE 802.11n 20MHz MCS0 / CH 6 / Ant. 1+2+3

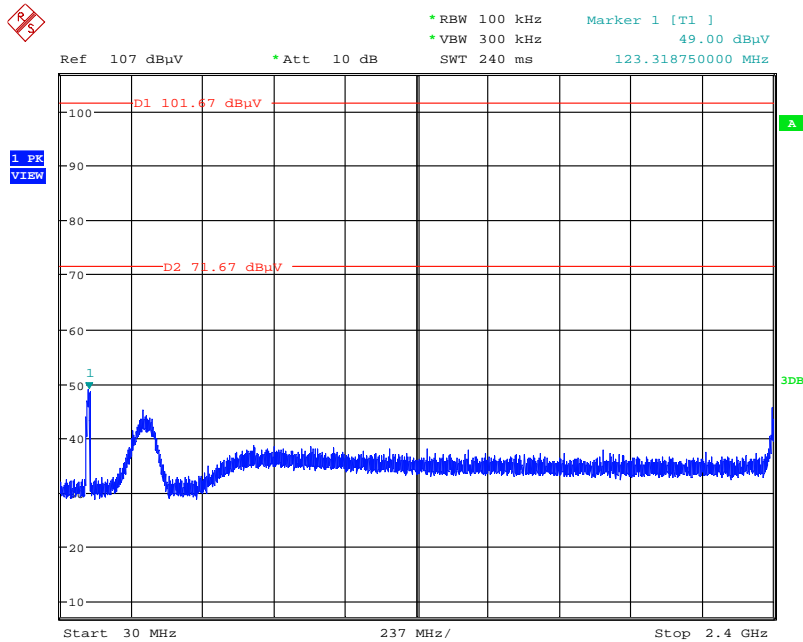

Date: 5.FEB.2014 09:28:47

Low Band Edge Plot on Configuration IEEE 802.11n 20MHz MCS0 / CH 6 / Ant. 1+2+3

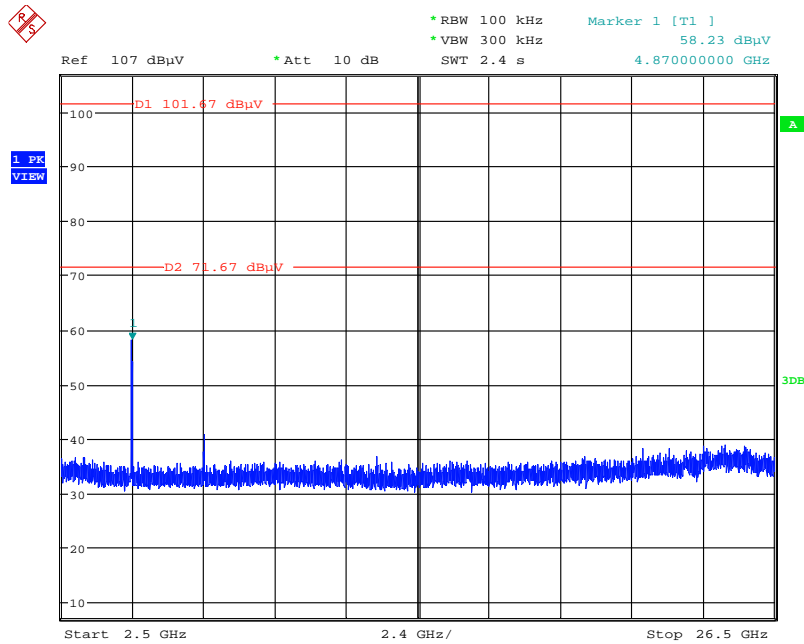

Date: 5.FEB.2014 09:29:13

Low Band Edge Plot on Configuration IEEE 802.11n 20MHz MCS0 / CH 11 / Ant. 1+2+3

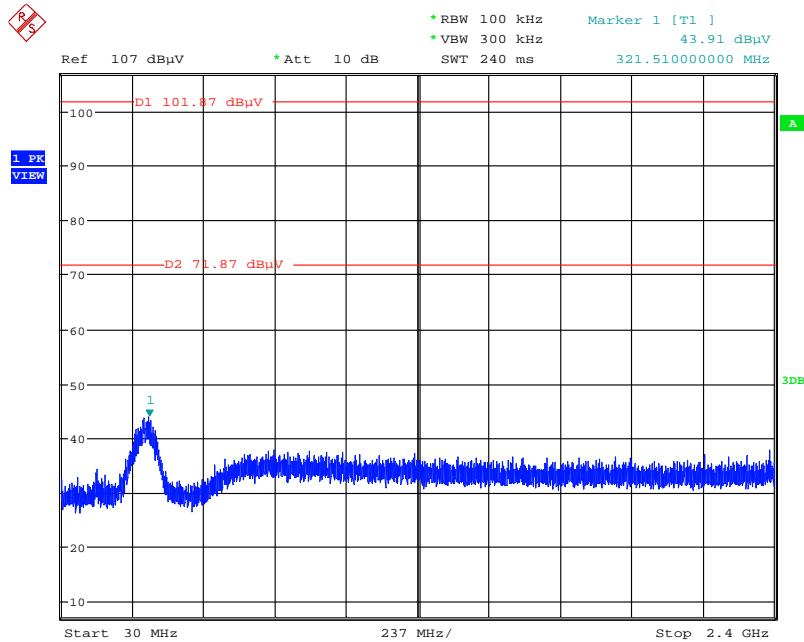

Date: 21.JAN.2014 11:31:20

Low Band Edge Plot on Configuration IEEE 802.11n 20MHz MCS0 / CH 11 / Ant. 1+2+3

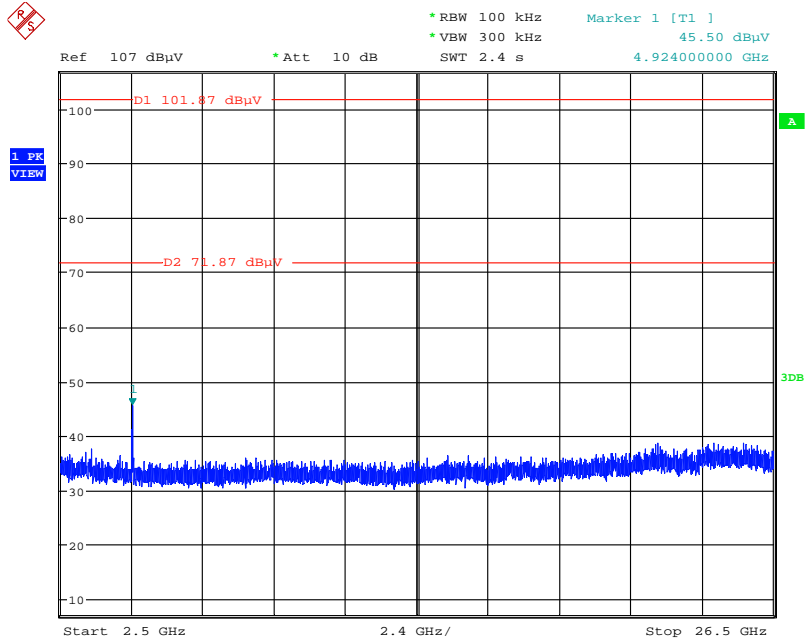

Date: 21.JAN.2014 11:31:05

Low Band Edge Plot on Configuration IEEE 802.11n 20MHz MCS8 / Reference Level / Ant. 1+2+3

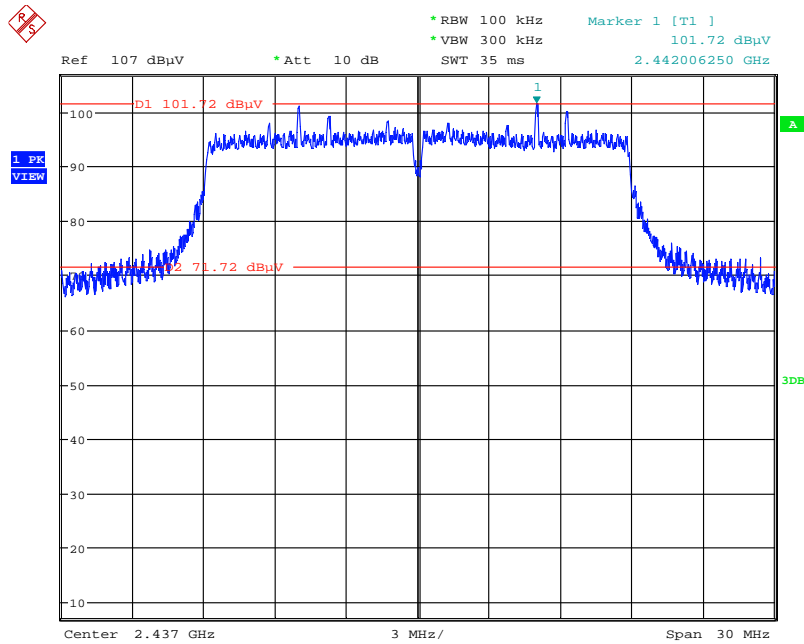

Date: 24.JAN.2014 11:24:04

Low Band Edge Plot on Configuration IEEE 802.11n 20MHz MCS8 / CH 1 / Ant. 1+2+3

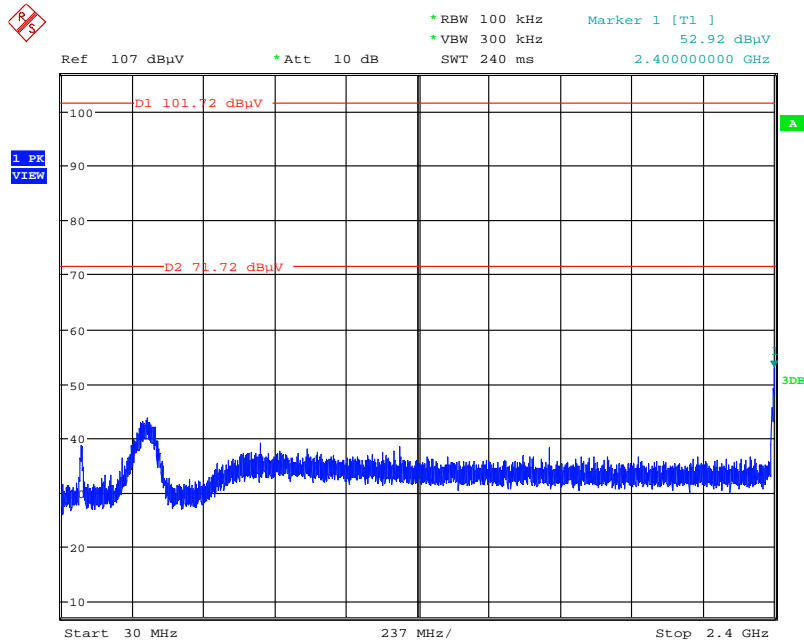

Date: 24.JAN.2014 11:25:01

Low Band Edge Plot on Configuration IEEE 802.11n 20MHz MCS8 / CH 1 / Ant. 1+2+3

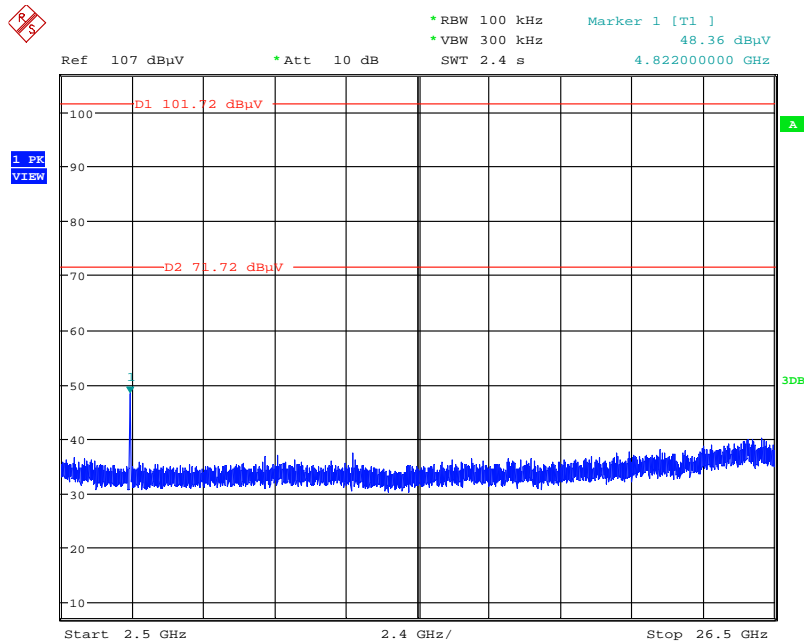

Date: 24.JAN.2014 11:25:25

Low Band Edge Plot on Configuration IEEE 802.11n 20MHz MCS8 / CH 6 / Ant. 1+2+3

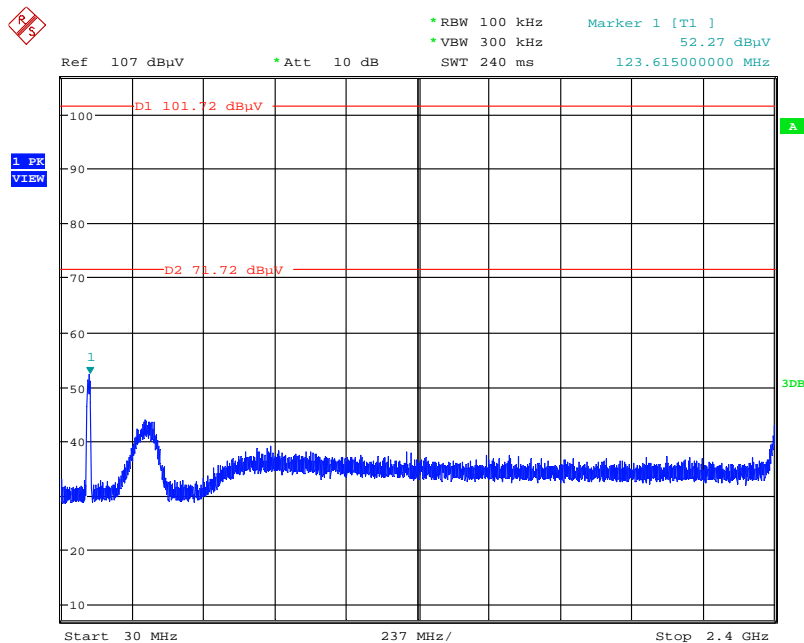

Date: 5.FEB.2014 09:31:30

Low Band Edge Plot on Configuration IEEE 802.11n 20MHz MCS8 / CH 6 / Ant. 1+2+3

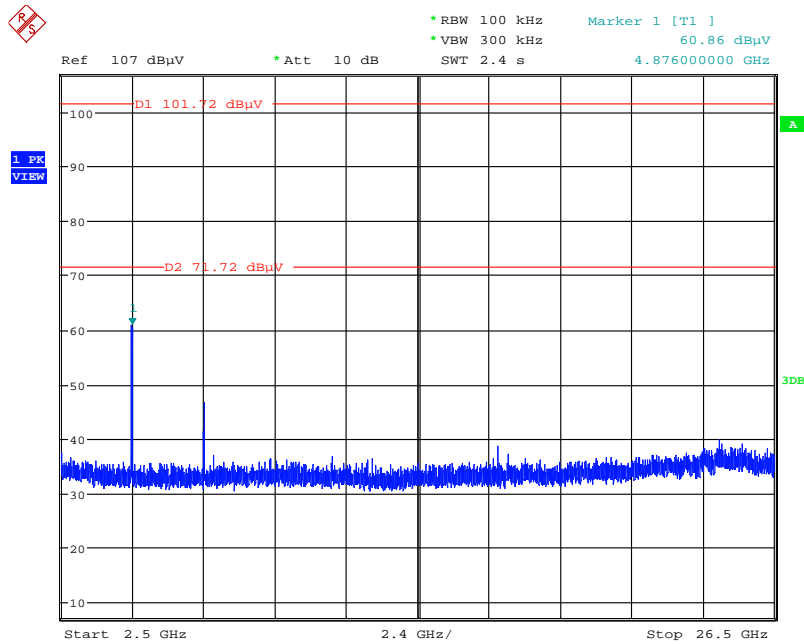

Date: 5.FEB.2014 09:32:15

Low Band Edge Plot on Configuration IEEE 802.11n 20MHz MCS8 / CH 11 / Ant. 1+2+3

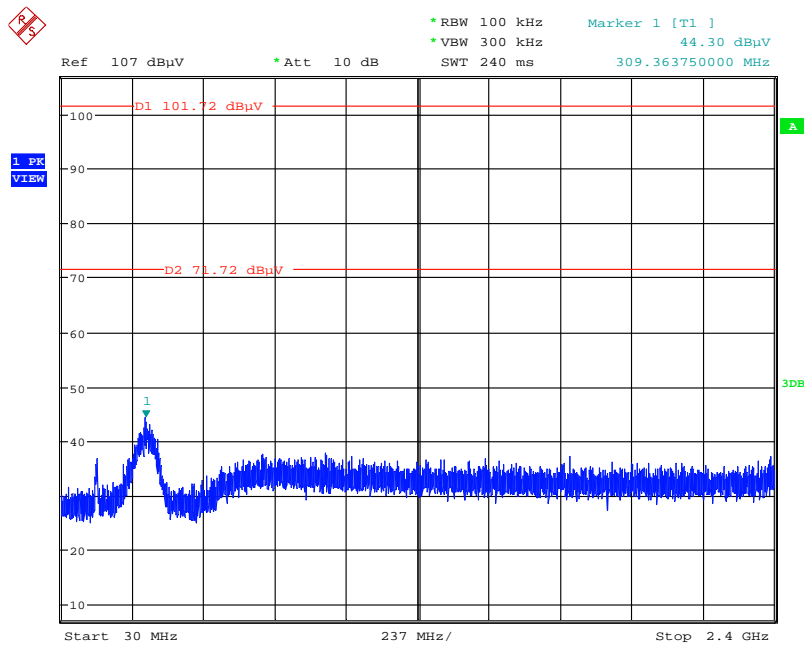

Date: 24.JAN.2014 11:26:15

Low Band Edge Plot on Configuration IEEE 802.11n 20MHz MCS8 / CH 11 / Ant. 1+2+3

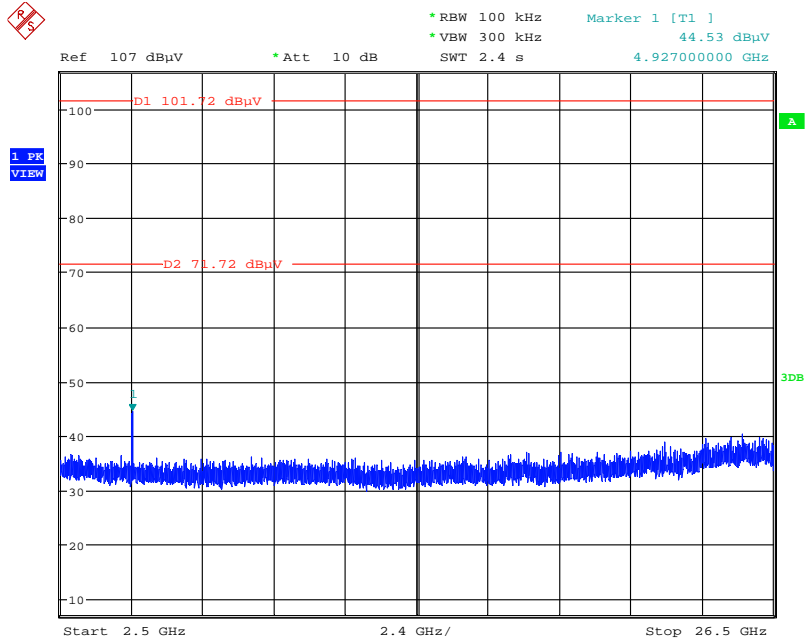

Date: 24.JAN.2014 11:25:58

Low Band Edge Plot on Configuration IEEE 802.11n 40MHz MCS0 / Reference Level / Ant. 3

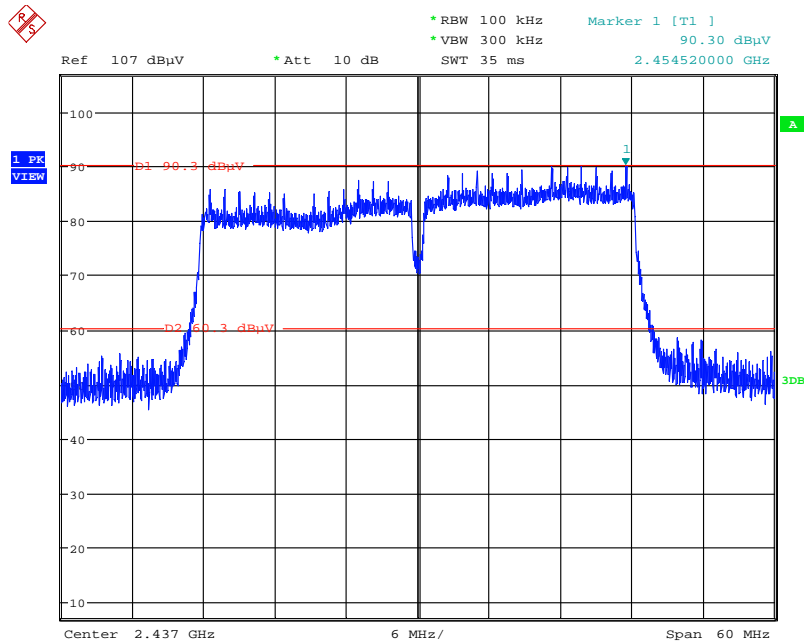

Date: 5.FEB.2014 11:17:04

Low Band Edge Plot on Configuration IEEE 802.11n 40MHz MCS0 / CH 3 / Ant. 3

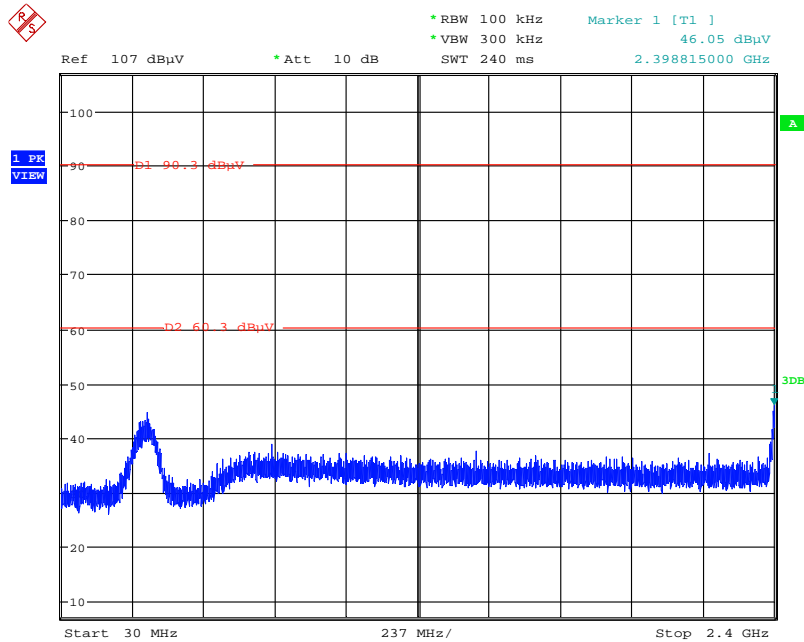

Date: 5.FEB.2014 11:18:35

Low Band Edge Plot on Configuration IEEE 802.11n 40MHz MCS0 / CH 3 / Ant. 3

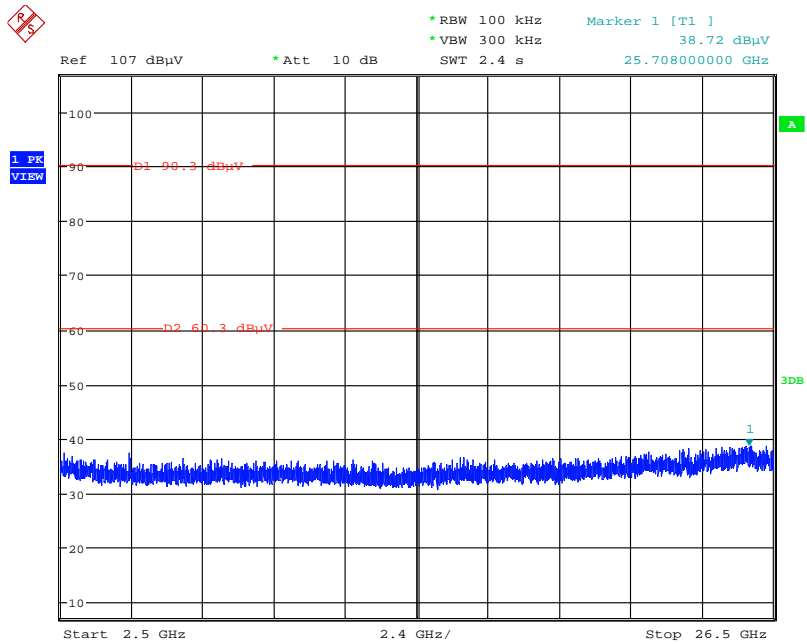

Date: 5.FEB.2014 11:19:09

Low Band Edge Plot on Configuration IEEE 802.11n 40MHz MCS0 / CH 6 / Ant. 3

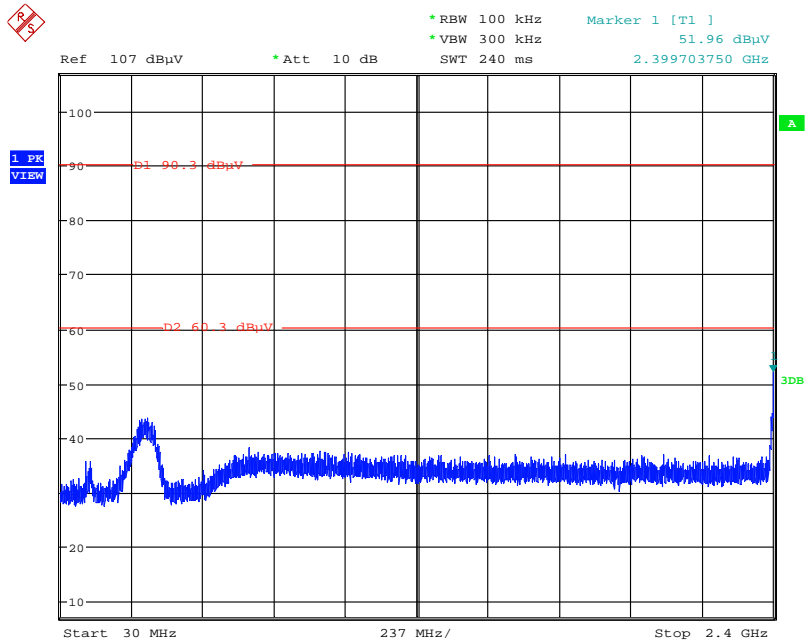

Date: 5.FEB.2014 11:17:35

Low Band Edge Plot on Configuration IEEE 802.11n 40MHz MCS0 / CH 6 / Ant. 3

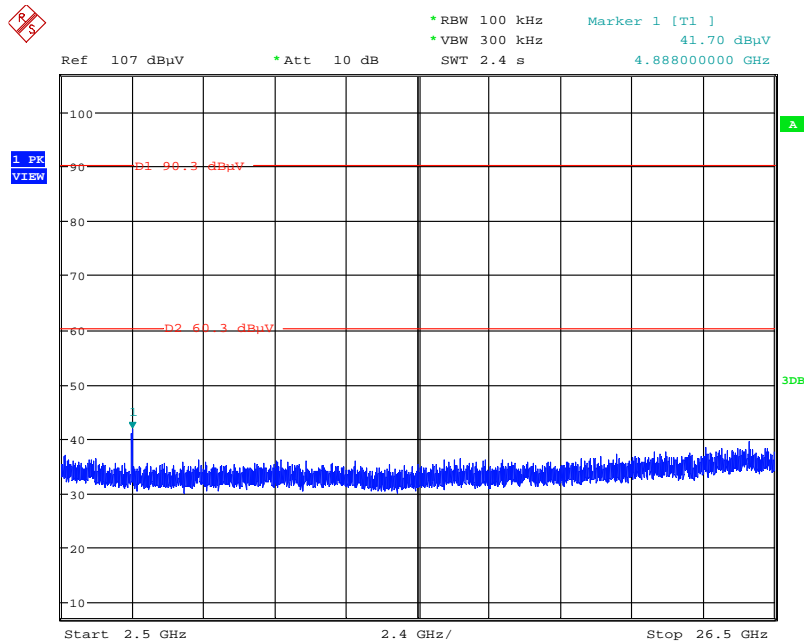

Date: 5.FEB.2014 11:17:57

Low Band Edge Plot on Configuration IEEE 802.11n 40MHz MCS0 / CH 9 / Ant. 3

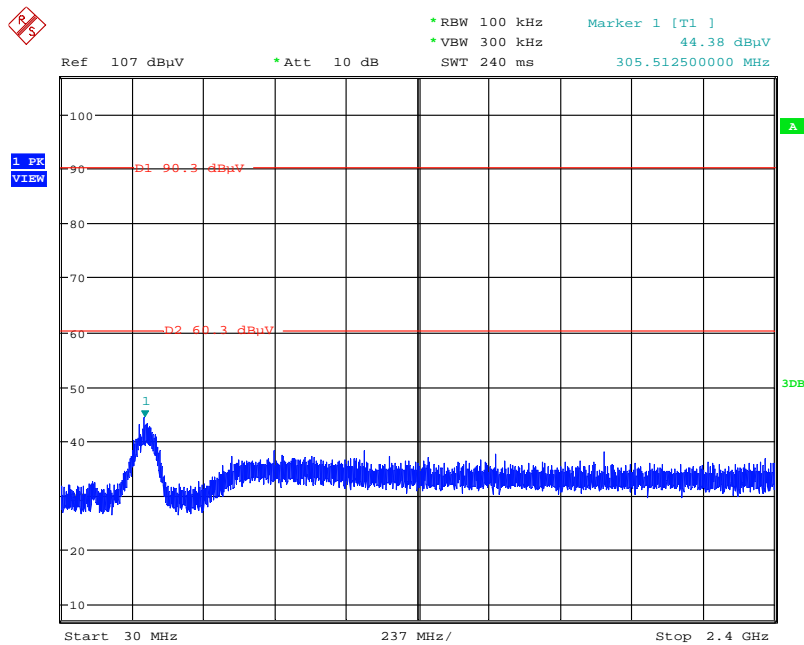

Date: 5.FEB.2014 11:22:04

Low Band Edge Plot on Configuration IEEE 802.11n 40MHz MCS0 / CH 9 / Ant. 3

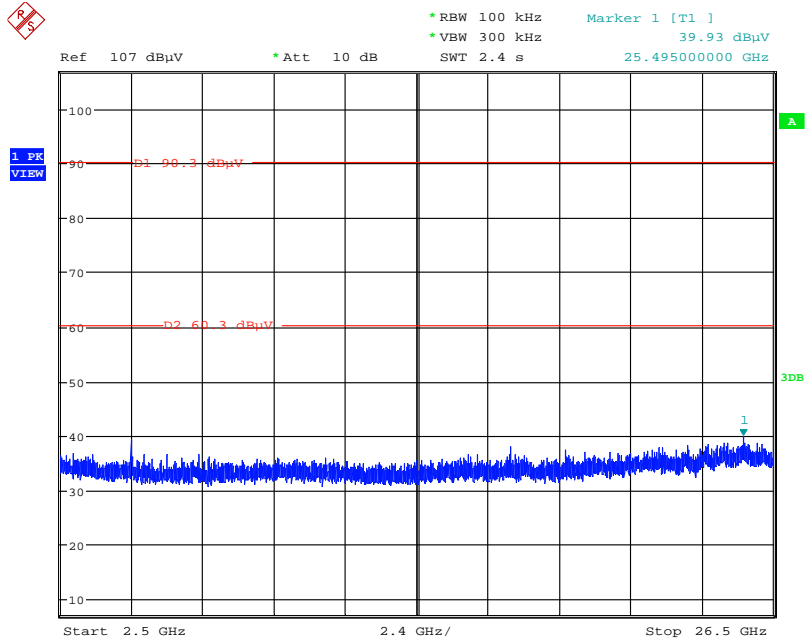

Date: 5.FEB.2014 11:22:31

Low Band Edge Plot on Configuration IEEE 802.11n 40MHz MCS0 / Reference Level / Ant. 1+2+3

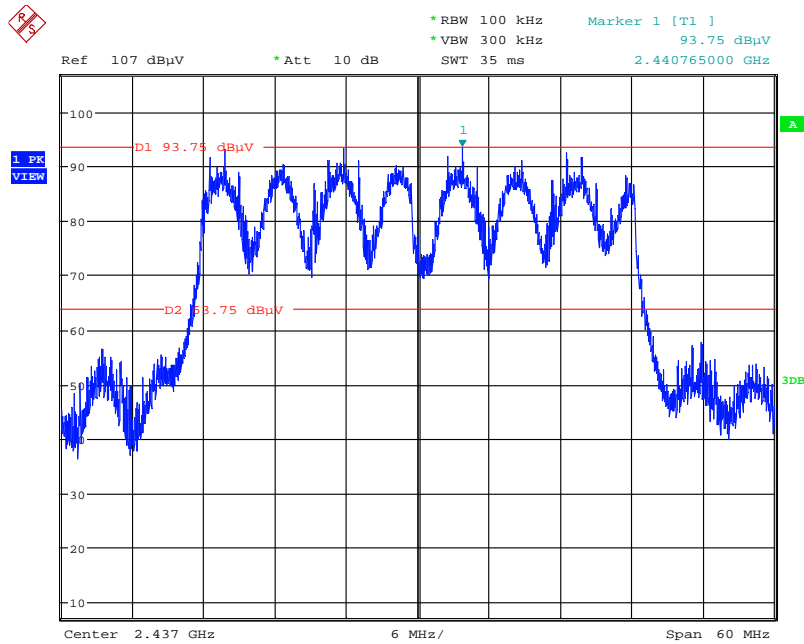

Date: 21.JAN.2014 11:34:29

Low Band Edge Plot on Configuration IEEE 802.11n 40MHz MCS0 / CH 3 / Ant. 1+2+3

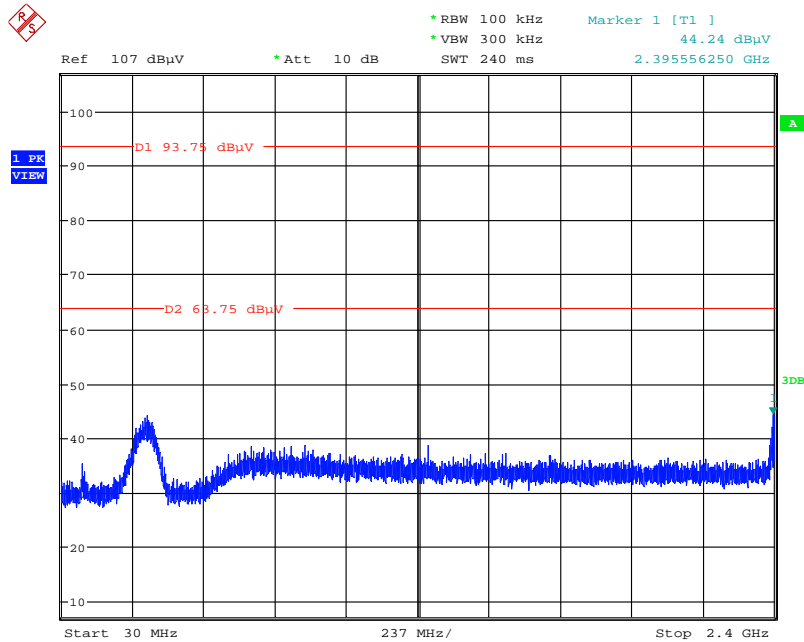

Date: 21.JAN.2014 11:35:23

Low Band Edge Plot on Configuration IEEE 802.11n 40MHz MCS0 / CH 3 / Ant. 1+2+3

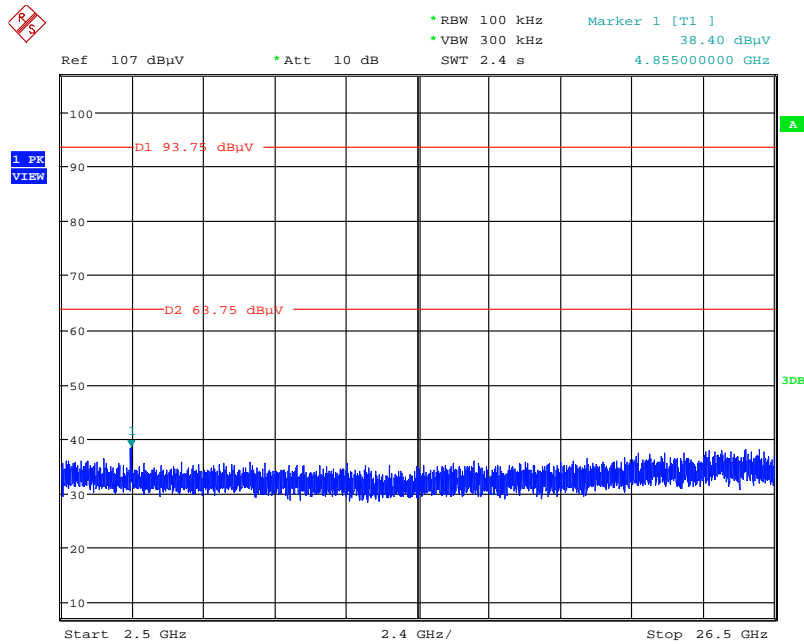

Date: 21.JAN.2014 11:35:41

Low Band Edge Plot on Configuration IEEE 802.11n 40MHz MCS0 / CH 6 / Ant. 1+2+3

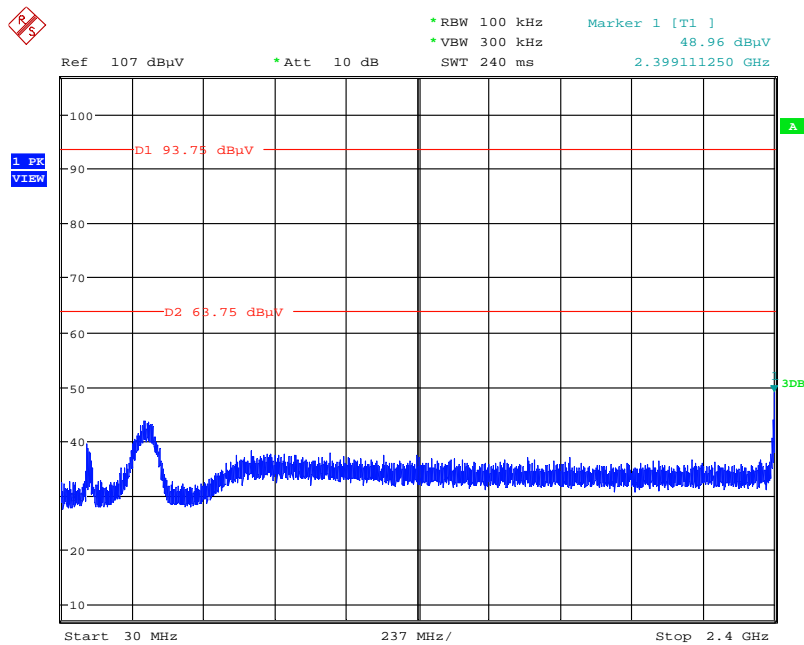

Date: 5.FEB.2014 10:45:47

Low Band Edge Plot on Configuration IEEE 802.11n 40MHz MCS0 / CH 6 / Ant. 1+2+3

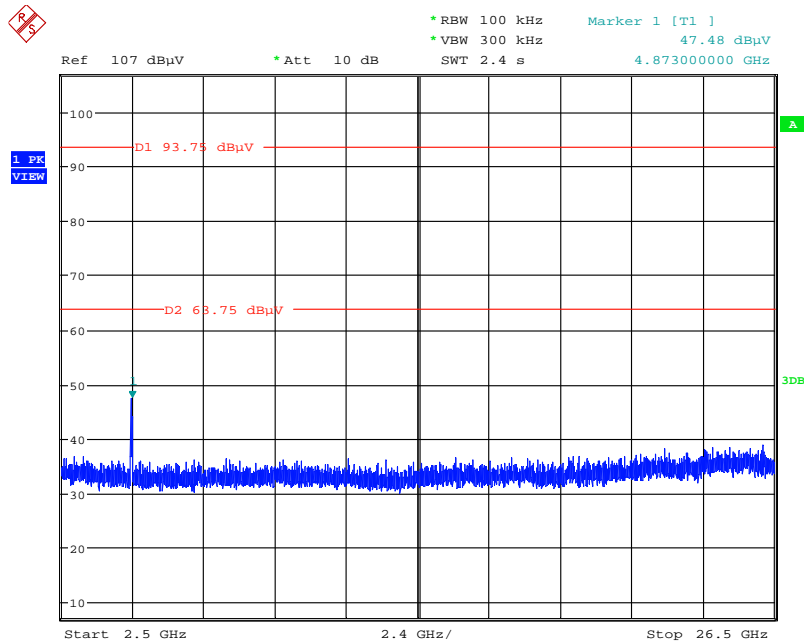

Date: 5.FEB.2014 10:46:10

Low Band Edge Plot on Configuration IEEE 802.11n 40MHz MCS0 / CH 9 / Ant. 1+2+3

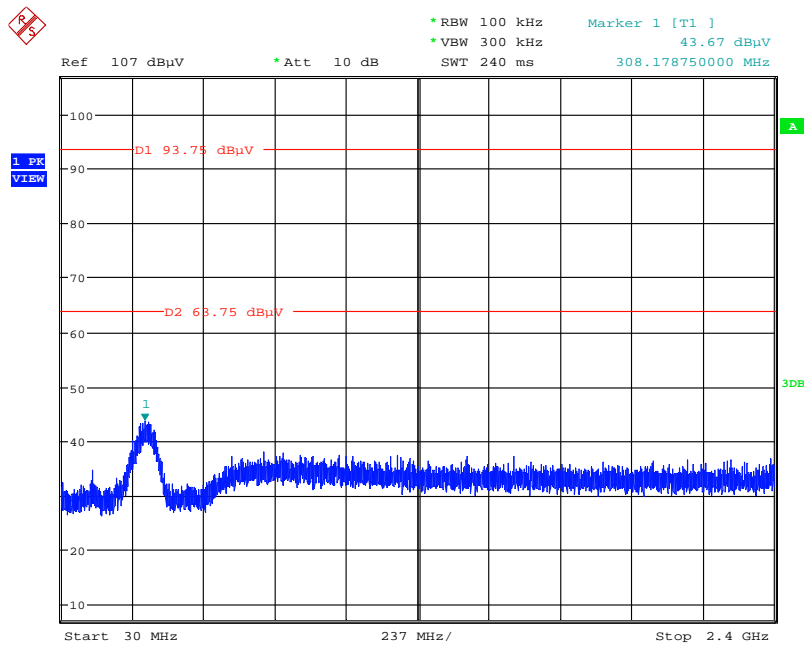

Date: 21.JAN.2014 11:36:31

Low Band Edge Plot on Configuration IEEE 802.11n 40MHz MCS0 / CH 9 / Ant. 1+2+3

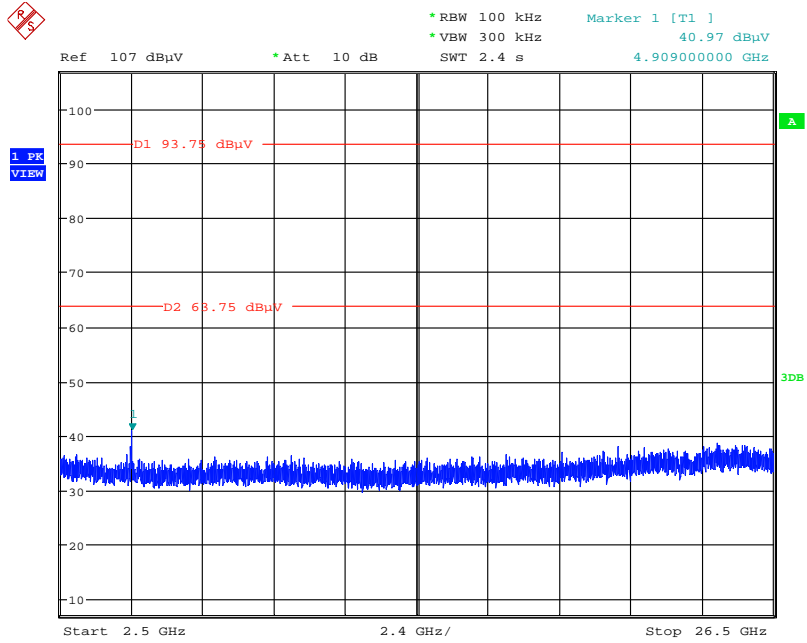

Date: 21.JAN.2014 11:36:16

Low Band Edge Plot on Configuration IEEE 802.11n 40MHz MCS8 / Reference Level / Ant. 1+2+3

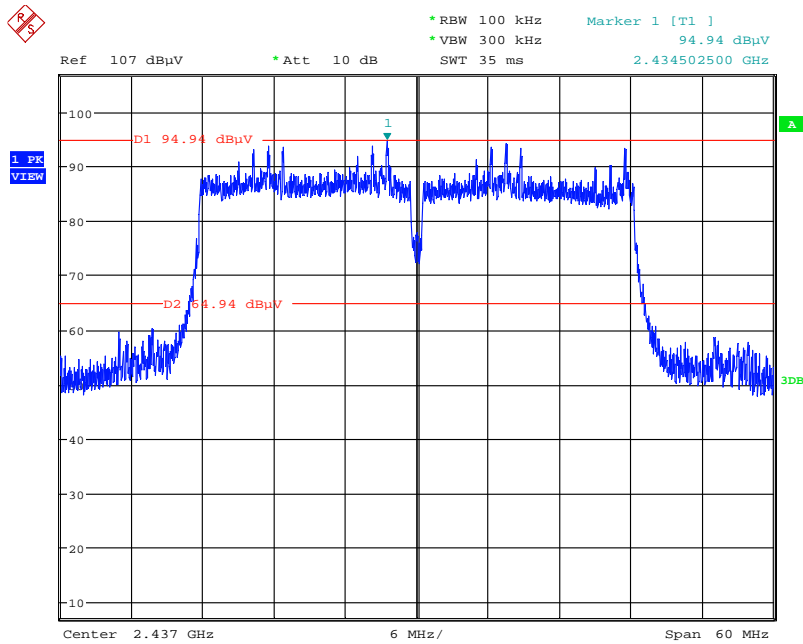

Date: 24.JAN.2014 11:28:07

Low Band Edge Plot on Configuration IEEE 802.11n 40MHz MCS8 / CH 3 / Ant. 1+2+3

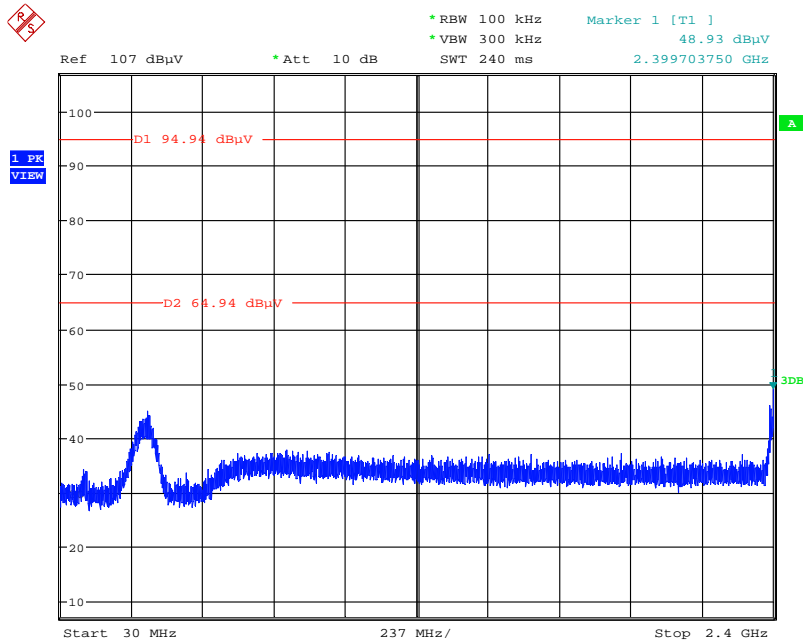

Date: 24.JAN.2014 11:29:16

Low Band Edge Plot on Configuration IEEE 802.11n 40MHz MCS8 / CH 3 / Ant. 1+2+3

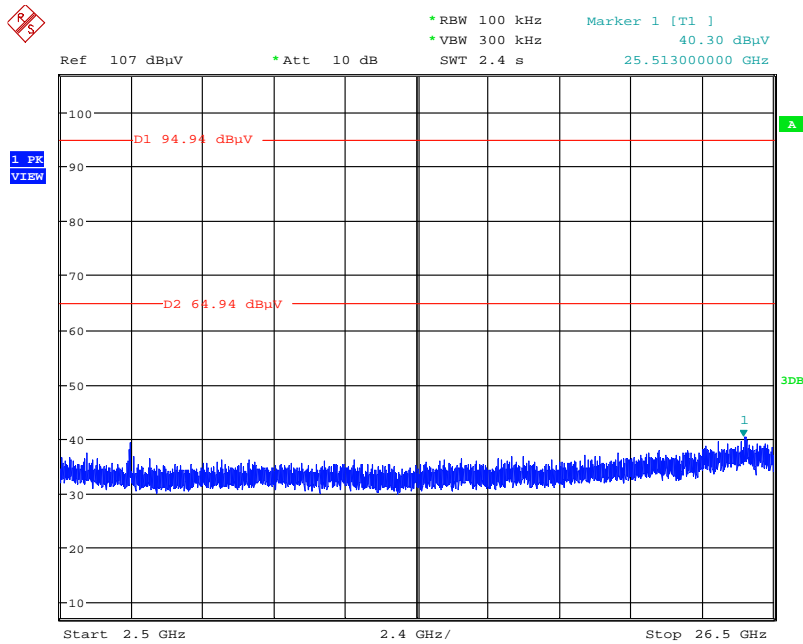

Date: 24.JAN.2014 11:29:31

Low Band Edge Plot on Configuration IEEE 802.11n 40MHz MCS8 / CH 6 / Ant. 1+2+3

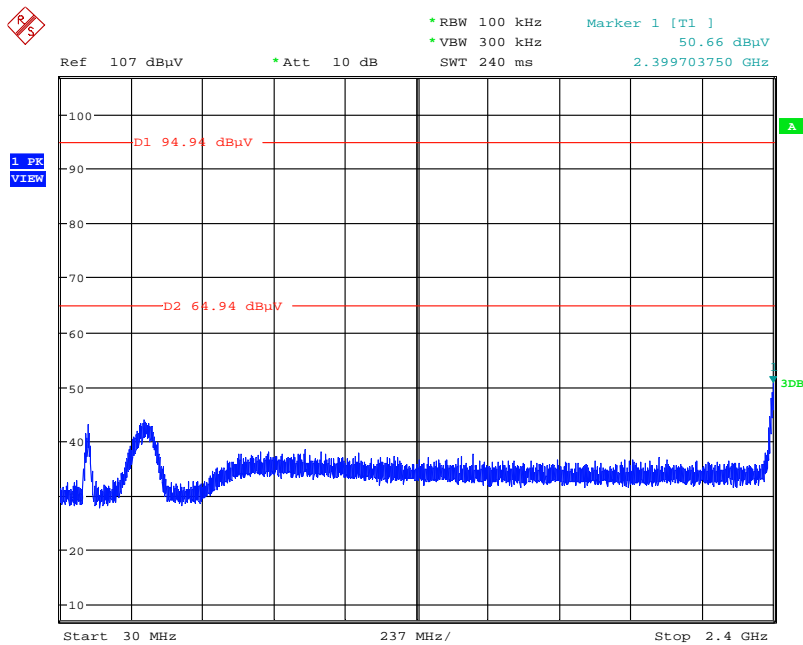

Date: 5.FEB.2014 10:51:09

Low Band Edge Plot on Configuration IEEE 802.11n 40MHz MCS8 / CH 6 / Ant. 1+2+3

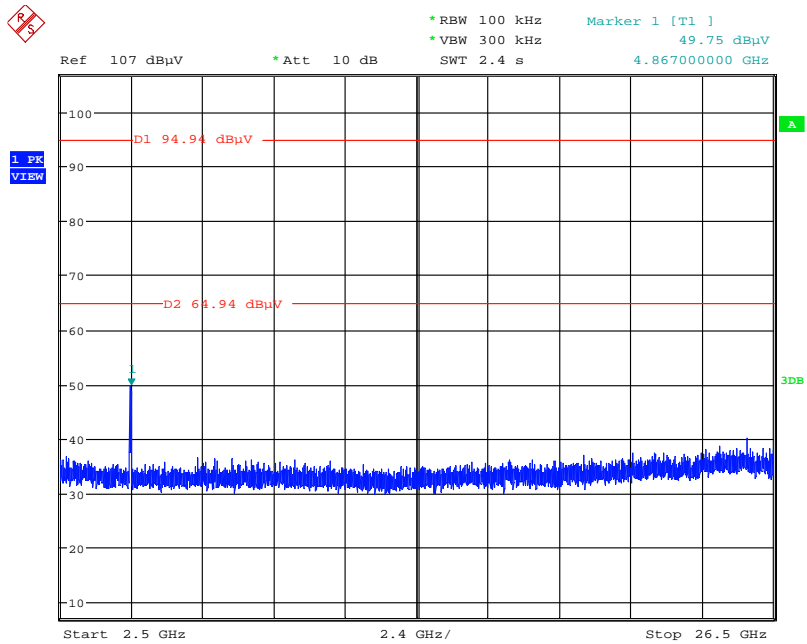

Date: 5.FEB.2014 10:51:29

Low Band Edge Plot on Configuration IEEE 802.11n 40MHz MCS8 / CH 9 / Ant. 1+2+3

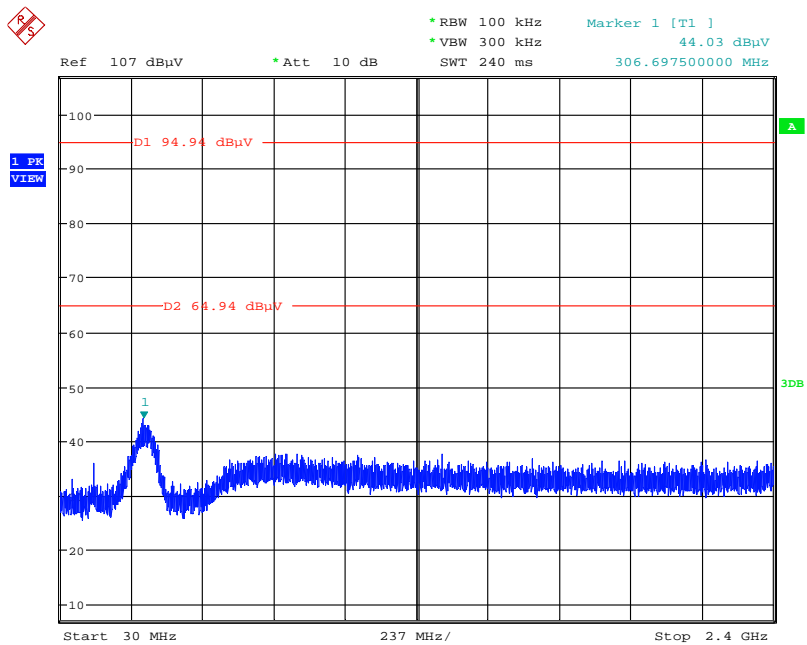

Date: 24.JAN.2014 11:30:18

Low Band Edge Plot on Configuration IEEE 802.11n 40MHz MCS8 / CH 9 / Ant. 1+2+3

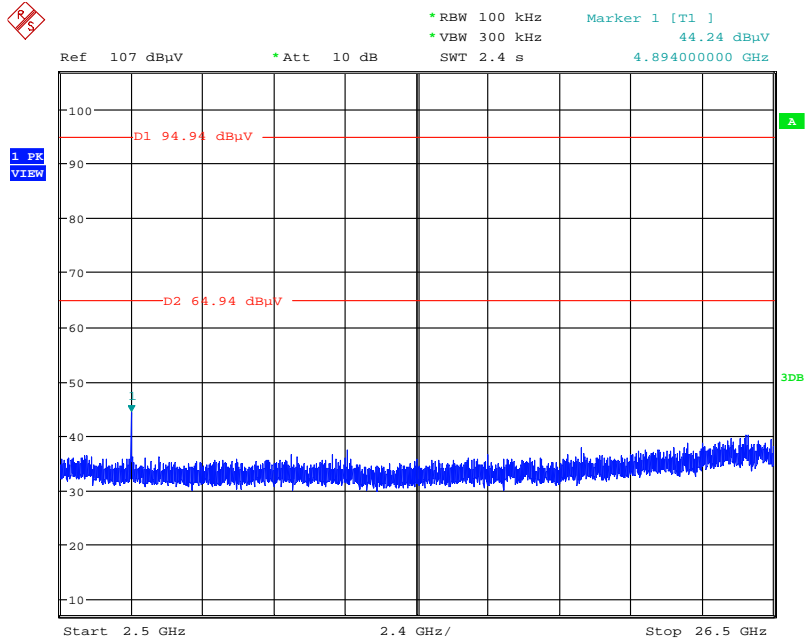

Date: 24.JAN.2014 11:30:07

4. THE 5G BAND 4 (5725~5850MHZ) TEST RESULT

4.1. AC Power Line Conducted Emissions Measurement

4.1.1. Limit

For this product which is designed to be connected to the AC power line, the radio frequency voltage that is conducted back onto the AC power line on any frequency or frequencies within the band 150 kHz to 30 MHz shall not exceed below limits table.

Frequency (MHz)	QP Limit (dBuV)	AV Limit (dBuV)
0.15~0.5	66~56	56~46
0.5~5	56	46
5~30	60	50

4.1.2. Measuring Instruments and Setting

Please refer to section 6 of equipments list in this report. The following table is the setting of the receiver.

Receiver Parameters	Setting
Attenuation	10 dB
Start Frequency	0.15 MHz
Stop Frequency	30 MHz
IF Bandwidth	9 kHz

4.1.3. Test Procedures

1. Configure the EUT according to ANSI C63.10. The EUT or host of EUT has to be placed 0.4 meter far from the conducting wall of the shielding room and at least 80 centimeters from any other grounded conducting surface.
2. Connect EUT or host of EUT to the power mains through a line impedance stabilization network (LISN).
3. All the support units are connected to the other LISNs. The LISN should provide 50uH/50ohms coupling impedance.
4. The frequency range from 150 kHz to 30 MHz was searched.
5. Set the test-receiver system to Peak Detect Function and Specified Bandwidth with Maximum Hold Mode.
6. The measurement has to be done between each power line and ground at the power terminal.

4.1.4. Test Setup Layout

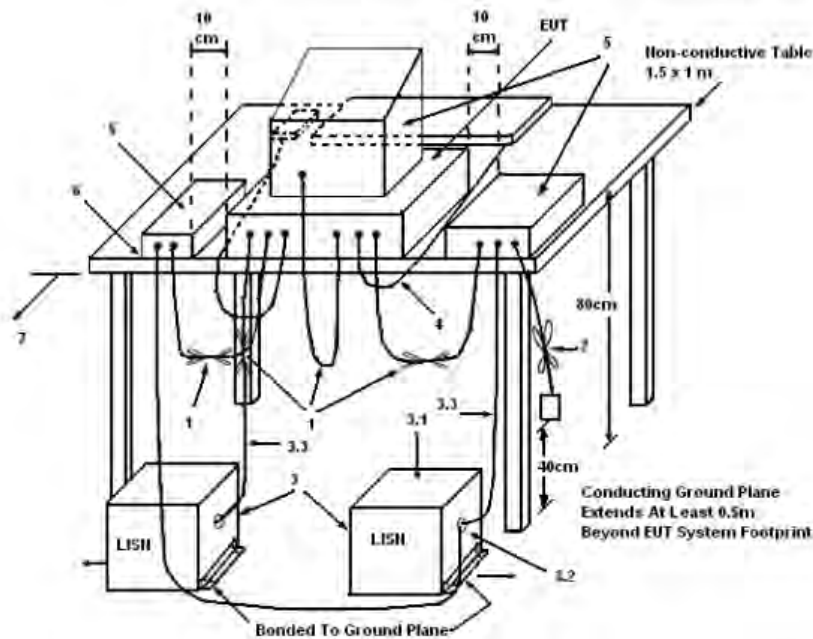

LEGEND:

1. Interconnecting cables that hang closer than 40 cm to the ground plane shall be folded back and forth in the center forming a bundle 30 to 40 cm long.
2. I/O cables that are not connected to a peripheral shall be bundled in the center. The end of the cable may be terminated, if required, using the correct terminating impedance. The overall length shall not exceed 1 m.
3. EUT connected to one LISN. Unused LISN measuring port connectors shall be terminated in 50 Ω. LISN can be placed on top of, or immediately beneath, reference ground plane.
4. All other equipment powered from additional LISN(s).
5. Multiple outlet strip can be used for multiple power cords of non-EUT equipment.
6. LISN at least 80 cm from nearest part of EUT chassis.
7. Cables of hand-operated devices, such as keyboards, mice, etc., shall be placed as for normal use.
8. Non-EUT components of EUT system being tested.
9. Rear of EUT, including peripherals, shall all be aligned and flush with rear of tabletop.
10. Rear of tabletop shall be 40 cm removed from a vertical conducting plane that is bonded to the ground plane.

4.1.5. Test Deviation

There is no deviation with the original standard.

4.1.6. EUT Operation during Test

The EUT was placed on the test table and programmed in normal function.

4.1.7. Results of AC Power Line Conducted Emissions Measurement

Temperature	24°C	Humidity	51%
Test Engineer	Justin Chiu	Phase	Line
Configuration	CTX		

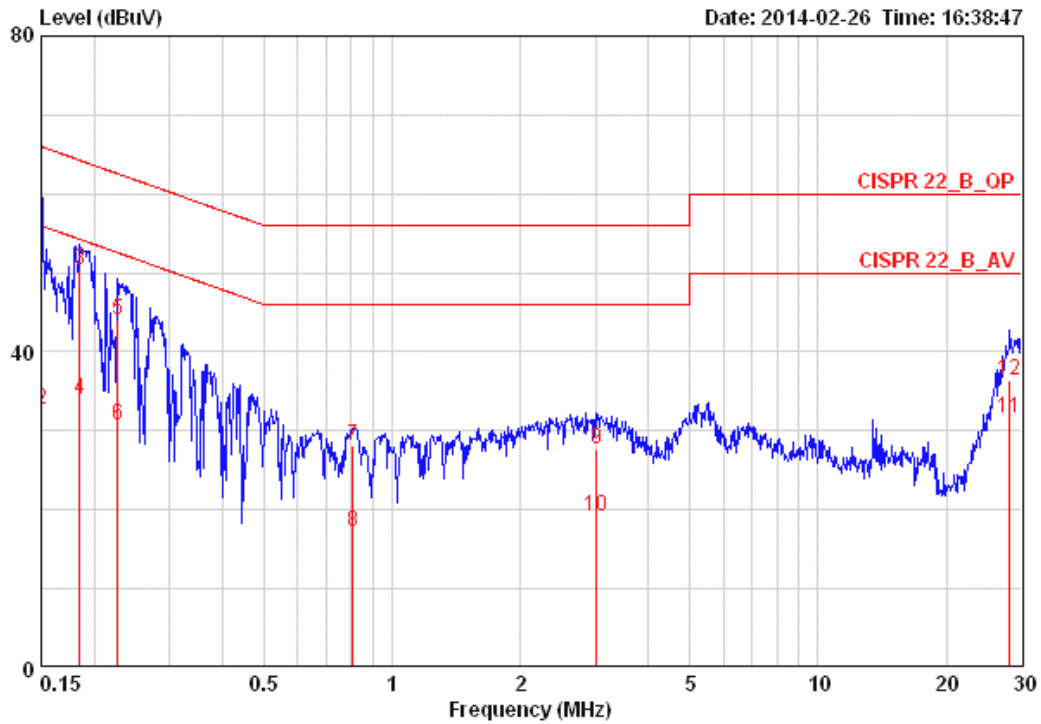

	Freq	Level	Over	Limit	LISN	Read	Cable		
	MHz	dBuV	Limit	Line	Factor	Level	Loss	Pol/Phase	Remark
			dB	dBuV	dB	dBuV	dB		
1 @	0.15000	52.97	-13.03	66.00	0.15	52.66	0.16	LINE	QP
2	0.15000	32.63	-23.37	56.00	0.15	32.32	0.16	LINE	AVERAGE
3	0.18443	50.34	-13.94	64.28	0.15	50.03	0.16	LINE	QP
4	0.18443	33.96	-20.32	54.28	0.15	33.65	0.16	LINE	AVERAGE
5	0.22676	44.14	-18.43	62.57	0.15	43.82	0.17	LINE	QP
6	0.22676	30.65	-21.92	52.57	0.15	30.33	0.17	LINE	AVERAGE
7	0.80876	28.08	-27.92	56.00	0.16	27.73	0.20	LINE	QP
8	0.80876	17.24	-28.76	46.00	0.16	16.89	0.20	LINE	AVERAGE
9	3.025	27.61	-28.39	56.00	0.24	27.09	0.28	LINE	QP
10	3.025	19.22	-26.78	46.00	0.24	18.70	0.28	LINE	AVERAGE
11	28.152	31.53	-18.47	50.00	0.85	30.07	0.60	LINE	AVERAGE
12	28.152	36.44	-23.56	60.00	0.85	34.98	0.60	LINE	QP

Note 1: The test was passed at the minimum margin that marked by the frame in the following data
 Note 2: The emission levels of other frequencies were very low against the limit.
 Note 3: Q.P. and AV. are abbreviations of quasi-peak and average individually.
 Note 4: Corrected Reading (dBμV) = LISN Factor + Cable Loss + Read Level = Level
 Note 5: Over Limit value = level - Limit value

Temperature	24°C	Humidity	51%
Test Engineer	Justin Chiu	Phase	Neutral
Configuration	CTX		

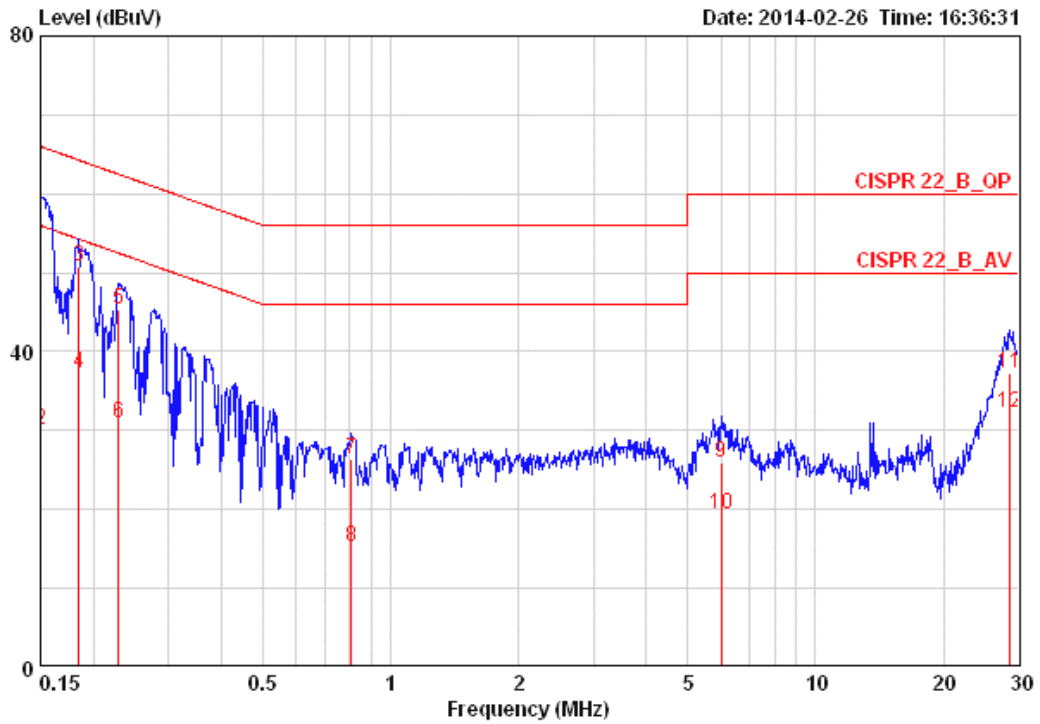

	Freq	Level	Over	Limit	LISN	Read	Cable		
	MHz	dBuV	Limit	Line	Factor	Level	Loss	Pol/Phase	Remark
			dB	dBuV	dB	dBuV	dB		
1	0.15000	53.01	-12.99	66.00	0.07	52.78	0.16	NEUTRAL	QP
2	0.15000	29.98	-26.02	56.00	0.07	29.75	0.16	NEUTRAL	AVERAGE
3	0.18443	50.79	-13.49	64.28	0.07	50.56	0.16	NEUTRAL	QP
4	0.18443	37.23	-17.05	54.28	0.07	37.00	0.16	NEUTRAL	AVERAGE
5	0.22918	45.25	-17.23	62.48	0.07	45.01	0.17	NEUTRAL	QP
6	0.22918	30.85	-21.63	52.48	0.07	30.61	0.17	NEUTRAL	AVERAGE
7	0.80876	26.34	-29.66	56.00	0.08	26.07	0.20	NEUTRAL	QP
8	0.80876	15.26	-30.74	46.00	0.08	14.99	0.20	NEUTRAL	AVERAGE
9	5.993	25.92	-34.08	60.00	0.18	25.41	0.34	NEUTRAL	QP
10	5.993	19.39	-30.61	50.00	0.18	18.88	0.34	NEUTRAL	AVERAGE
11	28.755	37.19	-22.81	60.00	0.81	35.77	0.61	NEUTRAL	QP
12	28.755	32.17	-17.83	50.00	0.81	30.75	0.61	NEUTRAL	AVERAGE

Note 1: The test was passed at the minimum margin that marked by the frame in the following data
 Note 2: The emission levels of other frequencies were very low against the limit.
 Note 3: Q.P. and AV. are abbreviations of quasi-peak and average individually.
 Note 4: Corrected Reading (dBµV) = LISN Factor + Cable Loss + Read Level = Level
 Note 5: Over Limit value = level - Limit value

4.2. Maximum Conducted Output Power Measurement

4.2.1. Limit

For systems using digital modulation in the 5725~5850MHz, the limit for peak output power is 30dBm. The limited has to be reduced by the amount in dB that the gain of the antenna exceed 6dBi. In case of point-to-point operation, the limit has to be reduced by 1dB for every 3dB that the directional gain of the antenna exceeds 6dBi.

4.2.2. Measuring Instruments and Setting

Please refer to section 6 of equipments list in this report. The following table is the setting of the power meter.

Power Meter Parameter	Setting
Detector	Average

4.2.3. Test Procedures

1. Test procedures refer KDB 662911 D01 v02r01 section 9.2.2 Measurement using a power meter (PM).
2. This procedure provides an alternative for determining the RMS output power using a broadband RF average power meter with a thermocouple detector.

4.2.4. Test Setup Layout

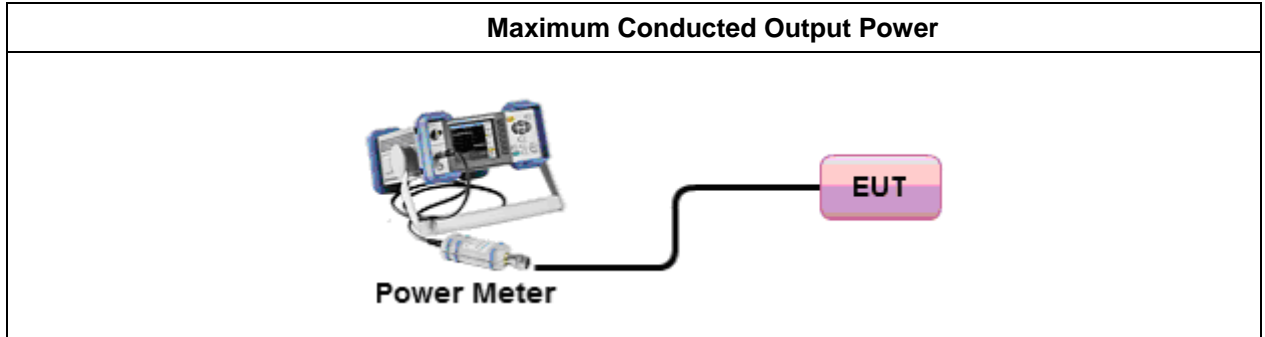

4.2.5. Test Deviation

There is no deviation with the original standard.

4.2.6. EUT Operation during Test

The EUT was programmed to be in continuously transmitting mode.

4.2.7. Test Result for Maximum Conducted Output Power

For Non-Beamforming

Test date	Feb. 13, 2014	Test Site No.	TH01-CB
Temperature	26°C	Humidity	63%
Test Engineer	Wen Chao	Configuration	802.11a
Duty Cycle	Ant. 1, 2, 3: 99.04% Ant. 1+2+3, CDD: 98.80%		

Configuration IEEE 802.11a

<Ant. 1>

Channel	Frequency	Conducted Power (dBm)	Antenna Gain (dBi)	Max. Limit (dBm)	Result
149	5745 MHz	22.27	5.65	30.00	Complies
157	5785 MHz	22.30	4.93	30.00	Complies
165	5825 MHz	22.30	4.18	30.00	Complies

<Ant. 2>

Channel	Frequency	Conducted Power (dBm)	Antenna Gain (dBi)	Max. Limit (dBm)	Result
149	5745 MHz	20.73	4.38	30.00	Complies
157	5785 MHz	20.73	3.78	30.00	Complies
165	5825 MHz	20.72	3.69	30.00	Complies

<Ant. 3>

Channel	Frequency	Conducted Power (dBm)	Antenna Gain (dBi)	Max. Limit (dBm)	Result
149	5745 MHz	22.38	5.53	30.00	Complies
157	5785 MHz	22.26	4.70	30.00	Complies
165	5825 MHz	22.47	5.03	30.00	Complies

<Ant. 1+2+3, CDD>

Channel	Frequency	Conducted Power (dBm)				Antenna Gain (dBi)	Max. Limit (dBm)	Result
		Ant. 1	Ant. 2	Ant. 3	Total			
149	5745 MHz	22.05	20.46	21.98	26.38	5.65	30.00	Complies
157	5785 MHz	21.96	20.43	21.87	26.30	4.93	30.00	Complies
165	5825 MHz	21.98	20.49	22.09	26.40	5.03	30.00	Complies

Test date	Feb. 13, 2014	Test Site No.	TH01-CB
Temperature	26°C	Humidity	63%
Test Engineer	Wen Chao	Configuration	802.11ac 20MHz
Duty Cycle	Ant. 1, 2: 98.72% Ant. 3: 98.87% Nss1MCS0, Ant. 1+2+3, CDD: 98.98% Nss2MCS0, Ant. 1+2+3, CDD: 96.29% Nss3MCS0, Ant. 1+2+3, SDM: 95.51%		

Configuration IEEE 802.11ac 20MHz

<Nss1MCS0, Ant. 1>

Channel	Frequency	Conducted Power (dBm)	Antenna Gain (dBi)	Max. Limit (dBm)	Result
149	5745 MHz	22.28	5.65	30.00	Complies
157	5785 MHz	22.24	4.93	30.00	Complies
165	5825 MHz	22.18	4.18	30.00	Complies

<Nss1MCS0, Ant. 2>

Channel	Frequency	Conducted Power (dBm)	Antenna Gain (dBi)	Max. Limit (dBm)	Result
149	5745 MHz	20.83	4.38	30.00	Complies
157	5785 MHz	20.58	3.78	30.00	Complies
165	5825 MHz	20.80	3.69	30.00	Complies

<Nss1MCS0, Ant. 3>

Channel	Frequency	Conducted Power (dBm)	Antenna Gain (dBi)	Max. Limit (dBm)	Result
149	5745 MHz	22.34	5.53	30.00	Complies
157	5785 MHz	22.32	4.70	30.00	Complies
165	5825 MHz	22.33	5.03	30.00	Complies

<Nss1MCS0, Ant. 1+2+3, CDD>

Channel	Frequency	Conducted Power (dBm)				Antenna Gain (dBi)	Max. Limit (dBm)	Result
		Ant. 1	Ant. 2	Ant. 3	Total			
149	5745 MHz	22.06	20.15	21.96	26.29	5.65	30.00	Complies
157	5785 MHz	21.95	20.33	21.91	26.27	4.93	30.00	Complies
165	5825 MHz	22.06	20.23	21.93	26.29	5.03	30.00	Complies

<Nss2MCS0, Ant. 1+2+3, CDD>

Channel	Frequency	Conducted Power (dBm)				Antenna Gain (dBi)	Max. Limit (dBm)	Result
		Ant. 1	Ant. 2	Ant. 3	Total			
149	5745 MHz	22.02	20.08	21.69	26.27	5.65	30.00	Complies
157	5785 MHz	21.94	20.02	21.71	26.23	4.93	30.00	Complies
165	5825 MHz	21.99	20.07	21.86	26.32	5.03	30.00	Complies

<Nss3MCS0, Ant. 1+2+3, SDM>

Channel	Frequency	Conducted Power (dBm)				Directional Gain (dBi)	Max. Limit (dBm)	Result
		Ant. 1	Ant. 2	Ant. 3	Total			
149	5745 MHz	24.45	23.16	23.75	28.79	3.32	30.00	Complies
157	5785 MHz	24.14	22.90	23.78	28.61	2.67	30.00	Complies
165	5825 MHz	24.19	22.89	23.67	28.59	2.46	30.00	Complies

Test date	Feb. 13, 2014	Test Site No.	TH01-CB
Temperature	26°C	Humidity	63%
Test Engineer	Wen Chao	Configuration	802.11ac 40MHz
Duty Cycle	Ant. 1: 97.46% Ant. 2, 3: 97.95% Nss1MCS0, Ant. 1+2+3, CDD: 97.95% Nss2MCS0, Ant. 1+2+3, CDD: 96.19% Nss3MCS0, Ant. 1+2+3, SDM: 92.19%		

Configuration IEEE 802.11ac 40MHz

<Nss1MCS0, Ant. 1>

Channel	Frequency	Conducted Power (dBm)	Antenna Gain (dBi)	Max. Limit (dBm)	Result
151	5755 MHz	21.44	5.79	30.00	Complies
159	5795 MHz	21.43	5.12	30.00	Complies

<Nss1MCS0, Ant. 2>

Channel	Frequency	Conducted Power (dBm)	Antenna Gain (dBi)	Max. Limit (dBm)	Result
151	5755 MHz	19.95	5.06	30.00	Complies
159	5795 MHz	19.97	3.92	30.00	Complies

<Nss1MCS0, Ant. 3>

Channel	Frequency	Conducted Power (dBm)	Antenna Gain (dBi)	Max. Limit (dBm)	Result
151	5755 MHz	21.13	5.40	30.00	Complies
159	5795 MHz	21.02	5.20	30.00	Complies

<Nss1MCS0, Ant. 1+2+3, CDD>

Channel	Frequency	Conducted Power (dBm)				Antenna Gain (dBi)	Max. Limit (dBm)	Result
		Ant. 1	Ant. 2	Ant. 3	Total			
151	5755 MHz	21.02	19.65	20.68	25.35	5.79	30.00	Complies
159	5795 MHz	21.05	19.63	20.82	25.40	5.20	30.00	Complies

<Nss2MCS0, Ant. 1+2+3, CDD>

Channel	Frequency	Conducted Power (dBm)				Antenna Gain	Max. Limit (dBm)	Result
		Ant. 1	Ant. 2	Ant. 3	Total			
151	5755 MHz	21.12	19.51	20.67	25.43	5.79	30.00	Complies
159	5795 MHz	20.92	19.49	20.82	25.40	5.20	30.00	Complies

<Nss3MCS0, Ant. 1+2+3, SDM>

Channel	Frequency	Conducted Power (dBm)				Directional Gain (dBi)	Max. Limit (dBm)	Result
		Ant. 1	Ant. 2	Ant. 3	Total			
151	5755 MHz	22.71	21.18	22.82	27.42	3.62	30.00	Complies
159	5795 MHz	23.20	21.74	23.06	27.84	2.95	30.00	Complies

Test date	Feb. 13, 2014	Test Site No.	TH01-CB
Temperature	26°C	Humidity	63%
Test Engineer	Wen Chao	Configuration	802.11ac 80MHz
Duty Cycle	Ant. 1: 95.91% Ant. 2, 3: 95.87% Nss1MCS0, Ant. 1+2+3, CDD: 95.87% Nss2MCS0, Ant. 1+2+3, CDD: 91.48% Nss3MCS0, Ant. 1+2+3, SDM: 89.09%		

Configuration IEEE 802.11ac 80MHz

<Nss1MCS0, Ant. 1>

Channel	Frequency	Conducted Power (dBm)	Antenna Gain (dBi)	Max. Limit (dBm)	Result
155	5775 MHz	21.62	5.19	30.00	Complies

<Nss1MCS0, Ant. 2>

Channel	Frequency	Conducted Power (dBm)	Antenna Gain (dBi)	Max. Limit (dBm)	Result
155	5775 MHz	20.80	4.42	30.00	Complies

<Nss1MCS0, Ant. 3>

Channel	Frequency	Conducted Power (dBm)	Antenna Gain (dBi)	Max. Limit (dBm)	Result
155	5775 MHz	21.44	5.09	30.00	Complies

<Nss1MCS0, Ant. 1+2+3, CDD>

Channel	Frequency	Conducted Power (dBm)				Antenna Gain (dBi)	Max. Limit (dBm)	Result
		Ant. 1	Ant. 2	Ant. 3	Total			
155	5775 MHz	21.23	20.28	21.21	25.88	5.19	30.00	Complies

<Nss2MCS0, Ant. 1+2+3, CDD>

Channel	Frequency	Conducted Power (dBm)				Antenna Gain (dBi)	Max. Limit (dBm)	Result
		Ant. 1	Ant. 2	Ant. 3	Total			
155	5775 MHz	21.26	19.98	20.87	25.90	5.19	30.00	Complies

<Nss3MCS0, Ant. 1+2+3, SDM>

Channel	Frequency	Conducted Power (dBm)				Directional Gain (dBi)	Max. Limit (dBm)	Result
		Ant. 1	Ant. 2	Ant. 3	Total			
155	5775 MHz	21.05	20.15	21.14	26.08	3.16	30.00	Complies

For Beamforming

Test date	Feb. 13, 2014	Test Site No.	TH01-CB
Temperature	26°C	Humidity	63%
Test Engineer	Magic Lai	Configuration	802.11ac 20MHz
Duty Cycle	Nss1MCS0, Ant. 1+2+3, CDD: 98.97% Nss2MCS0, Ant. 1+2+3, CDD: 98.20%		

Configuration IEEE 802.11ac 20MHz

<Nss1MCS0, Ant. 1+2+3, CDD>

Channel	Frequency	Conducted Power (dBm)				Directional Gain (dBi)	Max. Limit (dBm)	Result
		Ant. 1	Ant. 2	Ant. 3	Total			
149	5745 MHz	22.32	20.65	21.96	26.51	7.25	28.75	Complies
157	5785 MHz	22.09	20.25	22.05	26.36	6.80	29.20	Complies
165	5825 MHz	22.24	20.52	21.82	26.40	6.68	29.32	Complies

<Nss2MCS0, Ant. 1+2+3, CDD>

Channel	Frequency	Conducted Power (dBm)				Directional Gain (dBi)	Max. Limit (dBm)	Result
		Ant. 1	Ant. 2	Ant. 3	Total			
149	5745 MHz	22.62	20.99	21.13	26.50	6.24	29.76	Complies
157	5785 MHz	22.42	20.89	22.23	26.75	5.54	30.00	Complies
165	5825 MHz	22.42	20.76	22.02	26.64	5.30	30.00	Complies

Test date	Feb. 13, 2014	Test Site No.	TH01-CB
Temperature	26°C	Humidity	63%
Test Engineer	Magic Lai	Configuration	802.11ac 40MHz
Duty Cycle	Nss1MCS0, Ant. 1+2+3, CDD: 97.46% Nss2MCS0, Ant. 1+2+3, CDD: 98.15%		

Configuration IEEE 802.11ac 40MHz

<Nss1MCS0, Ant. 1+2+3, CDD>

Channel	Frequency	Conducted Power (dBm)				Directional Gain (dBi)	Max. Limit (dBm)	Result
		Ant. 1	Ant. 2	Ant. 3	Total			
151	5755 MHz	21.72	19.95	20.92	25.80	7.68	28.32	Complies
159	5795 MHz	21.33	19.78	21.13	25.68	7.07	28.93	Complies

<Nss2MCS0, Ant. 1+2+3, CDD>

Channel	Frequency	Conducted Power (dBm)				Directional Gain (dBi)	Max. Limit (dBm)	Result
		Ant. 1	Ant. 2	Ant. 3	Total			
151	5755 MHz	21.56	19.76	20.85	25.64	6.53	29.47	Complies
159	5795 MHz	21.42	19.65	20.82	25.54	5.79	30.00	Complies

Test date	Feb. 13, 2014	Test Site No.	TH01-CB
Temperature	26°C	Humidity	63%
Test Engineer	Magic Lai	Configuration	802.11ac 80MHz
Duty Cycle	Nss1MCS0, Ant. 1+2+3, CDD: 95.49% Nss2MCS0, Ant. 1+2+3, CDD: 96.38%		

Configuration IEEE 802.11ac 80MHz

<Nss1MCS0, Ant. 1+2+3, CDD>

Channel	Frequency	Conducted Power (dBm)				Directional Gain (dBi)	Max. Limit (dBm)	Result
		Ant. 1	Ant. 2	Ant. 3	Total			
155	5775 MHz	21.86	20.43	21.03	26.12	7.28	28.72	Complies

<Nss2MCS0, Ant. 1+2+3, CDD>

Channel	Frequency	Conducted Power (dBm)				Directional Gain (dBi)	Max. Limit (dBm)	Result
		Ant. 1	Ant. 2	Ant. 3	Total			
155	5775 MHz	21.62	20.48	20.92	25.96	6.04	29.96	Complies

4.3. Power Spectral Density Measurement

4.3.1. Limit

For digitally modulated systems, the power spectral density conducted from the intentional radiator to the antenna shall not be greater than 8 dBm in any 3 kHz band during any time interval of continuous transmission.

4.3.2. Measuring Instruments and Setting

Please refer to section 6 of equipments list in this report. The following table is the setting of Spectrum Analyzer.

Power Meter Parameter	Setting
Attenuation	Auto
Span Frequency	Set span to at least 1.5 times the OBW.
RBW	10 kHz
VBW	30 kHz
Detector	RMS
Trace	Average
Sweep Time	Auto
Trace Average	100 times

4.3.3. Test Procedures

1. The transmitter output (antenna port) was connected RF switch to the spectrum analyzer.
2. Test was performed in accordance with KDB 558074 D01 v03r01 for Compliance Testing of Digital Transmission Systems (DTS) Devices - Part 15, Subpart C => Method AVGPSD-2 (trace averaging across on and off times of the EUT transmissions, followed by duty cycle correction).
3. Multiple antenna systems was performed in accordance KDB 662911 D01 v02 in-Band Power Spectral Density (PSD) Measurements (a) Measure and sum the spectra across the outputs (bin-by-bin summing).
4. When measuring first spectral bin of output 1 is summed with that in the first spectral bin of output 2 and that from the first spectral bin of output 3 and so on up to the Nth output to obtain the value for the first frequency bin of the summed spectrum. The summed spectrum value for each of the other frequency bins is computed in the same way.

4.3.4. Test Setup Layout

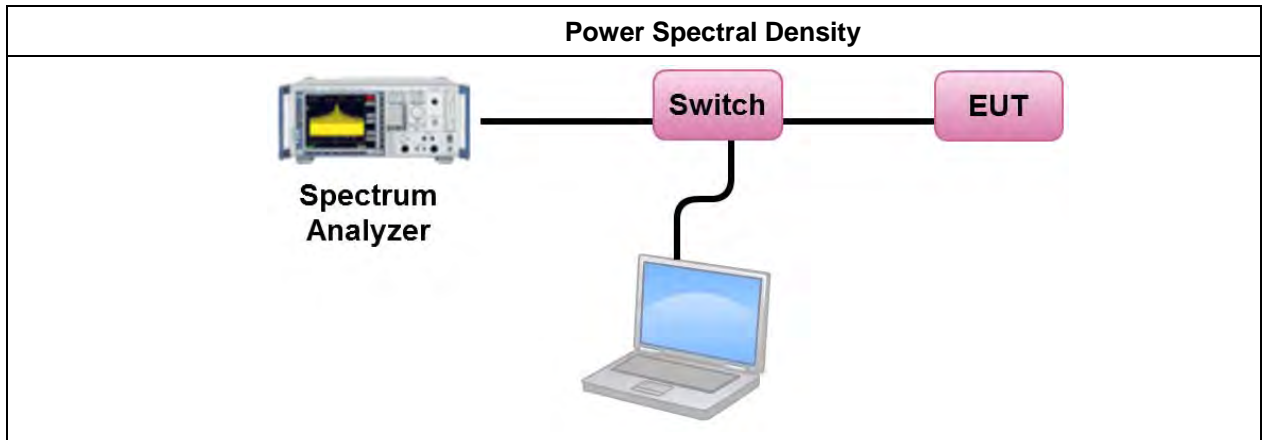

4.3.5. Test Deviation

There is no deviation with the original standard.

4.3.6. EUT Operation during Test

The EUT was programmed to be in continuously transmitting mode.

4.3.7. Test Result of Power Spectral Density

For Non-Beamforming

Test date	Feb. 13, 2014	Test Site No.	TH01-CB
Temperature	26°C	Humidity	63%
Test Engineer	Wen Chao	Configuration	802.11a
Duty Cycle	Ant. 1, 2, 3: 99.04% Ant. 1+2+3, CDD: 98.80%		

Configuration IEEE 802.11a

<Ant. 1>

Channel	Frequency	Total Power Density (dBm/10kHz)	Antenna Gain (dBi)	Max. Limit (dBm/10kHz)	Result
149	5745 MHz	-4.94	5.65	8.00	Complies
157	5785 MHz	-4.38	4.93	8.00	Complies
165	5825 MHz	-4.81	4.18	8.00	Complies

<Ant. 1+2+3, CDD>

Channel	Frequency	Total Power Density (dBm/10kHz)	Antenna Gain (dBi)	Max. Limit (dBm/10kHz)	Result
149	5745 MHz	-1.25	5.65	8.00	Complies
157	5785 MHz	-1.02	4.93	8.00	Complies
165	5825 MHz	-1.14	5.03	8.00	Complies

For Non-Beamforming

Power Density Plot on Configuration IEEE 802.11a / CH 149 / Ant. 1

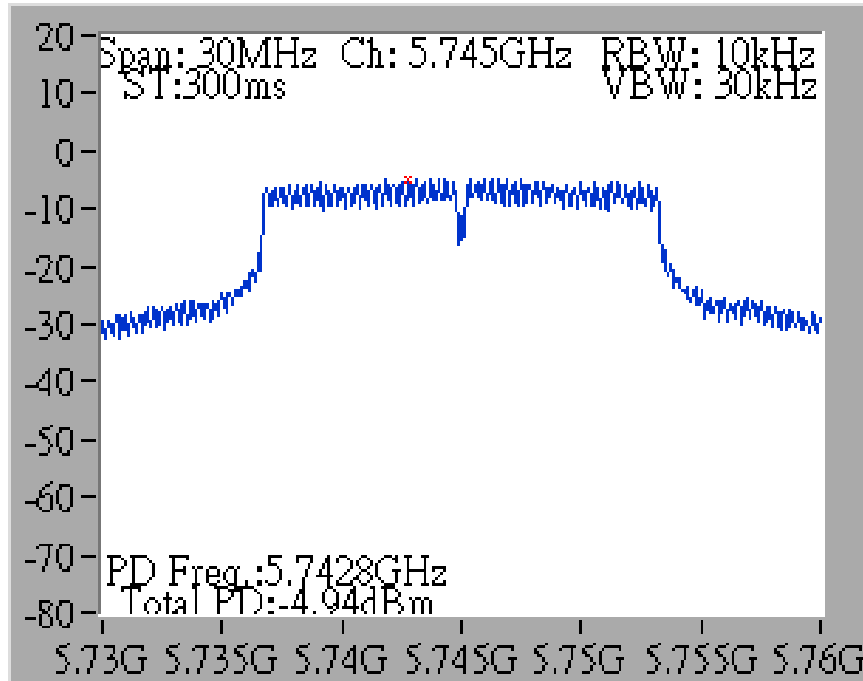

Power Density Plot on Configuration IEEE 802.11a / CH 157 / Ant. 1

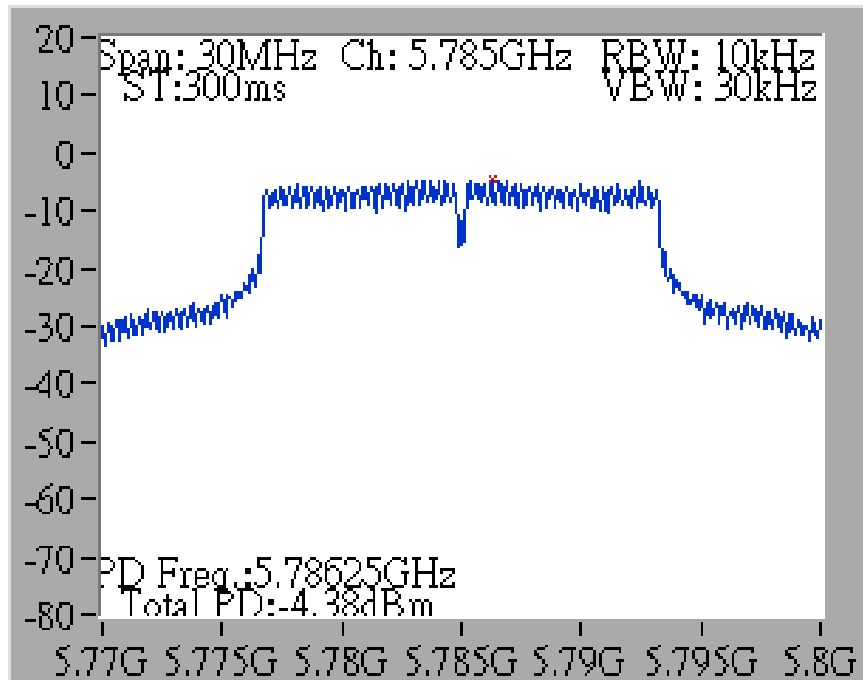

Power Density Plot on Configuration IEEE 802.11a / CH 165 / Ant. 1

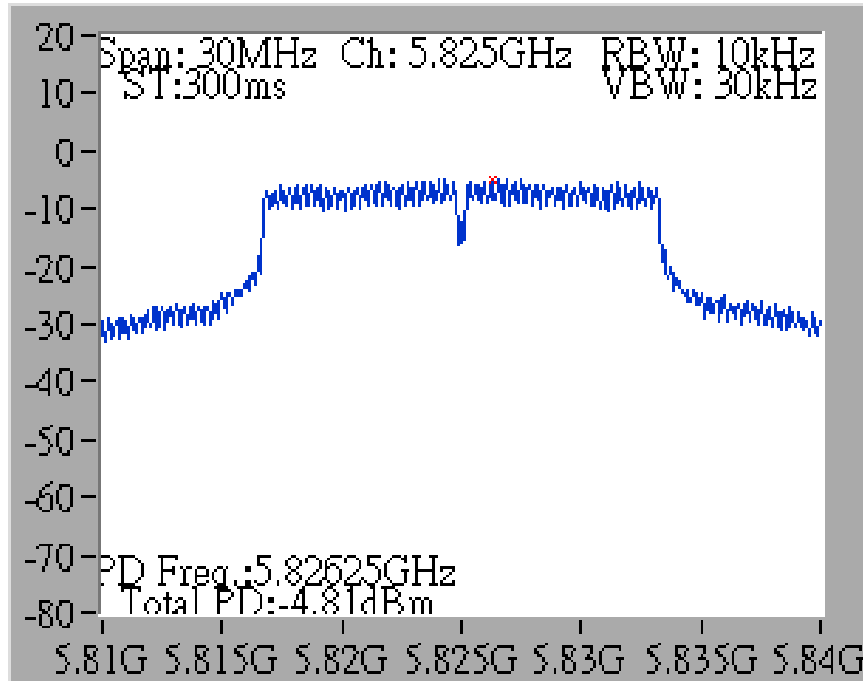

Power Density Plot on Configuration IEEE 802.11a / CH 149 / Ant. 1+2+3

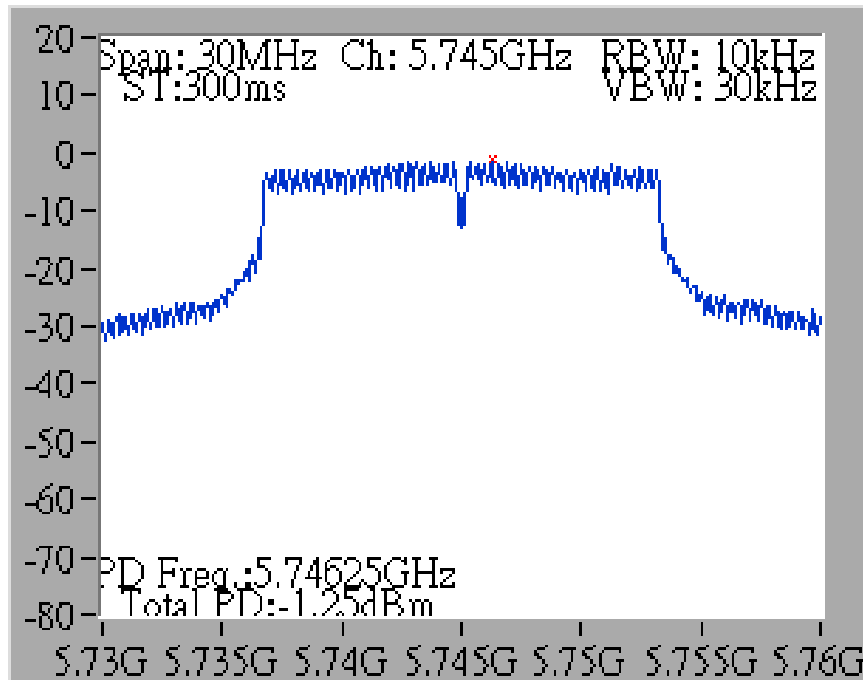

Power Density Plot on Configuration IEEE 802.11a / CH 157 / Ant. 1+2+3

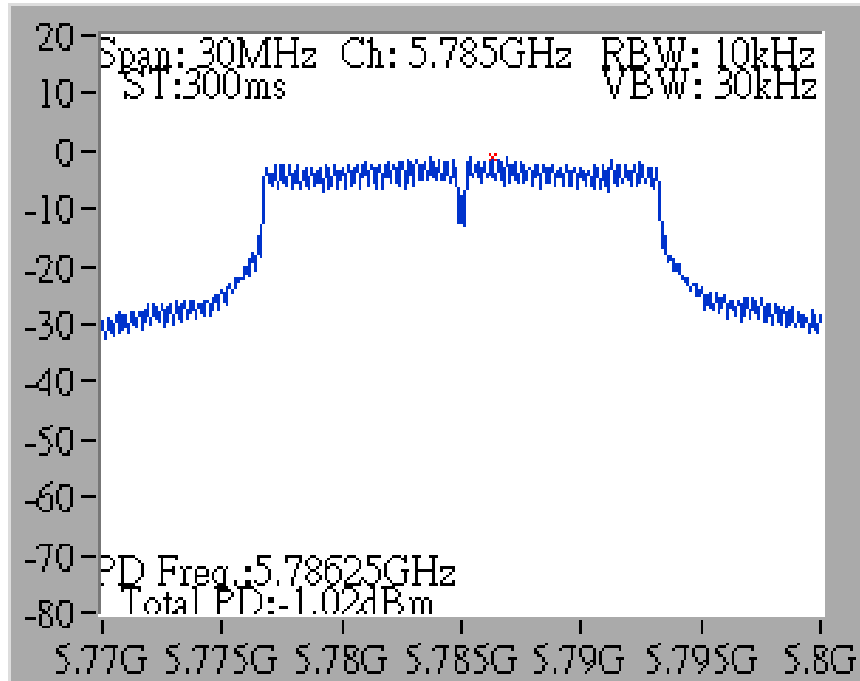

Power Density Plot on Configuration IEEE 802.11a / CH 165 / Ant. 1+2+3

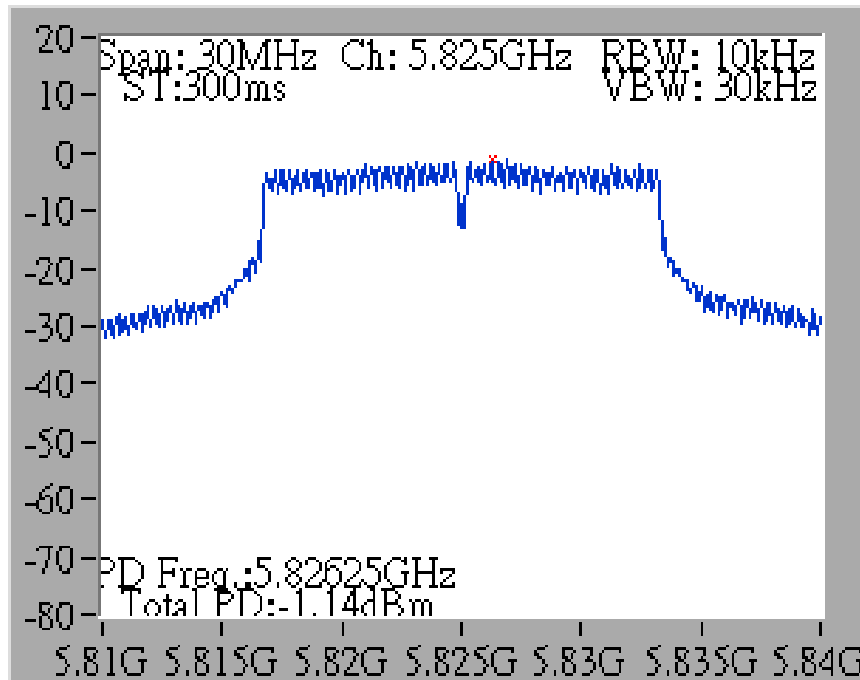

Test date	Feb. 13, 2014	Test Site No.	TH01-CB
Temperature	26°C	Humidity	63%
Test Engineer	Wen Chao	Configuration	802.11ac 20MHz
Duty Cycle	Nss1MCS0, Ant. 1+2+3, CDD: 98.98% Nss2MCS0, Ant. 1+2+3, CDD: 96.29%		

Configuration IEEE 802.11ac 20MHz

<Nss1MCS0, Ant. 1>

Channel	Frequency	Total Power Density (dBm/10kHz)	Antenna Gain (dBi)	Max. Limit (dBm/10kHz)	Result
149	5745 MHz	-5.38	5.65	8.00	Complies
157	5785 MHz	-5.05	4.93	8.00	Complies
165	5825 MHz	-5.46	4.18	8.00	Complies

<Nss1MCS0, Ant. 1+2+3>

Channel	Frequency	Total Power Density (dBm/10kHz)	Antenna Gain (dBi)	Max. Limit (dBm/10kHz)	Result
149	5745 MHz	-2.08	4.38	8.00	Complies
157	5785 MHz	-1.74	3.78	8.00	Complies
165	5825 MHz	-1.94	3.69	8.00	Complies

<Nss2MCS0, Ant. 1+2+3>

Channel	Frequency	Total Power Density (dBm/10kHz)	Antenna Gain (dBi)	Max. Limit (dBm/10kHz)	Result
149	5745 MHz	-1.85	4.38	8.00	Complies
157	5785 MHz	-1.46	3.78	8.00	Complies
165	5825 MHz	-1.83	3.69	8.00	Complies

Power Density Plot on Configuration IEEE 802.11ac 20MHz Nss1MCS0 / CH 149 / Ant. 1

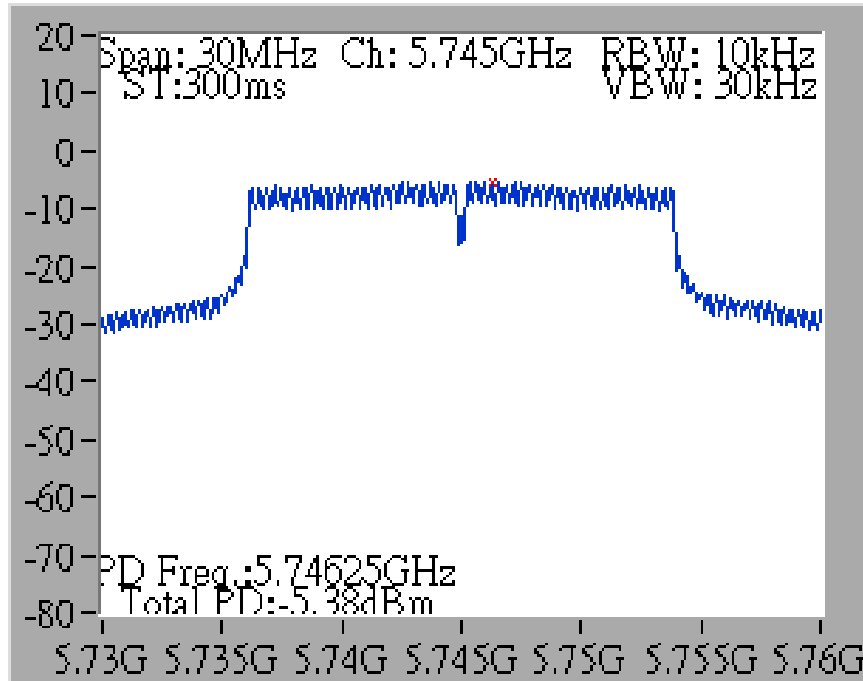

Power Density Plot on Configuration IEEE 802.11ac 20MHz Nss1MCS0 / CH 157 / Ant. 1

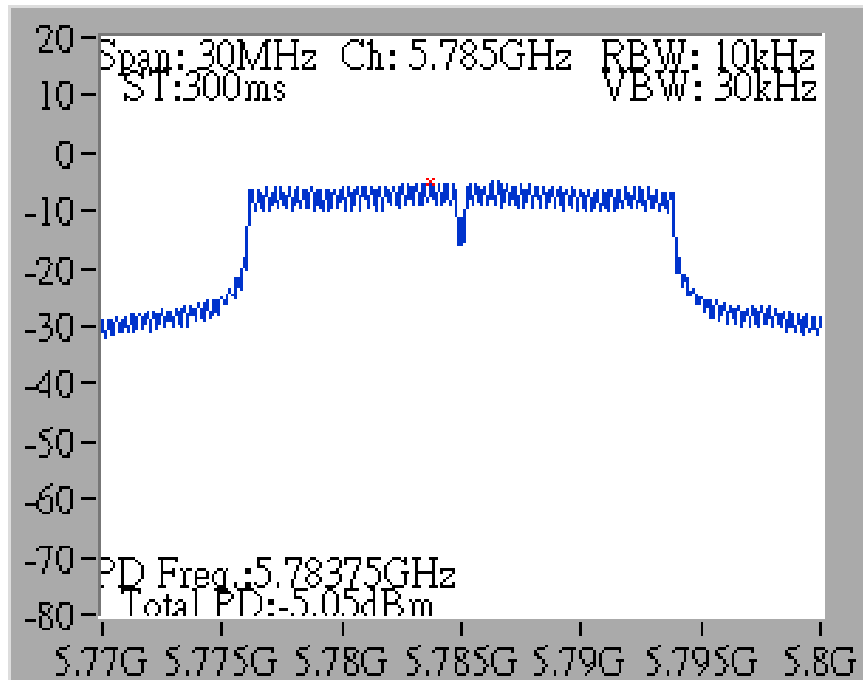

Power Density Plot on Configuration IEEE 802.11ac 20MHz Nss1MCS0 / CH 165 / Ant. 1

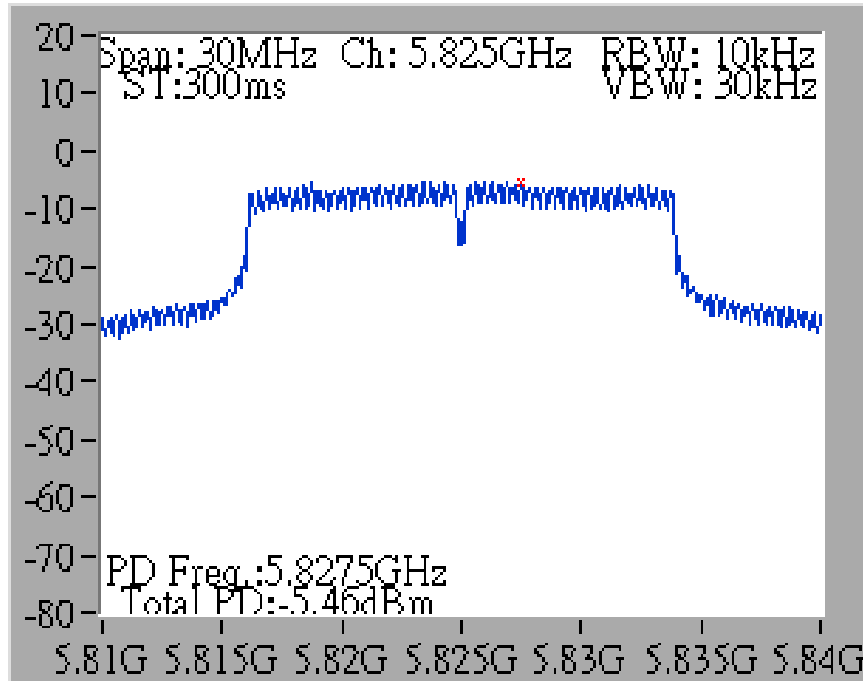

Power Density Plot on Configuration IEEE 802.11ac 20MHz Nss1MCS0 / CH 149 / Ant. 1+2+3

