

Wireless Device Over the Air Performance Data Summary

REPORT NO. : OQ202415
MANUFACTURER : Ningbo Sunrise Elc Technology Co., Ltd.
BRAND NAME : Vantiva
MODEL NAME : Murphy Antenna
ANTENNA TYPE : Stamped Metal
DEVICE RECEIVING DATE : Oct. 24, 2022
TEST DATE(S) : Oct. 25, 2022 ~ Oct. 26, 2022

Reviewed by:

A handwritten signature in black ink that reads 'Jinshan Zheng'.

Jinshan Zheng / Senior Engineer

Approved by:

A handwritten signature in black ink that reads 'Johnny Chen'.

Johnny Chen / Manager

Sporton International Inc. (Shenzhen)

**1/F, 2/F, Bldg 5, Shiling Industrial Zone, Xinwei Village, Xili, Nanshan, Shenzhen, 518055
People's Republic of China**



Table of Contents

Revision History ----- 3

1. Administration Data ----- 4

 1.1 Testing Laboratory----- 4

2. Test Equipment List ----- 5

3. Summary of WLAN Antenna Gain Test Results ----- 6

4. FS Pattern----- 8

5. EUT Photographs -----32

Appendix A. Test Results of Detailed raw data -----35



1. Administration Data

1.1 Testing Laboratory

Test Site	Sporton International Inc. (Shenzhen)
Test Site Location	1/F, 2/F, Bldg 5, Shiling Industrial Zone, Xinwei Village, Xili, Nanshan, Shenzhen, 518055, People's Republic of China TEL: +86-755-86379589 FAX: +86-755-86379595
Chamber	■ OTA01-SZ □ OTA02-SZ □ OTA03-SZ

■: Indicates the chamber(s) used in this data summary.

1.2 Manufacturer

Company Name	Ningbo Sunrise Elc Technology Co., Ltd.
Address	No. 1511, LuAn Road, Changhe Town, Cixi City, Zhejiang Province, China



2. Test Equipment List

Name	Manufacturer	Type/Model	Serial Number	Calibration	
				Last Cal.	Due Date
Network Analyzer	R&S	ZVB8	100106	2022/10/17	2023/10/16
Switch Control Mainframe	Agilent	3499A	MY42005451	NCR	NCR
Diagonal Dual Polarized Horn	ETS-Lindgren	3164-08	00102954	NCR	NCR
Multi-Devices Controller	ETS-Lindgren	2090-OPT1	00108147	NCR	NCR
Medium Duty Holder	ETS-Lindgren	2015	N/A	NCR	NCR

Note: Antenna gain was measured in the anechoic chamber (Measurement System: ETS-Lindgren AMS-8500, SW Version: EMQuest 100 V1.15).



3. Summary of WLAN Antenna Gain Test Results

Remark: For detailed raw data please refer to Appendix A.

Summary of 2.4GHz Test Results

Test Position	Free Space					
Antenna	2.4GHz Antenna 0			2.4GHz Antenna 1		
Frequency (MHz)	2412	2442	2462	2412	2442	2462
Peak Gain (dBi)	3.95	3.92	4.35	4.95	4.84	5.11

Test Position	Free Space					
Antenna	2.4GHz Antenna 2			2.4GHz Antenna 3		
Frequency (MHz)	2412	2442	2462	2412	2442	2462
Peak Gain (dBi)	3.91	3.68	4.10	3.33	3.14	3.53

Summary of 5GHz Test Results

Test Position	Free Space													
Antenna	5GHz Antenna 0													
Frequency (MHz)	5180	5220	5240	5260	5300	5320	5500	5580	5700	5745	5785	5825	5955	
Peak Gain (dBi)	3.82	3.95	3.94	3.51	3.80	3.44	3.09	3.08	3.22	2.82	3.08	2.83	2.94	

Test Position	Free Space													
Antenna	5GHz Antenna 1													
Frequency (MHz)	5180	5220	5240	5260	5300	5320	5500	5580	5700	5745	5785	5825	5955	
Peak Gain (dBi)	3.82	3.73	4.10	3.67	4.30	4.34	5.14	4.58	3.62	3.44	3.51	3.58	4.15	

Test Position	Free Space													
Antenna	5GHz Antenna 2													
Frequency (MHz)	5180	5220	5240	5260	5300	5320	5500	5580	5700	5745	5785	5825	5955	
Peak Gain (dBi)	3.00	2.51	2.59	2.61	3.73	3.66	4.82	4.44	4.16	4.51	4.34	4.32	3.99	

Test Position	Free Space													
Antenna	5GHz Antenna 3													
Frequency (MHz)	5180	5220	5240	5260	5300	5320	5500	5580	5700	5745	5785	5825	5955	
Peak Gain (dBi)	3.90	4.41	4.50	4.03	4.42	3.95	3.05	3.08	3.76	3.05	3.61	3.73	3.84	



Summary of 6GHz Test Results

Test Position	Free Space									
Antenna	6GHz Antenna 0									
Frequency (MHz)	6175	6415	6435	6475	6515	6535	6695	6875	6995	7115
Peak Gain (dBi)	2.94	1.88	2.23	2.01	2.29	2.44	3.89	4.11	4.29	4.14

Test Position	Free Space									
Antenna	6GHz Antenna 1									
Frequency (MHz)	6175	6415	6435	6475	6515	6535	6695	6875	6995	7115
Peak Gain (dBi)	4.65	4.55	4.83	4.34	4.45	4.52	5.05	4.85	4.92	4.23

Test Position	Free Space									
Antenna	6GHz Antenna 2									
Frequency (MHz)	6175	6415	6435	6475	6515	6535	6695	6875	6995	7115
Peak Gain (dBi)	3.86	2.55	3.22	2.98	2.99	2.98	3.40	3.63	4.53	3.49

Test Position	Free Space									
Antenna	6GHz Antenna 3									
Frequency (MHz)	6175	6415	6435	6475	6515	6535	6695	6875	6995	7115
Peak Gain (dBi)	5.02	3.31	3.20	3.46	3.09	3.91	3.96	5.25	4.79	5.20

4. FS Pattern

Note: Only the peak gain patterns of each Band were recorded as below:

2.4GHz Ant0

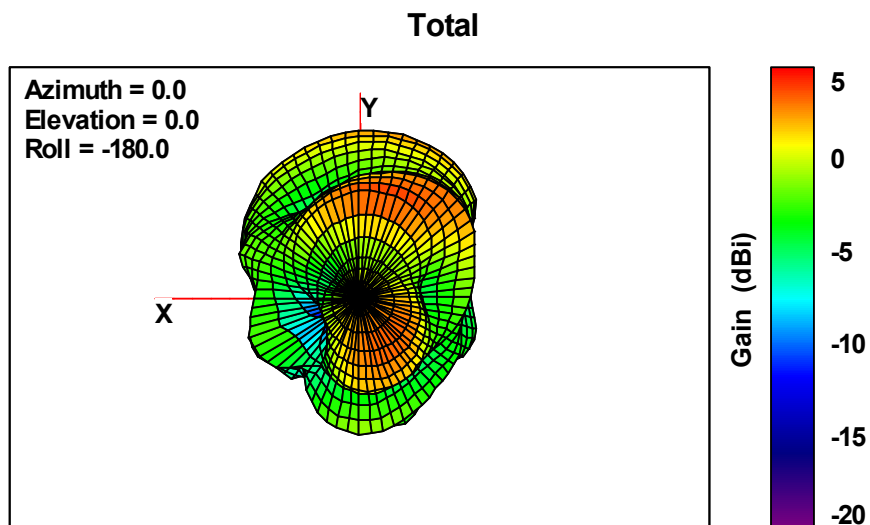
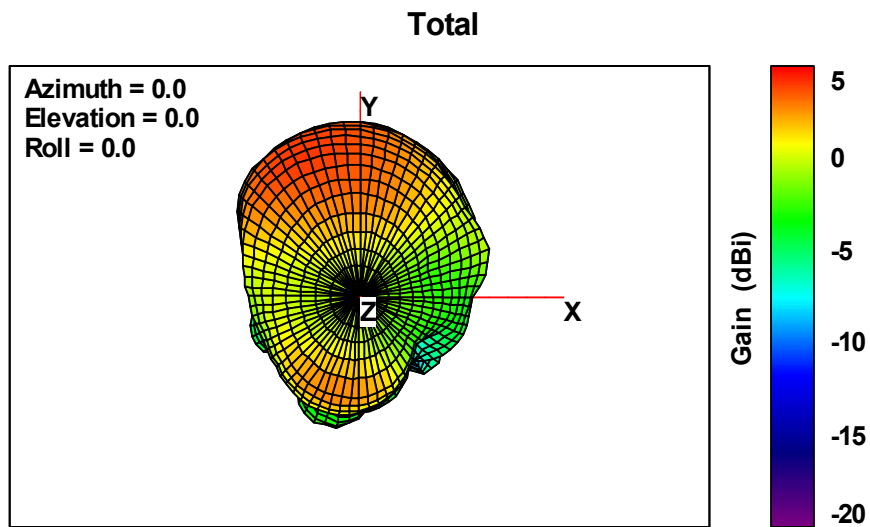

3D Free Space Gain Pattern

2.4GHz Ant1

Total

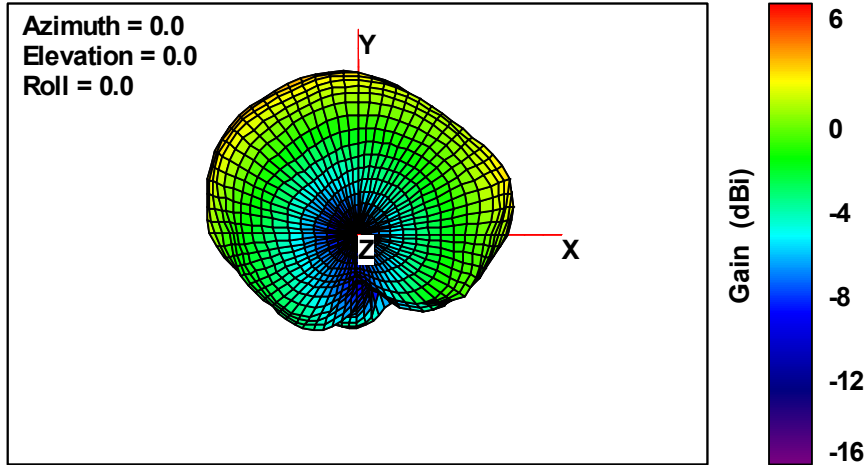

Total

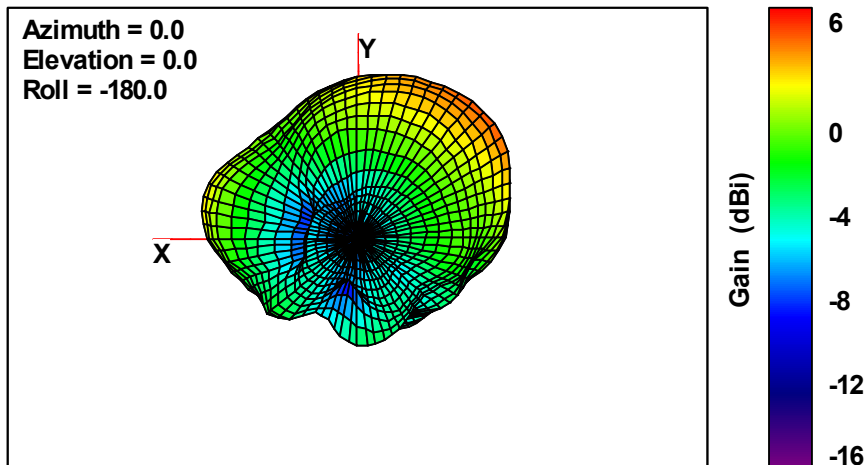

3D Free Space Gain Pattern

2.4GHz Ant2

Total

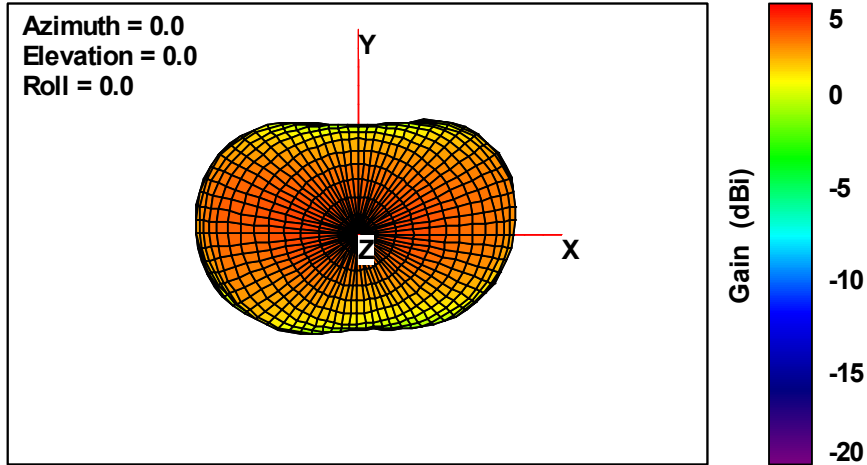

Total

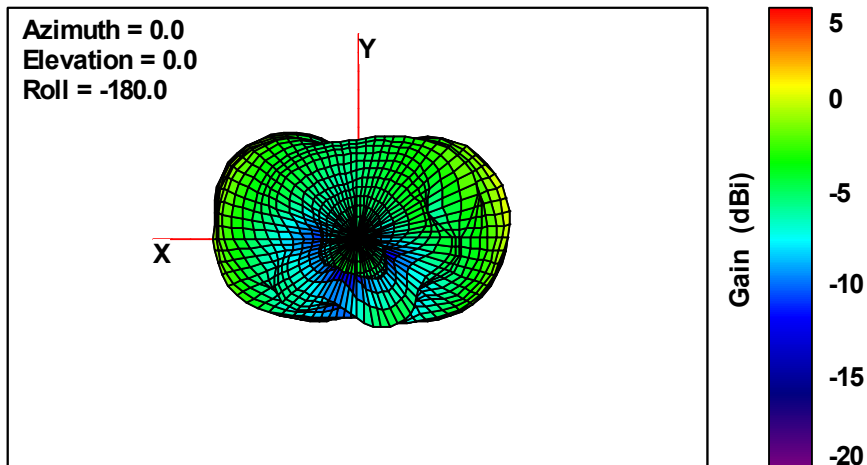

3D Free Space Gain Pattern

2.4GHz Ant3

Total

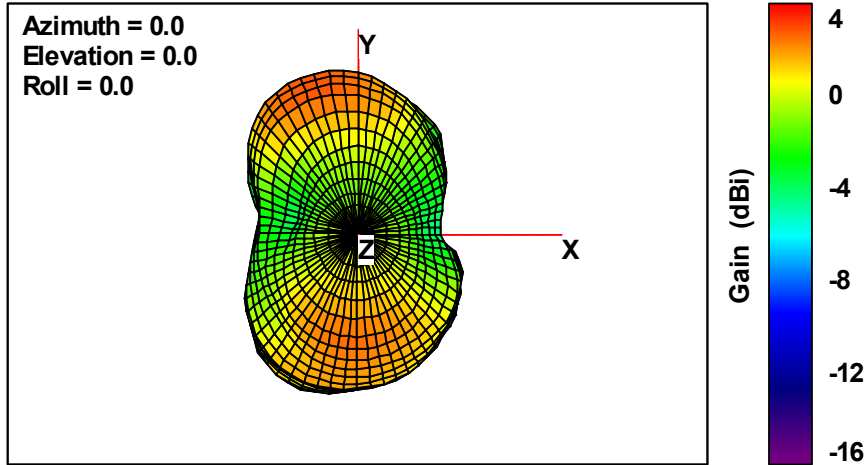

Total

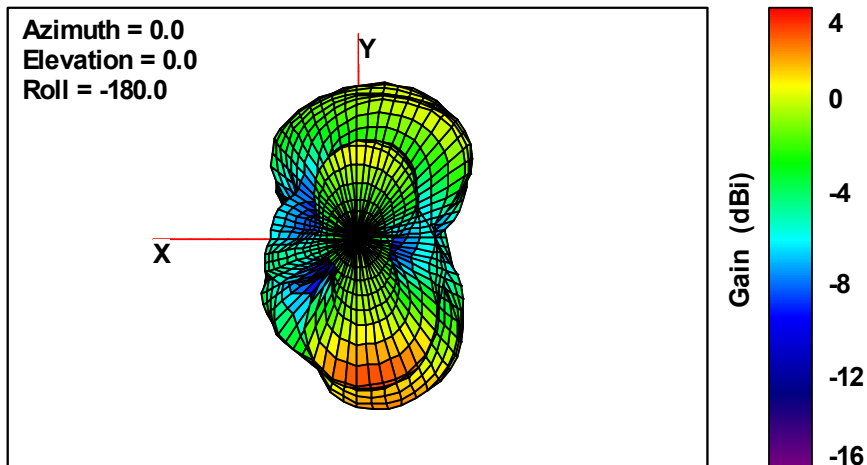

3D Free Space Gain Pattern

5.2GHz Ant0

Total

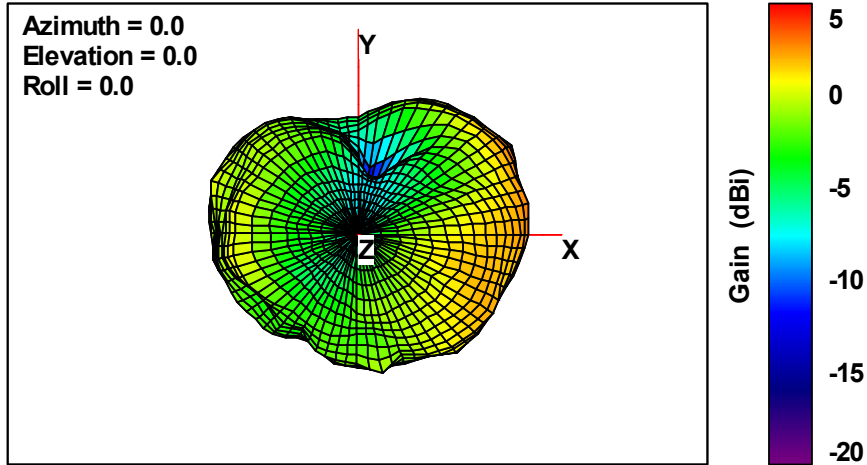

Total

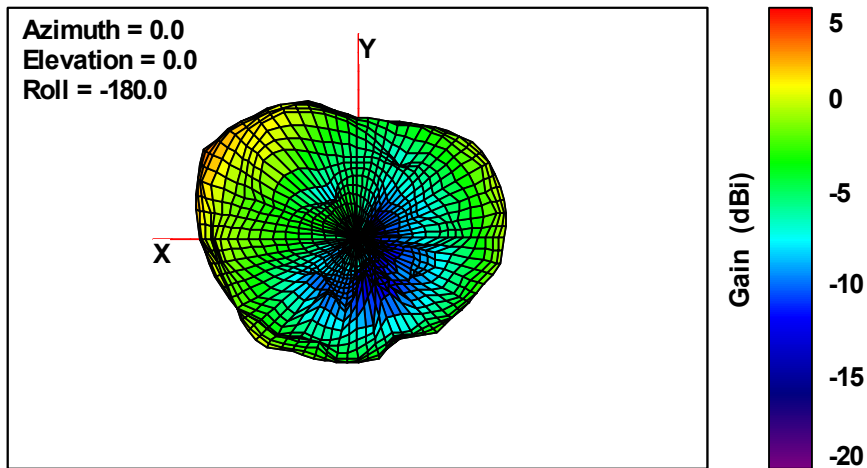

3D Free Space Gain Pattern

5.2GHz Ant1

Total

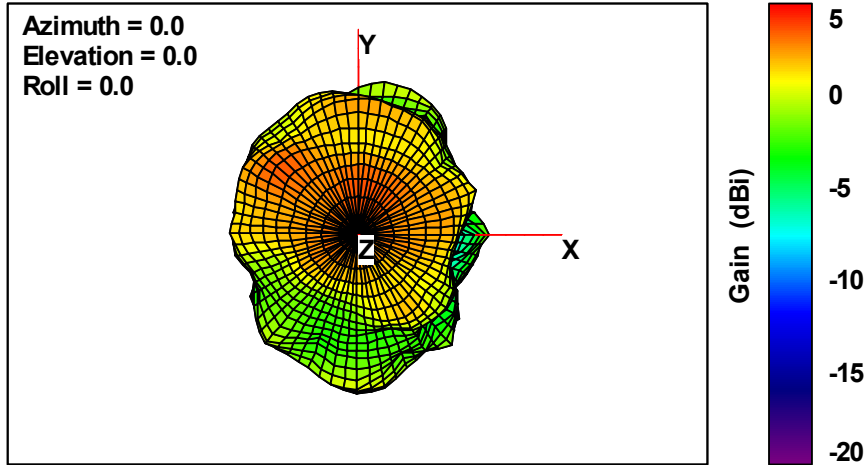

Total

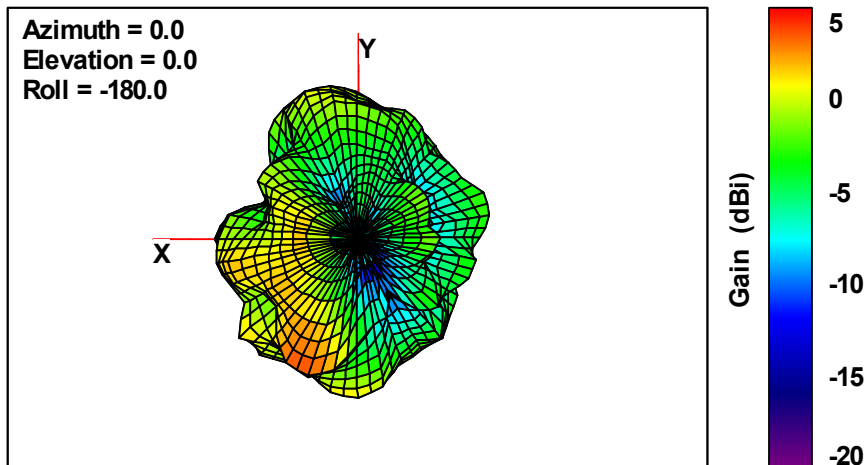

3D Free Space Gain Pattern

5.2GHz Ant2

Total

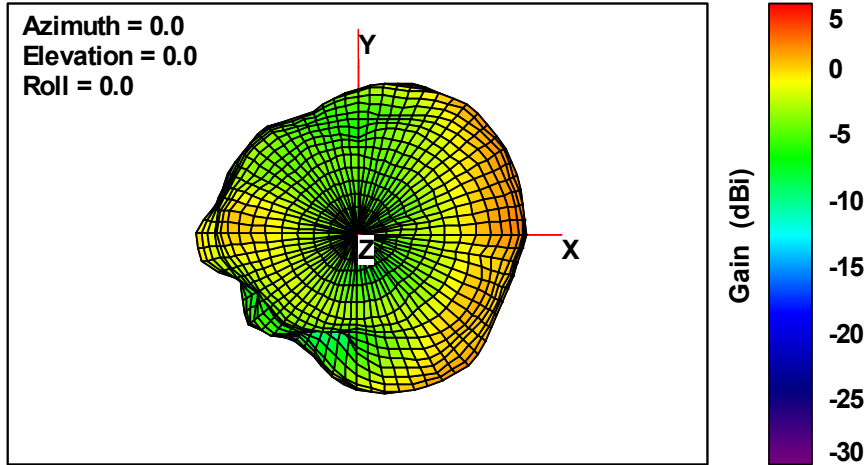

Total

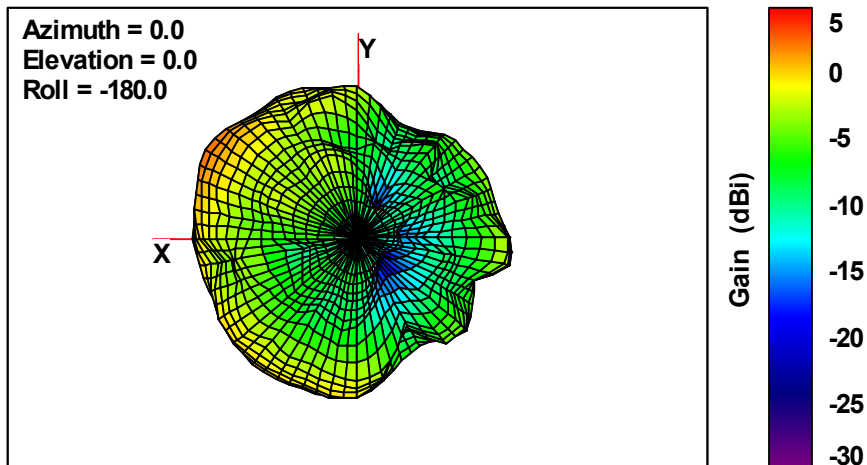

3D Free Space Gain Pattern

5.2GHz Ant3

Total

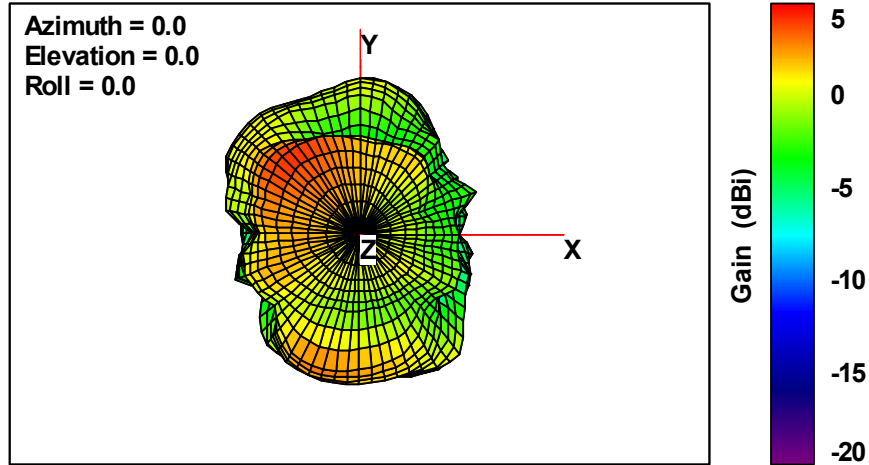

Total

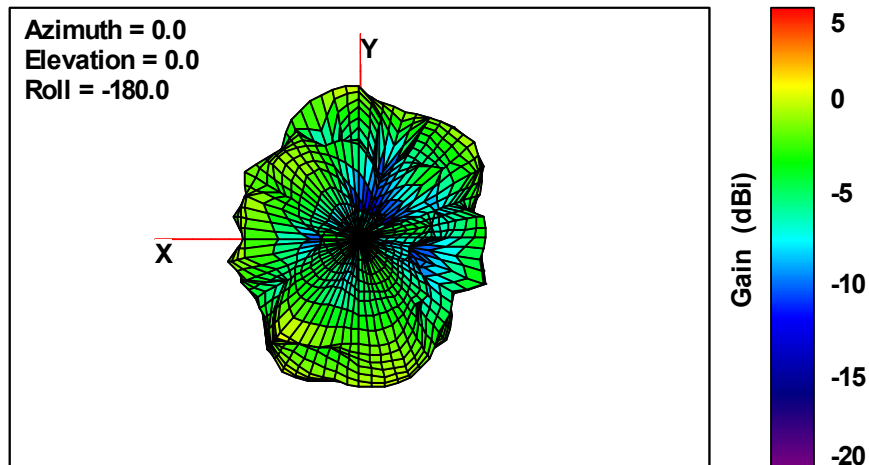

3D Free Space Gain Pattern

5.3GHz Ant0

Total

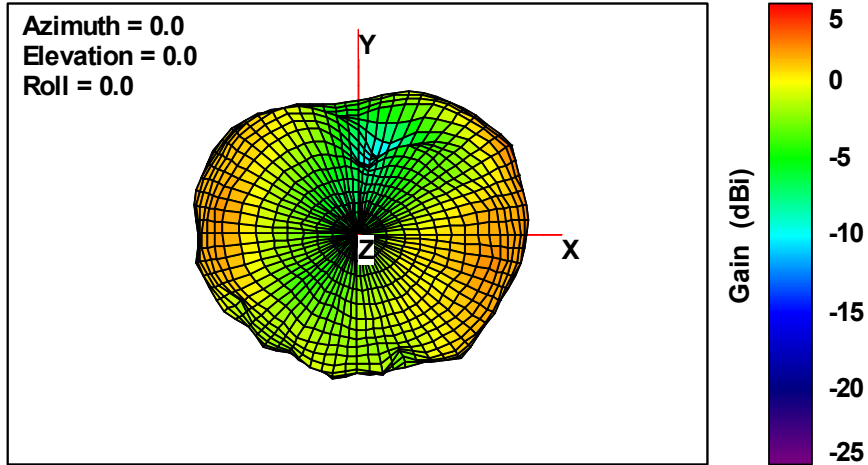

Total

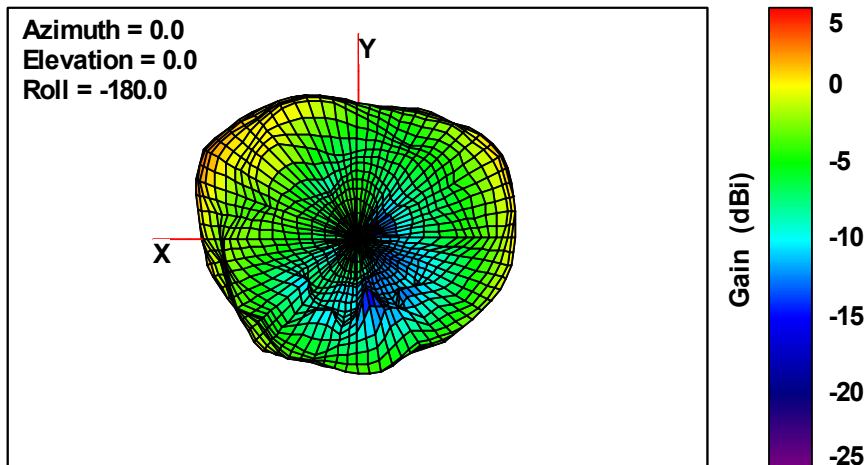

3D Free Space Gain Pattern

5.3GHz Ant1

Total

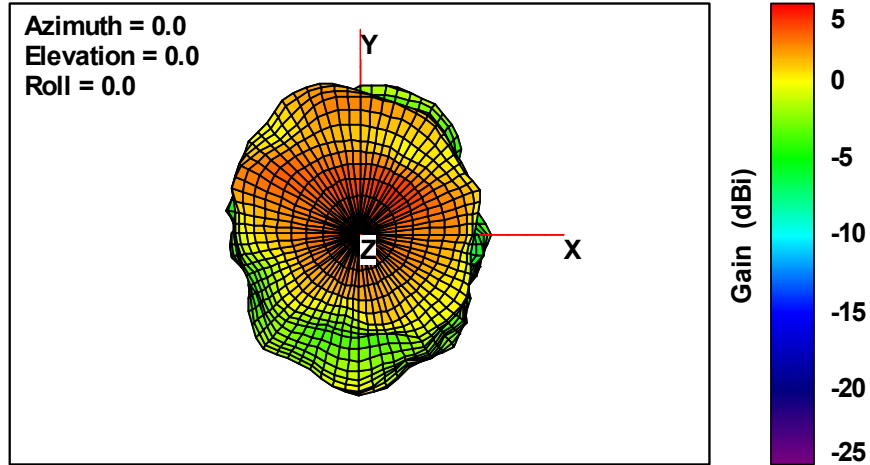

Total

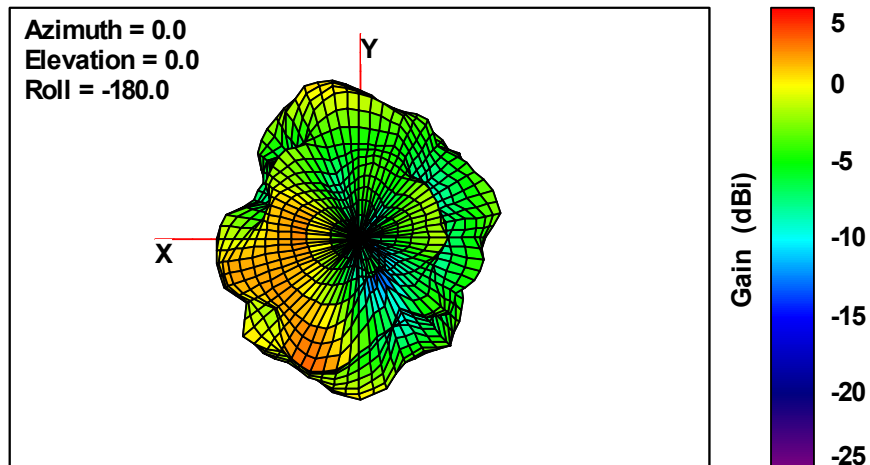

3D Free Space Gain Pattern

5.3GHz Ant2

Total

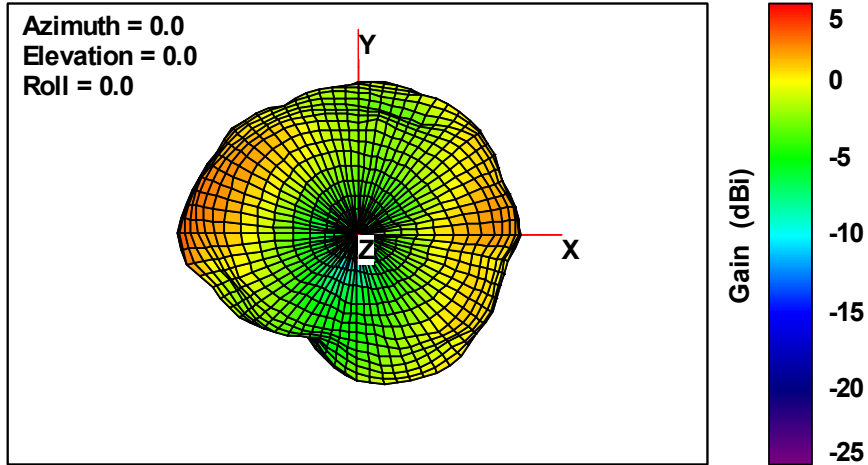

Total

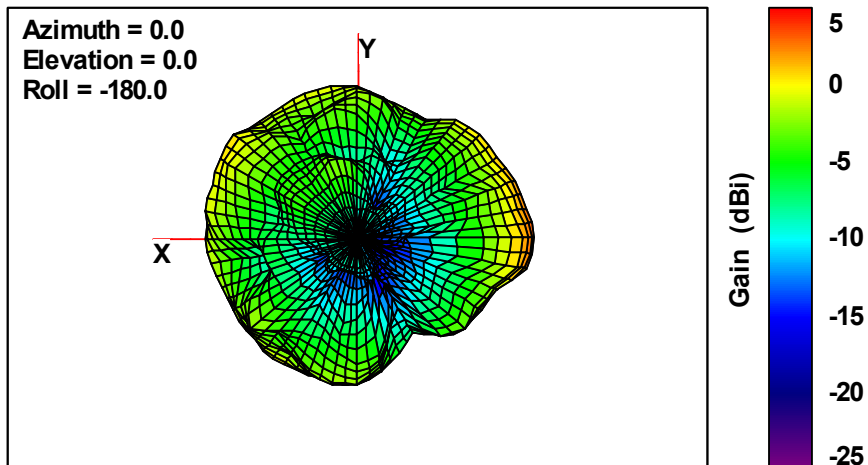

3D Free Space Gain Pattern

5.3GHz Ant3

Total

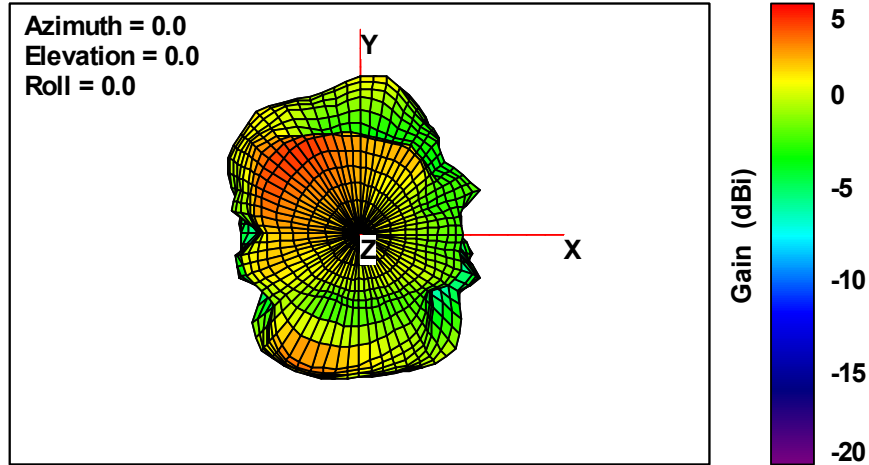

Total

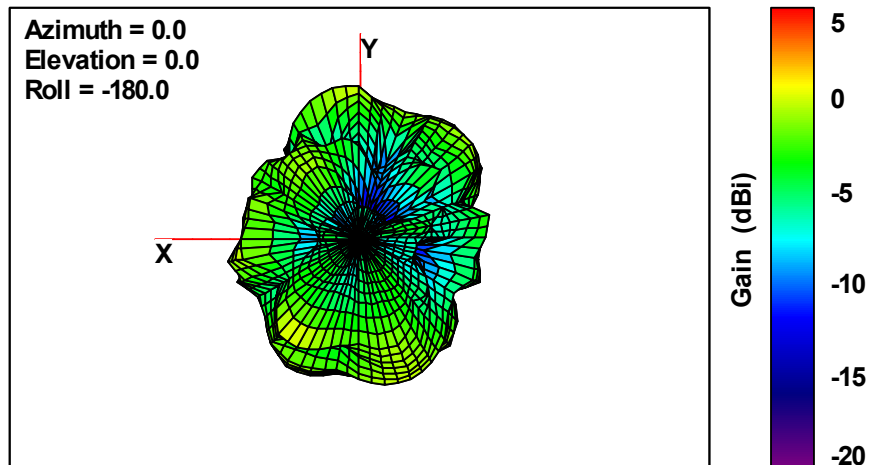

3D Free Space Gain Pattern

5.5GHz Ant0

Total

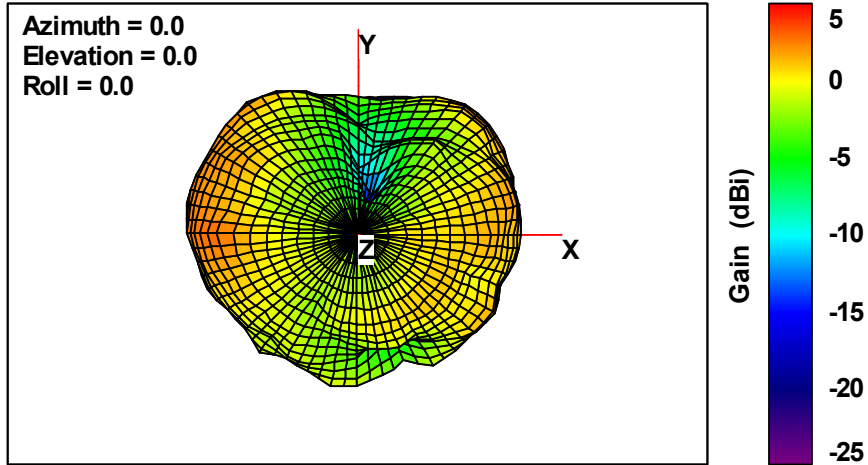

Total

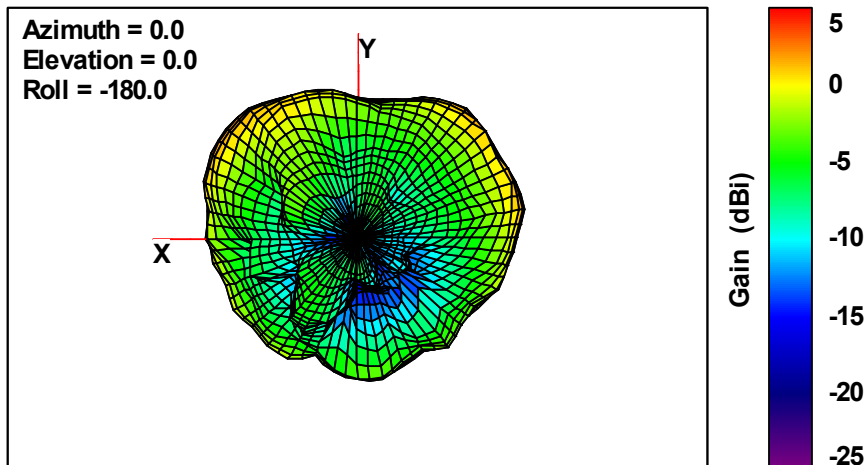

3D Free Space Gain Pattern

5.5GHz Ant1

Total

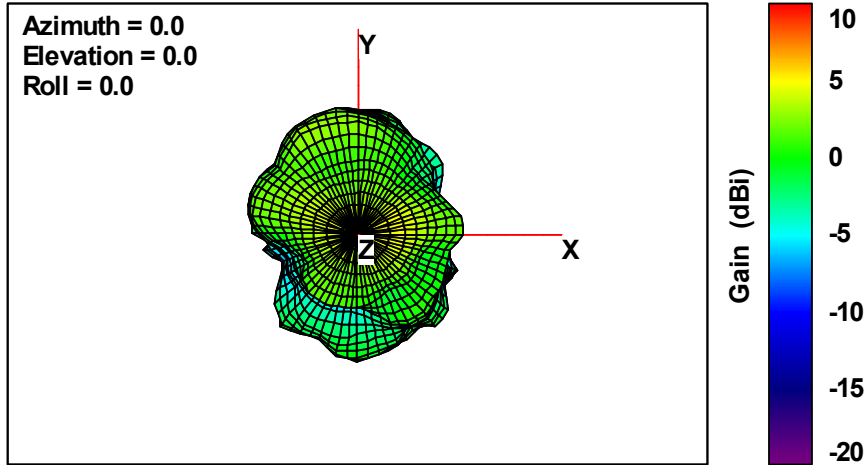

Total

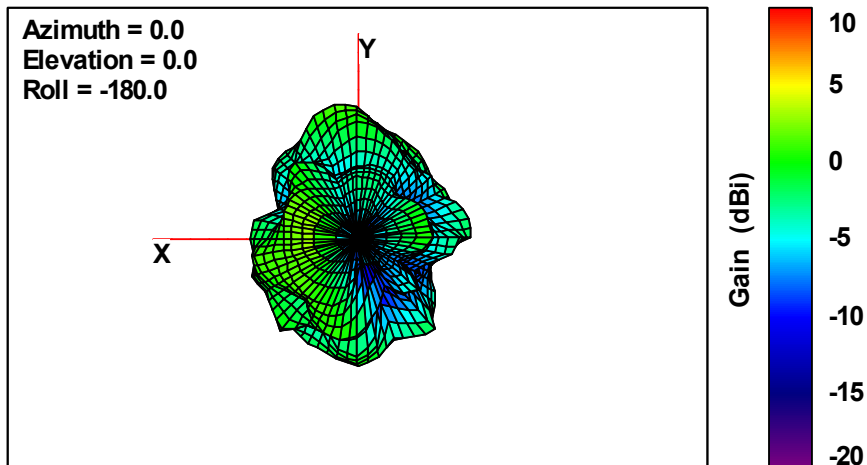

3D Free Space Gain Pattern

5.5GHz Ant2

Total

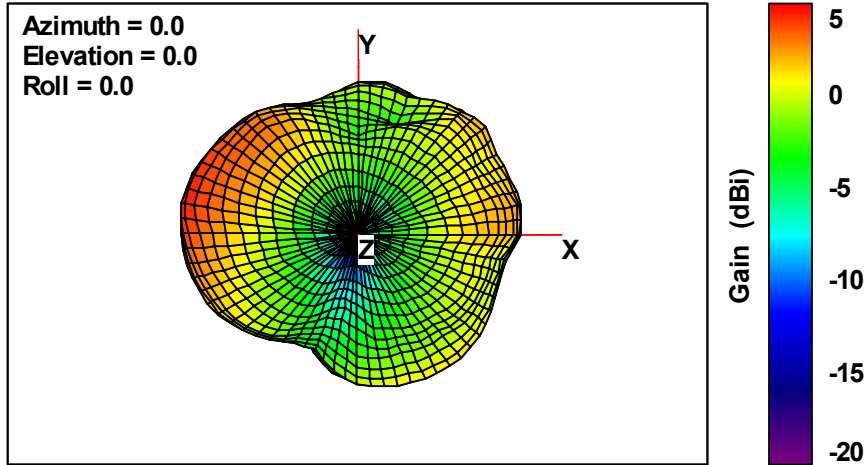

Total

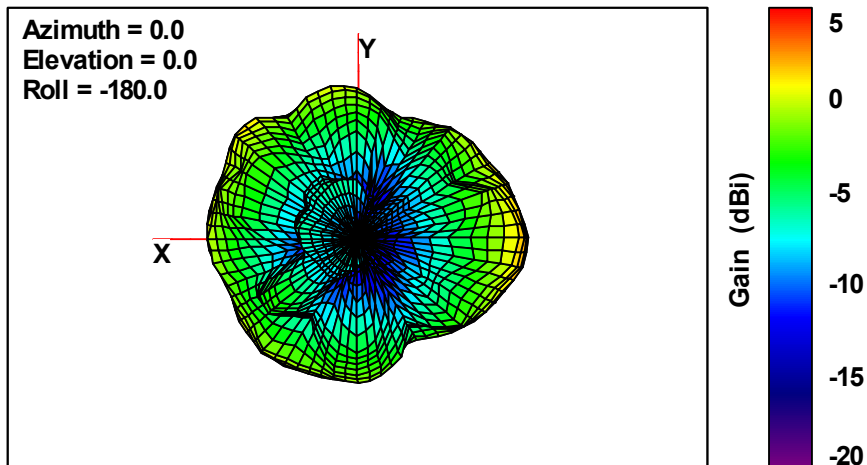

3D Free Space Gain Pattern

5.5GHz Ant3

Total

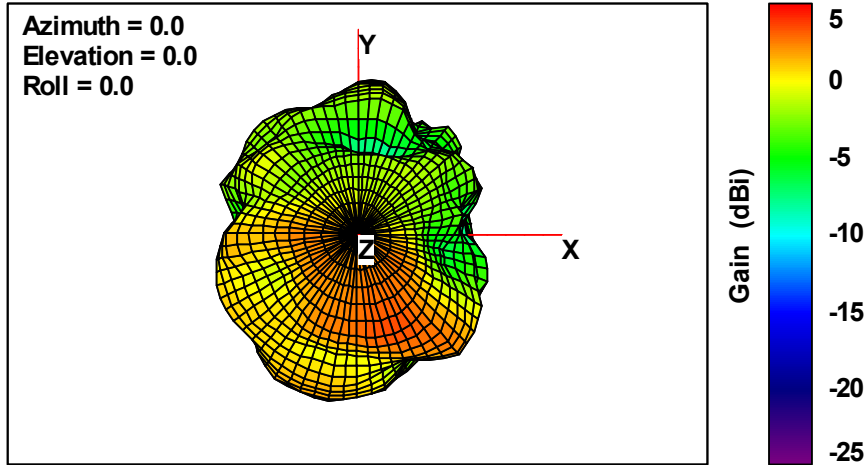

Total

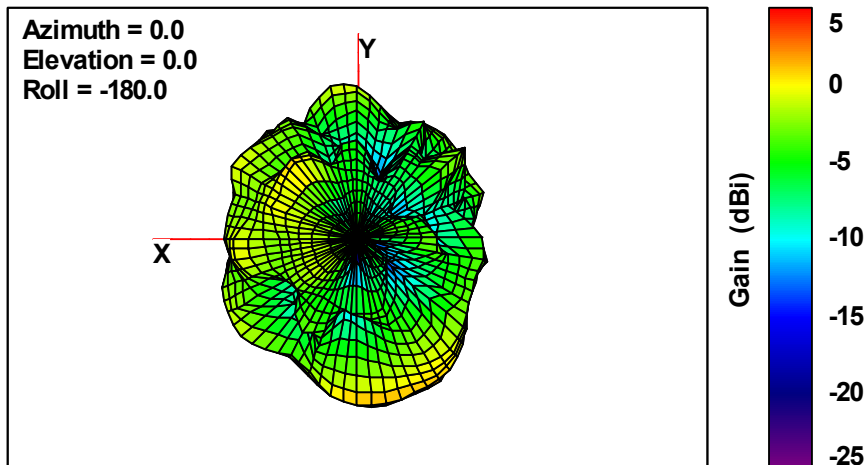

3D Free Space Gain Pattern

5.8GHz Ant0

Total

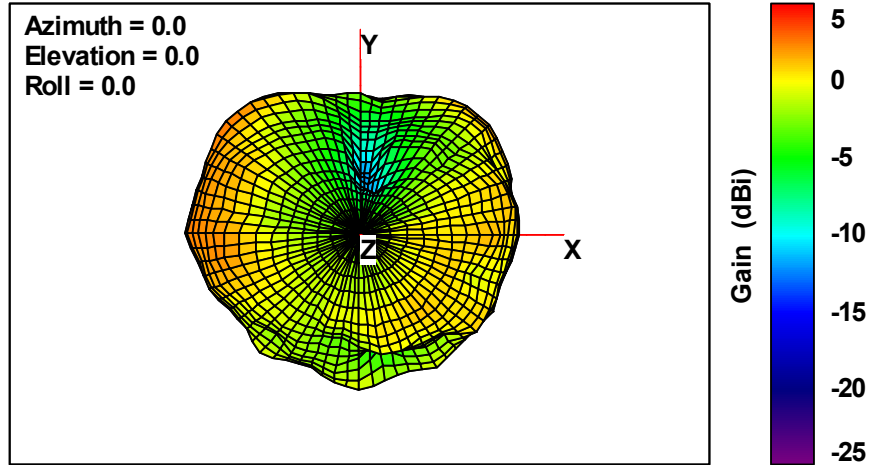

Total

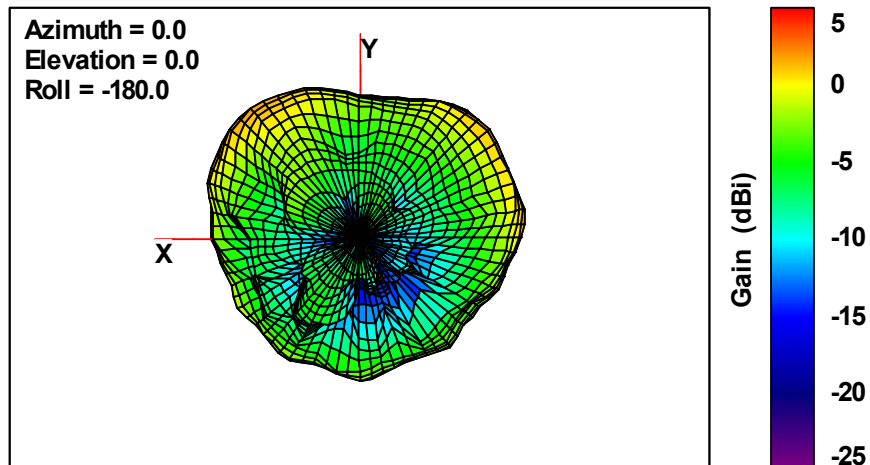

3D Free Space Gain Pattern

5.8GHz Ant1

Total

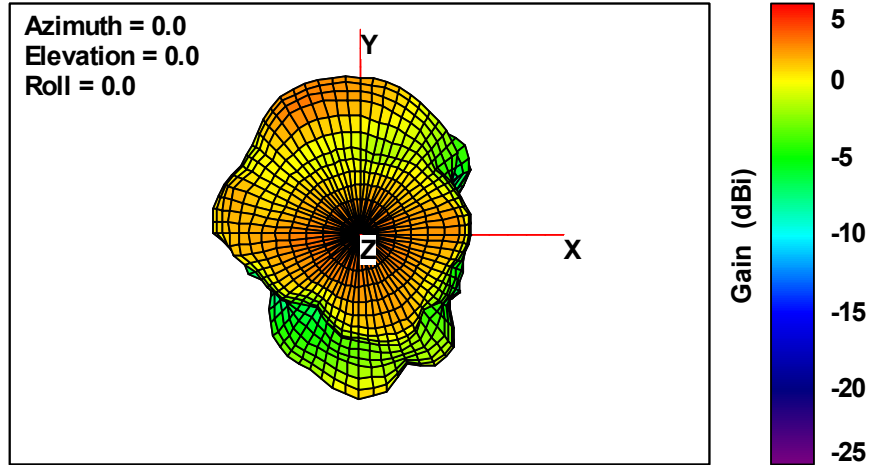

Total

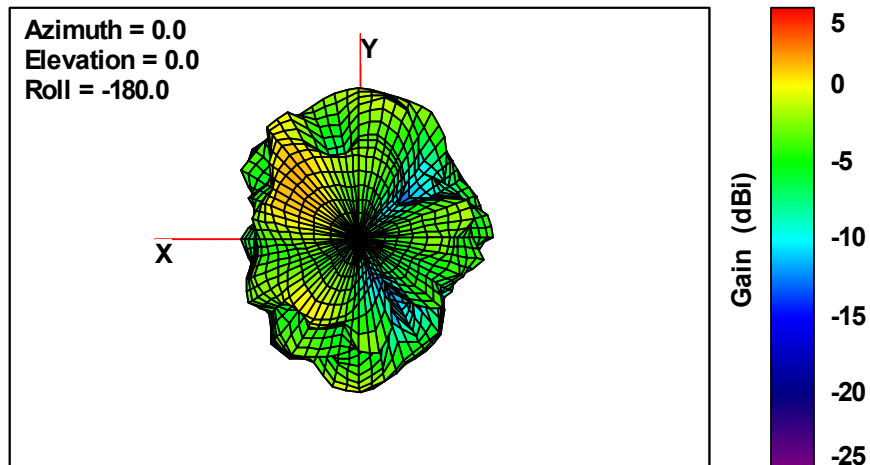

3D Free Space Gain Pattern

5.8GHz Ant2

Total

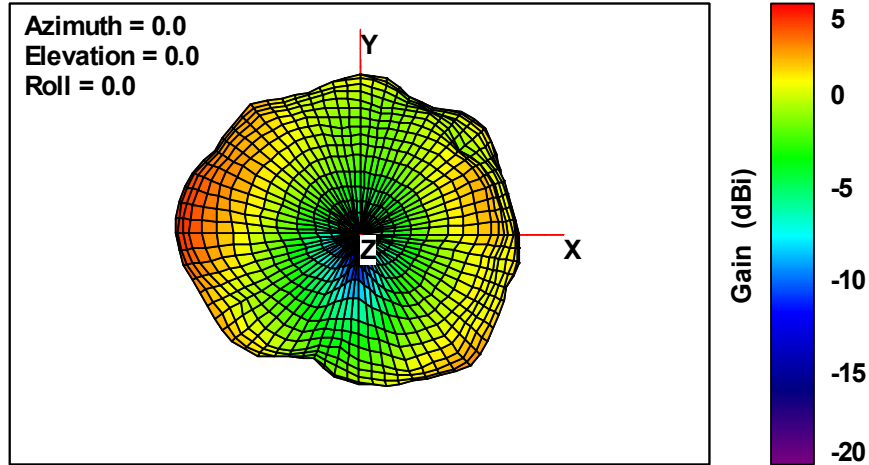

Total

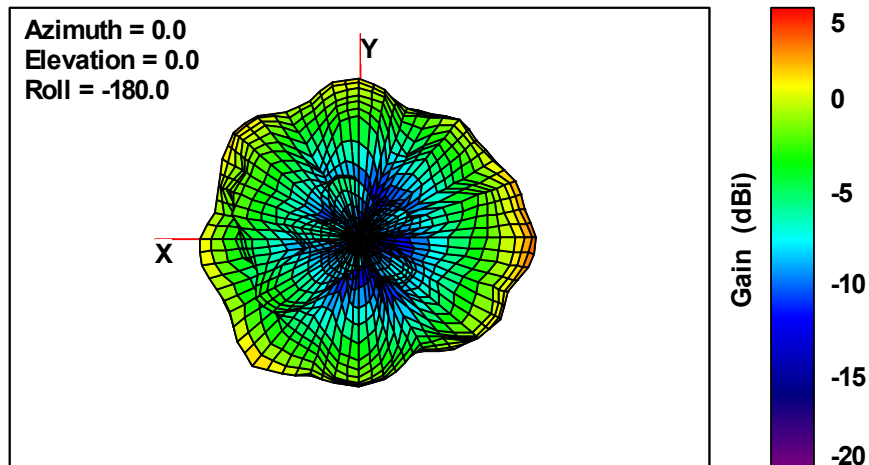

3D Free Space Gain Pattern

5.8GHz Ant3

Total

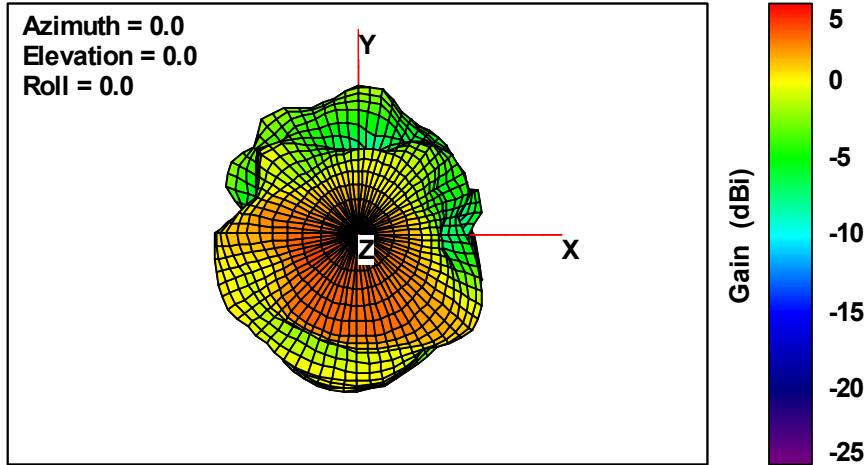

Total

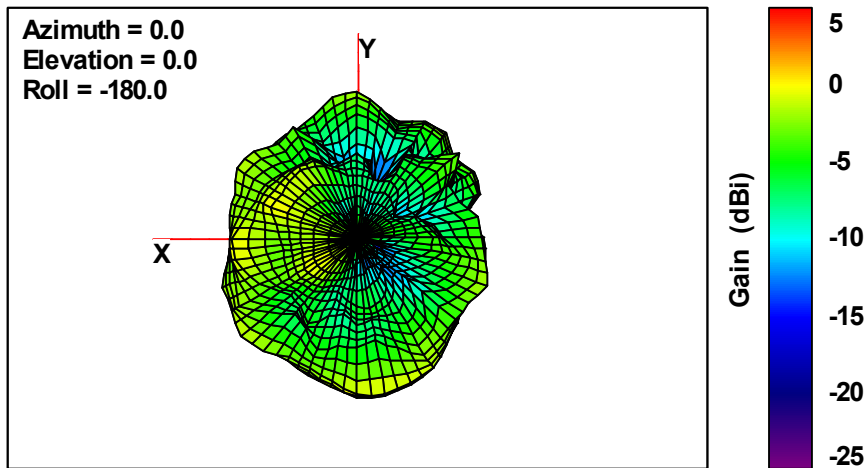

3D Free Space Gain Pattern

6GHz Ant0

Total

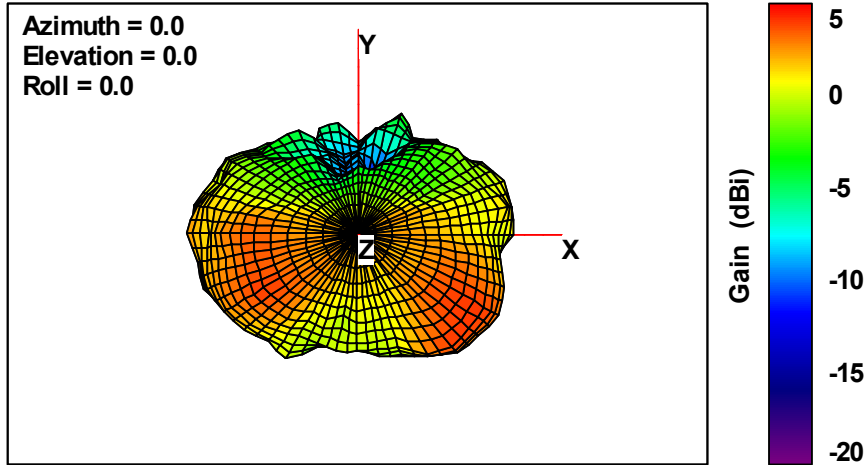

Total

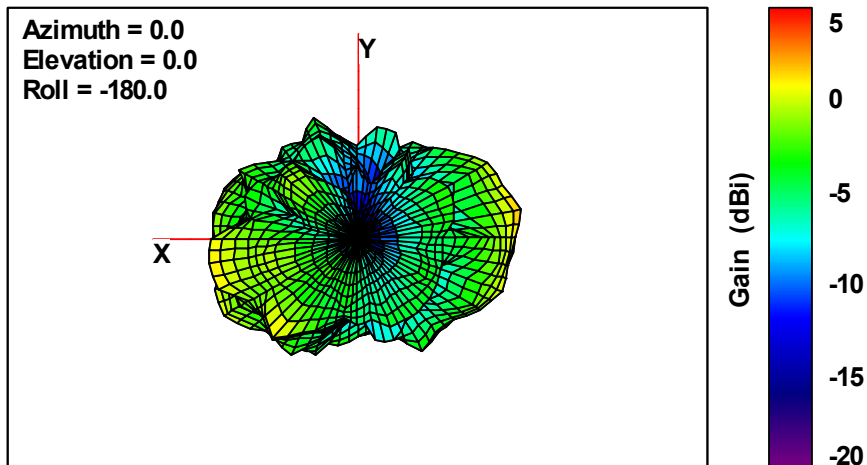

3D Free Space Gain Pattern

6GHz Ant1

Total

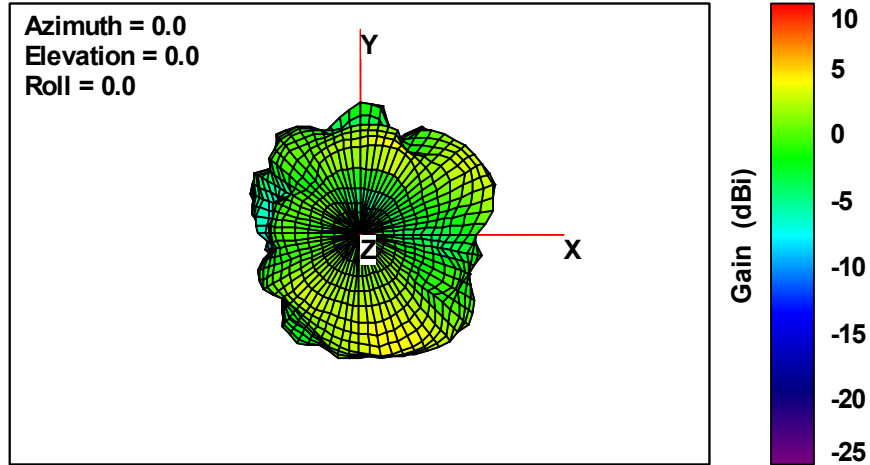

Total

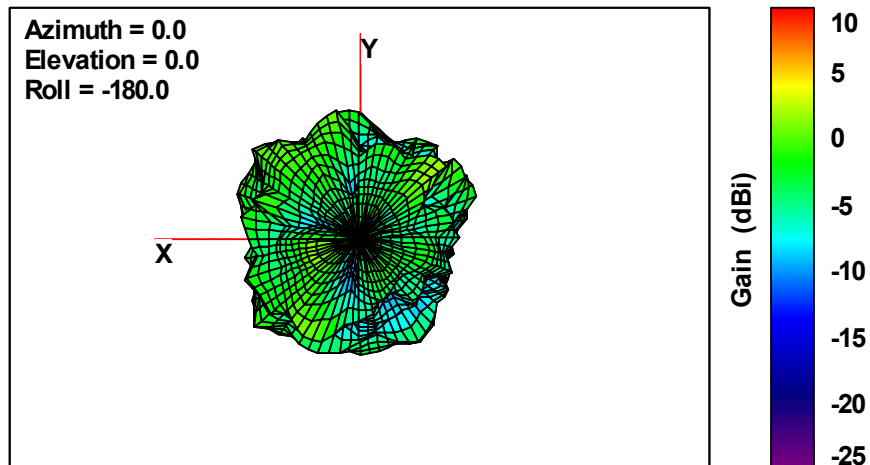

3D Free Space Gain Pattern

6GHz Ant2

Total

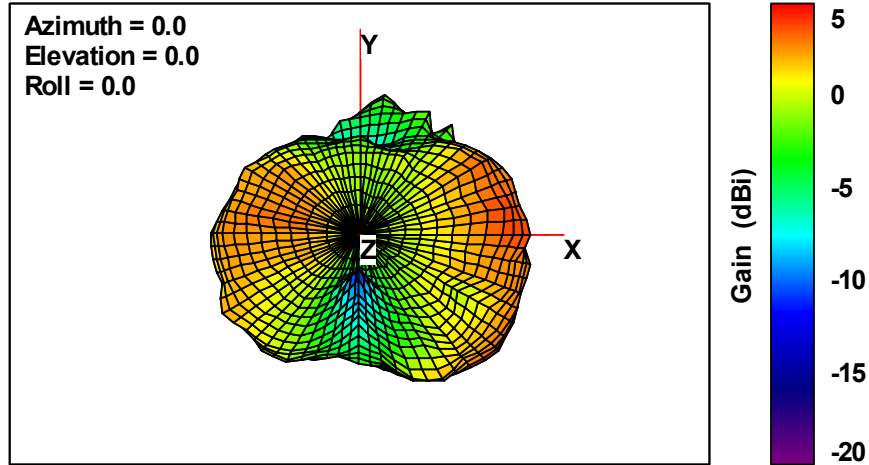

Total

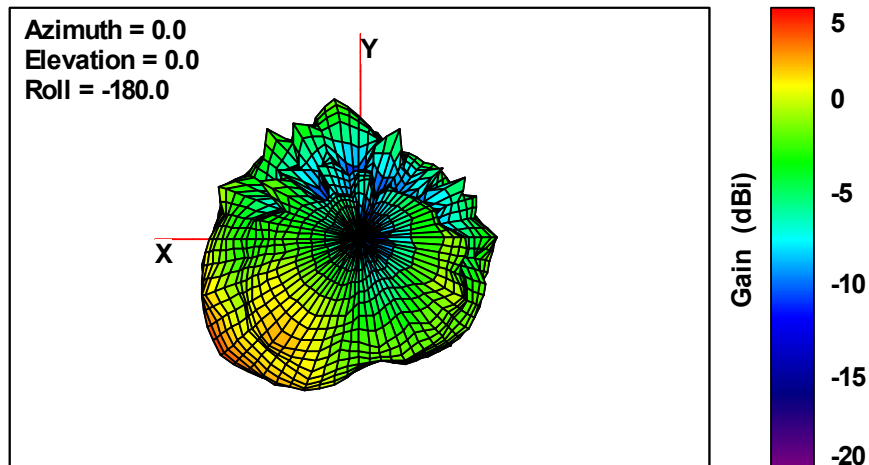

3D Free Space Gain Pattern

6GHz Ant3

Total

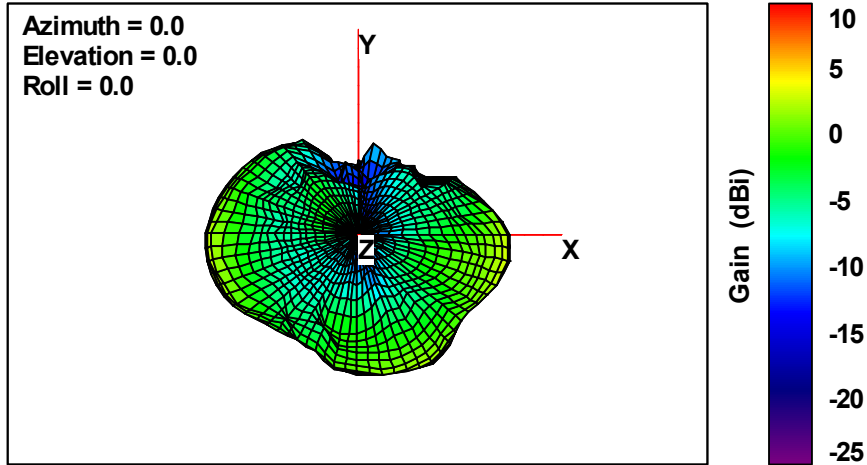

Total

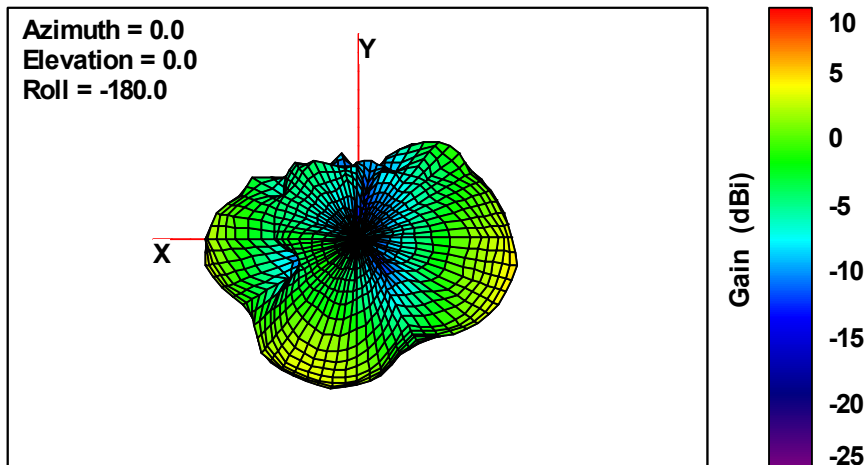

3D Free Space Gain Pattern



Appendix A. Test Results of Detailed raw data

The detailed raw data tables are shown as follows.



Frequency: 2412MHz

Angle (θ)		Theta Polarization				Nant	Angle (θ)		Phi Polarization				Nant	Total				Nant	Max DG(dB)	
		Max Gain(dB)							Max Gain(dB)					Max Gain(dB)					7.58	1.87
		Ant 1(G1)	Ant 2(G2)	Ant 3(G3)	Ant 4(G4)				Ant 1(G1)	Ant 2(G2)	Ant 3(G3)	Ant 4(G4)		Ant 1(G1)	Ant 2(G2)	Ant 3(G3)	Ant 4(G4)		g1k	g1k
		2.79	4.91	3.90	-0.29				3.78	-5.36	3.90	3.22		3.95	4.95	3.91	3.33		15AT	45AT
Ant 1(G1)	Ant 2(G2)	Ant 3(G3)	Ant 4(G4)	Ant 1(G1)	Ant 2(G2)	Ant 3(G3)	Ant 4(G4)	Ant 1(G1)	Ant 2(G2)	Ant 3(G3)	Ant 4(G4)									
0.00	0.00	-0.61	-11.21	-21.53	-1.02	4.00	0.00	0.00	-20.84	-12.31	3.9	-10.83	4.00	-0.57	-8.71	3.91	-0.59	4.00	5.59	0.36
0.00	10.00	-0.59	-10.09	-9.01	-0.67	4.00	0.00	10.00	-22.8	-14.38	3.68	-17.81	4.00	-0.56	-8.72	3.91	-0.59	4.00	5.59	0.36
0.00	20.00	-0.85	-9.33	-4.23	-0.60	4.00	0.00	20.00	-12.63	-17.48	3.18	-29.4	4.00	-0.57	-8.71	3.90	-0.59	4.00	5.59	0.36
0.00	30.00	-1.38	-8.89	-1.36	-0.79	4.00	0.00	30.00	-8.24	-22.82	2.37	-14.18	4.00	-0.57	-8.72	3.90	-0.60	4.00	5.59	0.36
0.00	40.00	-2.24	-8.72	0.59	-1.25	4.00	0.00	40.00	-5.52	-41.13	1.18	-9.09	4.00	-0.57	-8.72	3.91	-0.59	4.00	5.59	0.36
0.00	50.00	-3.49	-8.81	1.96	-2.03	4.00	0.00	50.00	-3.67	-25.19	-0.52	-6.09	4.00	-0.57	-8.71	3.90	-0.59	4.00	5.59	0.36
0.00	60.00	-5.28	-9.18	2.91	-3.18	4.00	0.00	60.00	-2.36	-18.63	-2.97	-4.07	4.00	-0.57	-8.71	3.91	-0.59	4.00	5.59	0.36
0.00	70.00	-7.87	-9.85	3.52	-4.82	4.00	0.00	70.00	-1.46	-15.11	-6.81	-2.65	4.00	-0.57	-8.72	3.90	-0.59	4.00	5.59	0.36
0.00	80.00	-12.00	-10.86	3.84	-7.18	4.00	0.00	80.00	-0.89	-12.81	-14.45	-1.67	4.00	-0.57	-8.72	3.90	-0.59	4.00	5.59	0.36
0.00	90.00	-20.84	-12.31	3.90	-10.83	4.00	0.00	90.00	-0.61	-11.21	-21.53	-1.02	4.00	-0.57	-8.71	3.91	-0.59	4.00	5.59	0.36
0.00	100.00	-22.80	-14.38	3.68	-17.81	4.00	0.00	100.00	-0.59	-10.09	-9.01	-0.67	4.00	-0.56	-8.72	3.91	-0.59	4.00	5.59	0.36
0.00	110.00	-12.63	-17.48	3.18	-29.40	4.00	0.00	110.00	-0.85	-9.33	-4.23	-0.6	4.00	-0.57	-8.71	3.90	-0.59	4.00	5.59	0.36
0.00	120.00	-8.24	-22.82	2.37	-14.18	4.00	0.00	120.00	-1.38	-8.89	-1.36	-0.79	4.00	-0.57	-8.72	3.90	-0.60	4.00	5.59	0.36
0.00	130.00	-5.52	-41.13	1.18	-9.09	4.00	0.00	130.00	-2.24	-8.72	0.59	-1.25	4.00	-0.57	-8.72	3.91	-0.59	4.00	5.59	0.36
0.00	140.00	-3.67	-25.19	-0.52	-6.09	4.00	0.00	140.00	-3.49	-8.81	1.96	-2.03	4.00	-0.57	-8.71	3.90	-0.59	4.00	5.59	0.36
0.00	150.00	-2.36	-18.63	-2.97	-4.07	4.00	0.00	150.00	-5.28	-9.18	2.91	-3.18	4.00	-0.57	-8.71	3.91	-0.59	4.00	5.59	0.36
0.00	160.00	-1.46	-15.11	-6.81	-2.65	4.00	0.00	160.00	-7.87	-9.85	3.52	-4.82	4.00	-0.57	-8.72	3.90	-0.59	4.00	5.59	0.36
0.00	170.00	-0.89	-12.81	-14.45	-1.67	4.00	0.00	170.00	-12	-10.86	3.84	-7.18	4.00	-0.57	-8.72	3.90	-0.59	4.00	5.59	0.36
0.00	180.00	-0.61	-11.21	-21.53	-1.02	4.00	0.00	180.00	-20.84	-12.31	3.9	-10.83	4.00	-0.57	-8.71	3.91	-0.59	4.00	5.59	0.36
0.00	190.00	-0.59	-10.09	-9.01	-0.67	4.00	0.00	190.00	-22.8	-14.38	3.68	-17.81	4.00	-0.56	-8.72	3.91	-0.59	4.00	5.59	0.36
0.00	200.00	-0.85	-9.33	-4.23	-0.60	4.00	0.00	200.00	-12.63	-17.48	3.18	-29.4	4.00	-0.57	-8.71	3.90	-0.59	4.00	5.59	0.36
0.00	210.00	-1.38	-8.89	-1.36	-0.79	4.00	0.00	210.00	-8.24	-22.82	2.37	-14.18	4.00	-0.57	-8.72	3.90	-0.60	4.00	5.59	0.36
0.00	220.00	-2.24	-8.72	0.59	-1.25	4.00	0.00	220.00	-5.52	-41.13	1.18	-9.09	4.00	-0.57	-8.72	3.91	-0.59	4.00	5.59	0.36
0.00	230.00	-3.49	-8.81	1.96	-2.03	4.00	0.00	230.00	-3.67	-25.19	-0.52	-6.09	4.00	-0.57	-8.71	3.90	-0.59	4.00	5.59	0.36
0.00	240.00	-5.28	-9.18	2.91	-3.18	4.00	0.00	240.00	-2.36	-18.63	-2.97	-4.07	4.00	-0.57	-8.71	3.91	-0.59	4.00	5.59	0.36
0.00	250.00	-7.87	-9.85	3.52	-4.82	4.00	0.00	250.00	-1.46	-15.11	-6.81	-2.65	4.00	-0.57	-8.72	3.90	-0.59	4.00	5.59	0.36
0.00	260.00	-12.00	-10.86	3.84	-7.18	4.00	0.00	260.00	-0.89	-12.81	-14.45	-1.67	4.00	-0.57	-8.72	3.90	-0.59	4.00	5.59	0.36
0.00	270.00	-20.84	-12.31	3.90	-10.83	4.00	0.00	270.00	-0.61	-11.21	-21.53	-1.02	4.00	-0.57	-8.71	3.91	-0.59	4.00	5.59	0.36
0.00	280.00	-22.80	-14.38	3.68	-17.81	4.00	0.00	280.00	-0.59	-10.09	-9.01	-0.67	4.00	-0.56	-8.72	3.91	-0.59	4.00	5.59	0.36
0.00	290.00	-12.63	-17.48	3.18	-29.40	4.00	0.00	290.00	-0.85	-9.33	-4.23	-0.6	4.00	-0.57	-8.71	3.90	-0.59	4.00	5.59	0.36
0.00	300.00	-8.24	-22.82	2.37	-14.18	4.00	0.00	300.00	-1.38	-8.89	-1.36	-0.79	4.00	-0.57	-8.72	3.90	-0.60	4.00	5.59	0.36
0.00	310.00	-5.52	-41.13	1.18	-9.09	4.00	0.00	310.00	-2.24	-8.72	0.59	-1.25	4.00	-0.57	-8.72	3.91	-0.59	4.00	5.59	0.36
0.00	320.00	-3.67	-25.19	-0.52	-6.09	4.00	0.00	320.00	-3.49	-8.81	1.96	-2.03	4.00	-0.57	-8.71	3.90	-0.59	4.00	5.59	0.36
0.00	330.00	-2.36	-18.63	-2.97	-4.07	4.00	0.00	330.00	-5.28	-9.18	2.91	-3.18	4.00	-0.57	-8.71	3.91	-0.59	4.00	5.59	0.36
0.00	340.00	-1.46	-15.11	-6.81	-2.65	4.00	0.00	340.00	-7.87	-9.85	3.52	-4.82	4.00	-0.57	-8.72	3.90	-0.59	4.00	5.59	0.36
0.00	350.00	-0.89	-12.81	-14.45	-1.67	4.00	0.00	350.00	-12	-10.86	3.84	-7.18	4.00	-0.57	-8.72	3.90	-0.59	4.00	5.59	0.36
15.00	0.00	-1.15	-6.99	-21.91	-1.77	4.00	15.00	0.00	-19.28	-10.58	3.58	-11.29	4.00	-1.08	-5.41	3.59	-1.31	4.00	5.55	0.10
15.00	10.00	-0.97	-7.13	-17.38	-2.47	4.00	15.00	10.00	-51.21	-10.37	3.58	-8.55	4.00	-0.97	-5.44	3.61	-1.51	4.00	5.54	0.10
15.00	20.00	-1.06	-7.40	-17.93	-3.58	4.00	15.00	20.00	-14.89	-10.66	3.46	-6.39	4.00	-0.88	-5.72	3.76	-1.75	4.00	5.53	0.14
15.00	30.00	-1.55	-7.69	-3.59	-5.23	4.00	15.00	30.00	-8.99	-10.75	2.84	-4.92	4.00	-0.83	-5.95	3.73	-2.06	4.00	5.43	0.07
15.00	40.00	-2.29	-7.88	-1.05	-7.42	4.00	15.00	40.00	-5.81	-11.1	1.9	-4	4.00	-0.69	-6.19	3.68	-2.37	4.00	5.35	0.01
15.00	50.00	-3.26	-8.18	0.64	-10.01	4.00	15.00	50.00	-3.63	-11.09	0.54	-3.37	4.00	-0.43	-6.39	3.60	-2.52	4.00	5.33	-0.01
15.00	60.00	-4.71	-8.29	1.88	-13.75	4.00	15.00	60.00	-2.15	-11.16	-1.23	-2.88	4.00	-0.23	-6.48	3.61	-2.54	4.00	5.36	0.03
15.00	70.00	-6.76	-8.54	2.65	-19.78	4.00	15.00	70.00	-1.03	-10.78	-4.2	-2.57	4.00	0.00	-6.51	3.47	-2.49	4.00	5.38	0.01
15.00	80.00	-10.60	-7.98	3.14	-20.62	4.00	15.00	80.00	-0.24	-10.51	-8.63	-2.39	4.00	0.14	-6.05	3.42	-2.33	4.00	5.49	0.07
15.00	90.00	-19.22	-7.73	3.31	-14.25	4.00	15.00	90.00	0.08	-11.51	-19.21	-2.54	4.00	0.13	-6.21	3.33	-2.26	4.00	5.44	0.02
15.00	100.00	-21.83	-8.34	3.16	-10.26	4.00	15.00	100.00	0.11	-13.55	-15.91	-3.01	4.00	0.14	-7.20	3.21	-2.26	4.00	5.28	-0.10
15.00	110.00	-11.14	-9.12	2.78	-7.56	4.00	15.00	110.00	-0.14	-15.76	-7.56	-3.89	4.00	0.19	-8.27	3.16	-2.34	4.00	5.13	-0.17
15.00	120.00	-6.54	-9.91	2.07	-5.64	4.00	15.00	120.00	-0.86	-15.41	-3.56	-5.19	4.00	0.18	-8.83	3.12	-2.40	4.00	5.04	-0.22
15.00	130.00	-3.88	-10.73	1.10	-4.25	4.00	15.00	130.00	-1.87	-15.34	-0.9	-7.07	4.00	0.25	-9.44	3.22	-2.42	4.00	5.04	-0.17
15.00	140.00	-2.23	-11.32	-0.17	-3.36	4.00	15.00	140.00	-3.07	-15.05	0.86	-9.95	4.00	0.38	-9.79	3.39	-2.50	4.00	5.09	-0.07
15.00	150.00	-1.07	-11.58	-1.77	-2.79	4.00	15.00	150.00	-5.03	-14.6	2.05	-13.85	4.00	0.40	-9.82	3.56	-2.46	4.00	5.17	0.04
15.00	160.00	-0.27	-11.98	-4.53	-2.56	4.00	15.00	160.00	-8.23	-13.95	2.89	-19.22	4.00	0.37	-9.84	3.61	-2.47	4.00	5.19	0.06
15.00	170.00	-0.01	-12.53	-9.11	-2.65	4.00	15.00	170.00	-13.04	-12.84	3.34	-16.51	4.00	0.20	-9.67	3.58	-2.48	4.00	5.14	0.00
15.00	180.00	-0.04	-12.82	-19.46	-2.84	4.00	15.00	180.00	-19.15	-11.85	3.48	-11.09	4.00	0.01	-9.30	3.50	-2.23	4.00	5.14	-0.05
15.00	190.00	-0.37	-13.75	-15.98	-2.99	4.00	15.00	190.00	-11.91	-10.33	3.27	-7.83	4.00	-0.08	-8.70	3.32	-1.76	4.00	5.20	-0.07
15.00	200.00	-1.31	-14.14	-7.65	-3.64	4.00	15.00	200.00	-7.4	-9.38	2.73	-5.55	4.00	-0.35	-8.13	3.11	-1.48	4.00	5.17	-0.18
15.00	210.00	-2.11	-14.46	-4.34	-4.37	4.00	15.00	210.00	-4.7	-8.73	2.09	-3.91	4.00	-0.20	-7.70	2.98	-1.12	4.00	5.29	-0.13
15.00	220.00																			



45.00	140.00	-1.01	-1.97	-4.30	-3.98	4.00	45.00	140.00	0.66	-12.49	0.9	0.23	4.00	2.92	-1.60	2.05	1.63	4.00	7.43	1.54
45.00	150.00	-0.38	-1.81	-6.53	-2.77	4.00	45.00	150.00	-2.02	-11.09	2.02	-2.08	4.00	1.89	-1.33	2.59	0.60	4.00	7.08	1.18
45.00	160.00	-0.37	-2.28	-9.92	-1.90	4.00	45.00	160.00	-5.65	-10.86	2.68	-5.82	4.00	0.76	-1.72	2.91	-0.42	4.00	6.57	0.73
45.00	170.00	-0.58	-3.57	-16.01	-1.20	4.00	45.00	170.00	-10.99	-10.8	2.99	-11.98	4.00	-0.20	-2.82	3.04	-0.85	4.00	6.08	0.33
45.00	180.00	-1.38	-4.68	-30.02	-1.12	4.00	45.00	180.00	-13.44	-10.93	2.93	-19.49	4.00	-1.12	-3.76	2.93	-1.06	4.00	5.61	-0.06
45.00	190.00	-3.22	-5.10	-15.84	-1.35	4.00	45.00	190.00	-8.04	-10.07	2.77	-11.88	4.00	-1.98	-3.90	2.83	-0.98	4.00	5.37	-0.27
45.00	200.00	-5.44	-5.27	-10.74	-2.20	4.00	45.00	200.00	-5.49	-9.33	2.42	-7.59	4.00	-2.45	-3.83	2.63	-1.10	4.00	5.18	-0.47
45.00	210.00	-6.22	-5.81	-8.36	-2.90	4.00	45.00	210.00	-4.99	-9	1.87	-5.09	4.00	-2.55	-4.11	2.26	-0.85	4.00	5.04	-0.64
45.00	220.00	-5.67	-6.58	-6.47	-3.91	4.00	45.00	220.00	-4.23	-9.85	0.72	-2.97	4.00	-1.88	-4.90	1.48	-0.40	4.00	4.90	-0.85
45.00	230.00	-5.72	-7.25	-5.22	-5.06	4.00	45.00	230.00	-3.2	-10.62	-0.89	-1.26	4.00	-1.27	-5.61	0.47	0.25	4.00	4.80	-0.97
45.00	240.00	-7.65	-7.74	-4.28	-6.79	4.00	45.00	240.00	-1.66	-11.91	-3.16	0.11	4.00	-0.68	-6.33	-0.67	0.92	4.00	4.72	-1.00
45.00	250.00	-10.87	-8.11	-3.75	-9.99	4.00	45.00	250.00	-0.67	-13.67	-6.37	1.19	4.00	-0.27	-7.04	-1.86	1.51	4.00	4.64	-0.96
45.00	260.00	-16.41	-8.69	-3.48	-14.49	4.00	45.00	260.00	-0.51	-15.68	-11.55	1.81	4.00	-0.40	-7.90	-2.85	1.91	4.00	4.41	-1.04
45.00	270.00	-32.84	-8.90	-3.78	-18.82	4.00	45.00	270.00	-0.91	-16.9	-19.8	1.91	4.00	-0.91	-8.26	-3.67	1.95	4.00	4.06	-1.31
45.00	280.00	-21.80	-8.68	-3.98	-13.94	4.00	45.00	280.00	-1.94	-16.48	-14	1.57	4.00	-1.90	-8.01	-3.57	1.69	4.00	3.75	-1.67
45.00	290.00	-17.49	-7.31	-4.30	-9.34	4.00	45.00	290.00	-3.57	-13.2	-7.96	0.83	4.00	-3.40	-6.31	-2.75	1.23	4.00	3.64	-1.96
45.00	300.00	-16.51	-5.55	-4.69	-6.37	4.00	45.00	300.00	-5.83	-10.35	-4.41	-0.07	4.00	-5.47	-4.31	-1.54	0.84	4.00	3.75	-1.92
45.00	310.00	-15.09	-3.54	-5.88	-4.15	4.00	45.00	310.00	-8.06	-8.46	-2	-1.19	4.00	-7.27	-2.33	-0.51	0.59	4.00	4.11	-1.54
45.00	320.00	-10.03	-1.98	-7.72	-2.39	4.00	45.00	320.00	-9.65	-7.38	-0.26	-2.51	4.00	-6.83	-0.88	0.46	0.56	4.00	4.81	-0.87
45.00	330.00	-6.43	-1.36	-10.03	-1.51	4.00	45.00	330.00	-10.56	-7.15	0.76	-4.16	4.00	-5.01	-0.34	1.11	0.37	4.00	5.35	-0.43
45.00	340.00	-3.49	-1.03	-13.86	-1.17	4.00	45.00	340.00	-12.18	-8.26	1.58	-7.74	4.00	-2.94	-0.28	1.70	-0.31	4.00	5.72	-0.16
45.00	350.00	-2.35	-0.94	-17.66	-1.57	4.00	45.00	350.00	-16.62	-10.5	2.33	-14.93	4.00	-2.19	-0.48	2.37	-1.37	4.00	5.78	-0.05
60.00	0.00	-4.18	0.44	-18.30	-6.59	4.00	60.00	0.00	-13.57	-22.19	1.17	-25.65	4.00	-3.71	0.46	1.22	-6.54	4.00	4.43	-1.13
60.00	10.00	-4.72	1.26	-15.30	-9.48	4.00	60.00	10.00	-5.76	-26.07	1.77	-13.14	4.00	-2.20	1.27	1.85	-7.93	4.00	5.04	-0.41
60.00	20.00	-5.28	1.56	-11.17	-10.99	4.00	60.00	20.00	-2.66	-17.25	2.05	-8.53	4.00	-0.77	1.62	2.25	-6.58	4.00	5.77	0.20
60.00	30.00	-5.88	1.29	-7.98	-9.82	4.00	60.00	30.00	-2.24	-13.73	1.87	-5.84	4.00	-0.68	1.42	2.30	-4.38	4.00	6.04	0.32
60.00	40.00	-5.90	0.97	-6.21	-8.89	4.00	60.00	40.00	-2.04	-13.54	1.13	-4.33	4.00	-0.54	1.12	1.87	-3.03	4.00	6.07	0.22
60.00	50.00	-6.34	0.91	-5.15	-8.77	4.00	60.00	50.00	-0.75	-14.55	-0.41	-2.69	4.00	0.31	1.03	0.85	-1.73	4.00	6.20	0.24
60.00	60.00	-7.20	0.95	-4.51	-9.58	4.00	60.00	60.00	0.74	-16.68	-2.72	-1.16	4.00	1.39	1.02	-0.51	-0.58	4.00	6.40	0.42
60.00	70.00	-8.66	0.88	-4.30	-10.60	4.00	60.00	70.00	1.88	-17.35	-6.12	0.21	4.00	2.25	-3.20	-5.20	3.20	4.00	5.98	0.56
60.00	80.00	-11.45	0.74	-4.03	-11.71	4.00	60.00	80.00	2.73	-16.51	-10.75	1.15	4.00	2.89	0.82	-6.10	1.37	4.00	6.36	0.77
60.00	90.00	-16.32	0.54	-4.10	-11.95	4.00	60.00	90.00	3.37	-15.95	-21.05	1.76	4.00	3.42	0.64	-6.20	1.94	4.00	6.64	1.10
60.00	100.00	-16.45	0.52	-4.15	-11.68	4.00	60.00	100.00	3.54	-15.98	-15.25	2.08	4.00	3.58	0.62	-3.83	2.26	4.00	7.09	1.41
60.00	110.00	-10.84	0.34	-4.38	-11.20	4.00	60.00	110.00	3.47	-15.03	-8.64	2.09	4.00	3.63	0.46	-3.00	2.29	4.00	7.20	1.47
60.00	120.00	-6.43	0.11	-4.61	-11.76	4.00	60.00	120.00	3.7	-15.02	-4.32	1.68	4.00	3.47	0.24	-1.45	1.87	4.00	7.25	1.41
60.00	130.00	-3.74	0.02	-5.31	-11.84	4.00	60.00	130.00	1.74	-15.21	-1.29	0.67	4.00	2.82	0.15	0.16	0.91	4.00	7.10	1.16
60.00	140.00	-2.56	0.06	-6.40	-10.32	4.00	60.00	140.00	-0.76	-14.95	0.41	-1	4.00	1.44	0.19	1.23	-0.52	4.00	6.64	0.66
60.00	150.00	-2.65	-0.05	-8.63	-7.89	4.00	60.00	150.00	-5.22	-15	1.35	-3.44	4.00	-0.74	0.09	1.77	-2.11	4.00	5.89	-0.02
60.00	160.00	-3.90	-0.55	-12.73	-5.53	4.00	60.00	160.00	-13.55	-13.67	1.8	-7.25	4.00	-3.45	-0.34	1.95	-3.30	4.00	5.03	-0.69
60.00	170.00	-5.18	-1.17	-20.90	-4.31	4.00	60.00	170.00	-35.07	-11.65	1.88	-12.12	4.00	-5.18	-0.80	1.90	-3.64	4.00	4.52	-1.08
60.00	180.00	-7.49	-2.15	-27.59	-4.06	4.00	60.00	180.00	-13.47	-9.21	1.73	-12.31	4.00	-6.51	-1.37	1.74	-3.45	4.00	4.14	-1.40
60.00	190.00	-10.59	-2.98	-19.82	-4.52	4.00	60.00	190.00	-8.74	-7.55	1.36	-7.01	4.00	-6.56	-1.68	1.39	-2.58	4.00	4.11	-1.50
60.00	200.00	-11.81	-3.35	-17.35	-5.39	4.00	60.00	200.00	-7.6	-6.84	0.56	-3.47	4.00	-6.20	-1.74	0.63	-1.31	4.00	4.20	-1.54
60.00	210.00	-8.64	-3.59	-13.21	-5.85	4.00	60.00	210.00	-9.79	-7.12	-0.81	-1.61	4.00	-6.17	-2.00	-0.57	-0.22	4.00	4.08	-1.71
60.00	220.00	-7.08	-4.24	-9.52	-6.21	4.00	60.00	220.00	-14.63	-7.08	-2.69	-0.33	4.00	-6.38	-2.42	-1.87	0.67	4.00	3.87	-1.84
60.00	230.00	-7.58	-5.54	-7.40	-6.88	4.00	60.00	230.00	-11.18	-6.7	-5.16	0.67	4.00	-6.01	-3.07	-3.13	1.37	4.00	3.73	-1.87
60.00	240.00	-8.97	-7.43	-6.77	-7.84	4.00	60.00	240.00	-6.76	-6.91	-8.48	1.21	4.00	-4.72	-4.15	-4.53	1.72	4.00	3.56	-1.94
60.00	250.00	-12.71	-9.59	-6.50	-9.78	4.00	60.00	250.00	-4.36	-8.47	-13.76	1.53	4.00	-3.77	-5.98	-5.75	1.84	4.00	3.23	-2.10
60.00	260.00	-19.49	-11.58	-7.03	-12.23	4.00	60.00	260.00	-3.36	-10.89	-20.18	1.57	4.00	-3.26	-8.21	-6.82	1.75	4.00	2.78	-2.35
60.00	270.00	-28.06	-12.76	-7.60	-17.53	4.00	60.00	270.00	-3.34	-15.34	-19.3	1.44	4.00	-3.33	-10.85	-7.32	1.49	4.00	2.24	-2.71
60.00	280.00	-15.44	-11.43	-7.99	-26.53	4.00	60.00	280.00	-4.33	-19.84	-14.06	1.34	4.00	-4.01	-10.84	-7.03	1.35	4.00	2.04	-2.92
60.00	290.00	-12.01	-9.53	-8.49	-21.30	4.00	60.00	290.00	-6.36	-16.99	-10.93	1.11	4.00	-5.31	-8.81	-6.53	1.13	4.00	1.99	-3.13
60.00	300.00	-10.85	-7.25	-9.14	-13.57	4.00	60.00	300.00	-9.85	-15.12	-7.66	0.62	4.00	-7.31	-6.59	-5.33	0.78	4.00	2.06	-3.24
60.00	310.00	-10.83	-5.39	-10.27	-9.58	4.00	60.00	310.00	-9.86	-16.79	-4.71	-0.63	4.00	-7.31	-5.09	-3.64	-0.11	4.00	2.39	-3.23
60.00	320.00	-8.90	-3.38	-12.74	-6.89	4.00	60.00	320.00	-8.83	-17.15	-2.65	-2.62	4.00	-5.85	-3.20	-2.24	-1.24	4.00	3.05	-2.83
60.00	330.00	-5.64	-1.35	-15.94	-5.18	4.00	60.00	330.00	-10.54	-13.94	-1.24	-5.37	4.00	-4.42	-1.12	-1.10	-2.26	4.00	3.90	-2.03
60.00	340.00	-3.88	-0.30	-19.64	-4.38	4.00	60.00	340.00	-17.7	-13.77	-0.16	-8.84	4.00	-3.70	-0.11	-0.11	-3.05	4.00	4.43	-1.44
60.00	350.00	-3.88	-0.12	-20.61	-4.72	4.00	60.00	350.00	-36.29	-16.09	0.47	-13.48	4.00	-3.88	-0.01	0.50	-4.18	4.00	4.39	-1.38
75.00	0.00	-12.89	0.85	-23.36	-13.94	4.00	75.00	0.00	-11.79	-17.95	0.4	-21.25	4.00	-9.29	0.91	0.42	-13.20	4.00	2.67	-2.04
75.00	10.00	-13.19	1.47	-25.06	-15.11	4.00	75.00	10.00	-7.6	-20.43	1	-18.68	4.00	-6.54	1.50	1.01	-13.53	4.00	3.50	-1.34
75.00	20.00	-13.75	2.40	-19.05	-16.54	4.00	75.00	20.00	-3.94	-31.32	1.51	-10.74	4.00	-3.51	2.40	1.55	-9.73	4.00	4.88	-0.32
75.00	30.																			



10500	0.00	-12.00	0.37	-18.60	-10.55	4.00	10500	0.00	-13.51	-13.51	-3.08	-12.61	4.00	-9.68	0.54	-2.96	-8.45	4.00	1.88	-3.26
10500	10.00	-13.21	0.72	-23.74	-8.88	4.00	10500	10.00	-10.97	-12.24	-2.2	-13.67	4.00	-8.94	0.93	-2.17	-7.64	4.00	2.49	-2.70
10500	20.00	-8.49	0.66	-28.41	-8.71	4.00	10500	20.00	-5.93	-14.01	-1.14	-13.75	4.00	-4.01	0.81	-1.13	-7.53	4.00	3.60	-1.96
10500	30.00	-6.86	-0.13	-27.23	-10.78	4.00	10500	30.00	-4.15	-18.53	-1.12	-12.17	4.00	-2.29	-0.07	-1.11	-8.41	4.00	3.58	-2.05
10500	40.00	-8.22	-1.05	-17.61	-14.01	4.00	10500	40.00	-3.32	-21.18	-1.64	-8	4.00	-2.10	-1.01	-1.53	-7.03	4.00	3.40	-2.38
10500	50.00	-12.86	-1.10	-13.34	-15.68	4.00	10500	50.00	-2.44	-23.96	-2.78	-4.89	4.00	-2.06	-1.08	-2.41	-4.54	4.00	3.59	-2.35
10500	60.00	-20.07	-0.57	-12.02	-15.79	4.00	10500	60.00	-2.32	-20.13	-4.96	-3.17	4.00	-2.25	-0.52	-4.18	-2.94	4.00	3.65	-2.27
10500	70.00	-18.2	0.75	-11.19	-15.61	4.00	10500	70.00	-2.19	-17.56	-7.95	-1.88	4.00	-2.08	0.81	-6.26	-1.70	4.00	4.06	-1.65
10500	80.00	-16.71	2.05	-10.33	-14.71	4.00	10500	80.00	-1.82	-19.14	-13.14	-0.91	4.00	-1.68	2.08	-8.50	-0.73	4.00	4.58	-0.86
10500	90.00	-18.05	3.15	-9.56	-16.17	4.00	10500	90.00	-1.13	-25.54	-25.86	-0.26	4.00	-1.04	3.16	-9.46	-0.15	4.00	5.21	-0.07
10500	100.00	-20.09	3.93	-9.20	-18.52	4.00	10500	100.00	-0.63	-41.73	-14.73	0.31	4.00	-0.58	3.93	-8.13	0.37	4.00	5.90	0.60
10500	110.00	-20.14	4.34	-9.39	-20.86	4.00	10500	110.00	-0.33	-25.02	-9.21	0.73	4.00	-0.28	4.35	-6.29	0.76	4.00	6.43	1.04
10500	120.00	-16.56	4.62	-10.08	-16.13	4.00	10500	120.00	-0.41	-19.97	-6.03	0.9	4.00	-0.31	4.64	-4.59	0.99	4.00	6.81	1.34
10500	130.00	-11.97	4.91	-11.86	-13.15	4.00	10500	130.00	-0.79	-15.73	-4.1	0.71	4.00	-0.47	4.95	-3.43	0.88	4.00	7.04	1.54
10500	140.00	-8.66	4.82	-16.26	-12.42	4.00	10500	140.00	-1.94	-13.04	-2.95	-0.34	4.00	-1.10	4.89	-2.75	-0.08	4.00	6.76	1.28
10500	150.00	-6.91	4.11	-22.94	-14.01	4.00	10500	150.00	-4.97	-12.79	-2.7	-2.56	4.00	-2.82	4.20	-2.66	-2.26	4.00	5.69	0.30
10500	160.00	-5.83	3.18	-21.55	-17.20	4.00	10500	160.00	-12.85	-15.7	-2.85	-6.27	4.00	-5.04	3.24	-2.79	-5.93	4.00	4.19	-0.97
10500	170.00	-5.24	2.10	-18.21	-16.70	4.00	10500	170.00	-30.23	-16.03	-3.09	-11.74	4.00	-5.23	2.17	-2.96	-10.54	4.00	3.05	-1.97
10500	180.00	-5.30	0.43	-19.53	-14.44	4.00	10500	180.00	-17.01	-15.09	-3.28	-16.85	4.00	-5.02	0.55	-3.18	-12.47	4.00	2.14	-3.04
10500	190.00	-5.74	-1.34	-23.80	-15.02	4.00	10500	190.00	-12.1	-23.77	-3.39	-14.14	4.00	-4.84	-1.32	-3.35	-11.55	4.00	1.50	-3.98
10500	200.00	-7.06	-1.94	-14.46	-17.63	4.00	10500	200.00	-7.72	-19.85	-3.86	-8.6	4.00	-4.37	-1.87	-3.50	-8.09	4.00	1.85	-3.93
10500	210.00	-9.90	-2.26	-11.87	-22.62	4.00	10500	210.00	-7.38	-18.09	-5.54	-4.97	4.00	-5.45	-2.15	-4.63	-4.90	4.00	1.84	-4.08
10500	220.00	-18.78	-3.07	-13.26	-21.09	4.00	10500	220.00	-11.91	-25.82	-9.46	-2.1	4.00	-11.10	-3.05	-7.95	-2.05	4.00	0.72	-4.69
10500	230.00	-17.92	-4.63	-16.97	-18.12	4.00	10500	230.00	-23.78	-24.84	-11	-0.34	4.00	-16.92	-4.59	-10.02	-0.27	4.00	0.07	-4.54
10500	240.00	-14.01	-5.95	-17.46	-17.92	4.00	10500	240.00	-10.17	-18.75	-9.5	0.8	4.00	-8.67	-5.73	-8.86	0.86	4.00	1.40	-3.59
10500	250.00	-14.22	-6.03	-14.78	-18.15	4.00	10500	250.00	-6.96	-16.97	-9.36	1.44	4.00	-6.21	-5.69	-8.26	1.49	4.00	2.22	-2.87
10500	260.00	-18.69	-5.17	-13.22	-17.45	4.00	10500	260.00	-6.38	-16.54	-12.13	1.65	4.00	-6.13	-4.86	-9.63	1.70	4.00	2.32	-2.68
10500	270.00	-26.80	-5.34	-12.74	-15.37	4.00	10500	270.00	-7.52	-16.96	-17.67	1.28	4.00	-7.47	-5.05	-11.53	1.37	4.00	1.65	-3.16
10500	280.00	-37.42	-7.73	-12.86	-13.88	4.00	10500	280.00	-1.2	-17.51	-28.58	0.88	4.00	-11.99	-7.30	-12.75	0.25	4.00	-0.25	-4.68
10500	290.00	-27.91	-18.79	-13.46	-12.79	4.00	10500	290.00	-22.15	-18.86	-18.42	-2.59	4.00	-21.13	-15.81	-12.26	-2.19	4.00	-3.94	-7.59
10500	300.00	-17.87	-10.30	-12.81	-13.49	4.00	10500	300.00	-10.36	-21.44	-15.33	-7.83	4.00	-9.65	-9.98	-10.88	-6.79	4.00	-3.16	-9.03
10500	310.00	-11.15	-3.33	-10.29	-15.32	4.00	10500	310.00	-6.98	-18.93	-14.92	-14.42	4.00	-5.57	-3.21	-9.00	-11.84	4.00	-0.78	-6.26
10500	320.00	-7.36	-1.77	-9.07	-18.30	4.00	10500	320.00	-7.7	-12.38	-13.31	-10.1	4.00	-4.52	-1.41	-7.68	-9.49	4.00	0.80	-4.69
10500	330.00	-6.03	-3.25	-9.44	-22.60	4.00	10500	330.00	-11.07	-9.47	-9.45	-8.08	4.00	-4.85	-2.32	-6.43	-7.93	4.00	0.89	-4.87
10500	340.00	-5.92	-4.15	-10.63	-30.78	4.00	10500	340.00	-12.07	-9.59	-5.78	-7.49	4.00	-4.98	-3.06	-4.55	-7.47	4.00	1.15	-4.74
10500	350.00	-8.10	-1.11	-13.56	-16.13	4.00	10500	350.00	-11.01	-13.43	-4.21	-9.37	4.00	-6.31	-0.86	-3.73	-8.54	4.00	1.63	-3.93
12000	0.00	-9.80	-2.78	-18.39	-8.47	4.00	12000	0.00	-14.29	-17.68	-6.03	-11.93	4.00	-8.48	-2.64	-5.78	-6.85	4.00	0.35	-5.39
12000	10.00	-4.75	-3.71	-20.03	-9.00	4.00	12000	10.00	-14.52	-21.85	-5.37	-11.15	4.00	-4.31	-3.64	-5.22	-6.93	4.00	1.08	-4.86
12000	20.00	-2.53	-4.26	-22.03	-9.40	4.00	12000	20.00	-7.28	-27	-4.7	-10.84	4.00	-1.28	-4.24	-4.62	-7.05	4.00	1.97	-3.81
12000	30.00	-2.69	-3.72	-24.08	-9.68	4.00	12000	30.00	-5.68	-20.61	-3.69	-11.94	4.00	-0.92	-3.63	-3.65	-7.65	4.00	2.37	-3.36
12000	40.00	-4.31	-3.31	-22.10	-9.65	4.00	12000	40.00	-6.02	-14.94	-3.07	-12.42	4.00	-2.07	-3.02	-3.02	-7.81	4.00	2.30	-3.51
12000	50.00	-6.69	-2.23	-14.11	-9.72	4.00	12000	50.00	-6.31	-13.75	-3.24	-10.09	4.00	-3.49	-1.93	-2.90	-6.89	4.00	2.41	-3.45
12000	60.00	-9.80	-0.69	-9.74	-9.65	4.00	12000	60.00	-6.29	-13.37	-4.79	-6.46	4.00	-4.69	-0.46	-3.58	-4.76	4.00	2.83	-2.99
12000	70.00	-12.71	0.69	-7.48	-10.79	4.00	12000	70.00	-5.77	-13.97	-7.89	-3.54	4.00	-4.97	0.84	-4.67	-2.79	4.00	3.45	-2.22
12000	80.00	-15.91	1.72	-6.34	-13.32	4.00	12000	80.00	-4.37	-15.51	-12.78	-1.8	4.00	-4.08	1.80	-5.45	-1.50	4.00	4.17	-1.40
12000	90.00	-17.72	2.42	-5.65	-17.26	4.00	12000	90.00	-2.91	-18.9	-22.94	-0.48	4.00	-2.77	2.45	-5.57	-0.39	4.00	4.95	-0.61
12000	100.00	-15.67	2.90	-5.96	-17.35	4.00	12000	100.00	-1.94	-24.68	-12.15	0.08	4.00	-1.76	2.91	-5.02	0.16	4.00	5.56	-0.03
12000	110.00	-13.14	3.17	-6.52	-13.94	4.00	12000	110.00	-1.16	-32.39	-7.27	0.14	4.00	-0.89	3.17	-3.87	0.31	4.00	6.06	0.39
12000	120.00	-10.08	3.21	-8.22	-9.38	4.00	12000	120.00	-0.7	-20.83	-4.05	-0.04	4.00	-0.23	3.23	-2.64	0.44	4.00	6.47	0.70
12000	130.00	-8.52	2.96	-10.94	-6.98	4.00	12000	130.00	-0.73	-14.64	-2.25	-0.72	4.00	-0.06	3.03	-1.70	0.20	4.00	6.56	0.72
12000	140.00	-7.54	2.38	-15.17	-5.59	4.00	12000	140.00	-1.58	-12.22	-1.46	-2.04	4.00	-0.60	2.53	-1.28	-0.45	4.00	6.20	0.32
12000	150.00	-6.42	1.92	-18.45	-5.20	4.00	12000	150.00	-4.05	-12.76	-1.18	-4.66	4.00	-2.06	2.07	-1.10	-1.91	4.00	5.44	-0.40
12000	160.00	-5.55	1.42	-19.32	-5.78	4.00	12000	160.00	-9.39	-12.14	-2.18	-8.54	4.00	-4.05	1.61	-2.10	-3.93	4.00	4.22	-1.45
12000	170.00	-5.62	0.60	-21.36	-6.92	4.00	12000	170.00	-19.24	-11.23	-3.73	-13.68	4.00	-5.44	0.88	-3.66	-6.09	4.00	2.90	-2.62
12000	180.00	-6.27	-0.25	-18.45	-7.26	4.00	12000	180.00	-18.06	-13.3	-4.52	-1.8	4.00	-5.99	-0.04	-4.35	-6.91	4.00	2.13	-3.43
12000	190.00	-7.31	-0.61	-14.20	-7.24	4.00	12000	190.00	-9.39	-20.62	-4.73	-11.64	4.00	-5.22	-0.57	-4.27	-5.89	4.00	2.29	-3.44
12000	200.00	-9.06	-1.29	-11.22	-8.61	4.00	12000	200.00	-5.24	-26.74	-6.35	-7.23	4.00	-3.73	-1.28	-5.13	-4.86	4.00	2.41	-3.46
12000	210.00	-12.87	-3.12	-10.11	-10.47	4.00	12000	210.00	-3.83	-18.99	-10.86	-5.61	4.00	-3.32	-3.01	-7.46	-4.38	4.00	1.65	-4.23
12000	220.00	-14.86	-4.50	-10.05	-12.61	4.00	12000	220.00	-4.26	-15.42	-13.74	-4.63	4.00	-3.80	-4.16	-8.50	-3.99	4.00	1.08	-4.78
12000	230.00	-13.99	-4.40	-9.76	-13.70	4.00	12000	230.00	-4.87	-15.53	-10.76	-3.07	4.00	-4.37	-4.08	-7.22	-2.71	4.00	1.57	-4.31
12000	240.00	-14.04	-3.85	-9.32	-16.55	4.00	12000	240.00	-4.37	-19.19	-10	-1.26	4.00	-3.93						



15000	22000	-2.32	-5.37	-14.48	-16.38	4.00	15000	22000	-3.51	-21.13	-12.52	-7.96	4.00	0.14	-5.26	-10.38	-7.38	4.00	1.18	-3.97
15000	23000	-3.41	-4.84	-16.20	-12.35	4.00	15000	23000	-1.28	-23.51	-9.73	-5.3	4.00	0.79	-4.78	-8.85	-4.52	4.00	2.37	-2.97
15000	24000	-5.63	-4.40	-18.81	-11.78	4.00	15000	24000	0.25	-22.33	-8.68	-3.09	4.00	1.33	-4.33	-8.28	-2.54	4.00	3.24	-2.16
15000	25000	-9.65	-4.30	-18.10	-14.14	4.00	15000	25000	1.22	-20.47	-9.32	-1.59	4.00	1.56	-4.20	-8.78	-1.36	4.00	3.62	-1.74
15000	26000	-18.98	-4.73	-15.54	-16.43	4.00	15000	26000	1.47	-18.63	-11.36	-1.03	4.00	1.51	-4.56	-9.96	-0.91	4.00	3.52	-1.74
15000	27000	-19.57	-5.65	-13.57	-15.55	4.00	15000	27000	1.08	-15.25	-16.72	-1.02	4.00	1.12	-5.20	-11.86	-0.87	4.00	3.07	-2.08
15000	28000	-10.63	-6.94	-13.25	-11.85	4.00	15000	28000	-0.09	-12.06	-28.22	-2.1	4.00	0.28	-5.78	-13.11	-1.66	4.00	2.26	-2.88
15000	29000	-7.92	-9.12	-15.35	-10.99	4.00	15000	29000	-1.95	-9.25	-17.86	-4.08	4.00	-0.97	-6.17	-13.42	-3.27	4.00	1.16	-4.10
15000	30000	-7.04	-12.10	-20.49	-12.79	4.00	15000	30000	-5.67	-7.52	-13.27	-8.12	4.00	-3.29	-6.22	-12.52	-6.85	4.00	-0.61	-6.15
15000	31000	-8.54	-12.87	-16.91	-19.61	4.00	15000	31000	-12.03	-6.6	-11.45	-16.62	4.00	-6.93	-5.68	-10.36	-14.85	4.00	-2.77	-8.26
15000	32000	-13.31	-9.36	-11.65	-20.48	4.00	15000	32000	-17.67	-7.13	-13.74	-23.32	4.00	-11.95	-5.09	-9.56	-18.66	4.00	-4.03	-9.05
15000	33000	-33.45	-6.95	-9.76	-10.39	4.00	15000	33000	-14.57	-8.53	-19.16	-15.1	4.00	-14.51	-4.66	-9.29	-9.13	4.00	-2.70	-8.11
15000	34000	-14.13	-5.75	-9.94	-7.98	4.00	15000	34000	-14.95	-10.66	-21.45	-12.18	4.00	-11.51	-4.53	-9.64	-6.58	4.00	-1.63	-7.26
15000	35000	-10.19	-5.52	-11.54	-7.90	4.00	15000	35000	-17.82	-11.68	-14.95	-11.6	4.00	-9.50	-4.58	-9.91	-6.36	4.00	-1.28	-7.02
16500	000	-2.57	-8.12	-17.78	-3.85	4.00	16500	000	-22.79	-11.99	-10.33	-17.41	4.00	-2.53	-6.63	-9.61	-3.66	4.00	0.83	-4.83
16500	1000	-2.88	-9.23	-16.36	-4.07	4.00	16500	1000	-38.82	-10.68	-10.24	-14.72	4.00	-2.88	-6.88	-9.29	-3.71	4.00	0.69	-5.00
16500	2000	-3.69	-11.27	-13.77	-4.09	4.00	16500	2000	-18.33	-9.21	-9.85	-11.72	4.00	-3.54	-7.11	-8.37	-3.40	4.00	0.68	-5.09
16500	3000	-4.52	-12.49	-11.08	-4.35	4.00	16500	3000	-12.5	-8.33	-10.05	-9.52	4.00	-3.88	-6.92	-7.52	-3.20	4.00	0.84	-4.99
16500	4000	-5.24	-13.45	-8.95	-4.55	4.00	16500	4000	-9.34	-7.9	-10.43	-7.74	4.00	-3.81	-6.83	-6.62	-2.85	4.00	1.17	-4.69
16500	5000	-6.11	-12.79	-7.32	-5.15	4.00	16500	5000	-6.95	-7.79	-11.35	-5.98	4.00	-3.50	-6.60	-5.87	-2.53	4.00	1.55	-4.31
16500	6000	-7.05	-10.27	-6.06	-6.16	4.00	16500	6000	-5.21	-7.98	-14.1	-4.4	4.00	-3.02	-5.97	-5.43	-2.18	4.00	2.02	-3.86
16500	7000	-8.43	-8.40	-5.35	-8.36	4.00	16500	7000	-3.78	-8.32	-18.29	-3.14	4.00	-2.50	-5.35	-5.13	-2.00	4.00	2.41	-3.49
16500	8000	-10.27	-7.15	-4.87	-12.03	4.00	16500	8000	-2.78	-9.35	-26	-2.39	4.00	-2.07	-5.10	-4.84	-1.94	4.00	2.66	-3.24
16500	9000	-12.97	-6.41	-4.78	-18.75	4.00	16500	9000	-2.3	-10.75	-23.63	-1.95	4.00	-1.94	-5.05	-4.72	-1.86	4.00	2.75	-3.14
16500	10000	-15.10	-6.02	-5.18	-28.21	4.00	16500	10000	-2.24	-13.18	-16.16	-1.97	4.00	-2.02	-5.26	-4.85	-1.96	4.00	2.63	-3.25
16500	11000	-13.43	-6.02	-5.77	-15.93	4.00	16500	11000	-2.44	-15.7	-12.25	-2.49	4.00	-2.11	-5.58	-4.89	-2.30	4.00	2.44	-3.45
16500	12000	-8.98	-5.93	-6.72	-11.53	4.00	16500	12000	-3.01	-17.42	-10.25	-3.37	4.00	-2.03	-5.63	-5.13	-2.75	4.00	2.27	-3.62
16500	13000	-5.48	-5.96	-8.26	-9.18	4.00	16500	13000	-3.82	-16.43	-8.72	-4.88	4.00	-1.56	-5.59	-5.47	-3.51	4.00	2.15	-3.71
16500	14000	-3.13	-6.30	-9.98	-7.89	4.00	16500	14000	-5.03	-14.09	-8.2	-6.68	4.00	-0.97	-5.63	-5.99	-4.23	4.00	2.05	-3.71
16500	15000	-1.19	-6.75	-12.38	-6.87	4.00	16500	15000	-6.88	-12.15	-8.07	-9.2	4.00	-0.15	-5.65	-6.70	-4.87	4.00	2.07	-3.52
16500	16000	0.37	-7.47	-16.13	-6.00	4.00	16500	16000	-9.79	-10.61	-8.71	-12.5	4.00	0.77	-5.75	-7.99	-5.12	4.00	2.15	-3.17
16500	17000	1.46	-8.59	-24.74	-5.17	4.00	16500	17000	-15.41	-8.86	-9.67	-16.76	4.00	1.55	-5.71	-9.54	-4.88	4.00	2.34	-2.73
16500	18000	2.33	-9.63	-25.73	-4.28	4.00	16500	18000	-22.49	-8.14	-10.7	-22.49	4.00	2.34	-5.81	-10.57	-4.21	4.00	2.71	-2.14
16500	19000	2.79	-9.51	-18.61	-3.38	4.00	16500	19000	-11.17	-7.58	-10.26	-21.92	4.00	2.96	-5.43	-9.67	-3.32	4.00	3.38	-1.49
16500	20000	2.74	-9.54	-14.04	-2.81	4.00	16500	20000	-5.51	-7.46	-9.04	-15.82	4.00	3.35	-5.37	-7.85	-2.60	4.00	3.96	-1.02
16500	21000	2.42	-8.64	-11.47	-2.56	4.00	16500	21000	-2.6	-7.25	-8.01	-11.94	4.00	3.61	-4.88	-6.39	-2.09	4.00	4.48	-0.62
16500	22000	1.45	-7.37	-8.94	-2.59	4.00	16500	22000	-0.29	-7.56	-7.01	-8.73	4.00	3.68	-4.45	-4.86	-1.64	4.00	4.92	-0.34
16500	23000	-0.06	-6.73	-7.15	-2.95	4.00	16500	23000	1.21	-8.07	-7.18	-6.2	4.00	3.63	-4.34	-4.15	-1.27	4.00	5.13	-0.21
16500	24000	-2.54	-6.34	-5.57	-3.82	4.00	16500	24000	2.18	-9.08	-8.42	-4.21	4.00	3.44	-4.49	-3.75	-1.00	4.00	5.16	-0.25
16500	25000	-6.37	-6.27	-4.33	-5.48	4.00	16500	25000	2.71	-10.34	-10.84	-2.79	4.00	3.22	-4.83	-3.45	-0.92	4.00	5.09	-0.35
16500	26000	-13.87	-6.59	-3.79	-7.85	4.00	16500	26000	2.81	-11.76	-16.15	-1.84	4.00	2.90	-5.44	-3.54	-0.87	4.00	4.86	-0.58
16500	27000	-17.97	-7.20	-3.45	-12.47	4.00	16500	27000	2.46	-12.67	-21.12	-1.42	4.00	2.50	-6.12	-3.38	-1.09	4.00	4.58	-0.89
16500	28000	-10.29	-7.74	-3.61	-20.75	4.00	16500	28000	1.74	-14.09	-13.78	-1.28	4.00	2.00	-6.83	-3.21	-1.23	4.00	4.28	-1.21
16500	29000	-6.36	-7.62	-4.50	-16.95	4.00	16500	29000	0.65	-15.01	-9.47	-1.68	4.00	1.44	-6.89	-3.30	-1.55	4.00	3.95	-1.60
16500	30000	-4.22	-6.93	-6.07	-10.80	4.00	16500	30000	-0.98	-17.33	-7.16	-2.45	4.00	0.71	-6.55	-3.57	-1.86	4.00	3.60	-2.06
16500	31000	-2.98	-6.17	-8.75	-7.48	4.00	16500	31000	-2.88	-19.37	-5.98	-4.04	4.00	0.08	-5.97	-4.14	-2.42	4.00	3.20	-2.54
16500	32000	-2.27	-5.72	-13.04	-5.66	4.00	16500	32000	-5.24	-23.62	-5.89	-6.38	4.00	-0.50	-5.65	-5.12	-2.99	4.00	2.70	-3.07
16500	33000	-1.94	-5.59	-18.89	-4.53	4.00	16500	33000	-7.37	-22.96	-6.27	-9.31	4.00	-0.85	-5.51	-6.04	-3.28	4.00	2.35	-3.41
16500	34000	-1.94	-6.03	-39.51	-4.04	4.00	16500	34000	-10.65	-18.52	-7.58	-15	4.00	-1.39	-5.79	-7.58	-3.71	4.00	1.71	-4.01
16500	35000	-2.22	-6.84	-22.17	-4.03	4.00	16500	35000	-15.24	-14.93	-9.24	-21.01	4.00	-2.01	-6.21	-9.02	-3.94	4.00	1.11	-4.57
18000	000	2.48	-11.54	-29.03	-0.46	4.00	18000	000	-14.77	-10.24	-7.01	-14.45	4.00	2.56	-7.83	-6.98	-0.29	4.00	3.98	-1.10
18000	1000	2.55	-10.05	-18.99	-0.29	4.00	18000	1000	-25.81	-11.8	-7.27	-33.14	4.00	2.56	-7.83	-6.99	-0.29	4.00	3.98	-1.10
18000	2000	2.36	-9.01	-14.62	-0.39	4.00	18000	2000	-10.95	-14.04	-7.8	-16.7	4.00	2.56	-7.82	-6.98	-0.29	4.00	3.98	-1.10
18000	3000	1.89	-8.33	-11.91	-0.76	4.00	18000	3000	-5.9	-17.46	-8.67	-10.17	4.00	2.56	-7.83	-6.98	-0.29	4.00	3.98	-1.10
18000	4000	1.11	-7.94	-10.06	-1.43	4.00	18000	4000	-2.91	-23.69	-9.92	-6.66	4.00	2.56	-7.83	-6.98	-0.29	4.00	3.98	-1.10
18000	5000	-0.05	-7.83	-8.77	-2.44	4.00	18000	5000	-0.9	-45.7	-11.71	-4.37	4.00	2.56	-7.83	-6.99	-0.29	4.00	3.98	-1.10
18000	6000	-1.69	-7.98	-7.87	-3.90	4.00	18000	6000	0.51	-22.43	-14.31	-2.78	4.00	2.56	-7.83	-6.98	-0.29	4.00	3.98	-1.10
18000	7000	-4.06	-8.41	-7.30	-5.98	4.00	18000	7000	1.49	-16.85	-18.46	-1.66	4.00	2.56	-7.83	-6.98	-0.29	4.00	3.98	-1.10
18000	8000	-7.73	-9.14	-7.02	-9.09	4.00	18000	8000	2.13	-13.66	-27.4	-0.91	4.00	2.56	-7.83	-6.98	-0.29	4.00	3.98	-1.10
18000	9000	-14.77	-10.24	-7.01	-14.45	4.00	18000	9000	2.48	-11.54	-29.03	-0.46	4.00	2.56	-7.83	-6.98	-0.29	4.00	3.98	-1.10
18000	10000	-25.81	-11.80	-7.27	-33.14	4.00	18000	10000	2.55	-10.05	-18.99	-0.29	4.00	2.56	-7.83	-6.98	-0.29	4.00	3.98	-1.10
18000	11000	-10.95	-14.04	-7.80	-16.70	4.00	18000	11000	2.36	-9										



Frequency: 2442MHz

Theta Polarization		Max Gain(dB)				Nant	Phi Polarization		Max Gain(dB)				Nant	Total				Nant	Max DG(dB)					
Angle (θ)	Angle (ψ)	Ant 1(G1)	Ant 2(G2)	Ant 3(G3)	Ant 4(G4)		Angle (θ)	Angle (ψ)	Ant 1(G1)	Ant 2(G2)	Ant 3(G3)	Ant 4(G4)		Ant 1(G1)	Ant 2(G2)	Ant 3(G3)	Ant 4(G4)		7.24	1.57				
		2.42	4.76	3.65	-0.25				3.72	-4.82	3.65	3.14									3.93	4.84	3.68	3.20
		Ant 1(G1)	Ant 2(G2)	Ant 3(G3)	Ant 4(G4)				Ant 1(G1)	Ant 2(G2)	Ant 3(G3)	Ant 4(G4)									Ant 1(G1)	Ant 2(G2)	Ant 3(G3)	Ant 4(G4)
0.00	0.00	-0.49	-12.67	-19.38	-0.87	4.00	0.00	0.00	-20.37	-12.79	3.65	-10.7	4.00	-0.45	-9.72	3.67	-0.44	4.00	5.47	0.25				
0.00	10.00	-0.47	-11.41	-8.63	-0.52	4.00	0.00	10.00	-23.13	-14.63	3.41	-17.72	4.00	-0.45	-9.72	3.67	-0.44	4.00	5.47	0.26				
0.00	20.00	-0.72	-10.54	-4.13	-0.44	4.00	0.00	20.00	-12.65	-17.33	2.89	-29.01	4.00	-0.45	-9.71	3.68	-0.43	4.00	5.47	0.26				
0.00	30.00	-1.25	-10.00	-1.37	-0.63	4.00	0.00	30.00	-8.19	-21.68	2.04	-13.98	4.00	-0.45	-9.71	3.67	-0.43	4.00	5.47	0.26				
0.00	40.00	-2.10	-9.74	0.52	-1.10	4.00	0.00	40.00	-5.45	-31.61	0.81	-8.92	4.00	-0.45	-9.71	3.68	-0.44	4.00	5.47	0.26				
0.00	50.00	-3.34	-9.76	1.84	-1.88	4.00	0.00	50.00	-3.58	-30.26	-0.95	-5.92	4.00	-0.45	-9.72	3.68	-0.44	4.00	5.47	0.26				
0.00	60.00	-5.11	-10.03	2.75	-3.04	4.00	0.00	60.00	-2.27	-21.24	-3.5	-3.91	4.00	-0.45	-9.71	3.67	-0.44	4.00	5.47	0.25				
0.00	70.00	-7.68	-10.60	3.33	-4.68	4.00	0.00	70.00	-1.36	-17.07	-7.54	-2.49	4.00	-0.45	-9.72	3.67	-0.44	4.00	5.47	0.25				
0.00	80.00	-11.75	-11.49	3.63	-7.05	4.00	0.00	80.00	-0.78	-14.46	-15.99	-1.51	4.00	-0.45	-9.72	3.68	-0.44	4.00	5.47	0.26				
0.00	90.00	-20.37	-12.79	3.65	-10.70	4.00	0.00	90.00	-0.49	-12.67	-19.38	-0.87	4.00	-0.45	-9.72	3.67	-0.44	4.00	5.47	0.25				
0.00	100.00	-23.13	-14.63	3.41	-17.72	4.00	0.00	100.00	-0.47	-11.41	-8.63	-0.52	4.00	-0.45	-9.72	3.67	-0.44	4.00	5.47	0.26				
0.00	110.00	-12.65	-17.33	2.89	-29.01	4.00	0.00	110.00	-0.72	-10.54	-4.13	-0.44	4.00	-0.45	-9.71	3.68	-0.43	4.00	5.47	0.26				
0.00	120.00	-8.19	-21.68	2.04	-13.98	4.00	0.00	120.00	-1.25	-10	-1.37	-0.63	4.00	-0.45	-9.71	3.67	-0.43	4.00	5.47	0.26				
0.00	130.00	-5.45	-31.61	0.81	-8.92	4.00	0.00	130.00	-2.1	-9.74	0.52	-1.1	4.00	-0.45	-9.71	3.68	-0.44	4.00	5.47	0.26				
0.00	140.00	-3.58	-30.26	-0.95	-5.92	4.00	0.00	140.00	-3.34	-9.76	1.84	-1.88	4.00	-0.45	-9.72	3.68	-0.44	4.00	5.47	0.26				
0.00	150.00	-2.27	-21.24	-3.50	-3.91	4.00	0.00	150.00	-5.11	-10.03	2.75	-3.04	4.00	-0.45	-9.71	3.67	-0.44	4.00	5.47	0.25				
0.00	160.00	-1.36	-17.07	-7.54	-2.49	4.00	0.00	160.00	-7.68	-10.6	3.33	-4.68	4.00	-0.45	-9.72	3.67	-0.44	4.00	5.47	0.25				
0.00	170.00	-0.78	-14.46	-15.99	-1.51	4.00	0.00	170.00	-11.75	-11.49	3.63	-7.05	4.00	-0.45	-9.72	3.68	-0.44	4.00	5.47	0.26				
0.00	180.00	-0.49	-12.67	-19.38	-0.87	4.00	0.00	180.00	-20.37	-12.79	3.65	-10.7	4.00	-0.45	-9.72	3.67	-0.44	4.00	5.47	0.25				
0.00	190.00	-0.47	-11.41	-8.63	-0.52	4.00	0.00	190.00	-23.13	-14.63	3.41	-17.72	4.00	-0.45	-9.72	3.67	-0.44	4.00	5.47	0.26				
0.00	200.00	-0.72	-10.54	-4.13	-0.44	4.00	0.00	200.00	-12.65	-17.33	2.89	-29.01	4.00	-0.45	-9.71	3.68	-0.43	4.00	5.47	0.26				
0.00	210.00	-1.25	-10.00	-1.37	-0.63	4.00	0.00	210.00	-8.19	-21.68	2.04	-13.98	4.00	-0.45	-9.71	3.67	-0.43	4.00	5.47	0.26				
0.00	220.00	-2.10	-9.74	0.52	-1.10	4.00	0.00	220.00	-5.45	-31.61	0.81	-8.92	4.00	-0.45	-9.71	3.68	-0.44	4.00	5.47	0.26				
0.00	230.00	-3.34	-9.76	1.84	-1.88	4.00	0.00	230.00	-3.58	-30.26	-0.95	-5.92	4.00	-0.45	-9.72	3.68	-0.44	4.00	5.47	0.26				
0.00	240.00	-5.11	-10.03	2.75	-3.04	4.00	0.00	240.00	-2.27	-21.24	-3.5	-3.91	4.00	-0.45	-9.71	3.67	-0.44	4.00	5.47	0.25				
0.00	250.00	-7.68	-10.60	3.33	-4.68	4.00	0.00	250.00	-1.36	-17.07	-7.54	-2.49	4.00	-0.45	-9.72	3.67	-0.44	4.00	5.47	0.25				
0.00	260.00	-11.75	-11.49	3.63	-7.05	4.00	0.00	260.00	-0.78	-14.46	-15.99	-1.51	4.00	-0.45	-9.72	3.68	-0.44	4.00	5.47	0.26				
0.00	270.00	-20.37	-12.79	3.65	-10.70	4.00	0.00	270.00	-0.49	-12.67	-19.38	-0.87	4.00	-0.45	-9.72	3.67	-0.44	4.00	5.47	0.25				
0.00	280.00	-23.13	-14.63	3.41	-17.72	4.00	0.00	280.00	-0.47	-11.41	-8.63	-0.52	4.00	-0.45	-9.72	3.67	-0.44	4.00	5.47	0.26				
0.00	290.00	-12.65	-17.33	2.89	-29.01	4.00	0.00	290.00	-0.72	-10.54	-4.13	-0.44	4.00	-0.45	-9.71	3.68	-0.43	4.00	5.47	0.26				
0.00	300.00	-8.19	-21.68	2.04	-13.98	4.00	0.00	300.00	-1.25	-10	-1.37	-0.63	4.00	-0.45	-9.71	3.67	-0.43	4.00	5.47	0.26				
0.00	310.00	-5.45	-31.61	0.81	-8.92	4.00	0.00	310.00	-2.1	-9.74	0.52	-1.1	4.00	-0.45	-9.71	3.68	-0.44	4.00	5.47	0.26				
0.00	320.00	-3.58	-30.26	-0.95	-5.92	4.00	0.00	320.00	-3.34	-9.76	1.84	-1.88	4.00	-0.45	-9.72	3.68	-0.44	4.00	5.47	0.26				
0.00	330.00	-2.27	-21.24	-3.50	-3.91	4.00	0.00	330.00	-5.11	-10.03	2.75	-3.04	4.00	-0.45	-9.71	3.67	-0.44	4.00	5.47	0.25				
0.00	340.00	-1.36	-17.07	-7.54	-2.49	4.00	0.00	340.00	-7.68	-10.6	3.33	-4.68	4.00	-0.45	-9.72	3.67	-0.44	4.00	5.47	0.25				
0.00	350.00	-0.78	-14.46	-15.99	-1.51	4.00	0.00	350.00	-11.75	-11.49	3.63	-7.05	4.00	-0.45	-9.72	3.68	-0.44	4.00	5.47	0.26				
15.00	0.00	-1.34	-8.02	-20.80	-1.97	4.00	15.00	0.00	-20.78	-11.15	3.44	-10.8	4.00	-1.29	-6.30	3.68	-1.44	4.00	5.30	-0.10				
15.00	10.00	-1.41	-8.55	-17.57	-2.56	4.00	15.00	10.00	-31.36	-10.8	3.44	-8.66	4.00	-1.41	-6.52	3.47	-1.61	4.00	5.21	-0.15				
15.00	20.00	-1.71	-8.67	-8.91	-3.86	4.00	15.00	20.00	-14.3	-10.76	3.18	-6.76	4.00	-1.48	-6.58	3.44	-2.06	4.00	5.07	-0.27				
15.00	30.00	-2.38	-8.64	-4.45	-5.43	4.00	15.00	30.00	-8.73	-10.67	2.57	-5.17	4.00	-1.47	-6.53	3.36	-2.29	4.00	5.00	-0.35				
15.00	40.00	-2.91	-8.53	-1.97	-7.46	4.00	15.00	40.00	-6.02	-10.55	1.59	-4.11	4.00	-1.18	-6.41	3.18	-2.46	4.00	4.97	-0.42				
15.00	50.00	-3.83	-8.52	-0.12	-10.33	4.00	15.00	50.00	-3.95	-11.23	0.4	-3.47	4.00	-0.88	-6.66	3.16	-2.66	4.00	4.97	-0.40				
15.00	60.00	-5.09	-8.52	1.18	-14.41	4.00	15.00	60.00	-2.46	-11.73	-1.41	-3.06	4.00	-0.57	-6.82	3.09	-2.75	4.00	4.98	-0.40				
15.00	70.00	-7.11	-9.20	2.18	-22.70	4.00	15.00	70.00	-1.37	-11.96	-4.07	-2.72	4.00	-0.34	-7.35	3.10	-2.68	4.00	4.99	-0.35				
15.00	80.00	-10.66	-9.54	2.83	-23.36	4.00	15.00	80.00	-0.58	-11.79	-8.1	-2.66	4.00	-0.17	-7.51	3.17	-2.62	4.00	5.06	-0.27				
15.00	90.00	-17.26	-9.54	3.07	-14.13	4.00	15.00	90.00	-0.18	-11.61	-16.93	-2.87	4.00	-0.10	-7.44	3.11	-2.56	4.00	5.08	-0.27				
15.00	100.00	-27.42	-9.65	3.07	-10.12	4.00	15.00	100.00	-0.11	-12.33	-17.75	-3.33	4.00	-0.10	-7.78	3.11	-2.50	4.00	5.05	-0.28				
15.00	110.00	-13.01	-9.66	2.71	-7.51	4.00	15.00	110.00	-0.32	-13.88	-8.4	-4.27	4.00	-0.09	-8.27	3.03	-2.58	4.00	4.95	-0.35				
15.00	120.00	-7.89	-10.05	2.05	-5.81	4.00	15.00	120.00	-0.86	-15.1	-4.13	-5.43	4.00	-0.07	-8.87	2.99	-2.61	4.00	4.87	-0.40				
15.00	130.00	-4.89	-10.76	0.96	-4.46	4.00	15.00	130.00	-1.85	-15.99	-1.24	-7.07	4.00	-0.10	-9.62	3.01	-2.56	4.00	4.80	-0.41				
15.00	140.00	-3.18	-11.59	-0.39	-3.50	4.00	15.00	140.00	-2.91	-16.08	0.51	-9.3	4.00	-0.03	-10.27	3.09	-2.49	4.00	4.82	-0.35				
15.00	150.00	-1.72	-11.76	-2.08	-3.02	4.00	15.00	150.00	-4.7	-15.6	1.79	-11.9	4.00	0.05	-10.26	3.28	-2.49	4.00	4.92	-0.22				
15.00	160.00	-0.84	-12.07	-4.58	-2.56	4.00	15.00	160.00	-7.96	-15.8	2.72	-13.96	4.00	-0.07	-10.54	3.46	-2.26	4.00	4.98	-0.13				
15.00	170.00	-0.47	-12.39	-8.88	-2.37	4.00	15.00	170.00	-13.24	-14.67	3.25	-13.67	4.00	-0.25	-10.37	3.51	-2.06	4.00	5.01	-0.11				
15.00	180.00	-0.46	-13.00	-17.16	-2.35	4.00	15.00	180.00	-21.75	-13.55	3.45	-11.21	4.00	-0.43	-10.26	3.49	-1.82	4.00	5.02	-0.12				
15.00	190.00	-0.75	-13.32	-17.17	-2.60	4.00	15.00	190.00	-12.93	-12.67	3.31	-8.63	4.00	-0.49	-9.97	3.35	-1.63	4.00	5.01	-0.18				
15.00	200.00	-1.34	-14.12	-8.50	-2.80	4.00	15.00	200.00	-7.94	-11.53	2.91	-6.36	4.00	-0.48	-9.62	3.21	-1.21	4.00	5.09	-0.16				
15.00	210.00	-2.16	-14.40	-4.99	-3.28	4.00	15.00	210.00	-5.18	-10.85	2.28	-4.72	4.00	-0.40	-9.26	3.03	-0.93	4.00	5.14	-0.17				
15.00	220.00	-3.47																						



45.00	140.00	-1.12	-2.96	-4.29	-4.42	4.00	45.00	140.00	0.78	-12.74	0.66	-0.36	4.00
45.00	150.00	-0.46	-2.63	-6.21	-3.46	4.00	45.00	150.00	-1.91	-10.74	1.81	-2.73	4.00
45.00	160.00	-0.35	-2.99	-9.25	-2.71	4.00	45.00	160.00	-5.7	-10.13	2.75	-6.79	4.00
45.00	170.00	-0.54	-3.82	-14.71	-2.40	4.00	45.00	170.00	-11.65	-10.37	3.07	-13.95	4.00
45.00	180.00	-1.37	-4.52	-29.87	-2.25	4.00	45.00	180.00	-15.63	-10.72	2.99	-20.42	4.00
45.00	190.00	-3.08	-5.20	-17.68	-2.56	4.00	45.00	190.00	-8.18	-9.92	2.7	-12.01	4.00
45.00	200.00	-5.52	-5.74	-11.72	-3.00	4.00	45.00	200.00	-5.28	-9.38	2.33	-8	4.00
45.00	210.00	-6.79	-6.23	-9.14	-3.37	4.00	45.00	210.00	-4.44	-8.88	1.81	-5.86	4.00
45.00	220.00	-6.63	-6.75	-6.97	-4.10	4.00	45.00	220.00	-3.63	-9.38	0.86	-3.76	4.00
45.00	230.00	-6.57	-7.07	-5.69	-5.02	4.00	45.00	230.00	-2.71	-10.05	-0.59	-1.9	4.00
45.00	240.00	-7.92	-7.50	-4.57	-6.79	4.00	45.00	240.00	-1.5	-10.88	-2.86	-0.31	4.00
45.00	250.00	-11.58	-8.31	-4.03	-9.02	4.00	45.00	250.00	-0.73	-12.49	-6.19	0.85	4.00
45.00	260.00	-16.84	-8.90	-4.02	-12.90	4.00	45.00	260.00	-0.6	-14.62	-11.09	1.41	4.00
45.00	270.00	-25.65	-9.13	-3.89	-16.52	4.00	45.00	270.00	-0.98	-15.77	-21.99	1.57	4.00
45.00	280.00	-19.47	-8.90	-3.99	-13.94	4.00	45.00	280.00	-2.09	-14.32	-14.3	1.26	4.00
45.00	290.00	-14.95	-7.71	-4.10	-9.89	4.00	45.00	290.00	-3.71	-11.85	-8.43	0.68	4.00
45.00	300.00	-13.46	-5.93	-4.69	-6.93	4.00	45.00	300.00	-5.45	-9.45	-4.81	-0.01	4.00
45.00	310.00	-12.48	-4.06	-5.86	-4.83	4.00	45.00	310.00	-7.35	-7.74	-2.43	-0.85	4.00
45.00	320.00	-9.31	-2.37	-7.63	-3.25	4.00	45.00	320.00	-9.06	-7.03	-0.74	-2.23	4.00
45.00	330.00	-6.40	-1.47	-10.16	-2.44	4.00	45.00	330.00	-11.43	-7.55	0.48	-3.84	4.00
45.00	340.00	-4.04	-1.16	-13.52	-2.22	4.00	45.00	340.00	-13.4	-8.6	1.45	-7.42	4.00
45.00	350.00	-3.08	-1.37	-17.10	-2.92	4.00	45.00	350.00	-20.1	-10.34	2.34	-15.05	4.00
60.00	0.00	-4.39	0.14	-18.13	-7.21	4.00	60.00	0.00	-13.38	-23.93	1.47	-33.04	4.00
60.00	10.00	-4.71	1.09	-14.68	-10.32	4.00	60.00	10.00	-5.55	-23.39	2.08	-13.08	4.00
60.00	20.00	-4.94	1.43	-11.07	-10.81	4.00	60.00	20.00	-2.58	-17.21	2.23	-7.63	4.00
60.00	30.00	-5.45	1.19	-8.15	-9.28	4.00	60.00	30.00	-2.01	-14	1.75	-5.71	4.00
60.00	40.00	-5.88	0.90	-6.84	-8.91	4.00	60.00	40.00	-1.66	-13.75	0.74	-4.47	4.00
60.00	50.00	-6.37	0.76	-6.03	-9.04	4.00	60.00	50.00	-0.66	-15.15	-0.98	-3.08	4.00
60.00	60.00	-7.14	0.78	-5.37	-10.51	4.00	60.00	60.00	0.58	-17.9	-3.5	-1.41	4.00
60.00	70.00	-8.49	0.73	-5.20	-12.08	4.00	60.00	70.00	1.6	-20.86	-7.2	0.12	4.00
60.00	80.00	-10.87	0.62	-4.94	-13.17	4.00	60.00	80.00	2.6	-19.16	-11.77	1.22	4.00
60.00	90.00	-14.91	0.56	-4.94	-13.13	4.00	60.00	90.00	3.22	-17.35	-23.38	1.93	4.00
60.00	100.00	-16.04	0.35	-4.97	-11.63	4.00	60.00	100.00	3.48	-16.45	-13.44	2.31	4.00
60.00	110.00	-10.81	0.21	-4.96	-10.96	4.00	60.00	110.00	3.48	-16.03	-8.13	2.32	4.00
60.00	120.00	-6.55	-0.18	-5.21	-10.21	4.00	60.00	120.00	3.06	-15.4	-4.26	1.96	4.00
60.00	130.00	-3.69	-0.30	-5.49	-10.33	4.00	60.00	130.00	1.94	-15.12	-1.45	1.05	4.00
60.00	140.00	-2.48	-0.27	-6.42	-10.43	4.00	60.00	140.00	-0.35	-14.39	0.39	-0.57	4.00
60.00	150.00	-2.67	-0.42	-8.27	-8.88	4.00	60.00	150.00	-4.53	-13.76	1.45	-3.09	4.00
60.00	160.00	-3.86	-0.76	-12.08	-6.58	4.00	60.00	160.00	-12.46	-13.71	2.04	-6.6	4.00
60.00	170.00	-5.11	-1.36	-18.61	-5.26	4.00	60.00	170.00	-36.66	-11.98	2.04	-11.06	4.00
60.00	180.00	-6.99	-2.25	-30.18	-4.72	4.00	60.00	180.00	-13.08	-9.57	1.83	-12.28	4.00
60.00	190.00	-10.22	-3.39	-21.88	-5.02	4.00	60.00	190.00	-8.22	-7.99	1.33	-7.44	4.00
60.00	200.00	-12.43	-3.85	-18.61	-5.53	4.00	60.00	200.00	-6.87	-7.06	0.54	-4.3	4.00
60.00	210.00	-9.49	-3.96	-13.47	-6.01	4.00	60.00	210.00	-8.68	-6.97	-0.67	-2.39	4.00
60.00	220.00	-7.58	-4.31	-9.72	-6.15	4.00	60.00	220.00	-12.75	-7.02	-2.24	-1.02	4.00
60.00	230.00	-7.53	-5.27	-7.72	-6.43	4.00	60.00	230.00	-13.31	-6.71	-4.56	0.17	4.00
60.00	240.00	-9.18	-6.73	-7.07	-7.37	4.00	60.00	240.00	-8.33	-7.25	-7.66	0.98	4.00
60.00	250.00	-12.84	-8.99	-7.29	-9.56	4.00	60.00	250.00	-5.97	-8.34	-11.6	1.47	4.00
60.00	260.00	-18.77	-10.71	-7.33	-12.15	4.00	60.00	260.00	-4.88	-10.77	-16.78	1.63	4.00
60.00	270.00	-31.47	-11.14	-7.79	-17.78	4.00	60.00	270.00	-4.81	-14.88	-22.76	1.54	4.00
60.00	280.00	-18.20	-9.97	-8.24	-32.54	4.00	60.00	280.00	-6.12	-18.44	-16.17	1.31	4.00
60.00	290.00	-13.64	-8.53	-8.61	-22.94	4.00	60.00	290.00	-8.29	-16.72	-11.21	0.89	4.00
60.00	300.00	-12.32	-7.02	-9.91	-13.80	4.00	60.00	300.00	-11.19	-15.22	-6.94	0.17	4.00
60.00	310.00	-12.31	-5.72	-11.37	-9.82	4.00	60.00	310.00	-10.39	-16.72	-3.95	-1.38	4.00
60.00	320.00	-9.60	-3.65	-13.90	-7.45	4.00	60.00	320.00	-9.35	-16.05	-2.16	-3.51	4.00
60.00	330.00	-6.04	-1.10	-17.64	-5.77	4.00	60.00	330.00	-11.78	-13.63	-1.03	-6	4.00
60.00	340.00	-4.49	-0.02	-20.38	-4.96	4.00	60.00	340.00	-18.78	-13.88	-0.08	-9	4.00
60.00	350.00	-4.41	-0.06	-20.08	-5.27	4.00	60.00	350.00	-33.23	-17.39	0.65	-12.83	4.00
75.00	0.00	-11.78	0.51	-23.74	-12.76	4.00	75.00	0.00	-10.69	-15.91	-0.11	-21.09	4.00
75.00	10.00	-11.43	1.22	-23.65	-14.44	4.00	75.00	10.00	-6.93	-17.17	0.49	-19.09	4.00
75.00	20.00	-11.62	2.45	-18.35	-18.12	4.00	75.00	20.00	-3.81	-26.53	1.29	-10.03	4.00
75.00	30.00	-11.82	2.36	-13.64	-20.91	4.00	75.00	30.00	-4.01	-24.48	1.19	-6.3	4.00
75.00	40.00	-11.04	1.65	-10.77	-23.28	4.00	75.00	40.00	-3.87	-21.44	0.54	-4.53	4.00
75.00	50.00	-9.83	1.16	-9.44	-19.22	4.00	75.00	50.00	-1.95	-25.12	-0.86	-3.46	4.00
75.00	60.00	-8.95	1.10	-9.36	-15.79	4.00	75.00	60.00	-0.11	-28.54	-2.99	-2.66	4.00
75.00	70.00	-9.04	1.31	-9.35	-13.98	4.00	75.00	70.00	1.17	-25.08	-5.91	-1.68	4.00
75.00	80.00	-10.66	1.58	-9.68	-12.97	4.00	75.00	80.00	2.2	-20.44	-10.21	-0.71	4.00
75.00	90.00	-13.54	1.77	-9.61	-12.04	4.00	75.00	90.00	2.75	-18.04	-20.59	0.04	4.00
75.00	100.00	-16.75	1.67	-9.57	-12.37	4.00	75.00	100.00	2.89	-17.37	-18.71	0.38	4.00
75.00	110.00	-16.91	1.66	-9.03	-13.58	4.00	75.00	110.00	2.56	-17.26	-9.7	0.3	4.00
75.00	120.00	-13.03	1.82	-8.69	-16.76	4.00	75.00	120.00	2.06	-22.18	-5.49	0.19	4.00
75.00	130.00	-9.42	2.11	-8.94	-23.93	4.00	75.00	130.00	1.34	-31.93	-2.54	-0.38	4.00
75.00	140.00	-7.53	2.25	-9.49	-20.32	4.00	75.00	140.00	-0.03	-20.11	-0.55	-1.56	4.00
75.00	150.00	-6.53	1.87	-11.31	-13.95	4.00	75.00	150.00	-3.63	-14.45	0.51	-3.47	4.00
75.00	160.00	-6.82	0.87	-15.60	-10.44	4.00	75.00	160.00	-10.96	-12.6	1.02	-6.74	4.00
75.00	170.00	-7.92	-0.54	-23.86	-9.21	4.00	75.00	170.00	-16.22	-10.78	1.27	-11.89	4.00
75.00	180.00	-10.17	-2.11	-35.25	-10.06	4.00	75.00	180.00	-17.68	-8.94	1.31	-13.84	4.00
75.00	190.00	-12.29	-2.58	-28.59	-12.97	4.00	75.00	190.00	-17.07	-7.52	0.96	-7.75	4.00
75.00	200.00	-13.65	-2.54	-19.13	-15.78	4.00	75.00	200.00	-11.29	-7.7	-0.14	-4.1	4.00
75.00	210.00	-14.81	-3.10	-14.89	-15.78	4.00	75.00	210.00	-10.14	-8.22	-1.41	-2.21	4.00
75.00	220.00	-12.64	-4.89	-13.14	-14.69	4.00	75.00	220.00	-12.07	-7.38	-3.34	-0.99	4.00
75.00	230.00	-10.96	-6.55	-13.73	-13.16	4.00	75.00	230.00	-12.62	-6.21	-5.55	-0.33	4.00
75.00	240.00	-10.98	-7.75	-13.52	-13.25	4.00	75.00	240.00	-8.08	-5.85	-8.23	0.19	4.00
75.00	250.00	-12.83	-8.48	-12.98	-12.89	4.00	75.00	250.00	-5.1	-6.96	-11.98	0.36	4.00
75.00	260.00	-16.31	-9.28	-11.67	-13.83	4.00	75.00	260.00	-4.13	-9.24	-18.29	0.4	4.00
75.00	270.00	-23.72	-10.23	-11.35	-14.20	4.00	75.00	270.00	-4.44	-14.2	-23.07	0.19	4.00
75.00	280.00	-28.54	-11.21	-11.80	-14.78	4.00	75.00	280.00	-6.27	-21.95	-13.66	-0.24	4.00
75.00	290.00	-21.10	-10.56	-12.35	-15.54	4.00	75.00	290.00	-9.94	-14.38	-9.36	-0.89	4.00
75.00	300.00	-20.05	-7.27	-13.19	-19.17	4.00	75.00	300.00					



105.00	0.00	-14.50	0.11	-19.16	-10.51	4.00	105.00	0.00	-12.98	-11.48	-2.67	-12.17	4.00
105.00	10.00	-13.73	0.34	-24.02	-8.99	4.00	105.00	10.00	-10.76	-10.33	-1.71	-14.46	4.00
105.00	20.00	-8.61	0.47	-30.48	-9.03	4.00	105.00	20.00	-6.03	-12.9	-1.17	-13.89	4.00
105.00	30.00	-7.63	0.04	-22.89	-11.07	4.00	105.00	30.00	-3.87	-18.26	-1.65	-12.43	4.00
105.00	40.00	-9.82	-0.81	-16.19	-14.18	4.00	105.00	40.00	-2.68	-19.94	-2.53	-8.21	4.00
105.00	50.00	-14.77	-1.19	-12.96	-15.24	4.00	105.00	50.00	-2.12	-27.61	-3.53	-5.01	4.00
105.00	60.00	-16.98	-0.66	-11.68	-15.36	4.00	105.00	60.00	-2.19	-24.61	-5.39	-3.18	4.00
105.00	70.00	-14.46	0.31	-11.34	-14.87	4.00	105.00	70.00	-2.29	-20.34	-8.42	-2.03	4.00
105.00	80.00	-14.16	1.48	-10.82	-14.27	4.00	105.00	80.00	-1.77	-21.38	-14.56	-1.37	4.00
105.00	90.00	-15.31	2.49	-10.33	-15.00	4.00	105.00	90.00	-1.12	-25.86	-27.82	-0.89	4.00
105.00	100.00	-17.7	3.40	-9.61	-17.85	4.00	105.00	100.00	-0.66	-37	-16.14	-0.43	4.00
105.00	110.00	-20.51	3.98	-9.51	-22.13	4.00	105.00	110.00	-0.37	-33.46	-10.16	0.11	4.00
105.00	120.00	-18.84	4.43	-10.23	-19.41	4.00	105.00	120.00	-0.44	-21.3	-6.65	0.47	4.00
105.00	130.00	-14.37	4.76	-11.93	-15.64	4.00	105.00	130.00	-0.84	-15.47	-4.62	0.44	4.00
105.00	140.00	-10.76	4.75	-15.62	-14.64	4.00	105.00	140.00	-1.96	-11.95	-3.44	-0.31	4.00
105.00	150.00	-8.04	3.95	-23.53	-15.87	4.00	105.00	150.00	-5.15	-10.76	-2.95	-2.21	4.00
105.00	160.00	-6.49	2.70	-27.70	-18.05	4.00	105.00	160.00	-12.73	-13.25	-2.77	-6.16	4.00
105.00	170.00	-5.86	1.86	-20.10	-16.19	4.00	105.00	170.00	-29.48	-14.79	-2.75	-11.79	4.00
105.00	180.00	-5.46	0.22	-21.39	-14.99	4.00	105.00	180.00	-15.63	-14.3	-3.13	-16.52	4.00
105.00	190.00	-5.69	-1.91	-23.32	-15.69	4.00	105.00	190.00	-10.53	-23.92	-3.5	-14.05	4.00
105.00	200.00	-7.01	-2.22	-14.75	-19.83	4.00	105.00	200.00	-6.3	-21.03	-4.06	-8.81	4.00
105.00	210.00	-9.99	-2.16	-12.17	-25.33	4.00	105.00	210.00	-5.95	-17.35	-5.49	-5.06	4.00
105.00	220.00	-18.91	-3.08	-13.11	-20.02	4.00	105.00	220.00	-9.84	-21.56	-8.6	-2.04	4.00
105.00	230.00	-19.17	-4.67	-16.11	-19.39	4.00	105.00	230.00	-33.89	-28.47	-10.14	-0.06	4.00
105.00	240.00	-15.39	-6.43	-17.43	-20.91	4.00	105.00	240.00	-11.23	-19.72	-9.36	1.17	4.00
105.00	250.00	-16.21	-6.93	-15.01	-22.38	4.00	105.00	250.00	-7.2	-17.73	-9.34	1.79	4.00
105.00	260.00	-20.23	-6.14	-14.29	-20.63	4.00	105.00	260.00	-6.23	-16.45	-11.64	2.16	4.00
105.00	270.00	-31.67	-6.47	-13.87	-15.91	4.00	105.00	270.00	-7.49	-15.87	-17.03	1.77	4.00
105.00	280.00	-37.05	-9.18	-14.61	-14.02	4.00	105.00	280.00	-12.56	-16.25	-24.03	0.52	4.00
105.00	290.00	-33.16	-21.41	-15.02	-13.19	4.00	105.00	290.00	-22.5	-18.11	-18.33	-2.35	4.00
105.00	300.00	-17.91	-9.19	-12.95	-13.97	4.00	105.00	300.00	-9.51	-19.73	-13.89	-8.31	4.00
105.00	310.00	-11.63	-3.59	-10.54	-17.27	4.00	105.00	310.00	-6.31	-16.58	-12.77	-15.34	4.00
105.00	320.00	-7.66	-2.60	-9.69	-22.78	4.00	105.00	320.00	-7.32	-10.93	-12.12	-9.91	4.00
105.00	330.00	-6.61	-4.51	-9.79	-34.14	4.00	105.00	330.00	-11.87	-8.79	-9.66	-8.66	4.00
105.00	340.00	-7.02	-3.85	-11.02	-24.27	4.00	105.00	340.00	-14.5	-9.39	-6.39	-8.4	4.00
105.00	350.00	-9.85	-0.86	-13.94	-15.04	4.00	105.00	350.00	-11.38	-12.98	-4.27	-9.28	4.00
120.00	0.00	-8.74	-3.22	-19.38	-7.64	4.00	120.00	0.00	-16.57	-21.93	-7.02	-11.27	4.00
120.00	10.00	-4.64	-4.28	-21.74	-7.67	4.00	120.00	10.00	-12.38	-24.41	-5.68	-11.17	4.00
120.00	20.00	-2.95	-3.91	-24.03	-8.32	4.00	120.00	20.00	-6.93	-27.65	-4.48	-10.33	4.00
120.00	30.00	-3.61	-3.33	-25.31	-8.88	4.00	120.00	30.00	-5.91	-19.72	-3.66	-11.1	4.00
120.00	40.00	-5.33	-2.97	-20.28	-8.92	4.00	120.00	40.00	-6.54	-15.64	-3.59	-11.67	4.00
120.00	50.00	-7.82	-2.24	-14.37	-8.86	4.00	120.00	50.00	-7.11	-15.52	-4.34	-9.2	4.00
120.00	60.00	-10.23	-1.11	-10.30	-9.34	4.00	120.00	60.00	-7.31	-14.29	-5.95	-5.89	4.00
120.00	70.00	-12.82	0.20	-7.84	-10.33	4.00	120.00	70.00	-6.65	-14.2	-9.06	-3.3	4.00
120.00	80.00	-15.16	1.24	-6.49	-12.52	4.00	120.00	80.00	-5.16	-15.01	-14.26	-1.72	4.00
120.00	90.00	-17.94	2.10	-5.95	-16.01	4.00	120.00	90.00	-3.8	-17.9	-26.19	-0.57	4.00
120.00	100.00	-17.62	2.77	-6.08	-17.14	4.00	120.00	100.00	-2.49	-24.53	-13.23	0.03	4.00
120.00	110.00	-14.27	3.17	-6.73	-14.10	4.00	120.00	110.00	-1.74	-45.65	-8.17	0.36	4.00
120.00	120.00	-10.85	3.35	-8.37	-10.06	4.00	120.00	120.00	-1.32	-21.03	-4.7	0.27	4.00
120.00	130.00	-8.90	2.98	-11.55	-7.41	4.00	120.00	130.00	-1.12	-15.14	-2.61	-0.32	4.00
120.00	140.00	-7.87	2.29	-15.68	-6.19	4.00	120.00	140.00	-1.77	-12.86	-1.36	-1.68	4.00
120.00	150.00	-6.89	1.40	-20.87	-6.11	4.00	120.00	150.00	-3.9	-13	-1.12	-4.12	4.00
120.00	160.00	-6.32	0.86	-22.66	-7.07	4.00	120.00	160.00	-8.59	-12.97	-2.19	-8.53	4.00
120.00	170.00	-6.42	0.17	-23.77	-7.88	4.00	120.00	170.00	-15.92	-11.82	-4.03	-13.6	4.00
120.00	180.00	-6.68	-0.76	-17.66	-7.50	4.00	120.00	180.00	-21.77	-13.47	-5.34	-17.38	4.00
120.00	190.00	-7.38	-1.28	-12.34	-7.27	4.00	120.00	190.00	-10.51	-21.64	-5.23	-11.41	4.00
120.00	200.00	-9.30	-2.03	-10.61	-8.43	4.00	120.00	200.00	-5.76	-23.26	-6.46	-7.13	4.00
120.00	210.00	-12.45	-3.77	-9.75	-10.31	4.00	120.00	210.00	-3.99	-16.94	-10.71	-5.46	4.00
120.00	220.00	-14.39	-5.07	-9.99	-12.44	4.00	120.00	220.00	-3.81	-15.26	-14.95	-4.41	4.00
120.00	230.00	-14.29	-4.92	-9.82	-13.89	4.00	120.00	230.00	-3.84	-16.47	-12.59	-2.75	4.00
120.00	240.00	-15.79	-4.19	-9.47	-16.69	4.00	120.00	240.00	-3.11	-20.08	-11.08	-0.94	4.00
120.00	250.00	-19.22	-3.29	-9.52	-23.92	4.00	120.00	250.00	-2.18	-31.04	-13.17	0.44	4.00
120.00	260.00	-15.52	-2.93	-9.70	-35.41	4.00	120.00	260.00	-1.63	-22.24	-17.59	1.01	4.00
120.00	270.00	-11.04	-2.91	-9.95	-18.79	4.00	120.00	270.00	-1.64	-15.9	-26.64	0.94	4.00
120.00	280.00	-8.32	-4.30	-11.19	-14.19	4.00	120.00	280.00	-2.41	-11.36	-19.36	-0.15	4.00
120.00	290.00	-7.31	-7.71	-11.09	-12.97	4.00	120.00	290.00	-3.69	-8.83	-16.23	-1.9	4.00
120.00	300.00	-8.22	-11.08	-9.45	-12.62	4.00	120.00	300.00	-5.91	-6.75	-15.44	-5.77	4.00
120.00	310.00	-10.60	-5.21	-6.97	-13.54	4.00	120.00	310.00	-7.27	-6.71	-15.89	-12.3	4.00
120.00	320.00	-9.87	-3.11	-5.88	-10.26	4.00	120.00	320.00	-7.04	-8.16	-12.95	-15.08	4.00
120.00	330.00	-7.40	-4.59	-6.93	-7.70	4.00	120.00	330.00	-6.8	-9.31	-10.33	-10.81	4.00
120.00	340.00	-7.93	-4.92	-10.66	-7.08	4.00	120.00	340.00	-7.4	-10	-9.29	-9.42	4.00
120.00	350.00	-9.72	-3.37	-14.45	-7.40	4.00	120.00	350.00	-9.54	-12.35	-8.62	-9.73	4.00
135.00	0.00	-1.41	-8.07	-19.03	-11.57	4.00	135.00	0.00	-22.25	-18.43	-8.85	-11.88	4.00
135.00	10.00	-1.65	-8.35	-20.97	-15.19	4.00	135.00	10.00	-16.39	-21.13	-8.4	-11.33	4.00
135.00	20.00	-2.31	-9.16	-20.38	-14.95	4.00	135.00	20.00	-8.4	-20.29	-6.55	-11.14	4.00
135.00	30.00	-3.60	-9.01	-24.81	-15.05	4.00	135.00	30.00	-5.82	-17.75	-4.88	-12.8	4.00
135.00	40.00	-4.96	-6.59	-35.76	-16.94	4.00	135.00	40.00	-4.96	-14.97	-4.26	-19.9	4.00
135.00	50.00	-6.44	-4.20	-17.66	-15.52	4.00	135.00	50.00	-4.25	-13.45	-4.44	-19.89	4.00
135.00	60.00	-7.57	-2.18	-11.26	-12.51	4.00	135.00	60.00	-3.33	-12.64	-5.55	-11.13	4.00
135.00	70.00	-9.04	-0.74	-8.13	-11.26	4.00	135.00	70.00	-2.24	-13.65	-8.08	-7.3	4.00
135.00	80.00	-11.44	-0.07	-6.54	-12.68	4.00	135.00	80.00	-1.01	-15.06	-12.49	-4.62	4.00
135.00	90.00	-15.52	0.22	-5.87	-14.98	4.00	135.00	90.00	0.1	-18.07	-17.68	-3.26	4.00
135.00	100.00	-18.06	0.39	-5.76	-14.81	4.00	135.00	100.00	0.92	-23.3	-12.68	-2.82	4.00
135.00	110.00	-12.50	0.52	-6.49	-11.26	4.00	135.00	110.00	1.57	-26.51	-8.21	-3.07	4.00
135.00	120.00	-7.23	0.78	-8.15	-8.54	4.00	135.00	120.00	2.09	-23.31	-5.83	-4.47	4.00
135.00	130.00	-4.13	0.65	-11.26	-7.13	4.00	135.00	130.00	1.89	-21.73	-4.75	-6.87	4.00
135.00	140.00	-2.15	0.40	-16.17	-6.80	4.00	135.00	140.00	1	-20.32	-5.08	-10.64	4.00
135.													



150.00	220.00	-3.28	-5.88	-13.58	-15.82	4.00	150.00	220.00	-3.92	-18.53	-14.32	-7.2	4.00	-0.58	-5.65	-10.92	-6.64	4.00	0.86	-4.42
150.00	230.00	-4.55	-5.12	-15.13	-12.70	4.00	150.00	230.00	-1.38	-21.47	-10.64	-4.71	4.00	0.33	-5.02	-9.32	-4.07	4.00	2.17	-3.23
150.00	240.00	-6.96	-4.36	-17.22	-12.54	4.00	150.00	240.00	0.19	-22.53	-9.67	-2.36	4.00	0.96	-4.29	-8.97	-1.96	4.00	3.17	-2.25
150.00	250.00	-11.89	-4.23	-19.93	-14.82	4.00	150.00	250.00	1.1	-21.06	-10.51	-1.07	4.00	1.31	-4.14	-10.04	-0.89	4.00	3.53	-1.78
150.00	260.00	-24.59	-4.48	-18.41	-16.88	4.00	150.00	260.00	1.26	-18.8	-12.21	-0.51	4.00	1.27	-4.32	-11.28	-0.41	4.00	3.50	-1.72
150.00	270.00	-16.93	-5.39	-16.74	-15.08	4.00	150.00	270.00	0.77	-15.51	-17	-0.57	4.00	0.84	-4.99	-13.86	-0.42	4.00	2.99	-2.07
150.00	280.00	-9.61	-7.24	-16.83	-11.85	4.00	150.00	280.00	-0.52	-11.86	-31.61	-1.59	4.00	-0.02	-5.95	-16.69	-1.20	4.00	2.01	-2.94
150.00	290.00	-7.61	-10.13	-20.26	-10.59	4.00	150.00	290.00	-2.71	-8.93	-19.56	-3.61	4.00	-1.49	-6.48	-16.89	-2.82	4.00	0.76	-4.33
150.00	300.00	-7.65	-14.71	-21.96	-12.22	4.00	150.00	300.00	-7.15	-7.13	-15.16	-7.72	4.00	-4.38	-6.43	-14.34	-6.40	4.00	-1.15	-6.69
150.00	310.00	-9.50	-12.54	-13.97	-19.74	4.00	150.00	310.00	-15.13	-6.32	-14.26	-15.86	4.00	-8.45	-5.39	-11.10	-14.37	4.00	-3.19	-8.65
150.00	320.00	-15.79	-8.39	-10.62	-17.32	4.00	150.00	320.00	-19.08	-6.85	-17.26	-26.04	4.00	-14.12	-4.54	-9.77	-16.77	4.00	-4.02	-8.89
150.00	330.00	-27.74	-6.21	-9.04	-9.60	4.00	150.00	330.00	-15.11	-8.65	-30.83	-15.36	4.00	-14.88	-4.25	-9.01	-8.58	4.00	-2.38	-7.74
150.00	340.00	-13.42	-5.43	-9.65	-6.94	4.00	150.00	340.00	-16.23	-10.93	-17.86	-12.54	4.00	-11.59	-4.35	-9.04	-5.88	4.00	-1.26	-6.89
150.00	350.00	-10.48	-5.59	-11.32	-7.11	4.00	150.00	350.00	-22.09	-11.8	-13.28	-12.23	4.00	-10.03	-4.66	-9.18	-5.95	4.00	-1.15	-6.90
165.00	0.00	-3.06	-8.86	-18.82	-4.40	4.00	165.00	0.00	-22.47	-12.47	-8.34	-18.59	4.00	-3.01	-7.29	-7.97	-4.24	4.00	0.64	-5.15
165.00	10.00	-3.56	-9.43	-16.36	-4.40	4.00	165.00	10.00	-35.52	-11.17	-8.19	-15.96	4.00	-3.56	-7.20	-7.57	-4.11	4.00	0.59	-5.25
165.00	20.00	-4.31	-11.28	-13.55	-4.63	4.00	165.00	20.00	-19.59	-9.88	-8.14	-12.55	4.00	-4.18	-7.51	-7.04	-3.98	4.00	0.49	-5.39
165.00	30.00	-5.39	-13.00	-10.76	-4.52	4.00	165.00	30.00	-13.86	-8.73	-8.68	-9.81	4.00	-4.81	-7.35	-6.59	-3.39	4.00	0.62	-5.26
165.00	40.00	-6.51	-13.71	-8.92	-4.52	4.00	165.00	40.00	-10.62	-8.23	-9.89	-7.66	4.00	-5.09	-7.15	-6.37	-2.80	4.00	0.83	-5.02
165.00	50.00	-7.10	-13.50	-7.48	-5.04	4.00	165.00	50.00	-8.23	-8.07	-11.69	-5.78	4.00	-4.62	-6.98	-6.08	-2.38	4.00	1.18	-4.65
165.00	60.00	-7.54	-11.75	-6.43	-6.14	4.00	165.00	60.00	-6.36	-7.89	-14.42	-4.21	4.00	-3.90	-6.39	-5.79	-2.06	4.00	1.65	-4.19
165.00	70.00	-8.71	-9.62	-5.68	-8.02	4.00	165.00	70.00	-4.74	-7.99	-19.93	-3.2	4.00	-3.28	-5.72	-5.52	-1.96	4.00	2.04	-3.83
165.00	80.00	-11.06	-7.58	-5.28	-11.22	4.00	165.00	80.00	-3.59	-8.47	-32.33	-2.38	4.00	-2.87	-4.99	-5.27	-1.85	4.00	2.39	-3.51
165.00	90.00	-13.86	-6.29	-5.11	-18.09	4.00	165.00	90.00	-2.77	-9.75	-21.61	-2.06	4.00	-2.44	-4.67	-5.01	-1.95	4.00	2.60	-3.32
165.00	100.00	-17.23	-5.67	-5.28	-28.94	4.00	165.00	100.00	-2.46	-11.57	-16.07	-2	4.00	-2.32	-4.68	-4.93	-1.99	4.00	2.64	-3.28
165.00	110.00	-16.03	-5.75	-6.02	-16.36	4.00	165.00	110.00	-2.52	-14.31	-12.32	-2.38	4.00	-2.33	-5.18	-5.11	-2.21	4.00	2.43	-3.47
165.00	120.00	-10.91	-5.90	-7.32	-11.84	4.00	165.00	120.00	-3.01	-16.33	-10.08	-3.36	4.00	-2.36	-5.52	-5.47	-2.78	4.00	2.11	-3.79
165.00	130.00	-7.04	-6.19	-8.74	-9.30	4.00	165.00	130.00	-3.68	-15.96	-8.7	-4.66	4.00	-2.03	-5.75	-5.71	-3.38	4.00	1.95	-3.93
165.00	140.00	-4.23	-6.57	-10.66	-8.19	4.00	165.00	140.00	-4.74	-14.03	-8.11	-6.48	4.00	-1.47	-5.85	-6.19	-4.24	4.00	1.79	-4.01
165.00	150.00	-2.17	-7.20	-13.39	-7.28	4.00	165.00	150.00	-6.57	-11.86	-7.95	-8.63	4.00	-0.82	-5.92	-6.86	-4.89	4.00	1.72	-3.94
165.00	160.00	-0.42	-7.62	-17.90	-6.44	4.00	165.00	160.00	-9.63	-10.05	-8.25	-12.26	4.00	0.07	-5.66	-7.80	-5.43	4.00	1.84	-3.61
165.00	170.00	0.82	-8.39	-23.93	-5.82	4.00	165.00	170.00	-15.01	-8.85	-9.17	-16.89	4.00	0.93	-5.60	-9.03	-5.49	4.00	2.02	-3.18
165.00	180.00	1.86	-8.70	-24.04	-5.03	4.00	165.00	180.00	-19.51	-8.01	-9.97	-2.72	4.00	1.89	-5.33	-9.80	-5.00	4.00	2.51	-2.48
165.00	190.00	2.35	-8.58	-19.17	-4.29	4.00	165.00	190.00	-10.79	-7.45	-10.44	-22.85	4.00	2.56	-4.97	-9.89	-4.23	4.00	3.05	-1.87
165.00	200.00	2.42	-7.97	-15.05	-3.59	4.00	165.00	200.00	-5.56	-7.2	-9.56	-15.35	4.00	3.06	-4.56	-8.48	-3.31	4.00	3.73	-1.27
165.00	210.00	2.11	-7.49	-12.68	-3.43	4.00	165.00	210.00	-2.82	-7.37	-8.7	-11.9	4.00	3.32	-4.42	-7.24	-2.85	4.00	4.14	-0.95
165.00	220.00	1.18	-6.86	-10.30	-3.44	4.00	165.00	220.00	-0.45	-7.85	-8.09	-8.53	4.00	3.45	-4.32	-6.05	-2.27	4.00	4.52	-0.67
165.00	230.00	-0.21	-6.63	-8.49	-3.80	4.00	165.00	230.00	1.08	-8.56	-8.5	-5.89	4.00	3.49	-4.48	-5.48	-1.71	4.00	4.72	-0.52
165.00	240.00	-2.60	-6.66	-6.57	-4.82	4.00	165.00	240.00	2.13	-9.86	-9.49	-3.89	4.00	3.39	-4.96	-4.78	-1.32	4.00	4.81	-0.49
165.00	250.00	-6.25	-7.10	-5.54	-6.41	4.00	165.00	250.00	2.71	-10.94	-12.13	-2.65	4.00	3.23	-5.60	-4.68	-1.12	4.00	4.70	-0.59
165.00	260.00	-12.50	-7.47	-4.60	-8.67	4.00	165.00	260.00	2.81	-11.77	-17.41	-1.98	4.00	2.94	-6.10	-4.38	-1.14	4.00	4.56	-0.77
165.00	270.00	-17.39	-8.23	-4.22	-12.79	4.00	165.00	270.00	2.5	-12.85	-23.43	-1.5	4.00	2.54	-6.94	-4.17	-1.19	4.00	4.30	-1.05
165.00	280.00	-10.85	-8.02	-4.50	-19.58	4.00	165.00	280.00	1.89	-13.55	-14.88	-1.54	4.00	2.12	-6.95	-4.12	-1.47	4.00	4.06	-1.35
165.00	290.00	-6.81	-7.22	-5.22	-16.33	4.00	165.00	290.00	0.76	-14.57	-10.16	-1.92	4.00	1.46	-6.49	-4.01	-1.77	4.00	3.82	-1.73
165.00	300.00	-4.60	-6.43	-6.82	-10.78	4.00	165.00	300.00	-0.69	-16.35	-7.67	-2.8	4.00	0.79	-6.01	-4.21	-2.16	4.00	3.50	-2.15
165.00	310.00	-3.41	-5.84	-9.55	-7.70	4.00	165.00	310.00	-2.46	-18.67	-6.44	-4.34	4.00	0.10	-5.62	-4.71	-2.69	4.00	3.08	-2.65
165.00	320.00	-2.62	-5.85	-14.11	-5.94	4.00	165.00	320.00	-4.66	-21.57	-6.39	-6.76	4.00	-0.51	-5.74	-5.71	-3.32	4.00	2.48	-3.26
165.00	330.00	-2.26	-5.97	-20.20	-4.81	4.00	165.00	330.00	-6.93	-23.44	-6.96	-9.79	4.00	-0.99	-5.89	-6.76	-3.61	4.00	2.00	-3.71
165.00	340.00	-2.21	-6.43	-31.99	-4.34	4.00	165.00	340.00	-10.19	-18.37	-7.86	-15.39	4.00	-1.57	-6.16	-7.84	-4.01	4.00	1.45	-4.26
165.00	350.00	-2.48	-7.64	-21.96	-4.50	4.00	165.00	350.00	-15.15	-15.22	-8.37	-22.56	4.00	-2.25	-6.94	-8.18	-4.43	4.00	0.87	-4.85
180.00	0.00	2.08	-11.77	-26.64	-0.48	4.00	180.00	0.00	-14.04	-10.81	-5.37	-12.88	4.00	2.18	-8.25	-5.54	-0.24	4.00	4.01	-1.21
180.00	10.00	2.18	-10.34	-17.25	-0.25	4.00	180.00	10.00	-32.04	-12.43	-5.84	-24.58	4.00	2.18	-8.25	-5.54	-0.23	4.00	4.01	-1.21
180.00	20.00	2.02	-9.34	-13.00	-0.29	4.00	180.00	20.00	-12.12	-14.77	-6.4	-19.12	4.00	2.18	-8.25	-5.54	-0.23	4.00	4.01	-1.21
180.00	30.00	1.58	-8.69	-10.36	-0.60	4.00	180.00	30.00	-6.69	-18.37	-7.28	-11.15	4.00	2.18	-8.25	-5.54	-0.23	4.00	4.01	-1.21
180.00	40.00	0.83	-8.34	-8.54	-1.20	4.00	180.00	40.00	-3.55	-25.2	-8.56	-7.24	4.00	2.18	-8.25	-5.54	-0.23	4.00	4.01	-1.21
180.00	50.00	-0.28	-8.25	-7.27	-2.13	4.00	180.00	50.00	-1.46	-38.14	-10.38	-4.74	4.00	2.18	-8.25	-5.54	-0.23	4.00	4.01	-1.21
180.00	60.00	-1.86	-8.44	-6.39	-3.48	4.00	180.00	60.00	0.01	-22.01	-13.04	-3.02	4.00	2.19	-8.25	-5.54	-0.23	4.00	4.01	-1.21
180.00	70.00	-4.14	-8.90	-5.84	-5.40	4.00	180.00	70.00	1.03	-16.84	-17.31	-1.81	4.00	2.18	-8.25	-5.54	-0.23	4.00	4.01	-1.21
180.00	80.00	-7.62	-9.67	-5.57	-8.23	4.00	180.00	80.00	1.7	-13.81	-26.83	-0.98	4.00	2.18	-8.25	-5.54	-0.23	4.00	4.01	-1.21
180.00	90.00	-14.04	-10.81	-5.57	-12.88	4.00	180.00	90.00	2.08	-11.77	-26.64	-0.48	4.00	2.18	-8.25	-5.54	-0.24	4.00	4.01	-1.21
180.00	100.00	-32.04	-12.43	-5.84	-24.58	4.00	180.00	100.00	2.18	-10.34	-1									



Frequency: 2462MHz

Theta Polarization		Max Gain(dBi)				Nant	Angle (θ)	Angle (φ)	Phi Polarization				Nant	Total				Nant	Max DG(dBi)		Max DG(θ)	Max DG(φ)												
Angle (θ)	Angle (φ)	Ant 1(G1)	Ant 2(G2)	Ant 3(G3)	Ant 4(G4)				Ant 1(G1)	Ant 2(G2)	Ant 3(G3)	Ant 4(G4)		Ant 1(G1)	Ant 2(G2)	Ant 3(G3)	Ant 4(G4)		Ant 1(G1)	Ant 2(G2)			Ant 3(G3)	Ant 4(G4)	7.54	1.81								
		2.41	5.04	4.06	0.35																						4.34	-4.46	4.06	3.52	4.35	5.11	4.10	3.53
		Ant 1(G1)	Ant 2(G2)	Ant 3(G3)	Ant 4(G4)																						Ant 1(G1)	Ant 2(G2)	Ant 3(G3)	Ant 4(G4)				
0.00	0.00	-0.66	-12.53	-17.12	-0.03	4.00	0.00	0.00	-19.56	-12.91	4.06	-10.3	4.00	-0.60	-9.71	4.09	0.36	4.00	5.81	0.63														
0.00	10.00	-0.62	-11.30	-7.65	0.29	4.00	0.00	10.00	-24.84	-14.81	3.8	-17.86	4.00	-0.60	-9.70	4.10	0.36	4.00	5.81	0.64														
0.00	20.00	-0.85	-10.47	-3.39	0.35	4.00	0.00	20.00	-13.23	-17.61	3.24	-25.41	4.00	-0.61	-9.70	4.09	0.36	4.00	5.81	0.64														
0.00	30.00	-1.36	-9.96	-0.73	0.14	4.00	0.00	30.00	-8.58	-22.2	2.37	-12.63	4.00	-0.61	-9.71	4.10	0.36	4.00	5.81	0.64														
0.00	40.00	-2.18	-9.72	1.09	-0.36	4.00	0.00	40.00	-5.76	-33.45	1.09	-7.82	4.00	-0.60	-9.70	4.10	0.36	4.00	5.81	0.64														
0.00	50.00	-3.40	-9.76	2.36	-1.16	4.00	0.00	50.00	-3.84	-28.93	-0.73	-4.93	4.00	-0.60	-9.71	4.09	0.36	4.00	5.81	0.64														
0.00	60.00	-5.12	-10.06	3.24	-2.35	4.00	0.00	60.00	-2.5	-20.75	-3.38	-2.97	4.00	-0.61	-9.70	4.10	0.36	4.00	5.81	0.64														
0.00	70.00	-7.62	-10.65	3.80	-4.04	4.00	0.00	70.00	-1.57	-16.78	-7.63	-1.6	4.00	-0.61	-9.70	4.10	0.36	4.00	5.81	0.64														
0.00	80.00	-11.55	-11.58	4.06	-6.48	4.00	0.00	80.00	-0.97	-14.26	-17.07	-0.65	4.00	-0.61	-9.71	4.09	0.36	4.00	5.81	0.63														
0.00	90.00	-19.56	-12.91	4.06	-10.30	4.00	0.00	90.00	-0.66	-12.53	-17.12	-0.03	4.00	-0.60	-9.71	4.09	0.36	4.00	5.81	0.63														
0.00	100.00	-24.84	-14.81	3.80	-17.86	4.00	0.00	100.00	-0.62	-11.3	-7.65	0.29	4.00	-0.60	-9.70	4.10	0.36	4.00	5.81	0.64														
0.00	110.00	-13.23	-17.61	3.24	-25.41	4.00	0.00	110.00	-0.85	-10.47	-3.39	0.35	4.00	-0.61	-9.70	4.09	0.36	4.00	5.81	0.64														
0.00	120.00	-8.58	-22.20	2.37	-12.63	4.00	0.00	120.00	-1.36	-9.96	-0.73	0.14	4.00	-0.61	-9.71	4.10	0.36	4.00	5.81	0.64														
0.00	130.00	-5.76	-33.45	1.09	-7.82	4.00	0.00	130.00	-2.18	-9.72	1.09	-0.36	4.00	-0.60	-9.70	4.10	0.36	4.00	5.81	0.64														
0.00	140.00	-3.84	-28.93	-0.73	-4.93	4.00	0.00	140.00	-3.4	-9.76	2.36	-1.16	4.00	-0.60	-9.71	4.09	0.36	4.00	5.81	0.64														
0.00	150.00	-2.50	-20.75	-3.38	-2.97	4.00	0.00	150.00	-5.12	-10.06	3.24	-2.35	4.00	-0.61	-9.70	4.10	0.36	4.00	5.81	0.64														
0.00	160.00	-1.57	-16.78	-7.63	-1.60	4.00	0.00	160.00	-7.62	-10.65	3.8	-4.04	4.00	-0.61	-9.70	4.10	0.36	4.00	5.81	0.64														
0.00	170.00	-0.97	-14.26	-17.07	-0.65	4.00	0.00	170.00	-11.55	-11.58	4.06	-6.48	4.00	-0.61	-9.71	4.09	0.36	4.00	5.81	0.63														
0.00	180.00	-0.66	-12.53	-17.12	-0.03	4.00	0.00	180.00	-19.56	-12.91	4.06	-10.3	4.00	-0.60	-9.71	4.09	0.36	4.00	5.81	0.63														
0.00	190.00	-0.62	-11.30	-7.65	0.29	4.00	0.00	190.00	-24.84	-14.81	3.8	-17.86	4.00	-0.60	-9.70	4.10	0.36	4.00	5.81	0.64														
0.00	200.00	-0.85	-10.47	-3.39	0.35	4.00	0.00	200.00	-13.23	-17.61	3.24	-25.41	4.00	-0.61	-9.70	4.09	0.36	4.00	5.81	0.64														
0.00	210.00	-1.36	-9.96	-0.73	0.14	4.00	0.00	210.00	-8.58	-22.2	2.37	-12.63	4.00	-0.61	-9.71	4.10	0.36	4.00	5.81	0.64														
0.00	220.00	-2.18	-9.72	1.09	-0.36	4.00	0.00	220.00	-5.76	-33.45	1.09	-7.82	4.00	-0.60	-9.70	4.10	0.36	4.00	5.81	0.64														
0.00	230.00	-3.40	-9.76	2.36	-1.16	4.00	0.00	230.00	-3.84	-28.93	-0.73	-4.93	4.00	-0.60	-9.71	4.09	0.36	4.00	5.81	0.64														
0.00	240.00	-5.12	-10.06	3.24	-2.35	4.00	0.00	240.00	-2.5	-20.75	-3.38	-2.97	4.00	-0.61	-9.70	4.10	0.36	4.00	5.81	0.64														
0.00	250.00	-7.62	-10.65	3.80	-4.04	4.00	0.00	250.00	-1.57	-16.78	-7.63	-1.6	4.00	-0.61	-9.70	4.10	0.36	4.00	5.81	0.64														
0.00	260.00	-11.55	-11.58	4.06	-6.48	4.00	0.00	260.00	-0.97	-14.26	-17.07	-0.65	4.00	-0.61	-9.71	4.09	0.36	4.00	5.81	0.63														
0.00	270.00	-19.56	-12.91	4.06	-10.30	4.00	0.00	270.00	-0.66	-12.53	-17.12	-0.03	4.00	-0.60	-9.71	4.09	0.36	4.00	5.81	0.63														
0.00	280.00	-24.84	-14.81	3.80	-17.86	4.00	0.00	280.00	-0.62	-11.3	-7.65	0.29	4.00	-0.60	-9.70	4.10	0.36	4.00	5.81	0.64														
0.00	290.00	-13.23	-17.61	3.24	-25.41	4.00	0.00	290.00	-0.85	-10.47	-3.39	0.35	4.00	-0.61	-9.70	4.09	0.36	4.00	5.81	0.64														
0.00	300.00	-8.58	-22.20	2.37	-12.63	4.00	0.00	300.00	-1.36	-9.96	-0.73	0.14	4.00	-0.61	-9.71	4.10	0.36	4.00	5.81	0.64														
0.00	310.00	-5.76	-33.45	1.09	-7.82	4.00	0.00	310.00	-2.18	-9.72	1.09	-0.36	4.00	-0.60	-9.70	4.10	0.36	4.00	5.81	0.64														
0.00	320.00	-3.84	-28.93	-0.73	-4.93	4.00	0.00	320.00	-3.4	-9.76	2.36	-1.16	4.00	-0.60	-9.71	4.09	0.36	4.00	5.81	0.64														
0.00	330.00	-2.50	-20.75	-3.38	-2.97	4.00	0.00	330.00	-5.12	-10.06	3.24	-2.35	4.00	-0.61	-9.70	4.10	0.36	4.00	5.81	0.64														
0.00	340.00	-1.57	-16.78	-7.63	-1.60	4.00	0.00	340.00	-7.62	-10.65	3.8	-4.04	4.00	-0.61	-9.70	4.10	0.36	4.00	5.81	0.64														
0.00	350.00	-0.97	-14.26	-17.07	-0.65	4.00	0.00	350.00	-11.55	-11.58	4.06	-6.48	4.00	-0.61	-9.71	4.09	0.36	4.00	5.81	0.63														
15.00	0.00	-1.68	-8.53	-18.73	-1.40	4.00	15.00	0.00	-21.07	-11.03	3.83	-10.79	4.00	-1.63	-6.59	3.85	-0.93	4.00	5.47	0.15														
15.00	10.00	-1.80	-8.71	-17.04	-1.99	4.00	15.00	10.00	-26.51	-11.25	3.81	-8.42	4.00	-1.79	-6.79	3.85	-1.10	4.00	5.37	0.08														
15.00	20.00	-1.98	-8.49	-8.65	-2.92	4.00	15.00	20.00	-13.04	-11.08	3.56	-6.27	4.00	-1.65	-6.58	3.81	-1.27	4.00	5.37	0.06														
15.00	30.00	-2.45	-8.58	-4.29	-4.30	4.00	15.00	30.00	-7.95	-11.01	2.91	-4.71	4.00	-1.37	-6.62	3.67	-1.49	4.00	5.32	-0.02														
15.00	40.00	-2.97	-8.30	-1.68	-6.16	4.00	15.00	40.00	-5.29	-10.98	1.94	-3.52	4.00	-0.97	-6.43	3.51	-1.63	4.00	5.34	-0.05														
15.00	50.00	-3.77	-8.24	0.10	-8.46	4.00	15.00	50.00	-3.24	-11.62	0.65	-2.76	4.00	-0.49	-6.60	3.39	-1.72	4.00	5.37	-0.03														
15.00	60.00	-5.14	-8.00	1.40	-11.93	4.00	15.00	60.00	-1.65	-12.62	-1.09	-2.16	4.00	-0.04	-6.71	3.34	-1.72	4.00	5.45	0.04														
15.00	70.00	-7.18	-8.31	2.30	-17.74	4.00	15.00	70.00	-0.5	-13	-3.7	-1.85	4.00	0.34	-7.04	3.27	-1.74	4.00	5.49	0.08														
15.00	80.00	-10.80	-8.86	2.98	-21.71	4.00	15.00	80.00	0.24	-12.67	-7.81	-1.69	4.00	0.57	-7.35	3.33	-1.65	4.00	5.55	0.17														
15.00	90.00	-18.54	-9.72	3.24	-14.86	4.00	15.00	90.00	0.65	-12.7	-15.83	-1.71	4.00	0.70	-7.95	3.29	-1.50	4.00	5.54	0.19														
15.00	100.00	-23.83	-10.34	3.26	-10.00	4.00	15.00	100.00	0.75	-12.28	-16.66	-1.95	4.00	0.77	-8.19	3.30	-1.32	4.00	5.58	0.24														
15.00	110.00	-12.82	-10.42	2.97	-7.23	4.00	15.00	110.00	0.49	-12.91	-7.74	-2.7	4.00	0.69	-8.48	3.32	-1.39	4.00	5.52	0.20														
15.00	120.00	-7.94	-10.93	2.36	-5.20	4.00	15.00	120.00	-0.06	-13.65	-3.5	-3.88	4.00	0.60	-9.07	3.36	-1.48	4.00	5.43	0.16														
15.00	130.00	-5.07	-11.96	1.37	-3.83	4.00	15.00	130.00	-1.04	-14.1	-0.67	-5.36	4.00	0.41	-9.89	3.48	-1.52	4.00	5.34	0.14														
15.00	140.00	-3.22	-12.05	0.03	-2.71	4.00	15.00	140.00	-2.27	-14.71	1.06	-7.28	4.00	0.29	-10.17	3.56	-1.41	4.00	5.35	0.17														
15.00	150.00	-1.99	-12.52	-1.75	-2.07	4.00	15.00	150.00	-4.43	-15.36	2.26	-8.84	4.00	-0.03	-10.70	3.71	-1.24	4.00	5.32	0.19														
15.00	160.00	-1.02	-12.76	-4.46	-1.50	4.00	15.00	160.00	-7.83	-16.03	3.25	-10.98	4.00	-0.20	-11.08	3.93	-1.04	4.00	5.38	0.31														
15.00	170.00	-0.55	-13.34	-8.65	-1.21	4.00	15.00	170.00	-13.06	-15.73	3.74	-11.7	4.00	-0.31	-11.36	3.98	-0.84	4.00	5.40	0.34														
15.00	180.00	-0.54	-13.51	-16.00	-1.17	4.00	15.00	180.00	-23.87	-14.85	3.95	-10.59	4.00	-0.52	-11.12	3.99	-0.70	4.00	5.40	0.34														
15.00	190.00	-0.86	-13.65	-15.09	-1.27	4.00	15.00	190.00	-12.56	-13.41	3.81	-8.54	4.00	-0.58	-10.52	3.87	-0.52	4.00	5.43	0.30														
15.00	200.00	-1.35	-14.69	-7.95	-1.65	4.00	15.00	200.00	-7.66	-12.31	3.44	-6.18	4.00	-0.44	-10.33	3.74	-0.34	4.00	5.47	0.30														
15.00	210.00	-2.20	-15.03	-4.68	-2.22	4.00	15.00	210.00	-5.17	-11.3	2.81	-4.43	4.00	-0.43	-9.77	3.52	-0.18	4.00	5.48	0.24														



45.00	140.00	-1.21	-3.00	-4.36	-4.38	4.00	45.00	140.00	1.22	-13.68	1.02	-0.67	4.00
45.00	150.00	-0.27	-2.58	-6.17	-3.43	4.00	45.00	150.00	-1.5	-10.97	2.2	-3.08	4.00
45.00	160.00	-0.23	-2.77	-9.33	-2.89	4.00	45.00	160.00	-5.62	-9.53	3.08	-7.42	4.00
45.00	170.00	-0.40	-3.54	-14.61	-2.57	4.00	45.00	170.00	-12.37	-9.69	3.37	-15.35	4.00
45.00	180.00	-1.04	-4.39	-23.64	-2.50	4.00	45.00	180.00	-15.86	-9.78	3.4	-18	4.00
45.00	190.00	-2.61	-4.96	-17.69	-2.72	4.00	45.00	190.00	-7.94	-9.49	3.08	-11.1	4.00
45.00	200.00	-4.95	-5.53	-12.22	-2.82	4.00	45.00	200.00	-4.81	-8.6	2.72	-7.77	4.00
45.00	210.00	-6.07	-6.03	-9.37	-3.06	4.00	45.00	210.00	-3.86	-8.05	2.15	-5.95	4.00
45.00	220.00	-5.95	-6.84	-7.00	-3.67	4.00	45.00	220.00	-3.12	-8.23	1.11	-3.81	4.00
45.00	230.00	-5.95	-7.41	-5.81	-4.54	4.00	45.00	230.00	-1.96	-9.51	-0.39	-1.83	4.00
45.00	240.00	-7.31	-8.08	-4.76	-5.89	4.00	45.00	240.00	-0.7	-10.69	-2.73	-0.12	4.00
45.00	250.00	-10.61	-8.79	-4.02	-8.23	4.00	45.00	250.00	0.06	-12.43	-6.07	1.15	4.00
45.00	260.00	-15.90	-9.47	-3.67	-11.83	4.00	45.00	260.00	0.22	-14.99	-11.19	1.8	4.00
45.00	270.00	-23.94	-10.31	-3.63	-15.98	4.00	45.00	270.00	-0.19	-15.78	-21.99	1.98	4.00
45.00	280.00	-17.68	-9.80	-3.76	-13.81	4.00	45.00	280.00	-1.09	-13.75	-14.77	1.76	4.00
45.00	290.00	-13.19	-8.10	-3.79	-9.70	4.00	45.00	290.00	-2.6	-11.21	-8.42	1.27	4.00
45.00	300.00	-11.86	-5.62	-4.40	-6.97	4.00	45.00	300.00	-4.86	-8.97	-4.65	0.57	4.00
45.00	310.00	-11.66	-3.36	-5.55	-4.92	4.00	45.00	310.00	-7.2	-7.72	-1.99	-0.27	4.00
45.00	320.00	-9.71	-1.88	-7.47	-3.64	4.00	45.00	320.00	-10.45	-6.86	-0.18	-1.64	4.00
45.00	330.00	-6.87	-1.26	-9.66	-2.91	4.00	45.00	330.00	-12.44	-7.25	1.04	-3.56	4.00
45.00	340.00	-4.50	-1.53	-12.75	-2.97	4.00	45.00	340.00	-13.33	-8.09	2.04	-7.51	4.00
45.00	350.00	-3.17	-1.81	-16.56	-3.57	4.00	45.00	350.00	-19.27	-10.24	2.73	-15.21	4.00
60.00	0.00	-3.99	0.29	-17.68	-7.98	4.00	60.00	0.00	-12.3	-26.95	2.23	-25	4.00
60.00	10.00	-4.17	1.50	-14.55	-10.98	4.00	60.00	10.00	-4.69	-24.19	2.64	-13.34	4.00
60.00	20.00	-4.60	1.78	-11.17	-10.35	4.00	60.00	20.00	-2.12	-16.08	2.66	-7.74	4.00
60.00	30.00	-5.24	1.26	-8.36	-8.69	4.00	60.00	30.00	-1.74	-13.51	2.08	-5.71	4.00
60.00	40.00	-5.68	0.88	-7.13	-8.18	4.00	60.00	40.00	-1.46	-13.77	0.98	-4.48	4.00
60.00	50.00	-6.22	0.79	-6.51	-8.69	4.00	60.00	50.00	-0.39	-14.84	-0.77	-3.11	4.00
60.00	60.00	-7.20	0.78	-6.03	-10.41	4.00	60.00	60.00	0.88	-17.2	-3.21	-1.33	4.00
60.00	70.00	-8.49	0.81	-5.78	-12.69	4.00	60.00	70.00	1.89	-19.62	-7.03	0.31	4.00
60.00	80.00	-10.24	0.78	-5.62	-13.78	4.00	60.00	80.00	2.82	-20.54	-12.26	1.35	4.00
60.00	90.00	-14.01	0.75	-5.39	-13.33	4.00	60.00	90.00	3.5	-18.43	-24.44	2.26	4.00
60.00	100.00	-15.73	0.63	-5.24	-11.63	4.00	60.00	100.00	3.85	-16.47	-12.59	2.58	4.00
60.00	110.00	-11.30	0.42	-5.09	-10.22	4.00	60.00	110.00	3.88	-15.78	-7.33	2.64	4.00
60.00	120.00	-6.76	0.08	-5.31	-9.48	4.00	60.00	120.00	3.37	-15.03	-3.56	2.26	4.00
60.00	130.00	-3.65	-0.07	-5.48	-9.29	4.00	60.00	130.00	2.31	-14.17	-0.92	1.36	4.00
60.00	140.00	-2.20	0.10	-6.40	-9.57	4.00	60.00	140.00	0.19	-13.05	0.74	-0.21	4.00
60.00	150.00	-2.27	-0.12	-7.94	-8.76	4.00	60.00	150.00	-3.93	-12.59	1.97	-2.6	4.00
60.00	160.00	-3.27	-0.69	-11.23	-7.01	4.00	60.00	160.00	-12.03	-12.64	2.5	-6.25	4.00
60.00	170.00	-4.79	-1.23	-16.50	-5.83	4.00	60.00	170.00	-30.48	-11.43	2.6	-10.33	4.00
60.00	180.00	-6.51	-2.00	-33.69	-5.15	4.00	60.00	180.00	-12.14	-9.18	2.4	-11.71	4.00
60.00	190.00	-9.81	-2.97	-23.92	-5.25	4.00	60.00	190.00	-7.43	-7.55	1.9	-8.14	4.00
60.00	200.00	-12.49	-3.82	-19.76	-5.78	4.00	60.00	200.00	-5.99	-6.7	1.04	-5.08	4.00
60.00	210.00	-9.52	-4.16	-14.01	-5.76	4.00	60.00	210.00	-7.2	-6.67	-0.1	-2.99	4.00
60.00	220.00	-7.61	-4.27	-9.76	-5.93	4.00	60.00	220.00	-11.19	-6.66	-1.64	-1.36	4.00
60.00	230.00	-7.39	-5.09	-7.63	-6.29	4.00	60.00	230.00	-12.7	-6.46	-3.65	-0.07	4.00
60.00	240.00	-9.03	-6.48	-6.93	-7.31	4.00	60.00	240.00	-8.77	-6.89	-6.54	0.95	4.00
60.00	250.00	-12.44	-8.66	-6.96	-9.36	4.00	60.00	250.00	-5.99	-8.03	-9.99	1.51	4.00
60.00	260.00	-18.95	-10.36	-6.97	-12.35	4.00	60.00	260.00	-4.93	-10.59	-15.63	1.66	4.00
60.00	270.00	-31.19	-11.11	-7.36	-18.02	4.00	60.00	270.00	-4.96	-14.19	-27.35	1.58	4.00
60.00	280.00	-17.26	-10.56	-7.84	-34.89	4.00	60.00	280.00	-6.11	-16.64	-15.42	1.3	4.00
60.00	290.00	-13.71	-8.97	-8.84	-21.06	4.00	60.00	290.00	-8.12	-15.35	-10.3	0.9	4.00
60.00	300.00	-12.42	-7.51	-9.80	-14.16	4.00	60.00	300.00	-10.39	-14.71	-6.25	0.07	4.00
60.00	310.00	-11.89	-5.58	-11.56	-10.23	4.00	60.00	310.00	-9.4	-16.57	-3.42	-1.41	4.00
60.00	320.00	-9.02	-2.75	-14.38	-7.74	4.00	60.00	320.00	-8.49	-15.03	-1.65	-3.09	4.00
60.00	330.00	-5.70	-0.54	-19.84	-5.91	4.00	60.00	330.00	-10.51	-12.14	-0.55	-4.92	4.00
60.00	340.00	-4.02	-0.09	-22.10	-4.93	4.00	60.00	340.00	-16.63	-13.15	0.71	-7.28	4.00
60.00	350.00	-3.85	-0.17	-19.37	-5.50	4.00	60.00	350.00	-31.19	-16.22	1.47	-10.73	4.00
75.00	0.00	-10.94	0.47	-22.73	-12.11	4.00	75.00	0.00	-9.85	-14.2	0.22	-20.38	4.00
75.00	10.00	-10.78	1.75	-23.37	-14.20	4.00	75.00	10.00	-6.55	-15.34	0.94	-18.66	4.00
75.00	20.00	-11.14	2.97	-17.49	-18.24	4.00	75.00	20.00	-3.7	-24.59	1.72	-8.83	4.00
75.00	30.00	-11.21	2.50	-13.36	-24.78	4.00	75.00	30.00	-3.81	-25.11	1.55	-5.26	4.00
75.00	40.00	-10.31	1.62	-10.91	-25.59	4.00	75.00	40.00	-3.42	-22.02	0.67	-4.18	4.00
75.00	50.00	-9.59	1.41	-10.4	-19.60	4.00	75.00	50.00	-1.42	-26.88	-0.84	-3.41	4.00
75.00	60.00	-8.9	1.46	-10.23	-16.53	4.00	75.00	60.00	0.36	-35.85	-3.06	-2.85	4.00
75.00	70.00	-9.16	1.69	-10.35	-14.86	4.00	75.00	70.00	1.59	-26.59	-5.94	-1.85	4.00
75.00	80.00	-10.88	1.89	-10.47	-13.52	4.00	75.00	80.00	2.59	-20.84	-9.98	-0.74	4.00
75.00	90.00	-13.32	2.07	-10.15	-12.30	4.00	75.00	90.00	3.2	-17.91	-18.33	-0.07	4.00
75.00	100.00	-16.33	2.11	-9.72	-11.99	4.00	75.00	100.00	3.38	-16.26	-19.47	0.23	4.00
75.00	110.00	-16.5	1.93	-9.21	-12.71	4.00	75.00	110.00	3.09	-16.69	-9.88	0.23	4.00
75.00	120.00	-12.65	1.89	-8.84	-14.85	4.00	75.00	120.00	2.41	-21.08	-5.24	0	4.00
75.00	130.00	-9.54	2.22	-8.64	-19.89	4.00	75.00	130.00	1.5	-34.09	-2.34	-0.41	4.00
75.00	140.00	-7.47	2.48	-9.23	-22.59	4.00	75.00	140.00	0.18	-17.8	-0.2	-1.59	4.00
75.00	150.00	-6.28	2.28	-10.96	-15.66	4.00	75.00	150.00	-3.33	-12.93	1.05	-3.49	4.00
75.00	160.00	-6.41	1.37	-15.35	-11.32	4.00	75.00	160.00	-10.14	-10.73	1.64	-6.97	4.00
75.00	170.00	-7.13	-0.09	-23.14	-9.84	4.00	75.00	170.00	-15.15	-9.8	1.75	-11.85	4.00
75.00	180.00	-9.39	-1.75	-28.02	-10.81	4.00	75.00	180.00	-16.51	-7.95	1.69	-13.2	4.00
75.00	190.00	-11.41	-2.59	-26.27	-13.97	4.00	75.00	190.00	-17.59	-6.63	1.22	-7.56	4.00
75.00	200.00	-13.72	-2.76	-19.20	-16.69	4.00	75.00	200.00	-11.35	-6.83	0.44	-4.04	4.00
75.00	210.00	-15.38	-3.44	-15.22	-16.04	4.00	75.00	210.00	-10.06	-7.25	-0.77	-2.22	4.00
75.00	220.00	-13.17	-5.08	-13.81	-14.59	4.00	75.00	220.00	-12.38	-6.35	-2.75	-1.14	4.00
75.00	230.00	-11.28	-6.39	-13.37	-12.94	4.00	75.00	230.00	-13.1	-5.31	-5.22	-0.23	4.00
75.00	240.00	-11.01	-7.04	-13.64	-12.49	4.00	75.00	240.00	-7.86	-5.11	-8.17	0.37	4.00
75.00	250.00	-12.82	-7.64	-12.35	-12.70	4.00	75.00	250.00	-4.94	-6.14	-12.1	0.59	4.00
75.00	260.00	-16.15	-7.86	-11.59	-13.18	4.00	75.00	260.00	-3.69	-8.8	-18.39	0.68	4.00
75.00	270.00	-22.71	-8.56	-11.37	-14.10	4.00	75.00	270.00	-4.15	-13.97	-21.02	0.48	4.00
75.00	280.00	-27.26	-9.71	-11.63	-14.19	4.00	75.00	280.00	-5.89	-19.5	-13.14	0.16	4.00
75.00	290.00	-20.57	-10.29	-12.84	-15.71	4.00	75.00	290.00	-9.45	-13.06	-8.92	-0.5	4.00
75.00	300.00	-18.70	-8.46	-13.52	-19.29	4.00	75.00	300.00	-11.2	-9.18</			



105.00	0.00	-14.92	0.05	-19.25	-11.34	4.00	105.00	0.00	-12.92	-10.86	-2.07	-11.35	4.00	-10.80	0.39	-1.99	-8.33	4.00	1.98	-3.11
105.00	10.00	-14.07	0.53	-25.53	-9.43	4.00	105.00	10.00	-10.75	-9.78	-1.55	-13.58	4.00	-9.09	0.92	-1.53	-8.02	4.00	2.60	-2.56
105.00	20.00	-9.03	0.78	-30.91	-9.42	4.00	105.00	20.00	-5.61	-1.12	-1.31	-14.74	4.00	-3.98	1.00	-1.31	-8.30	4.00	3.52	-1.96
105.00	30.00	-7.86	0.20	-21.72	-11.92	4.00	105.00	30.00	-3.59	-16.21	-1.48	-12.96	4.00	-2.21	0.30	-1.44	-9.40	4.00	3.51	-2.03
105.00	40.00	-10.04	-0.87	-15.28	-14.16	4.00	105.00	40.00	-2.5	-19.17	-2	-7.62	4.00	-1.80	-0.81	-1.80	-6.75	4.00	3.51	-2.28
105.00	50.00	-13.80	-1.24	-12.68	-15.14	4.00	105.00	50.00	-1.93	-41.41	-3.21	-4.21	4.00	-1.66	-1.24	-2.75	-3.87	4.00	3.70	-2.26
105.00	60.00	-15.28	-0.60	-11.54	-15.60	4.00	105.00	60.00	-1.81	-21.74	-5.26	-2.47	4.00	-1.62	-0.57	-4.34	-2.26	4.00	3.93	-1.99
105.00	70.00	-13.59	0.63	-11.72	-14.82	4.00	105.00	70.00	-1.67	-19.47	-8.78	-1.58	4.00	-1.40	0.67	-7.00	-1.38	4.00	4.17	-1.52
105.00	80.00	-13.77	1.69	-11.04	-14.17	4.00	105.00	80.00	-1	-19.92	-14.34	-1.09	4.00	-0.78	1.72	-9.37	-0.88	4.00	4.55	-0.90
105.00	90.00	-14.98	2.64	-10.56	-15.16	4.00	105.00	90.00	-0.4	-26.48	-31.38	-0.61	4.00	-0.25	2.65	-10.52	-0.46	4.00	5.04	-0.26
105.00	100.00	-16.81	3.41	-10.13	-17.32	4.00	105.00	100.00	0.02	-36.75	-16.45	-0.34	4.00	0.11	3.41	-9.22	-0.25	4.00	5.60	0.30
105.00	110.00	-19.08	4.06	-9.63	-20.87	4.00	105.00	110.00	0.12	-35.23	-10.19	-0.03	4.00	0.17	4.06	-6.89	0.01	4.00	6.17	0.79
105.00	120.00	-18.68	4.47	-9.54	-21.62	4.00	105.00	120.00	0.09	-27.27	-6.41	0.39	4.00	0.15	4.47	-4.69	0.42	4.00	6.69	1.20
105.00	130.00	-15.15	4.89	-11.24	-17.84	4.00	105.00	130.00	-0.39	-16.93	-4.31	0.44	4.00	-0.25	4.92	-3.51	0.50	4.00	6.97	1.47
105.00	140.00	-11.88	5.04	-14.32	-16.37	4.00	105.00	140.00	-1.45	-12.73	-3.16	-0.2	4.00	-1.07	5.11	-2.84	-0.10	4.00	6.84	1.40
105.00	150.00	-8.40	4.29	-19.76	-17.18	4.00	105.00	150.00	-4.41	-10.86	-2.78	-2.03	4.00	-2.95	4.42	-2.69	-1.90	4.00	5.83	0.47
105.00	160.00	-6.55	2.90	-32.09	-18.40	4.00	105.00	160.00	-11.58	-12.29	-2.62	-5.63	4.00	-5.36	3.03	-2.62	-5.41	4.00	4.17	-1.06
105.00	170.00	-5.82	1.86	-23.51	-15.48	4.00	105.00	170.00	-29.25	-13.67	-2.55	-10.83	4.00	-5.80	1.98	-2.52	-9.55	4.00	3.08	-2.02
105.00	180.00	-5.30	0.36	-21.68	-14.26	4.00	105.00	180.00	-15.2	-12.91	-2.47	-15.74	4.00	-4.88	0.56	-2.42	-11.93	4.00	2.44	-2.80
105.00	190.00	-5.29	-2.02	-22.71	-15.73	4.00	105.00	190.00	-10.15	-20.61	-2.75	-13.21	4.00	-4.06	-1.96	-2.71	-11.28	4.00	1.69	-3.87
105.00	200.00	-6.76	-2.59	-15.31	-20.85	4.00	105.00	200.00	-5.86	-20.66	-3.64	-8.79	4.00	-3.28	-2.52	-3.35	-8.53	4.00	1.90	-3.89
105.00	210.00	-9.84	-2.32	-12.30	-26.94	4.00	105.00	210.00	-5.09	-16.71	-5.22	-5.05	4.00	-3.84	-2.16	-4.44	-5.02	4.00	2.22	-3.73
105.00	220.00	-18.88	-2.99	-12.75	-21.82	4.00	105.00	220.00	-8.66	-20.01	-8.47	-1.98	4.00	-8.27	-2.90	-7.09	-1.94	4.00	1.38	-4.27
105.00	230.00	-18.24	-4.59	-15.76	-19.52	4.00	105.00	230.00	-25.49	-30.02	-9.96	0.08	4.00	-17.49	-4.58	-8.95	0.13	4.00	0.41	-4.19
105.00	240.00	-14.64	-6.06	-17.20	-21.24	4.00	105.00	240.00	-12.38	-20.91	-8.51	1.46	4.00	-10.35	-5.92	-7.96	1.48	4.00	1.57	-3.20
105.00	250.00	-16.35	-6.39	-16.03	-25.35	4.00	105.00	250.00	-7.75	-17.48	-8.78	2.23	4.00	-7.19	-6.06	-8.03	2.24	4.00	2.36	-2.46
105.00	260.00	-21.20	-5.77	-14.57	-20.37	4.00	105.00	260.00	-6.95	-15.6	-10.87	2.49	4.00	-6.79	-5.34	-9.33	2.51	4.00	2.53	-2.21
105.00	270.00	-40.29	-5.92	-14.82	-16.29	4.00	105.00	270.00	-7.95	-15.55	-16.06	2.07	4.00	-7.95	-5.47	-12.39	2.13	4.00	1.77	-2.72
105.00	280.00	-29.31	-8.47	-15.36	-14.02	4.00	105.00	280.00	-12.86	-15.69	-21.88	0.69	4.00	-12.76	-7.72	-14.49	0.83	4.00	-0.31	-4.35
105.00	290.00	-29.92	-18.57	-14.51	-13.40	4.00	105.00	290.00	-17.85	-16.92	-15.97	-2.43	4.00	-17.59	-14.66	-12.17	-2.10	4.00	-3.42	-7.39
105.00	300.00	-18.32	-9.68	-13.06	-14.01	4.00	105.00	300.00	-9.35	-19.23	-13.09	-8.61	4.00	-8.83	-9.22	-10.06	-7.51	4.00	-2.84	-8.81
105.00	310.00	-11.51	-3.76	-10.81	-16.91	4.00	105.00	310.00	-6.66	-15.57	-13.2	-12.72	4.00	-5.43	-3.48	-8.83	-11.32	4.00	-0.73	-6.29
105.00	320.00	-7.97	-2.60	-9.62	-22.12	4.00	105.00	320.00	-8.31	-9.8	-13.05	-8	4.00	-5.13	-1.84	-7.99	-7.83	4.00	0.70	-4.93
105.00	330.00	-6.83	-4.05	-9.56	-38.03	4.00	105.00	330.00	-13.65	-7.75	-9.45	-7.66	4.00	-6.01	-2.51	-6.49	-7.66	4.00	0.58	-5.20
105.00	340.00	-7.46	-3.70	-10.70	-23.62	4.00	105.00	340.00	-13.07	-8.61	-5.48	-8.45	4.00	-6.41	-2.48	-4.34	-8.32	4.00	0.91	-4.85
105.00	350.00	-10.16	-1.04	-13.88	-15.88	4.00	105.00	350.00	-11.02	-11.57	-3.23	-9.31	4.00	-7.56	-0.67	-2.87	-8.45	4.00	1.73	-3.74
120.00	0.00	-8.46	-3.18	-18.90	-7.27	4.00	120.00	0.00	-17.24	-22.68	-5.34	-10.52	4.00	-7.92	-3.13	-5.15	-5.59	4.00	0.74	-5.12
120.00	10.00	-4.42	-3.85	-23.11	-7.43	4.00	120.00	10.00	-11.63	-21.77	-4.52	-10.78	4.00	-3.66	-3.78	-4.46	-5.78	4.00	1.64	-4.34
120.00	20.00	-2.98	-3.34	-22.59	-8.04	4.00	120.00	20.00	-6.77	-24.52	-4.2	-9.91	4.00	-1.46	-3.31	-4.14	-5.86	4.00	2.47	-3.41
120.00	30.00	-3.61	-2.95	-23.10	-8.74	4.00	120.00	30.00	-6.37	-23.67	-3.91	-10.61	4.00	-1.76	-2.91	-3.86	-6.56	4.00	2.42	-3.45
120.00	40.00	-5.20	-2.83	-18.62	-9.01	4.00	120.00	40.00	-6.9	-18.21	-3.93	-11.1	4.00	-2.96	-2.71	-3.78	-6.92	4.00	2.08	-3.81
120.00	50.00	-7.53	-2.22	-13.94	-8.94	4.00	120.00	50.00	-7.19	-16.2	-4.69	-9.02	4.00	-4.35	-2.05	-4.20	-5.97	4.00	1.99	-3.91
120.00	60.00	-9.95	-1.04	-9.88	-9.44	4.00	120.00	60.00	-7.1	-13.86	-6.42	-5.95	4.00	-5.28	-0.82	-4.80	-4.34	4.00	2.40	-3.41
120.00	70.00	-12.78	0.28	-7.32	-10.91	4.00	120.00	70.00	-6.19	-13.76	-9.54	-3.41	4.00	-5.33	0.45	-5.28	-2.70	4.00	3.14	-2.53
120.00	80.00	-15.25	1.23	-6.17	-12.40	4.00	120.00	80.00	-4.77	-14.27	-15.08	-1.92	4.00	-4.40	1.35	-5.64	-1.55	4.00	3.89	-1.71
120.00	90.00	-17.76	2.00	-5.56	-15.64	4.00	120.00	90.00	-3.25	-16.55	-2.9	-0.76	4.00	-3.10	2.06	-5.54	-0.62	4.00	4.68	-0.91
120.00	100.00	-17.66	2.78	-5.51	-17.09	4.00	120.00	100.00	-2.09	-20.84	-13.45	0.07	4.00	-1.97	2.80	-4.86	0.15	4.00	5.50	-0.11
120.00	110.00	-14.45	3.36	-6.39	-13.85	4.00	120.00	110.00	-1.34	-31.98	-8.3	0.37	4.00	-1.13	3.36	-4.23	0.53	4.00	6.08	0.46
120.00	120.00	-11.00	3.59	-8.00	-10.18	4.00	120.00	120.00	-0.94	-21.99	-5.05	0.47	4.00	-0.53	3.60	-3.27	0.83	4.00	6.53	0.84
120.00	130.00	-8.70	3.35	-10.87	-7.73	4.00	120.00	130.00	-0.9	-15.28	-2.62	0.06	4.00	-0.23	3.41	-2.01	0.73	4.00	6.72	0.93
120.00	140.00	-7.32	2.60	-15.58	-6.40	4.00	120.00	140.00	-1.56	-12.19	-1.35	-1.17	4.00	-0.54	2.74	-1.19	-0.03	4.00	6.40	0.53
120.00	150.00	-6.49	1.64	-21.36	-6.24	4.00	120.00	150.00	-3.74	-12.65	-0.8	-3.44	4.00	-1.89	1.80	-0.76	-1.61	4.00	5.53	-0.35
120.00	160.00	-6.11	0.83	-25.12	-6.90	4.00	120.00	160.00	-7.99	-12.76	-1.5	-7.42	4.00	-3.94	1.02	-1.48	-4.14	4.00	4.15	-1.61
120.00	170.00	-5.91	0.15	-22.92	-8.00	4.00	120.00	170.00	-14.62	-11.45	-3.38	-12.33	4.00	-5.36	0.44	-3.33	-6.64	4.00	2.73	-2.84
120.00	180.00	-6.11	-0.76	-15.85	-7.66	4.00	120.00	180.00	-19.05	-12.94	-5.23	-15.98	4.00	-5.89	-0.50	-4.87	-7.06	4.00	1.82	-3.79
120.00	190.00	-7.05	-1.17	-12.06	-7.40	4.00	120.00	190.00	-10.35	-19.94	-5.47	-11.23	4.00	-5.38	-1.11	-4.61	-5.90	4.00	1.98	-3.80
120.00	200.00	-9.19	-1.96	-10.38	-8.23	4.00	120.00	200.00	-5.7	-22.89	-6.59	-7.33	4.00	-4.09	-1.93	-5.07	-4.75	4.00	2.15	-3.77
120.00	210.00	-12.50	-3.73	-9.65	-10.54	4.00	120.00	210.00	-3.68	-16.55	-10.59	-5.7	4.00	-3.14	-3.51	-7.08	-4.47	4.00	1.60	-4.31
120.00	220.00	-14.49	-5.17	-9.64	-12.44	4.00	120.00	220.00	-3.27	-14.74	-15.01	-4.4	4.00	-2.95	-4.72	-8.53	-3.77	4.00	1.27	-4.55
120.00	230.00	-14.62	-4.90	-9.63	-14.09	4.00	120.00	230.00	-2.93	-15.85	-12.21	-2.51	4.00	-2.65	-4.56	-7.72	-2.22	4.00	1.99	-3.81
120.00	240.00																			



150.00	220.00	-3.17	-5.65	-13.21	-16.02	4.00	150.00	220.00	-3.22	-18.5	-13.98	-6.87	4.00	-0.18	-5.43	-10.57	-6.37	4.00	1.18	-4.08
150.00	230.00	-4.55	-4.92	-14.02	-13.02	4.00	150.00	230.00	-0.78	-21.7	-10.44	-4.09	4.00	0.74	-4.83	-8.86	-3.57	4.00	2.56	-2.83
150.00	240.00	-6.97	-4.21	-15.49	-13.11	4.00	150.00	240.00	0.73	-21.4	-9.65	-1.79	4.00	1.41	-4.13	-8.64	-1.48	4.00	3.55	-1.84
150.00	250.00	-12.02	-4.19	-17.31	-15.27	4.00	150.00	250.00	1.58	-21.07	-10.18	-0.43	4.00	1.77	-4.10	-9.41	-0.29	4.00	3.96	-1.34
150.00	260.00	-22.84	-4.67	-16.41	-18.08	4.00	150.00	260.00	1.73	-19.76	-12.37	0.05	4.00	1.75	-4.54	-10.93	0.12	4.00	3.84	-1.32
150.00	270.00	-15.41	-5.84	-15.55	-14.59	4.00	150.00	270.00	1.34	-16.06	-17.11	-0.06	4.00	1.43	-5.45	-13.25	0.09	4.00	3.35	-1.64
150.00	280.00	-9.39	-7.94	-16.70	-11.08	4.00	150.00	280.00	-0.1	-11.69	-29.1	-1.2	4.00	0.38	-6.41	-16.46	-0.78	4.00	2.24	-2.64
150.00	290.00	-7.31	-11.01	-20.61	-10.43	4.00	150.00	290.00	-2.22	-8.57	-21.62	-3.27	4.00	-1.05	-6.61	-18.08	-2.51	4.00	0.94	-4.03
150.00	300.00	-7.16	-14.40	-26.61	-12.69	4.00	150.00	300.00	-6.35	-6.6	-15.81	-7.36	4.00	-3.73	-5.93	-15.46	-6.24	4.00	-0.86	-6.27
150.00	310.00	-9.46	-11.35	-15.99	-22.34	4.00	150.00	310.00	-13.55	-5.8	-14.29	-16.3	4.00	-8.03	-4.73	-12.05	-15.33	4.00	-3.11	-8.35
150.00	320.00	-15.96	-7.53	-10.84	-16.00	4.00	150.00	320.00	-20.45	-6.5	-15.95	-21.43	4.00	-14.64	-3.97	-9.67	-14.91	4.00	-3.57	-8.42
150.00	330.00	-29.52	-5.68	-9.48	-8.51	4.00	150.00	330.00	-17.12	-8.25	-25.35	-13.88	4.00	-16.88	-3.77	-9.37	-7.40	4.00	-2.17	-7.34
150.00	340.00	-14.05	-5.28	-9.92	-6.24	4.00	150.00	340.00	-18.2	-10.51	-22.67	-11.86	4.00	-12.64	-4.14	-9.70	-5.19	4.00	-1.25	-6.73
150.00	350.00	-10.80	-5.46	-11.85	-6.37	4.00	150.00	350.00	-23.8	-11.54	-16.19	-11.43	4.00	-10.59	-4.50	-10.49	-5.19	4.00	-1.21	-6.81
165.00	0.00	-3.81	-8.76	-18.40	-4.55	4.00	165.00	0.00	-22.86	-11.99	-8.04	-19.28	4.00	-3.76	-7.07	-7.66	-4.41	4.00	0.46	-5.41
165.00	10.00	-4.31	-9.50	-16.12	-4.73	4.00	165.00	10.00	-46.96	-10.69	-8.07	-15.96	4.00	-4.31	-7.04	-7.44	-4.41	4.00	0.34	-5.57
165.00	20.00	-5.13	-10.86	-13.46	-4.76	4.00	165.00	20.00	-20.07	-9.01	-8.87	-12.13	4.00	-4.99	-6.83	-7.57	-4.03	4.00	0.28	-5.63
165.00	30.00	-6.25	-12.03	-11.21	-4.69	4.00	165.00	30.00	-14.31	-8.02	-9.66	-9.56	4.00	-5.62	-6.57	-7.36	-3.47	4.00	0.39	-5.49
165.00	40.00	-6.93	-12.78	-9.20	-4.78	4.00	165.00	40.00	-11.06	-7.71	-11.15	-7.39	4.00	-5.51	-6.53	-7.06	-2.88	4.00	0.68	-5.17
165.00	50.00	-7.21	-12.69	-7.50	-5.18	4.00	165.00	50.00	-8.36	-7.55	-13.1	-5.74	4.00	-4.74	-6.39	-6.44	-2.44	4.00	1.18	-4.68
165.00	60.00	-7.43	-11.81	-6.55	-6.50	4.00	165.00	60.00	-6.04	-7.68	-15.52	-4.36	4.00	-3.67	-6.26	-6.03	-2.29	4.00	1.62	-4.24
165.00	70.00	-8.39	-10.14	-5.62	-8.44	4.00	165.00	70.00	-4.22	-7.8	-20.56	-3.27	4.00	-2.81	-5.80	-5.48	-2.12	4.00	2.12	-3.76
165.00	80.00	-10.32	-8.14	-5.25	-12.28	4.00	165.00	80.00	-3.01	-8.35	-33.01	-2.56	4.00	-2.27	-5.23	-5.24	-2.12	4.00	2.44	-3.45
165.00	90.00	-13.55	-6.61	-5.14	-18.64	4.00	165.00	90.00	-2.12	-9.12	-21.94	-2.29	4.00	-1.82	-4.68	-5.05	-2.19	4.00	2.71	-3.20
165.00	100.00	-17.05	-5.64	-5.38	-27.95	4.00	165.00	100.00	-1.68	-11.03	-15.42	-2.13	4.00	-1.56	-4.54	-4.97	-2.12	4.00	2.85	-3.05
165.00	110.00	-15.72	-5.43	-6.09	-16.33	4.00	165.00	110.00	-1.8	-13.2	-12.16	-2.38	4.00	-1.63	-4.76	-5.13	-2.21	4.00	2.72	-3.17
165.00	120.00	-11.05	-5.54	-7.34	-11.72	4.00	165.00	120.00	-2.19	-15.69	-9.87	-2.99	4.00	-1.66	-5.14	-5.41	-2.44	4.00	2.51	-3.36
165.00	130.00	-7.24	-5.92	-9.33	-9.49	4.00	165.00	130.00	-3.04	-14.67	-8.83	-4.28	4.00	-1.64	-5.38	-6.06	-3.14	4.00	2.15	-3.69
165.00	140.00	-4.67	-6.18	-11.80	-8.19	4.00	165.00	140.00	-3.9	-13.89	-8.13	-5.86	4.00	-1.26	-5.50	-6.58	-3.86	4.00	1.96	-3.82
165.00	150.00	-2.43	-6.62	-14.74	-7.41	4.00	165.00	150.00	-5.72	-11.17	-8.1	-7.99	4.00	-0.76	-5.31	-7.25	-4.68	4.00	1.85	-3.81
165.00	160.00	-0.75	-7.09	-18.86	-6.72	4.00	165.00	160.00	-8.75	-9.67	-8.39	-11.2	4.00	-0.11	-5.18	-8.02	-5.40	4.00	1.84	-3.65
165.00	170.00	0.67	-7.64	-23.82	-5.95	4.00	165.00	170.00	-13.16	-8.53	-9.05	-14.94	4.00	0.85	-5.05	-8.91	-5.43	4.00	2.13	-3.14
165.00	180.00	1.68	-7.82	-22.20	-5.14	4.00	165.00	180.00	-18.24	-7.4	-9.47	-24.19	4.00	1.72	-4.59	-9.24	-5.09	4.00	2.64	-2.47
165.00	190.00	2.33	-7.59	-18.08	-4.14	4.00	165.00	190.00	-10.66	-6.86	-9.49	-25.4	4.00	2.54	-4.20	-8.93	-4.11	4.00	3.34	-1.72
165.00	200.00	2.41	-7.33	-14.53	-3.59	4.00	165.00	200.00	-5.45	-6.82	-8.55	-15.65	4.00	3.07	-4.06	-7.57	-3.33	4.00	3.95	-1.16
165.00	210.00	2.24	-6.82	-12.45	-3.36	4.00	165.00	210.00	-2.53	-7.2	-7.74	-11.29	4.00	3.49	-4.00	-6.48	-2.71	4.00	4.43	-0.72
165.00	220.00	1.33	-6.56	-10.14	-3.44	4.00	165.00	220.00	-0.21	-7.93	-7.21	-7.82	4.00	3.64	-4.18	-5.42	-2.09	4.00	4.76	-0.46
165.00	230.00	-0.27	-6.53	-8.03	-3.90	4.00	165.00	230.00	1.51	-8.76	-7.51	-5.35	4.00	3.72	-4.49	-4.75	-1.55	4.00	4.97	-0.29
165.00	240.00	-2.44	-6.78	-6.34	-4.96	4.00	165.00	240.00	2.48	-9.76	-8.51	-3.64	4.00	3.69	-5.01	-4.28	-1.24	4.00	5.03	-0.24
165.00	250.00	-5.86	-7.40	-5.28	-6.77	4.00	165.00	250.00	3.1	-10.84	-10.83	-2.25	4.00	3.62	-5.78	-4.21	-0.94	4.00	4.97	-0.28
165.00	260.00	-11.46	-8.00	-4.19	-9.18	4.00	165.00	260.00	3.17	-11.43	-15.99	-1.55	4.00	3.32	-6.37	-3.91	-0.86	4.00	4.83	-0.45
165.00	270.00	-16.71	-8.30	-3.81	-13.84	4.00	165.00	270.00	2.79	-11.76	-24.81	-1.22	4.00	2.84	-6.68	-3.78	-0.99	4.00	4.58	-0.77
165.00	280.00	-10.89	-7.84	-3.86	-19.23	4.00	165.00	280.00	2.05	-12.38	-15.05	-1.38	4.00	2.27	-6.53	-3.54	-1.31	4.00	4.34	-1.12
165.00	290.00	-7.01	-6.91	-4.56	-14.98	4.00	165.00	290.00	0.76	-13.48	-9.62	-1.88	4.00	1.43	-6.05	-3.38	-1.67	4.00	4.03	-1.58
165.00	300.00	-4.81	-6.18	-6.11	-10.35	4.00	165.00	300.00	-0.76	-15.03	-7.13	-2.79	4.00	0.68	-5.65	-3.58	-2.09	4.00	3.67	-2.04
165.00	310.00	-3.66	-5.90	-8.52	-7.60	4.00	165.00	310.00	-2.58	-17.43	-5.81	-4.38	4.00	-0.08	-5.60	-3.95	-2.69	4.00	3.18	-2.60
165.00	320.00	-3.04	-5.75	-12.83	-5.82	4.00	165.00	320.00	-4.85	-20.19	-5.57	-6.55	4.00	-0.84	-5.60	-4.82	-3.16	4.00	2.61	-3.21
165.00	330.00	-2.70	-6.13	-19.01	-4.95	4.00	165.00	330.00	-7.18	-21.05	-6.01	-9.72	4.00	-1.38	-5.99	-5.80	-3.70	4.00	2.01	-3.79
165.00	340.00	-2.71	-6.71	-32.39	-4.48	4.00	165.00	340.00	-10.52	-17.27	-6.69	-15.25	4.00	-2.04	-6.34	-6.68	-4.13	4.00	1.43	-4.38
165.00	350.00	-3.14	-7.50	-22.72	-4.54	4.00	165.00	350.00	-15.31	-14.2	-7.51	-21.55	4.00	-2.88	-6.66	-7.38	-4.45	4.00	0.86	-4.98
180.00	0.00	1.80	-11.98	-29.22	-0.32	4.00	180.00	0.00	-13.26	-10.62	-5.22	-12	4.00	1.93	-8.24	-5.20	-0.03	4.00	4.03	-1.24
180.00	10.00	1.93	-10.48	-17.77	-0.06	4.00	180.00	10.00	-38.07	-12.17	-5.45	-21.93	4.00	1.93	-8.23	-5.20	-0.03	4.00	4.03	-1.24
180.00	20.00	1.80	-9.44	-13.15	-0.07	4.00	180.00	20.00	-13.29	-14.4	-5.96	-20.58	4.00	1.93	-8.24	-5.20	-0.03	4.00	4.03	-1.24
180.00	30.00	1.39	-8.75	-10.34	-0.35	4.00	180.00	30.00	-7.4	-17.78	-6.79	-11.56	4.00	1.93	-8.24	-5.20	-0.03	4.00	4.03	-1.24
180.00	40.00	0.68	-8.35	-8.43	-0.92	4.00	180.00	40.00	-4.09	-23.91	-8.01	-7.39	4.00	1.93	-8.23	-5.20	-0.04	4.00	4.03	-1.25
180.00	50.00	-0.38	-8.24	-7.09	-1.81	4.00	180.00	50.00	-1.91	-48.24	-9.74	-4.78	4.00	1.93	-8.24	-5.21	-0.04	4.00	4.03	-1.24
180.00	60.00	-1.90	-8.38	-6.16	-3.10	4.00	180.00	60.00	-0.39	-23	-12.25	-2.99	4.00	1.93	-8.23	-5.20	-0.03	4.00	4.03	-1.24
180.00	70.00	-4.08	-8.80	-5.56	-4.95	4.00	180.00	70.00	0.68	-17.34	-16.19	-1.73	4.00	1.93	-8.23	-5.20	-0.04	4.00	4.03	-1.24
180.00	80.00	-7.38	-9.53	-5.26	-7.64	4.00	180.00	80.00	1.39	-14.12	-24.28	-0.86	4.00	1.93	-8.23	-5.21	-0.03	4.00	4.03	-1.24
180.00	90.00	-13.26	-10.62	-5.22	-12.00	4.00	180.00	90.00	1.8	-11.98	-29.22	-0.32	4.00	1.93	-8.24	-5.20	-0.03	4.00	4.03	-1.24
180.00	100.00	-38.07	-12.17	-5.45	-21.93	4.00														



Frequency: 5180MHz

		Theta Polarization						Phi Polarization						Total						
Angle (θ)	Angle (ψ)	Max Gain(dB)				Nant	Angle (θ)	Angle (ψ)	Max Gain(dB)				Nant	Max Gain(dB)				Nant	Max DG(dB)	Max DG(dB)
		Ant 1(G1)	Ant 2(G2)	Ant 3(G3)	Ant 4(G4)				Ant 1(G1)	Ant 2(G2)	Ant 3(G3)	Ant 4(G4)		Ant 1(G1)	Ant 2(G2)	Ant 3(G3)	Ant 4(G4)			
		1.46	3.53	2.46	1.70				1.39	3.53	-2.06	3.31		3.82	3.82	3.00	3.90			
0.00	0.00	-13.26	3.43	-7.43	0.14	4.00	0.00	0.00	-9.68	-12.63	-8.59	-13.69	4.00	-8.10	3.54	-4.96	0.32	4.00	4.86	-0.21
0.00	10.00	-11.34	3.53	-6.31	0.32	4.00	0.00	10.00	-10.89	-31.2	-10.68	-31.35	4.00	-8.10	3.53	-4.96	0.32	4.00	4.86	-0.22
0.00	20.00	-10.00	3.37	-5.57	0.22	4.00	0.00	20.00	-12.61	-10.81	-13.81	-16.28	4.00	-8.10	3.53	-4.96	0.32	4.00	4.85	-0.22
0.00	30.00	-9.06	2.93	-5.13	-0.14	4.00	0.00	30.00	-15.11	-5.36	-19.22	-9.65	4.00	-8.10	3.53	-4.96	0.32	4.00	4.85	-0.22
0.00	40.00	-8.46	2.19	-4.96	-0.80	4.00	0.00	40.00	-19.04	-2.22	-38.83	-6.11	4.00	-8.10	3.53	-4.96	0.32	4.00	4.86	-0.22
0.00	50.00	-8.16	1.08	-5.07	-1.81	4.00	0.00	50.00	-27.03	-0.12	-21.23	-3.8	4.00	-8.10	3.53	-4.97	0.32	4.00	4.85	-0.22
0.00	60.00	-8.12	-0.50	-5.44	-3.26	4.00	0.00	60.00	-32.37	1.35	-14.78	-2.19	4.00	-8.10	3.53	-4.96	0.32	4.00	4.85	-0.22
0.00	70.00	-8.34	-2.77	-6.11	-5.32	4.00	0.00	70.00	-20.73	2.37	-11.29	-1.07	4.00	-8.10	3.53	-4.96	0.32	4.00	4.85	-0.22
0.00	80.00	-8.85	-6.24	-7.13	-8.40	4.00	0.00	80.00	-16.08	3.05	-9.01	-0.31	4.00	-8.10	3.53	-4.96	0.32	4.00	4.86	-0.22
0.00	90.00	-9.68	-12.63	-8.59	-13.69	4.00	0.00	90.00	-13.26	3.43	-7.43	0.14	4.00	-8.10	3.54	-4.96	0.32	4.00	4.86	-0.21
0.00	100.00	-10.89	-31.20	-10.68	-31.35	4.00	0.00	100.00	-11.34	3.53	-6.31	0.32	4.00	-8.10	3.53	-4.96	0.32	4.00	4.86	-0.22
0.00	110.00	-12.61	-10.81	-13.81	-16.28	4.00	0.00	110.00	-10	3.37	-5.57	0.22	4.00	-8.10	3.53	-4.96	0.32	4.00	4.85	-0.22
0.00	120.00	-15.11	-5.36	-19.22	-9.65	4.00	0.00	120.00	-9.06	2.93	-5.13	-0.14	4.00	-8.10	3.53	-4.96	0.32	4.00	4.85	-0.22
0.00	130.00	-19.04	-2.22	-38.83	-6.11	4.00	0.00	130.00	-8.46	2.19	-4.96	-0.8	4.00	-8.10	3.53	-4.96	0.32	4.00	4.86	-0.22
0.00	140.00	-27.03	-0.12	-21.23	-3.80	4.00	0.00	140.00	-8.16	1.08	-5.07	-1.81	4.00	-8.10	3.53	-4.97	0.32	4.00	4.85	-0.22
0.00	150.00	-32.37	1.35	-14.78	-2.19	4.00	0.00	150.00	-8.12	-0.5	-5.44	-3.26	4.00	-8.10	3.53	-4.96	0.32	4.00	4.85	-0.22
0.00	160.00	-20.73	2.37	-11.29	-1.07	4.00	0.00	160.00	-8.34	-2.77	-6.11	-5.32	4.00	-8.10	3.53	-4.96	0.32	4.00	4.85	-0.22
0.00	170.00	-16.08	3.05	-9.01	-0.31	4.00	0.00	170.00	-8.85	-6.24	-7.13	-8.4	4.00	-8.10	3.53	-4.96	0.32	4.00	4.86	-0.22
0.00	180.00	-13.26	3.43	-7.43	0.14	4.00	0.00	180.00	-9.68	-12.63	-8.59	-13.69	4.00	-8.10	3.54	-4.96	0.32	4.00	4.86	-0.21
0.00	190.00	-11.34	3.53	-6.31	0.32	4.00	0.00	190.00	-10.89	-31.2	-10.68	-31.35	4.00	-8.10	3.53	-4.96	0.32	4.00	4.86	-0.22
0.00	200.00	-10.00	3.37	-5.57	0.22	4.00	0.00	200.00	-12.61	-10.81	-13.81	-16.28	4.00	-8.10	3.53	-4.96	0.32	4.00	4.85	-0.22
0.00	210.00	-9.06	2.93	-5.13	-0.14	4.00	0.00	210.00	-15.11	-5.36	-19.22	-9.65	4.00	-8.10	3.53	-4.96	0.32	4.00	4.85	-0.22
0.00	220.00	-8.46	2.19	-4.96	-0.80	4.00	0.00	220.00	-19.04	-2.22	-38.83	-6.11	4.00	-8.10	3.53	-4.96	0.32	4.00	4.86	-0.22
0.00	230.00	-8.16	1.08	-5.07	-1.81	4.00	0.00	230.00	-27.03	-0.12	-21.23	-3.8	4.00	-8.10	3.53	-4.97	0.32	4.00	4.85	-0.22
0.00	240.00	-8.12	-0.50	-5.44	-3.26	4.00	0.00	240.00	-32.37	1.35	-14.78	-2.19	4.00	-8.10	3.53	-4.96	0.32	4.00	4.85	-0.22
0.00	250.00	-8.34	-2.77	-6.11	-5.32	4.00	0.00	250.00	-20.73	2.37	-11.29	-1.07	4.00	-8.10	3.53	-4.96	0.32	4.00	4.85	-0.22
0.00	260.00	-8.85	-6.24	-7.13	-8.40	4.00	0.00	260.00	-16.08	3.05	-9.01	-0.31	4.00	-8.10	3.53	-4.96	0.32	4.00	4.86	-0.22
0.00	270.00	-9.68	-12.63	-8.59	-13.69	4.00	0.00	270.00	-13.26	3.43	-7.43	0.14	4.00	-8.10	3.54	-4.96	0.32	4.00	4.86	-0.21
0.00	280.00	-10.89	-31.20	-10.68	-31.35	4.00	0.00	280.00	-11.34	3.53	-6.31	0.32	4.00	-8.10	3.53	-4.96	0.32	4.00	4.86	-0.22
0.00	290.00	-12.61	-10.81	-13.81	-16.28	4.00	0.00	290.00	-10	3.37	-5.57	0.22	4.00	-8.10	3.53	-4.96	0.32	4.00	4.85	-0.22
0.00	300.00	-15.11	-5.36	-19.22	-9.65	4.00	0.00	300.00	-9.06	2.93	-5.13	-0.14	4.00	-8.10	3.53	-4.96	0.32	4.00	4.85	-0.22
0.00	310.00	-19.04	-2.22	-38.83	-6.11	4.00	0.00	310.00	-8.46	2.19	-4.96	-0.8	4.00	-8.10	3.53	-4.96	0.32	4.00	4.86	-0.22
0.00	320.00	-27.03	-0.12	-21.23	-3.80	4.00	0.00	320.00	-8.16	1.08	-5.07	-1.81	4.00	-8.10	3.53	-4.97	0.32	4.00	4.85	-0.22
0.00	330.00	-32.37	1.35	-14.78	-2.19	4.00	0.00	330.00	-8.12	-0.5	-5.44	-3.26	4.00	-8.10	3.53	-4.96	0.32	4.00	4.85	-0.22
0.00	340.00	-20.73	2.37	-11.29	-1.07	4.00	0.00	340.00	-8.34	-2.77	-6.11	-5.32	4.00	-8.10	3.53	-4.96	0.32	4.00	4.85	-0.22
0.00	350.00	-16.08	3.05	-9.01	-0.31	4.00	0.00	350.00	-8.85	-6.24	-7.13	-8.4	4.00	-8.10	3.53	-4.96	0.32	4.00	4.86	-0.22
15.00	0.00	-6.54	2.42	-7.36	-0.88	4.00	15.00	0.00	-4.14	-13.03	-5.56	-17.02	4.00	-2.17	2.54	-3.36	-0.78	4.00	5.37	-0.34
15.00	10.00	-8.38	2.49	-6.28	-0.91	4.00	15.00	10.00	-4.15	-19.32	-4.96	-12.64	4.00	-2.76	2.52	-2.56	-0.63	4.00	5.44	-0.30
15.00	20.00	-14.69	2.24	-10.34	-1.98	4.00	15.00	20.00	-4.68	-14.61	-7.44	-8.84	4.00	-4.27	2.33	-5.64	-1.17	4.00	4.39	-1.08
15.00	30.00	-14.13	1.75	-13.64	-3.74	4.00	15.00	30.00	-4.27	-9.44	-7.48	-6.75	4.00	-3.84	2.07	-6.54	-1.98	4.00	4.02	-1.43
15.00	40.00	-13.57	1.11	-13.66	-4.58	4.00	15.00	40.00	-7.37	-5.92	-5.58	-3.97	4.00	-6.44	1.90	-4.95	-1.25	4.00	3.95	-1.48
15.00	50.00	-11.22	0.17	-9.40	-5.98	4.00	15.00	50.00	-9.2	-2.96	-7.59	-1.9	4.00	-7.08	1.89	-5.39	-0.47	4.00	4.00	-1.35
15.00	60.00	-9.12	-0.80	-7.97	-8.88	4.00	15.00	60.00	-11.63	-0.58	-8.51	-0.03	4.00	-7.19	2.32	-5.22	0.50	4.00	4.48	-0.81
15.00	70.00	-7.97	-2.16	-7.53	-13.90	4.00	15.00	70.00	-17.79	0.98	-9.65	0.94	4.00	-7.54	2.70	-5.45	1.08	4.00	4.74	-0.45
15.00	80.00	-7.01	-5.27	-7.08	-21.19	4.00	15.00	80.00	-18.88	2.26	-9.41	1.4	4.00	-6.74	2.97	-5.08	1.42	4.00	5.11	-0.12
15.00	90.00	-8.00	-7.78	-6.75	-13.54	4.00	15.00	90.00	-12.65	2.64	-10.43	1.84	4.00	-6.72	3.02	-5.20	1.96	4.00	5.30	0.10
15.00	100.00	-9.81	-13.81	-5.92	-8.38	4.00	15.00	100.00	-8.25	2.6	-11.72	1.64	4.00	-5.95	2.70	-4.91	2.05	4.00	5.35	0.05
15.00	110.00	-13.26	-12.14	-5.25	-5.18	4.00	15.00	110.00	-7.97	2.35	-13.82	1.08	4.00	-6.84	2.50	-4.68	2.00	4.00	5.18	-0.10
15.00	120.00	-20.29	-6.94	-4.83	-2.53	4.00	15.00	120.00	-5.89	2.12	-18.04	0.78	4.00	-5.74	2.63	-4.63	2.44	4.00	5.53	0.21
15.00	130.00	-23.06	-4.03	-4.43	-0.83	4.00	15.00	130.00	-4.2	1.34	-18.18	-0.29	4.00	-4.14	2.45	-4.25	2.46	4.00	5.77	0.29
15.00	140.00	-14.18	-2.16	-4.89	0.03	4.00	15.00	140.00	-3.97	0.83	-19.83	-1.43	4.00	-3.57	2.60	-4.75	2.37	4.00	5.81	0.33
15.00	150.00	-8.94	-0.37	-4.02	0.36	4.00	15.00	150.00	-3.97	-0.33	-21.81	-3.8	4.00	-2.77	2.66	-3.95	1.77	4.00	5.90	0.29
15.00	160.00	-5.31	1.34	-3.63	0.54	4.00	15.00	160.00	-6.35	-2.37	-17.59	-5.84	4.00	-2.79	2.88	-3.46	1.44	4.00	5.96	0.33
15.00	170.00	-3.49	2.04	-3.55	0.41	4.00	15.00	170.00	-6.89	-5	-13.6	-8.45	4.00	-1.86	2.82	-3.14	0.94	4.00	6.03	0.21
15.00	180.00	-3.97	2.50	-3.74	0.98	4.00	15.00	180.00	-11.29	-13.13	-9.78	-9.86	4.00	-3.23	2.62	-2.77	1.32	4.00	5.87	0.30
15.00	190.00	-4.63	2.61	-4.60	1.07	4.00	15.00	190.00	-17.55	-18.63	-7.5	-10.04	4.00	-4.41	2.64	-2.80	1.39	4.00	5.70	0.11
15.00	200.00	-4.71	1.98	-5.25	0.62	4.00	15.00	200.00	-14.26	-8.77	-6.46	-6.36	4.00	-4.25	2.33	-2.80	1.41	4.00	5.62	-0.01
15.00	210.00	-4.20	1.15	-6.64	-0.20	4.00	15.00	210.00	-16.94	-4.23	-5.81	-4.91	4.00	-3.97	2.26	-3.19	1.06	4.00	5.46	



45.00	140.00	-4.32	-2.14	-4.38	-4.85	4.00	45.00	140.00	-3.56	-1.38	-16.86	-0.85	4.00	-0.91	1.27	-4.14	0.61	4.00	5.46	-0.36
45.00	150.00	-3.55	-0.03	-3.79	-2.43	4.00	45.00	150.00	-3.39	-2.91	-20.31	-2.39	4.00	-0.46	1.77	-3.69	0.60	4.00	5.80	-0.02
45.00	160.00	-3.11	-0.50	-1.44	-1.32	4.00	45.00	160.00	-4.81	-3.81	-21.43	-4.54	4.00	-0.87	1.16	-1.40	0.37	4.00	5.90	-0.06
45.00	170.00	-1.34	1.00	0.39	-0.97	4.00	45.00	170.00	-7.02	-5.37	-13.04	-5.53	4.00	-0.30	1.90	0.58	0.33	4.00	6.69	0.71
45.00	180.00	-1.07	1.32	0.01	-1.52	4.00	45.00	180.00	-8.93	-8.71	-8.35	-11.18	4.00	-0.41	1.73	0.60	-1.07	4.00	6.30	0.34
45.00	190.00	-0.72	-1.15	-1.66	-0.48	4.00	45.00	190.00	-7.84	-6.93	-8.26	-12.17	4.00	0.05	-0.13	-0.80	-0.20	4.00	5.76	-0.26
45.00	200.00	-0.60	-2.03	-3.76	0.12	4.00	45.00	200.00	-12.07	-7.83	-8.63	-6.46	4.00	-0.30	-1.02	-2.54	0.98	4.00	5.40	-0.54
45.00	210.00	-1.70	-3.83	-4.54	-2.49	4.00	45.00	210.00	-10.83	-7.77	-9.05	-4.42	4.00	-1.20	-2.36	-3.22	-0.34	4.00	4.31	-1.64
45.00	220.00	-2.89	-8.27	-4.37	-4.24	4.00	45.00	220.00	-13.47	-4.08	-11.97	-3.97	4.00	-2.53	-2.68	-3.67	-1.09	4.00	3.58	-2.39
45.00	230.00	-4.48	-12.20	-4.49	-4.25	4.00	45.00	230.00	-22.9	-2.92	-9.89	-2.62	4.00	-4.42	-2.44	-3.39	-0.35	4.00	3.51	-2.38
45.00	240.00	-3.77	-18.20	-5.18	-4.98	4.00	45.00	240.00	-22.19	-2.78	-9.49	0.74	4.00	-3.71	-2.66	-3.81	1.77	4.00	4.24	-1.42
45.00	250.00	-2.72	-15.51	-6.15	-8.62	4.00	45.00	250.00	-16.35	-3.32	-11.53	2.68	4.00	-2.54	-3.07	-5.04	2.99	4.00	4.66	-0.76
45.00	260.00	-2.49	-11.25	-6.84	-12.80	4.00	45.00	260.00	-11.35	-3.32	-13.86	3.31	4.00	-1.96	-2.67	-6.05	3.42	4.00	4.89	-0.43
45.00	270.00	-3.62	-9.52	-7.07	-13.81	4.00	45.00	270.00	-8.98	-3.12	-16.57	3	4.00	-2.51	-2.22	-6.61	3.09	4.00	4.65	-0.69
45.00	280.00	-4.29	-7.71	-5.32	-14.05	4.00	45.00	280.00	-6.13	-3.62	-22.96	2.64	4.00	-2.10	-2.19	-5.25	2.73	4.00	4.81	-0.71
45.00	290.00	-2.35	-10.29	-3.80	-8.95	4.00	45.00	290.00	-5.77	-4.2	-36.28	1.19	4.00	-0.72	-3.24	-3.80	1.59	4.00	4.75	-1.00
45.00	300.00	-0.98	-14.60	-1.62	-7.45	4.00	45.00	300.00	-6.02	-3	-17.75	-0.85	4.00	0.46	-2.71	-1.52	0.01	4.00	5.17	-0.76
45.00	310.00	-0.63	-8.51	0.00	-5.71	4.00	45.00	310.00	-4.11	-2.58	-10.67	-4.82	4.00	0.98	-1.59	0.36	-2.23	4.00	5.50	-0.42
45.00	320.00	-1.23	-7.95	0.31	-3.48	4.00	45.00	320.00	-1.43	-3.22	-7.48	-5.35	4.00	1.68	-1.96	0.98	-1.30	4.00	6.00	0.11
45.00	330.00	-1.22	-6.95	0.12	-1.95	4.00	45.00	330.00	-0.31	-3.67	-6.37	-7.78	4.00	2.27	-2.00	1.00	-0.94	4.00	6.26	0.40
45.00	340.00	-0.88	-6.70	-0.70	-2.63	4.00	45.00	340.00	0.03	-7.79	-4.39	-23.31	4.00	2.61	-4.20	0.85	-2.59	4.00	5.60	-0.03
45.00	350.00	-2.75	-6.38	-1.90	-4.34	4.00	45.00	350.00	0.47	-14.47	-6.39	-10.32	4.00	2.16	-5.75	-0.58	-3.36	4.00	4.64	-0.91
60.00	0.00	-0.65	-7.76	1.90	-9.94	4.00	60.00	0.00	0.1	-12.72	-11.58	-18.1	4.00	2.75	-6.56	2.09	-9.32	4.00	4.75	-0.18
60.00	10.00	-1.42	-4.19	1.77	-8.02	4.00	60.00	10.00	-0.75	-12.4	-16.66	-8.88	4.00	1.94	-3.58	1.83	-5.42	4.00	5.30	-0.21
60.00	20.00	-3.06	-7.14	1.11	-5.89	4.00	60.00	20.00	-1.45	-7.21	-14.69	-6.43	4.00	0.83	-4.16	1.22	-3.14	4.00	5.03	-0.70
60.00	30.00	-3.72	-4.84	1.43	-7.92	4.00	60.00	30.00	-2.66	-9.39	-13.03	-7.8	4.00	-0.15	-3.53	1.58	-4.85	4.00	4.66	-1.00
60.00	40.00	-4.10	-4.59	0.41	-13.66	4.00	60.00	40.00	-3.66	-5.79	-17.53	-4.68	4.00	-0.86	-2.14	0.48	-4.16	4.00	4.51	-1.35
60.00	50.00	-6.77	-4.12	-0.79	-12.21	4.00	60.00	50.00	-5.36	-5.88	-20.97	-2.61	4.00	-3.00	-1.90	-0.75	-2.16	4.00	4.11	-1.88
60.00	60.00	-11.22	-3.42	-2.60	-12.13	4.00	60.00	60.00	-10.04	-5.04	-32.03	-2.97	4.00	-7.58	-1.14	-2.60	-2.47	4.00	2.89	-2.88
60.00	70.00	-15.56	-4.64	-4.81	-18.43	4.00	60.00	70.00	-15.64	-2.86	-20.47	-1.9	4.00	-12.59	-3.20	-5.20	3.20	4.00	3.29	-1.36
60.00	80.00	-17.48	-6.45	-6.00	-9.23	4.00	60.00	80.00	-21.52	-1.99	-15.85	-0.98	4.00	-16.04	-0.66	-6.10	-0.37	4.00	2.07	-2.91
60.00	90.00	-13.52	-9.69	-6.88	-5.63	4.00	60.00	90.00	-11.52	-0.93	-9.61	-0.31	4.00	-9.40	-0.39	-6.20	0.81	4.00	3.18	-2.09
60.00	100.00	-11.16	-16.35	-10.63	-4.80	4.00	60.00	100.00	-7.94	-0.63	-7.28	-1.21	4.00	-6.25	-0.52	-5.63	0.37	4.00	3.51	-2.06
60.00	110.00	-10.28	-22.71	-9.76	-4.68	4.00	60.00	110.00	-6.08	-0.35	-7.74	-2.97	4.00	-4.68	-0.32	-5.62	-0.73	4.00	3.49	-2.24
60.00	120.00	-7.84	-21.99	-6.52	-4.63	4.00	60.00	120.00	-4.37	-1.08	-10.62	-2.25	4.00	-2.76	-1.04	-5.09	-0.27	4.00	3.92	-1.93
60.00	130.00	-6.99	-9.65	-4.16	-5.29	4.00	60.00	130.00	-3.03	-1.42	-10.89	-1.33	4.00	-1.56	-0.81	-3.32	0.14	4.00	4.72	-1.21
60.00	140.00	-5.98	-4.09	-3.36	-11.31	4.00	60.00	140.00	-4.13	-4.8	-11.11	0.32	4.00	-1.95	-1.42	-2.69	0.61	4.00	4.75	-1.18
60.00	150.00	-4.93	-2.53	-3.08	-10.19	4.00	60.00	150.00	-6.11	-10.12	-18.12	0.03	4.00	-2.47	-1.83	-2.95	0.42	4.00	4.41	-1.50
60.00	160.00	-4.66	-3.33	-3.01	-1.43	4.00	60.00	160.00	-7.41	-9.67	-16.6	-4.37	4.00	-2.81	-2.42	-2.82	0.35	4.00	4.20	-1.70
60.00	170.00	-3.68	-5.20	-1.92	-0.94	4.00	60.00	170.00	-8.05	-10.43	-18.6	-7.69	4.00	-2.33	-4.06	-1.83	-0.11	4.00	4.05	-1.85
60.00	180.00	-3.48	-5.05	-1.39	-4.69	4.00	60.00	180.00	-9.83	-6.02	-16.89	-10.69	4.00	-2.57	-2.50	-1.27	-3.72	4.00	3.55	-2.43
60.00	190.00	-2.49	-4.60	-2.99	-4.57	4.00	60.00	190.00	-9.51	-7.06	-9.9	-8.45	4.00	-1.70	-2.65	-2.18	-3.08	4.00	3.63	-2.37
60.00	200.00	-3.49	-6.21	-5.57	-6.32	4.00	60.00	200.00	-12.72	-8.15	-9.87	-6.99	4.00	-3.00	-4.06	-4.20	-3.63	4.00	2.31	-3.70
60.00	210.00	-4.07	-11.19	-6.91	-15.10	4.00	60.00	210.00	-14.89	-2.54	-16.58	-10.53	4.00	-3.72	-1.98	-6.47	-9.23	4.00	1.09	-4.55
60.00	220.00	-4.01	-10.82	-7.97	-14.82	4.00	60.00	220.00	-28.1	-0.05	-11.73	-8.92	4.00	-3.99	0.30	-6.44	-7.93	4.00	2.09	-3.33
60.00	230.00	-4.32	-6.86	-8.15	-11.11	4.00	60.00	230.00	-21.06	-0.38	-10.38	-3.18	4.00	-4.23	0.50	-6.11	-2.53	4.00	3.27	-2.40
60.00	240.00	-5.59	-9.10	-10.41	-8.19	4.00	60.00	240.00	-14.14	-2.67	-9.99	-0.3	4.00	-5.02	-1.78	-7.18	0.35	4.00	3.09	-2.49
60.00	250.00	-3.04	-14.48	-12.98	-9.33	4.00	60.00	250.00	-15.89	-3.98	-16.34	0.66	4.00	-2.82	-3.61	-11.33	1.07	4.00	2.88	-2.38
60.00	260.00	-1.72	-19.57	-11.77	-12.41	4.00	60.00	260.00	-21.32	-3.66	-17.51	1.76	4.00	-1.67	-3.55	-10.74	1.92	4.00	3.60	-1.61
60.00	270.00	-1.26	-19.99	-7.79	-21.05	4.00	60.00	270.00	-17.87	-3.04	-10.22	1.9	4.00	-1.17	-2.95	-5.83	1.92	4.00	4.47	-1.12
60.00	280.00	0.14	-8.69	-4.27	-12.80	4.00	60.00	280.00	-9.94	-4.03	-8.35	2.05	4.00	0.55	-2.75	-2.84	2.19	4.00	5.58	-0.18
60.00	290.00	-1.83	-5.49	-2.52	-7.65	4.00	60.00	290.00	-7.39	-5.25	-7.72	1.42	4.00	-0.76	-2.36	-1.37	1.93	4.00	5.53	-0.33
60.00	300.00	-0.73	-7.26	-0.16	-4.92	4.00	60.00	300.00	-4.14	-4.28	-7.72	-0.33	4.00	0.90	-2.51	0.54	0.97	4.00	6.11	0.18
60.00	310.00	-0.48	-19.45	-0.44	-5.29	4.00	60.00	310.00	-4.04	-4.1	-11.74	-3.43	4.00	1.11	-3.98	-0.13	-1.25	4.00	5.15	-0.69
60.00	320.00	0.27	-15.49	-0.16	-8.31	4.00	60.00	320.00	-2.1	-7.83	-15.51	-7.21	4.00	2.26	-7.14	-0.04	-4.71	4.00	4.38	-0.96
60.00	330.00	0.04	-9.01	-0.25	-14.24	4.00	60.00	330.00	-0.14	-5.97	-9.34	-10.24	4.00	2.96	-4.22	0.25	-8.78	4.00	4.65	-0.52
60.00	340.00	-0.51	-10.16	-0.80	-13.46	4.00	60.00	340.00	-1.04	-8.23	-7.33	-14.76	4.00	2.24	-6.08	0.07	-11.05	4.00	3.75	-1.22
60.00	350.00	-1.88	-9.94	-0.02	-11.44	4.00	60.00	350.00	-0.04	-16.95	-6.96	-11.86	4.00	2.15	-9.15	0.78	-8.63	4.00	3.79	-1.11
75.00	0.00	1.36	-10.35	1.33	-9.97	4.00	75.00	0.00	-0.8	-12.31	-14.6	-13.94	4.00	3.42	-8.21	1.44	-8.51	4.00	4.68	-0.13
75.00	10.00	1.46	-8.83	1.36	-13.81	4.00	75.00	10.00	-0.56	-33.48	-19.63	-16.04	4.00	3.58	-8.82	1.39	-11.77	4.00	4.36	-0.16
75.00	20.00	0.38	-13.27	1.5	-13.15	4.00	75.00	20.00	-0.37	-9.32	-14.05	-12.03	4.00	3.03	-7.85	1.62	-9.54	4.00	4.51	-0.30
75.00	30.00	0.12	-7																	



10500	0.00	-6.73	-2.32	-0.53	-7.54	4.00	10500	0.00	-0.24	-7.42	-21.53	-9.15	4.00	0.64	-1.15	-0.50	-5.26	4.00	4.72	-1.08
10500	10.00	-5.19	-3.23	0.68	-6.52	4.00	10500	10.00	0.37	-14.87	-13.24	-14.57	4.00	1.44	-2.94	0.85	-5.89	4.00	4.87	-0.74
10500	20.00	-3.16	-7.77	1.64	-9.60	4.00	10500	20.00	1.39	-11.41	-11.16	-20.74	4.00	2.70	-6.21	1.86	-9.28	4.00	4.70	-0.28
10500	30.00	0.09	-8.76	2.46	-11.35	4.00	10500	30.00	0.16	-16.47	-6.3	-12.46	4.00	3.14	-8.08	3.00	-8.86	4.00	5.11	0.35
10500	40.00	-0.01	-5.94	0.74	-14.45	4.00	10500	40.00	0.57	-16.34	-4.25	-11.04	4.00	3.30	-5.56	1.94	-9.41	4.00	5.05	0.10
10500	50.00	-1.57	-10.83	-1.92	-10.34	4.00	10500	50.00	-1.01	-10.22	-4.82	-9.75	4.00	1.73	-7.50	-0.12	-7.02	4.00	3.73	-1.49
10500	60.00	-2.36	-11.95	-3.08	-10.19	4.00	10500	60.00	-2.11	-1.14	-5.89	-7.24	4.00	0.78	-0.79	-1.25	-5.46	4.00	4.62	-1.16
10500	70.00	-2.56	-16.69	-4.45	-15.68	4.00	10500	70.00	-4.92	1.27	-7.17	-18.37	4.00	-0.57	1.34	-2.59	-13.81	4.00	3.66	-1.50
10500	80.00	-3.08	-33.67	-3.44	-6.18	4.00	10500	80.00	-11.77	0.48	-5.91	-6.42	4.00	-2.53	0.48	-1.49	-3.29	4.00	4.43	-1.47
10500	90.00	-3.52	-22.87	-3.43	-7.65	4.00	10500	90.00	-22.08	-0.99	-5.77	-2.73	4.00	-3.46	-0.96	-1.43	-1.52	4.00	4.23	-1.75
10500	100.00	-3.98	-17.11	-7.27	-14.89	4.00	10500	100.00	-16.5	-1.01	-8.61	-6.06	4.00	-3.74	-0.90	-4.88	-5.53	4.00	2.45	-3.37
10500	110.00	-5.9	-11.48	-23.38	-30.64	4.00	10500	110.00	-11.39	-1.57	-9.34	-33.13	4.00	-4.82	-1.15	-9.17	-28.70	4.00	-1.75	-5.16
10500	120.00	-6.69	-9.53	-11.34	-10.57	4.00	10500	120.00	-6.84	-4.76	-11.74	-5.2	4.00	-3.75	-3.51	-8.53	-4.09	4.00	0.27	-4.57
10500	130.00	-6.16	-7.27	-7.14	-7.50	4.00	10500	130.00	-5.35	-10.99	-14.78	-8.12	4.00	-2.73	-5.73	-6.45	-4.79	4.00	1.21	-4.69
10500	140.00	-4.86	-6.21	-8.58	-5.73	4.00	10500	140.00	-6.61	-11.79	-14.6	-14.64	4.00	-2.64	-5.15	-7.61	-5.20	4.00	1.05	-4.80
10500	150.00	-4.27	-4.36	-9.03	-4.48	4.00	10500	150.00	-8.38	-12.87	-20.63	-6.36	4.00	-2.85	-3.79	-8.74	-2.31	4.00	1.94	-3.82
10500	160.00	-4.99	-2.26	-6.14	-11.00	4.00	10500	160.00	-5.89	-23.5	-18.43	-14.66	4.00	-2.41	-2.23	-5.89	-9.45	4.00	1.50	-4.13
10500	170.00	-3.65	-3.07	-5.71	-4.11	4.00	10500	170.00	-8.85	-13.59	-41.52	-19.65	4.00	-2.50	-2.70	-5.71	-3.99	4.00	2.39	-3.55
10500	180.00	-6.24	-6.82	-2.02	-4.33	4.00	10500	180.00	-7.06	-6.35	-13.42	-14.34	4.00	-3.62	-3.57	-1.72	-3.92	4.00	2.86	-3.11
10500	190.00	-6.43	-7.45	-2.63	-3.92	4.00	10500	190.00	-7.64	-10.66	-9.31	-18.88	4.00	-3.98	-5.75	-1.79	-3.78	4.00	2.31	-3.60
10500	200.00	-10.07	-8.35	-9.62	-2.70	4.00	10500	200.00	-6.37	-8.35	-9.95	-8.84	4.00	-4.83	-5.34	-6.77	-1.77	4.00	1.54	-4.27
10500	210.00	-7.56	-10.97	-14.04	-6.38	4.00	10500	210.00	-10.73	-9.51	-9.69	-11.43	4.00	-5.85	-7.17	-8.33	-5.20	4.00	-0.53	-6.47
10500	220.00	-8.89	-20.92	-8.75	-7.20	4.00	10500	220.00	-27.92	-15.14	-5	-7.08	4.00	-8.84	-14.12	-3.47	-4.13	4.00	-0.67	-6.00
10500	230.00	-9.40	-11.22	-7.65	-8.75	4.00	10500	230.00	-17.07	-8.34	-6.61	-4.33	4.00	-8.71	-6.54	-4.09	-2.99	4.00	0.71	-5.06
10500	240.00	-12.51	-8.09	-16.42	-11.44	4.00	10500	240.00	-21.4	-13.86	-10.78	-1.9	4.00	-11.98	-7.07	-9.73	-1.44	4.00	-0.59	-5.67
10500	250.00	-22.67	-11.88	-11.18	-12.35	4.00	10500	250.00	-15.82	-8.83	-25.48	0.01	4.00	-15.00	-7.08	-11.02	0.26	4.00	-0.30	-4.66
10500	260.00	-10.98	-30.18	-3.16	-12.10	4.00	10500	260.00	-13.31	-3.06	-16	1.07	4.00	-8.98	-3.05	-2.94	1.27	4.00	3.32	-2.09
10500	270.00	-8.43	-16.15	-0.53	-11.04	4.00	10500	270.00	-16.79	-3.26	-12.16	0.86	4.00	-7.84	-3.04	-0.24	1.13	4.00	4.14	-1.39
10500	280.00	-9.45	-19.20	-0.25	-11.62	4.00	10500	280.00	-8.89	-2.78	-12.79	0	4.00	-6.15	-2.68	-0.01	0.29	4.00	4.24	-1.48
10500	290.00	-17.58	-14.23	-1.27	-11.79	4.00	10500	290.00	-4.74	-0.63	-10.05	-1.29	4.00	-4.52	-0.44	-0.73	-0.92	4.00	4.51	-1.38
10500	300.00	-8.06	-11.15	-2.01	-9.07	4.00	10500	300.00	-8.06	-1.32	-6.74	-2.42	4.00	-5.05	-0.89	-0.75	-1.57	4.00	4.12	-1.76
10500	310.00	-5.18	-9.86	-1.36	-10.38	4.00	10500	310.00	-7.06	-1.01	-6.48	-2.75	4.00	-3.01	-0.48	-0.20	-2.06	4.00	4.66	-1.29
10500	320.00	-5.25	-4.74	-0.14	-31.76	4.00	10500	320.00	-5.5	-4.6	-10.11	-2.65	4.00	-2.36	-1.66	0.28	-2.64	4.00	4.50	-1.44
10500	330.00	-4.20	-5.14	0.06	-10.61	4.00	10500	330.00	-2.98	-19.22	-18.2	-5.42	4.00	-0.54	-4.97	0.12	-4.27	4.00	3.89	-1.86
10500	340.00	-6.46	-5.62	-1.59	-5.58	4.00	10500	340.00	-1.32	-20.53	-19.95	-8.29	4.00	-0.16	-5.48	-1.53	-3.72	4.00	3.53	-2.26
10500	350.00	-5.70	-4.70	-3.85	-5.61	4.00	10500	350.00	-1.46	-16.23	-16.29	-11.54	4.00	-0.07	-4.40	-3.61	-4.62	4.00	3.05	-2.74
12000	0.00	-3.81	-1.90	-1.64	-4.58	4.00	12000	0.00	-0.79	-10.22	-26.68	-16.2	4.00	0.97	-1.30	-1.63	-4.29	4.00	4.65	-1.18
12000	10.00	-4.75	-1.93	-2.37	-2.17	4.00	12000	10.00	-1.98	-1.1	-11.49	-13.25	4.00	-0.14	-1.42	-1.87	-1.84	4.00	4.73	-1.26
12000	20.00	-3.88	-5.25	-0.19	-6.06	4.00	12000	20.00	-2.56	-12.32	-13.26	-7.39	4.00	-0.16	-4.47	0.02	-3.66	4.00	4.18	-1.62
12000	30.00	-2.86	-11.41	-0.51	-1.29	4.00	12000	30.00	-2.67	-13.5	-8.25	-5.72	4.00	0.25	-9.32	0.17	0.05	4.00	4.60	-0.94
12000	40.00	-2.08	-9.00	-0.44	-4.08	4.00	12000	40.00	-1.38	-5.31	-5.17	-5.29	4.00	1.29	-3.76	0.82	-1.63	4.00	5.43	-0.38
12000	50.00	-1.30	-9.41	-1.38	-5.36	4.00	12000	50.00	-1.43	-3.59	-5.46	-3.6	4.00	1.65	-2.58	0.05	-1.38	4.00	5.60	-0.28
12000	60.00	-0.47	-8.11	-6.85	-6.07	4.00	12000	60.00	-4	-3.41	-4.92	-3.24	4.00	1.12	-2.14	-2.77	-1.42	4.00	4.85	-1.03
12000	70.00	-0.99	-10.04	-5.67	-11.13	4.00	12000	70.00	-9.98	-1.75	-2.74	-13.65	4.00	-0.47	-1.15	-0.95	-9.20	4.00	3.71	-1.89
12000	80.00	-2.35	-20.66	-3.73	-11.24	4.00	12000	80.00	-15.79	-1.24	-4.2	-9.15	4.00	-2.16	-1.19	-0.95	-7.06	4.00	3.50	-2.27
12000	90.00	-3.28	-14.31	-5.04	-12.22	4.00	12000	90.00	-16.37	-0.72	-10.71	-6.48	4.00	-3.07	-0.53	-4.00	-5.45	4.00	2.95	-2.88
12000	100.00	-5.63	-9.30	-11.37	-13.55	4.00	12000	100.00	-19.04	-1.68	-16.27	-12.93	4.00	-5.44	-0.99	-10.15	-10.22	4.00	2.00	-4.97
12000	110.00	-7.87	-8.71	-15.46	-13.82	4.00	12000	110.00	-26.54	-4	-12.13	-11.78	4.00	-7.81	-2.74	-10.47	-9.67	4.00	-1.09	-6.50
12000	120.00	-11.02	-10.02	-9.60	-13.84	4.00	12000	120.00	-14.88	-8.81	-12.95	-7.44	4.00	-9.52	-6.36	-7.95	-6.54	4.00	-1.48	-7.42
12000	130.00	-10.88	-11.65	-6.65	-8.30	4.00	12000	130.00	-8.15	-15.24	-11.19	-11.74	4.00	-6.29	-10.07	-5.34	-6.68	4.00	-0.90	-6.78
12000	140.00	-11.06	-9.61	-12.48	-5.55	4.00	12000	140.00	-6.69	-23.56	-14.17	-18.29	4.00	-5.34	-9.44	-10.23	-5.32	4.00	-1.27	-7.02
12000	150.00	-9.49	-8.43	-12.44	-7.46	4.00	12000	150.00	-9.72	-28.15	-15.55	-15.82	4.00	-6.59	-8.36	-10.71	-6.87	4.00	-1.97	-7.85
12000	160.00	-7.73	-7.47	-6.01	-12.06	4.00	12000	160.00	-8.12	-18.08	-19.61	-18.89	4.00	-4.91	-7.11	-5.82	-11.24	4.00	-0.94	-6.71
12000	170.00	-8.71	-5.99	-8.42	-6.47	4.00	12000	170.00	-8.34	-12.68	-33.35	-22.53	4.00	-5.51	-5.15	-8.41	-6.36	4.00	-0.25	-6.19
12000	180.00	-16.00	-6.03	-7.87	-9.82	4.00	12000	180.00	-6.47	-13.64	-18.86	-11.52	4.00	-6.01	-5.34	-7.54	-7.58	4.00	-0.54	-6.51
12000	190.00	-13.64	-3.32	-10.03	-14.64	4.00	12000	190.00	-11.07	-9.96	-14.66	-16.19	4.00	-9.16	-2.47	-8.74	-12.34	4.00	-1.37	-6.58
12000	200.00	-15.14	-6.00	-24.68	-8.70	4.00	12000	200.00	-8.81	-6.24	-9.1	-17.33	4.00	-7.90	-3.11	-8.98	-8.14	4.00	-0.68	-6.33
12000	210.00	-13.21	-5.18	-13.33	-10.16	4.00	12000	210.00	-12.31	-15.9	-11.39	-14.76	4.00	-9.73	-4.83	-9.24	-8.87	4.00	-1.91	-7.67
12000	220.00	-15.33	-8.08	-7.90	-9.47	4.00	12000	220.00	-14.34	-8.24	-9.93	-15.13	4.00	-11.80	-5.15	-5.79	-8.43	4.00	-1.40	-7.10
12000	230.00	-16.52	-11.81	-6.21	-9.22	4.00	12000	230.00	-24.33	-9.56	-16.6	-12.27	4.00	-15.85	-7.53	-5.83	-7.47	4.00	-2.41	-7.94
12000	240.00	-18.42	-19.78	-13.10	-8.38	4.00	12000	240.00	-11.94	-16.54	-14.01	-5.14	4.00	-11.06	-14.85	-10.52	-3.45	4.00		



15000	220.00	-35.88	-14.33	-27.49	-14.84	4.00	15000	220.00	-12.87	-11.24	-30.51	-6.93	4.00
15000	230.00	-36.50	-14.22	-24.20	-21.08	4.00	15000	230.00	-11.37	-18.76	-26.08	-4.93	4.00
15000	240.00	-20.90	-17.62	-22.64	-17.44	4.00	15000	240.00	-15.3	-16.75	-23.33	-4.99	4.00
15000	250.00	-16.75	-34.57	-21.15	-14.09	4.00	15000	250.00	-15.52	-12.51	-15.41	-5.08	4.00
15000	260.00	-15.16	-26.83	-16.70	-11.74	4.00	15000	260.00	-13.84	-12.86	-11.42	-6.4	4.00
15000	270.00	-18.02	-32.60	-13.66	-10.57	4.00	15000	270.00	-12.81	-9.34	-10.67	-8.11	4.00
15000	280.00	-19.74	-14.46	-12.30	-12.04	4.00	15000	280.00	-9.87	-2.69	-10.93	-10.68	4.00
15000	290.00	-17.05	-7.97	-12.76	-10.96	4.00	15000	290.00	-9.22	0.24	-12.69	-11.19	4.00
15000	300.00	-14.43	-4.63	-10.38	-11.24	4.00	15000	300.00	-12.16	0.68	-15.99	-11.38	4.00
15000	310.00	-14.90	-3.32	-7.65	-8.46	4.00	15000	310.00	-10.66	-0.08	-18.27	-9.02	4.00
15000	320.00	-13.28	-2.37	-6.56	-5.43	4.00	15000	320.00	-9.14	-0.61	-16.42	-8.86	4.00
15000	330.00	-10.20	-2.36	-8.66	-5.32	4.00	15000	330.00	-11.77	-0.36	-22.1	-16.13	4.00
15000	340.00	-6.28	-2.73	-11.57	-9.98	4.00	15000	340.00	-17.37	-1.97	-16.29	-18.88	4.00
15000	350.00	-5.18	-1.72	-13.92	-14.87	4.00	15000	350.00	-10.61	-5.47	-14.93	-18.21	4.00
16500	0.00	-8.91	-1.34	-4.93	-3.21	4.00	16500	0.00	-5.53	-3.53	-18.03	-13.47	4.00
16500	10.00	-8.06	-2.37	-5.38	-4.35	4.00	16500	10.00	-4.69	-2.42	-16.78	-11.7	4.00
16500	20.00	-7.25	-5.41	-5.89	-7.12	4.00	16500	20.00	-4.33	-0.69	-18.05	-12.04	4.00
16500	30.00	-7.11	-11.64	-6.47	-9.90	4.00	16500	30.00	-4.54	-1.02	-12.69	-12.67	4.00
16500	40.00	-6.67	-16.26	-6.57	-9.30	4.00	16500	40.00	-5.39	-2.27	-9.43	-15.75	4.00
16500	50.00	-6.40	-14.50	-6.65	-10.37	4.00	16500	50.00	-5.51	-4.77	-9.34	-16.44	4.00
16500	60.00	-7.08	-15.86	-7.07	-10.87	4.00	16500	60.00	-5.84	-8.43	-10.39	-14.07	4.00
16500	70.00	-5.37	-17.32	-6.65	-13.89	4.00	16500	70.00	-7.48	-8.93	-10.01	-11.66	4.00
16500	80.00	-6.50	-23.92	-7.66	-19.67	4.00	16500	80.00	-10.43	-6.28	-10.13	-11.32	4.00
16500	90.00	-9.24	-21.01	-9.19	-27.68	4.00	16500	90.00	-8.85	-5.1	-10.28	-9.62	4.00
16500	100.00	-11.75	-12.38	-11.33	-21.13	4.00	16500	100.00	-9.71	-6.27	-9.67	-9.49	4.00
16500	110.00	-14.80	-11.35	-14.09	-16.28	4.00	16500	110.00	-11.61	-8.95	-9.87	-12.19	4.00
16500	120.00	-24.15	-9.96	-14.80	-14.70	4.00	16500	120.00	-12.57	-14.74	-9.15	-12.06	4.00
16500	130.00	-20.60	-8.49	-12.82	-13.97	4.00	16500	130.00	-15.7	-18.45	-13.05	-10.35	4.00
16500	140.00	-17.85	-6.77	-11.21	-11.72	4.00	16500	140.00	-21.49	-14.38	-18.84	-15.23	4.00
16500	150.00	-17.40	-5.03	-10.97	-8.15	4.00	16500	150.00	-17.9	-18.1	-26.65	-17.89	4.00
16500	160.00	-15.99	-4.20	-10.07	-5.35	4.00	16500	160.00	-15.23	-20.1	-20.53	-15.63	4.00
16500	170.00	-16.49	-5.68	-9.85	-5.06	4.00	16500	170.00	-15.53	-15.12	-18.81	-12.93	4.00
16500	180.00	-13.33	-6.53	-11.36	-6.94	4.00	16500	180.00	-15.41	-17.48	-17.53	-14.34	4.00
16500	190.00	-13.53	-6.26	-15.46	-10.93	4.00	16500	190.00	-15.68	-29.79	-13.89	-33.26	4.00
16500	200.00	-15.41	-9.96	-19.17	-8.47	4.00	16500	200.00	-12.19	-16.81	-13.75	-18.76	4.00
16500	210.00	-18.52	-18.14	-28.93	-7.77	4.00	16500	210.00	-12.52	-15.33	-13.06	-10.63	4.00
16500	220.00	-25.38	-21.95	-19.94	-6.45	4.00	16500	220.00	-12.49	-17.22	-11.9	-6.71	4.00
16500	230.00	-26.97	-14.03	-16.32	-6.58	4.00	16500	230.00	-11.82	-14.42	-11.81	-6.46	4.00
16500	240.00	-21.72	-15.12	-14.69	-7.44	4.00	16500	240.00	-10.06	-8.98	-10.47	-4.02	4.00
16500	250.00	-13.79	-18.93	-12.68	-11.35	4.00	16500	250.00	-11.05	-8.04	-9.29	-3.54	4.00
16500	260.00	-9.93	-15.56	-11.50	-14.99	4.00	16500	260.00	-12.54	-8.68	-10.39	-4.29	4.00
16500	270.00	-8.74	-12.95	-10.27	-12.72	4.00	16500	270.00	-11.31	-12.51	-9.86	-6.69	4.00
16500	280.00	-11.15	-11.17	-8.88	-9.53	4.00	16500	280.00	-9.83	-14.84	-10.69	-11.21	4.00
16500	290.00	-11.86	-11.45	-9.43	-9.61	4.00	16500	290.00	-8.95	-11.8	-11.13	-24.08	4.00
16500	300.00	-13.46	-11.70	-9.36	-8.28	4.00	16500	300.00	-7.98	-7.9	-13.07	-13.15	4.00
16500	310.00	-16.30	-9.26	-9.45	-7.27	4.00	16500	310.00	-7.66	-5.88	-14.08	-11	4.00
16500	320.00	-15.25	-5.31	-8.14	-6.89	4.00	16500	320.00	-8.45	-5.78	-14.02	-14.28	4.00
16500	330.00	-12.76	-2.88	-8.37	-6.50	4.00	16500	330.00	-8.79	-5.75	-20.17	-15.14	4.00
16500	340.00	-10.21	-0.95	-8.59	-5.45	4.00	16500	340.00	-9.64	-7.05	-22.13	-15.67	4.00
16500	350.00	-9.89	-0.42	-8.09	-4.37	4.00	16500	350.00	-7.62	-6.11	-31.11	-15.07	4.00
18000	0.00	-7.23	-11.52	-19.13	-8.14	4.00	18000	0.00	-12.34	-12.66	-17.86	-11.13	4.00
18000	10.00	-6.55	-10.40	-17.65	-7.25	4.00	18000	10.00	-15.79	-14.74	-19.42	-13.75	4.00
18000	20.00	-6.17	-9.65	-16.61	-6.68	4.00	18000	20.00	-22.12	-17.85	-21.67	-17.93	4.00
18000	30.00	-6.07	-9.21	-15.93	-6.41	4.00	18000	30.00	-41.74	-23.23	-25.1	-27.02	4.00
18000	40.00	-6.22	-9.04	-15.55	-6.40	4.00	18000	40.00	-20.5	-42.22	-31.38	-28.14	4.00
18000	50.00	-6.66	-9.14	-15.44	-6.66	4.00	18000	50.00	-15	-25.4	-52.29	-18.29	4.00
18000	60.00	-7.40	-9.51	-15.59	-7.20	4.00	18000	60.00	-11.84	-18.9	-29.96	-13.95	4.00
18000	70.00	-8.50	-10.18	-16.02	-8.07	4.00	18000	70.00	-9.74	-15.4	-24.42	-11.27	4.00
18000	80.00	-10.08	-11.20	-16.76	-9.33	4.00	18000	80.00	-8.26	-13.11	-21.24	-9.43	4.00
18000	90.00	-12.34	-12.66	-17.86	-11.13	4.00	18000	90.00	-7.23	-11.52	-19.13	-8.14	4.00
18000	100.00	-15.79	-14.74	-19.42	-13.75	4.00	18000	100.00	-6.55	-10.4	-17.65	-7.25	4.00
18000	110.00	-22.12	-17.85	-21.67	-17.93	4.00	18000	110.00	-6.17	-9.65	-16.61	-6.68	4.00
18000	120.00	-41.74	-23.23	-25.10	-27.02	4.00	18000	120.00	-6.07	-9.21	-15.93	-6.41	4.00
18000	130.00	-20.50	-42.22	-31.38	-28.14	4.00	18000	130.00	-6.22	-9.04	-15.55	-6.4	4.00
18000	140.00	-15.00	-25.40	-52.29	-18.29	4.00	18000	140.00	-6.66	-9.14	-15.44	-6.66	4.00
18000	150.00	-11.84	-18.90	-29.96	-13.95	4.00	18000	150.00	-7.4	-9.51	-15.59	-7.2	4.00
18000	160.00	-9.74	-15.40	-24.42	-11.27	4.00	18000	160.00	-8.5	-10.18	-16.02	-8.07	4.00
18000	170.00	-8.26	-13.11	-21.24	-9.43	4.00	18000	170.00	-10.08	-11.2	-16.76	-9.33	4.00
18000	180.00	-7.23	-11.52	-19.13	-8.14	4.00	18000	180.00	-12.34	-12.66	-17.86	-11.13	4.00
18000	190.00	-6.55	-10.40	-17.65	-7.25	4.00	18000	190.00	-15.79	-14.74	-19.42	-13.75	4.00
18000	200.00	-6.17	-9.65	-16.61	-6.68	4.00	18000	200.00	-22.12	-17.85	-21.67	-17.93	4.00
18000	210.00	-6.07	-9.21	-15.93	-6.41	4.00	18000	210.00	-41.74	-23.23	-25.1	-27.02	4.00
18000	220.00	-6.22	-9.04	-15.55	-6.40	4.00	18000	220.00	-20.5	-42.22	-31.38	-28.14	4.00
18000	230.00	-6.66	-9.14	-15.44	-6.66	4.00	18000	230.00	-15	-25.4	-52.29	-18.29	4.00
18000	240.00	-7.40	-9.51	-15.59	-7.20	4.00	18000	240.00	-11.84	-18.9	-29.96	-13.95	4.00
18000	250.00	-8.50	-10.18	-16.02	-8.07	4.00	18000	250.00	-9.74	-15.4	-24.42	-11.27	4.00
18000	260.00	-10.08	-11.20	-16.76	-9.33	4.00	18000	260.00	-8.26	-13.11	-21.24	-9.43	4.00
18000	270.00	-12.34	-12.66	-17.86	-11.13	4.00	18000	270.00	-7.23	-11.52	-19.13	-8.14	4.00
18000	280.00	-15.79	-14.74	-19.42	-13.75	4.00	18000	280.00	-6.55	-10.4	-17.65	-7.25	4.00
18000	290.00	-22.12	-17.85	-21.67	-17.93	4.00	18000	290.00	-6.17	-9.65	-16.61	-6.68	4.00
18000	300.00	-41.74	-23.23	-25.10	-27.02	4.00	18000	300.00	-6.07	-9.21	-15.93	-6.41	4.00
18000	310.00	-20.50	-42.22	-31.38	-28.14	4.00	18000	310.00	-6.22	-9.04	-15.55	-6.4	4.00
18000	320.00	-15.00	-25.40	-52.29	-18.29	4.00	18000	320.00	-6.66	-9.14	-15.44	-6.66	4.00
18000	330.00	-11.84	-18.90	-29.96	-13.95	4.00	18000	330.00	-7.4	-9.51	-15.59	-7.2	4.00
18000	340.00	-9.74	-15.40	-24.42	-11.27	4.00	18000	340.00	-8.5	-10.18	-16.02	-8.07	4.00
18000	350.00	-8.26	-13.11	-21.24	-9.43	4.00	18000	350.00	-10.08	-11.2	-16.76	-9.33	4.00

-12.85	-9.51	-25.73	-6.28	4.00	-5.20	-9.98
-11.36	-12.91	-22.03	-4.83	4.00	-4.81	-9.40
-14.24						



Frequency: 5220MHz

Angle (θ)		Theta Polarization				Nant	Angle (θ)	Angle (ψ)	Phi Polarization				Nant	Total				Nant	Max DG(dB)	
		Max Gain(dBi)							Max Gain(dBi)					Max Gain(dBi)					7.05	1.63
		Ant 1(G1)	Ant 2(G2)	Ant 3(G3)	Ant 4(G4)				Ant 1(G1)	Ant 2(G2)	Ant 3(G3)	Ant 4(G4)		Ant 1(G1)	Ant 2(G2)	Ant 3(G3)	Ant 4(G4)			
		1.09	3.73	2.09	2.36				0.78	3.73	-1.75	2.93		3.95	3.73	2.51	4.41		154T	454T
Ant 1(G1)	Ant 2(G2)	Ant 3(G3)	Ant 4(G4)	Ant 1(G1)	Ant 2(G2)	Ant 3(G3)	Ant 4(G4)	Ant 1(G1)	Ant 2(G2)	Ant 3(G3)	Ant 4(G4)									
0.00	0.00	-13.26	3.61	-7.04	0.38	4.00	0.00	0.00	-7.96	-11.98	-12.91	-16.72	4.00	-6.84	3.73	-6.04	0.46	4.00	4.97	-0.08
0.00	10.00	-11.34	3.73	-6.43	0.46	4.00	0.00	10.00	-8.46	-36.27	-16.74	-28.46	4.00	-6.66	3.73	-6.04	0.47	4.00	5.00	-0.07
0.00	20.00	-10.00	3.58	-6.11	0.27	4.00	0.00	20.00	-9.28	-11	-24.36	-13.14	4.00	-6.61	3.73	-6.05	0.46	4.00	5.00	-0.07
0.00	30.00	-9.06	3.15	-6.05	-0.20	4.00	0.00	30.00	-10.48	-5.36	-31.58	-8.05	4.00	-6.70	3.72	-6.04	0.46	4.00	4.99	-0.08
0.00	40.00	-8.46	2.43	-6.27	-0.97	4.00	0.00	40.00	-12.19	-2.15	-18.98	-5.04	4.00	-6.93	3.73	-6.04	0.47	4.00	4.96	-0.08
0.00	50.00	-8.16	1.34	-6.76	-2.12	4.00	0.00	50.00	-14.66	-0.01	-14.19	-3.02	4.00	-7.28	3.73	-6.04	0.46	4.00	4.92	-0.10
0.00	60.00	-8.12	-0.22	-7.57	-3.76	4.00	0.00	60.00	-18.53	1.48	-11.31	-1.6	4.00	-7.74	3.72	-6.04	0.46	4.00	4.86	-0.13
0.00	70.00	-8.34	-2.44	-8.76	-6.12	4.00	0.00	70.00	-26.33	2.53	-9.36	-0.61	4.00	-8.27	3.73	-6.04	0.47	4.00	4.80	-0.14
0.00	80.00	-8.85	-5.83	-10.46	-9.76	4.00	0.00	80.00	-32.64	3.22	-7.99	0.03	4.00	-8.83	3.73	-6.04	0.46	4.00	4.74	-0.16
0.00	90.00	-9.68	-11.98	-12.91	-16.72	4.00	0.00	90.00	-20.52	3.61	-7.04	0.38	4.00	-9.34	3.73	-6.04	0.46	4.00	4.69	-0.18
0.00	100.00	-10.89	-36.27	-16.74	-28.46	4.00	0.00	100.00	-15.8	3.73	-6.43	0.46	4.00	-9.67	3.73	-6.04	0.47	4.00	4.66	-0.19
0.00	110.00	-12.61	-11.00	-24.36	-13.14	4.00	0.00	110.00	-12.94	3.58	-6.11	0.27	4.00	-9.76	3.73	-6.05	0.46	4.00	4.65	-0.19
0.00	120.00	-15.11	-5.36	-31.58	-8.05	4.00	0.00	120.00	-11.01	3.15	-6.05	-0.2	4.00	-9.58	3.72	-6.04	0.46	4.00	4.66	-0.19
0.00	130.00	-19.04	-2.15	-18.98	-5.04	4.00	0.00	130.00	-9.65	2.43	-6.27	-0.97	4.00	-9.18	3.73	-6.04	0.47	4.00	4.70	-0.17
0.00	140.00	-27.03	-0.01	-14.19	-3.02	4.00	0.00	140.00	-8.71	1.34	-6.76	-2.12	4.00	-8.65	3.73	-6.04	0.46	4.00	4.76	-0.16
0.00	150.00	-32.37	1.48	-11.31	-1.61	4.00	0.00	150.00	-8.1	-0.22	-7.57	-3.76	4.00	-8.08	3.72	-6.04	0.46	4.00	4.82	-0.14
0.00	160.00	-20.73	2.53	-9.36	-0.61	4.00	0.00	160.00	-7.79	-2.44	-8.76	-6.12	4.00	-7.57	3.73	-6.04	0.47	4.00	4.88	-0.11
0.00	170.00	-16.08	3.22	-7.99	0.03	4.00	0.00	170.00	-7.74	-5.83	-10.46	-9.76	4.00	-7.15	3.73	-6.04	0.46	4.00	4.93	-0.09
0.00	180.00	-13.26	3.61	-7.04	0.38	4.00	0.00	180.00	-7.96	-11.98	-12.91	-16.72	4.00	-6.84	3.73	-6.04	0.46	4.00	4.97	-0.08
0.00	190.00	-11.34	3.73	-6.43	0.46	4.00	0.00	190.00	-8.46	-36.27	-16.74	-28.46	4.00	-6.66	3.73	-6.04	0.47	4.00	5.00	-0.07
0.00	200.00	-10.00	3.58	-6.11	0.27	4.00	0.00	200.00	-9.28	-11	-24.36	-13.14	4.00	-6.61	3.73	-6.05	0.46	4.00	5.00	-0.07
0.00	210.00	-9.06	3.15	-6.05	-0.20	4.00	0.00	210.00	-10.48	-5.36	-31.58	-8.05	4.00	-6.70	3.72	-6.04	0.46	4.00	4.99	-0.08
0.00	220.00	-8.46	2.43	-6.27	-0.97	4.00	0.00	220.00	-12.19	-2.15	-18.98	-5.04	4.00	-6.93	3.73	-6.04	0.47	4.00	4.96	-0.08
0.00	230.00	-8.16	1.34	-6.76	-2.12	4.00	0.00	230.00	-14.66	-0.01	-14.19	-3.02	4.00	-7.28	3.73	-6.04	0.46	4.00	4.92	-0.10
0.00	240.00	-8.12	-0.22	-7.57	-3.76	4.00	0.00	240.00	-18.53	1.48	-11.31	-1.6	4.00	-7.74	3.72	-6.04	0.46	4.00	4.86	-0.13
0.00	250.00	-8.34	-2.44	-8.76	-6.12	4.00	0.00	250.00	-26.33	2.53	-9.36	-0.61	4.00	-8.27	3.73	-6.04	0.47	4.00	4.80	-0.14
0.00	260.00	-8.85	-5.83	-10.46	-9.76	4.00	0.00	260.00	-32.64	3.22	-7.99	0.03	4.00	-8.83	3.73	-6.04	0.46	4.00	4.74	-0.16
0.00	270.00	-9.68	-11.98	-12.91	-16.72	4.00	0.00	270.00	-20.52	3.61	-7.04	0.38	4.00	-9.34	3.73	-6.04	0.46	4.00	4.69	-0.18
0.00	280.00	-10.89	-36.27	-16.74	-28.46	4.00	0.00	280.00	-15.8	3.73	-6.43	0.46	4.00	-9.67	3.73	-6.04	0.47	4.00	4.66	-0.19
0.00	290.00	-12.61	-11.00	-24.36	-13.14	4.00	0.00	290.00	-12.94	3.58	-6.11	0.27	4.00	-9.76	3.73	-6.05	0.46	4.00	4.65	-0.19
0.00	300.00	-15.11	-5.36	-31.58	-8.05	4.00	0.00	300.00	-11.01	3.15	-6.05	-0.2	4.00	-9.58	3.72	-6.04	0.46	4.00	4.66	-0.19
0.00	310.00	-19.04	-2.15	-18.98	-5.04	4.00	0.00	310.00	-9.65	2.43	-6.27	-0.97	4.00	-9.18	3.73	-6.04	0.47	4.00	4.70	-0.17
0.00	320.00	-27.03	-0.01	-14.19	-3.02	4.00	0.00	320.00	-8.71	1.34	-6.76	-2.12	4.00	-8.65	3.73	-6.04	0.46	4.00	4.76	-0.16
0.00	330.00	-32.37	1.48	-11.31	-1.61	4.00	0.00	330.00	-8.1	-0.22	-7.57	-3.76	4.00	-8.08	3.72	-6.04	0.46	4.00	4.82	-0.14
0.00	340.00	-20.73	2.53	-9.36	-0.61	4.00	0.00	340.00	-7.79	-2.44	-8.76	-6.12	4.00	-7.57	3.73	-6.04	0.47	4.00	4.88	-0.11
0.00	350.00	-16.08	3.22	-7.99	0.03	4.00	0.00	350.00	-7.74	-5.83	-10.46	-9.76	4.00	-7.15	3.73	-6.04	0.46	4.00	4.93	-0.09
15.00	0.00	-6.54	2.20	-5.99	-0.17	4.00	15.00	0.00	-4.23	-13.76	-6.44	-20.24	4.00	-2.22	2.31	-3.20	-0.13	4.00	5.47	-0.28
15.00	10.00	-8.38	2.25	-5.63	-0.62	4.00	15.00	10.00	-4.25	-18.89	-6.63	-12.6	4.00	-2.83	2.28	-3.09	-0.35	4.00	5.30	-0.43
15.00	20.00	-14.69	2.10	-9.05	-1.29	4.00	15.00	20.00	-5.14	-15.12	-10.5	-8.29	4.00	-4.68	2.18	-6.70	-0.50	4.00	4.28	-1.11
15.00	30.00	-14.13	2.02	-10.33	-2.42	4.00	15.00	30.00	-4.14	-9.14	-10.82	-6.23	4.00	-3.73	2.34	-7.56	-0.91	4.00	4.30	-1.07
15.00	40.00	-13.57	1.80	-10.22	-4.66	4.00	15.00	40.00	-7.16	-5.05	-8.27	-3.94	4.00	-6.27	2.62	-6.13	-1.27	4.00	4.07	-1.17
15.00	50.00	-11.22	1.19	-7.57	-6.45	4.00	15.00	50.00	-9.39	-2.35	-9.07	-2.37	4.00	-7.20	2.78	-5.25	-0.94	4.00	4.24	-0.98
15.00	60.00	-9.12	-0.16	-7.73	-9.48	4.00	15.00	60.00	-12.98	-0.5	-9.68	-0.64	4.00	-7.62	2.68	-5.59	-0.11	4.00	4.33	-0.86
15.00	70.00	-7.97	-1.73	-6.84	-13.18	4.00	15.00	70.00	-18.21	1.36	-9.14	0.24	4.00	-7.58	3.09	-4.83	0.43	4.00	4.79	-0.40
15.00	80.00	-7.01	-4.76	-7.15	-19.60	4.00	15.00	80.00	-23.12	2.36	-9.9	1.32	4.00	-6.90	3.13	-5.30	1.35	4.00	5.10	-0.09
15.00	90.00	-8.00	-9.24	-6.49	-12.14	4.00	15.00	90.00	-14.45	2.76	-11.58	1.32	4.00	-7.11	3.03	-5.32	1.51	4.00	5.08	-0.10
15.00	100.00	-9.81	-12.96	-5.58	-7.45	4.00	15.00	100.00	-11.22	2.61	-11.75	1.19	4.00	-7.45	2.73	-4.64	1.75	4.00	5.11	-0.12
15.00	110.00	-13.26	-10.66	-5.27	-3.57	4.00	15.00	110.00	-8.53	2.58	-14.79	1.02	4.00	-7.27	2.78	-4.81	2.32	4.00	5.32	0.13
15.00	120.00	-20.29	-6.11	-5.14	-1.40	4.00	15.00	120.00	-6.62	1.87	-16.85	0.17	4.00	-6.44	2.51	-4.86	2.47	4.00	5.37	0.11
15.00	130.00	-23.06	-2.85	-5.24	-0.14	4.00	15.00	130.00	-6.81	0.94	-16.51	-1.2	4.00	-6.71	2.46	-4.93	2.37	4.00	5.27	0.02
15.00	140.00	-14.18	-1.58	-5.97	0.65	4.00	15.00	140.00	-5.96	0.1	-17.98	-2.15	4.00	-5.35	2.35	-5.70	2.48	4.00	5.34	0.05
15.00	150.00	-8.94	-0.48	-5.65	0.94	4.00	15.00	150.00	-5.7	-1.35	-17.31	-4.5	4.00	-4.01	2.12	-5.36	2.03	4.00	5.36	-0.10
15.00	160.00	-5.31	0.56	-5.45	0.95	4.00	15.00	160.00	-6.78	-2.75	-15.67	-6.43	4.00	-2.97	2.22	-5.06	1.68	4.00	5.52	-0.05
15.00	170.00	-3.49	1.77	-5.23	1.30	4.00	15.00	170.00	-6.64	-5.5	-15.6	-9.07	4.00	-1.78	2.52	-4.85	1.68	4.00	5.88	0.26
15.00	180.00	-3.97	2.42	-5.12	1.58	4.00	15.00	180.00	-9.61	-11.22	-11.71	-9.83	4.00	-2.92	2.60	-4.26	1.88	4.00	5.84	0.26
15.00	190.00	-4.63	2.47	-5.56	1.59	4.00	15.00	190.00	-14.45	-25.08	-10.39	-8.09	4.00	-4.20	2.48	-4.33	2.03	4.00	5.62	0.12
15.00	200.00	-4.71	2.10	-6.25	0.93	4.00	15.00	200.00	-12.24	-9.64	-8.98	-6.22	4.00	-4.00	2.38	-4.39	1.70	4.00	5.49	-0.03
15.00	210.00	-4.20	1.56	-6.96	-0.06	4.00	15.00	210.00	-14.24	-5.29	-7.04	-5.12	4.00	-3.79	2.38	-3.99	1.12	4.00	5.41	-0.18
15.00																				



45.00	140.00	-4.23	-2.04	-1.92	-2.00	4.00	45.00	140.00	-3.15	-1.7	-17.21	-1.25	4.00	-0.65	1.14	-1.79	1.40	4.00	6.14	0.22
45.00	150.00	-3.37	0.21	-0.77	-1.20	4.00	45.00	150.00	-3.54	-2.9	-23.36	-2.86	4.00	-0.44	1.94	-0.75	1.06	4.00	6.54	0.59
45.00	160.00	-2.18	-0.39	0.60	-1.53	4.00	45.00	160.00	-2.74	-4.03	-24.24	-4.98	4.00	0.56	1.17	0.61	0.09	4.00	6.64	0.63
45.00	170.00	-0.20	0.56	1.30	-1.44	4.00	45.00	170.00	-5.06	-6.26	-13.62	-6.63	4.00	1.03	1.38	1.44	-0.29	4.00	6.94	0.94
45.00	180.00	-0.16	1.41	0.97	-2.29	4.00	45.00	180.00	-7.25	-8.6	-11.29	-15.17	4.00	0.62	1.82	1.22	-2.07	4.00	6.54	0.62
45.00	190.00	0.45	-1.11	-0.94	-0.14	4.00	45.00	190.00	-6.5	-6.1	-8.73	-12.8	4.00	1.25	0.09	-0.27	0.09	4.00	6.33	0.33
45.00	200.00	0.51	-2.63	-2.98	-0.09	4.00	45.00	200.00	-11.06	-8.16	-7.31	-6.3	4.00	0.80	-1.56	-1.62	0.84	4.00	5.72	-0.22
45.00	210.00	-0.71	-3.60	-3.42	-2.15	4.00	45.00	210.00	-9.31	-7.74	-9.77	-5.34	4.00	-0.15	-2.18	-2.51	-0.45	4.00	4.76	-1.20
45.00	220.00	-1.92	-6.49	-3.57	-3.23	4.00	45.00	220.00	-11.16	-4.16	-12.95	-4.95	4.00	-1.43	-2.16	-3.10	-1.00	4.00	4.14	-1.85
45.00	230.00	-2.78	-11.08	-3.53	-3.69	4.00	45.00	230.00	-15.45	-2.73	-13.31	-2.34	4.00	-2.55	-2.14	-3.10	0.05	4.00	4.17	-1.76
45.00	240.00	-2.39	-16.20	-3.56	-4.90	4.00	45.00	240.00	-18.66	-2.16	-14.11	1.45	4.00	-2.29	-1.99	-3.19	2.36	4.00	5.03	-0.68
45.00	250.00	-2.12	-15.25	-3.82	-8.02	4.00	45.00	250.00	-17.47	-2.56	-15.67	2.91	4.00	-2.00	-2.33	-3.55	3.25	4.00	5.29	-0.26
45.00	260.00	-2.83	-13.10	-4.55	-11.65	4.00	45.00	260.00	-10.49	-3.51	-16.98	2.93	4.00	-2.14	-3.06	-4.31	3.08	4.00	4.91	-0.57
45.00	270.00	-4.11	-10.02	-4.92	-15.56	4.00	45.00	270.00	-8.82	-3.65	-24.2	2.53	4.00	-2.85	-2.75	-4.87	2.60	4.00	4.53	-0.98
45.00	280.00	-4.81	-8.85	-4.17	-12.71	4.00	45.00	280.00	-6.86	-4.37	-25.77	1.89	4.00	-2.70	-3.05	-4.14	2.04	4.00	4.41	-1.23
45.00	290.00	-2.68	-10.56	-2.71	-9.38	4.00	45.00	290.00	-6.4	-4.23	-16.48	0.78	4.00	-1.14	-3.32	-2.53	1.18	4.00	4.74	-1.10
45.00	300.00	-1.68	-12.32	-1.15	-7.96	4.00	45.00	300.00	-5.22	-2.12	-12.93	-1.24	4.00	-0.09	-1.72	-0.87	-0.40	4.00	5.27	-0.73
45.00	310.00	-1.45	-6.81	0.20	-7.10	4.00	45.00	310.00	-4.43	-2.44	-9.24	-4.51	4.00	0.32	-1.09	0.67	-2.60	4.00	5.44	-0.49
45.00	320.00	-1.54	-6.45	0.45	-4.43	4.00	45.00	320.00	-2.13	-3.37	-6.73	-7.58	4.00	1.19	-1.63	1.21	-2.72	4.00	5.70	-0.16
45.00	330.00	-0.95	-5.64	-0.11	-2.37	4.00	45.00	330.00	-1.24	-3.41	-5.35	-7.41	4.00	1.92	-1.37	1.03	-1.19	4.00	6.23	0.33
45.00	340.00	-0.48	-6.22	-1.06	-1.98	4.00	45.00	340.00	-1.3	-8.01	-5.54	-16.13	4.00	2.14	-4.01	0.26	-1.82	4.00	5.46	-0.28
45.00	350.00	-1.97	-5.30	-2.38	-3.53	4.00	45.00	350.00	-0.38	-12.04	-6.7	-15.31	4.00	1.91	-4.47	-1.01	-3.25	4.00	4.66	-1.00
60.00	0.00	-1.00	-7.76	2.00	-9.97	4.00	60.00	0.00	-0.54	-13.47	-12.78	-16.59	4.00	2.25	-6.73	2.14	-9.11	4.00	4.57	-0.40
60.00	10.00	-1.76	-4.31	1.71	-8.24	4.00	60.00	10.00	-1.16	-12.44	-14.56	-8.64	4.00	1.56	-3.69	1.81	-5.43	4.00	5.15	-0.38
60.00	20.00	-3.44	-6.28	0.91	-5.50	4.00	60.00	20.00	-1.8	-8.11	-13.35	-5.11	4.00	0.47	-4.09	1.07	-2.29	4.00	5.05	-0.74
60.00	30.00	-3.59	-4.31	0.94	-6.56	4.00	60.00	30.00	-3.08	-8.29	-11.57	-8.14	4.00	-0.32	-2.85	1.18	-4.27	4.00	4.71	-1.06
60.00	40.00	-4.32	-4.81	0.59	-11.01	4.00	60.00	40.00	-3.56	-5.66	-23.04	-5.05	4.00	-0.91	-2.20	0.61	-4.07	4.00	4.54	-1.32
60.00	50.00	-7.10	-4.38	-1.64	-12.91	4.00	60.00	50.00	-5.74	-4.78	-23.67	-2.84	4.00	-3.36	-1.57	-1.61	-2.43	4.00	3.81	-2.18
60.00	60.00	-13.17	-3.93	-3.66	-11.94	4.00	60.00	60.00	-9.75	-4.77	-29.64	-3.54	4.00	-8.12	-1.32	-3.65	-2.95	4.00	2.35	-3.40
60.00	70.00	-13.40	-5.16	-6.49	-15.12	4.00	60.00	70.00	-19.47	-3.54	-32.23	-2.15	4.00	-12.44	-3.20	-5.20	3.20	4.00	3.30	-1.36
60.00	80.00	-14.50	-7.25	-7.90	-8.92	4.00	60.00	80.00	-21.21	-2.15	-16.65	-0.87	4.00	-13.66	-0.98	-6.10	-0.24	4.00	2.18	-2.94
60.00	90.00	-11.74	-10.36	-8.91	-5.60	4.00	60.00	90.00	-10.83	-1.25	-10.34	-0.92	4.00	-8.25	-0.75	-6.20	0.35	4.00	3.03	-2.37
60.00	100.00	-9.94	-19.69	-7.88	-5.17	4.00	60.00	100.00	-6.57	0.01	-7.87	-2.44	4.00	-4.93	0.06	-4.86	-0.58	4.00	3.75	-1.98
60.00	110.00	-8.67	-24.20	-6.49	-6.54	4.00	60.00	110.00	-5.17	0.5	-8.58	-2.57	4.00	-3.57	0.51	-4.40	-1.11	4.00	4.10	-1.70
60.00	120.00	-6.64	-13.58	-4.16	-5.81	4.00	60.00	120.00	-3.92	-0.37	-11.51	-1.4	4.00	-2.06	-0.17	-3.43	-0.06	4.00	4.70	-1.21
60.00	130.00	-5.89	-9.46	-2.59	-6.35	4.00	60.00	130.00	-2.49	-1.06	-11.05	-0.78	4.00	-0.86	-0.47	-2.01	0.28	4.00	5.30	-0.69
60.00	140.00	-4.55	-4.18	-1.66	-16.22	4.00	60.00	140.00	-2.32	-3.6	-9.86	0.71	4.00	-0.28	-0.87	-1.05	0.80	4.00	5.70	-0.29
60.00	150.00	-3.74	-2.54	-0.92	-6.91	4.00	60.00	150.00	-3.94	-10.43	-14.8	-0.22	4.00	-0.83	-1.89	-0.75	0.62	4.00	5.36	-0.62
60.00	160.00	-3.51	-3.44	-0.14	-1.25	4.00	60.00	160.00	-4.77	-10.89	-24.71	-5.4	4.00	-1.08	-2.72	-0.12	0.16	4.00	5.15	-0.80
60.00	170.00	-2.33	-4.99	0.35	-1.02	4.00	60.00	170.00	-5.69	-12.03	-22.15	-7.99	4.00	-0.68	-4.21	0.37	-0.22	4.00	5.01	-0.87
60.00	180.00	-1.87	-4.53	0.05	-5.06	4.00	60.00	180.00	-6.56	-5.49	-17.37	-12.8	4.00	-0.60	-1.97	0.13	-4.38	4.00	4.48	-1.40
60.00	190.00	-1.24	-3.45	-1.89	-3.93	4.00	60.00	190.00	-7.12	-6.36	-11.26	-8.56	4.00	-0.24	-1.66	-1.41	-2.64	4.00	4.57	-1.40
60.00	200.00	-2.09	-5.67	-4.88	-6.61	4.00	60.00	200.00	-9.43	-9.35	-10.53	-7.87	4.00	-1.35	-4.12	-3.83	-4.18	4.00	2.73	-3.20
60.00	210.00	-3.59	-12.37	-5.59	-16.40	4.00	60.00	210.00	-14.82	-3.82	-14.51	-11.71	4.00	-3.27	-3.25	-5.07	-10.44	4.00	0.95	-4.73
60.00	220.00	-3.31	-11.43	-5.27	-12.06	4.00	60.00	220.00	-25.27	-1.09	-16.95	-7.81	4.00	-3.28	-0.71	-4.98	-6.42	4.00	2.44	-3.31
60.00	230.00	-2.54	-7.81	-5.02	-9.35	4.00	60.00	230.00	-25.99	-1.15	-13.81	-2.44	4.00	-2.52	-0.30	-4.48	-1.63	4.00	3.92	-1.98
60.00	240.00	-4.30	-9.01	-7.35	-8.54	4.00	60.00	240.00	-13.95	-3.2	-14.26	-0.25	4.00	-3.85	-2.19	-6.54	0.35	4.00	3.32	-2.36
60.00	250.00	-2.04	-13.76	-10.01	-9.21	4.00	60.00	250.00	-15.3	-4.32	-18.72	0.79	4.00	-1.84	-3.85	-9.46	1.20	4.00	3.33	-2.04
60.00	260.00	-1.49	-18.64	-8.65	-11.54	4.00	60.00	260.00	-21.99	-3.61	-21.24	0.96	4.00	-1.45	-3.48	-8.42	1.20	4.00	3.65	-1.83
60.00	270.00	-1.44	-22.43	-5.68	-20.93	4.00	60.00	270.00	-16.12	-2.89	-11.95	1.33	4.00	-1.29	-2.84	-4.76	1.36	4.00	4.43	-1.30
60.00	280.00	-0.13	-8.49	-3.25	-12.08	4.00	60.00	280.00	-10.63	-3.91	-9.68	1.03	4.00	0.24	-2.61	-2.36	1.24	4.00	5.30	-0.56
60.00	290.00	-2.81	-5.74	-1.75	-6.50	4.00	60.00	290.00	-7.63	-5.06	-9.14	0.43	4.00	-1.57	-2.38	-1.02	1.23	4.00	5.19	-0.71
60.00	300.00	-1.47	-9.57	-0.43	-4.49	4.00	60.00	300.00	-5.25	-3.65	-8.75	-1.73	4.00	0.05	-2.66	0.17	0.12	4.00	5.52	-0.43
60.00	310.00	-0.40	-27.69	-0.74	-5.57	4.00	60.00	310.00	-4.77	-5.5	-12.08	-4.52	4.00	0.95	-4.98	-0.43	-2.00	4.00	4.67	-1.11
60.00	320.00	0.21	-16.69	0.29	-7.03	4.00	60.00	320.00	-3.91	-6.66	-11.89	-9.16	4.00	1.63	-6.25	0.55	-4.96	4.00	4.41	-1.04
60.00	330.00	-0.05	-8.75	-0.15	-11.31	4.00	60.00	330.00	-1.29	-5.94	-7.98	-12.69	4.00	2.38	-4.11	0.51	-8.94	4.00	4.50	-0.74
60.00	340.00	-0.71	-8.89	-0.65	-12.38	4.00	60.00	340.00	-2.16	-9.96	-7.43	-15.82	4.00	1.64	-6.38	0.18	-10.76	4.00	3.51	-1.53
60.00	350.00	-1.88	-10.02	-0.64	-11.96	4.00	60.00	350.00	-0.77	-15.36	-9.16	-15.41	4.00	1.72	-8.91	-0.07	-10.34	4.00	3.15	-1.72
75.00	0.00	0.93	-9.47	1.13	-8.22	4.00	75.00	0.00	-1.75	-13.55	-15.91	-14.85	4.00	2.80	-8.04	1.22	-7.37	4.00	4.50	-0.49
75.00	10.00	0.94	-8.01	0.45	-14.30	4.00	75.00	10.00	-0.94	-23.37	-18.28	-13.88	4.00	3.11	-7.89	0.51	-11.07	4.00	4.01	-0.69
75.00	20.00	-0.09	-15.18	0.66	-13.79	4.00	75.00	20.00	-1.1	-10.66	-13.63	-11.27	4.00	2.44	-9.35	0.82	-9.34	4.00	3.82	-0.97
75.00	30.00	0.15																		



105.00	0.00	-845	-2.01	-1.18	-7.07	4.00	105.00	0.00	-1.15	-8.86	-21.71	-9.38	4.00	-0.41	-1.19	-1.14	-5.06	4.00	4.25	-1.63
105.00	10.00	-692	-2.79	0.61	-7.48	4.00	105.00	10.00	-1	-12.51	-13.47	-13.7	4.00	-0.01	-2.35	0.78	-6.55	4.00	4.42	-1.25
105.00	20.00	-323	-7.32	0.82	-8.88	4.00	105.00	20.00	0.7	-12.07	-10.33	-23.7	4.00	2.18	-6.07	1.14	-8.74	4.00	4.32	-0.79
105.00	30.00	-055	-8.92	2.09	-16.66	4.00	105.00	30.00	-1.03	-16.4	-7.84	-20.93	4.00	2.23	-8.21	2.51	-15.28	4.00	4.05	-0.42
105.00	40.00	-1.62	-6.40	0.42	-15.72	4.00	105.00	40.00	-0.06	-14.46	-4.35	-14.13	4.00	2.24	-5.77	1.67	-11.84	4.00	4.29	-0.61
105.00	50.00	-2.27	-13.51	-2.78	-11.41	4.00	105.00	50.00	-1.75	-10.73	-4.75	-11.75	4.00	1.01	-8.89	-0.64	-8.57	4.00	2.87	-2.23
105.00	60.00	-2.49	-16.57	-3.61	-10.03	4.00	105.00	60.00	-3.21	-1.84	-6.04	-8.55	4.00	0.18	-1.70	-1.65	-6.22	4.00	3.97	-1.80
105.00	70.00	-2.28	-21.62	-4.72	-15.88	4.00	105.00	70.00	-5.54	0.64	-9.01	-15.48	4.00	-0.60	0.67	-3.35	-12.67	4.00	3.30	-1.95
105.00	80.00	-3.31	-23.50	-3.63	-5.96	4.00	105.00	80.00	-10.52	-0.09	-7.04	-9.96	4.00	-2.55	-0.07	-2.00	-4.50	4.00	3.88	-2.00
105.00	90.00	-3.93	-22.33	-3.56	-7.39	4.00	105.00	90.00	-19.79	-2.07	-6.28	-3.46	4.00	-3.82	-2.03	-1.70	-1.98	4.00	3.68	-2.31
105.00	100.00	-3.81	-16.21	-5.84	-15.37	4.00	105.00	100.00	-17.59	-2.48	-7.91	-5.49	4.00	-3.63	-2.30	-3.74	-5.07	4.00	2.39	-3.57
105.00	110.00	-4.25	-10.77	-12.58	-16.24	4.00	105.00	110.00	-13.59	-1.77	-7.94	-3.0	4.00	-3.77	-1.26	-6.66	-16.06	4.00	0.57	-4.53
105.00	120.00	-4.82	-8.17	-8.11	-9.12	4.00	105.00	120.00	-6.91	-4.44	-10.35	-5.91	4.00	-2.73	-2.91	-6.08	-4.21	4.00	2.14	-3.79
105.00	130.00	-5.04	-6.73	-4.74	-7.25	4.00	105.00	130.00	-5.43	-12.36	-15.61	-8.22	4.00	-2.22	-5.68	-4.40	-4.70	4.00	1.87	-4.05
105.00	140.00	-3.64	-4.86	-4.49	-4.59	4.00	105.00	140.00	-6.05	-11.38	-12.42	-14.29	4.00	-1.67	-4.06	-3.84	-4.15	4.00	2.65	-3.30
105.00	150.00	-1.98	-4.24	-4.32	-4.20	4.00	105.00	150.00	-7.01	-12.02	-18.36	-6.13	4.00	-0.79	-3.57	-4.15	-2.05	4.00	3.48	-2.44
105.00	160.00	-4.25	-1.66	-2.72	-9.78	4.00	105.00	160.00	-5.36	-31.02	-18.94	-13.76	4.00	-1.76	-1.65	-2.62	-8.32	4.00	2.82	-2.91
105.00	170.00	-2.69	-2.26	-2.29	-3.17	4.00	105.00	170.00	-5.78	-12.99	-27.67	-20.92	4.00	-0.96	-1.91	-2.28	-3.10	4.00	4.00	-1.99
105.00	180.00	-5.23	-6.30	-0.13	-4.05	4.00	105.00	180.00	-6.74	-6.3	-14.02	-13.68	4.00	-2.91	-3.29	0.04	-3.60	4.00	3.71	-2.17
105.00	190.00	-4.80	-7.01	-0.92	-3.43	4.00	105.00	190.00	-6.69	-10.28	-9.55	-17.73	4.00	-2.63	-5.33	-0.36	-3.27	4.00	3.30	-2.54
105.00	200.00	-9.78	-9.60	-6.30	-2.70	4.00	105.00	200.00	-6.47	-8.47	-8.75	-9.36	4.00	-4.81	-5.99	-4.34	-1.85	4.00	1.91	-3.97
105.00	210.00	-6.14	-12.56	-7.94	-7.05	4.00	105.00	210.00	-10.92	-8.89	-10.92	-11.78	4.00	-4.89	-7.34	-6.17	-5.79	4.00	0.02	-5.96
105.00	220.00	-8.10	-18.14	-5.69	-6.39	4.00	105.00	220.00	-20.26	-19.98	-6.31	-8.14	4.00	-7.84	-15.95	-2.98	-4.17	4.00	0.48	-5.70
105.00	230.00	-10.13	-9.46	-5.43	-8.19	4.00	105.00	230.00	-14.04	-8.2	-7.91	-5.43	4.00	-8.65	-5.77	-3.49	-3.58	4.00	0.89	-4.92
105.00	240.00	-14.72	-7.70	-13.64	-9.22	4.00	105.00	240.00	-25.08	-15.36	-10.25	-2.38	4.00	-14.34	-7.01	-8.61	-1.56	4.00	0.70	-5.72
105.00	250.00	-19.99	-11.74	-11.11	-11.48	4.00	105.00	250.00	-14.25	-9.68	-23.19	-0.79	4.00	-13.22	-7.58	-10.85	-0.43	4.00	0.56	-5.20
105.00	260.00	-8.98	-30.85	-3.70	-13.66	4.00	105.00	260.00	-14.1	-3.88	-16.4	0.54	4.00	-7.82	-3.87	-3.47	0.70	4.00	2.93	-2.60
105.00	270.00	-7.83	-14.20	-1.45	-12.74	4.00	105.00	270.00	-19.84	-3.56	-12.32	-0.13	4.00	-7.56	-3.20	-1.11	0.10	4.00	3.53	-2.12
105.00	280.00	-10.41	-16.68	-1.03	-15.62	4.00	105.00	280.00	-8.29	-2.52	-12.95	-1.18	4.00	-6.21	-2.36	-0.76	-1.03	4.00	3.68	-2.13
105.00	290.00	-26.31	-13.85	-1.67	-12.26	4.00	105.00	290.00	-5.14	-1.06	-13.91	-1.83	4.00	-5.11	-0.84	-1.42	-1.45	4.00	3.97	-1.92
105.00	300.00	-7.57	-9.59	-2.02	-7.72	4.00	105.00	300.00	-9.35	-1.09	-8.9	-2.86	4.00	-5.36	-0.52	-1.21	-1.63	4.00	4.03	-1.83
105.00	310.00	-4.86	-8.61	-2.45	-7.93	4.00	105.00	310.00	-7.98	-0.56	-8.34	-3.2	4.00	-3.14	0.07	-1.45	-1.94	4.00	4.48	-1.46
105.00	320.00	-5.87	-4.12	-0.79	-17.97	4.00	105.00	320.00	-6.42	-5.22	-11.76	-3.08	4.00	-3.13	-1.62	-0.46	-2.94	4.00	4.05	-1.90
105.00	330.00	-5.13	-4.78	-0.73	-9.99	4.00	105.00	330.00	-3.69	-31.59	-18.92	-5.48	4.00	-1.34	-4.77	-0.66	-4.16	4.00	3.46	-2.39
105.00	340.00	-8.67	-4.82	-2.96	-5.49	4.00	105.00	340.00	-2.22	-16.45	-20.74	-8.91	4.00	-1.33	-4.53	-2.89	-3.86	4.00	2.95	-2.98
105.00	350.00	-5.53	-4.32	-5.05	-6.18	4.00	105.00	350.00	-3.1	-18.71	-18.22	-10.08	4.00	-1.14	-4.16	-4.85	-4.70	4.00	2.45	-3.42
120.00	0.00	-4.82	-1.28	-2.50	-3.40	4.00	120.00	0.00	-2.03	-10.25	-38.27	-15.01	4.00	-0.19	-0.76	-2.50	-3.11	4.00	4.46	-1.48
120.00	10.00	-5.63	-1.66	-3.12	-1.94	4.00	120.00	10.00	-3.08	-10.6	-12.29	-14.22	4.00	-1.16	-1.14	-2.62	-1.69	4.00	4.39	-1.61
120.00	20.00	-4.65	-6.14	-0.94	-6.09	4.00	120.00	20.00	-4.08	-13.15	-13.38	-6.46	4.00	-1.35	-5.35	-0.70	-3.26	4.00	3.54	-2.31
120.00	30.00	-3.47	-10.72	-0.75	-2.22	4.00	120.00	30.00	-3.77	-14.32	-9.08	-5.52	4.00	-0.61	-9.15	-0.15	-0.55	4.00	4.09	-1.49
120.00	40.00	-2.51	-8.57	-0.70	-4.37	4.00	120.00	40.00	-2.18	-15.53	-6.7	-6.37	4.00	0.67	-3.78	0.27	-2.25	4.00	4.94	-0.91
120.00	50.00	-1.76	-8.92	-1.72	-6.04	4.00	120.00	50.00	-1.6	-5.39	-6.57	-5.67	4.00	1.33	-3.80	-0.49	-2.84	4.00	4.81	-0.98
120.00	60.00	-0.68	-8.37	-8.86	-5.92	4.00	120.00	60.00	-4.12	-4.52	-6.43	-4.15	4.00	0.94	-3.02	-4.47	-1.94	4.00	4.13	-1.64
120.00	70.00	-1.15	-10.18	-6.23	-10.79	4.00	120.00	70.00	-10.72	-1.94	-3.54	-11.49	4.00	-0.70	-1.33	-1.67	-8.12	4.00	3.52	-2.18
120.00	80.00	-2.47	-24.88	-3.84	-11.27	4.00	120.00	80.00	-16.35	-0.49	-4.54	-9.61	4.00	-2.30	-0.47	-1.17	-7.35	4.00	3.57	-2.16
120.00	90.00	-3.88	-14.55	-4.26	-11.91	4.00	120.00	90.00	-18.72	-1.3	-10.68	-6.8	4.00	-3.74	-1.10	-3.37	-5.63	4.00	2.71	-3.16
120.00	100.00	-5.76	-9.07	-9.66	-12.80	4.00	120.00	100.00	-18.37	-2.27	-15.77	-15.25	4.00	-5.53	-1.45	-8.69	-10.84	4.00	0.13	-5.18
120.00	110.00	-6.92	-8.34	-23.30	-12.27	4.00	120.00	110.00	-24.16	-4.56	-10.94	-12.31	4.00	-6.84	-3.04	-10.69	-9.28	4.00	-0.94	-6.45
120.00	120.00	-8.46	-8.47	-9.99	-13.88	4.00	120.00	120.00	-15.87	-6.7	-14.73	-7.86	4.00	-7.74	-4.49	-8.73	-6.89	4.00	-0.79	-6.66
120.00	130.00	-8.19	-11.56	-4.65	-7.63	4.00	120.00	130.00	-8.79	-11.93	-14.61	-11.01	4.00	-5.47	-8.73	-4.23	-5.99	4.00	0.06	-5.82
120.00	140.00	-8.43	-10.10	-7.57	-5.66	4.00	120.00	140.00	-7.07	-20.13	-16.52	-27.05	4.00	-4.69	-9.69	-7.05	-5.63	4.00	-0.55	-6.39
120.00	150.00	-8.36	-6.73	-9.44	-8.46	4.00	120.00	150.00	-9.19	-35.16	-15.88	-21.14	4.00	-5.74	-6.72	-8.55	-8.23	4.00	-1.22	-7.16
120.00	160.00	-6.85	-7.73	-4.59	-9.90	4.00	120.00	160.00	-7.53	-17.01	-19.54	-17.5	4.00	-4.17	-7.25	-4.45	-9.20	4.00	-0.01	-5.81
120.00	170.00	-7.57	-6.34	-6.55	-6.31	4.00	120.00	170.00	-9.01	-12.23	-29.52	-21.66	4.00	-5.22	-5.34	-6.53	-6.19	4.00	0.22	-5.78
120.00	180.00	-11.31	-6.39	-5.75	-9.30	4.00	120.00	180.00	-5.38	-12.85	-23.08	-10.98	4.00	-4.39	-5.51	-5.67	-7.05	4.00	0.42	-5.55
120.00	190.00	-12.82	-3.31	-7.13	-15.48	4.00	120.00	190.00	-10.47	-10.18	-13.13	-15.17	4.00	-8.48	-2.50	-6.16	-12.31	4.00	-0.62	-6.00
120.00	200.00	-13.69	-5.14	-16.03	-9.08	4.00	120.00	200.00	-9.13	-7	-9.43	-15.59	4.00	-7.83	-2.96	-8.57	-8.20	4.00	-0.54	-6.19
120.00	210.00	-13.19	-5.38	-9.89	-12.21	4.00	120.00	210.00	-11.26	-15.84	-16.46	-15.54	4.00	-9.11	-5.01	-9.03	-10.55	4.00	-2.14	-7.88
120.00	220.00	-13.34	-7.10	-6.98	-8.71	4.00	120.00	220.00	-14.54	-9.85	-11.2	-16.21	4.00	-10.89	-5.25	-5.59	-8.00	4.00	-1.13	-6.91
120.00	230.00	-16.08	-10.70	-7.09	-7.65	4.00	120.00	230.00	-15.4	-11.41	-20.87	-12.54	4.00	-12.72	-8.03	-6.91	-6.43	4.00	-2.18	-7.95
120.00	240.00	-17.86	-17.77	-17.98	-8.04	4.00	120													



150.00	220.00	-26.79	-12.12	-20.25	-14.14	4.00	150.00	220.00	-12.74	-12.58	-39.68	-7.89	4.00	-12.57	-9.33	-20.20	-6.97	4.00	-5.01	-10.19
150.00	230.00	-27.56	-14.26	-23.09	-18.27	4.00	150.00	230.00	-12.04	-22.91	-26.46	-4.74	4.00	-11.92	-13.70	-21.45	-4.55	4.00	-4.91	-9.35
150.00	240.00	-20.30	-29.46	-20.55	-17.23	4.00	150.00	240.00	-14.15	-19.02	-19.4	-4.3	4.00	-13.21	-18.64	-16.93	-4.08	4.00	-5.17	-9.28
150.00	250.00	-14.44	-26.31	-17.98	-15.60	4.00	150.00	250.00	-17.14	-13.09	-14.87	-5.48	4.00	-12.57	-12.89	-13.14	-5.08	4.00	-4.16	-9.34
150.00	260.00	-13.80	-32.04	-16.76	-13.48	4.00	150.00	260.00	-16.97	-13.31	-12.31	-6.11	4.00	-12.09	-13.25	-10.98	-5.38	4.00	-3.83	-9.22
150.00	270.00	-16.43	-28.52	-13.67	-9.97	4.00	150.00	270.00	-12.83	-10.3	-11.16	-8.53	4.00	-11.26	-10.24	-9.23	-6.18	4.00	-2.99	-8.78
150.00	280.00	-17.17	-13.17	-12.34	-11.50	4.00	150.00	280.00	-10.7	-3	-12.42	-10.34	4.00	-9.82	-2.60	-9.37	-7.87	4.00	-0.88	-6.32
150.00	290.00	-15.79	-7.57	-13.27	-11.52	4.00	150.00	290.00	-10.65	0.1	-15.11	-10.58	4.00	-9.49	0.79	-11.08	-8.01	4.00	0.45	-4.13
150.00	300.00	-13.50	-4.12	-12.13	-10.55	4.00	150.00	300.00	-11.49	0.36	-19.75	-10.18	4.00	-9.37	1.68	-11.44	-7.35	4.00	1.03	-3.36
150.00	310.00	-13.40	-2.64	-9.99	-8.31	4.00	150.00	310.00	-9.82	-0.44	-24.74	-9.03	4.00	-8.24	1.61	-9.85	-5.64	4.00	1.71	-3.07
150.00	320.00	-14.54	-1.46	-8.58	-5.68	4.00	150.00	320.00	-8.62	-0.8	-21.71	-10.81	4.00	-7.63	1.89	-8.37	-4.52	4.00	2.39	-2.56
150.00	330.00	-9.69	-1.03	-12.06	-4.03	4.00	150.00	330.00	-11.76	-0.95	-32.49	-18.31	4.00	-7.59	2.02	-12.02	-3.87	4.00	2.18	-2.52
150.00	340.00	-5.57	-1.64	-14.55	-7.52	4.00	150.00	340.00	-19.99	-2.43	-16.55	-18.62	4.00	-5.42	0.99	-12.43	-7.20	4.00	1.34	-3.49
150.00	350.00	-4.23	-1.28	-16.12	-12.80	4.00	150.00	350.00	-12.31	-5.9	-14.86	-17.2	4.00	-3.60	0.01	-12.43	-11.45	4.00	0.70	-4.07
165.00	0.00	-9.47	-0.06	-5.63	-3.46	4.00	165.00	0.00	-6.79	-3.34	-17.53	-15.67	4.00	-4.92	1.61	-5.36	-3.21	4.00	3.53	-1.97
165.00	10.00	-8.53	-1.28	-5.27	-4.35	4.00	165.00	10.00	-6.36	-2.16	-18.34	-12.82	4.00	-4.30	1.31	-5.06	-3.77	4.00	3.46	-2.12
165.00	20.00	-6.74	-4.45	-5.86	-7.33	4.00	165.00	20.00	-5.52	-0.82	-18.98	-12.47	4.00	-3.08	0.74	-5.65	-6.17	4.00	2.94	-2.61
165.00	30.00	-6.81	-10.56	-7.09	-8.95	4.00	165.00	30.00	-5.49	-1.03	-13.79	-13.03	4.00	-3.09	-0.57	-6.25	-7.52	4.00	2.09	-3.51
165.00	40.00	-7.45	-20.99	-7.54	-9.83	4.00	165.00	40.00	-5.85	-2.3	-9.88	-15.33	4.00	-3.57	-2.24	-5.54	-8.75	4.00	1.32	-4.41
165.00	50.00	-6.31	-18.58	-7.77	-9.44	4.00	165.00	50.00	-5.82	-4.47	-10.23	-16.17	4.00	-3.05	-4.30	-5.82	-8.60	4.00	0.81	-4.99
165.00	60.00	-6.98	-16.36	-7.57	-10.55	4.00	165.00	60.00	-6.4	-7.44	-10.68	-14.73	4.00	-3.67	-6.92	-5.84	-9.15	4.00	-0.15	-5.96
165.00	70.00	-5.49	-19.26	-7.76	-12.42	4.00	165.00	70.00	-7.76	-9.75	-10.5	-11.7	4.00	-3.47	-9.29	-5.91	-9.03	4.00	-0.57	-6.25
165.00	80.00	-5.27	-23.75	-8.77	-17.80	4.00	165.00	80.00	-8.51	-7.29	-10.14	-9.35	4.00	-3.58	-7.19	-6.39	-8.77	4.00	-0.25	-6.06
165.00	90.00	-7.06	-16.91	-10.19	-23.77	4.00	165.00	90.00	-8.38	-5.36	-11.63	-7.99	4.00	-4.66	-5.07	-7.84	-7.88	4.00	-0.21	-6.10
165.00	100.00	-9.75	-12.09	-11.94	-19.82	4.00	165.00	100.00	-8.43	-6.06	-10.6	-8.38	4.00	-6.03	-5.09	-8.21	-8.08	4.00	-0.73	-6.65
165.00	110.00	-12.77	-10.74	-13.98	-15.25	4.00	165.00	110.00	-8.61	-9.29	-8.94	-10.06	4.00	-7.20	-6.94	-7.76	-8.91	4.00	-1.65	-7.64
165.00	120.00	-19.22	-10.44	-12.96	-13.97	4.00	165.00	120.00	-9.83	-16.22	-10.61	-11.53	4.00	-9.36	-9.42	-8.62	-9.57	4.00	-3.21	-9.23
165.00	130.00	-27.06	-8.16	-11.70	-13.17	4.00	165.00	130.00	-14.08	-16.98	-12.03	-13.17	4.00	-13.87	-7.62	-8.85	-10.16	4.00	-3.81	-9.58
165.00	140.00	-21.41	-5.77	-10.70	-11.79	4.00	165.00	140.00	-17.36	-13.33	-13.65	-16.09	4.00	-15.92	-5.07	-8.92	-10.42	4.00	-3.24	-8.57
165.00	150.00	-25.09	-3.63	-11.00	-7.73	4.00	165.00	150.00	-18.47	-17.7	-17.85	-19.37	4.00	-17.61	-3.46	-10.18	-7.44	4.00	-2.29	-7.31
165.00	160.00	-23.91	-3.49	-10.25	-4.35	4.00	165.00	160.00	-17.79	-23.94	-22.51	-13.63	4.00	-16.84	-3.45	-10.00	-3.87	4.00	-1.05	-6.09
165.00	170.00	-18.91	-4.80	-10.58	-4.17	4.00	165.00	170.00	-18.89	-14.73	-21.6	-12.21	4.00	-15.89	-4.38	-10.25	-3.54	4.00	-1.22	-6.35
165.00	180.00	-14.10	-5.86	-13.33	-7.15	4.00	165.00	180.00	-18.83	-14.96	-18.16	-13.16	4.00	-12.84	-5.36	-12.10	-6.18	4.00	-2.46	-7.92
165.00	190.00	-14.26	-5.62	-16.56	-11.05	4.00	165.00	190.00	-15.24	-35.54	-15	-25.77	4.00	-11.71	-5.62	-12.70	-10.91	4.00	-3.74	-9.24
165.00	200.00	-17.51	-8.71	-20.85	-7.92	4.00	165.00	200.00	-13.08	-18.43	-15.23	-17.74	4.00	-11.74	-8.27	-14.18	-7.49	4.00	-4.00	-9.66
165.00	210.00	-21.85	-18.10	-30.12	-7.05	4.00	165.00	210.00	-12.18	-18.83	-14.51	-11.9	4.00	-11.74	-15.44	-14.39	-5.82	4.00	-4.96	-10.07
165.00	220.00	-26.73	-20.02	-18.74	-6.27	4.00	165.00	220.00	-13.2	-20.2	-15.57	-7.52	4.00	-13.01	-17.10	-13.86	-3.84	4.00	-4.37	-8.83
165.00	230.00	-29.91	-12.71	-16.80	-5.96	4.00	165.00	230.00	-10.82	-11.93	-13.15	-5.65	4.00	-10.77	-9.29	-11.59	-2.79	4.00	-1.83	-7.01
165.00	240.00	-18.98	-13.35	-14.50	-8.36	4.00	165.00	240.00	-9.5	-8.14	-11.82	-3.98	4.00	-9.04	-7.00	-9.95	-2.63	4.00	-0.64	-6.15
165.00	250.00	-11.77	-16.52	-12.40	-12.39	4.00	165.00	250.00	-12.03	-7.75	-11.39	-3.81	4.00	-8.89	-7.21	-8.86	-3.25	4.00	-0.70	-6.37
165.00	260.00	-9.43	-15.85	-11.56	-15.37	4.00	165.00	260.00	-14.14	-9.2	-11.75	-4.99	4.00	-8.17	-8.35	-8.64	-4.61	4.00	-1.26	-7.09
165.00	270.00	-7.78	-13.78	-10.34	-12.07	4.00	165.00	270.00	-11.54	-12.91	-11.17	-8.55	4.00	-6.25	-10.31	-7.72	-6.95	4.00	-1.66	-7.57
165.00	280.00	-10.29	-12.78	-9.93	-9.78	4.00	165.00	280.00	-10.23	-16.48	-11.34	-13.99	4.00	-7.25	-11.24	-7.57	-8.38	4.00	-2.45	-8.36
165.00	290.00	-11.99	-12.36	-9.83	-7.96	4.00	165.00	290.00	-8.99	-11.89	-12	-30.53	4.00	-7.23	-9.11	-7.77	-7.94	4.00	-1.96	-7.96
165.00	300.00	-13.05	-9.44	-10.59	-6.51	4.00	165.00	300.00	-8.95	-7.27	-13.26	-13.56	4.00	-7.52	-5.21	-8.71	-5.73	4.00	-0.66	-6.58
165.00	310.00	-14.96	-7.99	-9.62	-5.71	4.00	165.00	310.00	-9.02	-5.04	-15.5	-10.44	4.00	-8.03	-3.26	-8.62	-4.45	4.00	0.23	-5.51
165.00	320.00	-15.61	-3.92	-8.51	-5.18	4.00	165.00	320.00	-9.7	-4.46	-16.4	-14.49	4.00	-8.71	-1.17	-7.86	-4.70	4.00	0.94	-4.56
165.00	330.00	-13.76	-1.45	-9.67	-5.26	4.00	165.00	330.00	-11.67	-4.91	-18.38	-15.67	4.00	-9.58	0.17	-9.12	-4.88	4.00	1.10	-3.99
165.00	340.00	-12.20	0.08	-8.89	-5.40	4.00	165.00	340.00	-10.55	-5.85	-24.46	-14.95	4.00	-8.29	1.07	-8.77	-4.94	4.00	1.75	-3.28
165.00	350.00	-10.73	0.55	-8.46	-4.44	4.00	165.00	350.00	-7.98	-5.03	-24.63	-15.6	4.00	-6.13	1.61	-8.36	-4.12	4.00	2.61	-2.55
180.00	0.00	-7.10	-11.74	-18.92	-7.85	4.00	180.00	0.00	-10.87	-17.4	-18.23	-11.35	4.00	-5.58	-10.70	-15.55	-6.25	4.00	-2.66	-8.05
180.00	10.00	-6.29	-11.11	-17.54	-7.02	4.00	180.00	10.00	-13.76	-21.13	-19.91	-14.15	4.00	-5.57	-10.70	-15.55	-6.25	4.00	-2.66	-8.05
180.00	20.00	-5.80	-10.77	-16.58	-6.50	4.00	180.00	20.00	-18.58	-28.36	-22.33	-18.73	4.00	-5.58	-10.70	-15.56	-6.25	4.00	-2.66	-8.05
180.00	30.00	-5.59	-10.71	-15.95	-6.27	4.00	180.00	30.00	-31.41	-37.97	-26.09	-29.93	4.00	-5.58	-10.70	-15.55	-6.25	4.00	-2.66	-8.05
180.00	40.00	-5.64	-10.91	-15.62	-6.30	4.00	180.00	40.00	-23.77	-24	-33.49	-25.51	4.00	-5.57	-10.70	-15.55	-6.25	4.00	-2.66	-8.05
180.00	50.00	-5.97	-11.38	-15.56	-6.60	4.00	180.00	50.00	-16.22	-19.05	-42.05	-17.31	4.00	-5.58	-10.69	-15.55	-6.25	4.00	-2.66	-8.05
180.00	60.00	-6.58	-12.18	-15.77	-7.19	4.00	180.00	60.00	-12.41	-16.1	-28.7	-13.33	4.00	-5.57	-10.70	-15.55	-6.24	4.00	-2.66	-8.04
180.00	70.00	-7.54	-13.34	-16.25	-8.12	4.00	180.00	70.00	-9.97	-14.11	-23.82	-10.81	4.00	-5.58	-10.70	-15.55	-6.25	4.00	-2.66	-8.05
180.00	80.00	-8.91	-15.01	-17.05	-9.45	4.00	180.00	80.00	-8.28	-12.71	-20.9	-9.07	4.00	-5.57	-10.70	-15.55	-6.25	4.00	-2.66	-8.04
180.00	90.00	-10.87	-17.40	-18.23	-11.35	4.00	180.00	90.00	-7.1	-11.74										



Frequency: 5240MHz

Theta Polarization		Max Gain(dB)				Nant	Angle (θ)	Angle (ψ)	Phi Polarization				Nant	Total				Max DG(dB)	Max DG(dB)		
Angle (θ)	Angle (ψ)	Ant 1(G1)	Ant 2(G2)	Ant 3(G3)	Ant 4(G4)				Max Gain(dB)					Ant 1(G1)	Ant 2(G2)	Ant 3(G3)	Ant 4(G4)			7.39	1.94
		0.91	3.74	2.58	2.46				1.27	3.74	-1.21	3.12		3.94	4.10	2.59	4.50				
		Ant 1(G1)	Ant 2(G2)	Ant 3(G3)	Ant 4(G4)	Ant 1(G1)	Ant 2(G2)	Ant 3(G3)	Ant 4(G4)	Ant 1(G1)	Ant 2(G2)	Ant 3(G3)	Ant 4(G4)	g1k	g1k						
0.00	0.00	-21.14	3.63	-7.67	0.46	4.00	0.00	0.00	-7.31	-12.19	-11.83	-17.52	4.00	-7.13	3.74	-6.26	0.53	4.00	4.93	-0.08	
0.00	10.00	-15.85	3.74	-6.90	0.52	4.00	0.00	10.00	-7.76	-33.22	-14.87	-25.66	4.00	-7.13	3.74	-6.26	0.53	4.00	4.93	-0.08	
0.00	20.00	-12.77	3.59	-6.45	0.31	4.00	0.00	20.00	-8.52	-10.79	-20.06	-12.55	4.00	-7.13	3.75	-6.26	0.53	4.00	4.93	-0.08	
0.00	30.00	-10.71	3.16	-6.26	-0.18	4.00	0.00	30.00	-9.65	-5.25	-36.39	-7.70	4.00	-7.14	3.75	-6.26	0.53	4.00	4.93	-0.08	
0.00	40.00	-9.26	2.42	-6.35	-0.98	4.00	0.00	40.00	-11.26	-2.07	-23.16	-4.79	4.00	-7.14	3.74	-6.26	0.53	4.00	4.93	-0.08	
0.00	50.00	-8.26	1.32	-6.71	-2.16	4.00	0.00	50.00	-13.57	0.05	-16.36	-2.83	4.00	-7.14	3.74	-6.26	0.53	4.00	4.93	-0.08	
0.00	60.00	-7.60	-0.25	-7.36	-3.84	4.00	0.00	60.00	-17.11	1.53	-12.77	-1.44	4.00	-7.14	3.74	-6.26	0.53	4.00	4.93	-0.08	
0.00	70.00	-7.23	-2.50	-8.36	-6.27	4.00	0.00	70.00	-23.75	2.56	-10.43	-0.49	4.00	-7.13	3.74	-6.26	0.53	4.00	4.93	-0.08	
0.00	80.00	-7.14	-5.92	-9.79	-10.06	4.00	0.00	80.00	-38.72	3.25	-8.81	0.13	4.00	-7.14	3.75	-6.26	0.53	4.00	4.93	-0.08	
0.00	90.00	-7.31	-12.19	-11.83	-17.52	4.00	0.00	90.00	-21.14	3.63	-7.67	0.46	4.00	-7.13	3.74	-6.26	0.53	4.00	4.93	-0.08	
0.00	100.00	-7.76	-33.22	-14.87	-25.66	4.00	0.00	100.00	-15.85	3.74	-6.90	0.52	4.00	-7.13	3.74	-6.26	0.53	4.00	4.93	-0.08	
0.00	110.00	-8.52	-10.79	-20.06	-12.55	4.00	0.00	110.00	-12.77	3.59	-6.45	0.31	4.00	-7.13	3.75	-6.26	0.53	4.00	4.93	-0.08	
0.00	120.00	-9.65	-5.25	-36.39	-7.70	4.00	0.00	120.00	-10.71	3.16	-6.26	-0.18	4.00	-7.14	3.75	-6.26	0.53	4.00	4.93	-0.08	
0.00	130.00	-11.26	-2.07	-23.16	-4.79	4.00	0.00	130.00	-9.26	2.42	-6.35	-0.98	4.00	-7.14	3.74	-6.26	0.53	4.00	4.93	-0.08	
0.00	140.00	-13.57	0.05	-16.36	-2.83	4.00	0.00	140.00	-8.26	1.32	-6.71	-2.16	4.00	-7.14	3.74	-6.26	0.53	4.00	4.93	-0.08	
0.00	150.00	-17.11	1.53	-12.77	-1.44	4.00	0.00	150.00	-7.60	-0.25	-7.36	-3.84	4.00	-7.14	3.74	-6.26	0.53	4.00	4.93	-0.08	
0.00	160.00	-23.75	2.56	-10.43	-0.49	4.00	0.00	160.00	-7.23	-2.50	-8.36	-6.27	4.00	-7.13	3.74	-6.26	0.53	4.00	4.93	-0.08	
0.00	170.00	-38.72	3.25	-8.81	0.13	4.00	0.00	170.00	-7.14	-5.92	-9.79	-10.06	4.00	-7.14	3.75	-6.26	0.53	4.00	4.93	-0.08	
0.00	180.00	-21.14	3.63	-7.67	0.46	4.00	0.00	180.00	-7.31	-12.19	-11.83	-17.52	4.00	-7.13	3.74	-6.26	0.53	4.00	4.93	-0.08	
0.00	190.00	-15.85	3.74	-6.90	0.52	4.00	0.00	190.00	-7.76	-33.22	-14.87	-25.66	4.00	-7.13	3.74	-6.26	0.53	4.00	4.93	-0.08	
0.00	200.00	-12.77	3.59	-6.45	0.31	4.00	0.00	200.00	-8.52	-10.79	-20.06	-12.55	4.00	-7.13	3.75	-6.26	0.53	4.00	4.93	-0.08	
0.00	210.00	-10.71	3.16	-6.26	-0.18	4.00	0.00	210.00	-9.65	-5.25	-36.39	-7.70	4.00	-7.14	3.75	-6.26	0.53	4.00	4.93	-0.08	
0.00	220.00	-9.26	2.42	-6.35	-0.98	4.00	0.00	220.00	-11.26	-2.07	-23.16	-4.79	4.00	-7.14	3.74	-6.26	0.53	4.00	4.93	-0.08	
0.00	230.00	-8.26	1.32	-6.71	-2.16	4.00	0.00	230.00	-13.57	0.05	-16.36	-2.83	4.00	-7.14	3.74	-6.26	0.53	4.00	4.93	-0.08	
0.00	240.00	-7.60	-0.25	-7.36	-3.84	4.00	0.00	240.00	-17.11	1.53	-12.77	-1.44	4.00	-7.14	3.74	-6.26	0.53	4.00	4.93	-0.08	
0.00	250.00	-7.23	-2.50	-8.36	-6.27	4.00	0.00	250.00	-23.75	2.56	-10.43	-0.49	4.00	-7.13	3.74	-6.26	0.53	4.00	4.93	-0.08	
0.00	260.00	-7.14	-5.92	-9.79	-10.06	4.00	0.00	260.00	-38.72	3.25	-8.81	0.13	4.00	-7.14	3.75	-6.26	0.53	4.00	4.93	-0.08	
0.00	270.00	-7.31	-12.19	-11.83	-17.52	4.00	0.00	270.00	-21.14	3.63	-7.67	0.46	4.00	-7.13	3.74	-6.26	0.53	4.00	4.93	-0.08	
0.00	280.00	-7.76	-33.22	-14.87	-25.66	4.00	0.00	280.00	-15.85	3.74	-6.90	0.52	4.00	-7.13	3.74	-6.26	0.53	4.00	4.93	-0.08	
0.00	290.00	-8.52	-10.79	-20.06	-12.55	4.00	0.00	290.00	-12.77	3.59	-6.45	0.31	4.00	-7.13	3.75	-6.26	0.53	4.00	4.93	-0.08	
0.00	300.00	-9.65	-5.25	-36.39	-7.70	4.00	0.00	300.00	-10.71	3.16	-6.26	-0.18	4.00	-7.14	3.75	-6.26	0.53	4.00	4.93	-0.08	
0.00	310.00	-11.26	-2.07	-23.16	-4.79	4.00	0.00	310.00	-9.26	2.42	-6.35	-0.98	4.00	-7.14	3.74	-6.26	0.53	4.00	4.93	-0.08	
0.00	320.00	-13.57	0.05	-16.36	-2.83	4.00	0.00	320.00	-8.26	1.32	-6.71	-2.16	4.00	-7.14	3.74	-6.26	0.53	4.00	4.93	-0.08	
0.00	330.00	-17.11	1.53	-12.77	-1.44	4.00	0.00	330.00	-7.60	-0.25	-7.36	-3.84	4.00	-7.14	3.74	-6.26	0.53	4.00	4.93	-0.08	
0.00	340.00	-23.75	2.56	-10.43	-0.49	4.00	0.00	340.00	-7.23	-2.50	-8.36	-6.27	4.00	-7.13	3.74	-6.26	0.53	4.00	4.93	-0.08	
0.00	350.00	-38.72	3.25	-8.81	0.13	4.00	0.00	350.00	-7.14	-5.92	-9.79	-10.06	4.00	-7.14	3.75	-6.26	0.53	4.00	4.93	-0.08	
15.00	0.00	-3.78	2.21	-5.67	0.01	4.00	15.00	0.00	-4.03	-15.58	-5.84	-20.95	4.00	-0.89	2.28	-2.74	0.04	4.00	5.88	0.05	
15.00	10.00	-5.71	2.40	-4.91	0.01	4.00	15.00	10.00	-4.41	-19.78	-6.43	-13.00	4.00	-2.00	2.43	-2.59	0.22	4.00	5.77	-0.02	
15.00	20.00	-10.84	2.18	-8.09	-0.82	4.00	15.00	20.00	-4.50	-12.11	-10.49	-8.26	4.00	-3.59	2.34	-6.12	-0.10	4.00	4.74	-0.74	
15.00	30.00	-22.91	2.05	-8.71	-1.87	4.00	15.00	30.00	-4.39	-7.59	-11.32	-5.42	4.00	-4.33	2.50	-6.81	-0.28	4.00	4.52	-0.85	
15.00	40.00	-17.32	2.20	-9.18	-4.43	4.00	15.00	40.00	-5.96	-4.09	-8.53	-3.49	4.00	-5.65	3.12	-5.83	-0.92	4.00	4.51	-0.72	
15.00	50.00	-11.34	1.52	-6.77	-6.27	4.00	15.00	50.00	-7.97	-1.25	-10.74	-1.98	4.00	-6.33	3.36	-5.31	-0.61	4.00	4.69	-0.50	
15.00	60.00	-8.58	0.35	-7.15	-9.01	4.00	15.00	60.00	-11.65	0.59	-11.74	-0.28	4.00	-6.84	3.48	-5.85	0.27	4.00	4.83	-0.27	
15.00	70.00	-8.22	-1.36	-6.45	-14.58	4.00	15.00	70.00	-19.93	1.86	-9.10	0.81	4.00	-7.94	3.55	-4.57	0.93	4.00	5.13	0.02	
15.00	80.00	-8.03	-4.22	-6.25	-21.03	4.00	15.00	80.00	-21.64	2.97	-10.28	1.41	4.00	-7.84	3.73	-4.80	1.43	4.00	5.33	0.26	
15.00	90.00	-8.48	-8.82	-5.51	-12.26	4.00	15.00	90.00	-15.84	3.32	-11.03	1.65	4.00	-7.75	3.58	-4.44	1.82	4.00	5.47	0.34	
15.00	100.00	-9.24	-12.84	-5.23	-6.81	4.00	15.00	100.00	-11.31	3.41	-11.89	1.38	4.00	-7.14	3.51	-4.38	1.99	4.00	5.57	0.40	
15.00	110.00	-12.03	-10.35	-5.21	-3.36	4.00	15.00	110.00	-8.71	2.84	-14.29	1.01	4.00	-7.05	3.04	-4.70	2.36	4.00	5.48	0.29	
15.00	120.00	-17.23	-5.66	-4.77	-1.20	4.00	15.00	120.00	-7.39	2.13	-15.98	0.36	4.00	-6.96	2.80	-4.45	2.66	4.00	5.54	0.32	
15.00	130.00	-42.32	-3.09	-5.25	0.21	4.00	15.00	130.00	-7.28	1.12	-15.22	-0.63	4.00	-7.28	2.52	-4.83	2.82	4.00	5.40	0.23	
15.00	140.00	-18.84	-1.65	-5.16	0.94	4.00	15.00	140.00	-5.81	0.19	-16.43	-2.46	4.00	-5.60	2.38	-4.85	2.57	4.00	5.48	0.15	
15.00	150.00	-12.26	-0.38	-5.30	1.39	4.00	15.00	150.00	-5.67	-1.06	-15.82	-4.73	4.00	-4.81	2.30	-4.93	2.34	4.00	5.47	0.07	
15.00	160.00	-8.24	0.65	-5.16	1.18	4.00	15.00	160.00	-5.70	-2.94	-14.50	-7.01	4.00	-3.78	2.23	-4.68	1.79	4.00	5.47	-0.07	
15.00	170.00	-5.74	1.69	-5.49	1.68	4.00	15.00	170.00	-5.85	-5.49	-12.42	-8.59	4.00	-2.78	2.45	-4.69	2.07	4.00	5.81	0.25	
15.00	180.00	-5.03	2.18	-5.46	2.10	4.00	15.00	180.00	-8.62	-11.16	-13.54	-9.85	4.00	-3.45	2.38	-4.83	2.37	4.00	5.74	0.25	
15.00	190.00	-5.50	2.43	-6.44	1.77	4.00	15.00	190.00	-12.95	-21.27	-10.66	-7.80	4.00	-4.78	2.45	-5.05	2.22	4.00	5.47	0.08	
15.00	200.00	-3.81	2.08	-7.35	0.92	4.00	15.00	200.00	-12.50	-9.54	-8.75	-6.03	4.00	-3.26	2.37	-4.98	1.72	4.00	5.54	0.00	
15.00	210.00	-5.02	1.70	-8.54	-0.08	4.00	15.00	210.00	-14.91	-5.00	-7.35	-5.10	4.00	-4.60	2.54	-4.89	1.11	4.00	5.19	-0.27	
15.00	220.00	-4.99	0.45	-7.56	-1.35	4.															



45.00	140.00	-4.33	-1.49	-0.77	-1.34	4.00	45.00	140.00	-2.81	-1.63	-16.88	-1.16	4.00	-0.49	1.45	-0.66	1.76	4.00	6.60	0.65
45.00	150.00	-3.19	0.34	0.26	-0.94	4.00	45.00	150.00	-2.93	-2.26	-18.91	-2.83	4.00	-0.05	2.24	0.31	1.23	4.00	7.00	1.03
45.00	160.00	-1.59	0.07	1.19	-2.06	4.00	45.00	160.00	-2.35	-4.00	-27.46	-5.00	4.00	1.06	1.51	1.20	-0.28	4.00	6.92	0.92
45.00	170.00	0.00	-0.06	1.52	-1.26	4.00	45.00	170.00	-3.98	-5.91	-15.84	-6.44	4.00	1.46	0.94	1.60	-0.11	4.00	7.02	1.02
45.00	180.00	0.48	0.96	1.33	-2.80	4.00	45.00	180.00	-6.69	-8.04	-11.94	-13.68	4.00	1.24	1.47	1.53	-2.46	4.00	6.62	0.72
45.00	190.00	0.83	-1.07	-0.53	-0.20	4.00	45.00	190.00	-6.13	-5.91	-8.46	-14.23	4.00	1.63	0.16	0.12	-0.03	4.00	6.52	0.52
45.00	200.00	0.80	-2.43	-2.33	-0.28	4.00	45.00	200.00	-11.63	-7.53	-6.44	-6.94	4.00	1.04	-1.26	-0.91	0.57	4.00	5.94	-0.03
45.00	210.00	-0.16	-2.98	-3.05	-1.75	4.00	45.00	210.00	-10.46	-7.86	-7.74	-4.96	4.00	0.23	-1.76	-1.78	-0.05	4.00	5.23	-0.74
45.00	220.00	-1.74	-5.77	-3.37	-3.12	4.00	45.00	220.00	-11.17	-3.85	-11.66	-5.07	4.00	-1.27	-1.69	-2.77	-0.98	4.00	4.37	-1.63
45.00	230.00	-2.36	-10.60	-3.35	-3.20	4.00	45.00	230.00	-14.60	-2.09	-13.61	-1.55	4.00	-2.11	-1.52	-2.96	0.71	4.00	4.66	-1.24
45.00	240.00	-1.50	-15.31	-3.67	-4.56	4.00	45.00	240.00	-18.01	-2.23	-15.51	1.80	4.00	-1.40	-2.02	-3.39	2.70	4.00	5.31	-0.37
45.00	250.00	-1.54	-14.78	-4.16	-8.41	4.00	45.00	250.00	-16.99	-3.09	-17.43	3.10	4.00	-1.42	-2.81	-3.96	3.40	4.00	5.31	-0.18
45.00	260.00	-2.61	-11.90	-3.90	-11.83	4.00	45.00	260.00	-10.70	-3.13	-19.11	3.12	4.00	-1.98	-2.59	-3.77	3.26	4.00	5.20	-0.31
45.00	270.00	-3.69	-9.46	-4.01	-16.86	4.00	45.00	270.00	-9.04	-3.48	-20.28	2.59	4.00	-2.58	-2.50	-4.00	2.64	4.00	4.81	-0.77
45.00	280.00	-5.00	-9.70	-3.39	-14.10	4.00	45.00	280.00	-5.88	-4.05	-30.63	1.98	4.00	-2.41	-3.00	-3.31	2.09	4.00	4.66	-1.03
45.00	290.00	-2.82	-11.83	-2.19	-9.50	4.00	45.00	290.00	-5.78	-3.47	-13.55	1.12	4.00	-1.04	-2.88	-1.88	1.48	4.00	5.10	-0.76
45.00	300.00	-2.21	-11.56	-1.08	-6.95	4.00	45.00	300.00	-4.91	-1.56	-11.32	-0.84	4.00	-0.34	-1.15	-0.69	0.11	4.00	5.52	-0.49
45.00	310.00	-1.51	-6.61	0.84	-7.98	4.00	45.00	310.00	-4.40	-1.96	-8.28	-4.09	4.00	0.29	-0.68	1.34	-2.60	4.00	5.73	-0.18
45.00	320.00	-1.36	-5.36	0.56	-4.95	4.00	45.00	320.00	-1.96	-2.15	-5.60	-7.30	4.00	1.36	-0.45	1.50	-2.96	4.00	6.06	0.20
45.00	330.00	-1.01	-5.09	0.08	-2.09	4.00	45.00	330.00	-1.68	-3.10	-4.52	-7.92	4.00	1.68	-0.97	1.37	-1.08	4.00	6.36	0.44
45.00	340.00	-0.88	-4.82	-0.78	-1.60	4.00	45.00	340.00	-1.55	-7.71	-4.88	-15.16	4.00	1.81	-3.02	0.65	-1.41	4.00	5.72	-0.11
45.00	350.00	-1.44	-4.10	-2.17	-3.01	4.00	45.00	350.00	0.02	-10.66	-6.96	-17.15	4.00	2.36	-3.23	-0.93	-2.85	4.00	5.16	-0.55
60.00	0.00	-1.02	-7.36	1.89	-9.00	4.00	60.00	0.00	-0.73	-15.14	-12.07	-18.30	4.00	2.14	-6.69	2.06	-8.52	4.00	4.57	-0.46
60.00	10.00	-1.95	-4.76	1.62	-9.04	4.00	60.00	10.00	-0.78	-11.00	-12.10	-7.84	4.00	1.68	-3.83	1.80	-5.39	4.00	5.17	-0.35
60.00	20.00	-3.17	-6.39	0.78	-5.14	4.00	60.00	20.00	-1.52	-8.24	-13.23	-4.58	4.00	0.74	-4.21	0.95	-1.84	4.00	5.18	-0.62
60.00	30.00	-3.80	-4.41	0.84	-6.47	4.00	60.00	30.00	-2.80	-8.13	-13.04	-7.87	4.00	-0.26	-2.87	1.01	-4.10	4.00	4.70	-1.09
60.00	40.00	-4.91	-5.92	0.38	-10.13	4.00	60.00	40.00	-3.59	-4.78	-19.71	-5.27	4.00	-1.19	-2.19	0.42	-4.04	4.00	4.39	-1.48
60.00	50.00	-8.68	-4.80	-1.76	-15.47	4.00	60.00	50.00	-5.52	-4.02	-29.96	-2.34	4.00	-3.81	-1.38	-1.75	-2.13	4.00	3.80	-2.18
60.00	60.00	-12.54	-4.17	-3.06	-11.23	4.00	60.00	60.00	-9.34	-4.58	-28.45	-3.23	4.00	-7.64	-1.36	-3.05	-2.59	4.00	2.66	-3.12
60.00	70.00	-13.08	-4.98	-5.64	-15.18	4.00	60.00	70.00	-16.95	-3.44	-47.18	-2.39	4.00	-11.59	-3.20	-5.20	3.20	4.00	3.38	-1.34
60.00	80.00	-11.97	-7.48	-6.75	-9.18	4.00	60.00	80.00	-23.73	-2.25	-16.25	-1.21	4.00	-11.69	-1.11	-6.10	-0.57	4.00	2.19	-3.09
60.00	90.00	-11.11	-11.06	-6.40	-5.88	4.00	60.00	90.00	-10.33	-0.65	-9.80	-1.16	4.00	-7.69	-0.27	-6.20	0.10	4.00	3.18	-2.27
60.00	100.00	-9.64	-18.31	-5.94	-5.80	4.00	60.00	100.00	-6.55	0.65	-7.99	-2.19	4.00	-4.82	0.70	-3.83	-0.62	4.00	4.17	-1.57
60.00	110.00	-7.61	-19.65	-4.32	-6.75	4.00	60.00	110.00	-3.77	0.88	-8.21	-1.96	4.00	-2.27	0.92	-2.83	-0.72	4.00	4.92	-0.97
60.00	120.00	-5.44	-11.32	-2.91	-5.91	4.00	60.00	120.00	-2.58	-0.31	-10.79	-1.07	4.00	-0.77	0.02	-2.25	0.16	4.00	5.36	-0.61
60.00	130.00	-4.77	-8.51	-1.96	-6.01	4.00	60.00	130.00	-1.78	-0.93	-9.86	-0.55	4.00	-0.01	-0.23	-1.31	0.54	4.00	5.79	-0.20
60.00	140.00	-3.81	-3.64	-1.13	-18.58	4.00	60.00	140.00	-1.96	-2.92	-8.67	0.66	4.00	0.22	-0.25	-0.43	0.71	4.00	6.10	0.09
60.00	150.00	-3.27	-2.51	-0.09	-6.48	4.00	60.00	150.00	-2.95	-8.58	-13.69	-0.45	4.00	-0.10	-1.55	0.10	0.52	4.00	5.80	-0.19
60.00	160.00	-2.61	-3.53	1.09	-1.40	4.00	60.00	160.00	-2.85	-10.73	-22.44	-5.41	4.00	0.28	-2.77	1.11	-0.03	4.00	5.78	-0.13
60.00	170.00	-1.94	-5.07	1.38	-1.05	4.00	60.00	170.00	-4.41	-12.02	-20.14	-7.86	4.00	0.01	-4.27	1.41	-0.23	4.00	5.49	-0.33
60.00	180.00	-1.30	-5.64	0.68	-5.19	4.00	60.00	180.00	-4.54	-5.73	-14.62	-12.13	4.00	0.39	-2.67	0.81	-4.39	4.00	4.81	-0.97
60.00	190.00	-0.48	-3.96	-1.59	-3.62	4.00	60.00	190.00	-6.62	-6.00	-9.98	-8.62	4.00	0.47	-1.85	-1.00	-2.43	4.00	4.89	-1.06
60.00	200.00	-1.27	-4.97	-4.16	-6.42	4.00	60.00	200.00	-9.40	-8.66	-9.25	-8.13	4.00	-0.65	-3.42	-2.99	-4.18	4.00	3.31	-2.60
60.00	210.00	-2.84	-9.72	-4.89	-17.02	4.00	60.00	210.00	-12.90	-4.55	-13.64	-12.17	4.00	-2.43	-3.40	-4.35	-10.94	4.00	1.60	-4.33
60.00	220.00	-2.77	-12.63	-4.51	-11.48	4.00	60.00	220.00	-36.23	-1.36	-15.37	-7.03	4.00	-2.77	-1.05	-4.17	-5.70	4.00	2.77	-3.08
60.00	230.00	-2.53	-8.05	-5.15	-8.01	4.00	60.00	230.00	-22.66	-0.39	-12.82	-1.59	4.00	-2.49	0.30	-4.46	-0.70	4.00	4.37	-1.48
60.00	240.00	-3.41	-9.07	-6.31	-7.92	4.00	60.00	240.00	-13.31	-2.54	-13.27	0.41	4.00	-2.99	-1.67	-5.51	1.01	4.00	4.05	-1.67
60.00	250.00	-1.40	-12.14	-7.82	-8.97	4.00	60.00	250.00	-14.82	-3.94	-22.00	1.03	4.00	-1.21	-3.33	-7.66	1.44	4.00	3.94	-1.57
60.00	260.00	-1.16	-18.82	-7.69	-12.67	4.00	60.00	260.00	-26.02	-2.48	-19.69	1.40	4.00	-1.15	-2.38	-7.42	1.57	4.00	4.24	-1.31
60.00	270.00	-1.26	-22.21	-5.39	-20.29	4.00	60.00	270.00	-17.27	-2.08	-12.36	1.33	4.00	-1.15	-2.04	-4.59	1.36	4.00	4.67	-1.10
60.00	280.00	0.10	-8.30	-2.94	-12.47	4.00	60.00	280.00	-10.35	-3.19	-9.79	1.07	4.00	0.47	-2.02	-2.12	1.26	4.00	5.55	-0.35
60.00	290.00	-3.42	-5.75	-1.81	-6.51	4.00	60.00	290.00	-8.58	-4.45	-8.11	0.20	4.00	-2.26	-2.04	-0.90	1.04	4.00	5.08	-0.83
60.00	300.00	-1.16	-9.98	-0.52	-4.07	4.00	60.00	300.00	-4.99	-3.56	-8.08	-1.47	4.00	0.34	-2.67	0.18	0.43	4.00	5.68	-0.26
60.00	310.00	-0.27	-26.24	-0.98	-4.83	4.00	60.00	310.00	-4.65	-5.07	-10.81	-4.81	4.00	1.08	-5.04	-0.55	-1.81	4.00	4.72	-1.06
60.00	320.00	0.34	-16.40	0.12	-7.41	4.00	60.00	320.00	-3.45	-6.08	-10.05	-8.12	4.00	1.86	-5.69	0.52	-4.74	4.00	4.60	-0.88
60.00	330.00	-0.36	-8.94	-0.16	-10.73	4.00	60.00	330.00	-1.35	-5.30	-7.35	-13.71	4.00	2.18	-3.74	0.60	-8.96	4.00	4.52	-0.77
60.00	340.00	-1.07	-8.79	-1.13	-14.01	4.00	60.00	340.00	-2.24	-10.37	-7.51	-14.86	4.00	1.39	-6.50	-0.23	-11.40	4.00	3.20	-1.83
60.00	350.00	-1.63	-9.78	-0.45	-11.08	4.00	60.00	350.00	-0.63	-13.14	-8.45	-15.08	4.00	2.91	-8.13	0.19	-9.62	4.00	3.49	-1.46
75.00	0.00	0.91	-9.42	1.28	-7.05	4.00	75.00	0.00	-1.30	-13.05	-15.68	-13.71	4.00	1.95	-7.86	1.37	-6.20	4.00	4.79	-0.28
75.00	10.00	0.64	-8.38	0.49	-13.97	4.00	75.00	10.00	-0.94	-20.02	-14.03	-12.97	4.00	2.93	-8.09	0.64	-10.43	4.00	4.01	-0.75
75.00	20.00	-0.27	-15.90	0.65	-14.30	4.00	75.00	20.00	-1.21	-11.97	-12.38	-10.25	4.00	2.30	-10.49	0.86	-8.81	4.00	3.72	-1.06
75.00	30.																			



10500	0.00	-9.34	-1.79	-1.28	-7.71	4.00	10500	0.00	-1.24	-7.56	-21.87	-9.73	4.00	-0.61	-0.77	-1.24	-5.59	4.00	4.19	-1.65
10500	10.00	-7.35	-3.05	0.24	-7.27	4.00	10500	10.00	-1.19	-13.57	-11.44	-14.39	4.00	-0.25	-2.68	0.53	-6.50	4.00	4.20	-1.49
10500	20.00	-3.31	-7.53	0.26	-8.00	4.00	10500	20.00	0.38	-11.31	-9.97	-29.10	4.00	1.93	-6.01	0.65	-7.97	4.00	4.15	-1.06
10500	30.00	-0.34	-8.38	1.47	-20.99	4.00	10500	30.00	-0.36	-15.67	-6.61	-23.53	4.00	2.66	-7.64	2.10	-19.07	4.00	3.97	-0.40
10500	40.00	-1.41	-6.35	0.05	-16.66	4.00	10500	40.00	-0.02	-13.60	-4.18	-18.51	4.00	2.35	-5.60	1.44	-14.48	4.00	4.10	-0.68
10500	50.00	-2.86	-12.80	-3.47	-12.86	4.00	10500	50.00	-1.90	-10.36	-4.60	-12.28	4.00	0.66	-8.40	-0.99	-9.55	4.00	2.56	-2.57
10500	60.00	-2.9	-22.12	-3.96	-9.92	4.00	10500	60.00	-3.24	-1.39	-5.50	-8.10	4.00	-0.06	-1.35	-1.65	-5.91	4.00	4.04	-1.77
10500	70.00	-2.38	-21.95	-4.32	-18.48	4.00	10500	70.00	-5.32	0.97	-8.66	-15.86	4.00	-0.60	0.99	-2.96	-13.97	4.00	3.42	-1.75
10500	80.00	-2.41	-19.04	-4.04	-5.95	4.00	10500	80.00	-10.98	0.27	-6.82	-9.54	4.00	-1.84	0.32	-2.20	-4.37	4.00	4.15	-1.71
10500	90.00	-3.14	-23.18	-3.36	-6.62	4.00	10500	90.00	-22.32	-1.65	-6.32	-4.12	4.00	-3.09	-1.62	-1.58	-2.18	4.00	3.92	-2.08
10500	100.00	-4.1	-18.79	-5.19	-15.05	4.00	10500	100.00	-17.21	-2.38	-7.66	-5.80	4.00	-3.89	-2.28	-3.24	-5.31	4.00	2.41	-3.55
10500	110.00	-4.39	-11.62	-10.91	-19.42	4.00	10500	110.00	-12.2	-1.95	-7.68	-27.88	4.00	-3.72	-1.51	-5.99	-18.84	4.00	0.46	-4.57
10500	120.00	-4.79	-8.01	-7.92	-9.22	4.00	10500	120.00	-7.87	-4.14	-11.72	-4.39	4.00	-3.05	-2.65	-6.41	-3.16	4.00	2.33	-3.59
10500	130.00	-4.24	-6.13	-3.51	-6.53	4.00	10500	130.00	-5.26	-11.24	-16.01	-6.65	4.00	-1.71	-4.96	-3.27	-3.58	4.00	2.72	-3.23
10500	140.00	-3.70	-4.32	-3.81	-4.51	4.00	10500	140.00	-5.18	-14.71	-12.41	-13.92	4.00	-1.37	-3.94	-3.25	-4.04	4.00	2.94	-3.01
10500	150.00	-1.80	-4.41	-3.43	-4.66	4.00	10500	150.00	-6.19	-12.12	-15.63	-6.41	4.00	-0.45	-3.73	-3.18	-2.44	4.00	3.66	-2.26
10500	160.00	-3.18	-1.67	-1.81	-8.16	4.00	10500	160.00	-4.15	-35.50	-18.34	-15.58	4.00	-0.63	-1.67	-1.71	-7.44	4.00	3.53	-2.22
10500	170.00	-2.55	-2.23	-1.48	-2.74	4.00	10500	170.00	-5.42	-14.34	-24.81	-23.70	4.00	-0.74	-1.97	-1.46	-2.71	4.00	4.33	-1.66
10500	180.00	-4.54	-5.95	0.52	-3.20	4.00	10500	180.00	-5.89	-7.17	-14.74	-13.83	4.00	-2.15	-3.51	0.65	-2.84	4.00	4.21	-1.65
10500	190.00	-4.83	-5.90	-0.18	-3.60	4.00	10500	190.00	-7.27	-11.98	-10.27	-15.97	4.00	-2.87	-4.94	0.23	-3.36	4.00	3.49	-2.31
10500	200.00	-9.08	-10.74	-4.09	-3.15	4.00	10500	200.00	-5.94	-8.54	-8.20	-8.84	4.00	-4.22	-6.49	-2.67	-2.11	4.00	2.31	-3.57
10500	210.00	-6.79	-13.05	-6.09	-6.59	4.00	10500	210.00	-9.35	-7.87	-11.67	-11.68	4.00	-4.87	-6.72	-5.03	-5.42	4.00	0.54	-5.45
10500	220.00	-8.26	-18.39	-5.09	-6.76	4.00	10500	220.00	-19.67	-20.62	-6.83	-7.40	4.00	-7.96	-16.35	-2.86	-4.06	4.00	-0.45	-5.63
10500	230.00	-8.91	-10.53	-5.79	-7.98	4.00	10500	230.00	-13.91	-8.74	-7.60	-5.15	4.00	-7.72	-6.53	-3.59	-3.33	4.00	0.93	-4.90
10500	240.00	-12.82	-7.57	-13.39	-9.36	4.00	10500	240.00	-30.50	-14.89	-11.04	-2.08	4.00	-12.75	-6.83	-9.05	-1.34	4.00	-0.46	-5.53
10500	250.00	-16.89	-13.33	-10.67	-11.27	4.00	10500	250.00	-14.41	-9.22	-21.18	-0.43	4.00	-12.47	-7.80	-10.30	-0.09	4.00	-0.26	-4.89
10500	260.00	-10.09	-35.00	-4.20	-13.89	4.00	10500	260.00	-16.03	-3.85	-14.49	-0.05	4.00	-9.10	-3.85	-3.81	0.13	4.00	2.45	-3.05
10500	270.00	-8.57	-14.15	-1.31	-15.03	4.00	10500	270.00	-18.10	-3.21	-12.51	-0.15	4.00	-8.11	-2.87	-0.99	-0.01	4.00	3.53	-2.10
10500	280.00	-11.21	-16.64	-1.34	-15.25	4.00	10500	280.00	-8.28	-2.00	-13.84	-0.84	4.00	-6.49	-1.85	-1.10	-0.69	4.00	3.77	-2.03
10500	290.00	-22.08	-13.78	-1.71	-11.28	4.00	10500	290.00	-5.57	-0.78	-14.40	-1.13	4.00	-5.47	-0.57	-1.48	-0.73	4.00	4.17	-1.68
10500	300.00	-7.68	-10.49	-2.76	-7.02	4.00	10500	300.00	-8.85	-1.33	-10.49	-2.54	4.00	-5.22	-0.83	-2.08	-1.22	4.00	3.84	-2.04
10500	310.00	-5.41	-8.56	-2.76	-6.16	4.00	10500	310.00	-8.59	-0.21	-7.90	-3.85	4.00	-3.70	0.38	-1.60	-1.84	4.00	4.45	-1.45
10500	320.00	-5.67	-3.56	-0.98	-13.97	4.00	10500	320.00	-6.63	-4.88	-11.06	-3.60	4.00	-3.11	-1.16	-0.57	-3.22	4.00	4.08	-1.86
10500	330.00	-5.25	-4.65	-0.54	-10.20	4.00	10500	330.00	-3.17	-36.00	-16.74	-5.11	4.00	-1.08	-4.65	-0.44	-3.94	4.00	3.68	-2.16
10500	340.00	-8.51	-4.76	-3.28	-4.90	4.00	10500	340.00	-2.15	-14.74	-18.64	-7.49	4.00	-1.25	-4.34	-3.16	-2.99	4.00	3.16	-2.79
10500	350.00	-6.73	-3.46	-5.48	-6.00	4.00	10500	350.00	-3.38	-15.68	-17.46	-10.22	4.00	-1.73	-3.21	-5.21	-4.61	4.00	2.44	-3.48
12000	0.00	-5.43	-0.53	-2.22	-3.82	4.00	12000	0.00	-2.30	-9.90	-29.49	-16.34	4.00	-0.58	-0.05	-2.21	-3.58	4.00	4.52	-1.39
12000	10.00	-6.70	-1.62	-3.23	-1.95	4.00	12000	10.00	-3.37	-10.62	-10.36	-12.61	4.00	-1.71	-1.11	-2.46	-1.59	4.00	4.32	-1.69
12000	20.00	-5.13	-6.63	-1.17	-5.41	4.00	12000	20.00	-4.21	-12.70	-12.09	-5.92	4.00	-1.64	-5.67	-0.83	-2.65	4.00	3.51	-2.35
12000	30.00	-2.94	-9.48	-0.59	-2.35	4.00	12000	30.00	-3.66	-13.26	-9.05	-5.57	4.00	-0.27	-7.96	-0.01	-0.66	4.00	4.34	-1.31
12000	40.00	-3.01	-9.15	-1.18	-4.32	4.00	12000	40.00	-2.03	-5.70	-6.38	-6.21	4.00	0.52	-4.08	-0.03	-2.15	4.00	4.77	-1.08
12000	50.00	-2.87	-10.03	-2.20	-5.74	4.00	12000	50.00	-1.53	-5.09	-5.99	-6.03	4.00	0.86	-3.88	-0.68	-2.87	4.00	4.57	-1.25
12000	60.00	-0.74	-8.69	-8.63	-5.87	4.00	12000	60.00	-4.34	-4.96	-6.17	-4.03	4.00	0.83	-3.43	-4.22	-1.84	4.00	4.08	-1.71
12000	70.00	-0.49	-10.60	-6.40	-12.05	4.00	12000	70.00	-10.01	-1.68	-3.82	-9.39	4.00	-0.03	-1.16	-1.91	-7.51	4.00	3.79	-1.90
12000	80.00	-1.88	-21.22	-3.95	-10.88	4.00	12000	80.00	-17.96	-0.08	-4.28	-9.29	4.00	-1.77	-0.05	-1.10	-7.00	4.00	3.91	-1.82
12000	90.00	-3.64	-14.54	-4.27	-11.33	4.00	12000	90.00	-21.75	-0.73	-10.93	-6.73	4.00	-3.57	-0.55	-3.42	-5.44	4.00	2.95	-2.88
12000	100.00	-4.84	-9.37	-9.27	-11.73	4.00	12000	100.00	-17.20	-1.88	-11.97	-12.48	4.00	-4.59	-1.17	-8.71	-9.08	4.00	0.76	-4.65
12000	110.00	-6.11	-8.55	-24.15	-12.88	4.00	12000	110.00	-20.49	-3.82	-9.95	-13.50	4.00	-5.95	-2.56	-9.79	-10.17	4.00	-0.52	-5.98
12000	120.00	-8.61	-9.10	-9.73	-12.47	4.00	12000	120.00	-16.74	-7.70	-14.37	-6.85	4.00	-7.99	-5.33	-8.45	-5.80	4.00	-0.77	-6.69
12000	130.00	-7.49	-9.97	-4.56	-7.25	4.00	12000	130.00	-9.06	-10.55	-15.61	-11.60	4.00	-5.19	-7.24	-4.23	-5.89	4.00	0.45	-5.50
12000	140.00	-7.45	-10.00	-6.94	-5.37	4.00	12000	140.00	-5.83	-15.70	-18.65	-27.97	4.00	-3.55	-8.96	-6.66	-5.35	4.00	0.11	-5.70
12000	150.00	-7.38	-7.23	-7.96	-10.17	4.00	12000	150.00	-9.72	-23.22	-16.68	-21.73	4.00	-5.38	-7.12	-7.41	-9.88	4.00	-1.28	-7.17
12000	160.00	-5.92	-8.31	-3.69	-9.60	4.00	12000	160.00	-7.47	-15.69	-17.16	-14.84	4.00	-3.62	-7.58	-3.50	-8.46	4.00	0.52	-5.23
12000	170.00	-6.96	-6.36	-4.96	-5.56	4.00	12000	170.00	-8.31	-11.61	-28.08	-21.39	4.00	-4.57	-5.23	-4.94	-5.45	4.00	0.98	-5.03
12000	180.00	-10.62	-7.02	-4.18	-9.33	4.00	12000	180.00	-5.48	-11.98	-19.53	-10.16	4.00	-4.32	-5.82	-4.06	-6.71	4.00	0.86	-5.09
12000	190.00	-13.08	-2.99	-5.45	-15.29	4.00	12000	190.00	-10.22	-10.55	-11.17	-17.28	4.00	-8.41	-2.29	-4.42	-13.16	4.00	-0.13	-5.43
12000	200.00	-12.83	-4.68	-13.63	-8.96	4.00	12000	200.00	-9.37	-7.37	-9.76	-14.26	4.00	-7.75	-2.81	-8.27	-7.84	4.00	-0.33	-6.00
12000	210.00	-11.79	-4.65	-9.95	-12.47	4.00	12000	210.00	-11.62	-17.23	-19.22	-16.87	4.00	-8.69	-4.42	-9.46	-11.37	4.00	-2.07	-7.68
12000	220.00	-14.81	-6.84	-7.65	-8.19	4.00	12000	220.00	-17.18	-9.49	-11.64	-16.95	4.00	-12.82	-4.96	-6.19	-7.65	4.00	-1.42	-7.08
12000	230.00	-17.41	-10.03	-6.71	-7.83	4.00	12000	230.00	-13.98	-10.43	-25.31	-11.60	4.00	-12.35	-7.22	-6.65	-6.31	4.00	-1.80	-7.58
12000	240.00	-18.35	-16.01	-18.03	-6.50	4.00	12000	240.00	-10.97	-14.88	-16.95	-3.79	4.00	-10.24	-12.40	-14.45				



150.00	220.00	-21.69	-11.30	-17.89	-14.81	4.00	150.00	220.00	-13.93	-12.10	-22.20	-6.90	4.00
150.00	230.00	-26.53	-14.26	-26.22	-16.45	4.00	150.00	230.00	-13.05	-17.17	-25.41	-4.64	4.00
150.00	240.00	-19.89	-26.55	-20.68	-17.41	4.00	150.00	240.00	-13.11	-19.81	-17.39	-3.98	4.00
150.00	250.00	-14.89	-25.65	-18.78	-16.12	4.00	150.00	250.00	-14.70	-12.53	-13.25	-4.97	4.00
150.00	260.00	-14.90	-29.58	-17.20	-12.31	4.00	150.00	260.00	-16.09	-13.27	-12.41	-5.63	4.00
150.00	270.00	-15.70	-24.96	-15.20	-9.97	4.00	150.00	270.00	-12.44	-9.68	-12.09	-6.51	4.00
150.00	280.00	-18.63	-12.85	-13.24	-10.20	4.00	150.00	280.00	-11.17	-2.01	-15.64	-8.50	4.00
150.00	290.00	-15.07	-7.35	-13.17	-11.42	4.00	150.00	290.00	-11.53	0.57	-18.73	-9.28	4.00
150.00	300.00	-12.63	-4.31	-14.68	-9.84	4.00	150.00	300.00	-12.24	1.09	-22.71	-9.04	4.00
150.00	310.00	-14.08	-2.29	-9.89	-7.31	4.00	150.00	310.00	-9.06	0.30	-22.44	-8.15	4.00
150.00	320.00	-15.03	-1.08	-9.16	-4.93	4.00	150.00	320.00	-8.24	-0.42	-27.76	-8.60	4.00
150.00	330.00	-10.33	-0.97	-15.99	-3.98	4.00	150.00	330.00	-10.86	-0.56	-22.00	-14.94	4.00
150.00	340.00	-5.55	-1.01	-15.15	-6.71	4.00	150.00	340.00	-18.76	-2.52	-15.33	-17.61	4.00
150.00	350.00	-4.99	-0.44	-16.54	-10.96	4.00	150.00	350.00	-13.85	-5.51	-15.58	-16.07	4.00
165.00	0.00	-10.41	0.34	-6.33	-3.13	4.00	165.00	0.00	-8.09	-2.48	-16.56	-13.70	4.00
165.00	10.00	-9.10	-0.29	-5.61	-4.35	4.00	165.00	10.00	-6.87	-2.00	-19.04	-12.68	4.00
165.00	20.00	-6.90	-2.76	-6.24	-8.11	4.00	165.00	20.00	-6.08	-0.39	-17.69	-12.63	4.00
165.00	30.00	-6.74	-8.52	-7.40	-9.84	4.00	165.00	30.00	-5.36	-0.60	-14.21	-16.35	4.00
165.00	40.00	-7.13	-17.01	-7.76	-10.40	4.00	165.00	40.00	-5.63	-1.67	-9.59	-14.84	4.00
165.00	50.00	-5.71	-20.30	-8.24	-8.98	4.00	165.00	50.00	-5.94	-3.94	-10.16	-17.11	4.00
165.00	60.00	-6.05	-15.74	-7.31	-9.94	4.00	165.00	60.00	-6.99	-7.00	-10.29	-13.50	4.00
165.00	70.00	-5.47	-20.03	-7.04	-11.35	4.00	165.00	70.00	-7.99	-7.82	-10.42	-11.32	4.00
165.00	80.00	-5.65	-22.50	-8.85	-14.25	4.00	165.00	80.00	-8.27	-6.17	-11.39	-8.53	4.00
165.00	90.00	-6.97	-17.22	-10.72	-20.38	4.00	165.00	90.00	-7.83	-3.93	-11.94	-7.03	4.00
165.00	100.00	-8.69	-12.93	-11.72	-22.66	4.00	165.00	100.00	-8.19	-5.00	-11.88	-7.50	4.00
165.00	110.00	-12.62	-10.58	-13.69	-14.04	4.00	165.00	110.00	-8.34	-7.64	-10.06	-8.82	4.00
165.00	120.00	-19.81	-11.36	-12.68	-12.21	4.00	165.00	120.00	-9.49	-14.73	-9.11	-10.51	4.00
165.00	130.00	-25.30	-8.93	-11.23	-11.50	4.00	165.00	130.00	-13.87	-20.14	-11.33	-11.48	4.00
165.00	140.00	-25.36	-6.58	-10.39	-11.48	4.00	165.00	140.00	-17.58	-13.86	-14.69	-15.44	4.00
165.00	150.00	-27.20	-4.02	-10.96	-7.60	4.00	165.00	150.00	-17.98	-17.95	-17.15	-21.52	4.00
165.00	160.00	-20.05	-2.78	-12.59	-4.58	4.00	165.00	160.00	-18.33	-20.33	-19.92	-14.41	4.00
165.00	170.00	-19.76	-4.39	-10.73	-4.25	4.00	165.00	170.00	-19.04	-14.25	-19.06	-11.13	4.00
165.00	180.00	-14.16	-5.96	-15.01	-7.19	4.00	165.00	180.00	-17.47	-16.33	-15.14	-14.65	4.00
165.00	190.00	-15.04	-5.82	-18.92	-9.85	4.00	165.00	190.00	-14.05	-29.56	-14.93	-25.30	4.00
165.00	200.00	-18.03	-8.79	-23.82	-7.06	4.00	165.00	200.00	-11.28	-19.76	-15.83	-16.03	4.00
165.00	210.00	-21.56	-18.64	-29.24	-7.29	4.00	165.00	210.00	-12.39	-17.89	-14.16	-12.00	4.00
165.00	220.00	-22.20	-16.64	-19.63	-6.53	4.00	165.00	220.00	-13.14	-15.78	-15.38	-8.08	4.00
165.00	230.00	-23.19	-13.43	-17.54	-6.26	4.00	165.00	230.00	-11.04	-10.61	-13.92	-5.00	4.00
165.00	240.00	-17.95	-12.50	-12.88	-8.75	4.00	165.00	240.00	-10.24	-7.76	-12.40	-3.75	4.00
165.00	250.00	-10.25	-15.47	-12.21	-13.63	4.00	165.00	250.00	-11.55	-7.24	-11.83	-3.26	4.00
165.00	260.00	-8.72	-16.91	-11.73	-15.05	4.00	165.00	260.00	-12.99	-8.17	-11.43	-4.04	4.00
165.00	270.00	-7.84	-12.90	-10.50	-11.69	4.00	165.00	270.00	-11.20	-10.96	-12.03	-6.49	4.00
165.00	280.00	-9.08	-12.97	-9.43	-9.24	4.00	165.00	280.00	-9.35	-14.20	-11.17	-11.84	4.00
165.00	290.00	-10.62	-10.68	-10.01	-7.68	4.00	165.00	290.00	-8.79	-10.61	-11.32	-35.97	4.00
165.00	300.00	-12.62	-9.17	-10.94	-6.59	4.00	165.00	300.00	-8.50	-7.04	-12.80	-14.67	4.00
165.00	310.00	-14.76	-7.41	-9.75	-5.48	4.00	165.00	310.00	-8.04	-5.51	-15.17	-12.30	4.00
165.00	320.00	-16.00	-3.51	-9.13	-4.90	4.00	165.00	320.00	-9.84	-4.11	-16.29	-14.49	4.00
165.00	330.00	-14.00	-1.44	-9.84	-5.37	4.00	165.00	330.00	-11.63	-4.34	-21.17	-17.45	4.00
165.00	340.00	-12.46	0.29	-9.10	-4.65	4.00	165.00	340.00	-10.47	-5.36	-24.47	-16.52	4.00
165.00	350.00	-10.57	0.74	-7.98	-4.49	4.00	165.00	350.00	-8.62	-4.77	-23.44	-14.23	4.00
180.00	0.00	-6.87	-11.94	-17.64	-7.01	4.00	180.00	0.00	-11.28	-17.99	-16.62	-10.28	4.00
180.00	10.00	-6.12	-11.34	-16.20	-6.15	4.00	180.00	10.00	-14.42	-21.92	-18.24	-12.99	4.00
180.00	20.00	-5.69	-11.03	-15.20	-5.61	4.00	180.00	20.00	-19.88	-29.94	-20.56	-17.37	4.00
180.00	30.00	-5.53	-10.99	-14.54	-5.36	4.00	180.00	30.00	-40.36	-35.18	-24.13	-27.48	4.00
180.00	40.00	-5.63	-11.22	-14.18	-5.37	4.00	180.00	40.00	-21.67	-23.59	-30.86	-25.67	4.00
180.00	50.00	-6.01	-11.73	-14.09	-5.66	4.00	180.00	50.00	-15.29	-18.95	-44.84	-16.78	4.00
180.00	60.00	-6.68	-12.56	-14.27	-6.23	4.00	180.00	60.00	-11.82	-16.13	-27.98	-12.65	4.00
180.00	70.00	-7.71	-13.77	-14.73	-7.12	4.00	180.00	70.00	-9.55	-14.21	-22.75	-10.05	4.00
180.00	80.00	-9.18	-15.49	-15.49	-8.42	4.00	180.00	80.00	-7.97	-12.87	-19.69	-8.27	4.00
180.00	90.00	-11.28	-17.99	-16.62	-10.28	4.00	180.00	90.00	-6.87	-11.94	-17.64	-7.01	4.00
180.00	100.00	-14.42	-21.92	-18.24	-12.99	4.00	180.00	100.00	-6.12	-11.34	-16.20	-6.15	4.00
180.00	110.00	-19.88	-29.94	-20.56	-17.37	4.00	180.00	110.00	-5.69	-11.03	-15.20	-5.61	4.00
180.00	120.00	-40.36	-35.18	-24.13	-27.48	4.00	180.00	120.00	-5.53	-10.99	-14.54	-5.36	4.00
180.00	130.00	-21.67	-23.59	-30.86	-25.67	4.00	180.00	130.00	-5.63	-11.22	-14.18	-5.37	4.00
180.00	140.00	-15.29	-18.95	-44.84	-16.78	4.00	180.00	140.00	-6.01	-11.73	-14.09	-5.66	4.00
180.00	150.00	-11.82	-16.13	-27.98	-12.65	4.00	180.00	150.00	-6.68	-12.56	-14.27	-6.23	4.00
180.00	160.00	-9.55	-14.21	-22.75	-10.05	4.00	180.00	160.00	-7.71	-13.77	-14.73	-7.12	4.00
180.00	170.00	-7.97	-12.87	-19.69	-8.27	4.00	180.00	170.00	-9.18	-15.49	-15.49	-8.42	4.00
180.00	180.00	-6.87	-11.94	-17.64	-7.01	4.00	180.00	180.00	-11.28	-17.99	-16.62	-10.28	4.00
180.00	190.00	-6.12	-11.34	-16.20	-6.15	4.00	180.00	190.00	-14.42	-21.92	-18.24	-12.99	4.00
180.00	200.00	-5.69	-11.03	-15.20	-5.61	4.00	180.00	200.00	-19.88	-29.94	-20.56	-17.37	4.00
180.00	210.00	-5.53	-10.99	-14.54	-5.36	4.00	180.00	210.00	-40.36	-35.18	-24.13	-27.48	4.00
180.00	220.00	-5.63	-11.22	-14.18	-5.37	4.00	180.00	220.00	-21.67	-23.59	-30.86	-25.67	4.00
180.00	230.00	-6.01	-11.73	-14.09	-5.66	4.00	180.00	230.00	-15.29	-18.95	-44.84	-16.78	4.00
180.00	240.00	-6.68	-12.56	-14.27	-6.23	4.00	180.00	240.00	-11.82	-16.13	-27.98	-12.65	4.00
180.00	250.00	-7.71	-13.77	-14.73	-7.12	4.00	180.00	250.00	-9.55	-14.21	-22.75	-10.05	4.00
180.00	260.00	-9.18	-15.49	-15.49	-8.42	4.00	180.00	260.00	-7.97	-12.87	-19.69	-8.27	4.00
180.00	270.00	-11.28	-17.99	-16.62	-10.28	4.00	180.00	270.00	-6.87	-11.94	-17.64	-7.01	4.00
180.00	280.00	-14.42	-21.92	-18.24	-12.99	4.00	180.00	280.00	-6.12	-11.34	-16.20	-6.15	4.00
180.00	290.00	-19.88	-29.94	-20.56	-17.37	4.00	180.00	290.00	-5.69	-11.03	-15.20	-5.61	4.00
180.00	300.00	-40.36	-35.18	-24.13	-27.48	4.00	180.00	300.00	-5.53	-10.99	-14.54	-5.36	4.00
180.00	310.00	-21.67	-23.59	-30.86	-25.67	4.00	180.00	310.00	-5.63	-11.22	-14.18	-5.37	4.00
180.00	320.00	-15.29	-18.95	-44.84	-16.78	4.00	180.00	320.00	-6.01	-11.73	-14.09	-5.66	4.00
180.00	330.00	-11.82	-16.13	-27.98	-12.65	4.00	180.00	330.00	-6.68	-12.56	-14.27	-6.23	4.00
180.00	340.00	-9.55	-14.21	-22.75	-10.05	4.00	180.00	340.00	-7.71	-13.77	-14.73	-7.12	4.00
180.00	350.00	-7.97	-12.87	-19.69	-8.27	4.00	180.00	350.00	-9.18	-15			



Frequency: 5260MHz

Theta Polarization		Max Gain(dBi)				Nant	Angle (θ)	Angle (ψ)	Phi Polarization				Nant	Total				Max DG(dB)	Max DG(dB)			
Angle (θ)	Angle (ψ)	Ant 1(G1)	Ant 2(G2)	Ant 3(G3)	Ant 4(G4)				Ant 1(G1)	Ant 2(G2)	Ant 3(G3)	Ant 4(G4)		Ant 1(G1)	Ant 2(G2)	Ant 3(G3)	Ant 4(G4)			Nant	7.20	1.62
		0.76	3.18	2.60	1.94				1.00	3.23	-2.10	2.70		3.51	3.67	2.61	4.03					
		Ant 1(G1)	Ant 2(G2)	Ant 3(G3)	Ant 4(G4)	Ant 1(G1)	Ant 2(G2)	Ant 3(G3)	Ant 4(G4)	Ant 1(G1)	Ant 2(G2)	Ant 3(G3)	Ant 4(G4)		glk	glk						
0.00	0.00	-22.68	3.10	-7.66	0.30	4.00	0.00	0.00	-7.29	-13.85	-11.68	-16.92	4.00	-7.17	3.19	-6.21	0.38	4.00	4.65	-0.45		
0.00	10.00	-16.63	3.18	-6.88	0.38	4.00	0.00	10.00	-7.69	-26.36	-14.66	-28.07	4.00	-7.17	3.18	-6.21	0.39	4.00	4.65	-0.45		
0.00	20.00	-13.28	2.99	-6.41	0.19	4.00	0.00	20.00	-8.39	-10.52	-19.71	-13.14	4.00	-7.17	3.18	-6.21	0.39	4.00	4.65	-0.45		
0.00	30.00	-11.07	2.53	-6.22	-0.28	4.00	0.00	30.00	-9.44	-5.38	-34.52	-8.08	4.00	-7.17	3.18	-6.21	0.39	4.00	4.65	-0.45		
0.00	40.00	-9.53	1.76	-6.29	-1.06	4.00	0.00	40.00	-10.94	-2.36	-23.56	-5.09	4.00	-7.17	3.18	-6.21	0.39	4.00	4.65	-0.45		
0.00	50.00	-8.45	0.62	-6.64	-2.22	4.00	0.00	50.00	-13.10	-0.32	-16.50	-3.08	4.00	-7.17	3.19	-6.21	0.38	4.00	4.65	-0.45		
0.00	60.00	-7.73	-1.01	-7.27	-3.86	4.00	0.00	60.00	-16.34	1.10	-12.83	-1.67	4.00	-7.17	3.18	-6.20	0.38	4.00	4.65	-0.45		
0.00	70.00	-7.31	-3.36	-8.25	-6.23	4.00	0.00	70.00	-22.08	2.09	-10.46	-0.68	4.00	-7.17	3.18	-6.21	0.39	4.00	4.65	-0.45		
0.00	80.00	-7.17	-6.98	-9.67	-9.89	4.00	0.00	80.00	-27.47	2.74	-8.82	-0.04	4.00	-7.17	3.18	-6.21	0.39	4.00	4.65	-0.45		
0.00	90.00	-7.29	-13.85	-11.68	-16.92	4.00	0.00	90.00	-22.68	3.10	-7.66	0.30	4.00	-7.17	3.19	-6.21	0.38	4.00	4.65	-0.45		
0.00	100.00	-7.69	-26.36	-14.66	-28.07	4.00	0.00	100.00	-16.63	3.18	-6.88	0.38	4.00	-7.17	3.18	-6.21	0.39	4.00	4.65	-0.45		
0.00	110.00	-8.39	-10.52	-19.71	-13.14	4.00	0.00	110.00	-13.28	2.99	-6.41	0.19	4.00	-7.17	3.18	-6.21	0.39	4.00	4.65	-0.45		
0.00	120.00	-9.44	-5.38	-34.52	-8.08	4.00	0.00	120.00	-11.07	2.53	-6.22	-0.28	4.00	-7.17	3.18	-6.21	0.39	4.00	4.65	-0.45		
0.00	130.00	-10.94	-2.36	-23.56	-5.09	4.00	0.00	130.00	-9.53	1.76	-6.29	-1.06	4.00	-7.17	3.18	-6.21	0.39	4.00	4.65	-0.45		
0.00	140.00	-13.10	-0.32	-16.50	-3.08	4.00	0.00	140.00	-8.45	0.62	-6.64	-2.22	4.00	-7.17	3.19	-6.21	0.38	4.00	4.65	-0.45		
0.00	150.00	-16.34	1.10	-12.83	-1.67	4.00	0.00	150.00	-7.73	-1.01	-7.27	-3.86	4.00	-7.17	3.18	-6.20	0.38	4.00	4.65	-0.45		
0.00	160.00	-22.08	2.09	-10.46	-0.68	4.00	0.00	160.00	-7.31	-3.36	-8.25	-6.23	4.00	-7.17	3.18	-6.21	0.39	4.00	4.65	-0.45		
0.00	170.00	-27.47	2.74	-8.82	-0.04	4.00	0.00	170.00	-7.17	-6.98	-9.67	-9.89	4.00	-7.17	3.18	-6.21	0.39	4.00	4.65	-0.45		
0.00	180.00	-22.68	3.10	-7.66	0.30	4.00	0.00	180.00	-7.29	-13.85	-11.68	-16.92	4.00	-7.17	3.19	-6.21	0.38	4.00	4.65	-0.45		
0.00	190.00	-16.63	3.18	-6.88	0.38	4.00	0.00	190.00	-7.69	-26.36	-14.66	-28.07	4.00	-7.17	3.18	-6.21	0.39	4.00	4.65	-0.45		
0.00	200.00	-13.28	2.99	-6.41	0.19	4.00	0.00	200.00	-8.39	-10.52	-19.71	-13.14	4.00	-7.17	3.18	-6.21	0.39	4.00	4.65	-0.45		
0.00	210.00	-11.07	2.53	-6.22	-0.28	4.00	0.00	210.00	-9.44	-5.38	-34.52	-8.08	4.00	-7.17	3.18	-6.21	0.39	4.00	4.65	-0.45		
0.00	220.00	-9.53	1.76	-6.29	-1.06	4.00	0.00	220.00	-10.94	-2.36	-23.56	-5.09	4.00	-7.17	3.18	-6.21	0.39	4.00	4.65	-0.45		
0.00	230.00	-8.45	0.62	-6.64	-2.22	4.00	0.00	230.00	-13.10	-0.32	-16.50	-3.08	4.00	-7.17	3.19	-6.21	0.38	4.00	4.65	-0.45		
0.00	240.00	-7.73	-1.01	-7.27	-3.86	4.00	0.00	240.00	-16.34	1.10	-12.83	-1.67	4.00	-7.17	3.18	-6.20	0.38	4.00	4.65	-0.45		
0.00	250.00	-7.31	-3.36	-8.25	-6.23	4.00	0.00	250.00	-22.08	2.09	-10.46	-0.68	4.00	-7.17	3.18	-6.21	0.39	4.00	4.65	-0.45		
0.00	260.00	-7.17	-6.98	-9.67	-9.89	4.00	0.00	260.00	-27.47	2.74	-8.82	-0.04	4.00	-7.17	3.18	-6.21	0.39	4.00	4.65	-0.45		
0.00	270.00	-7.29	-13.85	-11.68	-16.92	4.00	0.00	270.00	-22.68	3.10	-7.66	0.30	4.00	-7.17	3.19	-6.21	0.38	4.00	4.65	-0.45		
0.00	280.00	-7.69	-26.36	-14.66	-28.07	4.00	0.00	280.00	-16.63	3.18	-6.88	0.38	4.00	-7.17	3.18	-6.21	0.39	4.00	4.65	-0.45		
0.00	290.00	-8.39	-10.52	-19.71	-13.14	4.00	0.00	290.00	-13.28	2.99	-6.41	0.19	4.00	-7.17	3.18	-6.21	0.39	4.00	4.65	-0.45		
0.00	300.00	-9.44	-5.38	-34.52	-8.08	4.00	0.00	300.00	-11.07	2.53	-6.22	-0.28	4.00	-7.17	3.18	-6.21	0.39	4.00	4.65	-0.45		
0.00	310.00	-10.94	-2.36	-23.56	-5.09	4.00	0.00	310.00	-9.53	1.76	-6.29	-1.06	4.00	-7.17	3.18	-6.21	0.39	4.00	4.65	-0.45		
0.00	320.00	-13.10	-0.32	-16.50	-3.08	4.00	0.00	320.00	-8.45	0.62	-6.64	-2.22	4.00	-7.17	3.19	-6.21	0.38	4.00	4.65	-0.45		
0.00	330.00	-16.34	1.10	-12.83	-1.67	4.00	0.00	330.00	-7.73	-1.01	-7.27	-3.86	4.00	-7.17	3.18	-6.20	0.38	4.00	4.65	-0.45		
0.00	340.00	-22.08	2.09	-10.46	-0.68	4.00	0.00	340.00	-7.31	-3.36	-8.25	-6.23	4.00	-7.17	3.18	-6.21	0.39	4.00	4.65	-0.45		
0.00	350.00	-27.47	2.74	-8.82	-0.04	4.00	0.00	350.00	-7.17	-6.98	-9.67	-9.89	4.00	-7.17	3.18	-6.21	0.39	4.00	4.65	-0.45		
15.00	0.00	-3.66	1.58	-5.72	-0.62	4.00	15.00	0.00	-4.19	-16.86	-6.09	-18.84	4.00	-0.91	1.64	-2.89	-0.56	4.00	5.49	-0.38		
15.00	10.00	-4.80	1.81	-5.18	-0.35	4.00	15.00	10.00	-4.37	-17.69	-6.75	-12.17	4.00	-1.57	1.86	-2.88	-0.07	4.00	5.53	-0.30		
15.00	20.00	-10.65	1.89	-7.49	-0.69	4.00	15.00	20.00	-4.73	-11.28	-11.05	-7.85	4.00	-3.74	2.09	-5.90	0.07	4.00	4.71	-0.81		
15.00	30.00	-34.79	2.23	-8.43	-1.69	4.00	15.00	30.00	-4.38	-6.89	-11.89	-5.13	4.00	-4.38	2.73	-6.81	-0.07	4.00	4.67	-0.66		
15.00	40.00	-15.75	2.08	-8.27	-3.94	4.00	15.00	40.00	-5.52	-3.25	-9.00	-3.62	4.00	-5.13	3.20	-5.61	-0.77	4.00	4.71	-0.57		
15.00	50.00	-11.41	1.63	-7.04	-6.09	4.00	15.00	50.00	-8.18	-1.30	-12.25	-2.31	4.00	-6.49	3.42	-5.90	-0.79	4.00	4.55	-0.57		
15.00	60.00	-9.43	0.49	-6.70	-9.49	4.00	15.00	60.00	-12.05	0.42	-10.51	-0.55	4.00	-7.54	3.47	-5.19	-0.03	4.00	4.75	-0.35		
15.00	70.00	-7.56	-1.48	-6.28	-14.49	4.00	15.00	70.00	-19.34	1.83	-9.47	0.58	4.00	-7.28	3.49	-4.58	0.71	4.00	5.11	-0.06		
15.00	80.00	-7.54	-4.34	-6.11	-18.98	4.00	15.00	80.00	-22.04	2.74	-10.25	1.09	4.00	-7.39	3.52	-4.69	1.13	4.00	5.22	0.07		
15.00	90.00	-8.67	-9.12	-5.60	-12.17	4.00	15.00	90.00	-14.94	3.23	-11.18	1.14	4.00	-7.75	3.48	-4.54	1.34	4.00	5.25	0.11		
15.00	100.00	-9.85	-14.49	-4.90	-6.76	4.00	15.00	100.00	-11.39	3.20	-12.87	1.15	4.00	-7.54	3.27	-4.26	1.80	4.00	5.39	0.20		
15.00	110.00	-12.60	-9.97	-4.99	-3.47	4.00	15.00	110.00	-9.12	2.69	-15.47	0.57	4.00	-7.51	2.92	-4.62	2.01	4.00	5.27	0.08		
15.00	120.00	-18.88	-5.69	-4.78	-1.24	4.00	15.00	120.00	-7.50	1.98	-17.41	-0.16	4.00	-7.19	2.67	-4.55	2.34	4.00	5.34	0.11		
15.00	130.00	-30.67	-2.77	-5.33	-0.13	4.00	15.00	130.00	-7.29	0.98	-17.22	-1.53	4.00	-7.27	2.51	-5.06	2.24	4.00	5.15	-0.05		
15.00	140.00	-19.15	-1.49	-5.69	0.53	4.00	15.00	140.00	-6.73	-0.32	-14.87	-2.86	4.00	-6.49	2.14	-5.19	2.17	4.00	5.07	-0.21		
15.00	150.00	-12.98	-0.36	-5.97	0.71	4.00	15.00	150.00	-5.76	-1.47	-14.29	-5.09	4.00	-5.01	2.13	-5.37	1.72	4.00	5.10	-0.31		
15.00	160.00	-9.63	0.56	-5.91	0.94	4.00	15.00	160.00	-6.01	-3.89	-16.18	-6.99	4.00	-4.44	1.89	-5.52	1.59	4.00	5.04	-0.42		
15.00	170.00	-6.40	1.44	-6.78	1.17	4.00	15.00	170.00	-5.90	-5.85	-15.30	-8.70	4.00	-3.13	2.18	-6.21	1.60	4.00	5.28	-0.20		
15.00	180.00	-6.13	1.88	-6.80	1.57	4.00	15.00	180.00	-8.88	-11.34	-14.36	-9.44	4.00	-4.28	2.08	-6.10	1.90	4.00	5.16	-0.24		
15.00	190.00	-5.09	2.02	-7.73	1.08	4.00	15.00	190.00	-10.90	-18.33	-11.65	-7.81	4.00	-4.08	2.06	-6.25	1.61	4.00	5.06	-0.36		
15.00	200.00	-3.89	1.57	-8.39	0.16	4.00	15.00	200.00	-11.61	-9.10	-9.09	-6.61	4.00	-3.21	1.93	-5.72	0.99	4.00	5.05	-0.51		
15.00	210.00	-4.31	1.20	-9.38	-1.02	4.00	15.00	210.00	-14.23	-5.12	-7.78	-5.92	4.00	-3.89	2.11	-5.50	0.20	4.00	4.78	-0.75		
15.00	220.00																					



45.00	140.00	-4.80	-2.01	0.23	-1.30	4.00	45.00	140.00	-2.40	-1.56	-15.84	-1.76	4.00	-0.43	1.23	0.34	1.49	4.00	6.71	0.72
45.00	150.00	-3.18	0.22	0.84	-1.28	4.00	45.00	150.00	-2.89	-2.81	-18.00	-3.63	4.00	-0.02	1.97	0.90	0.71	4.00	6.94	0.95
45.00	160.00	-1.86	0.08	1.24	-2.42	4.00	45.00	160.00	-2.20	-4.42	-25.23	-5.07	4.00	0.98	1.40	1.25	-0.54	4.00	6.83	0.84
45.00	170.00	-0.22	-0.75	1.37	-1.90	4.00	45.00	170.00	-3.84	-6.43	-17.36	-6.45	4.00	1.35	0.29	1.43	-0.59	4.00	6.68	0.69
45.00	180.00	0.68	-0.06	0.99	-3.22	4.00	45.00	180.00	-5.99	-8.00	-12.60	-16.53	4.00	1.53	0.59	1.18	-3.02	4.00	6.26	0.39
45.00	190.00	0.76	-2.13	-0.54	-0.53	4.00	45.00	190.00	-7.21	-5.75	-7.81	-14.18	4.00	1.40	-0.56	0.21	-0.35	4.00	6.23	0.24
45.00	200.00	0.28	-3.52	-1.89	-0.64	4.00	45.00	200.00	-10.98	-7.80	-5.94	-6.81	4.00	0.59	-2.14	-0.45	0.30	4.00	5.66	-0.30
45.00	210.00	-0.41	-3.19	-3.37	-2.12	4.00	45.00	210.00	-9.61	-8.00	-6.79	-5.25	4.00	0.08	-1.95	-1.74	-0.40	4.00	5.06	-0.92
45.00	220.00	-1.72	-5.06	-3.69	-3.68	4.00	45.00	220.00	-11.96	-3.92	-11.30	-5.24	4.00	-1.33	-1.44	-3.00	-1.38	4.00	4.26	-1.73
45.00	230.00	-2.53	-9.62	-3.87	-3.34	4.00	45.00	230.00	-15.40	-2.16	-14.11	-1.41	4.00	-2.31	-1.44	-3.48	0.74	4.00	4.54	-1.34
45.00	240.00	-2.11	-14.18	-3.58	-5.04	4.00	45.00	240.00	-19.19	-2.26	-15.15	2.11	4.00	-2.03	-1.99	-3.29	2.88	4.00	5.26	-0.38
45.00	250.00	-1.84	-13.13	-4.51	-7.92	4.00	45.00	250.00	-17.53	-3.17	-16.00	2.70	4.00	-1.72	-2.75	-4.21	3.06	4.00	5.07	-0.45
45.00	260.00	-2.89	-11.49	-4.35	-12.60	4.00	45.00	260.00	-12.42	-3.50	-19.04	2.65	4.00	-2.43	-2.86	-4.20	2.78	4.00	4.78	-0.75
45.00	270.00	-4.01	-10.38	-4.75	-16.69	4.00	45.00	270.00	-8.36	-3.55	-26.82	2.16	4.00	-2.65	-2.73	-4.72	2.22	4.00	4.45	-1.14
45.00	280.00	-5.74	-10.33	-4.15	-14.60	4.00	45.00	280.00	-6.10	-4.40	-19.02	1.65	4.00	-2.91	-3.41	-4.01	1.75	4.00	4.20	-1.45
45.00	290.00	-3.40	-12.23	-2.81	-9.95	4.00	45.00	290.00	-6.28	-3.74	-13.01	0.41	4.00	-1.60	-3.16	-2.41	0.79	4.00	4.56	-1.32
45.00	300.00	-2.87	-11.82	-1.61	-8.02	4.00	45.00	300.00	-6.40	-1.73	-10.43	-1.26	4.00	-1.28	-1.32	-1.07	-0.43	4.00	5.00	-1.01
45.00	310.00	-1.84	-6.95	-0.08	-8.51	4.00	45.00	310.00	-4.67	-2.17	-7.75	-4.69	4.00	-0.02	-0.92	0.61	-3.18	4.00	5.26	-0.66
45.00	320.00	-1.81	-5.72	0.34	-6.20	4.00	45.00	320.00	-2.14	-2.35	-5.53	-8.29	4.00	1.04	-0.71	1.34	-4.11	4.00	5.66	-0.14
45.00	330.00	-1.22	-4.55	-0.26	-3.31	4.00	45.00	330.00	-1.82	-2.82	-4.52	-8.15	4.00	1.50	-0.59	1.12	-2.08	4.00	6.12	0.21
45.00	340.00	-0.85	-4.53	-0.57	-1.89	4.00	45.00	340.00	-2.00	-8.27	-4.84	-15.31	4.00	1.62	-3.00	0.81	-1.70	4.00	5.65	-0.18
45.00	350.00	-1.67	-4.12	-1.45	-2.85	4.00	45.00	350.00	-0.21	-10.35	-6.63	-18.04	4.00	2.13	-3.19	-0.30	-2.72	4.00	5.27	-0.48
60.00	0.00	-1.57	-6.97	1.34	-8.40	4.00	60.00	0.00	-1.06	-15.71	-10.62	-17.09	4.00	1.70	-6.43	1.61	-7.85	4.00	4.36	-0.81
60.00	10.00	-2.96	-5.19	1.10	-9.85	4.00	60.00	10.00	-1.49	-11.41	-11.72	-8.80	4.00	0.85	-4.26	1.32	-6.28	4.00	4.52	-0.99
60.00	20.00	-3.82	-6.69	0.10	-5.86	4.00	60.00	20.00	-2.21	-9.72	-12.37	-4.43	4.00	0.07	-4.94	0.34	-2.08	4.00	4.61	-1.19
60.00	30.00	-4.09	-5.33	0.53	-5.69	4.00	60.00	30.00	-3.56	-8.28	-12.82	-6.99	4.00	-0.81	-3.55	0.73	-3.28	4.00	4.48	-1.36
60.00	40.00	-5.59	-6.19	0.17	-10.39	4.00	60.00	40.00	-3.80	-4.82	-18.40	-5.17	4.00	-1.59	-2.44	0.23	-4.03	4.00	4.20	-1.69
60.00	50.00	-9.57	-5.89	-1.79	-15.53	4.00	60.00	50.00	-6.21	-4.18	-27.91	-3.06	4.00	-4.56	-1.94	-1.78	-2.82	4.00	3.31	-2.65
60.00	60.00	-13.80	-5.06	-3.68	-14.42	4.00	60.00	60.00	-10.34	-4.60	-35.08	-3.59	4.00	-8.72	-1.81	-3.68	-3.25	4.00	2.01	-3.73
60.00	70.00	-12.77	-5.73	-4.98	-16.76	4.00	60.00	70.00	-19.54	-4.28	-33.73	-2.66	4.00	-11.94	-3.20	-5.20	3.20	4.00	3.35	-1.35
60.00	80.00	-11.10	-7.69	-5.68	-10.90	4.00	60.00	80.00	-20.91	-3.05	-17.90	-1.96	4.00	-10.67	-1.77	-6.10	-1.44	4.00	1.77	-3.68
60.00	90.00	-10.28	-12.61	-5.55	-6.19	4.00	60.00	90.00	-10.76	-1.16	-11.42	-2.00	4.00	-7.50	-0.86	-6.20	-0.60	4.00	2.77	-2.78
60.00	100.00	-9.63	-21.03	-4.56	-6.71	4.00	60.00	100.00	-6.06	0.52	-8.68	-2.55	4.00	-4.48	0.55	-3.14	-1.14	4.00	4.18	-1.63
60.00	110.00	-7.26	-18.26	-3.52	-7.38	4.00	60.00	110.00	-4.15	0.78	-8.79	-2.20	4.00	-2.42	0.83	-2.39	-1.05	4.00	4.87	-1.04
60.00	120.00	-5.92	-10.51	-2.44	-6.27	4.00	60.00	120.00	-2.66	0.13	-11.12	-1.59	4.00	-0.98	0.25	-1.89	-0.32	4.00	5.32	-0.66
60.00	130.00	-4.70	-7.74	-1.42	-6.63	4.00	60.00	130.00	-1.95	-1.44	-10.11	-1.34	4.00	-0.10	-0.53	-0.87	-0.21	4.00	5.60	-0.42
60.00	140.00	-3.30	-4.01	-0.94	-24.20	4.00	60.00	140.00	-1.48	-2.64	-9.05	0.21	4.00	0.71	-0.26	-0.32	0.23	4.00	6.12	0.11
60.00	150.00	-3.11	-2.91	0.46	-6.21	4.00	60.00	150.00	-2.75	-9.14	-12.82	-0.98	4.00	0.08	-1.98	0.66	0.16	4.00	5.81	-0.16
60.00	160.00	-2.72	-4.51	1.46	-2.35	4.00	60.00	160.00	-2.59	-12.17	-21.79	-6.30	4.00	0.36	-3.82	1.48	-0.88	4.00	5.52	-0.31
60.00	170.00	-1.79	-5.22	1.90	-1.80	4.00	60.00	170.00	-3.69	-11.37	-18.97	-8.80	4.00	0.37	-4.28	1.94	-1.01	4.00	5.56	-0.20
60.00	180.00	-1.35	-5.52	1.06	-6.62	4.00	60.00	180.00	-4.73	-5.24	-13.08	-12.68	4.00	0.29	-2.37	1.22	-5.66	4.00	4.78	-0.91
60.00	190.00	-0.14	-4.90	-1.57	-3.83	4.00	60.00	190.00	-5.63	-6.23	-9.71	-9.51	4.00	0.94	-2.50	-0.95	-2.79	4.00	4.82	-1.06
60.00	200.00	-1.12	-5.96	-3.85	-7.20	4.00	60.00	200.00	-9.47	-10.08	-8.91	-9.28	4.00	-0.53	-4.54	-2.67	-5.11	4.00	3.00	-2.83
60.00	210.00	-2.50	-9.85	-4.52	-16.97	4.00	60.00	210.00	-11.35	-5.27	-12.30	-12.34	4.00	-1.97	-3.97	-3.85	-11.05	4.00	1.41	-4.18
60.00	220.00	-2.10	-12.03	-4.20	-11.09	4.00	60.00	220.00	-23.67	-1.87	-13.09	-6.71	4.00	-2.07	-1.47	-3.67	-5.36	4.00	3.01	-2.89
60.00	230.00	-2.75	-8.90	-4.64	-7.99	4.00	60.00	230.00	-22.71	-1.11	-11.66	-1.48	4.00	-2.71	-0.44	-3.85	-0.60	4.00	4.24	-1.67
60.00	240.00	-3.75	-10.17	-6.15	-7.70	4.00	60.00	240.00	-12.42	-2.51	-12.60	0.31	4.00	-3.20	-1.82	-5.26	0.95	4.00	3.98	-1.74
60.00	250.00	-1.46	-12.19	-7.91	-10.39	4.00	60.00	250.00	-14.59	-3.39	-21.57	0.79	4.00	-1.25	-2.85	-7.73	1.11	4.00	3.90	-1.66
60.00	260.00	-1.01	-18.54	-7.20	-11.83	4.00	60.00	260.00	-21.07	-2.37	-22.93	0.95	4.00	-0.97	-2.27	-7.09	1.17	4.00	4.22	-1.40
60.00	270.00	-1.91	-23.62	-5.54	-20.53	4.00	60.00	270.00	-14.74	-1.91	-12.86	0.53	4.00	-1.69	-1.88	-4.80	0.56	4.00	4.27	-1.56
60.00	280.00	-1.08	-8.13	-3.38	-10.77	4.00	60.00	280.00	-11.83	-3.27	-10.62	0.29	4.00	-0.73	-2.04	-2.63	0.62	4.00	4.92	-1.01
60.00	290.00	-4.60	-6.05	-2.73	-6.97	4.00	60.00	290.00	-8.57	-4.86	-9.33	-0.64	4.00	-3.14	-2.40	-1.87	0.27	4.00	4.33	-1.59
60.00	300.00	-1.69	-10.02	-1.16	-4.20	4.00	60.00	300.00	-5.59	-3.50	-8.40	-2.59	4.00	-0.21	-2.63	-0.41	-0.31	4.00	5.19	-0.78
60.00	310.00	-0.46	-24.36	-1.67	-5.94	4.00	60.00	310.00	-5.07	-4.58	-9.96	-6.44	4.00	0.83	-4.53	-1.07	-3.17	4.00	4.28	-1.51
60.00	320.00	-0.40	-16.03	-0.26	-8.17	4.00	60.00	320.00	-4.28	-5.06	-7.76	-10.85	4.00	1.09	-4.73	0.45	-6.30	4.00	4.22	-1.30
60.00	330.00	-0.81	-8.74	-0.43	-11.02	4.00	60.00	330.00	-2.11	-5.10	-7.06	-14.81	4.00	1.60	-3.54	0.42	-9.50	4.00	4.22	-1.10
60.00	340.00	-1.25	-9.63	-1.25	-11.99	4.00	60.00	340.00	-2.60	-11.56	-7.26	-15.44	4.00	1.14	-7.48	-0.28	-10.37	4.00	3.03	-2.03
60.00	350.00	-1.73	-10.99	-0.74	-11.12	4.00	60.00	350.00	-1.31	-13.55	-9.00	-15.15	4.00	1.50	-9.07	-0.14	-9.67	4.00	3.08	-1.85
75.00	0.00	0.02	-10.21	0.47	-7.64	4.00	75.00	0.00	-1.37	-13.57	-15.65	-16.45	4.00	2.39	-8.56	0.57	-7.10	4.00	4.08	-0.96
75.00	10.00	0.05	-8.83	-0.50	-13.09	4.00	75.00	10.00	-1.08	-17.61	-15.74	-12.22	4.00	2.53	-8.29	-0.37	-9.62	4.00	3.56	-1.30
75.00	20.00	-0.73	-16.51	-0.25	-12.45	4.00	75.00	20.00	-1.57	-15.00	-13.53	-10.55	4.00	1.88	-12.68	-0.05	-8.39	4.00	3.07	-1.66
75.0																				



105.00	0.00	-11.44	-2.46	-1.60	-8.78	4.00	105.00	0.00	-1.86	-7.76	-18.04	-9.12	4.00	-1.41	-1.34	-1.50	-5.94	4.00	3.68	-2.18
105.00	10.00	-8.42	-4.07	-0.06	-8.87	4.00	105.00	10.00	-1.73	-12.97	-11.66	-13.22	4.00	-0.89	-3.54	0.23	-7.51	4.00	3.57	-2.06
105.00	20.00	-3.61	-8.19	-0.40	-8.76	4.00	105.00	20.00	-0.46	-11.77	-10.75	-27.17	4.00	1.25	-6.61	-0.02	-8.70	4.00	3.49	-1.73
105.00	30.00	-0.73	-8.14	0.44	-22.22	4.00	105.00	30.00	-0.21	-16.01	-7.65	-24.23	4.00	2.55	-7.48	1.07	-20.10	4.00	3.50	-0.88
105.00	40.00	-2.31	-7.13	-0.84	-19.56	4.00	105.00	40.00	-0.54	-14.08	-4.89	-20.85	4.00	1.67	-6.33	0.60	-17.15	4.00	3.24	-1.44
105.00	50.00	-3.42	-15.45	-4.85	-13.90	4.00	105.00	50.00	-2.01	-11.19	-4.58	-13.70	4.00	0.35	-9.81	-1.70	-10.79	4.00	1.85	-3.12
105.00	60.00	-2.87	-24.14	-4.81	-10.76	4.00	105.00	60.00	-3.19	-1.65	-5.25	-9.01	4.00	-0.02	-1.63	-2.01	-6.79	4.00	3.75	-2.00
105.00	70.00	-2.71	-21.88	-4.85	-17.95	4.00	105.00	70.00	-5.79	0.77	-10.44	-14.35	4.00	-0.97	0.79	-3.79	-12.78	4.00	3.12	-2.09
105.00	80.00	-2.98	-22.25	-4.25	-5.95	4.00	105.00	80.00	-11.08	-0.01	-7.65	-10.19	4.00	-2.35	0.02	-2.62	-4.56	4.00	3.79	-2.07
105.00	90.00	-3.65	-22.79	-3.98	-7.72	4.00	105.00	90.00	-17.15	-1.69	-6.59	-4.28	4.00	-3.46	-1.66	-2.08	-2.66	4.00	3.58	-2.41
105.00	100.00	-4.01	-18.14	-5.25	-15.77	4.00	105.00	100.00	-17.65	-2.49	-7.68	-6.12	4.00	-3.83	-2.37	-3.29	-5.67	4.00	2.31	-3.63
105.00	110.00	-4.37	-13.08	-10.57	-18.14	4.00	105.00	110.00	-12.87	-2.42	-8.25	-31.17	4.00	-3.80	-2.06	-6.25	-17.93	4.00	0.21	-4.91
105.00	120.00	-4.84	-8.39	-8.65	-9.52	4.00	105.00	120.00	-9.29	-5.05	-11.54	-5.04	4.00	-3.51	-3.40	-6.85	-3.72	4.00	1.76	-4.16
105.00	130.00	-4.40	-6.73	-4.16	-6.89	4.00	105.00	130.00	-5.60	-11.95	-16.66	-7.10	4.00	-1.95	-5.59	-3.92	-3.98	4.00	2.26	-3.67
105.00	140.00	-3.66	-5.13	-3.56	-4.31	4.00	105.00	140.00	-4.50	-14.31	-11.27	-13.86	4.00	-1.05	-4.63	-2.88	-3.85	4.00	3.02	-2.89
105.00	150.00	-2.18	-4.59	-3.88	-4.57	4.00	105.00	150.00	-6.45	-12.03	-19.04	-6.70	4.00	-0.80	-3.87	-3.75	-2.50	4.00	3.38	-2.54
105.00	160.00	-3.06	-1.78	-1.96	-8.48	4.00	105.00	160.00	-4.55	-23.08	-18.66	-14.88	4.00	-0.73	-1.75	-1.87	-7.58	4.00	3.41	-2.33
105.00	170.00	-3.22	-2.26	-1.37	-3.03	4.00	105.00	170.00	-5.63	-15.27	-26.25	-21.17	4.00	-1.25	-2.05	-1.36	-2.96	4.00	4.14	-1.85
105.00	180.00	-4.54	-6.29	0.71	-3.44	4.00	105.00	180.00	-6.15	-8.49	-15.89	-12.41	4.00	-2.26	-4.24	0.80	-2.92	4.00	4.07	-1.73
105.00	190.00	-5.01	-6.19	0.07	-3.69	4.00	105.00	190.00	-7.01	-12.54	-10.40	-15.23	4.00	-2.89	-5.28	0.44	-3.40	4.00	3.49	-2.26
105.00	200.00	-8.32	-12.51	-4.08	-4.08	4.00	105.00	200.00	-6.29	-9.19	-8.97	-9.45	4.00	-4.18	-7.53	-2.86	-2.97	4.00	1.83	-4.03
105.00	210.00	-6.91	-13.78	-6.29	-6.59	4.00	105.00	210.00	-9.19	-9.37	-12.12	-13.90	4.00	-4.89	-8.03	-5.28	-5.85	4.00	0.09	-5.86
105.00	220.00	-8.83	-18.12	-4.73	-6.65	4.00	105.00	220.00	-20.03	-25.84	-8.56	-8.51	4.00	-8.51	-17.44	-3.23	-4.47	4.00	-0.93	-6.06
105.00	230.00	-9.84	-9.91	-6.01	-8.11	4.00	105.00	230.00	-14.97	-9.08	-9.81	-5.60	4.00	-8.68	-6.46	-4.50	-3.67	4.00	0.40	-5.43
105.00	240.00	-14.38	-8.88	-11.67	-9.75	4.00	105.00	240.00	-30.03	-14.75	-12.44	-2.30	4.00	-14.26	-7.88	-9.03	-1.58	4.00	-0.99	-5.93
105.00	250.00	-19.90	-12.71	-11.56	-11.00	4.00	105.00	250.00	-14.94	-10.79	-31.63	-0.85	4.00	-13.74	-8.63	-11.52	-0.45	4.00	-0.96	-5.41
105.00	260.00	-10.50	-30.28	-4.21	-16.27	4.00	105.00	260.00	-17.56	-4.26	-15.29	-0.51	4.00	-9.72	-4.25	-3.88	-0.40	4.00	2.06	-3.46
105.00	270.00	-9.70	-14.04	-2.05	-16.37	4.00	105.00	270.00	-16.88	-2.73	-12.42	-0.76	4.00	-8.94	-2.42	-1.67	-0.64	4.00	3.13	-2.51
105.00	280.00	-12.51	-15.23	-1.69	-16.17	4.00	105.00	280.00	-8.97	-1.72	-13.56	-1.39	4.00	-7.38	-1.53	-1.42	-1.25	4.00	4.47	-2.30
105.00	290.00	-21.58	-13.83	-2.36	-11.07	4.00	105.00	290.00	-6.19	-1.12	-17.42	-1.29	4.00	-6.07	-0.89	-2.23	-0.86	4.00	3.75	-2.07
105.00	300.00	-7.63	-10.80	-3.85	-6.48	4.00	105.00	300.00	-9.19	-1.85	-11.86	-2.88	4.00	-5.33	-1.33	-3.21	-1.31	4.00	3.38	-2.50
105.00	310.00	-5.48	-9.05	-4.47	-5.59	4.00	105.00	310.00	-8.63	-1.04	-10.81	-4.74	4.00	-3.77	-0.40	-3.56	-2.13	4.00	3.66	-2.25
105.00	320.00	-6.70	-4.26	-2.15	-11.90	4.00	105.00	320.00	-6.91	-6.35	-11.57	-4.97	4.00	-3.79	-2.17	-1.68	-4.17	4.00	3.13	-2.83
105.00	330.00	-7.07	-5.08	-1.65	-11.09	4.00	105.00	330.00	-4.61	-30.55	-14.18	-5.92	4.00	-2.66	-5.07	-1.41	-4.77	4.00	2.68	-3.21
105.00	340.00	-9.74	-5.50	-3.93	-5.86	4.00	105.00	340.00	-2.76	-13.80	-19.71	-8.76	4.00	-1.97	-4.90	-3.82	-4.06	4.00	2.40	-3.55
105.00	350.00	-7.60	-3.42	-5.55	-6.61	4.00	105.00	350.00	-4.17	-19.64	-16.88	-9.57	4.00	-2.54	-3.32	-5.24	-4.83	4.00	2.11	-3.85
120.00	0.00	-5.77	-1.09	-3.75	-3.60	4.00	120.00	0.00	-2.61	-10.36	-28.85	-16.59	4.00	-0.90	-0.60	-3.74	-3.39	4.00	3.98	-1.93
120.00	10.00	-7.87	-1.52	-3.50	-2.58	4.00	120.00	10.00	-4.12	-10.19	-12.24	-14.47	4.00	-2.59	-0.97	-2.96	-2.31	4.00	3.85	-2.14
120.00	20.00	-5.43	-7.08	-1.73	-5.65	4.00	120.00	20.00	-4.80	-12.86	-14.27	-6.28	4.00	-2.09	-6.06	-1.49	-2.94	4.00	3.04	-2.84
120.00	30.00	-3.83	-10.17	-1.18	-3.18	4.00	120.00	30.00	-4.43	-13.49	-9.66	-5.93	4.00	-1.11	-8.51	-0.60	-1.33	4.00	3.65	-2.00
120.00	40.00	-4.46	-9.75	-2.43	-4.87	4.00	120.00	40.00	-2.61	-6.87	-7.48	-7.34	4.00	-0.43	-5.07	-1.25	-2.92	4.00	3.78	-2.08
120.00	50.00	-3.37	-11.66	-3.07	-7.37	4.00	120.00	50.00	-1.69	-7.60	-6.53	-6.83	4.00	0.56	-6.16	-1.45	-4.08	4.00	3.61	-2.07
120.00	60.00	-1.15	-10.12	-9.50	-6.55	4.00	120.00	60.00	-3.98	-5.75	-6.89	-4.43	4.00	0.67	-4.40	-4.99	-2.35	4.00	3.55	-2.17
120.00	70.00	-0.83	-11.36	-7.50	-12.15	4.00	120.00	70.00	-9.92	-2.02	-4.26	-9.58	4.00	-0.33	-1.54	-2.57	-7.67	4.00	3.40	-2.30
120.00	80.00	-2.10	-19.61	-3.96	-11.27	4.00	120.00	80.00	-17.07	-0.51	-4.44	-9.37	4.00	-1.96	-0.46	-1.18	-7.21	4.00	3.68	-2.06
120.00	90.00	-3.87	-15.78	-4.59	-11.51	4.00	120.00	90.00	-19.60	-0.81	-10.92	-7.64	4.00	-3.76	-0.67	-3.68	-6.15	4.00	2.68	-3.12
120.00	100.00	-5.19	-9.67	-9.26	-12.51	4.00	120.00	100.00	-17.48	-2.04	-17.49	-14.73	4.00	-4.94	-1.35	-8.65	-10.47	4.00	0.39	-4.95
120.00	110.00	-6.20	-8.28	-25.60	-12.58	4.00	120.00	110.00	-22.38	-4.06	-10.48	-13.23	4.00	-6.10	-2.67	-10.35	-9.88	4.00	-0.65	-6.10
120.00	120.00	-8.41	-9.38	-9.92	-12.45	4.00	120.00	120.00	-16.36	-8.00	-12.58	-7.33	4.00	-7.76	-5.63	-8.04	-6.17	4.00	-0.82	-6.78
120.00	130.00	-7.31	-9.38	-4.79	-7.45	4.00	120.00	130.00	-9.39	-11.57	-16.70	-11.86	4.00	-5.22	-7.33	-4.52	-6.11	4.00	0.29	-5.67
120.00	140.00	-7.50	-9.71	-5.82	-6.36	4.00	120.00	140.00	-7.01	-20.31	-26.00	-31.14	4.00	-4.24	-9.35	-5.78	-6.35	4.00	-0.22	-6.07
120.00	150.00	-7.86	-7.51	-8.03	-11.74	4.00	120.00	150.00	-8.91	-24.06	-18.13	-20.44	4.00	-5.34	-7.41	-7.63	-11.19	4.00	-1.63	-7.43
120.00	160.00	-6.96	-7.79	-3.45	-9.27	4.00	120.00	160.00	-8.78	-17.09	-18.92	-14.60	4.00	-4.77	-7.31	-3.33	-8.11	4.00	3.66	-5.46
120.00	170.00	-6.69	-6.75	-4.19	-5.60	4.00	120.00	170.00	-8.24	-10.95	-32.94	-20.29	4.00	-4.39	-5.35	-4.18	-5.45	4.00	1.20	-4.81
120.00	180.00	-10.05	-6.71	-3.94	-8.97	4.00	120.00	180.00	-5.88	-12.68	-18.69	-10.91	4.00	-4.47	-5.73	-3.80	-6.82	4.00	0.89	-5.05
120.00	190.00	-12.90	-3.88	-6.10	-15.42	4.00	120.00	190.00	-9.57	-11.05	-9.42	-17.85	4.00	-7.91	-3.12	-4.44	-13.46	4.00	-0.39	-5.79
120.00	200.00	-12.15	-5.19	-12.00	-10.51	4.00	120.00	200.00	-10.60	-7.83	-10.95	-15.32	4.00	-8.30	-3.30	-8.43	-9.27	4.00	-0.96	-6.59
120.00	210.00	-12.31	-5.01	-10.05	-12.77	4.00	120.00	210.00	-13.39	-15.38	-18.34	-15.37	4.00	-9.81	-4.63	-9.45	-10.87	4.00	-2.31	-7.93
120.00	220.00	-12.25	-7.47	-7.34	-7.76	4.00	120.00	220.00	-15.45	-8.57	-15.07	-23.92	4.00	-10.55	-4.97	-6.66	-7.66	4.00	-1.21	-7.03
120.00	230.00	-18.73	-10.23	-6.93	-7.29	4.00	120.00	230.00	-15.67	-10.72	-35.99	-10.39	4.00	-13.93	-7.46	-6.92	-5.56	4.00	-1.92	-7.56
120.00	240.00	-20.68	-																	



150.00	220.00	-20.98	-11.85	-20.15	-13.83	4.00	150.00	220.00	-14.61	-12.93	-21.93	-7.04	4.00
150.00	230.00	-22.83	-13.45	-33.87	-15.85	4.00	150.00	230.00	-13.22	-17.12	-20.57	-4.95	4.00
150.00	240.00	-21.28	-29.08	-26.53	-16.72	4.00	150.00	240.00	-15.24	-19.25	-15.41	-3.90	4.00
150.00	250.00	-14.90	-25.15	-25.17	-16.47	4.00	150.00	250.00	-16.45	-14.72	-13.28	-3.62	4.00
150.00	260.00	-14.05	-27.87	-19.69	-11.96	4.00	150.00	260.00	-16.69	-14.43	-13.80	-4.85	4.00
150.00	270.00	-15.72	-22.99	-15.64	-9.55	4.00	150.00	270.00	-13.04	-8.19	-16.04	-6.19	4.00
150.00	280.00	-17.09	-12.93	-15.21	-10.46	4.00	150.00	280.00	-10.70	-1.94	-18.77	-8.83	4.00
150.00	290.00	-15.45	-7.29	-14.20	-11.93	4.00	150.00	290.00	-11.37	0.50	-21.88	-9.86	4.00
150.00	300.00	-12.85	-4.32	-16.67	-10.74	4.00	150.00	300.00	-12.48	1.01	-20.75	-9.04	4.00
150.00	310.00	-13.38	-2.66	-10.47	-7.60	4.00	150.00	310.00	-9.64	0.00	-25.37	-7.58	4.00
150.00	320.00	-15.78	-1.48	-10.61	-5.18	4.00	150.00	320.00	-8.50	-0.74	-36.22	-8.87	4.00
150.00	330.00	-11.30	-0.74	-14.29	-3.88	4.00	150.00	330.00	-9.89	-1.03	-23.56	-12.84	4.00
150.00	340.00	-6.88	-0.82	-15.81	-6.52	4.00	150.00	340.00	-18.81	-2.40	-14.13	-17.47	4.00
150.00	350.00	-5.52	-0.41	-14.85	-9.74	4.00	150.00	350.00	-14.42	-6.02	-14.06	-15.18	4.00
165.00	0.00	-12.03	0.42	-7.84	-3.26	4.00	165.00	0.00	-7.50	-2.78	-15.57	-13.52	4.00
165.00	10.00	-10.74	-0.06	-6.52	-4.71	4.00	165.00	10.00	-7.86	-1.96	-16.17	-12.43	4.00
165.00	20.00	-8.43	-2.30	-7.33	-6.95	4.00	165.00	20.00	-6.83	-0.52	-23.94	-13.19	4.00
165.00	30.00	-7.63	-7.40	-8.77	-10.11	4.00	165.00	30.00	-6.99	-0.57	-14.98	-14.45	4.00
165.00	40.00	-7.91	-15.50	-9.20	-11.79	4.00	165.00	40.00	-6.57	-1.96	-10.82	-16.21	4.00
165.00	50.00	-6.76	-27.04	-9.55	-9.94	4.00	165.00	50.00	-6.60	-4.05	-10.93	-17.82	4.00
165.00	60.00	-7.17	-16.98	-8.35	-9.04	4.00	165.00	60.00	-6.81	-7.21	-11.31	-15.09	4.00
165.00	70.00	-6.80	-16.83	-8.61	-11.68	4.00	165.00	70.00	-7.31	-9.34	-11.35	-11.19	4.00
165.00	80.00	-6.59	-20.49	-9.18	-14.13	4.00	165.00	80.00	-8.56	-6.77	-11.71	-7.69	4.00
165.00	90.00	-7.23	-17.98	-10.90	-20.00	4.00	165.00	90.00	-7.94	-4.66	-13.04	-6.10	4.00
165.00	100.00	-9.66	-12.55	-12.10	-22.88	4.00	165.00	100.00	-8.04	-4.98	-12.23	-6.49	4.00
165.00	110.00	-14.47	-10.56	-13.16	-15.67	4.00	165.00	110.00	-8.60	-7.20	-11.41	-8.11	4.00
165.00	120.00	-22.79	-10.80	-13.31	-12.56	4.00	165.00	120.00	-9.77	-14.14	-10.51	-10.09	4.00
165.00	130.00	-24.55	-10.78	-12.06	-12.56	4.00	165.00	130.00	-13.27	-18.15	-10.96	-12.35	4.00
165.00	140.00	-22.45	-6.64	-12.22	-11.20	4.00	165.00	140.00	-18.59	-15.09	-12.45	-16.72	4.00
165.00	150.00	-23.84	-4.52	-12.38	-7.55	4.00	165.00	150.00	-19.12	-20.42	-18.59	-18.23	4.00
165.00	160.00	-20.85	-3.73	-12.36	-4.72	4.00	165.00	160.00	-24.54	-21.66	-17.68	-15.31	4.00
165.00	170.00	-17.96	-4.72	-14.21	-4.54	4.00	165.00	170.00	-20.63	-15.24	-17.84	-11.49	4.00
165.00	180.00	-16.24	-5.98	-16.14	-7.77	4.00	165.00	180.00	-15.68	-16.07	-18.97	-13.32	4.00
165.00	190.00	-13.94	-6.57	-20.47	-9.39	4.00	165.00	190.00	-16.55	-26.36	-16.17	-24.29	4.00
165.00	200.00	-15.58	-9.75	-21.33	-7.91	4.00	165.00	200.00	-12.92	-21.41	-15.67	-20.45	4.00
165.00	210.00	-21.41	-19.31	-42.66	-7.63	4.00	165.00	210.00	-12.42	-17.80	-15.08	-12.57	4.00
165.00	220.00	-25.73	-17.92	-21.13	-7.17	4.00	165.00	220.00	-12.84	-15.18	-16.97	-8.09	4.00
165.00	230.00	-27.35	-12.56	-17.30	-7.03	4.00	165.00	230.00	-11.61	-9.88	-15.78	-6.16	4.00
165.00	240.00	-17.74	-13.86	-14.23	-9.71	4.00	165.00	240.00	-11.10	-6.87	-14.34	-3.83	4.00
165.00	250.00	-11.95	-15.08	-11.65	-13.42	4.00	165.00	250.00	-13.11	-6.34	-12.78	-3.26	4.00
165.00	260.00	-9.35	-15.80	-11.54	-15.49	4.00	165.00	260.00	-13.35	-7.44	-11.77	-4.26	4.00
165.00	270.00	-7.67	-15.19	-11.26	-12.15	4.00	165.00	270.00	-12.95	-10.24	-11.94	-7.00	4.00
165.00	280.00	-10.11	-12.12	-11.26	-10.68	4.00	165.00	280.00	-9.70	-14.20	-12.31	-13.67	4.00
165.00	290.00	-12.12	-10.50	-11.43	-8.34	4.00	165.00	290.00	-9.33	-12.08	-11.84	-27.95	4.00
165.00	300.00	-13.28	-9.53	-11.87	-7.62	4.00	165.00	300.00	-8.36	-7.18	-13.16	-13.35	4.00
165.00	310.00	-15.02	-7.06	-12.06	-5.69	4.00	165.00	310.00	-7.92	-5.76	-15.34	-10.97	4.00
165.00	320.00	-18.11	-4.32	-10.35	-5.31	4.00	165.00	320.00	-10.30	-4.37	-16.71	-15.93	4.00
165.00	330.00	-14.23	-2.28	-11.19	-5.93	4.00	165.00	330.00	-10.48	-4.32	-21.11	-18.28	4.00
165.00	340.00	-12.00	-0.20	-9.64	-6.08	4.00	165.00	340.00	-11.01	-5.48	-23.32	-17.38	4.00
165.00	350.00	-11.57	0.57	-9.28	-4.86	4.00	165.00	350.00	-8.83	-4.50	-20.75	-13.92	4.00
180.00	0.00	-7.26	-11.47	-14.56	-7.55	4.00	180.00	0.00	-11.17	-16.52	-16.85	-12.18	4.00
180.00	10.00	-6.47	-10.78	-13.59	-6.83	4.00	180.00	10.00	-14.12	-19.94	-19.25	-15.42	4.00
180.00	20.00	-5.99	-10.40	-12.96	-6.41	4.00	180.00	20.00	-19.07	-26.20	-22.97	-21.14	4.00
180.00	30.00	-5.79	-10.28	-12.62	-6.27	4.00	180.00	30.00	-32.98	-47.50	-30.20	-46.27	4.00
180.00	40.00	-5.85	-10.44	-12.55	-6.39	4.00	180.00	40.00	-23.47	-24.84	-39.85	-21.82	4.00
180.00	50.00	-6.19	-10.87	-12.75	-6.79	4.00	180.00	50.00	-16.22	-19.28	-25.86	-15.75	4.00
180.00	60.00	-6.82	-11.60	-13.23	-7.48	4.00	180.00	60.00	-12.49	-16.10	-20.90	-12.39	4.00
180.00	70.00	-7.79	-12.70	-14.02	-8.53	4.00	180.00	70.00	-10.09	-13.98	-17.95	-10.18	4.00
180.00	80.00	-9.18	-14.27	-15.19	-10.04	4.00	180.00	80.00	-8.43	-12.50	-15.96	-8.63	4.00
180.00	90.00	-11.17	-16.52	-16.85	-12.18	4.00	180.00	90.00	-7.26	-11.47	-14.56	-7.55	4.00
180.00	100.00	-14.12	-19.94	-19.25	-15.42	4.00	180.00	100.00	-6.47	-10.78	-13.59	-6.83	4.00
180.00	110.00	-19.07	-26.20	-22.97	-21.14	4.00	180.00	110.00	-5.99	-10.40	-12.96	-6.41	4.00
180.00	120.00	-32.98	-47.50	-30.20	-46.27	4.00	180.00	120.00	-5.79	-10.28	-12.62	-6.27	4.00
180.00	130.00	-23.47	-24.84	-39.85	-21.82	4.00	180.00	130.00	-5.85	-10.44	-12.55	-6.39	4.00
180.00	140.00	-16.22	-19.28	-25.86	-15.75	4.00	180.00	140.00	-6.19	-10.87	-12.75	-6.79	4.00
180.00	150.00	-12.49	-16.10	-20.90	-12.39	4.00	180.00	150.00	-6.82	-11.60	-13.23	-7.48	4.00
180.00	160.00	-10.09	-13.98	-17.95	-10.18	4.00	180.00	160.00	-7.79	-12.70	-14.02	-8.53	4.00
180.00	170.00	-8.43	-12.50	-15.96	-8.63	4.00	180.00	170.00	-9.18	-14.27	-15.19	-10.04	4.00
180.00	180.00	-7.26	-11.47	-14.56	-7.55	4.00	180.00	180.00	-11.17	-16.52	-16.85	-12.18	4.00
180.00	190.00	-6.47	-10.78	-13.59	-6.83	4.00	180.00	190.00	-14.12	-19.94	-19.25	-15.42	4.00
180.00	200.00	-5.99	-10.40	-12.96	-6.41	4.00	180.00	200.00	-19.07	-26.20	-22.97	-21.14	4.00
180.00	210.00	-5.79	-10.28	-12.62	-6.27	4.00	180.00	210.00	-32.98	-47.50	-30.20	-46.27	4.00
180.00	220.00	-5.85	-10.44	-12.55	-6.39	4.00	180.00	220.00	-23.47	-24.84	-39.85	-21.82	4.00
180.00	230.00	-6.19	-10.87	-12.75	-6.79	4.00	180.00	230.00	-16.22	-19.28	-25.86	-15.75	4.00
180.00	240.00	-6.82	-11.60	-13.23	-7.48	4.00	180.00	240.00	-12.49	-16.10	-20.90	-12.39	4.00
180.00	250.00	-7.79	-12.70	-14.02	-8.53	4.00	180.00	250.00	-10.09	-13.98	-17.95	-10.18	4.00
180.00	260.00	-9.18	-14.27	-15.19	-10.04	4.00	180.00	260.00	-8.43	-12.50	-15.96	-8.63	4.00
180.00	270.00	-11.17	-16.52	-16.85	-12.18	4.00	180.00	270.00	-7.26	-11.47	-14.56	-7.55	4.00
180.00	280.00	-14.12	-19.94	-19.25	-15.42	4.00	180.00	280.00	-6.47	-10.78	-13.59	-6.83	4.00
180.00	290.00	-19.07	-26.20	-22.97	-21.14	4.00	180.00	290.00	-5.99	-10.40	-12.96	-6.41	4.00
180.00	300.00	-32.98	-47.50	-30.20	-46.27	4.00	180.00	300.00	-5.79	-10.28	-12.62	-6.27	4.00
180.00	310.00	-23.47	-24.84	-39.85	-21.82	4.00	180.00	310.00	-5.85	-10.44	-12.55	-6.39	4.00
180.00	320.00	-16.22	-19.28	-25.86	-15.75	4.00	180.00	320.00	-6.19	-10.87	-12.75	-6.79	4.00
180.00	330.00	-12.49	-16.10	-20.90	-12.39	4.00	180.00	330.00	-6.82	-11.60	-13.23	-7.48	4.00
180.00	340.00	-10.09	-13.98	-17.95	-10.18	4.00	180.00	340.00	-7.79	-12.70	-14.02	-8.53	4.00
180.00	350.00	-8.43	-12.50	-15.96	-8.63	4.00	180.00	350					



Frequency: 5300MHz

Angle (θ)		Theta Polarization				Nant	Angle (ψ)		Phi Polarization				Nant	Total				Nant	Max Dc(dBi)			
		Max Gain(dBi)							Max Gain(dBi)					Max Gain(dBi)					g/k	2θ		
		Ant 1(G1)	Ant 2(G2)	Ant 3(G3)	Ant 4(G4)				Ant 1(G1)	Ant 2(G2)	Ant 3(G3)	Ant 4(G4)		Ant 1(G1)	Ant 2(G2)	Ant 3(G3)	Ant 4(G4)				3.80	4.30
		1.26	3.62	3.57	2.45				1.32	3.82	-2.23	3.15		3.80	4.30	3.72	4.43		3.80	4.30	3.72	4.43
Ant 1(G1)	Ant 2(G2)	Ant 3(G3)	Ant 4(G4)	Ant 1(G1)	Ant 2(G2)	Ant 3(G3)	Ant 4(G4)	Ant 1(G1)	Ant 2(G2)	Ant 3(G3)	Ant 4(G4)	Ant 1(G1)	Ant 2(G2)	Ant 3(G3)	Ant 4(G4)	g/k	2θ					
0.00	0.00	-22.10	3.53	-8.61	0.94	4.00	0.00	0.00	-6.22	-13.26	-8.98	-15.99	4.00	-6.11	3.62	-5.78	1.03	4.00	5.23	0.08		
0.00	10.00	-15.80	3.82	-7.39	1.02	4.00	0.00	10.00	-6.60	-28.59	-10.88	-28.56	4.00	-6.11	3.62	-5.78	1.02	4.00	5.23	0.08		
0.00	20.00	-12.36	3.44	-6.55	0.84	4.00	0.00	20.00	-7.28	-10.19	-13.67	-12.69	4.00	-6.11	3.62	-5.78	1.03	4.00	5.23	0.09		
0.00	30.00	-10.10	2.98	-6.04	0.38	4.00	0.00	30.00	-8.31	-4.99	-18.24	-7.54	4.00	-6.10	3.62	-5.79	1.03	4.00	5.23	0.09		
0.00	40.00	-8.53	2.21	-5.80	-0.39	4.00	0.00	40.00	-9.79	-1.95	-29.37	-4.51	4.00	-6.10	3.62	-5.78	1.03	4.00	5.23	0.09		
0.00	50.00	-7.43	1.08	-5.83	-1.54	4.00	0.00	50.00	-11.90	0.09	-25.11	-2.48	4.00	-6.10	3.62	-5.78	1.03	4.00	5.23	0.09		
0.00	60.00	-6.69	-0.55	-6.14	-3.16	4.00	0.00	60.00	-15.07	1.53	-16.87	-1.05	4.00	-6.10	3.62	-5.79	1.03	4.00	5.23	0.09		
0.00	70.00	-6.26	-2.88	-6.73	-5.51	4.00	0.00	70.00	-20.59	2.52	-12.88	-0.06	4.00	-6.10	3.62	-5.79	1.03	4.00	5.23	0.08		
0.00	80.00	-6.11	-6.47	-7.65	-9.12	4.00	0.00	80.00	-42.44	3.18	-10.36	0.59	4.00	-6.11	3.63	-5.79	1.03	4.00	5.23	0.09		
0.00	90.00	-6.22	-13.26	-8.98	-15.99	4.00	0.00	90.00	-22.10	3.53	-8.61	0.94	4.00	-6.11	3.62	-5.78	1.03	4.00	5.23	0.08		
0.00	100.00	-6.60	-26.59	-10.88	-28.56	4.00	0.00	100.00	-15.80	3.62	-7.39	1.02	4.00	-6.11	3.62	-5.78	1.02	4.00	5.23	0.08		
0.00	110.00	-7.28	-10.19	-13.67	-12.69	4.00	0.00	110.00	-12.36	3.44	-6.55	0.84	4.00	-6.11	3.62	-5.78	1.03	4.00	5.23	0.09		
0.00	120.00	-8.31	-4.99	-18.24	-7.54	4.00	0.00	120.00	-10.10	2.98	-6.04	0.38	4.00	-6.10	3.62	-5.79	1.03	4.00	5.23	0.09		
0.00	130.00	-9.79	-1.95	-29.37	-4.51	4.00	0.00	130.00	-8.53	2.21	-5.80	-0.39	4.00	-6.10	3.62	-5.78	1.03	4.00	5.23	0.09		
0.00	140.00	-11.90	0.09	-25.11	-2.48	4.00	0.00	140.00	-7.43	1.08	-5.83	-1.54	4.00	-6.10	3.62	-5.78	1.03	4.00	5.23	0.09		
0.00	150.00	-15.07	1.53	-16.87	-1.05	4.00	0.00	150.00	-6.69	-0.55	-6.14	-3.16	4.00	-6.10	3.62	-5.79	1.03	4.00	5.23	0.09		
0.00	160.00	-20.59	2.52	-12.88	-0.06	4.00	0.00	160.00	-6.26	-2.88	-6.73	-5.51	4.00	-6.10	3.62	-5.79	1.03	4.00	5.23	0.08		
0.00	170.00	-42.44	3.18	-10.36	0.59	4.00	0.00	170.00	-6.11	-6.47	-7.65	-9.12	4.00	-6.11	3.63	-5.79	1.03	4.00	5.23	0.09		
0.00	180.00	-22.10	3.53	-8.61	0.94	4.00	0.00	180.00	-6.22	-13.26	-8.98	-15.99	4.00	-6.11	3.62	-5.78	1.03	4.00	5.23	0.08		
0.00	190.00	-15.80	3.62	-7.39	1.02	4.00	0.00	190.00	-6.60	-28.59	-10.88	-28.56	4.00	-6.11	3.62	-5.78	1.02	4.00	5.23	0.08		
0.00	200.00	-12.36	3.44	-6.55	0.84	4.00	0.00	200.00	-7.28	-10.19	-13.67	-12.69	4.00	-6.11	3.62	-5.78	1.03	4.00	5.23	0.09		
0.00	210.00	-10.10	2.98	-6.04	0.38	4.00	0.00	210.00	-8.31	-4.99	-18.24	-7.54	4.00	-6.10	3.62	-5.79	1.03	4.00	5.23	0.09		
0.00	220.00	-8.53	2.21	-5.80	-0.39	4.00	0.00	220.00	-9.79	-1.95	-29.37	-4.51	4.00	-6.10	3.62	-5.78	1.03	4.00	5.23	0.09		
0.00	230.00	-7.43	1.08	-5.83	-1.54	4.00	0.00	230.00	-11.90	0.09	-25.11	-2.48	4.00	-6.10	3.62	-5.79	1.03	4.00	5.23	0.09		
0.00	240.00	-6.69	-0.55	-6.14	-3.16	4.00	0.00	240.00	-15.07	1.53	-16.87	-1.05	4.00	-6.10	3.62	-5.79	1.03	4.00	5.23	0.09		
0.00	250.00	-6.26	-2.88	-6.73	-5.51	4.00	0.00	250.00	-20.59	2.52	-12.88	-0.06	4.00	-6.10	3.62	-5.79	1.03	4.00	5.23	0.08		
0.00	260.00	-6.11	-6.47	-7.65	-9.12	4.00	0.00	260.00	-42.44	3.18	-10.36	0.59	4.00	-6.11	3.63	-5.79	1.03	4.00	5.23	0.09		
0.00	270.00	-6.22	-13.26	-8.98	-15.99	4.00	0.00	270.00	-22.10	3.53	-8.61	0.94	4.00	-6.11	3.62	-5.78	1.03	4.00	5.23	0.08		
0.00	280.00	-6.60	-26.59	-10.88	-28.56	4.00	0.00	280.00	-15.80	3.62	-7.39	1.02	4.00	-6.11	3.62	-5.78	1.02	4.00	5.23	0.08		
0.00	290.00	-7.28	-10.19	-13.67	-12.69	4.00	0.00	290.00	-12.36	3.44	-6.55	0.84	4.00	-6.11	3.62	-5.78	1.03	4.00	5.23	0.09		
0.00	300.00	-8.31	-4.99	-18.24	-7.54	4.00	0.00	300.00	-10.10	2.98	-6.04	0.38	4.00	-6.10	3.62	-5.79	1.03	4.00	5.23	0.09		
0.00	310.00	-9.79	-1.95	-29.37	-4.51	4.00	0.00	310.00	-8.53	2.21	-5.80	-0.39	4.00	-6.10	3.62	-5.78	1.03	4.00	5.23	0.09		
0.00	320.00	-11.90	0.09	-25.11	-2.48	4.00	0.00	320.00	-7.43	1.08	-5.83	-1.54	4.00	-6.10	3.62	-5.78	1.03	4.00	5.23	0.09		
0.00	330.00	-15.07	1.53	-16.87	-1.05	4.00	0.00	330.00	-6.69	-0.55	-6.14	-3.16	4.00	-6.10	3.62	-5.79	1.03	4.00	5.23	0.09		
0.00	340.00	-20.59	2.52	-12.88	-0.06	4.00	0.00	340.00	-6.26	-2.88	-6.73	-5.51	4.00	-6.10	3.62	-5.79	1.03	4.00	5.23	0.08		
0.00	350.00	-42.44	3.18	-10.36	0.59	4.00	0.00	350.00	-6.11	-6.47	-7.65	-9.12	4.00	-6.11	3.63	-5.79	1.03	4.00	5.23	0.09		
15.00	0.00	-2.78	1.94	-5.59	-0.21	4.00	15.00	0.00	-4.04	-15.02	-4.45	-26.42	4.00	-0.35	2.03	-1.97	-0.20	4.00	6.01	0.11		
15.00	10.00	-4.05	2.48	-4.70	0.10	4.00	15.00	10.00	-4.35	-17.82	-5.23	-13.74	4.00	-1.19	2.52	-1.95	-0.28	4.00	6.11	0.27		
15.00	20.00	-8.75	2.89	-6.43	-0.18	4.00	15.00	20.00	-3.41	-9.02	-9.85	-6.98	4.00	-2.30	3.16	-4.80	0.64	4.00	5.71	0.16		
15.00	30.00	-28.03	3.04	-6.43	-1.12	4.00	15.00	30.00	-3.21	-4.41	-11.93	-3.94	4.00	-3.20	3.76	-5.35	0.71	4.00	5.71	0.34		
15.00	40.00	-17.47	2.82	-6.65	-3.17	4.00	15.00	40.00	-2.26	-11.03	-7.26	-11.03	4.00	-4.50	3.99	-5.30	0.04	4.00	5.41	0.18		
15.00	50.00	-9.64	2.24	-5.43	-5.03	4.00	15.00	50.00	-7.61	-0.09	-13.52	-1.29	4.00	-5.50	4.24	-4.80	0.24	4.00	5.49	0.34		
15.00	60.00	-7.87	1.14	-5.81	-8.81	4.00	15.00	60.00	-11.85	1.44	-11.84	-0.12	4.00	-6.41	4.30	-4.84	0.43	4.00	5.44	0.37		
15.00	70.00	-6.61	-0.38	-5.30	-14.51	4.00	15.00	70.00	-16.33	2.38	-9.90	0.79	4.00	-6.17	4.23	-4.01	0.92	4.00	5.71	0.53		
15.00	80.00	-7.75	-3.21	-4.78	-24.68	4.00	15.00	80.00	-20.14	3.11	-10.22	1.36	4.00	-7.51	4.02	-3.69	1.17	4.00	5.65	0.51		
15.00	90.00	-8.35	-7.59	-5.09	-11.18	4.00	15.00	90.00	-14.51	3.73	-10.09	1.74	4.00	-7.41	4.04	-3.90	1.96	4.00	5.82	0.69		
15.00	100.00	-9.83	-13.02	-4.07	-6.55	4.00	15.00	100.00	-11.70	3.82	-13.52	1.64	4.00	-7.65	3.91	-3.60	2.25	4.00	5.89	0.74		
15.00	110.00	-12.49	-9.07	-4.07	-3.23	4.00	15.00	110.00	-9.31	3.57	-14.47	1.24	4.00	-7.60	3.89	-3.69	2.57	4.00	5.94	0.80		
15.00	120.00	-18.51	-4.25	-4.56	-0.93	4.00	15.00	120.00	-7.29	2.93	-15.53	0.54	4.00	-6.97	3.69	-4.23	2.88	4.00	5.99	0.84		
15.00	130.00	-30.48	-1.69	-4.47	-0.08	4.00	15.00	130.00	-6.09	1.80	-15.73	-1.01	4.00	-6.07	3.41	-4.16	2.49	4.00	5.86	0.60		
15.00	140.00	-19.75	-0.51	-5.82	0.72	4.00	15.00	140.00	-6.19	0.50	-14.74	-2.73	4.00	-6.00	3.03	-5.30	2.02	4.00	5.51	0.28		
15.00	150.00	-13.04	0.55	-6.69	1.02	4.00	15.00	150.00	-5.14	-1.17	-14.99	-4.99	4.00	-4.49	2.78	-6.09	1.99	4.00	5.41	0.09		
15.00	160.00	-10.14	1.21	-7.19	1.33	4.00	15.00	160.00	-5.12	-2.99	-14.96	-7.02	4.00	-3.93	2.61	-6.52	1.92	4.00	5.36	0.01		
15.00	170.00	-6.25	1.89	-8.13	2.05	4.00	15.00	170.00	-4.23	-6.10	-14.79	-8.45	4.00	-2.11	2.53	-7.28	2.42	4.00	5.75	0.35		
15.00	180.00	-6.38	2.53	-8.66	1.91	4.00	15.00	180.00	-7.14	-11.15	-12.01	-8.45	4.00	-3.73	2.71	-7.01	2.29	4.00	5.50	0.20		
15.00	190.00	-4.44	2.40	-8.78	1.11	4.00	15.00	190.00	-7.76	-6.42	-16.53	-10.19	-7.43	4.00	-2.78	2.46	-6.42	1.68	4.00	5.45	-0.01	
15.00	200.00	-3.59	2.02	-9.84	0.05	4.00	15.00	200.00	-9.88	-8.80	-8.50	-6.34	4.00	-2.67	2.37	-6.11	0.95	4.00	5.25	-0.28		
15.00	210.00	-3.56	1.60	-11.41	-1.10	4.00	15.00	210.00	-12													



45.00	190.00	1.17	-2.02	-0.34	0.17	4.00	45.00	190.00	-6.67	-5.79	-6.37	-13.96	4.00	1.83	-0.50	0.63	0.33	4.00	6.63	0.66
45.00	200.00	1.26	-4.72	-1.03	-0.46	4.00	45.00	200.00	-12.80	-7.54	-4.95	-7.09	4.00	1.43	-2.89	0.45	0.39	4.00	6.01	0.11
45.00	210.00	0.30	-3.90	-2.16	-2.22	4.00	45.00	210.00	-10.12	-8.40	-6.48	-6.29	4.00	0.68	-2.58	-0.79	-0.78	4.00	5.23	-0.72
45.00	220.00	-1.16	-4.95	-2.70	-3.19	4.00	45.00	220.00	-12.95	-4.52	-8.78	-5.32	4.00	-0.88	-1.72	-1.74	-1.12	4.00	4.66	-1.35
45.00	230.00	-1.64	-8.55	-3.86	-3.05	4.00	45.00	230.00	-15.45	-2.40	-9.56	-0.04	4.00	-1.46	-2.45	-2.82	1.72	4.00	5.18	-0.66
45.00	240.00	-0.77	-12.31	-4.08	-3.94	4.00	45.00	240.00	-16.51	-2.72	-11.20	-2.88	4.00	-0.66	-2.27	-3.31	3.54	4.00	5.76	0.19
45.00	250.00	-1.31	-12.20	-4.92	-7.40	4.00	45.00	250.00	-17.51	-3.56	-14.03	3.15	4.00	-1.21	-3.00	-4.42	3.52	4.00	5.29	-0.15
45.00	260.00	-2.66	-12.43	-4.77	-13.60	4.00	45.00	260.00	-10.66	-3.73	-18.96	2.74	4.00	-2.02	-3.18	-4.61	2.84	4.00	4.76	-0.73
45.00	270.00	-3.58	-9.79	-4.79	-17.31	4.00	45.00	270.00	-7.10	-4.82	-28.36	1.90	4.00	-1.98	-3.62	-4.77	1.95	4.00	4.31	-1.29
45.00	280.00	-4.84	-9.37	-4.38	-14.93	4.00	45.00	280.00	-5.83	-5.34	-15.68	0.81	4.00	-2.30	-3.89	-4.07	0.92	4.00	3.93	-1.63
45.00	290.00	-3.17	-14.03	-2.79	-8.26	4.00	45.00	290.00	-5.98	-3.24	-11.07	-0.35	4.00	-1.34	-3.99	-2.11	-0.21	4.00	5.54	-1.46
45.00	300.00	-2.69	-11.14	-1.93	-8.61	4.00	45.00	300.00	-5.62	-0.97	-8.42	-0.84	4.00	-0.90	-0.57	-1.05	-0.59	4.00	5.24	-0.77
45.00	310.00	-2.18	-6.10	-0.10	-8.65	4.00	45.00	310.00	-4.67	-1.36	-7.04	-3.67	4.00	-0.24	-0.10	-0.70	-2.47	4.00	5.57	-0.38
45.00	320.00	-1.97	-4.44	-0.14	-7.16	4.00	45.00	320.00	-2.88	-1.52	-5.56	-2.82	4.00	0.84	0.27	0.96	-4.65	4.00	5.66	-0.15
45.00	330.00	-0.93	-3.58	-0.53	-3.73	4.00	45.00	330.00	-2.25	-2.29	-4.94	-8.18	4.00	1.47	0.12	0.81	-2.40	4.00	6.14	0.23
45.00	340.00	0.20	-2.99	-0.50	-1.76	4.00	45.00	340.00	-2.64	-6.46	-4.88	-11.78	4.00	2.02	-1.38	0.85	-1.35	4.00	6.18	0.28
45.00	350.00	-1.16	-2.96	-0.94	-2.36	4.00	45.00	350.00	-0.07	-8.91	-5.71	-31.45	4.00	2.43	-1.98	0.31	-2.35	4.00	5.84	0.04
60.00	0.00	-1.59	-6.21	1.62	-7.85	4.00	60.00	0.00	-0.93	-21.16	-10.13	-17.51	4.00	1.76	-6.07	1.90	-7.40	4.00	4.59	-0.61
60.00	10.00	-3.04	-5.99	1.55	-8.75	4.00	60.00	10.00	-0.77	-10.64	-10.16	-9.66	4.00	1.25	-4.71	1.83	-6.17	4.00	4.77	-0.66
60.00	20.00	-3.73	-7.31	0.62	-5.69	4.00	60.00	20.00	-2.01	-9.88	-13.01	-3.41	4.00	0.22	-5.40	0.80	-1.39	4.00	4.89	-0.87
60.00	30.00	-4.15	-5.62	0.81	-5.15	4.00	60.00	30.00	-3.02	-8.74	-11.95	-6.34	4.00	-0.54	-3.90	1.03	-2.69	4.00	4.71	-1.11
60.00	40.00	-5.92	-7.44	0.89	-9.20	4.00	60.00	40.00	-3.98	-4.67	-18.53	-5.23	4.00	-1.83	-2.83	0.94	-3.77	4.00	4.33	-1.49
60.00	50.00	-10.40	-7.32	-0.81	-13.69	4.00	60.00	50.00	-5.33	-2.47	-40.12	-2.78	4.00	-4.15	-1.24	-0.81	-2.44	4.00	3.95	-1.98
60.00	60.00	-14.45	-5.40	-3.06	-14.19	4.00	60.00	60.00	-8.26	-3.68	-35.25	-3.27	4.00	-7.32	-1.45	-3.06	-2.93	4.00	2.59	-3.22
60.00	70.00	-13.65	-5.82	-3.39	-18.94	4.00	60.00	70.00	-16.27	-4.00	-33.17	-2.30	4.00	-11.76	-3.20	-5.20	3.20	4.00	2.36	-1.34
60.00	80.00	-10.60	-8.01	-3.44	-10.85	4.00	60.00	80.00	-28.55	-2.77	-19.38	-1.03	4.00	-10.53	-1.63	-6.10	-0.60	4.00	3.13	-3.25
60.00	90.00	-9.46	-12.00	-3.50	-6.94	4.00	60.00	90.00	-10.26	-0.22	-11.48	-1.38	4.00	-6.83	0.06	-6.20	-0.31	4.00	3.28	-2.23
60.00	100.00	-9.88	-34.63	-3.24	-7.60	4.00	60.00	100.00	-5.30	0.99	-9.47	-2.35	4.00	-4.00	0.99	-2.31	-1.02	4.00	4.58	-1.25
60.00	110.00	-7.35	-14.32	-2.38	-9.18	4.00	60.00	110.00	-3.14	2.05	-9.72	-1.46	4.00	-1.74	2.15	-1.64	-0.78	4.00	5.67	-0.19
60.00	120.00	-4.85	-7.92	-0.95	-6.58	4.00	60.00	120.00	-1.67	1.29	-13.51	-1.54	4.00	0.04	1.78	-0.72	0.43	4.00	6.45	0.48
60.00	130.00	-3.72	-6.54	-0.44	-7.34	4.00	60.00	130.00	-1.06	-0.86	-10.85	-0.57	4.00	0.82	0.18	-0.06	0.26	4.00	6.33	0.31
60.00	140.00	-2.97	-3.92	-0.29	-24.41	4.00	60.00	140.00	-0.73	-2.59	-9.09	0.85	4.00	1.30	-10.19	0.76	0.86	4.00	6.72	0.72
60.00	150.00	-2.71	-1.99	1.40	-5.76	4.00	60.00	150.00	-1.30	-8.30	-11.87	-1.03	4.00	1.06	-1.08	1.60	0.20	4.00	6.53	0.57
60.00	160.00	-2.20	-3.66	2.56	-2.96	4.00	60.00	160.00	-1.60	-10.95	-19.52	-6.61	4.00	2.54	-2.92	2.59	-1.43	4.00	6.13	0.36
60.00	170.00	-1.33	-5.06	-1.36	-2.25	4.00	60.00	170.00	-1.00	-10.59	-15.94	-7.65	4.00	1.36	-2.30	2.94	0.25	4.00	6.15	0.49
60.00	180.00	-0.47	-6.20	1.82	-7.38	4.00	60.00	180.00	-2.70	-4.91	-9.81	-12.04	4.00	1.57	-2.50	2.20	-6.15	4.00	5.42	-0.11
60.00	190.00	0.30	-4.77	-0.62	-4.06	4.00	60.00	190.00	-4.61	6.20	-7.64	-9.01	4.00	1.52	-2.42	0.17	-2.85	4.00	5.31	-0.52
60.00	200.00	-0.23	-4.73	-2.67	-8.20	4.00	60.00	200.00	-7.83	-10.17	-8.26	-9.90	4.00	0.47	-3.64	-1.61	-5.96	4.00	3.66	-2.06
60.00	210.00	-2.41	-9.40	-2.94	-16.75	4.00	60.00	210.00	-11.94	-6.31	-10.93	-12.85	4.00	-1.95	-4.58	-2.30	-11.37	4.00	1.68	-3.85
60.00	220.00	-1.50	-13.16	-2.87	-8.94	4.00	60.00	220.00	-18.97	-2.15	-9.46	-4.76	4.00	-1.42	-1.82	-2.01	-3.36	4.00	3.90	-2.09
60.00	230.00	-1.76	-9.94	-4.03	-6.96	4.00	60.00	230.00	-32.72	-1.41	-8.58	-0.12	4.00	-1.76	-0.84	-2.72	0.70	4.00	4.96	-0.97
60.00	240.00	-2.57	-11.95	-5.53	-7.19	4.00	60.00	240.00	-12.58	-2.50	-10.81	0.73	4.00	-2.16	-2.03	-4.40	1.38	4.00	4.47	-1.29
60.00	250.00	-0.77	-14.34	-6.22	-9.59	4.00	60.00	250.00	-15.85	-2.80	-17.51	0.84	4.00	-0.56	-2.51	-5.91	1.22	4.00	4.46	-1.22
60.00	260.00	-0.75	-17.47	-5.33	-12.75	4.00	60.00	260.00	-17.03	-1.62	-22.64	0.46	4.00	-0.65	-1.51	-5.25	0.66	4.00	4.59	-1.20
60.00	270.00	-1.90	-23.09	-4.04	-17.72	4.00	60.00	270.00	-14.52	-1.39	-13.13	-0.07	4.00	-1.67	-1.36	-3.54	0.00	4.00	4.47	-1.46
60.00	280.00	-1.06	-8.06	-2.67	-9.76	4.00	60.00	280.00	-10.84	-2.78	-10.06	-0.64	4.00	-0.63	-1.65	-1.94	-0.14	4.00	4.96	-1.03
60.00	290.00	-5.33	-6.27	-2.37	-5.96	4.00	60.00	290.00	-8.25	-3.89	-7.88	-1.24	4.00	-3.54	-1.91	-1.29	0.02	4.00	4.43	-1.50
60.00	300.00	-1.87	-10.12	-2.17	-4.49	4.00	60.00	300.00	-5.61	-2.57	-7.89	-2.98	4.00	-0.34	-1.87	-1.14	-0.66	4.00	5.04	-0.96
60.00	310.00	-0.52	-16.91	-1.93	-5.74	4.00	60.00	310.00	-4.52	-3.84	-7.75	-6.99	4.00	0.94	-3.63	-0.92	-3.60	4.00	4.43	-1.37
60.00	320.00	0.11	-14.11	-0.09	-7.66	4.00	60.00	320.00	-4.49	-3.30	-7.67	-11.61	4.00	1.40	-2.95	0.61	-6.19	4.00	4.74	-0.86
60.00	330.00	-0.05	-8.83	-0.27	-9.92	4.00	60.00	330.00	-2.93	-5.16	-6.49	-14.44	4.00	1.75	-3.61	0.66	-8.61	4.00	4.44	-0.92
60.00	340.00	-0.68	-8.55	-0.83	-12.90	4.00	60.00	340.00	-3.00	-11.13	-6.77	-14.20	4.00	1.32	-6.64	0.16	-10.49	4.00	3.37	-1.71
60.00	350.00	-1.54	-10.67	-0.48	-12.13	4.00	60.00	350.00	-1.10	-13.03	-9.36	-15.39	4.00	1.70	-8.68	0.05	-10.45	4.00	3.20	-1.68
75.00	0.00	-0.05	-8.60	0.90	-7.24	4.00	75.00	0.00	-1.74	-14.06	-14.67	-13.95	4.00	2.20	-7.51	1.02	-6.40	4.00	4.38	-0.80
75.00	10.00	-0.37	-8.25	0.38	-11.15	4.00	75.00	10.00	-0.74	-14.63	-13.64	-10.51	4.00	2.46	-7.35	0.55	-7.81	4.00	4.16	-0.91
75.00	20.00	-0.66	-20.34	-0.52	-10.60	4.00	75.00	20.00	-1.39	-12.68	-12.81	-9.26	4.00	2.00	-11.99	-0.27	-6.87	4.00	3.33	-1.56
75.00	30.00	0.01	-11.53	0.04	-9.19	4.00	75.00	30.00	-1.02	-26.09	-10.49	-10.86	4.00	2.54	-11.38	0.41	-6.93	4.00	3.83	-1.01
75.00	40.00	-2.18	-11.85	0.28	-12.55	4.00	75.00	40.00	-1.20	-8.56	-9.29	-11.42	4.00	1.35	-6.89	0.73	-8.94	4.00	3.71	-1.41
75.00	50.00	-4.77	-9.24	-0.32	-19.20	4.00	75.00	50.00	-1.57	-4.90	-8.59	-3.22	4.00	0.13	-3.54	0.05	-3.14	4.00	4.71	-1.13
75.00	60.00	-5.35	-7.14	-0.39	-9.68	4.00	75.00	60.00	-2.8	-4.95	-8.43	-3.55	4.00	-0.88	-2.90	0.24	-2.44	4.00	4.62	-1.31
75.00	70.00	-4.67	-8.45	-1.89	-10.26	4.00	75.00	70.00	-7.04	-7.63	-9.47	-1.36	4.00	-2.68	-5.01	-1.19	0.83	4.00	3.74	-2.15
75.00	80.00	-5.3</																		



105.00	100.00	-4.02	-26.06	-3.49	-15.34	4.00	105.00	100.00	-14.53	-4.07	-7.26	-5.86	4.00	-3.65	-4.04	-1.97	-5.40	4.00	2.34	-3.59
105.00	110.00	-4.42	-12.22	-8.43	-17.53	4.00	105.00	110.00	-11.57	-2.85	-9.25	-29.79	4.00	-3.65	-2.37	-5.81	-17.28	4.00	0.28	-4.91
105.00	120.00	-4.14	-7.93	-7.71	-6.51	4.00	105.00	120.00	-8.77	-3.99	-12.18	-4.21	4.00	-2.85	-2.52	-6.38	-2.84	4.00	2.51	-3.40
105.00	130.00	-3.60	-7.12	-3.12	-6.51	4.00	105.00	130.00	-5.40	-10.53	-14.96	-7.88	4.00	-1.40	-5.49	-2.84	-4.13	4.00	2.69	-3.20
105.00	140.00	-3.74	-4.08	-2.71	-3.41	4.00	105.00	140.00	-4.19	-15.15	-11.12	-11.68	4.00	-0.95	-3.75	-2.12	-2.81	4.00	3.67	-2.29
105.00	150.00	-1.23	-4.13	-2.63	-4.84	4.00	105.00	150.00	-5.35	-12.69	-16.19	-6.55	4.00	0.19	-3.56	-2.44	-2.60	4.00	4.03	-1.86
105.00	160.00	-2.49	-1.88	-0.50	-6.63	4.00	105.00	160.00	-4.34	-25.54	-20.60	-16.35	4.00	-0.31	-1.86	-0.46	-6.19	4.00	4.11	-1.67
105.00	170.00	-2.93	-1.90	0.03	-2.21	4.00	105.00	170.00	-4.05	-15.35	-26.64	-21.79	4.00	-0.44	-1.71	0.04	-2.16	4.00	5.00	-0.98
105.00	180.00	-4.06	-5.91	1.45	-3.52	4.00	105.00	180.00	-5.86	-8.29	-12.39	-12.56	4.00	-1.86	-3.93	1.63	-3.01	4.00	4.50	-1.23
105.00	190.00	-4.14	-5.95	0.52	-4.70	4.00	105.00	190.00	-8.19	-12.57	-9.03	-13.71	4.00	-2.70	-5.09	0.98	-4.19	4.00	3.60	-2.08
105.00	200.00	-8.40	-14.67	-3.01	-8.98	4.00	105.00	200.00	-9.22	-7.77	-13.56	-9.37	4.00	-4.88	-8.16	-3.25	-3.56	4.00	1.88	-3.89
105.00	210.00	-6.80	-15.99	-3.74	-6.13	4.00	105.00	210.00	-9.22	-7.77	-13.56	-9.37	4.00	-4.88	-7.16	-3.29	-5.27	4.00	0.99	-4.93
105.00	220.00	-9.15	-17.64	-2.87	-6.19	4.00	105.00	220.00	-14.24	-21.24	-11.08	-8.87	4.00	-7.98	-16.07	-2.26	-4.22	4.00	-0.28	-5.42
105.00	230.00	-9.72	-9.76	-5.00	-6.79	4.00	105.00	230.00	-13.37	-7.67	-11.67	-4.04	4.00	-8.16	-5.58	-4.15	-2.19	4.00	1.27	-4.51
105.00	240.00	-12.77	-9.38	-11.52	-8.78	4.00	105.00	240.00	-23.81	-15.13	-14.29	-1.57	4.00	-12.44	-8.36	-9.68	-0.81	4.00	-0.63	-5.45
105.00	250.00	-16.80	-14.46	-9.64	-11.32	4.00	105.00	250.00	-14.79	-9.70	-25.66	-0.21	4.00	-12.67	-8.45	-9.53	0.11	4.00	-0.19	-4.77
105.00	260.00	-9.33	-21.79	-4.48	-17.82	4.00	105.00	260.00	-19.41	-3.68	-13.48	-0.18	4.00	-8.92	-3.61	-3.97	-0.11	4.00	2.41	-3.14
105.00	270.00	-9.04	-12.97	-2.06	-16.84	4.00	105.00	270.00	-15.34	-2.33	-10.68	-1.19	4.00	-8.13	-1.97	-1.50	-1.07	4.00	3.27	-2.44
105.00	280.00	-14.91	-14.67	-1.84	-15.53	4.00	105.00	280.00	-8.12	-1.53	-11.81	-2.31	4.00	-7.29	-1.32	-1.42	-2.11	4.00	3.30	-2.48
105.00	290.00	-16.62	-13.39	-2.66	-9.79	4.00	105.00	290.00	-4.96	-0.85	-15.86	-2.07	4.00	-4.67	-0.61	-2.46	-1.39	4.00	3.87	-2.04
105.00	300.00	-6.46	-12.17	-4.36	-4.65	4.00	105.00	300.00	-9.68	-1.64	-17.46	-3.18	4.00	-4.77	-1.27	-4.15	-0.84	4.00	3.43	-2.43
105.00	310.00	-5.60	-7.85	-5.84	-3.86	4.00	105.00	310.00	-10.44	-0.41	-14.60	-5.30	4.00	-4.37	0.31	-5.30	-1.51	4.00	3.59	-2.14
105.00	320.00	-8.69	-4.46	-3.27	-8.08	4.00	105.00	320.00	-7.73	-6.07	-11.43	-5.21	4.00	-5.17	-2.18	-2.65	-3.40	4.00	2.74	-3.21
105.00	330.00	-7.38	-5.07	-2.81	-9.35	4.00	105.00	330.00	-4.37	-19.79	-12.52	-6.06	4.00	-2.61	-4.93	-2.37	-3.49	4.00	2.52	-3.44
105.00	340.00	-11.75	-4.56	-5.02	-5.03	4.00	105.00	340.00	-3.57	-12.01	-15.02	-6.80	4.00	-2.96	-3.84	-4.61	-2.82	4.00	2.50	-3.50
105.00	350.00	-9.39	-3.20	-6.60	-6.37	4.00	105.00	350.00	-4.92	-17.92	-15.66	-10.94	4.00	-3.59	-3.06	-6.09	-17.92	4.00	1.65	-4.29
120.00	0.00	-7.91	-0.43	-5.08	-3.62	4.00	120.00	0.00	-3.13	-10.83	-34.58	-16.01	4.00	-1.88	-0.05	-5.08	-3.38	4.00	3.62	-2.21
120.00	10.00	-8.84	-1.79	-4.33	-3.20	4.00	120.00	10.00	-5.20	-9.98	-12.11	-13.19	4.00	-3.64	-1.18	-3.66	-9.98	4.00	3.27	-2.69
120.00	20.00	-6.37	-8.54	-2.82	-6.55	4.00	120.00	20.00	-5.25	-13.20	-13.33	-6.17	4.00	-2.76	-7.26	-2.45	-3.35	4.00	2.26	-3.59
120.00	30.00	-3.48	-9.87	-1.22	-4.00	4.00	120.00	30.00	-4.13	-13.01	-9.82	-6.22	4.00	-0.78	-8.15	-0.66	-1.96	4.00	3.61	-2.07
120.00	40.00	-4.96	-9.71	-2.75	-4.46	4.00	120.00	40.00	-2.62	-6.58	-7.76	-6.61	4.00	-0.62	-4.86	-1.56	-2.39	4.00	3.80	-2.10
120.00	50.00	-3.94	-12.83	-3.66	-7.74	4.00	120.00	50.00	-1.92	-7.92	-6.72	-8.33	4.00	0.27	-6.70	-1.92	-5.01	4.00	3.10	-2.53
120.00	60.00	-0.31	-11.25	-8.44	-6.55	4.00	120.00	60.00	-3.56	-6.15	-7.91	-4.02	4.00	0.72	-4.98	-5.16	-2.09	4.00	3.49	-2.18
120.00	70.00	-0.45	-10.67	-8.70	-13.67	4.00	120.00	70.00	-7.59	-1.38	-4.57	-8.28	4.00	0.32	-0.90	-3.15	-7.18	4.00	3.73	-1.93
120.00	80.00	-1.34	-16.40	-4.47	-11.34	4.00	120.00	80.00	-1.34	0.20	-5.41	-10.24	4.00	-1.07	0.29	-10.24	-10.24	4.00	3.89	-1.76
120.00	90.00	-3.58	-17.01	-4.16	-11.18	4.00	120.00	90.00	-21.15	0.09	-10.92	-7.69	4.00	-3.50	0.17	-3.33	-6.08	4.00	3.13	-2.60
120.00	100.00	-5.15	-10.00	-7.85	-11.24	4.00	120.00	100.00	-16.52	-1.80	-17.20	-15.89	4.00	-4.84	-1.19	-7.37	-9.96	4.00	3.79	-4.65
120.00	110.00	-6.42	-8.10	-20.87	-11.00	4.00	120.00	110.00	-19.00	-4.27	-11.19	-11.99	4.00	-6.19	-2.77	-10.75	-8.46	4.00	-0.51	-6.04
120.00	120.00	-6.84	-9.14	-10.96	-10.68	4.00	120.00	120.00	-16.26	-7.27	-13.88	-6.31	4.00	-6.37	-5.09	-9.17	-7.27	4.00	-2.22	-6.11
120.00	130.00	-6.83	-9.02	-4.42	-7.26	4.00	120.00	130.00	-8.62	-8.74	-16.37	-10.46	4.00	-4.62	-5.87	-4.15	-5.56	4.00	1.00	-5.00
120.00	140.00	-6.81	-8.34	-4.81	-7.10	4.00	120.00	140.00	-6.96	-15.50	-25.70	-19.04	4.00	-3.87	-4.58	-7.57	-15.83	4.00	0.39	-5.51
120.00	150.00	-7.31	-6.26	-7.72	-12.79	4.00	120.00	150.00	-10.44	-26.31	-21.91	-15.26	4.00	-5.59	-6.22	-7.56	-10.84	4.00	-1.31	-7.14
120.00	160.00	-5.92	-8.16	-2.69	-8.17	4.00	120.00	160.00	-8.23	-15.31	-25.05	-13.25	4.00	-3.91	-7.39	-8.26	-15.70	4.00	1.01	-4.78
120.00	170.00	-6.73	-6.88	-3.75	-5.11	4.00	120.00	170.00	-8.74	-9.91	-33.50	-22.96	4.00	-4.61	-5.13	-3.75	-5.04	4.00	1.41	-4.59
120.00	180.00	-8.14	-6.40	-3.55	-9.19	4.00	120.00	180.00	-5.18	-11.44	-14.25	-9.79	4.00	-3.40	-5.22	-3.20	-1.47	4.00	1.55	-4.37
120.00	190.00	-11.07	-3.05	-4.26	-15.97	4.00	120.00	190.00	-8.79	-11.80	-8.16	-18.50	4.00	-6.77	-2.51	-2.78	-14.04	4.00	0.56	-4.75
120.00	200.00	-12.06	-5.21	-9.39	-12.43	4.00	120.00	200.00	-10.87	-8.42	-11.83	-13.45	4.00	-8.41	-3.51	-7.43	-9.90	4.00	-0.95	-6.61
120.00	210.00	-11.66	-5.79	-8.38	-10.32	4.00	120.00	210.00	-13.31	-16.64	-18.11	-15.13	4.00	-9.40	-5.45	-7.94	-9.08	4.00	-1.80	-7.67
120.00	220.00	-13.82	-7.00	-7.01	-6.76	4.00	120.00	220.00	-16.25	-8.78	-15.45	-21.45	4.00	-11.86	-2.79	-6.43	-6.61	4.00	-1.03	-6.76
120.00	230.00	-23.09	-8.91	-7.61	-5.99	4.00	120.00	230.00	-14.43	-11.36	-22.65	-8.79	4.00	-13.88	-6.95	-7.48	-4.16	4.00	-1.44	-6.96
120.00	240.00	-23.40	-15.89	-20.58	-6.42	4.00	120.00	240.00	-10.59	-14.16	-16.87	-2.95	4.00	-10.37	-11.93	-10.53	-14.16	4.00	-2.02	-6.38
120.00	250.00	-38.44	-20.57	-9.19	-9.61	4.00	120.00	250.00	-13.06	-8.56	-18.47	-0.89	4.00	-13.05	-8.29	-8.71	-0.34	4.00	-0.28	-5.03
120.00	260.00	-30.35	-13.73	-4.52	-13.60	4.00	120.00	260.00	-23.22	-9.81	-15.38	-1.35	4.00	-22.45	-8.33	-4.18	-1.10	4.00	-0.18	-4.84
120.00	270.00	-19.89	-12.03	-3.08	-12.26	4.00	120.00	270.00	-12.21	-7.03	-19.24	-3.24	4.00	-11.53	-5.84	-2.98	-2.73	4.00	0.89	-4.66
120.00	280.00	-21.04	-9.76	-4.67	-8.36	4.00	120.00	280.00	-9.22	-2.12	-37.13	-7.82	4.00	-8.94	-2.80	-4.43	-5.07	4.00	1.39	-4.26
120.00	290.00	-26.10	-6.05	-7.04	-6.59	4.00	120.00	290.00	-11.79	-1.74	-14.24	-12.06	4.00	-11.63	-0.37	-6.28	-5.51	4.00	0.97	-4.25
120.00	300.00	-12.71	-6.34	-7.04	-10.52	4.00	120.00	300.00	-14.13	-3.55	-11.54	-7.62	4.00	-10.35	-1.71	-5.98	-5.82	4.00	0.58	-4.95
120.00	310.00	-8.50	-3.50	-14.09	-4.00	4.00	120.00	310.00	-8.62	-2.37	-12.04	-3.77	4.00	-5.65	-0.36	-1.42	-1.22	4.00	3.42	-2.36
120.00	320.00	-13.09	0.16	-1.40	-11.96	4.00	120.00	320.00	-7.62	-4.84	-8.20	-4.74	4.00	-4.45	1.35	-0.54	-4.02	4.00	4.11	-1.45
120.00	330.00	-10.17	-1.99	-3.86	-6.75	4.00	120.00	330.00	-6.29	-15.01	-15.56	-15.68	4.00	-6.44	-1.78	-3.58	-6.22	4.00	2.08	-3.79
12																				



165.00	10.00	-12.09	0.75	-6.92	-4.38	4.00		165.00	10.00	-8.30	-1.48	-14.99	-12.34	4.00		-6.78	2.79	-6.29	-3.74	4.00	3.44	-1.60
165.00	20.00	-8.67	-1.68	-7.30	-6.89	4.00		165.00	20.00	-8.57	-0.28	-22.17	-14.56	4.00		-5.61	2.09	-7.16	-6.20	4.00	2.68	-2.36
165.00	30.00	-10.56	-5.63	-7.82	-10.16	4.00		165.00	30.00	-8.53	0.03	-15.74	-15.84	4.00		-6.42	1.07	-7.17	-9.12	4.00	1.57	-3.41
165.00	40.00	-10.41	-10.63	-9.66	-13.24	4.00		165.00	40.00	-7.34	-1.52	-12.13	-16.82	4.00		-5.60	-1.02	-7.71	-11.66	4.00	0.37	-4.87
165.00	50.00	-7.62	-22.55	-9.92	-10.49	4.00		165.00	50.00	-7.87	-3.48	-10.22	-18.53	4.00		-4.73	-3.43	-7.06	-9.86	4.00	0.08	-5.64
165.00	60.00	-6.95	-22.11	-9.34	-10.19	4.00		165.00	60.00	-8.11	-6.03	-12.05	-16.27	4.00		-4.48	-5.92	-7.48	-9.23	4.00	-0.58	-6.43
165.00	70.00	-5.91	-19.62	-8.49	-11.27	4.00		165.00	70.00	-8.45	-7.59	-11.52	-10.65	4.00		-3.99	-7.33	-6.74	-7.94	4.00	-0.34	-6.21
165.00	80.00	-5.61	-20.26	-9.35	-13.55	4.00		165.00	80.00	-7.72	-7.09	-12.62	-7.04	4.00		-3.53	-6.89	-7.67	-6.16	4.00	0.10	-5.76
165.00	90.00	-6.17	-15.95	-10.99	-20.89	4.00		165.00	90.00	-7.52	-5.01	-14.15	-5.80	4.00		-3.78	-4.67	-9.28	-5.67	4.00	0.40	-5.42
165.00	100.00	-7.61	-12.73	-10.53	-23.87	4.00		165.00	100.00	-7.41	-5.56	-13.60	-5.40	4.00		-4.50	-4.80	-8.79	-5.34	4.00	0.32	-5.56
165.00	110.00	-10.97	-10.74	-12.22	-13.72	4.00		165.00	110.00	-8.02	-7.32	-10.44	-6.59	4.00		-6.24	-5.69	-8.23	-5.82	4.00	-0.42	-6.38
165.00	120.00	-15.17	-11.01	-12.10	-10.61	4.00		165.00	120.00	-9.01	-13.27	-10.51	-9.43	4.00		-8.07	-8.98	-8.22	-6.97	4.00	-2.01	-8.00
165.00	130.00	-24.93	-10.70	-11.52	-10.74	4.00		165.00	130.00	-13.60	-18.82	-10.52	-12.37	4.00		-13.29	-9.75	-7.96	-8.47	4.00	-3.82	-9.45
165.00	140.00	-23.85	-6.69	-11.79	-10.35	4.00		165.00	140.00	-16.74	-12.91	-12.39	-16.06	4.00		-15.97	-5.76	-9.07	-9.32	4.00	-3.30	-8.76
165.00	150.00	-20.12	-3.67	-11.30	-6.86	4.00		165.00	150.00	-20.69	-15.32	-15.18	-18.39	4.00		-17.39	-3.38	-9.81	-8.56	4.00	-1.91	-6.98
165.00	160.00	-17.98	-3.47	-12.84	-4.54	4.00		165.00	160.00	-23.71	-40.21	-17.30	-12.80	4.00		-16.95	-3.47	-11.51	-3.94	4.00	-1.34	-6.27
165.00	170.00	-18.01	-4.52	-15.91	-4.36	4.00		165.00	170.00	-22.22	-17.49	-17.75	-10.79	4.00		-16.61	-4.31	-13.72	-3.47	4.00	-1.76	-6.55
165.00	180.00	-14.42	-5.68	-17.06	-7.55	4.00		165.00	180.00	-14.95	-14.50	-18.39	-12.56	4.00		-11.67	-5.14	-14.66	-6.36	4.00	-2.62	-7.96
165.00	190.00	-14.01	-5.77	-18.67	-8.80	4.00		165.00	190.00	-13.78	-24.84	-16.71	-23.76	4.00		-10.88	-5.72	-14.57	-8.66	4.00	-3.36	-8.85
165.00	200.00	-17.44	-8.33	-25.16	-7.81	4.00		165.00	200.00	-13.16	-24.17	-13.75	-21.13	4.00		-11.78	-8.22	-13.45	-7.61	4.00	-3.91	-9.63
165.00	210.00	-19.19	-17.91	-26.18	-7.68	4.00		165.00	210.00	-13.49	-18.58	-17.03	-12.48	4.00		-12.45	-15.22	-16.53	-6.44	4.00	-5.70	-10.75
165.00	220.00	-27.12	-17.08	-18.64	-6.84	4.00		165.00	220.00	-13.23	-15.29	-18.34	-8.81	4.00		-13.06	-13.08	-15.48	-7.40	4.00	-4.48	-9.34
165.00	230.00	-20.90	-11.67	-16.12	-7.01	4.00		165.00	230.00	-12.62	-9.88	-16.00	-5.48	4.00		-12.02	-7.67	-13.05	-3.17	4.00	-2.04	-7.18
165.00	240.00	-16.60	-12.15	-15.50	-10.13	4.00		165.00	240.00	-10.53	-6.30	-14.67	-3.99	4.00		-9.57	-5.30	-12.05	-3.04	4.00	-0.77	-6.18
165.00	250.00	-10.61	-13.91	-12.62	-15.26	4.00		165.00	250.00	-12.48	-5.73	-13.34	-3.83	4.00		-8.43	-5.12	-9.95	-3.53	4.00	-0.37	-6.04
165.00	260.00	-8.18	-15.93	-11.93	-15.13	4.00		165.00	260.00	-14.69	-6.99	-11.77	-4.53	4.00		-7.30	-6.47	-8.84	-4.17	4.00	-0.51	-6.36
165.00	270.00	-7.60	-13.54	-11.40	-10.75	4.00		165.00	270.00	-11.58	-10.65	-11.13	-6.79	4.00		-6.14	-8.85	-8.25	-5.32	4.00	-1.00	-6.90
165.00	280.00	-9.16	-10.90	-13.77	-9.51	4.00		165.00	280.00	-9.96	-15.20	-9.91	-13.40	4.00		-6.53	-9.53	-8.41	-8.02	4.00	-2.04	-7.99
165.00	290.00	-9.84	-10.71	-13.21	-7.14	4.00		165.00	290.00	-8.56	-12.18	-9.45	-18.60	4.00		-6.14	-8.37	-7.92	-6.84	4.00	-1.25	-7.23
165.00	300.00	-11.72	-8.58	-12.06	-5.74	4.00		165.00	300.00	-8.44	-6.72	-10.16	-12.32	4.00		-6.77	-4.54	-8.00	-4.88	4.00	0.09	-5.83
165.00	310.00	-14.66	-7.57	-10.83	-4.57	4.00		165.00	310.00	-9.15	-4.33	-13.19	-10.76	4.00		-8.07	-2.64	-8.84	-3.63	4.00	0.64	-5.01
165.00	320.00	-16.40	-3.64	-8.82	-3.86	4.00		165.00	320.00	-11.39	-3.40	-15.42	-14.29	4.00		-10.20	-0.51	-11.39	-3.48	4.00	1.30	-4.00
165.00	330.00	-14.93	-1.30	-8.82	-4.42	4.00		165.00	330.00	-12.06	-3.56	-18.32	-17.13	4.00		-10.25	0.73	-8.36	-4.19	4.00	1.56	-3.46
165.00	340.00	-13.82	0.63	-8.84	-5.01	4.00		165.00	340.00	-11.95	-4.12	-18.65	-15.77	4.00		-9.77	1.88	-8.41	-4.66	4.00	2.05	-2.73
165.00	350.00	-11.75	1.35	-8.05	-5.27	4.00		165.00	350.00	-9.65	-4.18	-20.71	-13.29	4.00		-7.56	2.42	-7.82	-4.63	4.00	2.71	-2.16
180.00	0.00	-7.36	-12.51	-11.95	-8.57	4.00		180.00	0.00	-11.05	-16.90	-17.89	-10.78	4.00		-5.81	-11.16	-10.96	-6.40	4.00	-2.21	-7.91
180.00	10.00	-6.54	-11.76	-11.34	-7.41	4.00		180.00	10.00	-13.91	-20.03	-21.76	-13.21	4.00		-5.81	-11.16	-10.96	-6.40	4.00	-2.21	-7.90
180.00	20.00	-6.05	-11.32	-11.02	-6.79	4.00		180.00	20.00	-18.65	-25.47	-29.54	-17.00	4.00		-5.82	-11.16	-10.96	-6.39	4.00	-2.21	-7.90
180.00	30.00	-5.83	-11.16	-10.98	-6.47	4.00		180.00	30.00	-30.91	-45.51	-35.94	-24.49	4.00		-5.82	-11.16	-10.97	-6.40	4.00	-2.21	-7.91
180.00	40.00	-5.87	-11.27	-11.20	-6.41	4.00		180.00	40.00	-24.33	-27.37	-23.77	-32.49	4.00		-5.81	-11.16	-10.97	-6.40	4.00	-2.21	-7.90
180.00	50.00	-6.19	-11.64	-11.70	-6.62	4.00		180.00	50.00	-16.59	-20.95	-19.04	-19.46	4.00		-5.81	-11.16	-10.96	-6.40	4.00	-2.21	-7.90
180.00	60.00	-6.80	-12.32	-12.51	-7.11	4.00		180.00	60.00	-12.73	-17.48	-16.19	-14.62	4.00		-5.81	-11.16	-10.96	-6.40	4.00	-2.21	-7.90
180.00	70.00	-7.74	-13.34	-13.71	-7.91	4.00		180.00	70.00	-10.26	-15.20	-14.25	-11.71	4.00		-5.81	-11.16	-10.96	-6.40	4.00	-2.21	-7.90
180.00	80.00	-9.11	-14.80	-15.42	-9.09	4.00		180.00	80.00	-8.56	-13.62	-12.89	-9.75	4.00		-5.82	-11.16	-10.96	-6.40	4.00	-2.21	-7.91
180.00	90.00	-11.05	-16.90	-17.89	-10.78	4.00		180.00	90.00	-7.36	-12.51	-11.95	-8.37	4.00		-5.81	-11.16	-10.96	-6.40	4.00	-2.21	-7.91
180.00	100.00	-13.91	-20.03	-21.76	-13.21	4.00		180.00	100.00	-6.54	-11.76	-11.34	-7.41	4.00		-5.81	-11.16	-10.96	-6.40	4.00	-2.21	-7.90
180.00	110.00	-18.65	-25.47	-29.54	-17.00	4.00		180.00	110.00	-6.05	-11.32	-11.02	-6.79	4.00		-5.82	-11.16	-10.96	-6.39	4.00	-2.21	-7.90
180.00	120.00	-30.91	-45.51	-35.94	-24.49	4.00		180.00	120.00	-5.83	-11.16	-10.98	-6.47	4.00		-5.82	-11.16	-10.97	-6.40	4.00	-2.21	-7.91
180.00	130.00	-24.33	-27.37	-23.77	-32.49	4.00		180.00	130.00	-5.87	-11.27	-11.20	-6.41	4.00		-5.81	-11.16	-10.97	-6.40	4.00	-2.21	-7.90
180.00	140.00	-16.59	-20.95	-19.04	-19.46	4.00		180.00	140.00	-6.19	-11.64	-11.70	-6.62	4.00		-5.81	-11.16	-10.96	-6.40	4.00	-2.21	-7.90
180.00	150.00	-12.73	-17.48	-16.19	-14.62	4.00		180.00	150.00	-6.80	-12.32	-12.51	-7.11	4.00		-5.81	-11.16	-10.96	-6.40	4.00	-2.21	-7.91
180.00	160.00	-10.26	-15.20	-14.25	-11.71	4.00		180.00	160.00	-7.74	-13.34	-13.71	-7.91	4.00		-5.81	-11.16	-10.96	-6.40	4.00	-2.21	-7.90
180.00	170.00	-8.56	-13.62	-12.89	-9.75	4.00		180.00	170.00	-9.11	-14.80	-15.42	-9.09	4.00		-5.82	-11.16	-10.96	-6.40	4.00	-2.21	-7.91
180.00	180.00	-7.36	-12.51	-11.95	-8.57	4.00		180.00	180.00	-11.05	-16.90	-17.89	-10.78	4.00		-5.81	-11.16	-10.96	-6.40	4.00	-2.21	-7.91
180.00	190.00	-6.54	-11.76	-11.34	-7.41	4.00		180.00	190.00	-13.91	-20.03	-21.76	-13.21	4.00		-5.81	-11.16	-10.96	-6.40	4.00	-2.21	-7.90
180.00	200.00	-6.05	-11.32	-11.02	-6.79	4.00		180.00	200.00	-18.65	-25.47	-29.54	-17.00	4.00		-5.82	-11.16	-10.96	-6.39	4.00	-2.21	-7.90
180.00	210.00	-5.83	-11.16	-10.98	-6.47	4.00		180.00	210.00	-30.91	-45.51	-35.94	-24.49	4.00		-5.82	-11.16	-10.97	-6.40	4.00	-2.21	-7.91
180.00																						



Frequency: 5320MHz

Theta Polarization		Max Gain(dB)				Nant	Angle (θ)	Angle (ψ)	Phi Polarization				Nant	Total				Max DG(dB)	Max DG(dB)				
Angle (θ)	Angle (ψ)	Ant 1(G1)	Ant 2(G2)	Ant 3(G3)	Ant 4(G4)				Angle (θ)	Angle (ψ)	Ant 1(G1)	Ant 2(G2)		Ant 3(G3)	Ant 4(G4)	Ant 1(G1)	Ant 2(G2)			Ant 3(G3)	Ant 4(G4)	7.68	1.78
		1.33	3.61	3.50	2.28						0.76	3.61		-2.95	2.66	3.43	4.34			3.66	3.95		
		Ant 1(G1)	Ant 2(G2)	Ant 3(G3)	Ant 4(G4)						Ant 1(G1)	Ant 2(G2)		Ant 3(G3)	Ant 4(G4)	Ant 1(G1)	Ant 2(G2)			Ant 3(G3)	Ant 4(G4)		
0.00	0.00	-17.20	3.51	-9.01	0.60	4.00	0.00	0.00	-6.84	-12.81	-8.84	-16.12	4.00	-6.46	3.61	-5.91	0.69	4.00	5.06	-0.05			
0.00	10.00	-13.35	3.61	-7.71	0.69	4.00	0.00	10.00	-7.45	-29.15	-10.62	-29.83	4.00	-6.46	3.61	-5.92	0.69	4.00	5.06	-0.05			
0.00	20.00	-10.89	3.44	-6.81	0.51	4.00	0.00	20.00	-8.40	-10.53	-13.21	-13.16	4.00	-6.46	3.61	-5.91	0.69	4.00	5.06	-0.05			
0.00	30.00	-9.19	3.00	-6.24	0.06	4.00	0.00	30.00	-9.76	-5.17	-17.34	-7.94	4.00	-6.46	3.62	-5.92	0.70	4.00	5.06	-0.05			
0.00	40.00	-8.00	2.25	-5.95	-0.71	4.00	0.00	40.00	-11.71	-2.07	-26.18	-4.89	4.00	-6.46	3.62	-5.91	0.69	4.00	5.06	-0.05			
0.00	50.00	-7.18	1.13	-5.94	-1.84	4.00	0.00	50.00	-14.58	0.01	-28.14	-2.84	4.00	-6.45	3.62	-5.91	0.70	4.00	5.06	-0.05			
0.00	60.00	-6.69	-0.47	-6.19	-3.46	4.00	0.00	60.00	-19.34	1.46	-17.98	-1.41	4.00	-6.46	3.61	-5.91	0.70	4.00	5.06	-0.05			
0.00	70.00	-6.47	-2.76	-6.73	-5.79	4.00	0.00	70.00	-31.75	2.48	-13.58	-0.41	4.00	-6.46	3.62	-5.91	0.70	4.00	5.06	-0.05			
0.00	80.00	-6.52	-6.27	-7.59	-9.37	4.00	0.00	80.00	-24.88	3.14	-10.86	0.25	4.00	-6.46	3.61	-5.91	0.70	4.00	5.06	-0.05			
0.00	90.00	-6.84	-12.81	-8.84	-16.12	4.00	0.00	90.00	-17.20	3.51	-9.01	0.60	4.00	-6.46	3.61	-5.91	0.69	4.00	5.06	-0.05			
0.00	100.00	-7.45	-29.15	-10.62	-29.83	4.00	0.00	100.00	-13.35	3.61	-7.71	0.69	4.00	-6.46	3.61	-5.92	0.69	4.00	5.06	-0.05			
0.00	110.00	-8.40	-10.53	-13.21	-13.16	4.00	0.00	110.00	-10.89	3.44	-6.81	0.51	4.00	-6.46	3.61	-5.91	0.69	4.00	5.06	-0.05			
0.00	120.00	-9.76	-5.17	-17.34	-7.94	4.00	0.00	120.00	-9.19	3.00	-6.24	0.06	4.00	-6.46	3.62	-5.92	0.70	4.00	5.06	-0.05			
0.00	130.00	-11.71	-2.07	-26.18	-4.89	4.00	0.00	130.00	-8.00	2.25	-5.95	-0.71	4.00	-6.46	3.62	-5.91	0.69	4.00	5.06	-0.05			
0.00	140.00	-14.58	0.01	-28.14	-2.84	4.00	0.00	140.00	-7.18	1.13	-5.94	-1.84	4.00	-6.45	3.62	-5.91	0.70	4.00	5.06	-0.05			
0.00	150.00	-19.34	1.46	-17.98	-1.41	4.00	0.00	150.00	-6.69	-0.47	-6.19	-3.46	4.00	-6.46	3.61	-5.91	0.70	4.00	5.06	-0.05			
0.00	160.00	-31.75	2.48	-13.58	-0.41	4.00	0.00	160.00	-6.47	-2.76	-6.73	-5.79	4.00	-6.46	3.62	-5.91	0.70	4.00	5.06	-0.05			
0.00	170.00	-24.88	3.14	-10.86	0.25	4.00	0.00	170.00	-6.52	-6.27	-7.59	-9.37	4.00	-6.46	3.61	-5.91	0.70	4.00	5.06	-0.05			
0.00	180.00	-17.20	3.51	-9.01	0.60	4.00	0.00	180.00	-6.84	-12.81	-8.84	-16.12	4.00	-6.46	3.61	-5.91	0.69	4.00	5.06	-0.05			
0.00	190.00	-13.35	3.61	-7.71	0.69	4.00	0.00	190.00	-7.45	-29.15	-10.62	-29.83	4.00	-6.46	3.61	-5.92	0.69	4.00	5.06	-0.05			
0.00	200.00	-10.89	3.44	-6.81	0.51	4.00	0.00	200.00	-8.40	-10.53	-13.21	-13.16	4.00	-6.46	3.61	-5.91	0.69	4.00	5.06	-0.05			
0.00	210.00	-9.19	3.00	-6.24	0.06	4.00	0.00	210.00	-9.76	-5.17	-17.34	-7.94	4.00	-6.46	3.62	-5.92	0.70	4.00	5.06	-0.05			
0.00	220.00	-8.00	2.25	-5.95	-0.71	4.00	0.00	220.00	-11.71	-2.07	-26.18	-4.89	4.00	-6.46	3.62	-5.91	0.69	4.00	5.06	-0.05			
0.00	230.00	-7.18	1.13	-5.94	-1.84	4.00	0.00	230.00	-14.58	0.01	-28.14	-2.84	4.00	-6.45	3.62	-5.91	0.70	4.00	5.06	-0.05			
0.00	240.00	-6.69	-0.47	-6.19	-3.46	4.00	0.00	240.00	-19.34	1.46	-17.98	-1.41	4.00	-6.46	3.61	-5.91	0.70	4.00	5.06	-0.05			
0.00	250.00	-6.47	-2.76	-6.73	-5.79	4.00	0.00	250.00	-31.75	2.48	-13.58	-0.41	4.00	-6.46	3.62	-5.91	0.70	4.00	5.06	-0.05			
0.00	260.00	-6.52	-6.27	-7.59	-9.37	4.00	0.00	260.00	-24.88	3.14	-10.86	0.25	4.00	-6.46	3.61	-5.91	0.70	4.00	5.06	-0.05			
0.00	270.00	-6.84	-12.81	-8.84	-16.12	4.00	0.00	270.00	-17.20	3.51	-9.01	0.60	4.00	-6.46	3.61	-5.91	0.69	4.00	5.06	-0.05			
0.00	280.00	-7.45	-29.15	-10.62	-29.83	4.00	0.00	280.00	-13.35	3.61	-7.71	0.69	4.00	-6.46	3.61	-5.92	0.69	4.00	5.06	-0.05			
0.00	290.00	-8.40	-10.53	-13.21	-13.16	4.00	0.00	290.00	-10.89	3.44	-6.81	0.51	4.00	-6.46	3.61	-5.91	0.69	4.00	5.06	-0.05			
0.00	300.00	-9.76	-5.17	-17.34	-7.94	4.00	0.00	300.00	-9.19	3.00	-6.24	0.06	4.00	-6.46	3.62	-5.92	0.70	4.00	5.06	-0.05			
0.00	310.00	-11.71	-2.07	-26.18	-4.89	4.00	0.00	310.00	-8.00	2.25	-5.95	-0.71	4.00	-6.46	3.62	-5.91	0.69	4.00	5.06	-0.05			
0.00	320.00	-14.58	0.01	-28.14	-2.84	4.00	0.00	320.00	-7.18	1.13	-5.94	-1.84	4.00	-6.45	3.62	-5.91	0.70	4.00	5.06	-0.05			
0.00	330.00	-19.34	1.46	-17.98	-1.41	4.00	0.00	330.00	-6.69	-0.47	-6.19	-3.46	4.00	-6.46	3.61	-5.91	0.70	4.00	5.06	-0.05			
0.00	340.00	-31.75	2.48	-13.58	-0.41	4.00	0.00	340.00	-6.47	-2.76	-6.73	-5.79	4.00	-6.46	3.62	-5.91	0.70	4.00	5.06	-0.05			
0.00	350.00	-24.88	3.14	-10.86	0.25	4.00	0.00	350.00	-6.52	-6.27	-7.59	-9.37	4.00	-6.46	3.61	-5.91	0.70	4.00	5.06	-0.05			
15.00	0.00	-2.50	2.14	-5.59	-0.09	4.00	15.00	0.00	-4.61	-16.77	-4.72	-26.51	4.00	-0.42	2.20	-2.12	-0.08	4.00	6.05	0.17			
15.00	10.00	-3.73	2.58	-5.30	-0.10	4.00	15.00	10.00	-4.68	-18.33	-5.78	-15.50	4.00	-1.17	2.62	-2.52	0.02	4.00	5.97	0.16			
15.00	20.00	-8.21	3.11	-6.68	0.04	4.00	15.00	20.00	-3.89	-9.48	-10.02	-8.32	4.00	-2.52	3.34	-3.03	0.63	4.00	5.70	0.20			
15.00	30.00	-22.40	3.33	-7.15	-0.91	4.00	15.00	30.00	-3.52	-3.89	-13.17	-4.44	4.00	-3.46	4.08	-6.18	0.68	4.00	5.68	0.44			
15.00	40.00	-14.61	2.96	-6.65	-3.03	4.00	15.00	40.00	-5.10	-1.60	-12.82	-2.79	4.00	-4.64	4.26	-5.71	0.10	4.00	5.46	0.32			
15.00	50.00	-10.05	2.38	-5.37	-4.96	4.00	15.00	50.00	-7.77	-0.05	-14.05	-1.62	4.00	-5.75	4.34	-4.82	0.03	4.00	5.44	0.34			
15.00	60.00	-8.65	1.10	-5.28	-8.16	4.00	15.00	60.00	-12.63	1.22	-12.21	-0.51	4.00	-7.19	4.17	-4.48	0.18	4.00	5.28	0.21			
15.00	70.00	-7.23	-0.48	-5.39	-13.61	4.00	15.00	70.00	-18.91	2.19	-10.67	0.63	4.00	-6.94	4.07	-4.26	0.79	4.00	5.47	0.34			
15.00	80.00	-7.15	-3.67	-5.10	-33.19	4.00	15.00	80.00	-23.06	2.91	-11.27	1.02	4.00	-7.04	3.77	-4.16	1.02	4.00	5.42	0.24			
15.00	90.00	-7.89	-7.29	-4.41	-11.79	4.00	15.00	90.00	-17.07	3.22	-12.17	1.28	4.00	-7.39	3.59	-3.74	1.49	4.00	5.52	0.31			
15.00	100.00	-10.09	-11.87	-4.75	-6.62	4.00	15.00	100.00	-11.73	3.58	-13.53	1.04	4.00	-7.82	3.70	-4.21	1.73	4.00	5.51	0.39			
15.00	110.00	-11.16	-9.87	-4.41	-3.72	4.00	15.00	110.00	-9.38	3.51	-16.38	0.57	4.00	-7.17	3.70	-4.14	1.94	4.00	5.67	0.50			
15.00	120.00	-17.10	-4.06	-4.42	-1.38	4.00	15.00	120.00	-6.83	2.71	-19.46	-0.29	4.00	-6.44	3.54	-4.29	2.21	4.00	5.76	0.53			
15.00	130.00	-26.22	-1.65	-4.65	-0.53	4.00	15.00	130.00	-6.62	1.61	-17.18	-1.74	4.00	-6.57	3.29	-4.41	1.92	4.00	5.53	0.28			
15.00	140.00	-20.53	0.11	-5.59	0.23	4.00	15.00	140.00	-6.37	-0.03	-17.37	-3.30	4.00	-6.21	3.05	-5.31	1.82	4.00	5.31	0.08			
15.00	150.00	-12.75	0.70	-6.43	0.77	4.00	15.00	150.00	-6.05	-1.67	-15.71	-5.25	4.00	-5.21	2.69	-5.95	1.74	4.00	5.19	-0.11			
15.00	160.00	-9.58	1.44	-7.76	1.22	4.00	15.00	160.00	-5.20	-4.16	-15.73	-6.91	4.00	-3.85	2.50	-7.12	1.84	4.00	5.23	-0.10			
15.00	170.00	-6.66	1.95	-8.36	1.61	4.00	15.00	170.00	-4.43	-7.29	-15.35	-9.18	4.00	-2.39	2.44	-7.57	1.96	4.00	5.47	0.08			
15.00	180.00	-6.29	2.44	-8.52	1.40	4.00	15.00	180.00	-6.96	-12.06	-12.80	-9.15	4.00	-3.60	2.59	-7.14	1.77	4.00	5.28	-0.06			
15.00	190.00	-4.46	2.47	-9.46	0.41	4.00	15.00	190.00	-7.88	-14.67	-10.57	-8.10	4.00	-2.83	2.55	-6.97	0.98	4.00	5.18	-0.25			
15.00	200.00	-3.31	1.79	-11.25	-0.69	4.00	15.00	200.00	-9.48	-7.83	-9.07	-6.79	4.00	-2.37	2.24	-7.01	0.26	4.00	4.94	-0.56			
15.00	210.00	-3.58	1.34	-11.98	-0.96	4.00	15.00	210.00	-11.86	-4.85	-9.25	-5.40	4.00	-2.98	2.28	-7.39	0.37	4.00	4.81	-0.62			
15.00	220.00	-4.94	0.11																				



45.00	140.00	-3.76	-2.27	2.30	-0.14	4.00	45.00	140.00	-1.60	-1.71	-17.45	-1.65	4.00
45.00	150.00	-2.64	0.73	2.54	-0.91	4.00	45.00	150.00	-2.13	-2.56	-20.97	-3.90	4.00
45.00	160.00	-1.82	1.13	2.14	-1.78	4.00	45.00	160.00	-1.38	-4.52	-25.23	-4.64	4.00
45.00	170.00	0.18	-1.28	1.97	-2.32	4.00	45.00	170.00	-2.36	-6.69	-19.42	-7.40	4.00
45.00	180.00	1.06	-1.60	1.27	-3.40	4.00	45.00	180.00	-4.74	-7.59	-10.49	-15.91	4.00
45.00	190.00	1.09	-2.67	0.11	-0.17	4.00	45.00	190.00	-6.41	-6.86	-6.38	-15.18	4.00
45.00	200.00	1.33	-4.57	-0.93	-0.57	4.00	45.00	200.00	-13.75	-8.30	-5.13	-8.92	4.00
45.00	210.00	0.23	-3.84	-1.85	-2.37	4.00	45.00	210.00	-12.12	-9.22	-6.27	-7.09	4.00
45.00	220.00	-1.15	-4.81	-3.21	-3.41	4.00	45.00	220.00	-15.80	-4.65	-8.50	-6.24	4.00
45.00	230.00	-2.13	-7.71	-4.00	-2.66	4.00	45.00	230.00	-15.55	-3.13	-10.12	0.09	4.00
45.00	240.00	-1.05	-11.29	-5.00	-4.05	4.00	45.00	240.00	-15.53	-3.83	-10.73	2.35	4.00
45.00	250.00	-1.56	-12.65	-5.97	-7.66	4.00	45.00	250.00	-19.88	-4.82	-11.89	2.66	4.00
45.00	260.00	-2.88	-12.08	-6.03	-14.79	4.00	45.00	260.00	-11.35	-4.50	-17.53	2.10	4.00
45.00	270.00	-3.79	-10.36	-5.50	-17.52	4.00	45.00	270.00	-7.36	-4.80	-22.86	1.09	4.00
45.00	280.00	-5.65	-9.32	-4.89	-14.59	4.00	45.00	280.00	-6.34	-5.62	-13.61	0.13	4.00
45.00	290.00	-3.74	-14.95	-3.61	-10.94	4.00	45.00	290.00	-6.33	-3.49	-10.99	-0.49	4.00
45.00	300.00	-3.60	-10.95	-2.20	-9.78	4.00	45.00	300.00	-6.14	-1.25	-9.60	-1.90	4.00
45.00	310.00	-2.66	-6.48	-0.93	-8.59	4.00	45.00	310.00	-5.00	-2.02	-7.22	-3.57	4.00
45.00	320.00	-1.78	-4.70	-0.92	-8.21	4.00	45.00	320.00	-3.38	-1.82	-5.87	-7.84	4.00
45.00	330.00	-1.25	-3.27	-0.70	-4.40	4.00	45.00	330.00	-3.32	-2.57	-5.42	-8.91	4.00
45.00	340.00	0.19	-2.30	-1.05	-2.16	4.00	45.00	340.00	-3.42	-6.09	-5.59	-11.56	4.00
45.00	350.00	-1.14	-3.11	-0.96	-2.16	4.00	45.00	350.00	-1.02	-8.88	-6.15	-36.73	4.00
60.00	0.00	-2.06	-6.34	1.50	-8.33	4.00	60.00	0.00	-1.34	-21.02	-9.22	-15.24	4.00
60.00	10.00	-3.38	-7.20	1.74	-9.43	4.00	60.00	10.00	-1.34	-10.34	-10.45	-10.89	4.00
60.00	20.00	-4.17	-7.94	0.38	-6.22	4.00	60.00	20.00	-2.25	-10.01	-14.16	-3.59	4.00
60.00	30.00	-4.23	-6.24	0.92	-5.24	4.00	60.00	30.00	-3.44	-9.44	-13.79	-5.59	4.00
60.00	40.00	-5.66	-8.38	0.66	-8.64	4.00	60.00	40.00	-4.45	-5.18	-17.43	-5.55	4.00
60.00	50.00	-11.41	-9.17	-0.87	-14.36	4.00	60.00	50.00	-5.92	-2.97	-31.54	-2.91	4.00
60.00	60.00	-15.92	-5.95	-2.93	-15.83	4.00	60.00	60.00	-9.41	-3.62	-34.18	-3.87	4.00
60.00	70.00	-15.45	-6.52	-3.18	-17.61	4.00	60.00	70.00	-14.23	-4.22	-37.53	-3.04	4.00
60.00	80.00	-11.28	-8.89	-3.34	-11.57	4.00	60.00	80.00	-33.98	-3.08	-20.64	-1.94	4.00
60.00	90.00	-9.27	-14.29	-3.15	-7.66	4.00	60.00	90.00	-11.06	-0.81	-13.29	-2.02	4.00
60.00	100.00	-9.28	-28.80	-2.28	-8.21	4.00	60.00	100.00	-5.66	1.14	-10.10	-2.31	4.00
60.00	110.00	-7.46	-13.98	-1.46	-10.03	4.00	60.00	110.00	-3.39	1.65	-9.95	-1.76	4.00
60.00	120.00	-4.85	-7.70	-0.60	-6.55	4.00	60.00	120.00	-1.82	0.90	-12.43	-1.28	4.00
60.00	130.00	-3.52	-6.16	0.07	-7.37	4.00	60.00	130.00	-1.38	-1.51	-11.06	-0.75	4.00
60.00	140.00	-2.92	-4.12	0.81	-24.55	4.00	60.00	140.00	-1.19	-2.51	-8.37	0.09	4.00
60.00	150.00	-2.54	-2.36	1.72	-5.72	4.00	60.00	150.00	-1.51	-8.32	-11.91	-1.94	4.00
60.00	160.00	-2.32	-3.43	2.80	-3.57	4.00	60.00	160.00	-1.31	-11.91	-18.35	-7.32	4.00
60.00	170.00	-1.42	-4.81	3.16	-2.44	4.00	60.00	170.00	-2.21	-8.92	-16.12	-7.69	4.00
60.00	180.00	-0.40	-7.22	2.20	-8.54	4.00	60.00	180.00	-2.80	-5.13	-8.85	-14.44	4.00
60.00	190.00	0.34	-6.56	-0.82	-4.24	4.00	60.00	190.00	-4.82	-6.46	-7.03	-10.05	4.00
60.00	200.00	-0.26	-5.29	-2.05	-8.98	4.00	60.00	200.00	-8.63	-9.65	-9.21	-9.73	4.00
60.00	210.00	-2.40	-8.27	-2.58	-16.02	4.00	60.00	210.00	-11.60	-6.68	-10.65	-14.70	4.00
60.00	220.00	-2.02	-13.35	-3.06	-8.12	4.00	60.00	220.00	-17.97	-3.72	-8.90	-5.57	4.00
60.00	230.00	-2.50	-11.25	-3.97	-7.76	4.00	60.00	230.00	-27.82	-2.20	-7.96	-0.69	4.00
60.00	240.00	-2.93	-13.68	-5.46	-7.50	4.00	60.00	240.00	-13.70	-2.78	-11.77	0.77	4.00
60.00	250.00	-0.91	-13.21	-6.33	-8.53	4.00	60.00	250.00	-16.45	-3.04	-20.62	0.40	4.00
60.00	260.00	-1.24	-15.47	-5.40	-12.54	4.00	60.00	260.00	-18.83	-1.73	-19.63	-0.24	4.00
60.00	270.00	-1.87	-22.09	-3.60	-17.96	4.00	60.00	270.00	-16.54	-1.24	-12.17	-1.14	4.00
60.00	280.00	-1.49	-9.39	-2.91	-10.21	4.00	60.00	280.00	-10.97	-3.10	-8.41	-1.36	4.00
60.00	290.00	-6.68	-6.68	-2.50	-6.49	4.00	60.00	290.00	-10.01	-4.30	-7.72	-1.88	4.00
60.00	300.00	-2.15	-9.33	-3.01	-5.17	4.00	60.00	300.00	-6.34	-2.96	-7.25	-3.72	4.00
60.00	310.00	-0.52	-15.40	-2.81	-5.81	4.00	60.00	310.00	-5.81	-3.51	-7.61	-8.84	4.00
60.00	320.00	-0.24	-14.69	-0.73	-7.48	4.00	60.00	320.00	-4.91	-3.69	-7.41	-12.85	4.00
60.00	330.00	-0.56	-9.05	-1.25	-9.35	4.00	60.00	330.00	-3.69	-5.52	-7.14	-13.24	4.00
60.00	340.00	-0.87	-8.57	-1.53	-12.66	4.00	60.00	340.00	-4.31	-11.84	-7.13	-14.93	4.00
60.00	350.00	-2.06	-10.82	-1.10	-12.74	4.00	60.00	350.00	-2.31	-12.45	-8.68	-16.82	4.00
75.00	0.00	-0.01	-9.08	0.85	-7.52	4.00	75.00	0.00	-2.03	-15.99	-14.13	-14.38	4.00
75.00	10.00	-0.91	-7.75	0.69	-10.19	4.00	75.00	10.00	-1.27	-13.96	-13.34	-10.39	4.00
75.00	20.00	-0.81	-23.25	0.12	-9.48	4.00	75.00	20.00	-1.75	-13.79	-12.98	-9.33	4.00
75.00	30.00	0.04	-11.58	0.57	-8.84	4.00	75.00	30.00	-1.65	-27.93	-9.99	-10.29	4.00
75.00	40.00	-2.62	-12.45	0.4	-11.00	4.00	75.00	40.00	-1.71	-8.44	-9.54	-11.24	4.00
75.00	50.00	-4.64	-9.44	-0.07	-20.03	4.00	75.00	50.00	-2.17	-6.28	-9.09	-3.68	4.00
75.00	60.00	-5.41	-6.99	-0.55	-10.09	4.00	75.00	60.00	-3.14	-6.00	-9.04	-3.44	4.00
75.00	70.00	-5.48	-8.31	-1.63	-10.08	4.00	75.00	70.00	-7.45	-7.52	-9.33	-1.49	4.00
75.00	80.00	-5.82	-12.79	-1.85	-11.15	4.00	75.00	80.00	-11.43	-7.25	-13.4	0.40	4.00
75.00	90.00	-6.53	-20.57	-1.11	-8.17	4.00	75.00	90.00	-11.53	-6.11	-19.82	-0.04	4.00
75.00	100.00	-7.83	-24.07	-1.26	-5.62	4.00	75.00	100.00	-10.49	-4.26	-10.23	-1.71	4.00
75.00	110.00	-6.9	-15.35	-2.32	-3.35	4.00	75.00	110.00	-8.3	-3.50	-7.44	-3.83	4.00
75.00	120.00	-5.48	-12.59	-2.10	-2.81	4.00	75.00	120.00	-4.73	-2.81	-7.50	-2.38	4.00
75.00	130.00	-3.92	-8.05	0.05	-4.29	4.00	75.00	130.00	-2.51	-4.09	-8.44	-0.52	4.00
75.00	140.00	-2.36	-7.00	0.76	-5.18	4.00	75.00	140.00	-1.33	-7.44	-8.66	-1.47	4.00
75.00	150.00	-2.28	-7.13	0.87	-10.27	4.00	75.00	150.00	-1.94	-9.97	-9.78	-0.32	4.00
75.00	160.00	-1.32	-9.89	1.78	-7.38	4.00	75.00	160.00	-2.42	-11.50	-13.25	-3.34	4.00
75.00	170.00	-0.21	-15.36	2.66	-7.27	4.00	75.00	170.00	-2.55	-12.51	-15.91	-9.50	4.00
75.00	180.00	-0.99	-10.45	3.50	-8.97	4.00	75.00	180.00	-5.60	-5.62	-15.00	-11.27	4.00
75.00	190.00	-0.14	-6.69	2.21	-4.12	4.00	75.00	190.00	-4.14	-6.71	-9.80	-9.06	4.00
75.00	200.00	-1.27	-11.46	-0.53	-5.63	4.00	75.00	200.00	-7.47	-8.35	-10.10	-7.10	4.00
75.00	210.00	-1.10	-8.73	-1.39	-5.74	4.00	75.00	210.00	-9.51	-5.92	-11.48	-11.31	4.00
75.00	220.00	-2.16	-8.11	-2.53	-6.25	4.00	75.00	220.00	-11.47	-3.54	-11.12	-2.98	4.00
75.00	230.00	-2.47	-6.65	-4.80	-10.70	4.00	75.00	230.00	-10.81	-2.20	-11.44	-0.09	4.00
75.00	240.00	-3.91	-6.61	-8.08	-11.70	4.00	75.00	240.00	-11.74	-3.89	-16.65	-0.33	4.00
75.00	250.00	-4.74	-7.89	-7.25	-11.71	4.00	75.00	250.00	-8.49	-3.01	-23.98	-0.21	4.00
75.00	260.00	-1.87	-8.50	-3.97	-15.15	4.00	75.00	260.00	-8.25	-0.90	-13.94	0.09	4.00
75.00	270.00	-2.18	-10.58	-2.26	-15.87	4.00	75.00	270.00	-12.40	0.02	-9.10	-0.98	4.00
75.00	280.00	-2.86	-18.73	-1.65	-12.10	4.00	75.00	280.00	-12.67	-1.71	-6.63	-1.62	4.00
75.00	290.00	-4.00	-7.43	-0.79	-8.32	4.00	75.00	290.00	-8.88	-5.60	-6.10	-2.35	4.00
75.00	300.00	-1.85	-6.45	-0.24	-5.49	4.00	75.00	300.00	-10.15	-4.06	-6.21	-2.51	4.00



10500	0.00	-14.75	-3.85	-2.11	-9.89	4.00	10500	0.00	-3.86	-6.76	-17.04	-8.83	4.00	-3.52	-2.06	-1.97	-6.32	4.00	2.72	-3.15
10500	10.00	-7.29	-4.56	-0.27	-10.47	4.00	10500	10.00	-3.47	-11.90	-14.26	-14.65	4.00	-1.96	-3.82	-0.10	-9.07	4.00	2.87	-2.69
10500	20.00	-3.35	-8.07	-1.28	-7.97	4.00	10500	20.00	-1.81	-13.01	-10.00	-26.97	4.00	0.50	-6.86	-0.73	-7.92	4.00	3.03	-2.34
10500	30.00	-1.53	-7.78	-0.81	-13.21	4.00	10500	30.00	-0.68	-13.96	-7.89	-12.43	4.00	1.93	-6.84	-0.03	-9.79	4.00	3.59	-1.45
10500	40.00	-3.37	-7.06	-0.90	-17.67	4.00	10500	40.00	-1.06	-10.21	-4.76	-12.50	4.00	0.95	-5.35	0.60	-11.35	4.00	3.51	-1.62
10500	50.00	-3.83	-14.83	-5.48	-17.44	4.00	10500	50.00	-2.85	-8.40	-5.84	-11.17	4.00	-0.30	-7.51	-2.65	-10.25	4.00	1.70	-3.59
10500	60.00	-2.92	-26.42	-6.27	-9.84	4.00	10500	60.00	-2.85	-1.44	-6.30	-9.28	4.00	0.13	-1.43	-3.27	-6.54	4.00	3.58	-2.14
10500	70.00	-2.13	-22.05	-5.33	-21.40	4.00	10500	70.00	-5.59	0.99	-10.28	-13.03	4.00	-0.51	1.01	-4.12	-12.44	4.00	3.31	-1.88
10500	80.00	-2.53	-16.13	-4.10	-6.61	4.00	10500	80.00	-11.7	0.78	-10.18	-14.16	4.00	-2.03	0.87	-3.14	-5.91	4.00	3.80	-1.89
10500	90.00	-2.92	-17.37	-2.86	-6.62	4.00	10500	90.00	-16.23	-1.54	-8.57	-5.65	4.00	-2.72	-1.43	-1.83	-3.10	4.00	3.78	-2.22
10500	100.00	-4.34	-35.72	-3.33	-15.48	4.00	10500	100.00	-13.86	-3.53	-8.28	-7.13	4.00	-3.88	-3.53	-2.12	-6.54	4.00	2.14	-3.75
10500	110.00	-4.73	-12.86	-7.91	-18.15	4.00	10500	110.00	-10.81	-3.73	-9.74	-22.90	4.00	-3.77	-3.23	-5.72	-16.90	4.00	-0.01	-5.29
10500	120.00	-3.97	-7.42	-8.18	-8.39	4.00	10500	120.00	-10.04	-4.28	-13.11	-3.89	4.00	-3.01	-2.56	-6.97	-2.57	4.00	2.42	-3.45
10500	130.00	-3.46	-7.04	-3.25	-6.44	4.00	10500	130.00	-6.34	-11.09	-15.60	-7.32	4.00	-1.66	-5.60	-3.00	-3.85	4.00	2.61	-3.30
10500	140.00	-3.32	-4.67	-2.17	-4.16	4.00	10500	140.00	-4.89	-16.36	-13.81	-12.44	4.00	-1.02	-4.39	-1.88	-3.56	4.00	3.41	-2.51
10500	150.00	-1.23	-4.01	-2.80	-4.69	4.00	10500	150.00	-5.46	-11.95	-19.35	-7.09	4.00	0.16	-3.36	-2.70	-2.72	4.00	3.98	-1.92
10500	160.00	-2.14	-2.11	-0.41	-5.99	4.00	10500	160.00	-4.66	-20.27	-17.79	-19.66	4.00	-0.21	-2.04	-0.33	-5.81	4.00	4.19	-1.60
10500	170.00	-3.05	-2.07	0.29	-2.52	4.00	10500	170.00	-5.01	-16.79	-23.93	-22.70	4.00	-0.91	-1.93	0.31	-2.48	4.00	4.83	-1.12
10500	180.00	-4.03	-6.19	1.39	-3.70	4.00	10500	180.00	-5.25	-9.59	-13.44	-12.07	4.00	-1.59	-4.56	1.53	-3.11	4.00	4.39	-1.31
10500	190.00	-4.09	-6.14	0.43	-5.11	4.00	10500	190.00	-9.04	-13.84	-9.84	-13.73	4.00	-2.88	-5.46	0.82	-4.55	4.00	3.35	-2.30
10500	200.00	-7.15	-15.84	-2.35	-5.92	4.00	10500	200.00	-5.78	-11.22	-8.99	-10.00	4.00	-3.40	-9.93	-1.50	-4.49	4.00	1.70	-3.92
10500	210.00	-7.13	-17.92	-3.50	-6.12	4.00	10500	210.00	-9.24	-8.67	-13.47	-15.04	4.00	-5.05	-8.18	-3.08	-5.60	4.00	0.73	-5.11
10500	220.00	-10.55	-15.17	-2.95	-6.71	4.00	10500	220.00	-15.16	-19.02	-14.27	-8.36	4.00	-9.26	-13.67	-2.64	-4.45	4.00	-0.50	-5.75
10500	230.00	-10.47	-9.18	-5.17	-6.81	4.00	10500	230.00	-12.99	-7.92	-12.27	-4.20	4.00	-8.54	-5.49	-4.40	-2.30	4.00	1.12	-4.64
10500	240.00	-11.75	-9.55	-12.08	-9.05	4.00	10500	240.00	-24.13	-16.88	-15.48	-1.55	4.00	-11.51	-8.81	-10.45	-0.84	4.00	-0.74	-5.54
10500	250.00	-17.77	-16.20	-8.80	-12.14	4.00	10500	250.00	-15.45	-11.08	-23.49	-0.52	4.00	-13.45	-9.92	-8.65	-0.23	4.00	-0.56	-5.12
10500	260.00	-10.04	-21.57	-3.69	-24.16	4.00	10500	260.00	-17.16	-4.19	-13.73	-1.11	4.00	-9.27	-4.11	-3.28	-1.09	4.00	2.06	-3.58
10500	270.00	-9.10	-12.80	-2.03	-18.45	4.00	10500	270.00	-15.28	-2.50	-11.24	-1.75	4.00	-8.16	-2.11	-1.54	-1.66	4.00	3.04	-2.69
10500	280.00	-14.34	-14.76	-1.84	-14.81	4.00	10500	280.00	-8.60	-1.34	-11.48	-3.00	4.00	-7.57	-1.15	-1.39	-2.72	4.00	3.16	-2.59
10500	290.00	-15.22	-15.45	-3.02	-9.72	4.00	10500	290.00	-5.39	-1.42	-15.45	-2.74	4.00	-4.96	-1.25	-2.78	-1.95	4.00	3.39	-2.53
10500	300.00	-6.64	-12.28	-5.49	-5.09	4.00	10500	300.00	-9.47	-2.38	-21.89	-3.22	4.00	-4.82	-1.96	-5.39	-1.04	4.00	2.91	-2.92
10500	310.00	-6.59	-8.71	-6.88	-2.78	4.00	10500	310.00	-12.48	-1.65	-15.82	-6.89	4.00	-5.59	-0.87	-6.36	-1.36	4.00	2.82	-2.89
10500	320.00	-8.71	-3.76	-4.00	-6.20	4.00	10500	320.00	-8.39	-6.29	-10.72	-7.15	4.00	-5.54	-1.83	-3.16	-3.64	4.00	2.58	-3.35
10500	330.00	-8.58	-4.56	-3.63	-9.15	4.00	10500	330.00	-5.69	-19.88	-12.16	-8.07	4.00	-3.89	-4.43	-3.06	-5.57	4.00	1.83	-4.14
10500	340.00	-12.36	-4.71	-5.48	-4.85	4.00	10500	340.00	-4.72	-10.88	-15.53	-7.13	4.00	-4.03	-3.77	-5.07	-2.83	4.00	2.13	-3.85
10500	350.00	-9.84	-3.59	-5.96	-6.09	4.00	10500	350.00	-5.75	-18.92	-16.19	-10.85	4.00	-4.32	-3.46	-5.57	-4.84	4.00	1.51	-4.48
12000	0.00	-8.41	-1.05	-5.04	-3.26	4.00	12000	0.00	-3.94	-10.81	-34.10	-17.43	4.00	-2.61	-0.61	-5.03	-3.10	4.00	3.32	-2.56
12000	10.00	-10.31	-2.03	-3.50	-3.76	4.00	12000	10.00	-6.62	-11.11	-13.48	-15.37	4.00	-5.07	-1.52	-3.08	-3.47	4.00	2.82	-3.11
12000	20.00	-6.55	-8.69	-2.95	-6.18	4.00	12000	20.00	-5.42	-13.55	-14.87	-7.32	4.00	-2.94	-7.46	-2.68	-3.70	4.00	2.02	-3.84
12000	30.00	-4.06	-10.01	-1.54	-4.64	4.00	12000	30.00	-4.44	-15.07	-10.76	-7.07	4.00	-1.28	-8.83	-1.05	-2.68	4.00	3.06	-2.60
12000	40.00	-5.53	-9.11	-2.81	-4.91	4.00	12000	40.00	-3.33	-7.05	-7.87	-8.37	4.00	-1.28	-4.95	-1.63	-3.29	4.00	3.35	-2.56
12000	50.00	-3.98	-14.13	-3.45	-7.86	4.00	12000	50.00	-2.37	-9.87	-6.96	-8.69	4.00	-0.09	-8.49	-1.85	-5.24	4.00	2.67	-2.85
12000	60.00	-1.24	-12.26	-8.47	-7.16	4.00	12000	60.00	-4.21	-7.39	-7.86	-4.27	4.00	0.53	-6.17	-5.14	-2.47	4.00	3.11	-2.51
12000	70.00	-0.38	-11.09	-9.75	-13.57	4.00	12000	70.00	-7.39	-2.09	-5.52	-6.90	4.00	0.41	-1.58	-4.13	-6.05	4.00	3.53	-2.17
12000	80.00	-1.39	-15.62	-5.16	-12.10	4.00	12000	80.00	-13.25	0.27	-6.15	-9.71	4.00	-1.12	0.38	-2.62	-7.73	4.00	3.74	-1.90
12000	90.00	-3.37	-20.90	-4.08	-11.71	4.00	12000	90.00	-24.32	-0.04	-11.79	-8.40	4.00	-3.34	0.00	-3.40	-6.74	4.00	2.98	-2.73
12000	100.00	-4.96	-11.12	-8.02	-12.08	4.00	12000	100.00	-15.99	-1.79	-20.03	-13.42	4.00	-4.63	-1.31	-8.32	-9.69	4.00	0.66	-4.75
12000	110.00	-6.03	-8.48	-21.07	-12.07	4.00	12000	110.00	-20.80	-3.81	-11.65	-13.33	4.00	-5.89	-2.54	-11.18	-9.64	4.00	-0.63	-6.02
12000	120.00	-7.81	-8.29	-11.59	-12.48	4.00	12000	120.00	-17.18	-8.12	-13.15	-6.15	4.00	-7.33	-5.19	-9.29	-5.24	4.00	-0.58	-6.46
12000	130.00	-6.81	-9.20	-4.81	-7.30	4.00	12000	130.00	-9.71	-10.33	-19.09	-10.57	4.00	-5.01	-6.72	-4.65	-5.62	4.00	0.55	-5.43
12000	140.00	-6.38	-9.68	-5.49	-6.83	4.00	12000	140.00	-6.45	-15.20	-22.90	-18.55	4.00	-3.40	-8.61	-5.41	-6.55	4.00	0.23	-5.59
12000	150.00	-7.01	-7.13	-7.32	-13.06	4.00	12000	150.00	-10.03	-27.83	-20.65	-14.85	4.00	-5.25	-7.09	-7.12	-10.85	4.00	-1.33	-7.16
12000	160.00	-6.33	-8.13	-2.34	-8.56	4.00	12000	160.00	-9.25	-15.48	-23.96	-14.18	4.00	-4.54	-7.40	-2.31	-7.51	4.00	0.86	-4.89
12000	170.00	-6.32	-6.31	-2.91	-5.76	4.00	12000	170.00	-8.92	-8.81	-36.13	-20.93	4.00	-4.42	-4.37	-2.91	-5.63	4.00	1.74	-4.22
12000	180.00	-8.06	-6.20	-3.39	-9.78	4.00	12000	180.00	-6.17	-10.94	-14.59	-10.09	4.00	-4.00	-4.94	-3.07	-6.92	4.00	1.40	-4.52
12000	190.00	-10.58	-3.69	-5.09	-16.13	4.00	12000	190.00	-9.26	-11.92	-8.58	-17.17	4.00	-6.86	-3.08	-3.48	-13.61	4.00	0.14	-5.27
12000	200.00	-12.82	-5.28	-8.76	-11.23	4.00	12000	200.00	-12.48	-8.71	-12.21	-13.79	4.00	-9.64	-3.65	-7.14	-9.31	4.00	-1.07	-6.73
12000	210.00	-12.23	-5.75	-8.72	-10.36	4.00	12000	210.00	-14.83	-17.71	-17.70	-17.50	4.00	-10.33	-5.48	-8.20	-9.59	4.00	-2.18	-7.98
12000	220.00	-14.03	-6.81	-7.00	-6.92	4.00	12000	220.00	-16.77	-8.00	-17.29	-18.81	4.00	-12.18	-4.35	-6.61	-6.65	4.00	-0.99	-6.67
12000	230.00	-23.36	-8.70	-7.43	-5.87	4.00	12000	230.00	-14.68	-11.54	-25.50	-8.22	4.00	-14.13	-6.88	-7.36	-3.88	4.00	-1.32	-6.79
12000	240.00	-25.22	-14.35	-21.52	-6.44	4.00	12000	240.00	-10.78	-14.42	-16.98	-3.17	4.00	-10.63	-11.3					



150.00	220.00	-17.87	-10.45	-16.04	-13.04	4.00	150.00	220.00	-13.20	-12.17	-16.21	-8.09	4.00
150.00	230.00	-28.58	-12.61	-27.32	-13.35	4.00	150.00	230.00	-12.14	-15.73	-17.99	-4.70	4.00
150.00	240.00	-20.50	-29.19	-24.85	-16.83	4.00	150.00	240.00	-13.75	-21.40	-14.42	-4.29	4.00
150.00	250.00	-14.51	-19.87	-21.69	-18.37	4.00	150.00	250.00	-16.14	-15.19	-13.23	-4.40	4.00
150.00	260.00	-13.74	-29.25	-21.93	-12.75	4.00	150.00	260.00	-15.88	-13.61	-13.69	-4.79	4.00
150.00	270.00	-16.14	-18.26	-15.93	-9.97	4.00	150.00	270.00	-12.55	-8.41	-18.59	-5.53	4.00
150.00	280.00	-19.01	-12.34	-16.84	-11.06	4.00	150.00	280.00	-12.35	-1.94	-21.98	-6.66	4.00
150.00	290.00	-14.45	-7.25	-18.72	-10.33	4.00	150.00	290.00	-12.89	0.92	-16.25	-6.74	4.00
150.00	300.00	-12.05	-4.95	-18.80	-8.40	4.00	150.00	300.00	-12.47	1.40	-12.20	-7.83	4.00
150.00	310.00	-13.03	-2.73	-11.82	-6.47	4.00	150.00	310.00	-8.37	0.38	-13.83	-7.76	4.00
150.00	320.00	-16.93	-0.92	-13.13	-4.55	4.00	150.00	320.00	-7.48	-0.49	-20.28	-8.19	4.00
150.00	330.00	-14.80	-0.29	-18.90	-3.44	4.00	150.00	330.00	-10.25	-1.13	-17.18	-10.70	4.00
150.00	340.00	-8.77	-0.40	-15.15	-7.12	4.00	150.00	340.00	-18.97	-2.74	-13.41	-12.95	4.00
150.00	350.00	-6.83	0.30	-13.96	-10.10	4.00	150.00	350.00	-17.74	-5.42	-14.00	-14.75	4.00
165.00	0.00	-13.19	1.03	-8.78	-4.15	4.00	165.00	0.00	-9.83	-2.66	-13.81	-13.14	4.00
165.00	10.00	-13.72	0.62	-7.60	-4.16	4.00	165.00	10.00	-10.21	-1.83	-15.83	-12.25	4.00
165.00	20.00	-10.60	-1.43	-7.68	-7.06	4.00	165.00	20.00	-9.51	-0.41	-22.67	-15.41	4.00
165.00	30.00	-12.09	-4.84	-8.84	-11.01	4.00	165.00	30.00	-8.86	-0.42	-17.04	-18.83	4.00
165.00	40.00	-10.05	-9.65	-9.75	-12.85	4.00	165.00	40.00	-8.07	-1.73	-11.48	-21.41	4.00
165.00	50.00	-7.89	-19.00	-11.50	-11.94	4.00	165.00	50.00	-8.39	-3.51	-10.84	-19.25	4.00
165.00	60.00	-6.87	-25.12	-9.51	-9.73	4.00	165.00	60.00	-8.69	-6.12	-11.42	-16.97	4.00
165.00	70.00	-6.53	-23.17	-9.18	-10.24	4.00	165.00	70.00	-9.40	-7.35	-11.81	-9.72	4.00
165.00	80.00	-6.54	-21.93	-9.16	-11.61	4.00	165.00	80.00	-8.84	-6.63	-12.50	-7.01	4.00
165.00	90.00	-6.88	-13.88	-10.75	-19.93	4.00	165.00	90.00	-8.59	-4.97	-15.06	-5.13	4.00
165.00	100.00	-8.55	-11.96	-10.65	-26.09	4.00	165.00	100.00	-7.70	-4.89	-15.05	-4.92	4.00
165.00	110.00	-11.32	-10.07	-11.61	-14.41	4.00	165.00	110.00	-8.58	-6.99	-13.02	-6.78	4.00
165.00	120.00	-15.68	-10.46	-12.41	-11.28	4.00	165.00	120.00	-9.70	-11.05	-10.18	-10.19	4.00
165.00	130.00	-18.15	-10.78	-12.88	-10.46	4.00	165.00	130.00	-15.25	-19.64	-11.06	-13.41	4.00
165.00	140.00	-17.35	-7.59	-11.74	-11.52	4.00	165.00	140.00	-20.10	-15.96	-13.36	-17.62	4.00
165.00	150.00	-17.98	-4.30	-12.71	-7.73	4.00	165.00	150.00	-25.47	-17.04	-15.85	-18.30	4.00
165.00	160.00	-17.23	-3.10	-14.05	-4.37	4.00	165.00	160.00	-24.99	-30.57	-15.25	-13.56	4.00
165.00	170.00	-17.37	-4.13	-15.01	-4.32	4.00	165.00	170.00	-23.69	-17.30	-17.97	-10.93	4.00
165.00	180.00	-17.15	-5.67	-16.42	-7.38	4.00	165.00	180.00	-14.95	-15.07	-19.32	-14.05	4.00
165.00	190.00	-15.73	-5.80	-19.50	-8.37	4.00	165.00	190.00	-13.41	-24.37	-17.65	-22.68	4.00
165.00	200.00	-17.55	-8.58	-24.27	-7.28	4.00	165.00	200.00	-13.41	-22.18	-18.10	-25.96	4.00
165.00	210.00	-20.62	-15.71	-25.72	-8.49	4.00	165.00	210.00	-13.31	-19.52	-17.74	-13.53	4.00
165.00	220.00	-23.96	-15.38	-19.68	-7.79	4.00	165.00	220.00	-14.75	-15.01	-17.23	-8.37	4.00
165.00	230.00	-23.70	-12.89	-16.63	-8.17	4.00	165.00	230.00	-14.73	-8.99	-16.69	-5.94	4.00
165.00	240.00	-16.78	-12.39	-15.84	-11.15	4.00	165.00	240.00	-12.15	-5.88	-14.60	-4.02	4.00
165.00	250.00	-11.30	-14.27	-13.19	-16.49	4.00	165.00	250.00	-12.96	-5.22	-13.15	-3.21	4.00
165.00	260.00	-7.84	-14.87	-11.51	-16.33	4.00	165.00	260.00	-15.27	-6.80	-12.12	-4.19	4.00
165.00	270.00	-7.78	-14.36	-11.84	-10.58	4.00	165.00	270.00	-13.03	-10.26	-10.73	-6.67	4.00
165.00	280.00	-10.31	-10.37	-13.95	-9.14	4.00	165.00	280.00	-9.83	-17.22	-10.08	-11.98	4.00
165.00	290.00	-11.27	-9.49	-13.70	-7.02	4.00	165.00	290.00	-8.89	-14.14	-9.73	-25.45	4.00
165.00	300.00	-12.35	-9.82	-12.67	-6.62	4.00	165.00	300.00	-8.46	-7.59	-9.28	-12.73	4.00
165.00	310.00	-13.55	-8.08	-10.53	-5.41	4.00	165.00	310.00	-8.53	-4.65	-11.69	-11.27	4.00
165.00	320.00	-18.07	-4.19	-9.34	-4.86	4.00	165.00	320.00	-11.02	-3.76	-16.25	-15.09	4.00
165.00	330.00	-15.69	-1.78	-9.96	-5.03	4.00	165.00	330.00	-12.16	-3.96	-18.18	-22.00	4.00
165.00	340.00	-13.79	0.24	-9.16	-6.45	4.00	165.00	340.00	-11.36	-4.79	-18.08	-15.35	4.00
165.00	350.00	-11.79	0.91	-8.94	-5.64	4.00	165.00	350.00	-9.76	-4.11	-18.91	-12.41	4.00
180.00	0.00	-8.19	-10.89	-11.29	-8.36	4.00	180.00	0.00	-11.33	-16.28	-16.00	-11.82	4.00
180.00	10.00	-7.32	-10.24	-10.57	-7.52	4.00	180.00	10.00	-14.00	-19.86	-19.28	-14.60	4.00
180.00	20.00	-6.77	-9.88	-10.16	-7.00	4.00	180.00	20.00	-18.29	-26.63	-25.10	-19.14	4.00
180.00	30.00	-6.51	-9.79	-10.02	-6.77	4.00	180.00	30.00	-27.91	-40.17	-50.02	-30.12	4.00
180.00	40.00	-6.51	-9.97	-10.15	-6.80	4.00	180.00	40.00	-27.43	-23.62	-25.36	-26.21	4.00
180.00	50.00	-6.78	-10.43	-10.56	-7.09	4.00	180.00	50.00	-18.14	-18.42	-19.41	-17.88	4.00
180.00	60.00	-7.34	-11.19	-11.26	-7.68	4.00	180.00	60.00	-13.91	-15.37	-16.08	-13.88	4.00
180.00	70.00	-8.22	-12.33	-12.32	-8.60	4.00	180.00	70.00	-11.27	-13.32	-13.89	-11.34	4.00
180.00	80.00	-9.51	-13.95	-13.83	-9.93	4.00	180.00	80.00	-9.46	-11.89	-12.36	-9.59	4.00
180.00	90.00	-11.33	-16.28	-16.00	-11.82	4.00	180.00	90.00	-8.19	-10.89	-11.29	-8.36	4.00
180.00	100.00	-14.00	-19.86	-19.28	-14.60	4.00	180.00	100.00	-7.32	-10.24	-10.57	-7.52	4.00
180.00	110.00	-18.29	-26.63	-25.10	-19.14	4.00	180.00	110.00	-6.77	-9.88	-10.16	-7.00	4.00
180.00	120.00	-27.91	-40.17	-50.02	-30.12	4.00	180.00	120.00	-6.51	-9.79	-10.02	-6.77	4.00
180.00	130.00	-27.43	-23.62	-25.36	-26.21	4.00	180.00	130.00	-6.51	-9.97	-10.15	-6.80	4.00
180.00	140.00	-18.14	-18.42	-19.41	-17.88	4.00	180.00	140.00	-6.78	-10.43	-10.56	-7.09	4.00
180.00	150.00	-13.91	-15.37	-16.08	-13.88	4.00	180.00	150.00	-7.34	-11.19	-11.26	-7.68	4.00
180.00	160.00	-11.27	-13.32	-13.89	-11.34	4.00	180.00	160.00	-8.22	-12.33	-12.32	-8.60	4.00
180.00	170.00	-9.46	-11.89	-12.36	-9.59	4.00	180.00	170.00	-9.51	-13.95	-13.83	-9.93	4.00
180.00	180.00	-8.19	-10.89	-11.29	-8.36	4.00	180.00	180.00	-11.33	-16.28	-16.00	-11.82	4.00
180.00	190.00	-7.32	-10.24	-10.57	-7.52	4.00	180.00	190.00	-14.00	-19.86	-19.28	-14.60	4.00
180.00	200.00	-6.77	-9.88	-10.16	-7.00	4.00	180.00	200.00	-18.29	-26.63	-25.10	-19.14	4.00
180.00	210.00	-6.51	-9.79	-10.02	-6.77	4.00	180.00	210.00	-27.91	-40.17	-50.02	-30.12	4.00
180.00	220.00	-6.51	-9.97	-10.15	-6.80	4.00	180.00	220.00	-27.43	-23.62	-25.36	-26.21	4.00
180.00	230.00	-6.78	-10.43	-10.56	-7.09	4.00	180.00	230.00	-18.14	-18.42	-19.41	-17.88	4.00
180.00	240.00	-7.34	-11.19	-11.26	-7.68	4.00	180.00	240.00	-13.91	-15.37	-16.08	-13.88	4.00
180.00	250.00	-8.22	-12.33	-12.32	-8.60	4.00	180.00	250.00	-11.27	-13.32	-13.89	-11.34	4.00
180.00	260.00	-9.51	-13.95	-13.83	-9.93	4.00	180.00	260.00	-9.46	-11.89	-12.36	-9.59	4.00
180.00	270.00	-11.33	-16.28	-16.00	-11.82	4.00	180.00	270.00	-8.19	-10.89	-11.29	-8.36	4.00
180.00	280.00	-14.00	-19.86	-19.28	-14.60	4.00	180.00	280.00	-7.32	-10.24	-10.57	-7.52	4.00
180.00	290.00	-18.29	-26.63	-25.10	-19.14	4.00	180.00	290.00	-6.77	-9.88	-10.16	-7.00	4.00
180.00	300.00	-27.91	-40.17	-50.02	-30.12	4.00	180.00	300.00	-6.51	-9.79	-10.02	-6.77	4.00
180.00	310.00	-27.43	-23.62	-25.36	-26.21	4.00	180.00	310.00	-6.51	-9.97	-10.15	-6.80	4.00
180.00	320.00	-18.14	-18.42	-19.41	-17.88	4.00	180.00	320.00	-6.78	-10.43	-10.56	-7.09	4.00
180.00	330.00	-13.91	-15.37	-16.08	-13.88	4.00	180.00	330.00	-7.34	-11.19	-11.26	-7.68	4.00
180.00	340.00	-11.27	-13.32	-13.89	-11.34	4.00	180.00	340.00	-8.22	-12.33	-12.32	-8.60	4.00
180.00	350.00	-9.46	-11.89	-12.36	-9.59	4.00	180.00	350.00	-9.51				



Frequency: 5500MHz

Theta Polarization		Max Gain(dB)				Nant	Angle (θ)	Angle (ψ)	Phi Polarization				Nant	Total				Max DG(dB)	Max DG(dB)					
Angle (θ)	Angle (ψ)	Ant 1(G1) Ant 2(G2) Ant 3(G3) Ant 4(G4)							Angle (θ)	Angle (ψ)	Ant 1(G1) Ant 2(G2) Ant 3(G3) Ant 4(G4)				Nant	Max Gain(dB)				Max DG(dB)	Max DG(dB)			
		1.08 5.12 4.78 0.96									0.50 5.12 -3.25 2.53					3.09 5.14 4.83 3.20								
		Ant 1(G1)	Ant 2(G2)	Ant 3(G3)	Ant 4(G4)						Ant 1(G1)	Ant 2(G2)		Ant 3(G3)		Ant 4(G4)	Ant 1(G1)					Ant 2(G2)	Ant 3(G3)	Ant 4(G4)
0.00	0.00	-12.72	5.12	-20.06	-0.05	4.00	0.00	0.00	-5.52	-17.56	-6.65	-15.21	4.00	-4.76	5.14	-6.46	0.08	4.00	5.74	0.83				
0.00	10.00	-9.91	5.10	-14.97	0.08	4.00	0.00	10.00	-6.35	-14.77	-7.12	-39.92	4.00	-4.76	5.14	-6.46	0.08	4.00	5.73	0.83				
0.00	20.00	-7.99	4.81	-11.96	-0.06	4.00	0.00	20.00	-7.56	-6.16	-7.90	-15.05	4.00	-4.76	5.14	-6.46	0.08	4.00	5.73	0.83				
0.00	30.00	-6.65	4.23	-9.94	-0.47	4.00	0.00	30.00	-9.29	-2.08	-9.05	-9.20	4.00	-4.76	5.14	-6.46	0.08	4.00	5.73	0.83				
0.00	40.00	-5.72	3.32	-8.52	-1.18	4.00	0.00	40.00	-11.80	0.48	-10.68	-5.92	4.00	-4.76	5.14	-6.46	0.08	4.00	5.73	0.83				
0.00	50.00	-5.12	2.01	-7.54	-2.25	4.00	0.00	50.00	-15.74	2.25	-13.04	-3.74	4.00	-4.76	5.14	-6.46	0.08	4.00	5.73	0.83				
0.00	60.00	-4.82	0.14	-6.89	-3.78	4.00	0.00	60.00	-23.79	3.49	-16.69	-2.22	4.00	-4.76	5.14	-6.46	0.08	4.00	5.73	0.83				
0.00	70.00	-4.78	-2.60	-6.54	-5.97	4.00	0.00	70.00	-28.85	4.34	-23.65	-1.16	4.00	-4.76	5.14	-6.46	0.08	4.00	5.73	0.83				
0.00	80.00	-5.01	-7.06	-6.47	-9.28	4.00	0.00	80.00	-17.35	4.87	-35.37	-0.46	4.00	-4.76	5.14	-6.46	0.08	4.00	5.73	0.83				
0.00	90.00	-5.52	-17.56	-6.65	-15.21	4.00	0.00	90.00	-12.72	5.12	-20.06	-0.05	4.00	-4.76	5.14	-6.46	0.08	4.00	5.74	0.83				
0.00	100.00	-6.35	-14.77	-7.12	-39.92	4.00	0.00	100.00	-9.91	5.10	-14.97	0.08	4.00	-4.76	5.14	-6.46	0.08	4.00	5.73	0.83				
0.00	110.00	-7.56	-6.16	-7.90	-15.05	4.00	0.00	110.00	-7.99	4.81	-11.96	-0.06	4.00	-4.76	5.14	-6.46	0.08	4.00	5.73	0.83				
0.00	120.00	-9.29	-2.08	-9.05	-9.20	4.00	0.00	120.00	-6.65	4.23	-9.94	-0.47	4.00	-4.76	5.14	-6.46	0.08	4.00	5.73	0.83				
0.00	130.00	-11.80	0.48	-10.68	-5.92	4.00	0.00	130.00	-5.72	3.32	-8.52	-1.18	4.00	-4.76	5.14	-6.46	0.08	4.00	5.73	0.83				
0.00	140.00	-15.74	2.25	-13.04	-3.74	4.00	0.00	140.00	-5.12	2.01	-7.54	-2.25	4.00	-4.76	5.14	-6.46	0.08	4.00	5.73	0.83				
0.00	150.00	-23.79	3.49	-16.69	-2.22	4.00	0.00	150.00	-4.82	0.14	-6.89	-3.78	4.00	-4.76	5.14	-6.46	0.08	4.00	5.73	0.83				
0.00	160.00	-28.85	4.34	-23.65	-1.16	4.00	0.00	160.00	-4.78	-2.60	-6.54	-5.97	4.00	-4.76	5.14	-6.46	0.08	4.00	5.73	0.83				
0.00	170.00	-17.35	4.87	-35.37	-0.46	4.00	0.00	170.00	-5.01	-7.06	-6.47	-9.28	4.00	-4.76	5.14	-6.46	0.08	4.00	5.73	0.83				
0.00	180.00	-12.72	5.12	-20.06	-0.05	4.00	0.00	180.00	-5.52	-17.56	-6.65	-15.21	4.00	-4.76	5.14	-6.46	0.08	4.00	5.74	0.83				
0.00	190.00	-9.91	5.10	-14.97	0.08	4.00	0.00	190.00	-6.35	-14.77	-7.12	-39.92	4.00	-4.76	5.14	-6.46	0.08	4.00	5.73	0.83				
0.00	200.00	-7.99	4.81	-11.96	-0.06	4.00	0.00	200.00	-7.56	-6.16	-7.90	-15.05	4.00	-4.76	5.14	-6.46	0.08	4.00	5.73	0.83				
0.00	210.00	-6.65	4.23	-9.94	-0.47	4.00	0.00	210.00	-9.29	-2.08	-9.05	-9.20	4.00	-4.76	5.14	-6.46	0.08	4.00	5.73	0.83				
0.00	220.00	-5.72	3.32	-8.52	-1.18	4.00	0.00	220.00	-11.80	0.48	-10.68	-5.92	4.00	-4.76	5.14	-6.46	0.08	4.00	5.73	0.83				
0.00	230.00	-5.12	2.01	-7.54	-2.25	4.00	0.00	230.00	-15.74	2.25	-13.04	-3.74	4.00	-4.76	5.14	-6.46	0.08	4.00	5.73	0.83				
0.00	240.00	-4.82	0.14	-6.89	-3.78	4.00	0.00	240.00	-23.79	3.49	-16.69	-2.22	4.00	-4.76	5.14	-6.46	0.08	4.00	5.73	0.83				
0.00	250.00	-4.78	-2.60	-6.54	-5.97	4.00	0.00	250.00	-28.85	4.34	-23.65	-1.16	4.00	-4.76	5.14	-6.46	0.08	4.00	5.73	0.83				
0.00	260.00	-5.01	-7.06	-6.47	-9.28	4.00	0.00	260.00	-17.35	4.87	-35.37	-0.46	4.00	-4.76	5.14	-6.46	0.08	4.00	5.73	0.83				
0.00	270.00	-5.52	-17.56	-6.65	-15.21	4.00	0.00	270.00	-12.72	5.12	-20.06	-0.05	4.00	-4.76	5.14	-6.46	0.08	4.00	5.74	0.83				
0.00	280.00	-6.35	-14.77	-7.12	-39.92	4.00	0.00	280.00	-9.91	5.10	-14.97	0.08	4.00	-4.76	5.14	-6.46	0.08	4.00	5.73	0.83				
0.00	290.00	-7.56	-6.16	-7.90	-15.05	4.00	0.00	290.00	-7.99	4.81	-11.96	-0.06	4.00	-4.76	5.14	-6.46	0.08	4.00	5.73	0.83				
0.00	300.00	-9.29	-2.08	-9.05	-9.20	4.00	0.00	300.00	-6.65	4.23	-9.94	-0.47	4.00	-4.76	5.14	-6.46	0.08	4.00	5.73	0.83				
0.00	310.00	-11.80	0.48	-10.68	-5.92	4.00	0.00	310.00	-5.72	3.32	-8.52	-1.18	4.00	-4.76	5.14	-6.46	0.08	4.00	5.73	0.83				
0.00	320.00	-15.74	2.25	-13.04	-3.74	4.00	0.00	320.00	-5.12	2.01	-7.54	-2.25	4.00	-4.76	5.14	-6.46	0.08	4.00	5.73	0.83				
0.00	330.00	-23.79	3.49	-16.69	-2.22	4.00	0.00	330.00	-4.82	0.14	-6.89	-3.78	4.00	-4.76	5.14	-6.46	0.08	4.00	5.73	0.83				
0.00	340.00	-28.85	4.34	-23.65	-1.16	4.00	0.00	340.00	-4.78	-2.60	-6.54	-5.97	4.00	-4.76	5.14	-6.46	0.08	4.00	5.73	0.83				
0.00	350.00	-17.35	4.87	-35.37	-0.46	4.00	0.00	350.00	-5.01	-7.06	-6.47	-9.28	4.00	-4.76	5.14	-6.46	0.08	4.00	5.73	0.83				
15.00	0.00	-4.30	4.62	-10.15	-1.41	4.00	15.00	0.00	-2.80	-11.25	-5.13	-15.05	4.00	-0.48	4.73	-3.94	-1.23	4.00	6.39	0.99				
15.00	10.00	-6.45	4.88	-8.02	-1.53	4.00	15.00	10.00	-2.41	-16.60	-5.81	-10.10	4.00	-0.97	4.91	-3.77	-0.96	4.00	6.44	1.07				
15.00	20.00	-9.06	4.60	-6.63	-1.68	4.00	15.00	20.00	-3.96	-7.61	-11.89	-7.65	4.00	-2.79	4.85	-5.50	-0.70	4.00	5.86	0.72				
15.00	30.00	-10.72	3.67	-7.65	-2.04	4.00	15.00	30.00	-4.84	-2.59	-19.59	-6.06	4.00	-3.84	4.59	-7.38	-0.59	4.00	5.35	0.36				
15.00	40.00	-10.78	2.03	-7.64	-3.24	4.00	15.00	40.00	-4.70	-0.54	-18.95	-3.95	4.00	-3.74	3.94	-7.33	-0.57	4.00	5.08	-0.04				
15.00	50.00	-7.27	0.02	-6.51	-5.31	4.00	15.00	50.00	-6.74	0.23	-33.00	-1.98	4.00	-3.99	3.14	-6.50	-0.32	4.00	4.87	-0.44				
15.00	60.00	-5.23	-1.97	-6.93	-8.59	4.00	15.00	60.00	-11.05	0.71	-16.36	-1.02	4.00	-4.22	2.58	-6.46	-0.32	4.00	4.61	-0.77				
15.00	70.00	-4.35	-4.70	-6.87	-17.08	4.00	15.00	70.00	-19.63	1.50	-15.71	-0.66	4.00	-4.22	2.43	-6.34	-0.56	4.00	4.50	-0.91				
15.00	80.00	-4.60	-6.92	-6.25	-27.57	4.00	15.00	80.00	-23.38	2.09	-14.57	-0.76	4.00	-4.54	2.60	-5.65	-0.75	4.00	4.56	-0.85				
15.00	90.00	-6.15	-9.70	-5.41	-14.52	4.00	15.00	90.00	-13.80	1.92	-15.22	-0.63	4.00	-5.46	2.21	-4.98	-0.46	4.00	4.44	-1.02				
15.00	100.00	-6.82	-10.45	-4.98	-9.64	4.00	15.00	100.00	-8.16	1.68	-15.52	-1.03	4.00	-4.43	1.94	-4.61	-0.47	4.00	4.57	-1.01				
15.00	110.00	-9.78	-7.09	-4.64	-7.25	4.00	15.00	110.00	-6.17	1.81	-16.10	-2.54	4.00	-4.60	2.34	-4.34	-1.28	4.00	4.53	-1.01				
15.00	120.00	-12.42	-2.89	-4.81	-4.54	4.00	15.00	120.00	-4.44	1.37	-17.46	-3.07	4.00	-3.80	2.75	-4.58	-0.73	4.00	4.93	-0.59				
15.00	130.00	-18.26	-0.07	-4.14	-2.52	4.00	15.00	130.00	-3.13	0.71	-18.13	-4.14	4.00	-3.00	3.35	-3.97	-0.24	4.00	5.54	0.01				
15.00	140.00	-24.00	1.95	-4.82	-1.35	4.00	15.00	140.00	-2.30	-0.72	-17.71	-5.93	4.00	-2.27	3.83	-4.60	-0.05	4.00	5.81	0.36				
15.00	150.00	-15.14	3.19	-5.47	-1.06	4.00	15.00	150.00	-2.02	-2.54	-14.65	-8.82	4.00	-1.81	4.22	-4.97	-0.39	4.00	5.93	0.54				
15.00	160.00	-10.40	3.59	-6.06	-0.43	4.00	15.00	160.00	-2.07	-5.26	-14.21	-13.02	4.00	-1.47	4.12	-5.44	-0.20	4.00	5.94	0.55				
15.00	170.00	-6.10	3.75	-7.65	-0.48	4.00	15.00	170.00	-2.21	-8.87	-9.94	-14.15	4.00	-0.72	3.98	-5.64	-0.30	4.00	6.00	0.56				
15.00	180.00	-5.24	3.36	-9.62	-0.96	4.00	15.00	180.00	-5.51	-15.29	-9.02	-10.14	4.00	-2.36	3.42	-6.30	-0.46	4.00	5.29	-0.10				
15.00	190.00	-3.25	3.32	-12.39	-0.60	4.00	15.00	190.00	-6.01	-14.57	-9.41	-7.82	4.00	-1.40	3.39	-7.64	0.15	4.00	5.49	0.12				
15.00	200.00	-2.94	2.60	-17.20	-0.52	4.00	15.00	200.00	-6.99	-6.63	-8.66	-5.58	4.00	-1.50	3.09	-8.09	0.66	4.00	5.44	0.07				
15.00	210.00	-3.35	1.52	-20.87	-0.38	4.00	15.00	210.00	-7.55	-3.24	-9.35	-4.18	4.00	-1.95	2.77	-9.05	1.13	4.00	5.27	-0.05				
15.00	220.00	-2.89	0.09	-27.57	-0.86	4.00	15.00	220.00	-11.01	-0.32	-9.66	-												



45.00	140.00	-3.85	-5.51	3.39	-0.31	4.00	45.00	140.00	-0.65	-0.37	-18.98	-1.95	4.00
45.00	150.00	-2.91	-2.07	3.41	0.96	4.00	45.00	150.00	-0.73	-0.80	-42.08	-3.19	4.00
45.00	160.00	-2.09	0.86	3.11	0.24	4.00	45.00	160.00	-1.24	-3.17	-26.27	-5.69	4.00
45.00	170.00	0.23	0.95	2.90	-3.06	4.00	45.00	170.00	-2.61	-4.37	-14.38	-9.07	4.00
45.00	180.00	1.08	-1.81	1.29	-0.67	4.00	45.00	180.00	-3.39	-5.54	-6.47	-10.08	4.00
45.00	190.00	0.87	-5.88	-0.15	-0.34	4.00	45.00	190.00	-3.66	-9.50	-3.25	-17.90	4.00
45.00	200.00	0.83	-6.28	-0.86	-1.97	4.00	45.00	200.00	-8.48	-12.48	-4.24	-22.34	4.00
45.00	210.00	0.37	-5.58	-1.46	-3.16	4.00	45.00	210.00	-7.48	-12.63	-6.34	-13.72	4.00
45.00	220.00	-0.86	-4.93	-2.16	-1.34	4.00	45.00	220.00	-10.75	-13.38	-6.79	-3.59	4.00
45.00	230.00	-1.37	-6.34	-3.47	-1.35	4.00	45.00	230.00	-17.04	-10.38	-6.40	-0.21	4.00
45.00	240.00	-0.88	-9.27	-5.41	-3.49	4.00	45.00	240.00	-17.08	-7.11	-7.84	1.25	4.00
45.00	250.00	-1.74	-11.65	-7.39	-6.95	4.00	45.00	250.00	-18.62	-6.40	-11.73	1.81	4.00
45.00	260.00	-3.45	-14.22	-7.13	-10.52	4.00	45.00	260.00	-10.34	-7.00	-18.12	1.96	4.00
45.00	270.00	-3.67	-12.73	-6.17	-12.97	4.00	45.00	270.00	-8.39	-6.50	-15.83	1.63	4.00
45.00	280.00	-4.33	-11.65	-4.26	-16.93	4.00	45.00	280.00	-7.41	-3.94	-10.79	1.62	4.00
45.00	290.00	-3.33	-10.93	-3.64	-16.48	4.00	45.00	290.00	-5.87	-0.88	-9.30	1.41	4.00
45.00	300.00	-3.36	-9.65	-2.98	-11.55	4.00	45.00	300.00	-5.19	0.26	-7.73	1.42	4.00
45.00	310.00	-2.33	-5.23	-2.14	-8.44	4.00	45.00	310.00	-6.03	-0.10	-8.23	0.10	4.00
45.00	320.00	-1.59	-3.92	-0.87	-6.54	4.00	45.00	320.00	-4.82	-1.56	-8.57	-2.38	4.00
45.00	330.00	-1.04	-2.60	-0.32	-7.12	4.00	45.00	330.00	-3.97	-2.53	-7.53	-5.40	4.00
45.00	340.00	-0.27	-1.59	-0.77	-4.07	4.00	45.00	340.00	-4.20	-5.56	-5.30	-7.39	4.00
45.00	350.00	-1.64	-2.07	-1.15	-4.04	4.00	45.00	350.00	-1.66	-5.86	-4.55	-13.24	4.00
60.00	0.00	-2.05	-8.93	1.36	-10.14	4.00	60.00	0.00	-1.97	-12.25	-6.11	-11.79	4.00
60.00	10.00	-2.89	-13.00	2.02	-7.77	4.00	60.00	10.00	-1.36	-10.39	-10.31	-9.78	4.00
60.00	20.00	-3.17	-9.60	1.07	-6.25	4.00	60.00	20.00	-1.74	-8.81	-16.86	-4.44	4.00
60.00	30.00	-4.99	-7.57	0.37	-4.75	4.00	60.00	30.00	-2.36	-7.21	-19.18	-4.50	4.00
60.00	40.00	-5.21	-8.90	1.11	-9.50	4.00	60.00	40.00	-3.02	-3.73	-18.97	-5.31	4.00
60.00	50.00	-7.41	-14.14	1.11	-12.95	4.00	60.00	50.00	-5.22	-1.75	-12.35	-3.74	4.00
60.00	60.00	-12.97	-17.25	-1.47	-14.97	4.00	60.00	60.00	-9.77	-0.66	-12.74	-3.43	4.00
60.00	70.00	-14.92	-11.99	-3.72	-17.88	4.00	60.00	70.00	-18.52	-0.44	-16.68	-3.63	4.00
60.00	80.00	-9.96	-11.28	-2.83	-16.30	4.00	60.00	80.00	-24.10	0.21	-21.18	-3.17	4.00
60.00	90.00	-8.09	-18.02	-2.15	-14.14	4.00	60.00	90.00	-11.64	1.31	-16.80	-2.50	4.00
60.00	100.00	-6.59	-18.14	-1.80	-15.76	4.00	60.00	100.00	-6.73	2.09	-15.34	-1.49	4.00
60.00	110.00	-5.47	-10.14	-0.59	-12.47	4.00	60.00	110.00	-3.78	1.59	-14.16	-0.57	4.00
60.00	120.00	-4.33	-6.40	0.91	-7.38	4.00	60.00	120.00	-1.54	0.96	-12.53	-0.77	4.00
60.00	130.00	-3.22	-5.88	2.27	-10.96	4.00	60.00	130.00	-0.53	-0.63	-10.22	-0.84	4.00
60.00	140.00	-2.16	-3.76	2.96	-11.53	4.00	60.00	140.00	-0.01	-4.36	-11.65	-0.80	4.00
60.00	150.00	-1.14	-1.20	3.75	-6.34	4.00	60.00	150.00	0.17	-6.08	-13.96	-3.28	4.00
60.00	160.00	-1.29	-0.62	4.46	-2.58	4.00	60.00	160.00	0.06	-7.85	-21.11	-4.19	4.00
60.00	170.00	0.10	-2.62	4.78	-6.79	4.00	60.00	170.00	0.06	-5.25	-14.93	-7.71	4.00
60.00	180.00	0.52	-9.61	3.47	-7.06	4.00	60.00	180.00	-1.84	-3.04	-5.59	-25.60	4.00
60.00	190.00	0.23	-13.63	2.11	-7.28	4.00	60.00	190.00	-4.41	-6.06	-4.21	-12.30	4.00
60.00	200.00	0.86	-10.70	1.36	-6.37	4.00	60.00	200.00	-7.08	-8.79	-6.02	-19.23	4.00
60.00	210.00	-0.66	-9.32	0.90	-2.09	4.00	60.00	210.00	-10.83	-7.68	-6.67	-6.31	4.00
60.00	220.00	-0.92	-12.94	-0.49	-2.14	4.00	60.00	220.00	-16.79	-6.54	-5.15	-1.84	4.00
60.00	230.00	-2.35	-9.34	-2.45	-3.67	4.00	60.00	230.00	-16.43	-3.98	-6.40	-0.21	4.00
60.00	240.00	-1.66	-8.52	-4.20	-5.05	4.00	60.00	240.00	-16.19	-2.53	-10.10	-0.39	4.00
60.00	250.00	-1.89	-12.11	-5.35	-7.64	4.00	60.00	250.00	-13.01	-1.90	-12.77	-0.28	4.00
60.00	260.00	-2.99	-15.50	-4.75	-11.62	4.00	60.00	260.00	-12.26	-1.48	-12.67	0.66	4.00
60.00	270.00	-4.33	-24.35	-3.12	-12.75	4.00	60.00	270.00	-10.64	-2.31	-9.79	-1.03	4.00
60.00	280.00	-5.46	-28.09	-3.25	-10.52	4.00	60.00	280.00	-9.31	-2.95	-7.06	-2.94	4.00
60.00	290.00	-9.95	-23.48	-4.24	-7.65	4.00	60.00	290.00	-10.32	-2.31	-5.30	-4.41	4.00
60.00	300.00	-4.31	-19.12	-3.50	-5.43	4.00	60.00	300.00	-9.72	-1.35	-4.83	-4.02	4.00
60.00	310.00	-1.10	-13.46	-2.52	-3.78	4.00	60.00	310.00	-7.38	-1.04	-5.84	-3.10	4.00
60.00	320.00	0.32	-10.37	-0.97	-4.07	4.00	60.00	320.00	-7.05	-2.67	-7.42	-3.07	4.00
60.00	330.00	0.36	-13.22	-0.76	-5.53	4.00	60.00	330.00	-4.43	-4.76	-8.20	-7.24	4.00
60.00	340.00	-0.67	-11.59	-0.58	-8.51	4.00	60.00	340.00	-3.90	-9.71	-7.90	-7.13	4.00
60.00	350.00	-1.52	-8.60	-0.85	-11.97	4.00	60.00	350.00	-1.82	-11.99	-6.85	-8.90	4.00
75.00	0.00	-1.83	-13.21	1.64	-9.46	4.00	75.00	0.00	-1.99	-17.32	-11.27	-21.00	4.00
75.00	10.00	-2.13	-12.33	1.93	-7.75	4.00	75.00	10.00	-1.89	-10.56	-10.86	-8.39	4.00
75.00	20.00	-1.62	-14.01	1.6	-5.53	4.00	75.00	20.00	-2.10	-16.74	-12.49	-6.35	4.00
75.00	30.00	-1.81	-12.39	1.3	-4.58	4.00	75.00	30.00	-1.14	-9.21	-13.86	-7.40	4.00
75.00	40.00	-3.72	-21.36	2.12	-11.89	4.00	75.00	40.00	-1.59	-6.56	-12.59	-8.01	4.00
75.00	50.00	-2.80	-17.11	1.22	-12.94	4.00	75.00	50.00	-1.78	-12.59	-10.83	-5.55	4.00
75.00	60.00	-4.59	-10.28	-0.07	-22.04	4.00	75.00	60.00	-3.53	-12.41	-7.39	-2.76	4.00
75.00	70.00	-6.07	-10.72	-1.01	-9.71	4.00	75.00	70.00	-8.92	-4.52	-8.82	-2.35	4.00
75.00	80.00	-7.24	-13.04	-0.41	-8.02	4.00	75.00	80.00	-19.72	-1.16	-11.65	0.05	4.00
75.00	90.00	-7.69	-16.88	-0.18	-7.69	4.00	75.00	90.00	-11.82	-0.05	-13.48	0.24	4.00
75.00	100.00	-7.57	-14.25	-1.16	-8.68	4.00	75.00	100.00	-6.14	-0.25	-11.99	-1.12	4.00
75.00	110.00	-5.64	-10.30	-1.99	-6.62	4.00	75.00	110.00	-3.57	-2.02	-9.48	-1.38	4.00
75.00	120.00	-4.13	-10.00	-0.83	-4.69	4.00	75.00	120.00	-3.28	-5.61	-9.87	0.43	4.00
75.00	130.00	-4.01	-11.66	0.53	-3.23	4.00	75.00	130.00	-1.47	-5.41	-11.44	-1.32	4.00
75.00	140.00	-2.93	-11.62	1.55	-4.17	4.00	75.00	140.00	-0.40	-7.19	-12.60	-3.08	4.00
75.00	150.00	-0.95	-8.22	2.09	-12.48	4.00	75.00	150.00	-0.07	-10.51	-15.82	-2.61	4.00
75.00	160.00	-0.17	-7.22	3.37	-4.00	4.00	75.00	160.00	-1.31	-12.46	-19.26	-8.77	4.00
75.00	170.00	0.62	-8.02	3.47	-3.98	4.00	75.00	170.00	-1.62	-18.24	-12.91	-16.93	4.00
75.00	180.00	0.76	-18.60	3.16	-7.29	4.00	75.00	180.00	-4.27	-8.02	-8.53	-18.91	4.00
75.00	190.00	0.44	-7.00	2.37	-5.42	4.00	75.00	190.00	-4.59	-7.29	-5.23	-11.18	4.00
75.00	200.00	0.37	-8.61	1.76	-9.66	4.00	75.00	200.00	-8.27	-11.76	-5.75	-14.31	4.00
75.00	210.00	-0.93	-11.23	0.95	-6.20	4.00	75.00	210.00	-9.76	-6.74	-7.05	-12.37	4.00
75.00	220.00	-1.51	-7.55	-1.41	-9.16	4.00	75.00	220.00	-12.30	-3.67	-5.63	-1.28	4.00
75.00	230.00	-1.06	-6.88	-3.36	-8.12	4.00	75.00	230.00	-8.19	-2.12	-5.91	-0.79	4.00
75.00	240.00	-3.29	-6.57	-5.87	-8.17	4.00	75.00	240.00	-9.12	-2.97	-6.08	0.60	4.00
75.00	250.00	-3.54	-8.53	-5.25	-9.87	4.00	75.00	250.00	-7.53	-2.95	-8.45	2.53	4.00
75.00	260.00	-1.21	-9.14	-1.58	-9.64	4.00	75.00	260.00	-8.71	-0.57	-12.75	2.44	4.00
75.00	270.00	-1.39	-15.38	-0.18	-8.46	4.00	75.00	270.00	-15.00	-0.01	-11.11	0.54	4.00
75.00	280.00	-1.85	-20.19	-0.16	-7.91	4.00	75.00	280.00	-10.38	-0.69	-5.98	-1.25	4.00
75.00	290.00	-3.39	-15.48	-0.49	-5.85	4.00	75.00	290.00	-8.97	-1.27	-3.74	-3.56	4.00
75.00	300.00	-2.12	-15.07	0.06	-5.77	4.00	75.00	300.00	-10.79	-3.64	-4.06	-3.43	4.00



105.00	0.00	-10.93	-6.96	-3.75	-8.06	4.00	105.00	0.00	-9.75	-7.17	-20.33	-13.71	4.00	-7.29	-4.05	-3.66	-7.01	4.00	0.67	-5.19
105.00	10.00	-4.99	-6.35	-1.95	-7.09	4.00	105.00	10.00	-6.52	-13.41	-18.28	-28.56	4.00	-2.68	-5.57	-1.85	-7.06	4.00	1.98	-3.80
105.00	20.00	-1.77	-7.78	-0.58	-4.17	4.00	105.00	20.00	-2.43	-11.98	-14.25	-33.97	4.00	0.92	-6.38	-0.40	-4.17	4.00	3.99	-1.61
105.00	30.00	-2.65	-6.80	-2.40	-7.03	4.00	105.00	30.00	-0.59	-8.60	-11.29	-4.15	4.00	1.51	-4.60	-1.87	-2.35	4.00	4.48	-1.26
105.00	40.00	-2.85	-6.19	-0.94	-8.25	4.00	105.00	40.00	-2.02	-6.77	-6.87	-4.20	4.00	0.60	-3.46	0.05	-2.76	4.00	4.80	-1.05
105.00	50.00	-3.51	-7.77	-2.72	-15.45	4.00	105.00	50.00	-2.67	-6.36	-8.03	-4.43	4.00	-0.06	-4.00	-1.60	-4.10	4.00	3.75	-2.10
105.00	60.00	-2.28	-10.33	-7.55	-10.87	4.00	105.00	60.00	-2.81	-2.35	-7.23	-5.42	4.00	0.47	-1.71	-4.38	-4.33	4.00	3.78	-2.00
105.00	70.00	-1.64	-14.05	-4.40	-15.58	4.00	105.00	70.00	-4.07	0.93	-8.54	-10.18	4.00	0.32	1.07	-2.98	-9.08	4.00	4.16	-1.28
105.00	80.00	-2.09	-13.11	-2.31	-9.44	4.00	105.00	80.00	-7.79	1.95	-19.57	-11.46	4.00	-1.05	2.08	-2.23	-7.32	4.00	4.51	-0.99
105.00	90.00	-2.96	-12.75	-2.38	-6.50	4.00	105.00	90.00	-17.2	1.32	-12.41	-9.54	4.00	-2.80	1.49	-1.97	-4.75	4.00	4.32	-1.39
105.00	100.00	-3.95	-16.39	-4.02	-12.42	4.00	105.00	100.00	-9.96	-1.61	-9.51	-12.13	4.00	-2.98	-1.47	-2.94	-9.26	4.00	2.32	-3.36
105.00	110.00	-3.85	-13.13	-8.22	-12.27	4.00	105.00	110.00	-6.28	-5.90	-8.96	-15.05	4.00	-1.89	-5.15	-5.56	-10.43	4.00	0.77	-4.81
105.00	120.00	-3.62	-7.12	-8.96	-9.22	4.00	105.00	120.00	-5.23	-6.35	-12.57	-3.31	4.00	-1.34	-3.71	-7.39	-2.32	4.00	2.61	-3.17
105.00	130.00	-3.04	-6.17	-2.67	-8.25	4.00	105.00	130.00	-5.87	-10.78	-17.71	-11.14	4.00	-1.22	-4.88	-2.54	-6.45	4.00	2.48	-3.31
105.00	140.00	-2.02	-5.02	-3.94	-4.54	4.00	105.00	140.00	-4.35	-11.19	-19.74	-6.86	4.00	-0.02	-4.08	-3.83	-2.54	4.00	3.56	-2.30
105.00	150.00	-1.88	-6.31	-5.03	-4.31	4.00	105.00	150.00	-2.93	-13.46	-23.00	-8.83	4.00	0.64	-5.54	-4.96	-3.00	4.00	3.16	-2.48
105.00	160.00	-0.52	-3.77	-0.60	-5.34	4.00	105.00	160.00	-5.03	-10.31	-16.34	-25.74	4.00	0.80	-2.90	-0.49	-5.30	4.00	4.35	-1.39
105.00	170.00	-3.21	-2.00	1.01	-4.48	4.00	105.00	170.00	-2.82	-11.52	-21.89	-21.51	4.00	0.00	-1.54	1.03	-4.39	4.00	5.02	-0.79
105.00	180.00	-4.73	-2.37	1.50	-6.11	4.00	105.00	180.00	-4.79	-9.12	-13.49	-11.08	4.00	-1.75	-1.54	1.64	-4.91	4.00	4.69	-1.04
105.00	190.00	-4.03	-7.97	0.52	-6.82	4.00	105.00	190.00	-8.50	-29.31	-10.06	-15.08	4.00	-2.70	-7.94	0.88	-6.22	4.00	2.70	-2.67
105.00	200.00	-7.58	-17.79	-2.53	-9.53	4.00	105.00	200.00	-9.62	-12.56	-7.57	-17.05	4.00	-5.47	-11.42	-1.35	-8.82	4.00	0.09	-5.16
105.00	210.00	-6.85	-12.45	-2.43	-6.39	4.00	105.00	210.00	-8.41	-10.55	-16.17	-17.54	4.00	-4.55	-8.39	-2.25	-6.07	4.00	0.99	-4.75
105.00	220.00	-11.75	-12.86	-1.91	-4.97	4.00	105.00	220.00	-9.89	-15.03	-14.03	-4.39	4.00	-7.71	-10.80	-1.65	-1.66	4.00	1.41	-3.93
105.00	230.00	-7.03	-12.52	-5.90	-5.21	4.00	105.00	230.00	-11.92	-7.80	-9.19	-0.60	4.00	-5.81	-6.54	-4.23	0.69	4.00	2.54	-2.94
105.00	240.00	-8.90	-14.02	-11.26	-8.82	4.00	105.00	240.00	-14.84	-11.53	-10.49	1.53	4.00	-7.91	-9.59	-7.85	1.91	4.00	1.53	-3.03
105.00	250.00	-23.86	-20.60	-6.98	-18.91	4.00	105.00	250.00	-10.92	-12.44	-13.12	1.80	4.00	-10.70	-11.82	-6.03	1.84	4.00	1.15	-3.17
105.00	260.00	-8.34	-19.50	-3.39	-16.22	4.00	105.00	260.00	-18.05	-3.63	-19.22	1.12	4.00	-7.90	-3.52	-3.28	1.20	4.00	3.24	-2.23
105.00	270.00	-9.08	-18.24	-2.70	-10.35	4.00	105.00	270.00	-18.83	-0.61	-13.53	-0.07	4.00	-8.64	-0.54	-2.36	0.32	4.00	3.83	-1.74
105.00	280.00	-19.01	-23.89	-2.95	-8.88	4.00	105.00	280.00	-9.14	-1.66	-11.17	-2.49	4.00	-8.71	-1.63	-2.34	-1.59	4.00	2.90	-2.80
105.00	290.00	-9.56	-14.14	-5.16	-6.86	4.00	105.00	290.00	-6.98	-5.97	-13.22	-5.15	4.00	-5.07	-5.35	-4.53	-2.91	4.00	1.61	-4.36
105.00	300.00	-6.27	-24.07	-10.12	-3.53	4.00	105.00	300.00	-12.97	-4.92	-11.10	-7.08	4.00	-5.43	-4.87	-7.57	-1.94	4.00	1.30	-4.48
105.00	310.00	-8.24	-4.93	-9.86	-0.77	4.00	105.00	310.00	-31.24	-2.56	-8.93	-15.31	4.00	-8.22	-0.57	-6.36	-0.62	4.00	2.72	-2.75
105.00	320.00	-12.87	-5.22	-7.46	-0.74	4.00	105.00	320.00	-11.49	-8.95	-7.85	-32.94	4.00	-9.12	-3.69	-4.64	-0.74	4.00	1.97	-3.62
105.00	330.00	-11.10	-3.27	-5.55	-4.40	4.00	105.00	330.00	-8.93	-11.75	-10.53	-10.79	4.00	-6.87	-2.69	-4.35	-3.50	4.00	1.80	-4.10
105.00	340.00	-11.08	-2.86	-5.96	-7.23	4.00	105.00	340.00	-8.05	-8.06	-15.51	-6.25	4.00	-6.30	-1.71	-5.50	-3.70	4.00	1.90	-3.93
105.00	350.00	-13.62	-5.62	-4.28	-5.18	4.00	105.00	350.00	-7.94	-16.59	-23.47	-22.23	4.00	-6.90	-5.29	-4.23	-5.10	4.00	0.70	-5.27
120.00	0.00	-18.02	-1.56	-6.62	-2.42	4.00	120.00	0.00	-7.19	-11.63	-19.70	-19.46	4.00	-6.85	-1.15	-6.41	-2.33	4.00	2.19	-3.50
120.00	10.00	-9.68	-1.72	-2.90	-5.07	4.00	120.00	10.00	-8.98	-13.28	-14.67	-13.39	4.00	-6.31	-1.43	-2.62	-4.47	4.00	2.51	-3.33
120.00	20.00	-7.02	-5.44	-2.99	-5.60	4.00	120.00	20.00	-6.87	-22.42	-12.33	-7.99	4.00	-3.93	-5.35	-2.51	-3.62	4.00	2.22	-3.74
120.00	30.00	-5.78	-7.59	-1.76	-8.29	4.00	120.00	30.00	-3.65	-20.17	-12.12	-4.85	4.00	-1.58	-7.36	-1.38	-3.23	4.00	2.94	-2.83
120.00	40.00	-5.43	-8.38	-1.73	-5.70	4.00	120.00	40.00	-2.94	-13.31	-14.07	-4.51	4.00	-1.00	-7.17	-1.48	-2.05	4.00	3.41	-2.37
120.00	50.00	-2.91	-9.12	-4.81	-9.42	4.00	120.00	50.00	-3.58	-5.66	-10.56	-6.83	4.00	-0.22	-4.04	-3.79	-4.92	4.00	2.97	-2.83
120.00	60.00	-1.44	-11.55	-8.62	-8.63	4.00	120.00	60.00	-3.90	-5.64	-10.29	-5.37	4.00	0.51	-4.65	-6.36	-3.69	4.00	2.86	-2.74
120.00	70.00	-0.28	-10.29	-9.67	-11.18	4.00	120.00	70.00	-4.22	-4.55	-11.98	-5.46	4.00	1.19	-3.52	-7.66	-4.43	4.00	3.01	-2.42
120.00	80.00	-0.39	-12.42	-5.88	-13.57	4.00	120.00	80.00	-7.10	-1.31	-14.61	-12.10	4.00	0.45	-0.99	-5.33	-9.76	4.00	2.96	-2.39
120.00	90.00	-1.67	-24.57	-4.21	-10.98	4.00	120.00	90.00	-12.77	0.49	-19.82	-17.36	4.00	-1.35	0.50	-4.09	-10.08	4.00	3.09	-2.32
120.00	100.00	-4.23	-14.85	-7.14	-14.61	4.00	120.00	100.00	-19.11	-0.34	-31.31	-17.20	4.00	-4.09	-0.19	-7.12	-12.70	4.00	1.12	-3.99
120.00	110.00	-4.94	-9.56	-19.92	-13.46	4.00	120.00	110.00	-13.93	-2.53	-20.27	-10.75	4.00	-4.42	-1.74	-17.08	-8.89	4.00	0.36	-5.31
120.00	120.00	-5.34	-7.34	-9.87	-14.49	4.00	120.00	120.00	-17.42	-5.92	-24.95	-4.67	4.00	-5.08	-3.56	-9.74	-4.24	4.00	0.67	-5.11
120.00	130.00	-7.03	-6.47	-5.96	-6.81	4.00	120.00	130.00	-17.56	-8.37	-18.26	-18.12	4.00	-6.66	-4.31	-5.71	-6.50	4.00	0.28	-5.69
120.00	140.00	-6.69	-8.70	-5.21	-5.56	4.00	120.00	140.00	-11.30	-10.43	-14.75	-7.43	4.00	-5.40	-6.47	-4.75	-3.38	4.00	1.09	-4.86
120.00	150.00	-4.88	-8.62	-5.20	-13.26	4.00	120.00	150.00	-11.12	-24.55	-13.90	-10.13	4.00	-3.95	-8.51	-4.65	-8.41	4.00	-1.11	-5.89
120.00	160.00	-5.64	-8.77	-0.85	-6.75	4.00	120.00	160.00	-10.67	-13.42	-19.95	-12.31	4.00	-4.45	-7.49	-0.80	-5.68	4.00	0.77	-3.87
120.00	170.00	-5.26	-7.95	-2.16	-7.71	4.00	120.00	170.00	-9.18	-10.37	-27.49	-21.61	4.00	-3.78	-5.98	-2.15	-7.54	4.00	1.40	-4.39
120.00	180.00	-8.60	-2.99	-4.08	-11.42	4.00	120.00	180.00	-7.25	-9.35	-14.22	-11.54	4.00	-4.86	-2.09	-3.68	-8.47	4.00	1.55	-4.21
120.00	190.00	-8.57	-2.91	-4.44	-8.66	4.00	120.00	190.00	-8.53	-24.36	-7.27	-17.10	4.00	-5.54	-2.88	-2.62	-8.08	4.00	1.51	-4.27
120.00	200.00	-10.35	-7.66	-6.39	-12.95	4.00	120.00	200.00	-17.09	-14.40	-12.33	-13.25	4.00	-9.52	-6.83	-5.40	-10.09	4.00	-1.72	-7.53
120.00	210.00	-15.51	-8.75	-6.77	-5.54	4.00	120.00	210.00	-29.40	-19.66	-17.20	-22.09	4.00	-15.34	-8.41	-6.39	-5.44	4.00	-2.14	-7.64
120.00	220.00	-13.30	-7.79	-4.96	-3.42	4.00	120.00	220.00	-16.48	-10.34	-18.05	-15.72	4.00	-11.59	-5.87	-4.75	-3.17	4.00	0.19	-5.43
120.00	230.00	-14.46	-10.40	-8.38	-4.17	4.00	120.00	230.00	-13.95	-14.34	-14.70	-6.16	4.00	-11.19	-8.93	-7.47	-2.04	4.00	-0.69	-5.99
120.00	240.00	-22.82	-19																	



150.00	220.00	-14.01	-7.62	-15.00	-10.24	4.00	150.00	220.00	-12.22	-12.64	-15.82	-10.47	4.00
150.00	230.00	-21.66	-10.97	-17.57	-13.68	4.00	150.00	230.00	-16.64	-10.57	-13.12	-6.59	4.00
150.00	240.00	-24.68	-26.87	-19.93	-19.34	4.00	150.00	240.00	-14.84	-18.49	-11.61	-5.33	4.00
150.00	250.00	-13.22	-20.14	-27.31	-20.28	4.00	150.00	250.00	-14.60	-20.38	-13.53	-3.13	4.00
150.00	260.00	-13.01	-20.90	-22.57	-14.29	4.00	150.00	260.00	-11.22	-18.36	-14.97	-3.43	4.00
150.00	270.00	-15.22	-16.90	-16.13	-13.87	4.00	150.00	270.00	-10.22	-8.47	-18.60	-4.21	4.00
150.00	280.00	-19.11	-11.53	-15.09	-10.96	4.00	150.00	280.00	-10.95	-2.42	-13.95	-5.50	4.00
150.00	290.00	-15.58	-8.91	-16.16	-8.17	4.00	150.00	290.00	-12.99	0.34	-10.67	-6.41	4.00
150.00	300.00	-11.09	-6.52	-19.54	-5.77	4.00	150.00	300.00	-10.60	0.76	-9.10	-9.28	4.00
150.00	310.00	-10.72	-2.86	-13.03	-4.97	4.00	150.00	310.00	-7.08	-0.23	-10.20	-11.16	4.00
150.00	320.00	-11.38	-1.10	-10.33	-3.90	4.00	150.00	320.00	-6.95	-0.82	-12.59	-7.54	4.00
150.00	330.00	-15.53	-1.31	-8.94	-4.31	4.00	150.00	330.00	-8.58	-0.86	-16.71	-9.93	4.00
150.00	340.00	-19.48	-0.90	-8.24	-6.29	4.00	150.00	340.00	-11.79	-2.59	-15.03	-9.77	4.00
150.00	350.00	-14.48	0.22	-7.48	-8.07	4.00	150.00	350.00	-16.81	-5.37	-12.42	-10.80	4.00
165.00	0.00	-14.67	2.03	-11.34	-10.47	4.00	165.00	0.00	-14.42	-1.78	-11.08	-6.99	4.00
165.00	10.00	-17.72	1.84	-9.34	-9.28	4.00	165.00	10.00	-18.63	-1.18	-13.24	-7.19	4.00
165.00	20.00	-21.96	0.43	-9.72	-7.67	4.00	165.00	20.00	-20.11	-0.24	-17.07	-8.73	4.00
165.00	30.00	-18.85	-1.76	-9.90	-6.60	4.00	165.00	30.00	-16.70	-0.07	-20.62	-16.23	4.00
165.00	40.00	-27.94	-5.46	-9.75	-7.90	4.00	165.00	40.00	-15.46	-1.08	-15.85	-17.93	4.00
165.00	50.00	-41.96	-10.26	-11.38	-10.04	4.00	165.00	50.00	-16.48	-2.77	-11.93	-16.11	4.00
165.00	60.00	-14.74	-18.75	-11.26	-12.72	4.00	165.00	60.00	-16.36	-4.78	-11.21	-15.77	4.00
165.00	70.00	-10.15	-18.81	-12.50	-11.35	4.00	165.00	70.00	-13.33	-6.67	-11.69	-11.17	4.00
165.00	80.00	-7.67	-16.29	-12.64	-12.54	4.00	165.00	80.00	-11.75	-6.52	-13.48	-6.47	4.00
165.00	90.00	-6.55	-11.16	-13.70	-17.29	4.00	165.00	90.00	-10.82	-5.65	-17.43	-4.23	4.00
165.00	100.00	-6.48	-7.92	-13.67	-21.59	4.00	165.00	100.00	-10.53	-5.28	-19.06	-4.13	4.00
165.00	110.00	-6.64	-6.01	-14.36	-12.45	4.00	165.00	110.00	-9.16	-6.68	-15.38	-7.50	4.00
165.00	120.00	-8.62	-6.55	-12.81	-9.61	4.00	165.00	120.00	-9.38	-10.41	-13.51	-10.77	4.00
165.00	130.00	-10.48	-9.24	-13.37	-10.28	4.00	165.00	130.00	-11.92	-16.78	-12.05	-18.80	4.00
165.00	140.00	-13.22	-10.28	-12.57	-10.80	4.00	165.00	140.00	-16.49	-17.40	-12.29	-18.29	4.00
165.00	150.00	-14.70	-5.97	-11.78	-6.79	4.00	165.00	150.00	-22.29	-14.86	-16.77	-13.25	4.00
165.00	160.00	-15.82	-4.04	-11.34	-4.77	4.00	165.00	160.00	-26.78	-22.73	-14.87	-10.60	4.00
165.00	170.00	-16.03	-3.53	-10.55	-5.15	4.00	165.00	170.00	-16.23	-17.99	-21.84	-10.90	4.00
165.00	180.00	-16.68	-3.66	-12.27	-7.01	4.00	165.00	180.00	-13.98	-17.19	-21.44	-12.37	4.00
165.00	190.00	-13.43	-3.93	-14.52	-9.75	4.00	165.00	190.00	-15.55	-29.33	-22.80	-17.64	4.00
165.00	200.00	-12.11	-4.60	-20.34	-12.33	4.00	165.00	200.00	-18.84	-17.92	-23.96	-21.98	4.00
165.00	210.00	-15.91	-7.19	-19.72	-13.02	4.00	165.00	210.00	-21.59	-15.07	-25.00	-11.87	4.00
165.00	220.00	-21.49	-8.86	-16.25	-9.23	4.00	165.00	220.00	-17.10	-11.63	-17.36	-7.14	4.00
165.00	230.00	-20.30	-8.62	-16.42	-8.85	4.00	165.00	230.00	-15.70	-7.95	-15.03	-4.47	4.00
165.00	240.00	-15.19	-8.44	-15.07	-12.53	4.00	165.00	240.00	-15.49	-5.41	-13.15	-3.34	4.00
165.00	250.00	-11.08	-11.41	-12.86	-17.82	4.00	165.00	250.00	-20.85	-4.74	-11.82	-2.71	4.00
165.00	260.00	-7.59	-13.03	-12.48	-20.91	4.00	165.00	260.00	-17.86	-6.78	-11.09	-5.52	4.00
165.00	270.00	-8.19	-11.30	-13.26	-12.72	4.00	165.00	270.00	-10.99	-11.07	-7.96	-8.70	4.00
165.00	280.00	-7.98	-7.89	-14.93	-10.95	4.00	165.00	280.00	-9.09	-18.54	-7.58	-15.16	4.00
165.00	290.00	-10.33	-9.02	-12.95	-11.30	4.00	165.00	290.00	-7.19	-10.67	-7.31	-18.76	4.00
165.00	300.00	-11.64	-15.19	-10.28	-9.10	4.00	165.00	300.00	-7.94	-5.67	-9.02	-8.96	4.00
165.00	310.00	-12.69	-11.60	-8.76	-6.68	4.00	165.00	310.00	-8.72	-3.50	-10.64	-6.66	4.00
165.00	320.00	-12.47	-4.19	-8.38	-4.50	4.00	165.00	320.00	-10.54	-3.16	-12.85	-7.85	4.00
165.00	330.00	-11.89	-1.00	-8.56	-3.34	4.00	165.00	330.00	-10.91	-3.82	-14.28	-11.96	4.00
165.00	340.00	-13.95	1.29	-10.07	-4.02	4.00	165.00	340.00	-11.43	-3.62	-13.24	-19.98	4.00
165.00	350.00	-18.57	2.39	-10.52	-7.47	4.00	165.00	350.00	-13.41	-2.64	-12.16	-10.49	4.00
180.00	0.00	-13.41	-20.88	-8.43	-11.29	4.00	180.00	0.00	-14.44	-14.33	-15.75	-12.72	4.00
180.00	10.00	-12.28	-18.25	-7.92	-10.22	4.00	180.00	10.00	-16.49	-15.21	-20.47	-14.88	4.00
180.00	20.00	-11.52	-16.44	-7.70	-9.50	4.00	180.00	20.00	-19.56	-16.50	-32.55	-18.13	4.00
180.00	30.00	-11.07	-15.17	-7.75	-9.08	4.00	180.00	30.00	-24.80	-18.33	-26.32	-23.89	4.00
180.00	40.00	-10.89	-14.30	-8.06	-8.94	4.00	180.00	40.00	-41.86	-21.00	-18.51	-48.94	4.00
180.00	50.00	-10.98	-13.75	-8.67	-9.06	4.00	180.00	50.00	-27.61	-25.30	-14.63	-24.41	4.00
180.00	60.00	-11.34	-13.49	-9.61	-9.46	4.00	180.00	60.00	-20.91	-34.98	-12.16	-18.39	4.00
180.00	70.00	-12.00	-13.50	-10.97	-10.16	4.00	180.00	70.00	-17.35	-34.34	-10.45	-15.04	4.00
180.00	80.00	-13.00	-13.77	-12.90	-11.22	4.00	180.00	80.00	-15.02	-25.10	-9.24	-12.83	4.00
180.00	90.00	-14.44	-14.33	-15.75	-12.72	4.00	180.00	90.00	-13.41	-20.88	-8.43	-11.29	4.00
180.00	100.00	-16.49	-15.21	-20.47	-14.88	4.00	180.00	100.00	-12.28	-18.25	-7.92	-10.22	4.00
180.00	110.00	-19.56	-16.50	-32.55	-18.13	4.00	180.00	110.00	-11.52	-16.44	-7.70	-9.50	4.00
180.00	120.00	-24.80	-18.33	-26.32	-23.89	4.00	180.00	120.00	-11.07	-15.17	-7.75	-9.08	4.00
180.00	130.00	-41.86	-21.00	-18.51	-48.94	4.00	180.00	130.00	-10.89	-14.30	-8.06	-8.94	4.00
180.00	140.00	-27.61	-25.30	-14.63	-24.41	4.00	180.00	140.00	-10.98	-13.75	-8.67	-9.06	4.00
180.00	150.00	-20.91	-34.98	-12.16	-18.39	4.00	180.00	150.00	-11.34	-13.49	-9.61	-9.46	4.00
180.00	160.00	-17.35	-34.34	-10.45	-15.04	4.00	180.00	160.00	-12.00	-13.50	-10.97	-10.16	4.00
180.00	170.00	-15.02	-25.10	-9.24	-12.83	4.00	180.00	170.00	-13.00	-13.77	-12.90	-11.22	4.00
180.00	180.00	-13.41	-20.88	-8.43	-11.29	4.00	180.00	180.00	-14.44	-14.33	-15.75	-12.72	4.00
180.00	190.00	-12.28	-18.25	-7.92	-10.22	4.00	180.00	190.00	-16.49	-15.21	-20.47	-14.88	4.00
180.00	200.00	-11.52	-16.44	-7.70	-9.50	4.00	180.00	200.00	-19.56	-16.50	-32.55	-18.13	4.00
180.00	210.00	-11.07	-15.17	-7.75	-9.08	4.00	180.00	210.00	-24.80	-18.33	-26.32	-23.89	4.00
180.00	220.00	-10.89	-14.30	-8.06	-8.94	4.00	180.00	220.00	-41.86	-21.00	-18.51	-48.94	4.00
180.00	230.00	-10.98	-13.75	-8.67	-9.06	4.00	180.00	230.00	-27.61	-25.30	-14.63	-24.41	4.00
180.00	240.00	-11.34	-13.49	-9.61	-9.46	4.00	180.00	240.00	-20.91	-34.98	-12.16	-18.39	4.00
180.00	250.00	-12.00	-13.50	-10.97	-10.16	4.00	180.00	250.00	-17.35	-34.34	-10.45	-15.04	4.00
180.00	260.00	-13.00	-13.77	-12.90	-11.22	4.00	180.00	260.00	-15.02	-25.10	-9.24	-12.83	4.00
180.00	270.00	-14.44	-14.33	-15.75	-12.72	4.00	180.00	270.00	-13.41	-20.88	-8.43	-11.29	4.00
180.00	280.00	-16.49	-15.21	-20.47	-14.88	4.00	180.00	280.00	-12.28	-18.25	-7.92	-10.22	4.00
180.00	290.00	-19.56	-16.50	-32.55	-18.13	4.00	180.00	290.00	-11.52	-16.44	-7.70	-9.50	4.00
180.00	300.00	-24.80	-18.33	-26.32	-23.89	4.00	180.00	300.00	-11.07	-15.17	-7.75	-9.08	4.00
180.00	310.00	-41.86	-21.00	-18.51	-48.94	4.00	180.00	310.00	-10.89	-14.30	-8.06	-8.94	4.00
180.00	320.00	-27.61	-25.30	-14.63	-24.41	4.00	180.00	320.00	-10.98	-13.75	-8.67	-9.06	4.00
180.00	330.00	-20.91	-34.98	-12.16	-18.39	4.00	180.00	330.00	-11.34	-13.49	-9.61	-9.46	4.00
180.00	340.00	-17.35	-34.34	-10.45	-15.04	4.00	180.00	340.00	-12.00	-13.50	-10.97	-10.16	4.00
180.00	350.00	-15.02	-25.10	-9.24	-12.83								



Frequency: 5580MHz

		Theta Polarization						Phi Polarization						Total						
Angle (θ)	Angle (ψ)	Max Gain(dBi)				Nant	Angle (θ)	Angle (ψ)	Max Gain(dBi)				Nant	Max Gain(dBi)				Nant	Max DG(dBi)	Max DG(dBi)
		Ant 1(G1)	Ant 2(G2)	Ant 3(G3)	Ant 4(G4)				Ant 1(G1)	Ant 2(G2)	Ant 3(G3)	Ant 4(G4)		Ant 1(G1)	Ant 2(G2)	Ant 3(G3)	Ant 4(G4)			
		1.59	4.56	4.41	1.00				0.24	4.36	-3.10	3.02		3.08	4.58	4.44	3.20			
Ant 1(G1)	Ant 2(G2)	Ant 3(G3)	Ant 4(G4)	Ant 1(G1)	Ant 2(G2)	Ant 3(G3)	Ant 4(G4)	Ant 1(G1)	Ant 2(G2)	Ant 3(G3)	Ant 4(G4)	g1k	g1k							
		15AT	45AT																	
0.00	0.00	-14.72	4.36	-20.13	0.89	4.00	0.00	0.00	-3.80	-17.77	-7.09	-15.04	4.00	-3.46	4.39	-6.88	1.00	4.00	5.81	0.66
0.00	10.00	-10.66	4.35	-15.20	1.00	4.00	0.00	10.00	-4.38	-15.94	-7.57	-34.86	4.00	-3.46	4.39	-6.88	1.00	4.00	5.81	0.67
0.00	20.00	-8.10	4.07	-12.26	0.84	4.00	0.00	20.00	-5.29	-7.06	-8.37	-13.45	4.00	-3.46	4.39	-6.88	1.00	4.00	5.81	0.67
0.00	30.00	-6.34	3.50	-10.28	0.41	4.00	0.00	30.00	-6.60	-2.92	-9.54	-7.94	4.00	-3.46	4.39	-6.88	1.00	4.00	5.81	0.67
0.00	40.00	-5.10	2.60	-8.88	-0.33	4.00	0.00	40.00	-8.48	-0.33	-11.20	-4.78	4.00	-3.46	4.39	-6.88	1.00	4.00	5.81	0.67
0.00	50.00	-4.25	1.30	-7.92	-1.43	4.00	0.00	50.00	-11.23	1.46	-13.61	-2.67	4.00	-3.46	4.39	-6.88	1.00	4.00	5.81	0.67
0.00	60.00	-3.73	-0.55	-7.29	-3.01	4.00	0.00	60.00	-15.70	2.71	-17.35	-1.20	4.00	-3.46	4.39	-6.88	1.00	4.00	5.81	0.66
0.00	70.00	-3.48	-3.27	-6.95	-5.26	4.00	0.00	70.00	-26.30	3.57	-24.64	-0.17	4.00	-3.46	4.39	-6.88	1.00	4.00	5.81	0.67
0.00	80.00	-3.51	-7.65	-6.89	-8.71	4.00	0.00	80.00	-23.27	4.11	-33.88	0.51	4.00	-3.46	4.39	-6.88	1.00	4.00	5.81	0.67
0.00	90.00	-3.80	-17.77	-7.09	-15.04	4.00	0.00	90.00	-14.72	4.36	-20.13	0.89	4.00	-3.46	4.39	-6.88	1.00	4.00	5.81	0.66
0.00	100.00	-4.38	-15.94	-7.57	-34.86	4.00	0.00	100.00	-10.66	4.35	-15.20	1.00	4.00	-3.46	4.39	-6.88	1.00	4.00	5.81	0.67
0.00	110.00	-5.29	-7.06	-8.37	-13.45	4.00	0.00	110.00	-8.10	4.07	-12.26	0.84	4.00	-3.46	4.39	-6.88	1.00	4.00	5.81	0.67
0.00	120.00	-6.60	-2.92	-9.54	-7.94	4.00	0.00	120.00	-6.34	3.50	-10.28	0.41	4.00	-3.46	4.39	-6.88	1.00	4.00	5.81	0.67
0.00	130.00	-8.48	-0.33	-11.20	-4.78	4.00	0.00	130.00	-5.10	2.60	-8.88	-0.33	4.00	-3.46	4.39	-6.88	1.00	4.00	5.81	0.67
0.00	140.00	-11.23	1.46	-13.61	-2.67	4.00	0.00	140.00	-4.25	1.30	-7.92	-1.43	4.00	-3.46	4.39	-6.88	1.00	4.00	5.81	0.67
0.00	150.00	-15.70	2.71	-17.35	-1.20	4.00	0.00	150.00	-3.73	-0.55	-7.29	-3.01	4.00	-3.46	4.39	-6.88	1.00	4.00	5.81	0.66
0.00	160.00	-26.30	3.57	-24.64	-0.17	4.00	0.00	160.00	-3.48	-3.27	-6.95	-5.26	4.00	-3.46	4.39	-6.88	1.00	4.00	5.81	0.67
0.00	170.00	-23.27	4.11	-33.88	0.51	4.00	0.00	170.00	-3.51	-7.65	-6.89	-8.71	4.00	-3.46	4.39	-6.88	1.00	4.00	5.81	0.67
0.00	180.00	-14.72	4.36	-20.13	0.89	4.00	0.00	180.00	-3.80	-17.77	-7.09	-15.04	4.00	-3.46	4.39	-6.88	1.00	4.00	5.81	0.66
0.00	190.00	-10.66	4.35	-15.20	1.00	4.00	0.00	190.00	-4.38	-15.94	-7.57	-34.86	4.00	-3.46	4.39	-6.88	1.00	4.00	5.81	0.67
0.00	200.00	-8.10	4.07	-12.26	0.84	4.00	0.00	200.00	-5.29	-7.06	-8.37	-13.45	4.00	-3.46	4.39	-6.88	1.00	4.00	5.81	0.67
0.00	210.00	-6.34	3.50	-10.28	0.41	4.00	0.00	210.00	-6.60	-2.92	-9.54	-7.94	4.00	-3.46	4.39	-6.88	1.00	4.00	5.81	0.67
0.00	220.00	-5.10	2.60	-8.88	-0.33	4.00	0.00	220.00	-8.48	-0.33	-11.20	-4.78	4.00	-3.46	4.39	-6.88	1.00	4.00	5.81	0.67
0.00	230.00	-4.25	1.30	-7.92	-1.43	4.00	0.00	230.00	-11.23	1.46	-13.61	-2.67	4.00	-3.46	4.39	-6.88	1.00	4.00	5.81	0.67
0.00	240.00	-3.73	-0.55	-7.29	-3.01	4.00	0.00	240.00	-15.70	2.71	-17.35	-1.20	4.00	-3.46	4.39	-6.88	1.00	4.00	5.81	0.66
0.00	250.00	-3.48	-3.27	-6.95	-5.26	4.00	0.00	250.00	-26.30	3.57	-24.64	-0.17	4.00	-3.46	4.39	-6.88	1.00	4.00	5.81	0.67
0.00	260.00	-3.51	-7.65	-6.89	-8.71	4.00	0.00	260.00	-23.27	4.11	-33.88	0.51	4.00	-3.46	4.39	-6.88	1.00	4.00	5.81	0.67
0.00	270.00	-3.80	-17.77	-7.09	-15.04	4.00	0.00	270.00	-14.72	4.36	-20.13	0.89	4.00	-3.46	4.39	-6.88	1.00	4.00	5.81	0.66
0.00	280.00	-4.38	-15.94	-7.57	-34.86	4.00	0.00	280.00	-10.66	4.35	-15.20	1.00	4.00	-3.46	4.39	-6.88	1.00	4.00	5.81	0.67
0.00	290.00	-5.29	-7.06	-8.37	-13.45	4.00	0.00	290.00	-8.10	4.07	-12.26	0.84	4.00	-3.46	4.39	-6.88	1.00	4.00	5.81	0.67
0.00	300.00	-6.60	-2.92	-9.54	-7.94	4.00	0.00	300.00	-6.34	3.50	-10.28	0.41	4.00	-3.46	4.39	-6.88	1.00	4.00	5.81	0.67
0.00	310.00	-8.48	-0.33	-11.20	-4.78	4.00	0.00	310.00	-5.10	2.60	-8.88	-0.33	4.00	-3.46	4.39	-6.88	1.00	4.00	5.81	0.67
0.00	320.00	-11.23	1.46	-13.61	-2.67	4.00	0.00	320.00	-4.25	1.30	-7.92	-1.43	4.00	-3.46	4.39	-6.88	1.00	4.00	5.81	0.67
0.00	330.00	-15.70	2.71	-17.35	-1.20	4.00	0.00	330.00	-3.73	-0.55	-7.29	-3.01	4.00	-3.46	4.39	-6.88	1.00	4.00	5.81	0.66
0.00	340.00	-26.30	3.57	-24.64	-0.17	4.00	0.00	340.00	-3.48	-3.27	-6.95	-5.26	4.00	-3.46	4.39	-6.88	1.00	4.00	5.81	0.67
0.00	350.00	-23.27	4.11	-33.88	0.51	4.00	0.00	350.00	-3.51	-7.65	-6.89	-8.71	4.00	-3.46	4.39	-6.88	1.00	4.00	5.81	0.67
15.00	0.00	-7.85	4.39	-11.65	-1.73	4.00	15.00	0.00	-1.25	-13.31	-6.10	-15.45	4.00	-0.39	4.46	-5.03	-1.55	4.00	6.07	0.72
15.00	10.00	-10.94	4.56	-8.06	-2.38	4.00	15.00	10.00	-1.32	-19.46	-6.12	-10.68	4.00	-0.87	4.58	-3.97	-1.78	4.00	6.12	0.75
15.00	20.00	-11.43	4.34	-6.95	-3.92	4.00	15.00	20.00	-3.25	-8.60	-11.37	-6.62	4.00	-2.64	4.56	-5.61	-2.05	4.00	5.44	0.31
15.00	30.00	-10.79	3.47	-6.87	-4.58	4.00	15.00	30.00	-3.56	-3.83	-15.15	-5.72	4.00	-2.81	4.21	-6.27	-2.10	4.00	5.15	0.01
15.00	40.00	-11.41	1.56	-6.74	-6.33	4.00	15.00	40.00	-4.44	-1.76	-14.62	-4.73	4.00	-3.64	3.22	-6.08	-2.45	4.00	4.50	-0.77
15.00	50.00	-7.95	-0.26	-6.30	-7.49	4.00	15.00	50.00	-7.21	-0.84	-21.16	-3.29	4.00	-4.55	2.47	-6.16	-1.89	4.00	4.13	-1.24
15.00	60.00	-6.49	-2.90	-6.71	-11.85	4.00	15.00	60.00	-9.51	0.29	-31.44	-2.55	4.00	-4.73	1.99	-6.70	-2.07	4.00	3.77	-1.62
15.00	70.00	-5.59	-6.93	-6.53	-19.14	4.00	15.00	70.00	-16.92	0.51	-19.50	-2.18	4.00	-5.28	1.23	-6.32	-2.09	4.00	3.42	-2.09
15.00	80.00	-4.84	-10.69	-6.27	-20.94	4.00	15.00	80.00	-26.71	0.79	-20.96	-2.03	4.00	-4.81	1.09	-6.12	-1.97	4.00	3.52	-2.05
15.00	90.00	-5.24	-13.58	-5.70	-13.38	4.00	15.00	90.00	-12.32	0.88	-17.14	-3.15	4.00	-4.46	1.03	-5.40	-2.76	4.00	3.49	-2.14
15.00	100.00	-7.19	-11.54	-5.01	-7.89	4.00	15.00	100.00	-8.41	0.57	-14.96	-3.25	4.00	-4.75	0.83	-4.59	-1.97	4.00	3.71	-1.99
15.00	110.00	-8.47	-8.13	-4.69	-5.54	4.00	15.00	110.00	-5.86	0.32	-15.39	-3.95	4.00	-3.96	0.90	-4.34	-1.66	4.00	4.02	-1.74
15.00	120.00	-13.19	-3.61	-4.30	-2.85	4.00	15.00	120.00	-4.36	-0.27	-18.44	-4.71	4.00	-3.83	1.38	-4.14	-0.67	4.00	4.51	-1.20
15.00	130.00	-21.02	-1.03	-4.66	-1.89	4.00	15.00	130.00	-3.23	-1.06	-16.66	-6.39	4.00	-3.16	1.97	-4.39	-0.57	4.00	4.83	-0.84
15.00	140.00	-28.60	1.19	-4.67	-1.24	4.00	15.00	140.00	-2.57	-2.30	-15.14	-8.02	4.00	-2.56	2.80	-4.30	-0.41	4.00	5.32	-0.29
15.00	150.00	-16.78	2.73	-5.38	-0.77	4.00	15.00	150.00	-1.82	-3.68	-12.64	-11.37	4.00	-1.68	3.62	-4.63	-0.41	4.00	5.76	0.25
15.00	160.00	-10.63	3.52	-6.44	-0.32	4.00	15.00	160.00	-1.77	-6.82	-10.54	-14.26	4.00	-1.24	3.90	-5.01	-0.15	4.00	5.98	0.50
15.00	170.00	-6.06	3.98	-7.21	-0.28	4.00	15.00	170.00	-2.11	-10.24	-9.96	-14.55	4.00	-0.64	4.14	-5.36	-0.12	4.00	6.16	0.72
15.00	180.00	-4.70	4.03	-9.02	0.28	4.00	15.00	180.00	-4.92	-15.94	-9.37	-11.04	4.00	-1.80	4.07	-6.18	0.59	4.00	5.96	0.67
15.00	190.00	-2.75	3.55	-13.70	0.25	4.00	15.00	190.00	-5.16	-18.04	-8.82	-8.74	4.00	-0.78	3.58	-7.60	0.77	4.00	5.87	0.49
15.00	200.00	-2.19	2.58	-19.86	0.58	4.00	15.00	200.00	-7.72	-7.62	-8.88	-5.91	4.00	-1.12	2.98	-8.55	1.46	4.00	5.68	0.31
15.00	210.00	-2.82	1.93	-17.30	0.09	4.00	15.00	210.00	-10.00											



45.00	140.00	-3.16	-2.92	2.86	-2.44	4.00	45.00	140.00	-0.56	-0.17	-24.40	-2.00	4.00	1.34	1.68	2.87	0.80	4.00	7.73	1.74
45.00	150.00	-1.99	-3.09	2.72	-0.96	4.00	45.00	150.00	-1.04	-0.16	-24.65	-2.28	4.00	1.52	1.63	2.73	1.44	4.00	7.87	1.86
45.00	160.00	-2.21	-0.55	3.05	-1.88	4.00	45.00	160.00	-1.22	-1.91	-24.65	-5.81	4.00	1.32	1.83	3.06	-0.40	4.00	7.56	1.62
45.00	170.00	0.17	0.82	2.90	-3.17	4.00	45.00	170.00	-2.97	-3.07	-14.87	-8.60	4.00	1.89	2.31	2.97	-2.08	4.00	7.50	1.65
45.00	180.00	1.59	0.39	1.18	-0.09	4.00	45.00	180.00	-3.72	-3.94	-6.29	-15.10	4.00	2.71	1.75	1.90	0.04	4.00	7.67	1.70
45.00	190.00	1.54	-3.12	-0.16	-0.07	4.00	45.00	190.00	-4.34	-9.91	-3.10	-20.02	4.00	2.54	-2.29	1.62	-0.03	4.00	6.67	0.82
45.00	200.00	1.14	-6.04	-1.18	-2.37	4.00	45.00	200.00	-8.20	-17.53	-4.35	-13.44	4.00	1.62	-5.74	0.53	-2.04	4.00	5.04	-0.61
45.00	210.00	0.59	-6.94	-1.45	-1.49	4.00	45.00	210.00	-7.62	-18.84	-5.75	-7.17	4.00	1.20	-6.67	-0.08	-0.45	4.00	4.99	-0.68
45.00	220.00	-0.99	-7.35	-2.50	-0.42	4.00	45.00	220.00	-12.92	-14.00	-7.57	-4.16	4.00	-0.72	-6.50	-1.32	1.11	4.00	4.58	-1.11
45.00	230.00	-1.18	-8.27	-3.67	-1.29	4.00	45.00	230.00	-16.20	-7.73	-7.71	-2.13	4.00	-1.05	-4.98	-2.23	1.32	4.00	4.58	-1.17
45.00	240.00	-0.82	-9.88	-5.68	-3.60	4.00	45.00	240.00	-17.58	-4.68	-8.73	0.11	4.00	-0.73	-3.53	-3.93	1.65	4.00	4.69	-1.03
45.00	250.00	-1.62	-14.45	-7.23	-6.69	4.00	45.00	250.00	-16.21	-4.40	-11.72	1.11	4.00	-1.47	-3.99	-5.91	1.78	4.00	4.11	-1.44
45.00	260.00	-3.06	-16.45	-7.51	-9.93	4.00	45.00	260.00	-12.05	-4.81	-15.62	1.07	4.00	-2.54	-4.52	-6.89	1.40	4.00	3.43	-2.05
45.00	270.00	-2.93	-15.04	-6.20	-12.14	4.00	45.00	270.00	-9.80	-3.50	-13.51	0.51	4.00	-2.12	-3.21	-5.46	0.74	4.00	3.80	-1.93
45.00	280.00	-3.00	-13.85	-4.41	-13.00	4.00	45.00	280.00	-9.21	-2.63	-10.52	0.21	4.00	-2.07	-2.31	-3.46	0.41	4.00	4.28	-1.61
45.00	290.00	-2.77	-10.34	-3.39	-16.12	4.00	45.00	290.00	-7.50	-1.28	-8.48	0.80	4.00	-1.51	-0.77	-2.22	0.89	4.00	5.20	-0.74
45.00	300.00	-2.99	-7.30	-2.97	-12.49	4.00	45.00	300.00	-6.07	-0.38	-8.00	1.59	4.00	-1.25	0.42	-1.78	1.76	4.00	5.92	0.01
45.00	310.00	-1.67	-4.76	-1.51	-8.21	4.00	45.00	310.00	-7.03	-1.50	-10.06	1.69	4.00	-0.56	0.18	-0.94	2.11	4.00	6.30	0.37
45.00	320.00	-1.06	-5.30	-1.01	-7.11	4.00	45.00	320.00	-5.66	-2.67	-9.75	-0.59	4.00	0.23	-0.78	-0.47	0.28	4.00	5.85	-0.16
45.00	330.00	-1.13	-3.33	-1.05	-6.78	4.00	45.00	330.00	-3.53	-3.74	-7.10	-4.18	4.00	0.84	-0.52	-0.09	-2.28	4.00	5.58	-0.37
45.00	340.00	-1.33	-2.33	-1.11	-6.31	4.00	45.00	340.00	-4.27	-6.95	-4.99	-7.60	4.00	0.45	-1.04	0.38	-3.90	4.00	5.16	-0.71
45.00	350.00	-1.88	-1.69	-1.26	-4.05	4.00	45.00	350.00	-1.43	-4.59	-3.88	-13.85	4.00	1.36	0.11	0.63	-3.62	4.00	5.84	-0.02
60.00	0.00	-2.17	-11.06	1.24	-8.87	4.00	60.00	0.00	-2.80	-8.45	-6.44	-13.43	4.00	0.54	-6.55	1.92	-7.57	4.00	4.08	-1.13
60.00	10.00	-2.15	-13.14	1.41	-10.34	4.00	60.00	10.00	-0.94	-9.23	-11.53	-8.99	4.00	1.51	-7.75	1.63	-6.60	4.00	4.28	-0.89
60.00	20.00	-2.61	-8.29	1.12	-8.62	4.00	60.00	20.00	-1.05	-9.68	-29.57	-5.19	4.00	1.25	-5.92	1.12	-3.56	4.00	4.77	-0.80
60.00	30.00	-4.04	-8.24	-0.16	-6.28	4.00	60.00	30.00	-1.18	-7.39	-24.66	-4.01	4.00	0.63	-4.78	-0.14	-1.99	4.00	4.69	-1.12
60.00	40.00	-5.17	-9.43	-0.24	-9.62	4.00	60.00	40.00	-2.25	-3.55	-19.10	-6.20	4.00	-0.46	-2.55	-0.18	-4.57	4.00	4.25	-1.61
60.00	50.00	-8.15	-12.96	0.07	-14.17	4.00	60.00	50.00	-4.95	-1.78	-12.72	-5.08	4.00	-3.25	-1.46	0.29	-4.58	4.00	3.97	-1.86
60.00	60.00	-14.25	-29.10	-1.18	-12.89	4.00	60.00	60.00	-10.27	-0.36	-11.73	-3.76	4.00	-8.81	-0.35	-0.81	-3.26	4.00	3.29	-2.30
60.00	70.00	-13.48	-17.09	-3.52	-12.00	4.00	60.00	70.00	-26.37	0.78	-14.74	-3.92	4.00	-13.26	-3.20	-5.20	3.20	4.00	3.24	-1.37
60.00	80.00	-11.15	-13.36	-3.49	-12.36	4.00	60.00	80.00	-16.70	1.47	-23.40	-3.31	4.00	-10.08	1.61	-6.10	-2.80	4.00	2.72	-2.37
60.00	90.00	-6.94	-18.73	-2.31	-13.37	4.00	60.00	90.00	-9.74	2.56	-18.49	-2.56	4.00	-5.11	2.59	-6.20	-2.21	4.00	3.99	-1.30
60.00	100.00	-6.11	-21.91	-1.40	-15.50	4.00	60.00	100.00	-7.20	2.71	-11.23	-2.49	4.00	-3.61	2.72	-0.97	-2.28	4.00	5.32	-0.34
60.00	110.00	-5.27	-10.39	-0.40	-12.78	4.00	60.00	110.00	-4.64	2.21	-12.25	-1.70	4.00	-1.93	2.44	-0.13	-1.37	4.00	5.94	0.10
60.00	120.00	-5.40	-6.54	0.84	-8.44	4.00	60.00	120.00	-2.63	0.86	-11.36	-1.75	4.00	-0.79	1.59	1.09	-0.91	4.00	6.34	0.39
60.00	130.00	-3.67	-5.56	2.31	-11.57	4.00	60.00	130.00	-0.74	-0.99	-11.04	-1.09	4.00	1.05	0.31	2.51	-0.72	4.00	6.89	0.95
60.00	140.00	-2.40	-4.01	2.86	-17.59	4.00	60.00	140.00	0.05	-3.46	-13.27	-1.68	4.00	2.01	-0.72	2.96	-1.57	4.00	6.89	1.06
60.00	150.00	-1.91	-0.95	3.42	-6.90	4.00	60.00	150.00	0.24	-5.71	-18.05	-3.30	4.00	2.31	0.30	3.45	-1.73	4.00	7.32	1.51
60.00	160.00	-1.33	0.32	4.04	-1.67	4.00	60.00	160.00	-0.34	-6.01	-17.30	-5.17	4.00	2.20	1.23	4.07	-0.07	4.00	8.01	2.13
60.00	170.00	-0.12	-1.79	4.41	-7.76	4.00	60.00	170.00	-0.07	-3.66	-17.26	-7.41	4.00	2.92	0.39	4.44	-4.57	4.00	7.43	1.89
60.00	180.00	0.87	-5.98	3.82	-9.07	4.00	60.00	180.00	-2.14	-3.35	-6.16	-14.28	4.00	2.63	-1.46	4.24	-7.93	4.00	6.50	1.27
60.00	190.00	0.03	-10.85	2.21	-6.33	4.00	60.00	190.00	-4.08	-7.93	-3.35	-11.52	4.00	1.45	-6.14	3.28	-5.18	4.00	5.31	0.08
60.00	200.00	0.63	-10.32	1.32	-1.88	4.00	60.00	200.00	-7.41	-9.67	-5.15	-10.42	4.00	1.26	-6.97	2.20	-1.31	4.00	5.47	-0.07
60.00	210.00	-0.80	-12.76	0.46	0.56	4.00	60.00	210.00	-8.05	-10.84	-6.92	-5.30	4.00	-0.05	-8.68	1.19	1.56	4.00	5.36	-0.14
60.00	220.00	-0.48	-12.99	-0.07	-0.49	4.00	60.00	220.00	-19.66	-9.90	-6.15	-1.60	4.00	-0.43	-8.17	0.89	2.00	4.00	5.36	-0.14
60.00	230.00	-1.85	-9.42	-1.52	-3.95	4.00	60.00	230.00	-13.90	-5.96	-6.45	-0.30	4.00	-1.59	-4.34	-0.31	1.26	4.00	5.01	-0.80
60.00	240.00	-0.81	-8.78	-3.77	-5.98	4.00	60.00	240.00	-14.12	-3.38	-7.18	0.34	4.00	-0.61	-2.28	-2.14	1.25	4.00	5.20	-0.70
60.00	250.00	-1.32	-12.52	-4.58	-8.81	4.00	60.00	250.00	-15.21	-2.12	-8.50	1.28	4.00	-1.15	-1.74	-3.10	1.69	4.00	5.13	-0.70
60.00	260.00	-3.17	-16.89	-4.40	-11.22	4.00	60.00	260.00	-11.18	-1.58	-12.02	1.57	4.00	-2.53	-1.45	-3.71	1.79	4.00	4.80	-0.95
60.00	270.00	-4.44	-30.86	-3.05	-11.55	4.00	60.00	270.00	-10.01	-2.03	-13.18	0.51	4.00	-3.38	-2.02	-2.65	0.77	4.00	4.35	-1.51
60.00	280.00	-6.58	-19.36	-3.91	-10.88	4.00	60.00	280.00	-10.43	-2.70	-8.97	-0.84	4.00	-5.08	-2.61	-2.73	-0.43	4.00	3.46	-2.41
60.00	290.00	-11.12	-18.14	-3.52	-7.72	4.00	60.00	290.00	-11.89	-2.40	-5.43	-2.39	4.00	-8.48	-2.29	-1.36	-1.27	4.00	3.12	-2.58
60.00	300.00	-5.20	-14.77	-2.54	-5.47	4.00	60.00	300.00	-11.81	-1.66	-4.38	-3.38	4.00	-4.34	-1.45	-0.35	-1.29	4.00	4.28	-1.63
60.00	310.00	-1.51	-13.10	-1.63	-2.38	4.00	60.00	310.00	-8.46	-1.08	-5.81	-1.80	4.00	-0.71	-0.82	-0.23	0.93	4.00	5.84	-0.15
60.00	320.00	0.66	-12.25	-0.45	-2.94	4.00	60.00	320.00	-5.83	-2.71	-6.27	-1.40	4.00	1.54	-2.25	0.56	0.91	4.00	6.32	0.40
60.00	330.00	0.44	-13.25	-0.44	-4.97	4.00	60.00	330.00	-3.62	-5.91	-8.79	-5.05	4.00	1.88	-5.17	0.15	-2.00	4.00	5.12	-0.57
60.00	340.00	-1.12	-9.66	-0.32	-6.09	4.00	60.00	340.00	-3.57	-11.88	-7.76	-8.20	4.00	0.84	-7.62	0.40	-4.01	4.00	4.07	-1.43
60.00	350.00	-1.66	-8.65	-0.18	-8.05	4.00	60.00	350.00	-2.15	-8.77	-6.10	-10.85	4.00	1.11	-5.70	0.81	-6.22	4.00	4.20	-1.24
75.00	0.00	-1.54	-17.07	1.71	-10.00	4.00	75.00	0.00	-1.66	-18.56	-10.10	-19.97	4.00	1.41	-14.74	1.99	-9.58	4.00	3.37	-1.10
75.00	10.00	-2.55	-13.74	1.47	-9.35	4.00	75.00	10.00	-1.17	-10.41	-8.28	-9.43	4.00	1.20	-8.75	1.91	-6.38	4.00	4.19	-0.92
75.00	20.00	-2.08	-10.21	1.92	-8.27	4.00	75.00	20.00	-1.33	-9.66	-12.36	-4.86	4.00	1.32	-10.21	2.08	-3.23	4.00	4.69	-0.53
75.00	30.00																			



10500	0.00	-8.94	-5.97	-4.37	-6.93	4.00	10500	0.00	-13.49	-9.46	-19.48	-14.18	4.00	-7.63	-4.36	-4.24	-6.18	4.00	0.53	-5.39
10500	10.00	-4.46	-6.46	-2.17	-7.39	4.00	10500	10.00	-6.96	-16.55	-17.87	-15.28	4.00	-2.52	-6.05	-2.05	-6.74	4.00	1.92	-3.87
10500	20.00	-2.70	-8.56	-0.62	-5.14	4.00	10500	20.00	-3.06	-9.68	-12.73	-16.20	4.00	0.13	-6.07	-0.36	-4.81	4.00	3.66	-1.99
10500	30.00	-2.58	-6.05	-1.49	-7.52	4.00	10500	30.00	-1.59	-7.03	-14.74	-4.41	4.00	0.95	-3.50	-1.29	-2.68	4.00	4.56	-1.29
10500	40.00	-2.66	-5.96	-0.56	-7.32	4.00	10500	40.00	-2.46	-6.68	-8.17	-4.38	4.00	0.45	-3.29	0.13	-2.60	4.00	4.85	-1.02
10500	50.00	-3.80	-7.25	-2.94	-13.30	4.00	10500	50.00	-2.24	-6.86	-8.45	-2.98	4.00	0.06	-4.04	-1.86	-2.59	4.00	4.04	-1.85
10500	60.00	-2.37	-9.99	-7.94	-9.30	4.00	10500	60.00	-2.96	-3.27	-7.68	-4.70	4.00	0.36	-2.43	-4.80	-3.41	4.00	3.66	-2.14
10500	70.00	-1.9	-14.35	-4.71	-14.16	4.00	10500	70.00	-3.39	0.14	-7.85	-9.07	4.00	0.43	0.29	-2.99	-7.90	4.00	4.07	-1.49
10500	80.00	-1.97	-13.54	-2.32	-9.80	4.00	10500	80.00	-7.26	1.76	-18.01	-10.55	4.00	-0.84	1.89	-2.20	-7.15	4.00	4.52	-1.02
10500	90.00	-2.9	-14.93	-2.01	-7.26	4.00	10500	90.00	-17.74	1.55	-16.63	-9.97	4.00	-2.76	1.65	-1.86	-5.40	4.00	4.30	-1.35
10500	100.00	-3.68	-14.42	-3.73	-12.45	4.00	10500	100.00	-10.86	-0.88	-10.50	-15.03	4.00	-2.92	-0.69	-2.90	-10.54	4.00	2.45	-3.09
10500	110.00	-4.12	-11.08	-9.58	-12.20	4.00	10500	110.00	-5.1	-6.93	-9.31	-10.80	4.00	-1.57	-5.52	-6.43	-8.43	4.00	0.91	-4.72
10500	120.00	-3.50	-7.83	-7.75	-8.38	4.00	10500	120.00	-3.87	-9.31	-11.37	-3.29	4.00	-0.67	-5.50	-6.18	-2.12	4.00	2.71	-3.02
10500	130.00	-2.30	-5.56	-2.28	-8.60	4.00	10500	130.00	-4.04	-10.99	-18.56	-12.77	4.00	-0.07	-4.47	-2.18	-7.19	4.00	2.94	-2.72
10500	140.00	-1.64	-5.64	-3.43	-4.66	4.00	10500	140.00	-4.85	-9.47	-16.55	-4.54	4.00	0.06	-4.14	-3.22	-1.59	4.00	3.95	-1.92
10500	150.00	-1.86	-8.67	-5.12	-4.08	4.00	10500	150.00	-2.92	-13.76	-21.86	-7.53	4.00	0.65	-7.50	-5.03	-2.46	4.00	2.96	-2.55
10500	160.00	-0.57	-6.66	-0.67	-6.33	4.00	10500	160.00	-4.03	-8.67	-15.27	-14.59	4.00	1.05	-4.54	-0.52	-5.73	4.00	4.03	-1.58
10500	170.00	-2.56	-3.26	0.69	-6.08	4.00	10500	170.00	-2.02	-7.20	-25.23	-15.74	4.00	0.73	-1.79	0.70	-5.63	4.00	4.88	-0.84
10500	180.00	-5.26	-2.21	1.06	-8.18	4.00	10500	180.00	-5.05	-7.25	-13.37	-11.46	4.00	-2.14	-1.03	1.21	-6.51	4.00	4.33	-1.33
10500	190.00	-4.77	-8.01	0.12	-6.98	4.00	10500	190.00	-7.79	-21.58	-9.09	-14.21	4.00	-3.01	-7.82	0.61	-6.23	4.00	2.52	-2.89
10500	200.00	-7.14	-16.55	-3.04	-9.91	4.00	10500	200.00	-13.14	-15.39	-7.01	-14.57	4.00	-6.17	-12.92	-1.58	-8.63	4.00	-0.35	-5.51
10500	210.00	-6.67	-12.10	-2.16	-7.23	4.00	10500	210.00	-9.95	-12.35	-15.84	-15.60	4.00	-5.00	-9.21	-1.98	-6.64	4.00	0.71	-4.92
10500	220.00	-12.08	-13.73	-1.48	-4.72	4.00	10500	220.00	-8.61	-17.35	-13.98	-3.52	4.00	-7.00	-12.16	-1.24	-1.07	4.00	1.74	-3.48
10500	230.00	-7.41	-18.40	-5.14	-5.11	4.00	10500	230.00	-13.89	-10.27	-10.42	0.09	4.00	-6.53	-9.65	-4.01	1.24	4.00	2.22	-2.89
10500	240.00	-8.83	-14.56	-10.49	-11.35	4.00	10500	240.00	-13.31	-13.78	-10.62	1.68	4.00	-7.51	-11.14	-7.54	1.89	4.00	1.44	-3.06
10500	250.00	-16.85	-18.67	-6.53	-17.74	4.00	10500	250.00	-11.66	-10.27	-13.45	1.68	4.00	-10.51	-9.68	-5.73	1.73	4.00	1.45	-3.11
10500	260.00	-7.57	-33.24	-3.49	-14.52	4.00	10500	260.00	-17.15	-3.11	-32.00	1.77	4.00	-7.12	-3.11	-3.48	1.87	4.00	3.67	-1.76
10500	270.00	-11.32	-25.85	-1.94	-10.03	4.00	10500	270.00	-17.68	-1.45	-14.95	0.99	4.00	-10.42	-1.43	-1.73	1.32	4.00	3.90	-1.49
10500	280.00	-28.22	-15.12	-3.14	-8.78	4.00	10500	280.00	-9.24	-3.45	-12.69	-0.39	4.00	-9.19	-3.16	-2.68	0.20	4.00	2.92	-2.62
10500	290.00	-7.32	-16.16	-5.72	-7.03	4.00	10500	290.00	-8.54	-7.88	-12.19	-4.35	4.00	-4.88	-7.28	-4.84	-2.48	4.00	1.32	-4.54
10500	300.00	-5.89	-14.97	-11.96	-3.55	4.00	10500	300.00	-14.09	-5.20	-9.81	-11.62	4.00	-5.28	-4.76	-7.74	-2.92	4.00	1.01	-4.85
10500	310.00	-10.34	-5.00	-8.49	-0.85	4.00	10500	310.00	-21.57	-3.66	-10.05	-20.40	4.00	-10.02	-1.27	-6.19	-0.80	4.00	2.22	-3.19
10500	320.00	-10.91	-7.23	-8.18	-0.38	4.00	10500	320.00	-15.42	-10.69	-9.55	-13.24	4.00	-9.59	-5.61	-5.80	-0.16	4.00	1.40	-3.95
10500	330.00	-9.78	-3.62	-7.45	-3.17	4.00	10500	330.00	-10.59	-10.31	-12.36	-10.29	4.00	-7.16	-2.78	-6.23	-2.40	4.00	1.63	-4.16
10500	340.00	-10.79	-3.09	-6.37	-8.18	4.00	10500	340.00	-9.80	-9.02	-17.91	-6.00	4.00	-7.26	-2.10	-6.08	-3.94	4.00	1.40	-4.39
10500	350.00	-14.20	-5.31	-3.50	-7.09	4.00	10500	350.00	-8.40	-13.53	-23.30	-12.85	4.00	-7.39	-4.70	-3.45	-6.07	4.00	0.74	-5.16
12000	0.00	-13.59	-2.14	-6.15	-2.06	4.00	12000	0.00	-7.61	-12.35	-16.80	-14.38	4.00	-6.63	-1.74	-5.79	-1.81	4.00	2.31	-3.45
12000	10.00	-7.94	-1.63	-2.44	-4.23	4.00	12000	10.00	-9.21	-21.83	-20.62	-11.21	4.00	-5.52	-1.59	-2.37	-3.44	4.00	2.91	-3.00
12000	20.00	-6.64	-5.20	-2.56	-5.31	4.00	12000	20.00	-7.27	-16.71	-11.80	-8.36	4.00	-3.93	-4.90	-2.07	-3.56	4.00	2.46	-3.50
12000	30.00	-5.72	-5.30	-1.77	-7.02	4.00	12000	30.00	-4.61	-18.23	-9.94	-3.44	4.00	-2.12	-5.08	-1.15	-1.86	4.00	3.59	-2.32
12000	40.00	-5.36	-6.56	-1.22	-5.88	4.00	12000	40.00	-4.79	-11.10	-16.40	-3.18	4.00	-2.06	-5.25	-1.09	-1.31	4.00	3.74	-2.15
12000	50.00	-3.06	-7.76	-3.47	-7.96	4.00	12000	50.00	-4.99	-2.92	-17.37	-5.34	4.00	-0.91	-1.69	-3.30	-3.45	4.00	3.75	-2.20
12000	60.00	-0.71	-11.14	-8.98	-9.60	4.00	12000	60.00	-4.35	-3.45	-12.37	-4.66	4.00	0.85	-2.77	-7.34	-3.45	4.00	3.32	-2.25
12000	70.00	-0.38	-13.31	-7.87	-11.27	4.00	12000	70.00	-4.60	-5.22	-14.01	-5.61	4.00	1.01	-4.59	-6.92	-4.57	4.00	2.78	-2.67
12000	80.00	-0.83	-13.70	-5.17	-12.10	4.00	12000	80.00	-6.41	-1.72	-21.52	-12.77	4.00	0.23	-1.45	-5.07	-9.41	4.00	2.83	-2.60
12000	90.00	-1.91	-21.09	-4.29	-11.91	4.00	12000	90.00	-12.32	0.49	-27.56	-17.30	4.00	-1.53	0.52	-4.27	-10.81	4.00	2.92	-2.43
12000	100.00	-3.93	-16.81	-6.53	-15.32	4.00	12000	100.00	-15.43	0.23	-44.77	-17.96	4.00	-3.63	0.32	-6.53	-13.43	4.00	1.51	-3.53
12000	110.00	-4.79	-9.09	-16.98	-15.02	4.00	12000	110.00	-11.56	-1.30	-31.30	-10.71	4.00	-3.96	-0.63	-16.82	-9.34	4.00	0.21	-4.55
12000	120.00	-5.29	-6.00	-9.24	-20.50	4.00	12000	120.00	-13.35	-5.26	-25.22	-4.47	4.00	-4.66	-2.60	-9.13	-4.36	4.00	1.14	-4.62
12000	130.00	-5.40	-5.42	-5.81	-7.75	4.00	12000	130.00	-15.91	-10.24	-16.08	-20.30	4.00	-5.03	-4.18	-5.42	-7.52	4.00	0.57	-5.38
12000	140.00	-6.16	-6.57	-6.40	-5.56	4.00	12000	140.00	-13.25	-11.19	-13.34	-5.01	4.00	-5.38	-5.28	-5.60	-2.27	4.00	1.50	-4.39
12000	150.00	-4.82	-8.39	-5.33	-13.15	4.00	12000	150.00	-9.77	-24.89	-11.59	-8.96	4.00	-3.61	-8.29	-4.41	-7.56	4.00	1.28	-5.52
12000	160.00	-5.13	-10.46	-0.96	-8.78	4.00	12000	160.00	-8.58	-12.25	-17.81	-13.14	4.00	-3.51	-8.25	-0.87	-7.42	4.00	0.53	-3.99
12000	170.00	-4.62	-9.13	-2.16	-7.72	4.00	12000	170.00	-8.64	-9.65	-26.38	-26.75	4.00	-3.17	-6.37	-2.14	-7.67	4.00	1.47	-4.28
12000	180.00	-8.57	-2.80	-4.46	-7.29	4.00	12000	180.00	-9.04	-9.46	-14.10	-10.47	4.00	-5.79	-1.95	-4.01	-5.58	4.00	1.83	-4.05
12000	190.00	-9.04	-1.66	-5.28	-5.17	4.00	12000	190.00	-10.67	-39.07	-9.24	-17.54	4.00	-6.77	-1.66	-3.81	-4.93	4.00	1.93	-3.90
12000	200.00	-9.66	-8.34	-6.74	-8.96	4.00	12000	200.00	-15.79	-18.71	-11.48	-14.02	4.00	-8.71	-7.96	-5.48	-7.78	4.00	1.38	-7.30
12000	210.00	-16.05	-10.49	-7.16	-3.62	4.00	12000	210.00	-20.18	-16.50	-18.01	-28.34	4.00	-14.63	-9.52	-6.82	-3.61	4.00	-1.74	-7.04
12000	220.00	-16.44	-8.76	-5.61	-2.12	4.00	12000	220.00	-19.76	-11.65	-15.36	-7.88	4.00	-14.78	-6.96	-5.17	-1.10	4.00	0.27	-4.83
12000	230.00	-15.98	-13.24	-9.93	-4.71	4.00	12000	230.00	-18.46	-17.82	-13.47	-3.30	4.00	-14.04	-11.94	-8.34	-0.94	4.00	-1.25	-5.78
12000	240.00	-20.66	-21.81	-19.61	-10.01	4.00	12000	240.00	-14.89	-13.64	-12.68	-1.05	4.00	-13.87	-13.02					



15000	22000	-13.09	-7.51	-12.73	-15.92	4.00	15000	22000	-14.01	-10.79	-15.70	-10.83	4.00	-10.52	-5.84	-10.96	-9.66	4.00	-2.97	-8.71
15000	23000	-15.98	-10.85	-14.66	-18.59	4.00	15000	23000	-18.24	-10.35	-12.78	-8.29	4.00	-13.95	-7.58	-10.61	-7.90	4.00	-3.64	-9.36
15000	24000	-26.18	-27.85	-14.15	-25.34	4.00	15000	24000	-15.03	-16.62	-12.07	-5.74	4.00	-14.71	-16.30	-9.98	-5.69	4.00	-4.63	-9.71
15000	25000	-12.85	-24.22	-21.24	-20.28	4.00	15000	25000	-14.25	-22.49	-13.03	-3.04	4.00	-10.48	-20.26	-12.42	-2.96	4.00	-3.43	-7.81
15000	26000	-12.98	-20.91	-25.47	-14.43	4.00	15000	26000	-12.49	-17.06	-17.47	-2.76	4.00	-9.72	-15.56	-16.83	-2.47	4.00	-3.16	-7.44
15000	27000	-16.04	-16.84	-17.50	-12.68	4.00	15000	27000	-12.36	-7.86	-14.15	-3.19	4.00	-10.81	-7.34	-12.50	-2.73	4.00	-1.49	-6.69
15000	28000	-16.36	-11.34	-14.30	-11.02	4.00	15000	28000	-13.68	-2.30	-12.96	-3.92	4.00	-11.81	-1.79	-10.57	-3.15	4.00	0.27	-4.88
15000	29000	-13.99	-9.70	-13.54	-7.91	4.00	15000	29000	-12.83	-0.44	-10.39	-5.78	4.00	-10.36	0.05	-8.68	-3.71	4.00	1.33	-3.81
15000	30000	-11.46	-6.53	-20.18	-4.92	4.00	15000	30000	-9.85	-0.29	-8.92	-8.38	4.00	-7.57	0.64	-8.61	-3.30	4.00	2.11	-3.15
15000	31000	-10.73	-2.75	-21.95	-3.29	4.00	15000	31000	-6.39	-0.79	-10.76	-13.39	4.00	-5.03	1.35	-10.44	-2.89	4.00	2.76	-2.43
15000	32000	-10.79	-2.05	-10.81	-3.29	4.00	15000	32000	-6.34	-1.69	-13.50	-10.14	4.00	-5.01	1.14	-8.94	-2.47	4.00	2.96	-2.38
15000	33000	-14.24	-2.94	-9.03	-3.31	4.00	15000	33000	-7.89	-1.60	-15.58	-10.52	4.00	-6.98	0.79	-8.16	-2.55	4.00	2.54	-2.78
15000	34000	-20.56	-2.20	-8.52	-3.87	4.00	15000	34000	-10.79	-3.64	-14.79	-9.48	4.00	-10.35	0.15	-7.60	-2.82	4.00	1.80	-3.41
15000	35000	-16.47	-1.23	-8.10	-5.38	4.00	15000	35000	-15.35	-5.97	-11.96	-10.36	4.00	-12.86	0.03	-6.60	-4.18	4.00	1.27	-3.82
16500	0	-21.22	1.88	-9.82	-6.38	4.00	16500	0	-20.12	-1.97	-9.52	-6.63	4.00	-17.62	3.38	-6.66	-3.49	4.00	2.74	-1.46
16500	1000	-20.45	1.53	-8.79	-8.10	4.00	16500	1000	-30.21	-1.58	-11.71	-5.84	4.00	-20.01	3.26	-7.00	-3.81	4.00	2.43	-1.64
16500	2000	-15.58	0.67	-8.02	-8.97	4.00	16500	2000	-23.78	-0.46	-13.84	-6.62	4.00	-14.97	3.15	-7.01	-4.63	4.00	2.44	-1.80
16500	3000	-13.97	-1.23	-9.47	-7.74	4.00	16500	3000	-19.92	-0.03	-17.58	-10.79	4.00	-12.99	2.42	-8.85	-5.99	4.00	1.61	-2.64
16500	4000	-13.04	-4.14	-10.65	-7.87	4.00	16500	4000	-21.90	-0.61	-15.89	-17.07	4.00	-12.51	0.98	-9.51	-7.38	4.00	0.50	-3.96
16500	5000	-16.59	-7.70	-10.81	-10.20	4.00	16500	5000	-22.78	-1.93	-10.83	-13.80	4.00	-15.65	-0.91	-7.81	-8.63	4.00	-0.71	-5.45
16500	6000	-24.85	-12.70	-10.92	-10.08	4.00	16500	6000	-24.20	-4.10	-10.24	-13.77	4.00	-21.50	-3.54	-7.56	-8.53	4.00	-2.25	-7.18
16500	7000	-12.88	-17.40	-12.52	-9.00	4.00	16500	7000	-19.44	-6.30	-11.38	-12.37	4.00	-12.01	-5.98	-8.90	-7.36	4.00	-2.26	-8.04
16500	8000	-8.52	-15.39	-13.09	-11.42	4.00	16500	8000	-18.06	-6.09	-11.77	-6.48	4.00	-8.06	-5.61	-9.37	-5.27	4.00	-0.89	-6.76
16500	9000	-7.27	-11.11	-13.62	-15.10	4.00	16500	9000	-13.98	-5.86	-15.86	-4.33	4.00	-6.43	-4.73	-11.59	-3.98	4.00	-0.21	-5.88
16500	10000	-6.71	-8.42	-14.08	-23.48	4.00	16500	10000	-11.59	-5.89	-19.85	-4.90	4.00	-5.49	-3.96	-13.06	-4.84	4.00	-0.17	-5.76
16500	11000	-6.02	-6.14	-14.60	-15.39	4.00	16500	11000	-9.99	-6.79	-15.84	-6.86	4.00	-4.56	-3.44	-12.17	-6.29	4.00	-0.02	-5.61
16500	12000	-7.30	-6.34	-13.91	-10.97	4.00	16500	12000	-9.54	-9.88	-12.49	-12.00	4.00	-5.27	-4.75	-10.13	-8.44	4.00	-0.85	-6.61
16500	13000	-8.85	-8.64	-11.90	-10.29	4.00	16500	13000	-9.65	-19.25	-12.51	-20.31	4.00	-6.22	-8.28	-9.18	-9.88	4.00	-2.26	-8.16
16500	14000	-11.72	-9.98	-11.79	-8.80	4.00	16500	14000	-10.77	-19.14	-12.41	-15.64	4.00	-8.21	-9.48	-9.08	-7.98	4.00	-2.65	-8.65
16500	15000	-13.38	-6.03	-11.16	-5.94	4.00	16500	15000	-14.43	-15.42	-15.72	-12.88	4.00	-10.86	-5.56	-9.86	-5.14	4.00	-1.47	-7.16
16500	16000	-12.99	-3.45	-10.32	-4.01	4.00	16500	16000	-15.79	-20.16	-18.23	-10.53	4.00	-11.16	-3.36	-9.67	-3.14	4.00	-0.08	-5.48
16500	17000	-13.06	-2.92	-11.77	-4.41	4.00	16500	17000	-17.68	-18.99	-20.75	-10.58	4.00	-11.77	-2.81	-11.25	-3.47	4.00	-0.33	-5.55
16500	18000	-14.83	-2.60	-12.82	-6.02	4.00	16500	18000	-14.19	-14.84	-30.07	-13.65	4.00	-11.49	-2.35	-12.74	-5.33	4.00	-0.91	-6.02
16500	19000	-13.50	-2.62	-16.21	-9.26	4.00	16500	19000	-14.48	-22.69	-21.01	-17.92	4.00	-10.95	-2.58	-14.97	-8.71	4.00	-2.09	-6.99
16500	20000	-12.85	-3.55	-20.25	-19.69	4.00	16500	20000	-16.95	-16.61	-22.44	-20.89	4.00	-11.42	-3.34	-18.20	-17.24	4.00	-4.37	-8.47
16500	21000	-13.90	-5.23	-17.31	-15.39	4.00	16500	21000	-20.17	-14.65	-22.84	-12.31	4.00	-12.98	-4.76	-16.24	-10.57	4.00	-4.06	-9.07
16500	22000	-21.39	-8.52	-14.80	-9.49	4.00	16500	22000	-15.52	-11.11	-15.85	-6.54	4.00	-14.52	-6.61	-12.28	-4.76	4.00	-2.64	-7.91
16500	23000	-42.38	-7.82	-13.90	-9.86	4.00	16500	23000	-14.84	-8.45	-13.54	-3.94	4.00	-14.83	-5.11	-10.71	-2.95	4.00	-1.21	-6.32
16500	24000	-14.05	-9.22	-13.39	-14.03	4.00	16500	24000	-17.52	-6.35	-12.55	-3.73	4.00	-12.44	-4.54	-9.94	-3.34	4.00	-0.77	-6.14
16500	25000	-8.80	-12.06	-11.68	-23.26	4.00	16500	25000	-23.49	-5.70	-12.46	-4.73	4.00	-8.65	-4.80	-9.04	-4.67	4.00	-0.53	-6.32
16500	26000	-7.22	-14.17	-9.87	-17.50	4.00	16500	26000	-16.45	-6.85	-10.17	-7.15	4.00	-6.73	-6.11	-7.01	-6.77	4.00	-0.63	-6.64
16500	27000	-7.30	-11.06	-10.64	-16.68	4.00	16500	27000	-10.81	-9.94	-8.25	-12.02	4.00	-5.70	-7.45	-6.27	-10.74	4.00	-1.32	-7.16
16500	28000	-8.50	-8.33	-11.48	-15.93	4.00	16500	28000	-7.27	-11.69	-7.60	-39.72	4.00	-4.83	-6.68	-6.11	-15.91	4.00	-1.45	-6.91
16500	29000	-10.40	-9.34	-12.48	-18.53	4.00	16500	29000	-6.65	-7.71	-7.18	-13.48	4.00	-5.12	-5.44	-6.06	-12.30	4.00	-0.77	-6.48
16500	30000	-11.10	-15.51	-12.39	-12.93	4.00	16500	30000	-7.86	-4.96	-8.28	-7.52	4.00	-6.17	-4.59	-6.86	-6.42	4.00	0.05	-5.92
16500	31000	-12.28	-15.43	-10.35	-6.32	4.00	16500	31000	-9.41	-3.12	-9.47	-5.68	4.00	-7.60	-2.87	-6.88	-2.98	4.00	1.21	-4.56
16500	32000	-11.61	-4.81	-9.67	-3.04	4.00	16500	32000	-11.30	-3.61	-10.55	-6.60	4.00	-8.44	-1.16	-7.08	-1.45	4.00	2.08	-3.42
16500	33000	-11.51	1.24	-9.74	-2.25	4.00	16500	33000	-11.90	-4.43	-11.11	-11.37	4.00	-8.69	0.46	-7.36	-1.75	4.00	2.50	-2.80
16500	34000	-14.72	1.04	-10.32	-1.62	4.00	16500	34000	-12.61	-4.09	-10.62	-15.90	4.00	-10.53	2.20	-7.46	-1.46	4.00	3.09	-1.80
16500	35000	-16.16	1.88	-9.40	-3.29	4.00	16500	35000	-14.02	-3.34	-10.85	-9.33	4.00	-11.95	3.02	-7.05	-2.32	4.00	3.16	-1.47
18000	0	-13.92	-26.42	-11.09	-9.03	4.00	18000	0	-16.86	-12.81	-13.99	-17.10	4.00	-12.14	-12.62	-9.29	-8.40	4.00	-4.41	-10.25
18000	1000	-13.02	-21.23	-10.19	-8.58	4.00	18000	1000	-19.46	-13.27	-16.57	-22.37	4.00	-12.13	-12.63	-9.29	-8.40	4.00	-4.41	-10.24
18000	2000	-12.45	-18.19	-9.61	-8.41	4.00	18000	2000	-23.61	-14.04	-20.69	-39.72	4.00	-12.13	-12.63	-9.28	-8.41	4.00	-4.40	-10.24
18000	3000	-12.17	-16.15	-9.33	-8.50	4.00	18000	3000	-32.55	-15.18	-29.49	-25.07	4.00	-12.13	-12.63	-9.29	-8.41	4.00	-4.41	-10.25
18000	4000	-12.16	-14.72	-9.31	-8.86	4.00	18000	4000	-34.18	-16.80	-31.60	-18.40	4.00	-12.13	-12.63	-9.28	-8.40	4.00	-4.40	-10.24
18000	5000	-12.42	-13.72	-9.57	-9.52	4.00	18000	5000	-24.14	-19.13	-21.38	-14.85	4.00	-12.14	-12.62	-9.29	-8.40	4.00	-4.41	-10.25
18000	6000	-12.96	-13.07	-10.10	-10.53	4.00	18000	6000	-19.77	-22.73	-16.97	-12.53	4.00	-12.14	-12.62	-9.29	-8.41	4.00	-4.41	-10.25
18000	7000	-13.82	-12.72	-10.96	-11.97	4.00	18000	7000	-17.07	-29.53	-14.25	-10.92	4.00	-12.14	-12.63	-9.29	-8.40	4.00	-4.41	-10.25
18000	8000	-15.07	-12.63	-12.21	-14.03	4.00	18000	8000	-15.22	-42.73	-12.39	-9.79	4.00	-12.13	-12.63	-9.29	-8.40	4.00	-4.41	-10.24
18000	9000	-16.86	-12.81	-13.99	-17.10	4.00	18000	9000	-13.92	-26.42	-11.09	-9.03	4.00	-12.14	-12.62	-9.29	-8.40	4.00	-4.41	-10.25
18000	10000	-19.46	-13.27	-16.57	-22.37	4.00	18000	10000												



Frequency: 5700MHz

Angle (θ)		Theta Polarization				Nant	Angle (φ)		Phi Polarization				Nant	Total				Max Dg(dB)	Max Dg(dB)				
		Max Gain(dB)							Max Gain(dB)					Max Gain(dB)									
		Ant 1(G1)	Ant 2(G2)	Ant 3(G3)	Ant 4(G4)				Ant 1(G1)	Ant 2(G2)	Ant 3(G3)	Ant 4(G4)		Ant 1(G1)	Ant 2(G2)	Ant 3(G3)	Ant 4(G4)			Ant 1(G1)	Ant 2(G2)	Ant 3(G3)	Ant 4(G4)
		1.71	3.31	3.86	2.39				0.58	3.45	-2.89	3.48		3.22	3.62	4.17	3.76			8.28	2.29		
0.00	0.00	-22.66	2.03	-19.90	1.63	4.00	0.00	0.00	-2.17	-12.26	-6.03	-11.98	4.00	-2.13	2.19	-5.86	1.82	4.00	5.60	0.05			
0.00	10.00	-13.65	2.19	-14.59	1.81	4.00	0.00	10.00	-2.45	-33.62	-6.48	-28.32	4.00	-2.13	2.19	-5.86	1.81	4.00	5.60	0.05			
0.00	20.00	-9.48	2.08	-11.51	1.73	4.00	0.00	20.00	-3.01	-13.86	-7.23	-15.08	4.00	-2.13	2.19	-5.85	1.82	4.00	5.60	0.05			
0.00	30.00	-6.87	1.70	-9.44	1.37	4.00	0.00	30.00	-3.90	-7.53	-8.36	-8.28	4.00	-2.13	2.19	-5.86	1.82	4.00	5.60	0.05			
0.00	40.00	-5.08	1.02	-7.99	0.72	4.00	0.00	40.00	-5.20	-4.08	-9.96	-4.69	4.00	-2.13	2.19	-5.85	1.82	4.00	5.60	0.05			
0.00	50.00	-3.82	-0.01	-6.98	-0.28	4.00	0.00	50.00	-7.04	-1.82	-12.26	-2.35	4.00	-2.13	2.19	-5.85	1.82	4.00	5.60	0.05			
0.00	60.00	-2.95	-1.49	-6.32	-1.71	4.00	0.00	60.00	-9.74	-0.25	-15.80	-0.73	4.00	-2.12	2.18	-5.86	1.82	4.00	5.60	0.05			
0.00	70.00	-2.41	-3.59	-5.95	-3.75	4.00	0.00	70.00	-14.10	0.85	-22.40	0.41	4.00	-2.13	2.18	-5.85	1.82	4.00	5.60	0.05			
0.00	80.00	-2.16	-6.75	-5.86	-6.79	4.00	0.00	80.00	-24.04	1.59	-37.84	1.18	4.00	-2.13	2.18	-5.86	1.82	4.00	5.60	0.05			
0.00	90.00	-2.17	-12.26	-6.03	-11.98	4.00	0.00	90.00	-22.66	2.03	-19.90	1.63	4.00	-2.13	2.19	-5.86	1.82	4.00	5.60	0.05			
0.00	100.00	-2.45	-33.62	-6.48	-28.32	4.00	0.00	100.00	-13.65	2.19	-14.59	1.81	4.00	-2.13	2.19	-5.86	1.81	4.00	5.60	0.05			
0.00	110.00	-3.01	-13.86	-7.23	-15.08	4.00	0.00	110.00	-9.48	2.08	-11.51	1.73	4.00	-2.13	2.19	-5.85	1.82	4.00	5.60	0.05			
0.00	120.00	-3.90	-7.53	-8.36	-8.28	4.00	0.00	120.00	-6.87	1.70	-9.44	1.37	4.00	-2.13	2.19	-5.86	1.82	4.00	5.60	0.05			
0.00	130.00	-5.20	-4.08	-9.96	-4.69	4.00	0.00	130.00	-5.08	1.02	-7.99	0.72	4.00	-2.13	2.19	-5.85	1.82	4.00	5.60	0.05			
0.00	140.00	-7.04	-1.82	-12.26	-2.35	4.00	0.00	140.00	-3.82	-0.01	-6.98	-0.28	4.00	-2.13	2.19	-5.85	1.82	4.00	5.60	0.05			
0.00	150.00	-9.74	-0.25	-15.80	-0.73	4.00	0.00	150.00	-2.95	-1.49	-6.32	-1.71	4.00	-2.12	2.18	-5.86	1.82	4.00	5.60	0.05			
0.00	160.00	-14.10	0.85	-22.40	0.41	4.00	0.00	160.00	-2.41	-3.59	-5.95	-3.75	4.00	-2.13	2.18	-5.85	1.82	4.00	5.60	0.05			
0.00	170.00	-24.04	1.59	-37.84	1.18	4.00	0.00	170.00	-2.16	-6.75	-5.86	-6.79	4.00	-2.13	2.18	-5.86	1.82	4.00	5.60	0.05			
0.00	180.00	-22.66	2.03	-19.90	1.63	4.00	0.00	180.00	-2.17	-12.26	-6.03	-11.98	4.00	-2.13	2.19	-5.86	1.82	4.00	5.60	0.05			
0.00	190.00	-13.65	2.19	-14.59	1.81	4.00	0.00	190.00	-2.45	-33.62	-6.48	-28.32	4.00	-2.13	2.19	-5.86	1.81	4.00	5.60	0.05			
0.00	200.00	-9.48	2.08	-11.51	1.73	4.00	0.00	200.00	-3.01	-13.86	-7.23	-15.08	4.00	-2.13	2.19	-5.85	1.82	4.00	5.60	0.05			
0.00	210.00	-6.87	1.70	-9.44	1.37	4.00	0.00	210.00	-3.90	-7.53	-8.36	-8.28	4.00	-2.13	2.19	-5.86	1.82	4.00	5.60	0.05			
0.00	220.00	-5.08	1.02	-7.99	0.72	4.00	0.00	220.00	-5.20	-4.08	-9.96	-4.69	4.00	-2.13	2.19	-5.85	1.82	4.00	5.60	0.05			
0.00	230.00	-3.82	-0.01	-6.98	-0.28	4.00	0.00	230.00	-7.04	-1.82	-12.26	-2.35	4.00	-2.13	2.19	-5.85	1.82	4.00	5.60	0.05			
0.00	240.00	-2.95	-1.49	-6.32	-1.71	4.00	0.00	240.00	-9.74	-0.25	-15.80	-0.73	4.00	-2.12	2.18	-5.86	1.82	4.00	5.60	0.05			
0.00	250.00	-2.41	-3.59	-5.95	-3.75	4.00	0.00	250.00	-14.10	0.85	-22.40	0.41	4.00	-2.13	2.18	-5.85	1.82	4.00	5.60	0.05			
0.00	260.00	-2.16	-6.75	-5.86	-6.79	4.00	0.00	260.00	-24.04	1.59	-37.84	1.18	4.00	-2.13	2.18	-5.86	1.82	4.00	5.60	0.05			
0.00	270.00	-2.17	-12.26	-6.03	-11.98	4.00	0.00	270.00	-22.66	2.03	-19.90	1.63	4.00	-2.13	2.19	-5.86	1.82	4.00	5.60	0.05			
0.00	280.00	-2.45	-33.62	-6.48	-28.32	4.00	0.00	280.00	-13.65	2.19	-14.59	1.81	4.00	-2.13	2.19	-5.86	1.81	4.00	5.60	0.05			
0.00	290.00	-3.01	-13.86	-7.23	-15.08	4.00	0.00	290.00	-9.48	2.08	-11.51	1.73	4.00	-2.13	2.19	-5.85	1.82	4.00	5.60	0.05			
0.00	300.00	-3.90	-7.53	-8.36	-8.28	4.00	0.00	300.00	-6.87	1.70	-9.44	1.37	4.00	-2.13	2.19	-5.86	1.82	4.00	5.60	0.05			
0.00	310.00	-5.20	-4.08	-9.96	-4.69	4.00	0.00	310.00	-5.08	1.02	-7.99	0.72	4.00	-2.13	2.19	-5.85	1.82	4.00	5.60	0.05			
0.00	320.00	-7.04	-1.82	-12.26	-2.35	4.00	0.00	320.00	-3.82	-0.01	-6.98	-0.28	4.00	-2.13	2.19	-5.85	1.82	4.00	5.60	0.05			
0.00	330.00	-9.74	-0.25	-15.80	-0.73	4.00	0.00	330.00	-2.95	-1.49	-6.32	-1.71	4.00	-2.12	2.18	-5.86	1.82	4.00	5.60	0.05			
0.00	340.00	-14.10	0.85	-22.40	0.41	4.00	0.00	340.00	-2.41	-3.59	-5.95	-3.75	4.00	-2.13	2.18	-5.85	1.82	4.00	5.60	0.05			
0.00	350.00	-24.04	1.59	-37.84	1.18	4.00	0.00	350.00	-2.16	-6.75	-5.86	-6.79	4.00	-2.13	2.18	-5.86	1.82	4.00	5.60	0.05			
15.00	0.00	-15.18	3.24	-7.80	0.19	4.00	15.00	0.00	0.41	-10.75	-6.48	-29.67	4.00	0.53	3.41	-4.08	0.19	4.00	6.43	0.75			
15.00	10.00	-18.01	3.31	-5.79	-0.84	4.00	15.00	10.00	0.10	-21.67	-6.00	-16.97	4.00	0.17	3.32	-2.88	-0.74	4.00	6.28	0.56			
15.00	20.00	-23.45	3.02	-5.27	-2.15	4.00	15.00	20.00	-2.89	-14.22	-9.65	-10.82	4.00	-2.85	3.10	-3.92	-1.60	4.00	5.15	-0.39			
15.00	30.00	-13.65	2.29	-5.47	-4.21	4.00	15.00	30.00	-3.62	-8.04	-9.83	-6.47	4.00	-3.21	2.67	-4.11	-2.18	4.00	4.74	-0.81			
15.00	40.00	-11.55	1.15	-5.55	-4.95	4.00	15.00	40.00	-3.69	-4.73	-10.01	-3.82	4.00	-3.03	2.15	-4.22	-1.34	4.00	4.76	-0.90			
15.00	50.00	-7.91	-0.06	-5.34	-6.67	4.00	15.00	50.00	-6.50	-2.19	-14.27	-2.86	4.00	-4.14	2.01	-4.82	-1.35	4.00	4.38	-1.19			
15.00	60.00	-7.29	-2.32	-6.01	-8.56	4.00	15.00	60.00	-11.02	-0.83	-18.59	-2.40	4.00	-5.76	1.50	-5.78	-1.46	4.00	3.70	-1.78			
15.00	70.00	-6.83	-5.90	-5.68	-10.11	4.00	15.00	70.00	-17.04	0.06	-19.26	-2.21	4.00	-6.43	1.04	-5.49	-1.56	4.00	3.44	-2.08			
15.00	80.00	-6.53	-11.07	-6.43	-13.99	4.00	15.00	80.00	-19.94	0.47	-23.48	-1.51	4.00	-6.34	0.76	-6.35	-1.27	4.00	3.29	-2.21			
15.00	90.00	-7.49	-19.40	-5.86	-16.19	4.00	15.00	90.00	-11.22	0.97	-32.77	-1.54	4.00	-5.96	1.01	-5.85	-1.39	4.00	3.49	-2.04			
15.00	100.00	-8.47	-19.28	-5.24	-10.64	4.00	15.00	100.00	-7.38	0.82	-27.30	-1.30	4.00	-4.88	0.86	-5.21	-0.82	4.00	3.90	-1.75			
15.00	110.00	-10.46	-12.09	-4.21	-7.85	4.00	15.00	110.00	-5.09	1.01	-25.27	-2.12	4.00	-3.98	1.22	-4.18	-1.09	4.00	4.30	-1.42			
15.00	120.00	-14.72	-6.67	-4.43	-4.74	4.00	15.00	120.00	-3.69	0.99	-18.67	-2.59	4.00	-3.36	1.68	-4.27	-0.52	4.00	4.72	-0.98			
15.00	130.00	-24.55	-4.51	-4.06	-2.40	4.00	15.00	130.00	-2.58	0.30	-12.82	-4.65	4.00	-2.55	1.54	-3.52	-0.37	4.00	5.02	-0.78			
15.00	140.00	-24.33	-1.31	-4.53	-0.87	4.00	15.00	140.00	-2.40	-1.31	-11.09	-7.20	4.00	-2.37	1.70	-3.66	0.04	4.00	5.20	-0.58			
15.00	150.00	-15.84	0.27	-5.08	0.51	4.00	15.00	150.00	-2.33	-2.35	-9.68	-13.09	4.00	-2.14	2.16	-3.79	0.70	4.00	5.56	-0.17			
15.00	160.00	-10.88	1.65	-6.64	1.01	4.00	15.00	160.00	-2.40	-5.23	-7.51	-29.39	4.00	-1.82	2.46	-4.04	1.01	4.00	5.78	0.08			
15.00	170.00	-7.07	2.28	-8.74	1.52	4.00	15.00	170.00	-2.53	-9.52	-7.63	-13.32	4.00	-1.22	2.56	-5.14	1.66	4.00	5.97	0.34			
15.00	180.00	-6.24	2.51	-11.90	2.39	4.00	15.00	180.00	-3.57	-14.05	-7.78	-9.00	4.00	-1.69	2.60	-6.36	2.69	4.00	6.06	0.60			
15.00	190.00	-3.87	2.41	-13.66	1.65	4.00	15.00	190.00	-4.25	-18.31	-9.59	-5.35	4.00	-1.05	2.45	-8.15	2.44	4.00	5.86	0.46			
15.00	200.00	-2.53	2.08	-14.25	0.95	4.00	15.00	200.00	-5.31	-11.82	-8.81	-3.64	4.00	-0.69	2.25	-7.72	2.25	4.00	5.86	0.39			
15.00	210.00	-1.84	1.47	-13.77	0.28	4.00	15.00	210.00	-6.99	-6.21	-9.00	-1.56	4.00	-0.68	2.15	-7.75	2.47	4.00	5.90	0.4			



45.00	140.00	-3.05	-3.31	1.40	-6.31	4.00		45.00	140.00	-0.70	0.15	-19.83	-1.06	4.00
45.00	150.00	-1.76	-1.84	2.10	-3.13	4.00		45.00	150.00	-0.71	-0.84	-17.43	-3.19	4.00
45.00	160.00	-2.83	-0.85	2.67	-3.99	4.00		45.00	160.00	-1.19	-1.78	-18.29	-8.02	4.00
45.00	170.00	-1.25	-0.12	1.85	-1.17	4.00		45.00	170.00	-1.83	-3.37	-14.56	-12.67	4.00
45.00	180.00	1.71	1.89	0.74	1.50	4.00		45.00	180.00	-2.11	-4.66	-7.26	-21.69	4.00
45.00	190.00	0.93	0.19	-0.08	1.16	4.00		45.00	190.00	-4.24	-12.66	-4.43	-12.22	4.00
45.00	200.00	0.54	-5.53	-1.52	-1.08	4.00		45.00	200.00	-7.75	-14.80	-4.88	-7.81	4.00
45.00	210.00	0.21	-6.42	-2.54	-1.25	4.00		45.00	210.00	-9.28	-14.80	-6.38	-5.09	4.00
45.00	220.00	-0.47	-9.63	-3.93	-1.75	4.00		45.00	220.00	-18.93	-23.64	-7.89	-2.58	4.00
45.00	230.00	-0.35	-13.11	-3.47	-3.37	4.00		45.00	230.00	-31.09	-10.85	-7.41	-1.92	4.00
45.00	240.00	-1.08	-15.46	-3.95	-6.31	4.00		45.00	240.00	-16.96	-5.88	-7.21	-0.90	4.00
45.00	250.00	-2.78	-19.49	-6.30	-7.87	4.00		45.00	250.00	-18.80	-3.49	-8.35	-1.44	4.00
45.00	260.00	-3.24	-22.33	-7.56	-9.34	4.00		45.00	260.00	-26.83	-2.39	-11.19	-0.99	4.00
45.00	270.00	-2.38	-18.52	-7.08	-9.81	4.00		45.00	270.00	-16.04	-2.88	-11.85	-0.99	4.00
45.00	280.00	-1.69	-13.88	-5.63	-12.43	4.00		45.00	280.00	-10.12	-3.06	-11.12	0.07	4.00
45.00	290.00	-1.47	-9.38	-3.59	-14.64	4.00		45.00	290.00	-7.72	-2.74	-9.32	1.49	4.00
45.00	300.00	-2.78	-7.63	-2.21	-10.80	4.00		45.00	300.00	-7.05	-2.85	-10.12	1.97	4.00
45.00	310.00	-1.39	-7.21	-0.61	-7.70	4.00		45.00	310.00	-7.47	-4.69	-9.56	2.56	4.00
45.00	320.00	-1.25	-5.19	-0.81	-8.78	4.00		45.00	320.00	-5.20	-7.28	-8.40	0.61	4.00
45.00	330.00	-2.18	-2.89	-0.84	-9.92	4.00		45.00	330.00	-3.90	-6.57	-5.61	-2.35	4.00
45.00	340.00	-3.19	-4.31	-0.57	-8.51	4.00		45.00	340.00	-4.00	-8.54	-4.63	-9.21	4.00
45.00	350.00	-2.53	-3.11	-0.14	-7.25	4.00		45.00	350.00	-1.13	-3.29	-5.18	-18.85	4.00
60.00	0.00	-2.27	-14.23	-0.03	-8.53	4.00		60.00	0.00	-2.10	-7.39	-6.47	-10.68	4.00
60.00	10.00	-2.51	-11.32	0.07	-12.55	4.00		60.00	10.00	0.25	-10.70	-10.84	-11.15	4.00
60.00	20.00	-2.65	-9.03	0.16	-11.19	4.00		60.00	20.00	-0.45	-10.71	-18.56	-4.22	4.00
60.00	30.00	-4.93	-8.86	-0.69	-10.11	4.00		60.00	30.00	-1.20	-7.35	-25.58	-2.77	4.00
60.00	40.00	-7.95	-9.29	-1.11	-9.50	4.00		60.00	40.00	-2.95	-3.22	-19.03	-4.06	4.00
60.00	50.00	-11.44	-11.95	-0.61	-13.41	4.00		60.00	50.00	-4.27	-1.32	-10.94	-6.85	4.00
60.00	60.00	-15.39	-16.66	-0.73	-15.06	4.00		60.00	60.00	-5.98	0.68	-9.07	-5.33	4.00
60.00	70.00	-11.94	-24.91	-2.44	-11.48	4.00		60.00	70.00	-10.05	2.02	-14.46	-2.71	4.00
60.00	80.00	-10.40	-20.83	-2.89	-9.52	4.00		60.00	80.00	-12.79	2.67	-26.08	-1.98	4.00
60.00	90.00	-9.20	-17.09	-2.22	-13.76	4.00		60.00	90.00	-8.97	3.35	-14.61	-2.13	4.00
60.00	100.00	-8.49	-14.78	-1.63	-16.79	4.00		60.00	100.00	-6.34	3.43	-10.36	-2.63	4.00
60.00	110.00	-7.57	-8.39	-0.71	-11.06	4.00		60.00	110.00	-5.04	3.05	-9.24	-2.49	4.00
60.00	120.00	-6.89	-5.65	-0.06	-10.55	4.00		60.00	120.00	-3.13	1.53	-7.70	-2.42	4.00
60.00	130.00	-6.75	-3.41	1.29	-15.10	4.00		60.00	130.00	-1.71	-2.42	-9.06	-3.23	4.00
60.00	140.00	-3.70	-3.06	2.23	-16.84	4.00		60.00	140.00	-1.30	-4.28	-11.84	-2.76	4.00
60.00	150.00	-2.32	-2.37	2.39	-5.89	4.00		60.00	150.00	0.05	-4.17	-13.27	-2.85	4.00
60.00	160.00	-2.03	-1.50	3.18	-4.01	4.00		60.00	160.00	-0.30	-3.56	-11.20	-7.15	4.00
60.00	170.00	-1.33	-1.75	3.72	-25.28	4.00		60.00	170.00	-0.35	-2.41	-10.93	-6.01	4.00
60.00	180.00	0.67	-2.45	3.35	-2.99	4.00		60.00	180.00	-1.60	-3.67	-6.91	-9.82	4.00
60.00	190.00	0.67	-7.71	1.81	-1.13	4.00		60.00	190.00	-3.76	-14.26	-2.89	-8.46	4.00
60.00	200.00	0.23	-10.30	-0.19	0.41	4.00		60.00	200.00	-7.70	-15.63	-4.71	-9.61	4.00
60.00	210.00	-0.47	-12.39	-0.69	0.15	4.00		60.00	210.00	-8.53	-11.98	-7.68	-5.20	4.00
60.00	220.00	-0.46	-12.94	-0.02	-2.75	4.00		60.00	220.00	-18.61	-6.71	-7.03	-2.05	4.00
60.00	230.00	-2.58	-8.40	-1.04	-5.10	4.00		60.00	230.00	-9.10	-6.25	-5.57	-0.74	4.00
60.00	240.00	-0.73	-10.63	-3.78	-6.42	4.00		60.00	240.00	-14.86	-5.47	-5.47	-0.03	4.00
60.00	250.00	-1.43	-14.86	-4.65	-9.55	4.00		60.00	250.00	-13.84	-3.79	-7.92	0.98	4.00
60.00	260.00	-3.04	-18.80	-4.12	-12.13	4.00		60.00	260.00	-13.16	-2.68	-15.45	1.11	4.00
60.00	270.00	-4.65	-24.37	-2.18	-14.49	4.00		60.00	270.00	-10.06	-2.46	-14.95	0.62	4.00
60.00	280.00	-8.57	-12.15	-1.64	-22.49	4.00		60.00	280.00	-11.84	-3.14	-7.39	-0.96	4.00
60.00	290.00	-7.71	-11.52	-1.17	-15.00	4.00		60.00	290.00	-16.79	-2.59	-4.99	-2.41	4.00
60.00	300.00	-3.97	-11.68	-0.34	-7.12	4.00		60.00	300.00	-15.96	-0.92	-4.93	-1.02	4.00
60.00	310.00	-2.15	-17.50	0.14	-4.80	4.00		60.00	310.00	-8.60	-0.94	-5.30	1.04	4.00
60.00	320.00	0.14	-13.68	-0.33	-5.56	4.00		60.00	320.00	-5.18	-6.07	-6.37	0.08	4.00
60.00	330.00	0.07	-9.22	-0.69	-3.75	4.00		60.00	330.00	-3.50	-9.03	-6.44	-2.95	4.00
60.00	340.00	-1.86	-8.18	-0.63	-4.52	4.00		60.00	340.00	-3.85	-8.50	-5.83	-9.22	4.00
60.00	350.00	-2.77	-10.95	-1.19	-5.65	4.00		60.00	350.00	-1.77	-7.06	-4.85	-10.39	4.00
75.00	0.00	-2.59	-19.79	0.80	-10.51	4.00		75.00	0.00	-1.28	-16.40	-7.94	-31.12	4.00
75.00	10.00	-3.03	-18.32	-0.17	-8.95	4.00		75.00	10.00	-0.86	-11.33	-9.05	-10.28	4.00
75.00	20.00	-2.62	-13.60	0.24	-10.13	4.00		75.00	20.00	-1.58	-13.64	-15.77	-4.86	4.00
75.00	30.00	-3.19	-18.42	0.22	-11.48	4.00		75.00	30.00	-2.56	-8.51	-19.59	-4.85	4.00
75.00	40.00	-1.17	-12.58	0.67	-9.54	4.00		75.00	40.00	-2.34	-13.03	-23.99	-8.07	4.00
75.00	50.00	-1.26	-14.11	0.15	-10.11	4.00		75.00	50.00	-3.74	-12.15	-14.56	-7.23	4.00
75.00	60.00	-5.23	-30.42	-2.61	-12.03	4.00		75.00	60.00	-5.03	-8.10	-7.1	-8.92	4.00
75.00	70.00	-7.35	-26.52	-2.27	-15.48	4.00		75.00	70.00	-6.67	-4.63	-7.9	-2.86	4.00
75.00	80.00	-6.76	-17.77	-0.74	-8.66	4.00		75.00	80.00	-11.43	-2.10	-12.14	-1.67	4.00
75.00	90.00	-7.92	-16.15	-0.11	-12.76	4.00		75.00	90.00	-17.54	-0.31	-9.01	-1.87	4.00
75.00	100.00	-7.49	-17.94	-0.46	-16.21	4.00		75.00	100.00	-6.73	0.94	-7.71	-2.44	4.00
75.00	110.00	-5.97	-22.69	-1.40	-11.57	4.00		75.00	110.00	-2.19	0.86	-6.42	-4.44	4.00
75.00	120.00	-3.34	-20.46	-0.04	-10.10	4.00		75.00	120.00	-0.71	-1.52	-7.00	-2.40	4.00
75.00	130.00	-1.86	-12.26	1.77	-9.86	4.00		75.00	130.00	0.22	-6.11	-6.17	-1.99	4.00
75.00	140.00	-2.04	-12.05	1.53	-12.20	4.00		75.00	140.00	0.37	-10.09	-8.61	-2.08	4.00
75.00	150.00	-2.38	-6.18	2.13	-11.56	4.00		75.00	150.00	0.06	-17.14	-11.24	-3.41	4.00
75.00	160.00	-0.40	-4.51	3.36	-2.84	4.00		75.00	160.00	-0.61	-16.47	-10.40	-6.82	4.00
75.00	170.00	-0.34	-6.48	3.60	-7.07	4.00		75.00	170.00	-0.63	-6.90	-10.90	-7.87	4.00
75.00	180.00	0.49	-9.05	3.86	-6.06	4.00		75.00	180.00	-1.88	-4.46	-7.52	-15.62	4.00
75.00	190.00	-0.60	-10.17	2.69	-6.93	4.00		75.00	190.00	-4.52	-6.03	-3.52	-15.90	4.00
75.00	200.00	0.44	-7.78	1.56	-6.72	4.00		75.00	200.00	-11.45	-9.97	-6.91	-15.20	4.00
75.00	210.00	-1.48	-11.12	1.83	-7.45	4.00		75.00	210.00	-9.59	-9.96	-8.18	-9.40	4.00
75.00	220.00	-1.90	-9.58	0.95	-11.93	4.00		75.00	220.00	-12.30	-7.67	-6.30	-4.06	4.00
75.00	230.00	-1.24	-8.95	-1.13	-11.93	4.00		75.00	230.00	-6.69	-1.83	-3.94	-0.36	4.00
75.00	240.00	-3.44	-8.25	-4.81	-9.69	4.00		75.00	240.00	-8.30	-1.04	-4.50	1.36	4.00
75.00	250.00	-2.67	-11.10	-4.04	-10.09	4.00		75.00	250.00	-7.11	-0.94	-9.04	1.40	4.00
75.00	260.00	-0.66	-14.64	-1.94	-9.72	4.00		75.00	260.00	-10.63	0.06	-22.03	1.44	4.00
75.00	270.00	-0.51	-17.32	0.13	-10.02	4.00		75.00	270.00	-28.25	1.35	-14.02	0.75	4.00
75.00	280.00	-2.18	-15.24	-0.26	-9.81	4								



105.00	0.00	-7.62	-5.07	-4.64	-7.06	4.00	105.00	0.00	-12.13	-14.22	-14.93	-10.78	4.00	-6.30	-4.57	-4.25	-5.52	4.00	0.90	-5.09
105.00	10.00	-4.94	-9.02	-3.38	-8.74	4.00	105.00	10.00	-7.02	-20.99	-16.64	-10.27	4.00	-2.85	-8.75	-3.18	-6.43	4.00	1.05	-4.68
105.00	20.00	-3.83	-9.98	-0.44	-5.55	4.00	105.00	20.00	-3.95	-8.06	-12.98	-9.95	4.00	-0.88	-5.90	-0.20	-4.20	4.00	3.53	-2.21
105.00	30.00	-2.85	-7.37	-2.19	-8.83	4.00	105.00	30.00	-2.06	-5.08	-15.01	-5.05	4.00	0.57	-3.07	-1.97	-3.53	4.00	4.17	-1.68
105.00	40.00	-2.09	-10.18	-1.42	-9.71	4.00	105.00	40.00	-1.37	-6.38	-10.10	-4.10	4.00	1.30	-4.87	-0.87	-3.05	4.00	4.46	-1.27
105.00	50.00	-1.96	-8.71	-1.69	-14.19	4.00	105.00	50.00	-0.89	-6.85	-9.53	-3.51	4.00	1.62	-4.67	-1.03	-3.15	4.00	4.54	-1.16
105.00	60.00	-1.62	-10.60	-6.72	-9.12	4.00	105.00	60.00	-3.15	-3.94	-7.19	-3.27	4.00	0.69	-3.09	-3.94	-2.27	4.00	4.05	-1.77
105.00	70.00	-1.9	-11.72	-5.27	-11.30	4.00	105.00	70.00	-4.03	-0.32	-6.89	-10.06	4.00	0.17	-0.02	-2.99	-7.63	4.00	3.92	-1.69
105.00	80.00	-1.94	-13.57	-2.62	-11.71	4.00	105.00	80.00	-6.74	1.22	-12.10	-6.60	4.00	-0.70	1.36	-2.16	-5.43	4.00	4.63	-1.09
105.00	90.00	-2.94	-15.15	-1.76	-8.97	4.00	105.00	90.00	-11.56	1.23	-16.53	-5.88	4.00	-2.38	1.33	-1.62	-4.15	4.00	4.55	-1.23
105.00	100.00	-3.47	-17.40	-3.94	-14.06	4.00	105.00	100.00	-11.95	0.53	-10.36	-8.26	4.00	-2.89	0.60	-3.05	-7.25	4.00	3.31	-2.32
105.00	110.00	-3.65	-12.82	-8.94	-11.44	4.00	105.00	110.00	-5.44	-3.48	-8.91	-7.40	4.00	-1.44	-3.00	-5.91	-5.96	4.00	2.16	-3.64
105.00	120.00	-3.25	-9.23	-8.96	-8.91	4.00	105.00	120.00	-2.73	-23.98	-11.92	-4.32	4.00	0.03	-9.09	-7.18	-3.02	4.00	1.93	-3.42
105.00	130.00	-2.51	-9.52	-2.56	-11.77	4.00	105.00	130.00	-1.82	-11.98	-25.25	-14.82	4.00	0.86	-7.57	-2.54	-10.02	4.00	2.23	-2.90
105.00	140.00	-1.10	-9.92	-4.16	-8.40	4.00	105.00	140.00	-1.61	-9.35	-17.33	-3.76	4.00	1.66	-6.62	-3.96	-2.48	4.00	3.70	-1.78
105.00	150.00	-2.46	-11.01	-5.98	-6.92	4.00	105.00	150.00	-2.02	-10.60	-20.66	-8.79	4.00	0.78	-7.79	-5.83	-4.74	4.00	2.25	-3.10
105.00	160.00	-1.73	-10.84	-1.59	-9.13	4.00	105.00	160.00	-1.75	-6.45	-13.75	-11.16	4.00	1.27	-5.10	-1.33	-7.02	4.00	3.57	-1.90
105.00	170.00	-3.98	-5.94	-0.32	-12.22	4.00	105.00	170.00	-1.86	-5.52	-19.11	-19.96	4.00	0.22	-2.71	-0.26	-11.54	4.00	3.50	-1.87
105.00	180.00	-5.11	-4.70	0.34	-6.80	4.00	105.00	180.00	-2.90	-3.35	-23.19	-12.93	4.00	-0.86	-1.51	0.36	-5.85	4.00	4.35	-1.44
105.00	190.00	-5.57	-10.53	0.15	-4.93	4.00	105.00	190.00	-4.71	-13.84	-8.91	-9.95	4.00	-2.11	-8.87	0.66	-3.74	4.00	3.15	-2.34
105.00	200.00	-6.79	-15.31	-2.03	-7.32	4.00	105.00	200.00	-10.70	-16.52	-8.61	-13.28	4.00	-5.31	-12.86	-1.17	-6.34	4.00	0.53	-4.74
105.00	210.00	-7.20	-14.67	-0.80	-5.92	4.00	105.00	210.00	-11.78	-17.61	-17.25	-5.44	4.00	-5.90	-12.89	-0.70	-5.74	4.00	0.72	-4.48
105.00	220.00	-10.92	-17.15	-0.95	-4.98	4.00	105.00	220.00	-9.84	-21.35	-15.38	-19.71	4.00	-7.34	-15.75	-0.80	-2.19	4.00	1.15	-3.85
105.00	230.00	-6.83	-19.27	-4.43	-9.15	4.00	105.00	230.00	-10.86	-15.76	-14.75	-0.62	4.00	-5.38	-14.16	-4.04	-0.05	4.00	1.42	-3.69
105.00	240.00	-7.10	-14.17	-9.62	-17.79	4.00	105.00	240.00	-12.43	-16.76	-12.71	1.22	4.00	-5.98	-12.26	-7.89	1.27	4.00	1.24	-3.43
105.00	250.00	-17.76	-17.84	-5.39	-14.80	4.00	105.00	250.00	-11.11	-11.75	-16.80	1.23	4.00	-10.26	-10.79	-5.09	1.34	4.00	1.28	-3.35
105.00	260.00	-8.68	-27.16	-2.56	-10.50	4.00	105.00	260.00	-33.00	-3.92	-27.16	1.76	4.00	-8.66	-3.90	-2.54	2.01	4.00	3.56	-1.72
105.00	270.00	-10.68	-21.64	-2.16	-10.37	4.00	105.00	270.00	-19.68	-2.00	-12.81	1.73	4.00	-10.17	-1.95	-1.80	1.99	4.00	4.03	-1.28
105.00	280.00	-29.40	-18.32	-3.29	-12.14	4.00	105.00	280.00	-15.92	-3.65	-9.46	0.61	4.00	-15.73	-3.50	-2.35	0.83	4.00	2.59	-2.47
105.00	290.00	-9.40	-30.14	-8.37	-9.51	4.00	105.00	290.00	-13.73	-7.08	-8.50	-3.11	4.00	-8.04	-7.06	-5.42	-2.21	4.00	0.63	-5.08
105.00	300.00	-7.60	-9.41	-11.39	-4.39	4.00	105.00	300.00	-14.41	-4.07	-7.02	-10.06	4.00	-6.78	-2.96	-5.67	-3.35	4.00	1.48	-4.41
105.00	310.00	-10.68	-8.62	-6.59	-2.05	4.00	105.00	310.00	-19.51	-3.99	-10.55	-10.73	4.00	-10.15	-2.70	-5.12	-1.50	4.00	1.73	-3.85
105.00	320.00	-7.97	-11.29	-8.64	-1.21	4.00	105.00	320.00	-16.68	-9.73	-10.53	-7.90	4.00	-7.42	-7.43	-6.47	-0.37	4.00	1.15	-4.24
105.00	330.00	-9.25	-5.74	-10.50	-2.15	4.00	105.00	330.00	-11.49	-10.68	-9.92	-7.11	4.00	-7.22	-4.53	-7.19	-0.95	4.00	1.45	-4.15
105.00	340.00	-11.44	-6.26	-9.37	-5.82	4.00	105.00	340.00	-9.87	-12.04	-15.11	-3.94	4.00	-7.57	-5.24	-8.34	-1.77	4.00	0.68	-4.93
105.00	350.00	-15.12	-4.77	-6.07	-8.15	4.00	105.00	350.00	-14.47	-14.29	-18.85	-6.17	4.00	-11.77	-4.31	-4.89	-4.04	4.00	0.27	-5.39
120.00	0.00	-10.06	-5.74	-5.02	-2.35	4.00	120.00	0.00	-8.87	-18.42	-12.96	-12.05	4.00	-6.41	-5.51	-5.87	-1.91	4.00	1.29	-4.52
120.00	10.00	-6.04	-4.47	-2.25	-3.60	4.00	120.00	10.00	-9.09	-15.63	-17.23	-7.75	4.00	-4.29	-4.15	-2.11	-2.19	4.00	2.90	-3.06
120.00	20.00	-4.96	-4.65	-1.40	-3.80	4.00	120.00	20.00	-9.64	-15.81	-14.63	-7.77	4.00	-3.69	-4.33	-1.20	-2.34	4.00	3.22	-2.72
120.00	30.00	-7.84	-4.40	-1.39	-8.52	4.00	120.00	30.00	-7.47	-19.27	-8.79	-0.64	4.00	-4.64	-4.26	-0.66	0.02	4.00	3.88	-1.90
120.00	40.00	-4.47	-7.42	-1.71	-6.12	4.00	120.00	40.00	-6.33	-9.98	-13.22	-2.10	4.00	-2.29	-4.68	-1.41	-0.65	4.00	3.89	-2.02
120.00	50.00	-1.90	-8.34	-4.07	-7.99	4.00	120.00	50.00	-3.93	-1.04	-24.04	-3.40	4.00	0.21	-0.30	-4.03	-2.10	4.00	4.62	-1.26
120.00	60.00	-1.20	-10.44	-9.83	-7.90	4.00	120.00	60.00	-3.03	-0.91	-15.63	-4.36	4.00	0.99	-0.45	-8.82	-2.77	4.00	3.97	-1.52
120.00	70.00	-1.28	-14.32	-7.60	-15.27	4.00	120.00	70.00	-4.78	-5.61	-13.42	-6.16	4.00	0.32	-5.06	-6.59	-5.66	4.00	2.23	-3.28
120.00	80.00	-1.76	-17.70	-4.30	-10.91	4.00	120.00	80.00	-5.85	-3.76	-15.47	-14.21	4.00	-0.33	-3.59	-3.98	-9.24	4.00	2.28	-3.27
120.00	90.00	-2.57	-34.16	-3.47	-10.24	4.00	120.00	90.00	-8.75	-0.25	-18.83	-13.94	4.00	-1.63	-0.25	-3.35	-8.70	4.00	3.07	-2.54
120.00	100.00	-3.40	-17.33	-5.94	-13.53	4.00	120.00	100.00	-11.42	0.72	-19.93	-13.99	4.00	-2.76	0.79	-5.77	-10.74	4.00	2.37	-2.85
120.00	110.00	-3.68	-11.41	-15.53	-18.02	4.00	120.00	110.00	-10.55	-0.85	-16.33	-14.64	4.00	-2.87	-0.48	-12.90	-13.00	4.00	0.49	-4.22
120.00	120.00	-3.92	-7.67	-9.63	-24.08	4.00	120.00	120.00	-8.34	-4.20	-16.11	-6.12	4.00	-2.58	-2.59	-8.75	-6.05	4.00	1.40	-4.30
120.00	130.00	-4.12	-8.06	-5.95	-7.26	4.00	120.00	130.00	-11.34	-11.28	-26.50	-17.93	4.00	-3.37	-6.37	-5.91	-6.90	4.00	0.49	-5.41
120.00	140.00	-4.19	-8.11	-7.76	-5.21	4.00	120.00	140.00	-11.45	-7.61	-11.65	-2.81	4.00	-3.44	-4.84	-6.27	-0.84	4.00	2.41	-3.37
120.00	150.00	-5.53	-8.92	-7.98	-12.30	4.00	120.00	150.00	-8.85	-20.56	-12.07	-8.11	4.00	-3.87	-8.63	-6.55	-6.71	4.00	-0.25	-6.10
120.00	160.00	-5.07	-6.86	-1.45	-8.05	4.00	120.00	160.00	-10.49	-15.86	-15.11	-25.90	4.00	-3.97	-6.35	-1.27	-7.98	4.00	1.50	-4.15
120.00	170.00	-4.71	-9.99	-2.68	-6.23	4.00	120.00	170.00	-6.13	-10.82	-25.28	-17.77	4.00	-2.35	-7.37	-2.66	-5.94	4.00	1.70	-4.08
120.00	180.00	-7.89	-3.86	-4.01	-4.22	4.00	120.00	180.00	-9.11	-11.73	-16.21	-9.60	4.00	-5.45	-3.20	-3.76	-3.11	4.00	2.19	-3.79
120.00	190.00	-10.36	-2.10	-5.40	-3.30	4.00	120.00	190.00	-9.29	-26.04	-8.81	-13.42	4.00	-6.78	-2.08	-3.77	-2.90	4.00	2.31	-3.56
120.00	200.00	-12.04	-7.19	-8.37	-4.63	4.00	120.00	200.00	-12.30	-25.80	-11.11	-9.87	4.00	-9.16	-7.13	-6.52	-3.49	4.00	-0.31	-6.08
120.00	210.00	-14.28	-10.48	-9.58	-2.56	4.00	120.00	210.00	-16.24	-13.49	-16.26	-33.30	4.00	-12.14	-8.72	-8.74	-2.56	4.00	-1.29	-6.55
120.00	220.00	-21.79	-10.69	-5.28	-3.27	4.00	120.00	220.00	-37.30	-12.94	-14.76	-5.63	4.00	-21.67	-8.66	-4.82	-1.28	4.00	-0.50	-5.17
120.00	230.00	-20.72	-17.36	-8.83	-6.65	4.00	120.00	230.00	-18.98	-25.71	-15.80	-1.28	4.00	-16.75	-16.77	-8.03	-0.17	4.00	-2.18	-5.37
120.00	240.00	-22.																		



150.00	220.00	-13.18	-7.51	-11.35	-18.73	4.00	150.00	220.00	-11.84	-8.86	-11.33	-16.82	4.00
150.00	230.00	-19.17	-13.08	-14.44	-24.49	4.00	150.00	230.00	-18.16	-9.19	-11.85	-12.00	4.00
150.00	240.00	-17.59	-23.25	-12.46	-18.50	4.00	150.00	240.00	-14.86	-16.83	-10.25	-8.67	4.00
150.00	250.00	-12.67	-22.80	-15.89	-11.69	4.00	150.00	250.00	-13.26	-20.95	-12.60	-4.69	4.00
150.00	260.00	-12.95	-26.20	-25.46	-9.69	4.00	150.00	260.00	-14.83	-13.01	-17.46	-4.11	4.00
150.00	270.00	-16.55	-19.19	-22.64	-9.86	4.00	150.00	270.00	-15.48	-6.20	-15.91	-4.15	4.00
150.00	280.00	-13.83	-11.54	-15.34	-9.42	4.00	150.00	280.00	-17.83	-1.96	-13.43	-5.24	4.00
150.00	290.00	-9.61	-8.24	-13.71	-9.06	4.00	150.00	290.00	-13.66	-0.93	-10.43	-7.10	4.00
150.00	300.00	-9.41	-4.49	-18.69	-6.51	4.00	150.00	300.00	-8.04	-0.66	-8.48	-11.72	4.00
150.00	310.00	-8.80	-1.85	-23.00	-4.81	4.00	150.00	310.00	-6.22	-1.71	-8.52	-19.32	4.00
150.00	320.00	-13.40	-2.57	-10.95	-2.80	4.00	150.00	320.00	-5.69	-2.22	-11.00	-21.02	4.00
150.00	330.00	-14.14	-5.97	-10.12	-2.64	4.00	150.00	330.00	-5.38	-2.17	-12.67	-21.00	4.00
150.00	340.00	-18.53	-5.33	-12.14	-3.27	4.00	150.00	340.00	-9.03	-4.39	-10.57	-13.65	4.00
150.00	350.00	-18.97	-3.56	-11.04	-4.17	4.00	150.00	350.00	-14.29	-7.27	-9.54	-10.60	4.00
165.00	0.00	-31.16	-0.65	-10.93	-2.82	4.00	165.00	0.00	-21.11	-2.58	-7.77	-5.55	4.00
165.00	10.00	-19.20	-0.22	-9.05	-3.90	4.00	165.00	10.00	-15.39	-2.37	-7.84	-4.58	4.00
165.00	20.00	-14.14	-0.53	-9.37	-5.60	4.00	165.00	20.00	-12.66	-0.21	-9.49	-4.20	4.00
165.00	30.00	-12.12	-2.02	-9.36	-7.83	4.00	165.00	30.00	-14.33	0.49	-14.67	-6.16	4.00
165.00	40.00	-10.15	-4.07	-10.79	-8.91	4.00	165.00	40.00	-14.93	0.50	-12.62	-9.53	4.00
165.00	50.00	-12.38	-8.07	-12.58	-10.81	4.00	165.00	50.00	-16.01	-0.31	-12.08	-12.15	4.00
165.00	60.00	-21.21	-12.42	-11.86	-10.84	4.00	165.00	60.00	-26.03	-2.20	-10.23	-16.16	4.00
165.00	70.00	-17.75	-15.58	-12.36	-10.85	4.00	165.00	70.00	-34.89	-4.51	-10.18	-13.16	4.00
165.00	80.00	-12.23	-14.88	-13.62	-10.78	4.00	165.00	80.00	-20.78	-4.77	-10.55	-6.95	4.00
165.00	90.00	-8.46	-11.58	-14.15	-14.27	4.00	165.00	90.00	-14.63	-4.90	-13.07	-5.30	4.00
165.00	100.00	-7.29	-8.14	-15.11	-23.40	4.00	165.00	100.00	-12.18	-4.57	-17.99	-5.85	4.00
165.00	110.00	-7.15	-7.73	-14.42	-18.65	4.00	165.00	110.00	-10.15	-6.47	-13.88	-8.84	4.00
165.00	120.00	-6.81	-7.35	-12.53	-12.11	4.00	165.00	120.00	-8.41	-10.29	-11.91	-13.62	4.00
165.00	130.00	-9.46	-10.13	-13.23	-9.13	4.00	165.00	130.00	-7.08	-19.91	-10.58	-40.01	4.00
165.00	140.00	-11.08	-10.02	-12.10	-8.34	4.00	165.00	140.00	-8.78	-19.84	-11.78	-15.53	4.00
165.00	150.00	-12.74	-7.16	-12.65	-6.41	4.00	165.00	150.00	-10.29	-13.80	-13.22	-11.56	4.00
165.00	160.00	-10.80	-3.25	-11.55	-4.77	4.00	165.00	160.00	-15.92	-15.14	-17.41	-10.09	4.00
165.00	170.00	-11.00	-2.31	-13.99	-3.98	4.00	165.00	170.00	-18.16	-20.38	-21.19	-11.30	4.00
165.00	180.00	-11.28	-3.55	-12.74	-6.38	4.00	165.00	180.00	-15.32	-13.30	-35.87	-17.42	4.00
165.00	190.00	-11.58	-3.32	-12.89	-10.94	4.00	165.00	190.00	-16.60	-16.01	-29.35	-18.81	4.00
165.00	200.00	-11.74	-3.73	-13.61	-30.44	4.00	165.00	200.00	-18.51	-18.65	-27.04	-15.93	4.00
165.00	210.00	-13.50	-5.84	-15.25	-15.53	4.00	165.00	210.00	-20.18	-14.70	-18.60	-10.57	4.00
165.00	220.00	-15.82	-7.16	-16.63	-13.27	4.00	165.00	220.00	-16.07	-12.00	-14.51	-7.18	4.00
165.00	230.00	-35.36	-8.63	-14.69	-15.93	4.00	165.00	230.00	-14.36	-8.94	-11.63	-5.85	4.00
165.00	240.00	-15.22	-9.64	-12.02	-17.97	4.00	165.00	240.00	-13.99	-7.68	-11.58	-6.81	4.00
165.00	250.00	-9.04	-15.91	-9.36	-23.63	4.00	165.00	250.00	-16.19	-8.90	-11.10	-8.76	4.00
165.00	260.00	-7.08	-19.07	-8.34	-22.20	4.00	165.00	260.00	-11.53	-9.70	-9.84	-14.05	4.00
165.00	270.00	-7.21	-14.36	-8.65	-24.36	4.00	165.00	270.00	-8.55	-9.61	-7.81	-22.71	4.00
165.00	280.00	-9.64	-11.69	-10.75	-22.02	4.00	165.00	280.00	-7.89	-6.81	-6.69	-19.74	4.00
165.00	290.00	-9.44	-13.76	-13.27	-14.79	4.00	165.00	290.00	-7.95	-4.56	-6.46	-9.76	4.00
165.00	300.00	-9.77	-19.16	-12.32	-8.36	4.00	165.00	300.00	-9.00	-3.55	-7.14	-7.11	4.00
165.00	310.00	-10.02	-18.49	-13.26	-3.95	4.00	165.00	310.00	-10.17	-4.09	-8.82	-5.38	4.00
165.00	320.00	-12.71	-9.21	-12.61	-2.12	4.00	165.00	320.00	-10.13	-5.05	-10.29	-6.42	4.00
165.00	330.00	-15.73	-5.33	-13.50	-1.41	4.00	165.00	330.00	-7.99	-5.78	-11.20	-9.76	4.00
165.00	340.00	-18.02	-2.23	-13.46	-0.97	4.00	165.00	340.00	-10.46	-4.86	-11.57	-21.80	4.00
165.00	350.00	-27.83	-1.26	-12.58	-1.42	4.00	165.00	350.00	-14.87	-3.44	-10.74	-8.93	4.00
180.00	0.00	-14.91	-11.40	-14.84	-5.22	4.00	180.00	0.00	-14.46	-9.58	-12.61	-16.55	4.00
180.00	10.00	-13.56	-9.82	-13.19	-4.95	4.00	180.00	10.00	-16.19	-11.05	-14.02	-25.79	4.00
180.00	20.00	-12.63	-8.72	-12.03	-4.95	4.00	180.00	20.00	-18.69	-13.15	-16.02	-26.44	4.00
180.00	30.00	-12.03	-7.98	-11.25	-5.21	4.00	180.00	30.00	-22.61	-16.31	-19.00	-16.76	4.00
180.00	40.00	-11.72	-7.54	-10.77	-5.76	4.00	180.00	40.00	-30.62	-21.79	-24.02	-12.46	4.00
180.00	50.00	-11.69	-7.38	-10.58	-6.63	4.00	180.00	50.00	-35.90	-42.78	-38.61	-9.78	4.00
180.00	60.00	-11.91	-7.49	-10.65	-7.90	4.00	180.00	60.00	-24.29	-23.47	-28.00	-7.95	4.00
180.00	70.00	-12.42	-7.87	-11.00	-9.70	4.00	180.00	70.00	-19.65	-17.12	-20.90	-6.67	4.00
180.00	80.00	-13.25	-8.55	-11.63	-12.33	4.00	180.00	80.00	-16.83	-13.66	-17.22	-5.78	4.00
180.00	90.00	-14.46	-9.58	-12.61	-16.55	4.00	180.00	90.00	-14.91	-11.40	-14.84	-5.22	4.00
180.00	100.00	-16.19	-11.05	-14.02	-25.79	4.00	180.00	100.00	-13.56	-9.82	-13.19	-4.95	4.00
180.00	110.00	-18.69	-13.15	-16.02	-26.44	4.00	180.00	110.00	-12.63	-8.72	-12.03	-4.95	4.00
180.00	120.00	-22.61	-16.31	-19.00	-16.76	4.00	180.00	120.00	-12.03	-7.98	-11.25	-5.21	4.00
180.00	130.00	-30.62	-21.79	-24.02	-12.46	4.00	180.00	130.00	-11.72	-7.54	-10.77	-5.76	4.00
180.00	140.00	-35.90	-42.78	-38.61	-9.78	4.00	180.00	140.00	-11.69	-7.38	-10.58	-6.63	4.00
180.00	150.00	-24.29	-23.47	-28.00	-7.95	4.00	180.00	150.00	-11.91	-7.49	-10.65	-9.70	4.00
180.00	160.00	-19.65	-17.12	-20.90	-6.67	4.00	180.00	160.00	-12.42	-7.87	-11.00	-7.90	4.00
180.00	170.00	-16.83	-13.66	-17.22	-5.78	4.00	180.00	170.00	-13.25	-8.55	-11.63	-12.33	4.00
180.00	180.00	-14.91	-11.40	-14.84	-5.22	4.00	180.00	180.00	-14.46	-9.58	-12.61	-16.55	4.00
180.00	190.00	-13.56	-9.82	-13.19	-4.95	4.00	180.00	190.00	-16.19	-11.05	-14.02	-25.79	4.00
180.00	200.00	-12.63	-8.72	-12.03	-4.95	4.00	180.00	200.00	-18.69	-13.15	-16.02	-26.44	4.00
180.00	210.00	-12.03	-7.98	-11.25	-5.21	4.00	180.00	210.00	-22.61	-16.31	-19.00	-16.76	4.00
180.00	220.00	-11.72	-7.54	-10.77	-5.76	4.00	180.00	220.00	-30.62	-21.79	-24.02	-12.46	4.00
180.00	230.00	-11.69	-7.38	-10.58	-6.63	4.00	180.00	230.00	-35.90	-42.78	-38.61	-9.78	4.00
180.00	240.00	-11.91	-7.49	-10.65	-7.90	4.00	180.00	240.00	-24.29	-23.47	-28.00	-7.95	4.00
180.00	250.00	-12.42	-7.87	-11.00	-9.70	4.00	180.00	250.00	-19.65	-17.12	-20.90	-6.67	4.00
180.00	260.00	-13.25	-8.55	-11.63	-12.33	4.00	180.00	260.00	-16.83	-13.66	-17.22	-5.78	4.00
180.00	270.00	-14.46	-9.58	-12.61	-16.55	4.00	180.00	270.00	-14.91	-11.40	-14.84	-5.22	4.00
180.00	280.00	-16.19	-11.05	-14.02	-25.79	4.00	180.00	280.00	-13.56	-9.82	-13.19	-4.95	4.00
180.00	290.00	-18.69	-13.15	-16.02	-26.44	4.00	180.00	290.00	-12.63	-8.72	-12.03	-4.95	4.00
180.00	300.00	-22.61	-16.31	-19.00	-16.76	4.00	180.00	300.00	-12.03	-7.98	-11.25	-5.21	4.00
180.00	310.00	-30.62	-21.79	-24.02	-12.46	4.00	180.00	310.00	-11.72	-7.54	-10.77	-5.76	4.00
180.00	320.00	-35.90	-42.78	-38.61	-9.78	4.00	180.00	320.00	-11.69	-7.38	-10.58	-6.63	4.00
180.00	330.00	-24.29	-23.47	-28.00	-7.95	4.00	180.00	330.00	-11.91	-7.49	-10.65	-9.70	4.00
180.00	340.00	-19.65	-17.12	-20.90	-6.67	4.00	180.00	340.00	-12.42	-7.87	-11.00	-7.90	4.00
180.00	350.00	-16.83	-13.66	-17.22	-5.78	4.00	180.00	350.00	-13.25	-8.55</			



Frequency: 5745MHz

		Theta Polarization						Phi Polarization						Total						
Angle (θ)	Angle (ψ)	Max Gain(dBi)				Nant	Angle (θ)	Angle (ψ)	Max Gain(dBi)				Nant	Max Gain(dBi)				Nant	Max DG(dB)	
		Ant 1(G1)	Ant 2(G2)	Ant 3(G3)	Ant 4(G4)				Ant 1(G1)	Ant 2(G2)	Ant 3(G3)	Ant 4(G4)		Ant 1(G1)	Ant 2(G2)	Ant 3(G3)	Ant 4(G4)		8.14	2.14
		1.88	3.39	4.29	2.87				-0.02	3.14	-4.48	2.87		2.82	3.43	4.51	3.20		g1k	g1k
Ant 1(G1)	Ant 2(G2)	Ant 3(G3)	Ant 4(G4)	Ant 1(G1)	Ant 2(G2)	Ant 3(G3)	Ant 4(G4)	Ant 1(G1)	Ant 2(G2)	Ant 3(G3)	Ant 4(G4)	ISAT	454T							
0.00	0.00	-20.18	3.05	-16.45	2.76	4.00	0.00	0.00	-3.48	-13.45	-6.15	-13.09	4.00	-3.39	3.15	-5.76	2.87	4.00	6.06	0.72
0.00	10.00	-13.44	3.14	-12.63	2.87	4.00	0.00	10.00	-3.84	-28.57	-6.77	-33.83	4.00	-3.39	3.14	-5.77	2.87	4.00	6.06	0.72
0.00	20.00	-9.87	2.97	-10.18	2.72	4.00	0.00	20.00	-4.49	-10.87	-7.72	-11.64	4.00	-3.38	3.15	-5.77	2.88	4.00	6.07	0.72
0.00	30.00	-7.54	2.52	-8.48	2.29	4.00	0.00	30.00	-5.49	-5.58	-9.09	-6.10	4.00	-3.38	3.15	-5.76	2.88	4.00	6.07	0.73
0.00	40.00	-5.92	1.76	-7.29	1.55	4.00	0.00	40.00	-6.93	-2.49	-11.04	-2.93	4.00	-3.39	3.15	-5.76	2.87	4.00	6.07	0.72
0.00	50.00	-4.79	0.64	-6.49	0.45	4.00	0.00	50.00	-8.98	-0.43	-13.93	-0.82	4.00	-3.39	3.15	-5.77	2.87	4.00	6.06	0.72
0.00	60.00	-4.03	-0.97	-5.99	-1.12	4.00	0.00	60.00	-12.03	1.02	-18.72	0.66	4.00	-3.39	3.15	-5.76	2.87	4.00	6.06	0.72
0.00	70.00	-3.57	-3.28	-5.78	-3.37	4.00	0.00	70.00	-17.26	2.02	-31.37	1.70	4.00	-3.39	3.14	-5.77	2.88	4.00	6.06	0.72
0.00	80.00	-3.39	-6.82	-5.83	-6.80	4.00	0.00	80.00	-34.01	2.69	-24.06	2.38	4.00	-3.39	3.15	-5.77	2.88	4.00	6.07	0.73
0.00	90.00	-3.48	-13.45	-6.15	-13.09	4.00	0.00	90.00	-20.18	3.05	-16.45	2.76	4.00	-3.39	3.15	-5.76	2.87	4.00	6.06	0.72
0.00	100.00	-3.84	-28.57	-6.77	-33.83	4.00	0.00	100.00	-13.44	3.14	-12.63	2.87	4.00	-3.39	3.14	-5.77	2.87	4.00	6.06	0.72
0.00	110.00	-4.49	-10.87	-7.72	-11.64	4.00	0.00	110.00	-9.87	2.97	-10.18	2.72	4.00	-3.38	3.15	-5.77	2.88	4.00	6.07	0.72
0.00	120.00	-5.49	-5.58	-9.09	-6.10	4.00	0.00	120.00	-7.54	2.52	-8.48	2.29	4.00	-3.38	3.15	-5.76	2.88	4.00	6.07	0.73
0.00	130.00	-6.93	-2.49	-11.04	-2.93	4.00	0.00	130.00	-5.92	1.76	-7.29	1.55	4.00	-3.39	3.15	-5.76	2.87	4.00	6.07	0.72
0.00	140.00	-8.98	-0.43	-13.93	-0.82	4.00	0.00	140.00	-4.79	0.64	-6.49	0.45	4.00	-3.39	3.15	-5.77	2.87	4.00	6.06	0.72
0.00	150.00	-12.03	1.02	-18.72	0.66	4.00	0.00	150.00	-4.03	-0.97	-5.99	-1.12	4.00	-3.39	3.15	-5.76	2.87	4.00	6.06	0.72
0.00	160.00	-17.26	2.02	-31.37	1.70	4.00	0.00	160.00	-3.57	-3.28	-5.78	-3.37	4.00	-3.39	3.14	-5.77	2.88	4.00	6.06	0.72
0.00	170.00	-34.01	2.69	-24.06	2.38	4.00	0.00	170.00	-3.39	-6.82	-5.83	-6.80	4.00	-3.39	3.15	-5.77	2.88	4.00	6.07	0.73
0.00	180.00	-20.18	3.05	-16.45	2.76	4.00	0.00	180.00	-3.48	-13.45	-6.15	-13.09	4.00	-3.39	3.15	-5.76	2.87	4.00	6.06	0.72
0.00	190.00	-13.44	3.14	-12.63	2.87	4.00	0.00	190.00	-3.84	-28.57	-6.77	-33.83	4.00	-3.39	3.14	-5.77	2.87	4.00	6.06	0.72
0.00	200.00	-9.87	2.97	-10.18	2.72	4.00	0.00	200.00	-4.49	-10.87	-7.72	-11.64	4.00	-3.38	3.15	-5.77	2.88	4.00	6.07	0.72
0.00	210.00	-7.54	2.52	-8.48	2.29	4.00	0.00	210.00	-5.49	-5.58	-9.09	-6.10	4.00	-3.38	3.15	-5.76	2.88	4.00	6.07	0.73
0.00	220.00	-5.92	1.76	-7.29	1.55	4.00	0.00	220.00	-6.93	-2.49	-11.04	-2.93	4.00	-3.39	3.15	-5.76	2.87	4.00	6.07	0.72
0.00	230.00	-4.79	0.64	-6.49	0.45	4.00	0.00	230.00	-8.98	-0.43	-13.93	-0.82	4.00	-3.39	3.15	-5.77	2.87	4.00	6.06	0.72
0.00	240.00	-4.03	-0.97	-5.99	-1.12	4.00	0.00	240.00	-12.03	1.02	-18.72	0.66	4.00	-3.39	3.15	-5.76	2.87	4.00	6.06	0.72
0.00	250.00	-3.57	-3.28	-5.78	-3.37	4.00	0.00	250.00	-17.26	2.02	-31.37	1.70	4.00	-3.39	3.14	-5.77	2.88	4.00	6.06	0.72
0.00	260.00	-3.39	-6.82	-5.83	-6.80	4.00	0.00	260.00	-34.01	2.69	-24.06	2.38	4.00	-3.39	3.15	-5.77	2.88	4.00	6.07	0.73
0.00	270.00	-3.48	-13.45	-6.15	-13.09	4.00	0.00	270.00	-20.18	3.05	-16.45	2.76	4.00	-3.39	3.15	-5.76	2.87	4.00	6.06	0.72
0.00	280.00	-3.84	-28.57	-6.77	-33.83	4.00	0.00	280.00	-13.44	3.14	-12.63	2.87	4.00	-3.39	3.14	-5.77	2.87	4.00	6.06	0.72
0.00	290.00	-4.49	-10.87	-7.72	-11.64	4.00	0.00	290.00	-9.87	2.97	-10.18	2.72	4.00	-3.38	3.15	-5.77	2.88	4.00	6.07	0.72
0.00	300.00	-5.49	-5.58	-9.09	-6.10	4.00	0.00	300.00	-7.54	2.52	-8.48	2.29	4.00	-3.38	3.15	-5.76	2.88	4.00	6.07	0.73
0.00	310.00	-6.93	-2.49	-11.04	-2.93	4.00	0.00	310.00	-5.92	1.76	-7.29	1.55	4.00	-3.39	3.15	-5.76	2.87	4.00	6.07	0.72
0.00	320.00	-8.98	-0.43	-13.93	-0.82	4.00	0.00	320.00	-4.79	0.64	-6.49	0.45	4.00	-3.39	3.15	-5.77	2.87	4.00	6.06	0.72
0.00	330.00	-12.03	1.02	-18.72	0.66	4.00	0.00	330.00	-4.03	-0.97	-5.99	-1.12	4.00	-3.39	3.15	-5.76	2.87	4.00	6.06	0.72
0.00	340.00	-17.26	2.02	-31.37	1.70	4.00	0.00	340.00	-3.57	-3.28	-5.78	-3.37	4.00	-3.39	3.14	-5.77	2.88	4.00	6.06	0.72
0.00	350.00	-34.01	2.69	-24.06	2.38	4.00	0.00	350.00	-3.39	-6.82	-5.83	-6.80	4.00	-3.39	3.15	-5.77	2.88	4.00	6.07	0.73
15.00	0.00	-16.53	2.99	-7.19	1.41	4.00	15.00	0.00	-0.29	-9.72	-7.32	-29.66	4.00	-0.19	3.22	-4.24	1.41	4.00	6.48	0.81
15.00	10.00	-14.99	3.00	-5.70	0.83	4.00	15.00	10.00	-0.81	-17.63	-7.19	-17.22	4.00	-0.65	3.04	-3.37	0.90	4.00	6.31	0.57
15.00	20.00	-30.66	2.96	-5.04	-0.40	4.00	15.00	20.00	-3.59	-16.97	-11.78	-10.01	4.00	-3.58	3.00	-4.21	0.05	4.00	5.34	-0.19
15.00	30.00	-16.38	2.50	-5.23	-1.69	4.00	15.00	30.00	-5.50	-9.51	-12.18	-6.54	4.00	-5.16	2.77	-4.43	-0.46	4.00	4.80	-0.64
15.00	40.00	-10.54	1.65	-4.65	-3.27	4.00	15.00	40.00	-4.72	-5.04	-11.69	-4.28	4.00	-3.71	2.49	-3.87	-0.74	4.00	4.97	-0.64
15.00	50.00	-8.05	0.14	-4.78	-4.36	4.00	15.00	50.00	-7.59	-3.24	-14.89	-2.83	4.00	-4.80	1.78	-4.38	-0.52	4.00	4.48	-1.12
15.00	60.00	-6.12	-1.84	-4.67	-6.14	4.00	15.00	60.00	-11.73	-1.82	-19.72	-1.93	4.00	-5.07	1.18	-4.54	-0.53	4.00	4.18	-1.46
15.00	70.00	-6.30	-4.59	-5.44	-9.23	4.00	15.00	70.00	-18.40	-0.67	-18.47	-1.22	4.00	-6.04	0.81	-5.23	-0.58	4.00	3.75	-1.82
15.00	80.00	-6.11	-8.42	-5.01	-14.81	4.00	15.00	80.00	-20.43	0.25	-21.27	-0.63	4.00	-5.95	0.80	-4.91	-0.47	4.00	3.85	-1.74
15.00	90.00	-7.21	-14.09	-5.21	-18.47	4.00	15.00	90.00	-12.58	0.25	-20.20	-0.68	4.00	-6.10	0.41	-5.07	-0.61	4.00	3.62	-2.00
15.00	100.00	-8.47	-20.47	-4.11	-12.32	4.00	15.00	100.00	-7.93	0.48	-21.63	-1.00	4.00	-5.18	0.51	-4.03	-0.69	4.00	3.98	-1.74
15.00	110.00	-11.27	-11.75	-3.92	-7.70	4.00	15.00	110.00	-5.23	0.35	-32.83	-1.18	4.00	-4.26	0.61	-3.91	-0.31	4.00	4.32	-1.45
15.00	120.00	-14.33	-6.98	-3.12	-3.65	4.00	15.00	120.00	-4.24	0.23	-20.10	-2.97	4.00	-3.83	0.99	-3.03	-0.29	4.00	4.70	-1.10
15.00	130.00	-24.48	-4.10	-2.99	-1.49	4.00	15.00	130.00	-3.83	0.21	-16.94	-4.89	4.00	-3.79	1.58	-2.82	0.14	4.00	5.07	-0.69
15.00	140.00	-25.79	-1.91	-3.36	0.44	4.00	15.00	140.00	-3.37	-1.55	-13.30	-7.28	4.00	-3.35	1.28	-2.94	1.12	4.00	5.32	-0.45
15.00	150.00	-16.28	0.00	-4.70	1.33	4.00	15.00	150.00	-3.41	-2.89	-11.78	-12.68	4.00	-3.19	1.80	-3.92	1.50	4.00	5.46	-0.21
15.00	160.00	-11.24	1.31	-6.52	2.08	4.00	15.00	160.00	-4.04	-4.98	-8.88	-38.24	4.00	-3.28	2.23	-4.53	2.08	4.00	5.67	0.11
15.00	170.00	-8.38	2.37	-8.81	2.36	4.00	15.00	170.00	-4.31	-9.07	-9.64	-13.85	4.00	-2.87	2.67	-6.19	2.46	4.00	5.79	0.38
15.00	180.00	-5.61	2.26	-11.22	2.40	4.00	15.00	180.00	-4.85	-12.77	-8.60	-9.46	4.00	-2.20	2.39	-6.71	2.67	4.00	5.84	0.42
15.00	190.00	-3.69	2.35	-13.40	2.10	4.00	15.00	190.00	-5.42	-16.63	-10.02	-6.66	4.00	-1.46	2.40	-8.38	2.64	4.00	5.80	0.45
15.00	200.00	-2.47	2.01	-13.13	1.90	4.00	15.00	200.00	-5.91	-11.34	-9.52	-3.70	4.00	-0.85	2.21	-7.95	2.96	4.00	6.03	0.63
15.00	210.00	-2.11	1.32	-14.63	1.49	4.00	15.00	210.00	-7.21	-7.30	-11.08	-2.17	4.00	-0.94	1.88	-9.49	3.04	4.00		



45.00	140.00	-3.36	-3.50	1.65	-4.64	4.00	45.00	140.00	-2.20	-0.98	-15.07	-1.66	4.00	0.27	0.95	1.74	0.11	4.00	6.81	0.82
45.00	150.00	-1.50	-1.65	2.58	-2.29	4.00	45.00	150.00	-1.59	-1.84	-16.55	-4.89	4.00	1.47	1.27	2.63	-0.39	4.00	7.33	1.37
45.00	160.00	-2.28	0.57	2.60	-3.42	4.00	45.00	160.00	-2.91	-2.90	-18.47	-8.97	4.00	0.43	2.18	2.63	-2.35	4.00	6.95	1.12
45.00	170.00	-1.57	0.57	1.79	-0.41	4.00	45.00	170.00	-3.23	-4.78	-13.38	-16.98	4.00	0.69	1.68	1.92	-0.32	4.00	7.06	1.08
45.00	180.00	1.45	2.05	0.90	1.80	4.00	45.00	180.00	-3.69	-5.82	-9.55	-26.56	4.00	2.61	2.71	1.27	1.81	4.00	8.14	2.14
45.00	190.00	1.88	1.67	0.39	1.01	4.00	45.00	190.00	-5.12	-16.47	-6.64	-14.15	4.00	2.67	1.74	1.18	1.14	4.00	7.72	1.73
45.00	200.00	1.29	-3.46	-0.62	-0.64	4.00	45.00	200.00	-10.06	-13.32	-6.99	-10.15	4.00	1.60	-3.03	0.28	-0.18	4.00	5.84	-0.03
45.00	210.00	0.27	-4.21	-1.64	-0.97	4.00	45.00	210.00	-10.39	-10.82	-7.81	-6.41	4.00	0.63	-3.35	-0.70	0.12	4.00	5.32	-0.58
45.00	220.00	-0.53	-7.32	-2.80	-2.05	4.00	45.00	220.00	-18.16	-13.72	-9.85	-4.71	4.00	-0.46	-6.42	-2.02	-0.17	4.00	4.08	-1.68
45.00	230.00	-0.50	-15.86	-3.36	-3.61	4.00	45.00	230.00	-18.62	-16.62	-8.54	-3.30	4.00	-0.43	-13.21	-2.21	-0.44	4.00	3.21	-2.12
45.00	240.00	-0.82	-32.84	-3.61	-5.47	4.00	45.00	240.00	-20.88	-11.10	-9.23	-2.62	4.00	-0.78	-11.07	-2.56	-0.80	4.00	3.08	-2.40
45.00	250.00	-2.41	-29.27	-5.61	-7.54	4.00	45.00	250.00	-22.20	-6.65	-9.69	-2.83	4.00	-2.36	-6.63	-4.18	-1.57	4.00	2.55	-3.29
45.00	260.00	-2.97	-36.38	-6.20	-7.67	4.00	45.00	260.00	-35.09	-4.99	-10.60	-2.33	4.00	-2.97	-4.99	-4.85	-1.22	4.00	2.65	-3.22
45.00	270.00	-1.59	-20.45	-5.55	-9.07	4.00	45.00	270.00	-19.18	-4.08	-13.71	-1.75	4.00	-1.52	-3.98	-4.93	-1.01	4.00	3.31	-2.56
45.00	280.00	-0.61	-13.98	-4.17	-11.71	4.00	45.00	280.00	-13.07	-3.50	-12.85	-0.59	4.00	-0.37	-3.13	-3.62	-0.27	4.00	4.31	-1.58
45.00	290.00	-0.96	-9.23	-2.61	-12.90	4.00	45.00	290.00	-8.97	-2.69	-9.76	0.59	4.00	-0.32	-1.82	-1.84	0.78	4.00	5.29	-0.66
45.00	300.00	-1.75	-7.73	-1.40	-8.01	4.00	45.00	300.00	-8.98	-3.38	-9.27	1.26	4.00	-1.00	-2.02	-0.74	1.75	4.00	5.63	-0.27
45.00	310.00	-1.49	-7.57	-0.33	-6.15	4.00	45.00	310.00	-8.73	-5.98	-9.32	1.22	4.00	-0.74	-3.69	0.19	1.95	4.00	5.68	-0.13
45.00	320.00	-0.64	-5.55	-0.36	-5.70	4.00	45.00	320.00	-6.70	-7.51	-8.16	-0.24	4.00	0.32	-3.41	0.31	0.85	4.00	5.69	-0.20
45.00	330.00	-1.27	-3.21	-0.04	-7.30	4.00	45.00	330.00	-4.31	-7.53	-5.65	-2.93	4.00	0.48	-1.84	1.01	-1.58	4.00	5.63	-0.30
45.00	340.00	-2.98	-4.36	-0.11	-7.39	4.00	45.00	340.00	-5.61	-8.26	-5.91	-9.03	4.00	-1.09	-2.88	0.90	-5.12	4.00	4.26	-1.50
45.00	350.00	-3.19	-3.68	0.19	-8.15	4.00	45.00	350.00	-2.08	-4.18	-6.89	-40.83	4.00	0.41	-0.91	0.97	-8.15	4.00	4.76	-0.82
60.00	0.00	-2.49	-13.63	0.71	-8.19	4.00	60.00	0.00	-3.13	-9.41	-7.92	-10.90	4.00	0.21	-8.02	1.27	-6.33	4.00	3.70	-1.58
60.00	10.00	-2.42	-8.93	0.37	-12.81	4.00	60.00	10.00	-0.74	-9.95	-11.42	-10.60	4.00	1.51	-6.40	0.65	-8.56	4.00	3.86	-1.33
60.00	20.00	-2.58	-8.43	0.46	-11.34	4.00	60.00	20.00	-0.99	-13.12	-16.67	-5.13	4.00	1.30	-7.16	0.54	-4.20	4.00	4.30	-1.17
60.00	30.00	-4.35	-10.00	-0.01	-11.57	4.00	60.00	30.00	-2.05	-7.98	-21.40	-3.80	4.00	-0.04	-5.86	0.02	-3.13	4.00	4.09	-1.64
60.00	40.00	-8.12	-9.67	-1.42	-10.77	4.00	60.00	40.00	-3.57	-3.32	-25.21	-4.05	4.00	-2.26	-2.41	-1.40	-3.21	4.00	3.72	-2.28
60.00	50.00	-14.05	-12.76	-0.63	-12.78	4.00	60.00	50.00	-4.75	-2.19	-11.77	-5.79	4.00	-4.27	-1.82	-0.31	-5.00	4.00	3.38	-2.44
60.00	60.00	-15.33	-14.25	-0.26	-14.78	4.00	60.00	60.00	-6.08	-0.43	-11.29	-7.49	4.00	-5.59	-0.25	0.07	-6.75	4.00	3.42	-2.13
60.00	70.00	-11.73	-25.50	-1.14	-12.66	4.00	60.00	70.00	-9.71	0.89	-17.00	-4.55	4.00	-7.59	-3.20	-5.20	3.20	4.00	3.82	-1.19
60.00	80.00	-10.71	-17.83	-1.57	-9.68	4.00	60.00	80.00	-12.52	1.66	-29.03	-3.55	4.00	-8.51	1.71	-6.10	-2.60	4.00	3.01	-2.19
60.00	90.00	-10.93	-15.75	-0.88	-13.70	4.00	60.00	90.00	-10.95	2.09	-16.69	-2.46	4.00	-7.93	2.16	-6.20	-2.15	4.00	3.39	-1.78
60.00	100.00	-8.61	-14.42	-0.48	-16.14	4.00	60.00	100.00	-7.44	2.42	-12.53	-2.52	4.00	-4.98	2.51	-0.22	-2.34	4.00	5.20	-0.42
60.00	110.00	-8.37	-9.08	-0.51	-11.70	4.00	60.00	110.00	-6.44	2.25	-11.00	-2.80	4.00	-4.29	2.56	-0.14	-2.27	4.00	5.36	-0.30
60.00	120.00	-7.33	-5.44	-0.04	-10.77	4.00	60.00	120.00	-4.74	0.95	-10.26	-3.69	4.00	-2.83	1.85	0.35	-2.91	4.00	5.38	-0.40
60.00	130.00	-6.79	-2.80	1.65	-16.92	4.00	60.00	130.00	-2.44	-2.48	-9.78	-4.54	4.00	-1.08	0.37	1.95	-4.30	4.00	5.55	-0.21
60.00	140.00	-3.79	-2.29	2.09	-17.95	4.00	60.00	140.00	-2.37	-6.08	-13.92	-3.41	4.00	-0.01	-0.77	2.20	-3.26	4.00	5.77	-0.04
60.00	150.00	-2.53	-1.93	2.46	-6.29	4.00	60.00	150.00	-1.50	-5.60	-14.17	-5.14	4.00	1.03	-0.38	2.55	-2.67	4.00	6.36	0.54
60.00	160.00	-1.51	-1.11	3.30	-6.93	4.00	60.00	160.00	-1.33	-4.38	-11.26	-8.17	4.00	1.59	0.57	3.45	-4.50	4.00	6.75	1.10
60.00	170.00	-0.96	-0.64	3.83	-13.11	4.00	60.00	170.00	-1.36	-3.57	-12.80	-7.16	4.00	1.85	1.15	3.92	-6.18	4.00	6.93	1.42
60.00	180.00	0.88	-1.41	3.82	-1.27	4.00	60.00	180.00	-2.35	-5.19	-7.53	-10.19	4.00	2.57	0.11	4.13	-0.75	4.00	7.75	1.95
60.00	190.00	1.03	-7.33	2.21	0.07	4.00	60.00	190.00	-3.90	-16.66	-4.48	-8.85	4.00	2.24	-6.85	3.05	0.59	4.00	6.53	1.01
60.00	200.00	1.05	-10.52	0.08	0.60	4.00	60.00	200.00	-7.93	-23.33	-5.91	-10.29	4.00	1.57	-10.30	1.06	0.94	4.00	5.45	0.05
60.00	210.00	-0.19	-12.03	-0.91	0.05	4.00	60.00	210.00	-11.59	-11.71	-9.53	-5.84	4.00	0.11	-8.86	-0.35	1.05	4.00	4.77	-0.77
60.00	220.00	-0.54	-14.84	0.29	-2.85	4.00	60.00	220.00	-19.02	-7.46	-8.40	-3.28	4.00	-0.48	-6.73	0.84	-0.05	4.00	4.87	-0.82
60.00	230.00	-2.32	-10.70	-0.41	-4.29	4.00	60.00	230.00	-11.41	-6.84	-5.80	-2.66	4.00	-1.82	-5.34	0.69	-0.39	4.00	4.59	-1.19
60.00	240.00	-0.65	-12.15	-2.13	-5.69	4.00	60.00	240.00	-17.22	-5.81	-5.39	-0.88	4.00	-0.56	-4.90	-0.45	0.36	4.00	4.86	-0.98
60.00	250.00	-1.92	-15.63	-3.87	-8.67	4.00	60.00	250.00	-16.08	-5.84	-9.90	-0.34	4.00	-1.76	-5.41	-2.90	0.26	4.00	3.80	-1.99
60.00	260.00	-2.27	-20.12	-3.36	-12.89	4.00	60.00	260.00	-12.56	-3.49	-20.41	0.33	4.00	-1.88	-3.40	-3.28	0.53	4.00	4.17	-1.70
60.00	270.00	-4.60	-18.82	-1.90	-25.34	4.00	60.00	270.00	-10.33	-2.83	-16.07	-0.15	4.00	-3.57	-2.72	-1.74	-0.14	4.00	4.07	-1.85
60.00	280.00	-7.43	-12.04	-1.66	-28.95	4.00	60.00	280.00	-12.94	-2.76	-8.56	-1.40	4.00	-6.35	-2.28	-0.85	-1.39	4.00	3.55	-2.27
60.00	290.00	-4.65	-12.15	-0.12	-13.11	4.00	60.00	290.00	-18.38	-2.50	-6.10	-3.33	4.00	-4.47	-2.05	0.86	-2.90	4.00	4.10	-1.69
60.00	300.00	-2.84	-13.69	0.48	-8.74	4.00	60.00	300.00	-17.54	-2.26	-6.73	-2.82	4.00	-2.70	-1.96	1.24	-1.83	4.00	4.85	-1.02
60.00	310.00	-2.62	-18.93	1.36	-5.52	4.00	60.00	310.00	-10.08	-2.63	-7.34	0.14	4.00	-1.90	-2.53	1.91	1.18	4.00	5.89	0.07
60.00	320.00	0.05	-13.44	-0.16	-4.72	4.00	60.00	320.00	-6.15	-7.17	-6.94	-0.53	4.00	0.98	-6.25	0.67	0.87	4.00	6.56	-0.13
60.00	330.00	0.42	-7.50	-0.49	-3.10	4.00	60.00	330.00	-5.86	-11.04	-7.20	-3.43	4.00	1.34	-5.91	0.35	-0.25	4.00	5.31	-0.40
60.00	340.00	-1.84	-8.11	-0.43	-3.69	4.00	60.00	340.00	-4.19	-9.23	-6.73	-8.66	4.00	0.15	-5.62	0.48	-2.49	4.00	4.48	-1.26
60.00	350.00	-2.85	-12.61	-0.56	-4.97	4.00	60.00	350.00	-2.96	-7.87	-7.11	-12.06	4.00	0.11	-6.61	0.31	-4.19	4.00	3.90	-1.71
75.00	0.00	-2.43	-21.48	0.72	-12.19	4.00	75.00	0.00	-2.82	-18.46	-9.50	-35.26	4.00	0.39	-16.70	1.11	-12.17	4.00	2.20	-2.10
75.00	10.00	-2.34	-20.34	0.19	-9.64	4.00	75.00	10.00	-2.02	-11.42	-9.93	-12.19	4.00	0.83	-10.90	0.59	-7.72	4.00	3.13	-1.86
75.00	20.00	-2.14	-15.79	0.62	-10.25	4.00	75.00	20.00	-2.85	-14.79	-19.65	-6.90	4.00	0.53	-12.25	0.66	-5.25	4.00	3.32	-1.78



10500	0.00	-8.06	-4.68	-3.76	-5.75	4.00	10500	0.00	-14.42	-19.96	-14.67	-10.45	4.00	-7.16	-4.55	-3.42	-4.48	4.00	1.22	-4.70
10500	10.00	-3.98	-8.12	-4.83	-7.83	4.00	10500	10.00	-8.24	-26.33	-15.21	-10.99	4.00	-2.60	-8.05	-4.45	-6.12	4.00	0.95	-4.85
10500	20.00	-4.06	-8.54	-1.17	-5.29	4.00	10500	20.00	-5.67	-10.24	-13.40	-10.07	4.00	-1.78	-6.30	-0.92	-4.04	3.00	3.00	-2.79
10500	30.00	-2.40	-7.47	-1.86	-9.97	4.00	10500	30.00	-3.36	-6.15	-21.46	-7.49	4.00	0.16	-3.75	-1.81	-5.55	4.00	3.54	-2.23
10500	40.00	-1.31	-10.40	0.17	-10.52	4.00	10500	40.00	-2.11	-5.34	-13.07	-6.11	4.00	1.32	-4.16	0.37	-4.77	4.00	4.62	-1.02
10500	50.00	-1.32	-7.02	-0.46	-16.54	4.00	10500	50.00	-1.60	-6.56	-11.23	-5.20	4.00	1.55	-3.77	-0.11	-4.89	4.00	4.61	-1.04
10500	60.00	-0.68	-9.04	-5.45	-8.92	4.00	10500	60.00	-3.62	-4.33	-8.26	-5.13	4.00	1.10	-3.07	-3.62	-3.61	4.00	3.96	-1.78
10500	70.00	-0.69	-12.44	-5.59	-10.26	4.00	10500	70.00	-4.95	-1.86	-5.82	-10.02	4.00	0.69	-1.50	-2.69	-7.13	4.00	3.80	-1.85
10500	80.00	-0.96	-11.89	-1.79	-10.91	4.00	10500	80.00	-7.27	0.10	-11.39	-8.88	4.00	-0.05	0.37	-1.34	-6.77	4.00	4.49	-1.22
10500	90.00	-1.9	-13.02	-0.96	-8.90	4.00	10500	90.00	-11.17	-0.15	-16.95	-7.04	4.00	-1.41	0.07	-0.85	-4.86	4.00	4.44	-1.42
10500	100.00	-1.91	-15.62	-2.03	-14.61	4.00	10500	100.00	-12.64	-0.70	-10.10	-7.82	4.00	-1.56	-0.56	-1.40	-6.99	4.00	3.73	-2.04
10500	110.00	-3.38	-13.28	-7.18	-10.35	4.00	10500	110.00	-6.21	-4.47	-10.76	-8.14	4.00	-1.56	-3.93	-5.60	-6.10	4.00	1.91	-3.92
10500	120.00	-2.57	-8.90	-8.66	-7.19	4.00	10500	120.00	-3.23	-18.88	-12.23	-7.01	4.00	0.12	-8.48	-7.08	-4.09	4.00	1.79	-3.57
10500	130.00	-1.49	-10.84	-2.26	-14.93	4.00	10500	130.00	-2.01	-14.68	-33.71	-16.87	4.00	1.27	-9.34	-2.26	-12.78	4.00	1.94	-2.79
10500	140.00	-1.38	-12.54	-2.60	-7.99	4.00	10500	140.00	-2.39	-9.64	-18.55	-5.43	4.00	1.15	-7.84	-2.49	-3.51	4.00	3.42	-2.08
10500	150.00	-1.91	-12.06	-4.26	-7.24	4.00	10500	150.00	-2.30	-10.34	-20.17	-10.68	4.00	0.91	-8.11	-4.15	-5.62	4.00	2.44	-2.91
10500	160.00	-1.81	-8.96	-0.56	-9.83	4.00	10500	160.00	-2.13	-7.48	-14.13	-12.73	4.00	1.04	-5.15	-0.37	-8.03	4.00	3.62	-1.78
10500	170.00	-3.10	-5.14	-0.33	-13.91	4.00	10500	170.00	-2.39	-5.32	-19.25	-31.20	4.00	0.28	-2.22	-0.27	-13.83	4.00	3.46	-1.79
10500	180.00	-5.17	-5.30	0.79	-5.51	4.00	10500	180.00	-3.51	-5.03	-22.80	-16.84	4.00	-1.25	-2.15	0.81	-5.20	4.00	4.33	-1.45
10500	190.00	-5.37	-10.00	0.07	-4.40	4.00	10500	190.00	-4.21	-16.28	-9.25	-9.69	4.00	-1.74	-9.08	0.55	-3.27	4.00	3.29	-2.22
10500	200.00	-6.66	-18.36	-1.73	-6.93	4.00	10500	200.00	-9.29	-14.78	-8.98	-14.98	4.00	-4.77	-13.20	-0.98	-6.30	4.00	0.72	-4.52
10500	210.00	-7.22	-14.33	0.29	-5.50	4.00	10500	210.00	-11.75	-16.52	-18.06	-20.57	4.00	-5.91	-12.28	0.35	-5.37	4.00	1.33	-3.74
10500	220.00	-8.59	-20.81	-0.27	-4.67	4.00	10500	220.00	-9.84	-24.43	-17.19	-6.69	4.00	-6.16	-19.24	-0.18	-2.55	4.00	1.31	-3.54
10500	230.00	-6.21	-14.38	-3.83	-12.50	4.00	10500	230.00	-11.70	-15.56	-16.33	-1.58	4.00	-5.13	-11.92	-3.59	-1.24	4.00	1.35	-4.09
10500	240.00	-6.90	-10.98	-9.45	-16.22	4.00	10500	240.00	-12.67	-15.94	-13.38	-0.06	4.00	-5.88	-9.78	-7.97	0.04	4.00	0.97	-4.16
10500	250.00	-17.96	-13.99	-4.81	-11.30	4.00	10500	250.00	-11.75	-12.27	-18.15	0.34	4.00	-10.82	-10.04	-4.61	0.63	4.00	1.08	-3.76
10500	260.00	-7.32	-24.67	-2.04	-8.72	4.00	10500	260.00	-18.70	-4.07	-17.64	0.28	4.00	-7.01	-4.03	-1.92	0.79	4.00	3.44	-2.15
10500	270.00	-9.19	-26.14	-0.75	-9.88	4.00	10500	270.00	-20.44	-3.13	-11.73	0.50	4.00	-8.88	-3.11	-0.42	0.88	4.00	3.86	-1.62
10500	280.00	-23.90	-21.68	-1.73	-11.58	4.00	10500	280.00	-16.87	-5.08	-9.40	-0.47	4.00	-16.08	-4.99	-1.04	-0.15	4.00	2.25	-2.81
10500	290.00	-9.66	-23.26	-5.64	-8.80	4.00	10500	290.00	-14.80	-9.07	-7.11	-3.78	4.00	-8.50	-8.91	-3.30	-2.59	4.00	0.67	-4.92
10500	300.00	-5.76	-8.37	-7.63	-4.29	4.00	10500	300.00	-16.67	-4.25	-5.61	-8.21	4.00	-5.42	-2.83	-3.49	-2.81	4.00	2.44	-3.52
10500	310.00	-9.61	-8.56	-5.47	-1.32	4.00	10500	310.00	-21.29	-4.09	-8.51	-11.14	4.00	-9.32	-2.76	-3.72	-0.89	4.00	2.36	-3.27
10500	320.00	-6.74	-10.83	-6.47	-0.94	4.00	10500	320.00	-18.46	-9.98	-10.82	-7.99	4.00	-6.46	-7.37	-5.11	-0.16	4.00	1.73	-3.76
10500	330.00	-7.34	-5.64	-9.17	-2.52	4.00	10500	330.00	-10.93	-11.24	-10.76	-6.97	4.00	-5.76	-4.58	-6.88	-1.19	4.00	1.69	-4.04
10500	340.00	-11.97	-7.88	-7.81	-5.22	4.00	10500	340.00	-11.77	-12.46	-14.24	-4.35	4.00	-8.86	-6.58	-6.92	-1.75	4.00	0.41	-5.15
10500	350.00	-13.19	-4.90	-4.21	-7.20	4.00	10500	350.00	-15.11	-19.10	-20.43	-6.70	4.00	-11.03	-4.74	-4.11	-3.93	4.00	5.00	-5.20
12000	0.00	-7.11	-6.35	-4.94	-2.38	4.00	12000	0.00	-8.64	-18.66	-12.34	-14.68	4.00	-4.80	-6.10	-4.21	-2.13	4.00	1.83	-4.07
12000	10.00	-5.47	-5.69	-1.19	-2.67	4.00	12000	10.00	-11.91	-15.88	-17.95	-7.99	4.00	-4.58	-5.29	-1.10	-1.55	4.00	3.08	-2.76
12000	20.00	-4.57	-4.39	-1.76	-3.00	4.00	12000	20.00	-10.08	-14.35	-16.91	-8.12	4.00	-3.49	-3.97	-1.63	-1.84	4.00	3.35	-2.62
12000	30.00	-7.68	-4.76	-2.45	-7.95	4.00	12000	30.00	-9.15	-16.05	-9.70	-1.34	4.00	-5.34	-4.45	-1.70	-0.48	4.00	3.25	-2.55
12000	40.00	-5.29	-7.87	-1.67	-6.52	4.00	12000	40.00	-6.81	-8.50	-12.15	-2.94	4.00	-2.97	-5.16	-1.30	-1.36	4.00	3.46	-2.44
12000	50.00	-1.38	-8.37	-3.48	-7.69	4.00	12000	50.00	-3.99	-1.22	-27.24	-3.83	4.00	0.52	-0.45	-3.46	-2.33	4.00	4.73	-1.16
12000	60.00	-0.19	-10.35	-9.28	-6.77	4.00	12000	60.00	-3.93	-1.32	-15.59	-5.16	4.00	1.34	-0.81	-8.37	-2.88	4.00	4.02	-1.47
12000	70.00	-0.67	-12.67	-7.09	-14.76	4.00	12000	70.00	-6.09	-5.39	-13.76	-8.87	4.00	0.43	-4.65	-6.24	-7.87	4.00	2.03	-3.36
12000	80.00	-1.99	-15.29	-3.08	-11.85	4.00	12000	80.00	-7.49	-4.44	-13.93	-17.41	4.00	-0.91	-4.10	-2.74	-10.78	4.00	2.09	-3.43
12000	90.00	-2.09	-36.59	-2.33	-10.36	4.00	12000	90.00	-9.90	-1.13	-17.40	-18.20	4.00	-1.42	-1.13	-2.20	-9.70	4.00	3.02	-2.59
12000	100.00	-2.55	-16.30	-4.73	-13.08	4.00	12000	100.00	-12.15	-0.25	-17.63	-18.44	4.00	-2.10	-0.14	-4.51	-11.97	4.00	2.33	-3.01
12000	110.00	-3.66	-10.78	-13.22	-18.51	4.00	12000	110.00	-9.64	-1.84	-14.10	-14.65	4.00	-2.68	-1.32	-10.63	-13.15	4.00	4.46	-4.52
12000	120.00	-3.41	-8.44	-8.51	-20.94	4.00	12000	120.00	-7.18	-6.66	-13.09	-7.01	4.00	-1.89	-4.45	-7.21	-6.84	4.00	1.19	-4.55
12000	130.00	-2.22	-10.51	-4.84	-7.35	4.00	12000	130.00	-10.99	-11.37	-28.17	-14.09	4.00	-1.68	-7.91	-4.82	-6.52	4.00	1.11	-4.58
12000	140.00	-3.11	-11.13	-7.63	-4.96	4.00	12000	140.00	-11.90	-6.69	-11.48	-3.67	4.00	-2.57	-7.34	-6.13	-1.26	4.00	2.05	-3.64
12000	150.00	-4.73	-10.11	-7.92	-11.44	4.00	12000	150.00	-10.33	-18.65	-13.02	-10.39	4.00	-3.67	-9.54	-6.75	-7.87	4.00	-0.67	-6.41
12000	160.00	-4.63	-6.27	-1.64	-7.63	4.00	12000	160.00	-10.79	-16.49	-18.13	-18.71	4.00	-3.69	-5.88	-1.54	-7.30	4.00	1.69	-4.05
12000	170.00	-4.47	-7.19	-2.82	-5.46	4.00	12000	170.00	-7.39	-12.76	-23.52	-13.38	4.00	-2.68	-6.13	-2.78	-4.81	4.00	2.04	-3.87
12000	180.00	-7.37	-4.26	-3.82	-3.46	4.00	12000	180.00	-10.25	-14.08	-19.77	-10.66	4.00	-5.57	-3.83	-3.71	-2.70	4.00	2.13	-3.84
12000	190.00	-10.04	-1.97	-5.48	-2.99	4.00	12000	190.00	-10.73	-22.25	-10.68	-15.27	4.00	-7.36	-1.93	-4.33	-2.74	4.00	2.16	-3.65
12000	200.00	-11.70	-5.87	-7.74	-2.71	4.00	12000	200.00	-12.16	-34.21	-11.62	-9.72	4.00	-8.91	-5.86	-6.25	-1.92	4.00	0.65	-4.99
12000	210.00	-16.36	-10.22	-7.40	-1.74	4.00	12000	210.00	-13.56	-12.09	-17.94	-30.30	4.00	-11.73	-8.04	-7.03	-1.73	4.00	-0.36	-5.63
12000	220.00	-20.48	-9.47	-5.03	-3.64	4.00	12000	220.00	-34.01	-16.81	-15.71	-6.35	4.00	-20.29	-8.73	-4.67	-1.78	4.00	-0.62	-5.42
12000	230.00	-24.78	-17.51	-9.30	-8.04	4.00	12000	230.00	-21.22	-18.06	-16.82	-2.42	4.00	-19.63	-14.77	-8.59	-1.37	4.00	-2.42	-6.42
12000	240.00	-19.26	-19.81	-19.40	-16.16	4.00	12000	240.00	-14.16	-10.60	-21.77	-1.70	4.00	-1						



15000	220.00	-12.11	-6.86	-9.77	-13.93	4.00	15000	220.00	-15.26	-9.79	-9.53	-23.63	4.00	-10.40	-5.07	-6.64	-13.49	4.00	-2.29	-7.80
15000	230.00	-17.52	-12.29	-11.40	-16.99	4.00	15000	230.00	-19.56	-8.91	-9.87	-14.82	4.00	-15.41	-7.27	-7.56	-12.76	4.00	-4.07	-9.54
15000	240.00	-17.73	-21.75	-12.41	-14.52	4.00	15000	240.00	-17.38	-14.92	-11.55	-9.17	4.00	-14.54	-14.10	-8.95	-8.06	4.00	-4.90	-10.48
15000	250.00	-12.56	-24.75	-18.97	-10.65	4.00	15000	250.00	-16.04	-18.59	-15.37	-6.27	4.00	-10.95	-17.65	-13.80	-4.92	4.00	-4.54	-9.38
15000	260.00	-14.64	-31.39	-29.03	-8.44	4.00	15000	260.00	-16.35	-12.84	-16.28	-6.23	4.00	-12.40	-12.78	-16.06	-4.19	4.00	-4.12	-8.89
15000	270.00	-18.86	-17.90	-19.73	-9.31	4.00	15000	270.00	-21.29	-7.16	-17.72	-7.48	4.00	-16.90	-6.81	-15.60	-5.29	4.00	-3.68	-8.60
15000	280.00	-12.18	-9.65	-13.53	-9.90	4.00	15000	280.00	-25.33	-3.56	-16.47	-8.15	4.00	-11.97	-2.60	-11.75	-5.93	4.00	-1.13	-6.31
15000	290.00	-9.23	-6.58	-12.61	-8.62	4.00	15000	290.00	-13.66	-1.95	-12.86	-10.25	4.00	-7.89	-0.66	-9.72	-6.35	4.00	0.58	-4.69
15000	300.00	-7.90	-2.68	-14.29	-6.88	4.00	15000	300.00	-8.83	-1.92	-10.03	-16.65	4.00	-5.33	0.73	-8.65	-6.44	4.00	1.85	-3.38
15000	310.00	-9.22	-0.57	-20.23	-4.98	4.00	15000	310.00	-6.47	-2.34	-8.54	-18.50	4.00	-4.62	1.64	-8.26	-4.79	4.00	2.79	-2.43
15000	320.00	-14.62	-1.80	-11.05	-3.04	4.00	15000	320.00	-6.42	-3.00	-10.92	-21.55	4.00	-5.81	0.65	-7.97	-2.98	4.00	2.60	-2.82
15000	330.00	-15.02	-5.47	-11.28	-2.80	4.00	15000	330.00	-8.07	-3.32	-12.84	-41.69	4.00	-7.27	-1.25	-8.98	-2.80	4.00	1.51	-4.01
15000	340.00	-15.48	-6.84	-14.91	-3.42	4.00	15000	340.00	-10.78	-6.85	-11.35	-17.01	4.00	-9.51	-3.83	-9.76	-3.23	4.00	-0.04	-5.58
15000	350.00	-11.70	-4.60	-13.12	-4.20	4.00	15000	350.00	-15.40	-9.47	-10.25	-10.73	4.00	-10.16	-3.38	-8.44	-3.33	4.00	0.21	-5.36
16500	0.00	-25.63	-1.09	-9.07	-2.21	4.00	16500	0.00	-22.19	-3.99	-8.47	-6.17	4.00	-20.57	0.71	-5.75	-0.74	4.00	2.32	-2.41
16500	10.00	-19.29	-1.03	-8.89	-3.52	4.00	16500	10.00	-17.67	-3.57	-9.59	-5.22	4.00	-15.39	0.89	-6.22	-1.28	4.00	2.38	-2.52
16500	20.00	-13.61	-1.01	-7.59	-4.14	4.00	16500	20.00	-12.41	-1.66	-10.39	-4.53	4.00	-9.96	1.69	-5.76	-1.32	4.00	3.25	-1.91
16500	30.00	-9.46	-2.53	-8.35	-5.42	4.00	16500	30.00	-12.21	-0.71	-13.24	-6.80	4.00	-7.61	1.48	-7.13	-3.05	4.00	2.76	-2.46
16500	40.00	-9.56	-4.09	-10.32	-7.64	4.00	16500	40.00	-13.09	-0.59	-13.74	-9.40	4.00	-7.97	1.01	-8.69	-5.42	4.00	1.68	-3.36
16500	50.00	-11.33	-7.88	-12.26	-9.89	4.00	16500	50.00	-17.20	-1.32	-15.15	-12.41	4.00	-10.33	-0.45	-10.46	-7.96	4.00	-0.20	-5.07
16500	60.00	-20.70	-11.24	-13.12	-9.83	4.00	16500	60.00	-28.39	-2.68	-11.90	-15.03	4.00	-20.02	-2.11	-9.46	-8.68	4.00	-2.00	-6.61
16500	70.00	-17.51	-15.48	-13.39	-10.25	4.00	16500	70.00	-20.99	-5.34	-10.77	-15.59	4.00	-15.90	-4.94	-8.88	-9.14	4.00	-2.88	-8.25
16500	80.00	-9.48	-15.62	-13.33	-9.51	4.00	16500	80.00	-22.27	-5.53	-11.38	-9.41	4.00	-9.26	-5.12	-9.24	-6.45	4.00	-1.31	-7.15
16500	90.00	-6.23	-11.78	-14.69	-12.59	4.00	16500	90.00	-13.95	-5.30	-15.14	-6.25	4.00	-5.55	-4.42	-11.90	-5.34	4.00	-0.34	-6.03
16500	100.00	-5.76	-9.49	-14.48	-22.43	4.00	16500	100.00	-12.44	-5.76	-18.71	-7.41	4.00	-4.92	-4.23	-13.09	-7.28	4.00	-0.74	-6.30
16500	110.00	-5.16	-7.71	-15.09	-17.62	4.00	16500	110.00	-10.15	-7.29	-13.97	-10.60	4.00	-3.96	-4.48	-11.48	-9.81	4.00	-0.82	-6.32
16500	120.00	-6.20	-6.74	-13.32	-10.60	4.00	16500	120.00	-9.27	-12.34	-12.63	-16.83	4.00	-4.46	-5.68	-9.95	-9.67	4.00	-1.09	-6.79
16500	130.00	-7.90	-9.84	-11.66	-8.02	4.00	16500	130.00	-7.18	-21.29	-11.28	-22.39	4.00	-4.51	-9.54	-8.46	-7.86	4.00	-1.36	-7.15
16500	140.00	-10.63	-9.69	-12.06	-7.51	4.00	16500	140.00	-8.14	-21.26	-13.51	-18.41	4.00	-6.20	-9.40	-9.71	-7.17	4.00	-1.97	-7.87
16500	150.00	-11.38	-7.17	-11.34	-5.80	4.00	16500	150.00	-11.48	-16.95	-12.63	-12.83	4.00	-8.42	-6.74	-8.93	-5.01	4.00	-1.12	-6.99
16500	160.00	-10.53	-3.61	-10.23	-5.09	4.00	16500	160.00	-18.76	-15.58	-16.27	-11.36	4.00	-9.92	-3.34	-9.26	-4.17	4.00	-0.16	-5.74
16500	170.00	-9.55	-2.39	-11.42	-4.59	4.00	16500	170.00	-19.48	-19.65	-25.40	-12.90	4.00	-9.13	-2.31	-11.25	-3.99	4.00	0.09	-5.29
16500	180.00	-10.97	-3.49	-10.76	-6.49	4.00	16500	180.00	-14.66	-14.97	-41.51	-14.14	4.00	-9.42	-3.19	-10.76	-5.80	4.00	-0.76	-6.29
16500	190.00	-13.88	-3.36	-11.75	-11.46	4.00	16500	190.00	-15.74	-18.68	-26.54	-19.53	4.00	-11.70	-3.23	-11.61	-10.83	4.00	-2.50	-7.61
16500	200.00	-13.60	-3.68	-12.79	-21.69	4.00	16500	200.00	-16.64	-19.29	-29.75	-19.99	4.00	-11.85	-3.56	-12.70	-17.75	4.00	-3.87	-8.42
16500	210.00	-14.50	-5.60	-13.83	-14.62	4.00	16500	210.00	-20.66	-17.29	-20.46	-12.55	4.00	-13.56	-5.32	-12.98	-10.45	4.00	-3.90	-9.22
16500	220.00	-19.38	-6.73	-13.18	-12.39	4.00	16500	220.00	-16.32	-13.85	-15.60	-8.75	4.00	-14.58	-5.96	-11.21	-7.19	4.00	-3.08	-8.58
16500	230.00	-24.67	-7.82	-13.32	-12.88	4.00	16500	230.00	-15.08	-11.02	-12.53	-6.99	4.00	-14.63	-6.12	-9.90	-5.99	4.00	-2.49	-8.01
16500	240.00	-13.25	-10.98	-11.38	-16.17	4.00	16500	240.00	-14.08	-9.19	-13.68	-9.71	4.00	-10.63	-6.98	-9.37	-8.83	4.00	-2.83	-8.75
16500	250.00	-7.55	-17.08	-9.01	-20.47	4.00	16500	250.00	-17.05	-9.58	-11.54	-13.67	4.00	-7.09	-8.87	-7.08	-12.85	4.00	-2.66	-8.44
16500	260.00	-6.45	-19.78	-11.28	-26.06	4.00	16500	260.00	-12.00	-10.59	-11.44	-15.91	4.00	-5.38	-10.10	-8.35	-15.51	4.00	-3.09	-8.53
16500	270.00	-6.54	-15.73	-11.17	-20.82	4.00	16500	270.00	-9.34	-9.83	-8.49	-15.13	4.00	-4.71	-8.84	-6.62	-14.09	4.00	-1.90	-7.41
16500	280.00	-7.31	-13.28	-12.99	-16.48	4.00	16500	280.00	-8.59	-5.54	-8.16	-12.32	4.00	-4.89	-4.86	-6.93	-10.91	4.00	-0.56	-6.31
16500	290.00	-9.24	-15.35	-14.14	-11.59	4.00	16500	290.00	-8.86	-3.76	-7.37	-9.73	4.00	-6.04	-3.47	-6.54	-7.55	4.00	0.26	-5.62
16500	300.00	-8.82	-17.55	-14.71	-7.86	4.00	16500	300.00	-10.07	-3.84	-8.27	-6.87	4.00	-6.39	-3.66	-7.38	-4.33	4.00	0.71	-5.18
16500	310.00	-10.52	-18.04	-13.13	-3.36	4.00	16500	310.00	-11.36	-4.74	-10.57	-4.70	4.00	-7.91	-4.54	-8.65	-0.97	4.00	1.06	-4.41
16500	320.00	-12.23	-10.74	-11.37	-1.13	4.00	16500	320.00	-10.66	-5.61	-13.32	-6.91	4.00	-8.36	-4.45	-9.23	-0.11	4.00	1.27	-3.98
16500	330.00	-14.56	-6.03	-12.23	-0.37	4.00	16500	330.00	-8.92	-5.62	-15.83	-11.33	4.00	-7.87	-2.81	-10.66	-0.04	4.00	1.64	-3.55
16500	340.00	-19.32	-3.38	-12.81	-0.60	4.00	16500	340.00	-9.45	-5.90	-14.61	-29.05	4.00	-9.02	-1.45	-10.61	-0.59	4.00	1.69	-3.47
16500	350.00	-27.27	-1.50	-11.34	-1.42	4.00	16500	350.00	-14.25	-5.13	-12.31	-11.88	4.00	-14.04	0.06	-8.79	-1.05	4.00	1.78	-3.07
18000	0.00	-18.36	-6.84	-15.68	-3.69	4.00	18000	0.00	-15.26	-11.29	-12.76	-18.03	4.00	-13.53	-5.51	-10.97	-3.53	4.00	-1.46	-6.73
18000	10.00	-16.54	-6.10	-13.89	-3.54	4.00	18000	10.00	-16.54	-14.45	-14.06	-40.00	4.00	-13.53	-5.51	-10.96	-3.54	4.00	-1.47	-6.73
18000	20.00	-15.27	-5.66	-12.64	-3.65	4.00	18000	20.00	-18.36	-19.95	-15.91	-19.52	4.00	-13.54	-5.50	-10.96	-3.54	4.00	-1.46	-6.73
18000	30.00	-14.39	-5.50	-11.78	-4.03	4.00	18000	30.00	-21.01	-41.34	-18.62	-13.22	4.00	-13.53	-5.50	-10.96	-3.54	4.00	-1.46	-6.73
18000	40.00	-13.83	-5.61	-11.24	-4.71	4.00	18000	40.00	-25.27	-21.55	-23.02	-9.79	4.00	-13.53	-5.50	-10.96	-3.54	4.00	-1.46	-6.73
18000	50.00	-13.57	-5.99	-10.99	-5.74	4.00	18000	50.00	-34.71	-15.22	-33.16	-7.53	4.00	-13.54	-5.50	-10.96	-3.53	4.00	-1.46	-6.73
18000	60.00	-13.56	-6.67	-11.01	-7.22	4.00	18000	60.00	-34.74	-11.77	-31.26	-5.96	4.00	-13.53	-5.50	-10.97	-3.53	4.00	-1.46	-6.73
18000	70.00	-13.83	-7.70	-11.29	-9.33	4.00	18000	70.00	-25.28	-9.51	-22.40	-4.86	4.00	-13.53	-5.50	-10.97	-3.53	4.00	-1.46	-6.73
18000	80.00	-14.39	-9.18	-11.86	-12.51	4.00	18000	80.00	-21.02	-7.94	-18.27	-4.13	4.00	-13.54	-5.51	-10.97	-3.54	4.00	-1.47	-6.74
18000	90.00	-15.26	-11.29	-12.76	-18.03	4.00	18000	90.00	-18.36	-6.84	-15.68	-3.69	4.00	-13.53	-5.51	-10.97	-3.53	4.00	-1.46	-6.73



Frequency: 5785MHz

Angle (θ)		Theta Polarization					Phi Polarization					Total									
		Max Gain(dB)				Nant	Max Gain(dB)				Nant	Max Gain(dB)				Max DG(dB)	Max DG(dB)				
		Ant 1(G1)	Ant 2(G2)	Ant 3(G3)	Ant 4(G4)		Ant 1(G1)	Ant 2(G2)	Ant 3(G3)	Ant 4(G4)		Ant 1(G1)	Ant 2(G2)	Ant 3(G3)	Ant 4(G4)						
		1.60	2.91	4.00	2.93		1.07	3.43	-3.76	3.38		3.08	3.52	4.34	3.60						
Ant 1(G1)	Ant 2(G2)	Ant 3(G3)	Ant 4(G4)	Ant 1(G1)	Ant 2(G2)	Ant 3(G3)	Ant 4(G4)	Ant 1(G1)	Ant 2(G2)	Ant 3(G3)	Ant 4(G4)										
0.00	0.00	-22.18	2.74	-21.34	2.84	4.00	0.00	0.00	-2.99	-11.15	-6.90	-13.61	4.00	-2.94	2.91	-6.75	2.94	4.00	5.96	0.65	
0.00	10.00	-13.99	2.91	-15.76	2.93	4.00	0.00	10.00	-3.29	-29.18	-7.33	-29.02	4.00	-2.94	2.91	-6.75	2.93	4.00	5.96	0.64	
0.00	20.00	-10.02	2.82	-12.57	2.76	4.00	0.00	20.00	-3.88	-13.62	-8.06	-11.11	4.00	-2.93	2.92	-6.74	2.93	4.00	5.97	0.65	
0.00	30.00	-7.50	2.45	-10.45	2.31	4.00	0.00	30.00	-4.81	-7.02	-9.16	-5.80	4.00	-2.94	2.91	-6.75	2.93	4.00	5.96	0.65	
0.00	40.00	-5.76	1.78	-8.97	1.56	4.00	0.00	40.00	-6.14	-3.49	-10.72	-2.71	4.00	-2.94	2.91	-6.75	2.94	4.00	5.96	0.65	
0.00	50.00	-4.54	0.77	-7.93	0.43	4.00	0.00	50.00	-8.05	-1.19	-12.96	-0.65	4.00	-2.94	2.91	-6.74	2.93	4.00	5.96	0.64	
0.00	60.00	-3.71	-0.67	-7.25	-1.17	4.00	0.00	60.00	-10.84	0.41	-16.38	0.80	4.00	-2.94	2.91	-6.75	2.94	4.00	5.96	0.65	
0.00	70.00	-3.19	-2.74	-6.86	-3.47	4.00	0.00	70.00	-15.43	1.54	-22.62	1.81	4.00	-2.94	2.92	-6.75	2.94	4.00	5.97	0.65	
0.00	80.00	-2.96	-5.83	-6.75	-7.01	4.00	0.00	80.00	-26.66	2.29	-44.48	2.47	4.00	-2.94	2.91	-6.75	2.93	4.00	5.96	0.64	
0.00	90.00	-2.99	-11.15	-6.90	-13.61	4.00	0.00	90.00	-44.81	2.74	-89.72	2.84	4.00	-2.94	2.91	-6.75	2.94	4.00	5.96	0.65	
0.00	100.00	-3.29	-29.18	-7.33	-29.02	4.00	0.00	100.00	-89.72	2.91	-173.99	2.93	4.00	-2.94	2.91	-6.75	2.93	4.00	5.96	0.64	
0.00	110.00	-3.88	-13.62	-8.06	-11.11	4.00	0.00	110.00	-136.22	2.82	-125.72	2.76	4.00	-2.93	2.92	-6.74	2.93	4.00	5.97	0.65	
0.00	120.00	-4.81	-7.02	-9.16	-5.80	4.00	0.00	120.00	-209.11	2.45	-104.52	2.31	4.00	-2.94	2.91	-6.75	2.93	4.00	5.96	0.65	
0.00	130.00	-6.14	-3.49	-10.72	-2.71	4.00	0.00	130.00	-338.47	1.78	-97.97	1.56	4.00	-2.94	2.91	-6.75	2.94	4.00	5.96	0.65	
0.00	140.00	-8.05	-1.19	-12.96	-0.65	4.00	0.00	140.00	-545.47	0.77	-79.93	0.43	4.00	-2.94	2.91	-6.74	2.93	4.00	5.96	0.64	
0.00	150.00	-10.84	0.41	-16.38	0.80	4.00	0.00	150.00	-897.22	-0.67	-72.52	-1.17	4.00	-2.94	2.91	-6.75	2.94	4.00	5.96	0.65	
0.00	160.00	-15.43	1.54	-22.62	1.81	4.00	0.00	160.00	-1414.48	-3.19	-74.74	-6.86	-3.47	4.00	-2.94	2.92	-6.75	2.94	4.00	5.97	0.65
0.00	170.00	-26.66	2.29	-44.48	2.47	4.00	0.00	170.00	-2448.11	-2.96	-5.83	-6.75	-7.01	4.00	-2.94	2.91	-6.75	2.93	4.00	5.96	0.64
0.00	180.00	-22.18	2.74	-21.34	2.84	4.00	0.00	180.00	-22.99	-11.15	-6.90	-13.61	4.00	-2.94	2.91	-6.75	2.94	4.00	5.96	0.65	
0.00	190.00	-13.99	2.91	-15.76	2.93	4.00	0.00	190.00	-3.29	-29.18	-7.33	-29.02	4.00	-2.94	2.91	-6.75	2.93	4.00	5.96	0.64	
0.00	200.00	-10.02	2.82	-12.57	2.76	4.00	0.00	200.00	-3.88	-13.62	-8.06	-11.11	4.00	-2.93	2.92	-6.74	2.93	4.00	5.97	0.65	
0.00	210.00	-7.50	2.45	-10.45	2.31	4.00	0.00	210.00	-4.81	-7.02	-9.16	-5.80	4.00	-2.94	2.91	-6.75	2.93	4.00	5.96	0.65	
0.00	220.00	-5.76	1.78	-8.97	1.56	4.00	0.00	220.00	-6.14	-3.49	-10.72	-2.71	4.00	-2.94	2.91	-6.75	2.94	4.00	5.96	0.65	
0.00	230.00	-4.54	0.77	-7.93	0.43	4.00	0.00	230.00	-8.05	-1.19	-12.96	-0.65	4.00	-2.94	2.91	-6.74	2.93	4.00	5.96	0.64	
0.00	240.00	-3.71	-0.67	-7.25	-1.17	4.00	0.00	240.00	-10.84	0.41	-16.38	0.80	4.00	-2.94	2.91	-6.75	2.94	4.00	5.96	0.65	
0.00	250.00	-3.19	-2.74	-6.86	-3.47	4.00	0.00	250.00	-15.43	1.54	-22.62	1.81	4.00	-2.94	2.92	-6.75	2.94	4.00	5.97	0.65	
0.00	260.00	-2.96	-5.83	-6.75	-7.01	4.00	0.00	260.00	-26.66	2.29	-44.48	2.47	4.00	-2.94	2.91	-6.75	2.93	4.00	5.96	0.64	
0.00	270.00	-2.99	-11.15	-6.90	-13.61	4.00	0.00	270.00	-44.81	2.74	-89.72	2.84	4.00	-2.94	2.91	-6.75	2.94	4.00	5.96	0.65	
0.00	280.00	-2.99	-29.18	-7.33	-29.02	4.00	0.00	280.00	-89.72	2.91	-173.99	2.93	4.00	-2.94	2.91	-6.75	2.93	4.00	5.96	0.64	
0.00	290.00	-3.88	-13.62	-8.06	-11.11	4.00	0.00	290.00	-136.22	2.82	-125.72	2.76	4.00	-2.93	2.92	-6.74	2.93	4.00	5.97	0.65	
0.00	300.00	-4.81	-7.02	-9.16	-5.80	4.00	0.00	300.00	-209.11	2.45	-104.52	2.31	4.00	-2.94	2.91	-6.75	2.93	4.00	5.96	0.65	
0.00	310.00	-6.14	-3.49	-10.72	-2.71	4.00	0.00	310.00	-338.47	1.78	-97.97	1.56	4.00	-2.94	2.91	-6.75	2.94	4.00	5.96	0.65	
0.00	320.00	-8.05	-1.19	-12.96	-0.65	4.00	0.00	320.00	-545.47	0.77	-79.93	0.43	4.00	-2.94	2.91	-6.74	2.93	4.00	5.96	0.64	
0.00	330.00	-10.84	0.41	-16.38	0.80	4.00	0.00	330.00	-897.22	-0.67	-72.52	-1.17	4.00	-2.94	2.91	-6.75	2.94	4.00	5.96	0.65	
0.00	340.00	-15.43	1.54	-22.62	1.81	4.00	0.00	340.00	-1414.48	-3.19	-74.74	-6.86	-3.47	4.00	-2.94	2.92	-6.75	2.94	4.00	5.97	0.65
0.00	350.00	-26.66	2.29	-44.48	2.47	4.00	0.00	350.00	-2448.11	-2.96	-5.83	-6.75	-7.01	4.00	-2.94	2.91	-6.75	2.93	4.00	5.96	0.64
15.00	0.00	-12.96	1.93	-6.93	1.51	4.00	15.00	0.00	0.06	-8.95	-6.73	-19.65	4.00	0.27	2.27	-3.82	1.54	4.00	6.38	0.60	
15.00	10.00	-13.14	2.08	-5.29	1.09	4.00	15.00	10.00	0.13	-14.07	-7.04	-14.70	4.00	0.33	2.18	-3.07	1.20	4.00	6.39	0.55	
15.00	20.00	-23.17	2.11	-5.63	-0.02	4.00	15.00	20.00	-2.99	-17.27	-10.00	-9.05	4.00	-2.95	2.16	-4.28	0.49	4.00	5.26	-0.40	
15.00	30.00	-19.09	1.91	-5.65	-1.17	4.00	15.00	30.00	-4.28	-9.49	-10.75	-5.64	4.00	-4.14	2.21	-4.48	0.16	4.00	4.93	-0.65	
15.00	40.00	-11.69	0.83	-4.79	-3.18	4.00	15.00	40.00	-4.23	-5.98	-11.29	-3.90	4.00	-3.51	1.65	-3.91	-0.51	4.00	4.75	-0.97	
15.00	50.00	-9.50	-0.15	-5.41	-4.67	4.00	15.00	50.00	-5.76	-2.51	-15.15	-2.29	4.00	-4.23	1.84	-4.97	-0.31	4.00	4.56	-1.03	
15.00	60.00	-7.18	-1.47	-5.15	-6.88	4.00	15.00	60.00	-10.87	-1.46	-17.57	-1.16	4.00	-5.63	1.55	-4.91	-0.13	4.00	4.27	-1.26	
15.00	70.00	-6.40	-3.83	-5.49	-9.99	4.00	15.00	70.00	-18.64	-0.37	-17.93	-0.58	4.00	-6.15	1.25	-5.25	0.34	4.00	4.17	-1.31	
15.00	80.00	-6.13	-7.72	-4.75	-15.31	4.00	15.00	80.00	-19.39	0.61	-17.07	0.52	4.00	-5.93	1.21	-4.50	0.63	4.00	4.42	-1.13	
15.00	90.00	-8.20	-12.78	-5.09	-19.54	4.00	15.00	90.00	-12.63	0.91	-19.04	0.67	4.00	-6.86	1.09	-4.92	0.71	4.00	4.19	-1.26	
15.00	100.00	-8.53	-25.39	-4.38	-12.39	4.00	15.00	100.00	-8.20	0.63	-21.68	0.39	4.00	-5.35	0.64	-4.30	0.61	4.00	4.35	-1.29	
15.00	110.00	-11.29	-12.49	-3.34	-7.06	4.00	15.00	110.00	-5.87	0.86	-20.96	-0.36	4.00	-4.77	1.06	-3.33	0.82	4.00	4.72	-0.98	
15.00	120.00	-16.24	-7.80	-2.74	-2.59	4.00	15.00	120.00	-4.02	0.59	-23.01	-1.53	4.00	-3.77	1.18	-2.70	0.98	4.00	5.22	-0.55	
15.00	130.00	-50.70	-4.68	-2.73	-0.80	4.00	15.00	130.00	-3.55	0.44	-15.79	-4.24	4.00	-3.55	1.58	-2.52	0.82	4.00	5.37	-0.40	
15.00	140.00	-26.37	-2.39	-3.22	0.57	4.00	15.00	140.00	-3.15	-0.33	-12.28	-6.77	4.00	-3.13	1.77	-2.71	1.31	4.00	5.62	-0.14	
15.00	150.00	-16.58	-0.56	-4.51	1.55	4.00	15.00	150.00	-3.17	-1.72	-9.92	-13.22	4.00	-2.98	1.91	-3.41	1.69	4.00	5.68	-0.01	
15.00	160.00	-11.59	0.93	-6.83	2.11	4.00	15.00	160.00	-3.41	-4.54	-8.80	-21.72	4.00	-2.80	2.01	-4.69	2.13	4.00	5.68	0.09	
15.00	170.00	-8.81	1.82	-9.10	2.43	4.00	15.00	170.00	-3.96	-8.28	-8.67	-12.40	4.00	-2.73	2.22	-5.87	2.27	4.00	5.75	0.28	
15.00	180.00	-6.93	1.98	-10.41	2.83	4.00	15.00	180.00	-4.52	-10.19	-8.03	-9.61	4.00	-2.55	2.24	-6.05	3.07	4.00	5.94	0.52	
15.00	190.00	-5.11	2.23	-11.40	2.53	4.00	15.00	190.00	-4.98	-12.00	-9.20	-5.86	4.00	-2.03	2.39	-7.15	3.12	4.00	5.97	0.61	
15.00	200.00	-4.29	1.95	-12.71	2.19	4.00	15.00	200.00	-5.08	-10.17	-9.31	-3.29	4.00	-1.66	2.21	-7.68	3.27	4.00	5.99	0.65	
15.00	210.00	-3.64	1.00	-13.60	1.86	4.00	15.00	210.00	-6.90	-10.62	-1.49	4.00	-1.96	1.72	-8.85	6.51	3.51	4.00	5.75	0.51	
15.00</																					



45.00	190.00	1.60	1.41	0.48	0.89	4.00	45.00	190.00	-5.28	-15.51	-6.60	-14.58	4.00	2.41	1.50	1.26	1.01	4.00	7.58	1.58
45.00	200.00	0.82	-3.46	-0.22	-1.33	4.00	45.00	200.00	-9.54	-10.51	-8.22	-10.42	4.00	1.20	-2.68	0.42	-0.83	4.00	5.67	-0.24
45.00	210.00	-0.09	-5.07	-2.44	-1.43	4.00	45.00	210.00	-11.18	-10.63	-9.29	-6.66	4.00	0.24	-4.00	-1.62	-0.29	4.00	4.75	-1.14
45.00	220.00	-0.68	-6.53	-3.36	-2.81	4.00	45.00	220.00	-13.07	-10.72	-10.55	-4.55	4.00	-0.44	-5.13	-2.60	-0.58	4.00	4.03	-1.81
45.00	230.00	-0.77	-13.91	-3.46	-4.26	4.00	45.00	230.00	-15.23	-14.68	-8.17	-3.47	4.00	-0.62	-11.27	-2.20	-0.84	4.00	3.20	-2.27
45.00	240.00	-1.56	-22.39	-3.45	-6.32	4.00	45.00	240.00	-21.09	-9.70	-7.94	-3.85	4.00	-1.51	-9.47	-2.13	-1.90	4.00	2.80	-2.85
45.00	250.00	-2.98	-27.23	-5.42	-7.14	4.00	45.00	250.00	-18.98	-5.73	-8.59	-3.13	4.00	-2.87	-5.70	-3.71	-1.68	4.00	2.65	-3.26
45.00	260.00	-3.61	-28.95	-6.14	-7.52	4.00	45.00	260.00	-20.92	-4.12	-12.00	-2.70	4.00	-3.53	-4.11	-5.14	-1.46	4.00	2.57	-3.34
45.00	270.00	-2.11	-19.28	-6.32	-8.53	4.00	45.00	270.00	-19.86	-3.09	-13.20	-1.22	4.00	-2.04	-2.99	-5.51	-0.48	4.00	3.45	-2.39
45.00	280.00	-0.40	-13.70	-4.29	-12.89	4.00	45.00	280.00	-13.22	-3.40	-12.34	0.16	4.00	-0.18	-3.01	-3.66	0.37	4.00	4.57	-1.28
45.00	290.00	-0.49	-9.24	-3.50	-10.72	4.00	45.00	290.00	-9.45	-2.51	-9.42	0.98	4.00	0.03	-1.57	-2.09	1.51	4.00	5.47	-0.46
45.00	300.00	-1.57	-8.08	-1.52	-10.07	4.00	45.00	300.00	-7.45	-3.03	-8.10	1.74	4.00	-0.55	-1.88	-0.76	2.02	4.00	5.83	-0.06
45.00	310.00	-0.72	-8.08	-0.73	-5.79	4.00	45.00	310.00	-7.11	-5.99	-8.86	1.79	4.00	0.18	-3.90	-0.11	2.49	4.00	5.97	0.21
45.00	320.00	-0.56	-5.11	-1.24	-4.95	4.00	45.00	320.00	-6.19	-7.43	-7.73	0.28	4.00	0.49	-3.11	-0.36	1.42	4.00	5.79	-0.09
45.00	330.00	-1.71	-4.58	-1.20	-5.74	4.00	45.00	330.00	-3.85	-7.73	-5.82	-1.98	4.00	0.36	-2.87	0.09	-0.45	4.00	5.39	-0.55
45.00	340.00	-4.53	-6.60	-0.76	-6.78	4.00	45.00	340.00	-3.73	-8.11	-5.09	-7.63	4.00	-1.10	-4.28	0.60	-1.47	4.00	4.03	-1.74
45.00	350.00	-3.71	-5.90	0.17	-8.56	4.00	45.00	350.00	-1.51	-4.11	-6.46	-28.95	4.00	0.54	-1.90	1.02	-8.52	4.00	4.52	-0.99
60.00	0.00	-2.72	-12.26	0.47	-7.42	4.00	60.00	0.00	-2.25	-8.01	-8.22	-9.59	4.00	0.53	-6.62	1.02	-5.36	4.00	4.07	-1.39
60.00	10.00	-3.08	-9.47	-0.12	-13.67	4.00	60.00	10.00	-0.59	-10.93	-11.81	-9.19	4.00	1.35	-7.13	0.16	-7.87	4.00	3.61	-1.61
60.00	20.00	-3.61	-7.40	-0.41	-13.19	4.00	60.00	20.00	-0.78	-13.75	-13.01	-4.70	4.00	1.04	-6.49	-0.18	-4.12	4.00	4.09	-1.48
60.00	30.00	-5.09	-10.77	-0.59	-13.28	4.00	60.00	30.00	-2.06	-8.53	-14.55	-3.54	4.00	-0.31	-6.50	-0.42	-3.10	4.00	3.78	-1.95
60.00	40.00	-9.63	-11.77	-1.10	-11.52	4.00	60.00	40.00	-3.20	-2.63	-17.20	-3.13	4.00	-2.31	-2.13	-0.99	-2.50	4.00	4.05	-1.95
60.00	50.00	-14.64	-14.98	-0.47	-13.53	4.00	60.00	50.00	-3.28	-1.92	-12.44	-7.77	4.00	-2.97	-1.71	-0.20	-4.23	4.00	3.87	-2.02
60.00	60.00	-13.34	-14.24	-0.59	-13.85	4.00	60.00	60.00	-4.95	-0.40	-9.68	-4.71	4.00	-4.36	-0.22	-0.09	-7.55	4.00	3.49	-2.09
60.00	70.00	-11.66	-21.77	-1.26	-14.65	4.00	60.00	70.00	-7.15	1.32	-16.30	-4.24	4.00	-5.83	-3.20	-5.20	3.20	4.00	4.08	-1.06
60.00	80.00	-10.90	-19.46	-2.18	-12.60	4.00	60.00	80.00	-11.34	1.80	-35.09	-3.50	4.00	-8.10	1.83	-6.10	-3.00	4.00	3.02	-2.17
60.00	90.00	-11.87	-17.77	-1.59	-15.37	4.00	60.00	90.00	-11.11	2.38	-14.17	-2.98	4.00	-8.46	2.42	-6.20	-2.74	4.00	3.28	-1.77
60.00	100.00	-10.33	-13.71	-1.46	-20.15	4.00	60.00	100.00	-7.44	2.64	-11.21	-2.75	4.00	-5.64	2.74	-1.02	-2.67	4.00	4.90	-0.60
60.00	110.00	-9.15	-9.41	-0.80	-10.37	4.00	60.00	110.00	-5.50	2.37	-10.18	-3.05	4.00	-3.94	2.65	-0.33	-2.31	4.00	5.39	-0.27
60.00	120.00	-7.74	-5.45	-0.20	-11.21	4.00	60.00	120.00	-4.24	1.86	-9.24	-3.82	4.00	-2.64	1.20	0.31	-3.09	4.00	5.63	-0.08
60.00	130.00	-6.96	-3.31	1.15	-18.90	4.00	60.00	130.00	-2.02	-1.20	-9.16	-3.94	4.00	-0.81	0.88	1.54	-3.80	4.00	5.70	-0.11
60.00	140.00	-4.50	-2.63	1.46	-19.59	4.00	60.00	140.00	-1.63	-5.03	-11.23	-2.89	4.00	0.18	-0.66	1.69	-2.80	4.00	5.77	-0.11
60.00	150.00	-1.83	-2.57	2.06	-8.46	4.00	60.00	150.00	-1.04	-5.38	-13.17	-4.66	4.00	1.59	-0.74	2.19	-3.15	4.00	6.24	0.44
60.00	160.00	-1.38	-1.89	2.82	-9.55	4.00	60.00	160.00	-0.57	-4.49	-9.45	-8.76	4.00	2.05	0.01	3.07	-6.13	4.00	6.42	0.86
60.00	170.00	-1.43	-1.71	3.15	-10.41	4.00	60.00	170.00	-0.67	-4.01	-9.18	-7.53	4.00	1.98	0.30	3.40	-10.22	4.00	6.62	1.06
60.00	180.00	0.22	-1.75	3.11	0.68	4.00	60.00	180.00	-1.62	-4.65	-7.52	-9.75	4.00	2.21	0.05	2.47	-0.17	4.00	7.60	1.71
60.00	190.00	0.50	-5.75	1.66	-0.56	4.00	60.00	190.00	-4.11	-17.97	-4.03	-9.97	4.00	1.79	-5.50	2.70	-0.09	4.00	6.26	0.64
60.00	200.00	0.69	-11.30	-0.42	0.08	4.00	60.00	200.00	-7.44	-18.01	-5.98	-9.98	4.00	1.31	-10.46	0.65	0.49	4.00	5.10	-0.31
60.00	210.00	-0.89	-15.02	-0.72	-0.90	4.00	60.00	210.00	-11.93	-11.94	-8.53	-3.66	4.00	-0.56	-10.93	-0.05	0.95	4.00	4.49	-0.96
60.00	220.00	-1.08	-15.41	0.14	-2.95	4.00	60.00	220.00	-19.55	-8.45	-7.58	-3.46	4.00	-1.02	-7.65	0.82	-0.19	4.00	4.56	-1.07
60.00	230.00	-3.25	-9.86	-0.65	-3.85	4.00	60.00	230.00	-11.74	-6.29	-5.16	-2.31	4.00	-2.67	-2.91	0.67	0.00	4.00	4.60	-1.19
60.00	240.00	-1.61	-11.65	-3.39	-5.62	4.00	60.00	240.00	-16.87	-5.19	-5.16	-0.87	4.00	-1.48	-4.31	-1.18	0.38	4.00	4.53	-1.34
60.00	250.00	-2.49	-16.73	-4.45	-9.58	4.00	60.00	250.00	-13.42	-4.37	-10.46	0.18	4.00	-2.15	-4.12	-3.48	0.62	4.00	3.93	-1.88
60.00	260.00	-2.60	-17.88	-3.15	-15.51	4.00	60.00	260.00	-9.89	-3.21	-20.61	1.08	4.00	-1.86	-3.06	-3.07	1.17	4.00	4.50	-1.32
60.00	270.00	-4.76	-16.90	-1.91	-30.71	4.00	60.00	270.00	-9.91	-3.00	-10.86	0.54	4.00	-3.60	-2.83	-1.39	0.54	4.00	4.35	-1.52
60.00	280.00	-8.70	-13.24	-1.66	-16.39	4.00	60.00	280.00	-13.08	-2.28	-7.11	-0.56	4.00	-7.35	-1.95	-0.57	-0.45	4.00	3.85	-1.87
60.00	290.00	-4.12	-13.59	-0.49	-14.54	4.00	60.00	290.00	-20.87	-2.02	-4.76	-2.13	4.00	-4.03	-2.73	0.89	-1.89	4.00	4.51	-1.33
60.00	300.00	-2.41	-14.56	0.93	-11.39	4.00	60.00	300.00	-23.61	-0.55	-6.08	-2.34	4.00	-2.38	-0.38	1.72	-1.83	4.00	5.45	-0.41
60.00	310.00	-3.25	-14.28	1.54	-8.04	4.00	60.00	310.00	-9.65	-1.67	-6.24	0.33	4.00	-2.35	-1.44	2.21	0.92	4.00	6.05	0.21
60.00	320.00	0.08	-11.63	-0.17	-6.24	4.00	60.00	320.00	-5.70	-7.17	-6.62	0.26	4.00	1.10	-5.84	0.72	1.14	4.00	5.74	0.03
60.00	330.00	-0.69	-8.04	-0.95	-4.00	4.00	60.00	330.00	-4.92	-8.78	-6.19	-2.70	4.00	0.70	-5.38	0.19	-0.29	4.00	5.13	-0.65
60.00	340.00	-2.27	-8.14	-0.89	-3.47	4.00	60.00	340.00	-3.98	-7.90	-5.72	-7.49	4.00	-0.03	-5.01	0.34	-2.02	4.00	4.59	-1.22
60.00	350.00	-3.17	-13.05	-0.30	-5.38	4.00	60.00	350.00	-2.98	-8.02	-6.53	-12.73	4.00	-0.06	-3.83	0.63	-4.65	4.00	3.83	-1.72
75.00	0.00	-2.55	-22.12	0.18	-12.51	4.00	75.00	0.00	-2.30	-20.56	-10.06	-18.24	4.00	0.59	-18.26	0.57	-11.48	4.00	2.03	-2.27
75.00	10.00	-2.88	-25.85	-0.31	-9.91	4.00	75.00	10.00	-1.74	-11.69	-10.10	-12.07	4.00	0.74	-11.53	0.12	-7.85	4.00	2.84	-2.13
75.00	20.00	-3.32	-16.74	-0.16	-11.17	4.00	75.00	20.00	-3.87	-13.21	-17.17	-5.94	4.00	-0.58	-11.62	-0.07	-4.80	4.00	2.81	-2.48
75.00	30.00	-3.67	-12.31	-0.71	-9.26	4.00	75.00	30.00	-3.97	-8.94	-32.36	-7.31	4.00	-0.81	-7.30	-0.71	-5.17	4.00	2.97	-2.65
75.00	40.00	-1.80	-11.39	0.22	-8.75	4.00	75.00	40.00	-3.11	-11.68	-9.85	-8.91	4.00	0.52	-8.52	-0.17	-5.82	4.00	3.31	-2.06
75.00	50.00	-2.88	-13.30	-0.45	-9.45	4.00	75.00	50.00	-4.10	-12.65	-18.75	-5.14	4.00	-0.44	-9.95	0.13	-3.77	4.00	3.32	-2.12
75.00	60.00	-6.23	-18.98	-1.85	-8.28	4.00	75.00	60.00	-6.34	-11.78	-8.07	-9.36	4.00	-3.27	-11.02	-0.92	-5.78	4.00	1.51	-3.92
75.00	70.00	-7.15	-19.31	-1.89	-15.96	4.00	75.00	70.00	-9.99	-8.54	-9.15	-4.33	4.00	-5.33	-8.19	-1.14	-4.04	4.00	1.71	-3.96
75.00</																				



105.00	100.00	-2.58	-17.83	-2.81	-16.29	4.00	105.00	100.00	-13.63	-0.47	-9.67	-5.17	4.00	-2.25	-0.39	-2.00	-4.85	4.00	3.79	-2.10	
105.00	110.00	-3.21	-14.53	-10.02	-12.68	4.00	105.00	110.00	-6.67	-2.80	-8.02	-7.76	4.00	-1.59	-2.52	-5.90	-6.55	4.00	2.14	-3.64	
105.00	120.00	-2.29	-9.72	-9.36	-8.32	4.00	105.00	120.00	-3.09	-15.28	-12.31	-7.88	4.00	0.34	-8.65	-7.58	-5.08	4.00	1.52	-3.71	
105.00	130.00	-2.67	-10.94	-3.58	-15.30	4.00	105.00	130.00	-1.22	-11.18	-29.03	-15.40	4.00	1.13	-8.05	-3.57	-12.34	4.00	1.72	-3.12	
105.00	140.00	-1.17	-17.92	-5.05	-8.91	4.00	105.00	140.00	-1.59	-9.89	-18.61	-6.54	4.00	1.64	-9.26	-4.86	-5.45	4.00	2.65	-2.49	
105.00	150.00	-2.00	-12.60	-5.22	-8.63	4.00	105.00	150.00	-1.61	-11.39	-19.08	-13.49	4.00	1.21	-8.94	-5.05	-7.40	4.00	1.91	-3.13	
105.00	160.00	-2.23	-10.24	-1.83	-10.51	4.00	105.00	160.00	-1.35	-7.65	-14.17	-12.38	4.00	1.24	-5.74	-1.58	-8.33	4.00	3.19	-2.15	
105.00	170.00	-4.21	-6.63	-0.92	-16.08	4.00	105.00	170.00	-1.63	-5.63	-18.02	-26.52	4.00	0.28	-3.09	-0.84	-15.70	4.00	2.94	-2.20	
105.00	180.00	-5.76	-6.46	0.66	-4.46	4.00	105.00	180.00	-2.85	-4.44	-16.93	-17.65	4.00	-1.06	-2.32	0.73	-4.42	4.00	4.48	-1.35	
105.00	190.00	-6.65	-9.23	0.19	-4.74	4.00	105.00	190.00	-3.45	-16.15	-7.68	-10.12	4.00	-1.75	-8.43	0.85	-3.63	4.00	3.40	-2.11	
105.00	200.00	-6.12	-16.80	-2.95	-5.74	4.00	105.00	200.00	-7.90	-15.45	-7.80	-14.36	4.00	-3.01	-13.06	-1.43	-5.18	4.00	1.21	-4.11	
105.00	210.00	-7.46	-16.00	-0.47	-6.41	4.00	105.00	210.00	-8.42	-13.01	-19.32	-38.75	4.00	-4.90	-11.06	-0.41	-6.41	4.00	1.12	-4.15	
105.00	220.00	-8.51	-31.62	-0.97	-6.17	4.00	105.00	220.00	-9.89	-24.16	-16.74	-17.44	4.00	-6.14	-23.44	-0.86	-3.93	4.00	0.44	-4.34	
105.00	230.00	-7.12	-20.66	-3.42	-13.57	4.00	105.00	230.00	-11.80	-12.87	-15.93	-1.73	4.00	-5.85	-12.20	-3.18	-1.45	4.00	1.19	-4.21	
105.00	240.00	-5.76	-12.78	-8.73	-12.69	4.00	105.00	240.00	-14.61	-10.37	-13.46	-0.51	4.00	-5.23	-8.40	-7.47	-0.25	4.00	1.30	-4.07	
105.00	250.00	-21.04	-17.93	-4.73	-10.05	4.00	105.00	250.00	-13.60	-16.69	-16.14	0.50	4.00	-12.88	-14.26	-4.43	-0.87	4.00	0.53	-3.79	
105.00	260.00	-8.10	-22.42	-2.41	-12.01	4.00	105.00	260.00	-23.34	-4.95	-18.94	0.97	4.00	-7.97	-4.87	-2.31	1.18	4.00	3.17	-2.25	
105.00	270.00	-8.74	-22.08	-2.25	-12.03	4.00	105.00	270.00	-25.90	-2.12	-10.97	0.54	4.00	-8.66	-2.08	-1.70	0.77	4.00	3.73	-1.83	
105.00	280.00	-15.97	-23.74	-3.33	-15.04	4.00	105.00	280.00	-18.42	-3.75	-9.59	-1.37	4.00	-14.01	-3.71	-2.41	-1.19	4.00	1.88	-3.47	
105.00	290.00	-12.50	-21.27	-6.81	-10.90	4.00	105.00	290.00	-16.61	-8.56	-6.76	-4.04	4.00	-11.08	-8.33	-3.77	-3.23	4.00	0.00	-5.53	
105.00	300.00	-6.93	-10.40	-6.65	-5.19	4.00	105.00	300.00	-14.47	-3.74	-5.45	-7.11	4.00	-6.23	-2.89	-3.00	-3.03	4.00	2.34	-3.59	
105.00	310.00	-8.90	-9.58	-3.96	-1.96	4.00	105.00	310.00	-17.96	-3.46	-7.58	-9.93	4.00	-8.39	-2.51	-2.39	-1.29	4.00	2.77	-2.96	
105.00	320.00	-6.46	-9.99	-5.58	-1.59	4.00	105.00	320.00	-17.68	-10.55	-11.27	-7.62	4.00	-6.14	-7.25	-4.54	-0.62	4.00	1.76	-3.85	
105.00	330.00	-8.47	-6.95	-9.62	-3.05	4.00	105.00	330.00	-11.59	-12.81	-10.31	-4.89	4.00	-6.75	-5.95	-6.94	-0.86	4.00	1.29	-4.30	
105.00	340.00	-10.84	-8.06	-8.99	-5.59	4.00	105.00	340.00	-9.81	-10.55	-12.20	-4.61	4.00	-7.28	-6.12	-7.29	-2.06	4.00	0.62	-5.09	
105.00	350.00	-14.36	-5.99	-4.74	-7.11	4.00	105.00	350.00	-17.43	-17.63	-18.96	-6.57	4.00	-12.62	-5.70	-4.58	-3.82	4.00	-0.66	-5.66	
120.00	0.00	-8.16	-6.94	-6.70	-3.40	4.00	120.00	0.00	-9.61	-15.50	-11.00	-13.69	4.00	-5.81	-6.37	-5.33	-3.01	4.00	0.99	-4.93	
120.00	10.00	-4.04	-6.38	-2.78	-3.32	4.00	120.00	10.00	-10.06	-13.54	-14.88	-7.07	4.00	-3.07	-5.62	-2.52	-1.79	4.00	2.88	-3.03	
120.00	20.00	-5.30	-4.69	-1.55	-3.17	4.00	120.00	20.00	-11.49	-13.57	-15.96	-7.58	4.00	-4.36	-4.16	-1.40	-1.83	4.00	3.19	-2.73	
120.00	30.00	-7.74	-5.75	-2.15	-9.68	4.00	120.00	30.00	-8.21	-20.18	-9.80	-1.46	4.00	-4.96	-5.60	-1.46	-0.85	4.00	3.05	-2.73	
120.00	40.00	-3.55	-9.33	-1.83	-5.88	4.00	120.00	40.00	-5.36	-10.65	-12.79	-2.48	4.00	-1.35	-6.93	-1.50	-0.85	4.00	3.68	-2.10	
120.00	50.00	-1.20	-8.51	-3.79	-10.08	4.00	120.00	50.00	-3.24	-0.72	-29.83	-3.41	4.00	0.91	-0.05	-3.78	-2.56	4.00	4.85	-0.98	
120.00	60.00	-1.31	-8.75	-10.18	-6.32	4.00	120.00	60.00	-3.60	-0.23	-15.12	-4.60	4.00	0.70	0.34	-8.97	-2.48	4.00	4.17	-1.32	
120.00	70.00	-1.29	-10.22	-8.05	-15.18	4.00	120.00	70.00	-4.86	-4.83	-12.33	-9.02	4.00	-0.29	-3.73	-6.67	-8.08	4.00	2.09	-3.32	
120.00	80.00	-1.86	-13.32	-3.49	-13.29	4.00	120.00	80.00	-7.21	-4.39	-13.72	-13.83	4.00	-0.75	-4.81	-3.43	-3.43	4.00	1.83	-3.65	
120.00	90.00	-3.31	-22.85	-2.69	-10.54	4.00	120.00	90.00	-9.42	-1.23	-16.97	-13.46	4.00	-2.14	-1.20	-2.53	-10.75	4.00	2.81	-2.88	
120.00	100.00	-3.32	-20.41	-5.52	-15.16	4.00	120.00	100.00	-9.42	-0.36	-17.07	-12.92	4.00	-2.35	-0.32	-5.23	-10.89	4.00	2.15	-3.25	
120.00	110.00	-3.15	-11.37	-14.76	-21.05	4.00	120.00	110.00	-9.61	-1.38	-14.21	-19.65	4.00	-2.27	-0.97	-11.47	-17.28	4.00	0.30	-4.31	
120.00	120.00	-3.03	-8.95	-8.81	-19.63	4.00	120.00	120.00	-6.14	-4.58	-16.30	-8.21	4.00	-1.30	-3.38	-8.10	-7.91	4.00	1.34	-4.21	
120.00	130.00	-3.06	-10.63	-4.35	-7.21	4.00	120.00	130.00	-8.18	-15.93	-26.02	-12.17	4.00	-1.90	-9.51	-4.32	-6.01	4.00	1.01	-4.63	
120.00	140.00	-3.54	-13.85	-8.38	-5.96	4.00	120.00	140.00	-10.11	-8.10	-10.07	-10.07	4.00	-2.68	-7.08	-6.13	-8.12	4.00	2.07	-3.63	
120.00	150.00	-4.78	-10.74	-7.82	-12.65	4.00	120.00	150.00	-8.35	-16.05	-12.23	-10.48	4.00	-3.20	-9.62	-6.48	-8.42	4.00	-0.56	-6.21	
120.00	160.00	-5.28	-5.77	-1.58	-7.15	4.00	120.00	160.00	-10.39	-16.72	-18.07	-13.91	4.00	-4.11	-5.43	-1.48	-6.32	4.00	1.88	-3.93	
120.00	170.00	-4.45	-7.02	-3.07	-4.69	4.00	120.00	170.00	-6.80	-12.45	-25.00	-12.02	4.00	-2.46	-5.93	-3.04	-3.95	4.00	2.27	-3.66	
120.00	180.00	-7.74	-5.88	-4.12	-3.81	4.00	120.00	180.00	-8.79	-12.67	-21.98	-12.43	4.00	-5.22	-5.05	-4.05	-12.67	4.00	1.66	-4.32	
120.00	190.00	-9.86	-2.38	-4.91	-3.52	4.00	120.00	190.00	-9.97	-18.74	-11.58	-14.29	4.00	-6.90	-2.28	-4.06	-3.17	4.00	2.08	-3.79	
120.00	200.00	-11.59	-7.32	-9.02	-4.77	4.00	120.00	200.00	-10.95	-24.08	-10.75	-9.28	4.00	-8.25	-7.23	-6.79	-1.65	4.00	0.45	-5.11	
120.00	210.00	-13.49	-11.17	-7.20	-2.30	4.00	120.00	210.00	-11.88	-11.42	-14.35	-25.70	4.00	-9.60	-8.28	-6.43	-2.28	4.00	-0.17	-5.70	
120.00	220.00	-28.80	-8.95	-4.83	-4.56	4.00	120.00	220.00	-24.41	-8.01	-12.98	-5.54	4.00	-23.06	-8.62	-4.21	-20.01	4.00	-0.68	-5.41	
120.00	230.00	-22.06	-16.53	-9.28	-9.78	4.00	120.00	230.00	-26.78	-13.78	-17.22	-2.07	4.00	-20.80	-11.93	-8.63	-1.39	4.00	-2.12	-6.31	
120.00	240.00	-20.98	-19.30	-18.23	-12.43	4.00	120.00	240.00	-14.86	-9.38	-21.97	-1.51	4.00	-13.91	-8.96	-16.70	-1.17	4.00	-2.06	-6.23	
120.00	250.00	-29.96	-18.53	-8.99	-13.48	4.00	120.00	250.00	-13.67	-20.77	-27.12	-3.78	4.00	-13.57	-16.50	-8.92	-3.34	4.00	-3.11	-7.84	
120.00	260.00	-19.48	-21.76	-4.77	-13.39	4.00	120.00	260.00	-17.83	-10.35	-14.52	-6.08	4.00	-15.57	-10.05	-17.83	-4.33	-5.34	4.00	-1.78	-7.06
120.00	270.00	-19.96	-14.73	-4.10	-11.80	4.00	120.00	270.00	-18.61	-7.56	-10.90	-7.70	4.00	-16.22	-6.80	-3.28	-6.27	4.00	-1.00	-6.29	
120.00	280.00	-21.26	-10.92	-5.62	-10.51	4.00	120.00	280.00	-12.71	-6.25	-8.56	-7.14	4.00	-12.14	-4.98	-3.84	-5.50	4.00	-0.06	-5.71	
120.00	290.00	-12.60	-11.80	-6.53	-8.82	4.00	120.00	290.00	-20.29	-3.33	-9.08	-6.23	4.00	-11.92	-2.75	-4.61	-4.32	4.00	0.74	-4.85	
120.00	300.00	-14.54	-9.60	-8.16	-12.52	4.00	120.00	300.00	-7.93	-1.32	-10.49	-9.64	4.00	-6.72	-3.10	-7.62	-6.16	-7.84	4.00	1.07	-4.41
120.00	310.00	-18.69	-7.97	-9.31	-3.49	4.00	120.00	310.00	-10.09	-3.44	-11.34	-16.76	4.00	-7.07	-10.72	-6.66	-8.27	4.00	0.58	-5.14	
120.00	320.00	-14.90	-9.27	-6.05	-6.44	4.00	120.00	320.00	-13.84	-10.53	-8.38	-16.76	4.00	-11.33	-5.59	-2.87	-11.16	4.00	0.47	-1.64	
120.00	330.00	-14.62	-3.37	-4.18	-2.04	4.00	120.00	330.00	-12.61	-10.55	-7.47	-11.67	4.00	-10.49	-						



165.00	10.00	-21.37	-1.65	-8.93	-3.35	4.00		165.00	10.00	-11.88	-3.01	-7.92	-5.05	4.00	-11.42	0.73	-5.39	-1.11	4.00	2.84	-2.36
165.00	20.00	-13.49	-1.35	-8.60	-4.41	4.00		165.00	20.00	-9.50	-0.88	-10.77	-4.19	4.00	-8.04	1.90	-6.54	-1.29	4.00	3.45	-1.75
165.00	30.00	-11.35	-2.67	-9.49	-6.27	4.00		165.00	30.00	-10.65	0.04	-15.13	-5.77	4.00	-7.98	1.90	-8.44	-3.00	4.00	2.70	-2.30
165.00	40.00	-9.68	-5.08	-11.79	-7.03	4.00		165.00	40.00	-12.97	0.26	-15.10	-8.66	4.00	-8.01	1.37	-10.13	-4.76	4.00	1.79	-3.09
165.00	50.00	-12.05	-7.91	-13.93	-9.00	4.00		165.00	50.00	-15.80	-0.42	-14.17	-11.53	4.00	-10.52	0.29	-11.04	-7.07	4.00	0.24	-4.46
165.00	60.00	-14.32	-12.51	-14.57	-10.15	4.00		165.00	60.00	-20.99	-2.49	-12.67	-16.95	4.00	-13.47	-2.08	-10.51	-9.33	4.00	-1.73	-6.62
165.00	70.00	-26.46	-16.16	-14.82	-10.26	4.00		165.00	70.00	-27.72	-4.36	-12.66	-13.92	4.00	-24.03	-4.08	-10.60	-8.71	4.00	-3.41	-8.12
165.00	80.00	-13.56	-16.24	-12.76	-10.52	4.00		165.00	80.00	-26.75	-5.30	-13.19	-8.79	4.00	-13.36	-4.96	-9.96	-6.56	4.00	-2.12	-7.65
165.00	90.00	-8.38	-13.13	-15.31	-13.39	4.00		165.00	90.00	-15.76	-4.75	-15.05	-7.15	4.00	-7.65	-4.16	-12.17	-6.22	4.00	-1.07	-6.70
165.00	100.00	-6.46	-10.47	-14.56	-20.11	4.00		165.00	100.00	-13.37	-4.83	-19.58	-8.05	4.00	-5.65	-3.78	-13.37	-7.79	4.00	-0.96	-6.46
165.00	110.00	-6.31	-8.23	-14.48	-14.96	4.00		165.00	110.00	-9.11	-6.42	-14.89	-11.62	4.00	-4.48	-4.22	-11.57	-9.07	4.00	-0.95	-6.45
165.00	120.00	-6.22	-8.29	-12.99	-10.44	4.00		165.00	120.00	-8.90	-10.93	-12.25	-16.15	4.00	-4.35	-6.40	-9.59	-9.41	4.00	-1.14	-6.88
165.00	130.00	-8.96	-10.06	-11.73	-8.72	4.00		165.00	130.00	-7.68	-17.00	-11.20	-27.77	4.00	-5.26	-9.26	-8.45	-8.67	4.00	-1.74	-7.60
165.00	140.00	-9.85	-12.12	-10.34	-8.19	4.00		165.00	140.00	-8.58	-26.46	-10.96	-14.85	4.00	-6.16	-11.96	-7.63	-7.34	4.00	-2.00	-7.81
165.00	150.00	-10.12	-7.65	-10.44	-7.20	4.00		165.00	150.00	-11.06	-14.66	-14.16	-11.29	4.00	-7.55	-6.86	-8.90	-5.77	4.00	-1.18	-7.13
165.00	160.00	-10.20	-3.34	-10.33	-5.31	4.00		165.00	160.00	-13.91	-19.33	-15.42	-10.83	4.00	-8.66	-3.23	-9.16	-4.24	4.00	0.09	-5.57
165.00	170.00	-10.14	-2.66	-9.12	-5.03	4.00		165.00	170.00	-22.39	-23.73	-22.72	-11.96	4.00	-9.89	-2.63	-8.93	-4.23	4.00	0.14	-5.40
165.00	180.00	-13.53	-3.86	-8.78	-7.71	4.00		165.00	180.00	-15.51	-16.69	-23.93	-14.20	4.00	-11.40	-3.64	-8.65	-6.83	4.00	-1.15	-6.73
165.00	190.00	-13.59	-5.60	-10.26	-12.78	4.00		165.00	190.00	-15.77	-21.71	-25.84	-15.82	4.00	-11.53	-5.49	-10.14	-11.03	4.00	-3.17	-8.79
165.00	200.00	-14.25	-5.25	-10.98	-23.01	4.00		165.00	200.00	-18.34	-19.83	-23.34	-17.22	4.00	-12.82	-5.10	-10.73	-16.20	4.00	-4.22	-9.30
165.00	210.00	-17.07	-5.78	-13.38	-16.96	4.00		165.00	210.00	-16.94	-16.02	-20.35	-14.04	4.00	-13.99	-5.39	-12.58	-12.25	4.00	-4.32	-9.55
165.00	220.00	-18.74	-6.51	-16.57	-14.18	4.00		165.00	220.00	-16.07	-14.43	-14.16	-9.68	4.00	-14.19	-5.86	-12.19	-8.36	4.00	-3.53	-9.00
165.00	230.00	-27.71	-7.75	-16.62	-14.26	4.00		165.00	230.00	-12.47	-10.50	-11.23	-9.23	4.00	-12.34	-5.90	-10.13	-8.04	4.00	-2.76	-8.47
165.00	240.00	-12.68	-10.20	-12.51	-14.81	4.00		165.00	240.00	-15.93	-8.35	-11.87	-11.11	4.00	-11.00	-6.17	-9.17	-9.57	4.00	-2.77	-8.59
165.00	250.00	-7.77	-17.20	-9.57	-18.34	4.00		165.00	250.00	-14.90	-8.50	-10.09	-14.12	4.00	-7.00	-7.95	-6.81	-12.73	4.00	-2.30	-8.09
165.00	260.00	-6.84	-27.94	-9.68	-24.38	4.00		165.00	260.00	-11.85	-10.13	-10.12	-16.01	4.00	-5.65	-10.06	-6.88	-15.42	4.00	-2.75	-8.21
165.00	270.00	-7.08	-17.90	-9.55	-19.58	4.00		165.00	270.00	-9.08	-8.47	-8.01	-17.40	4.00	-4.96	-8.00	-5.70	-15.34	4.00	-1.66	-7.12
165.00	280.00	-7.74	-17.82	-11.86	-20.41	4.00		165.00	280.00	-7.68	-5.67	-7.61	-12.36	4.00	-4.70	-5.41	-6.22	-11.73	4.00	-0.60	-6.33
165.00	290.00	-8.66	-17.38	-13.84	-11.75	4.00		165.00	290.00	-9.23	-3.90	-7.05	-8.04	4.00	-5.93	-3.71	-6.22	-6.50	4.00	0.50	-5.44
165.00	300.00	-10.24	-19.93	-15.41	-8.33	4.00		165.00	300.00	-9.28	-3.38	-8.14	-5.77	4.00	-7.01	-3.28	-7.39	-3.85	4.00	0.83	-5.01
165.00	310.00	-11.04	-18.87	-14.85	-3.62	4.00		165.00	310.00	-10.03	-4.72	-9.61	-4.31	4.00	-7.50	-4.56	-8.47	-0.94	4.00	1.17	-4.33
165.00	320.00	-12.37	-13.74	-12.76	-1.41	4.00		165.00	320.00	-9.64	-5.06	-11.86	-5.74	4.00	-7.78	-4.51	-9.28	-0.05	4.00	1.37	-3.90
165.00	330.00	-13.95	-8.34	-14.06	-0.64	4.00		165.00	330.00	-8.72	-5.72	-14.20	-9.08	4.00	-7.58	-3.83	-11.12	-0.06	4.00	1.34	-3.84
165.00	340.00	-17.90	-6.38	-14.28	-0.45	4.00		165.00	340.00	-9.67	-5.32	-14.34	-24.39	4.00	-9.06	-2.81	-11.30	-0.43	4.00	1.21	-3.91
165.00	350.00	-27.13	-3.71	-12.95	-1.78	4.00		165.00	350.00	-16.95	-5.14	-11.91	-11.64	4.00	-16.55	-1.36	-9.39	-1.35	4.00	0.82	-3.98
180.00	0.00	-18.59	-6.91	-14.34	-3.83	4.00		180.00	0.00	-14.07	-10.30	-12.47	-18.15	4.00	-12.76	-5.27	-10.29	-3.67	4.00	-1.23	-6.61
180.00	10.00	-16.46	-6.06	-12.76	-3.67	4.00		180.00	10.00	-15.16	-13.05	-13.93	-39.93	4.00	-12.75	-5.27	-10.30	-3.67	4.00	-1.23	-6.61
180.00	20.00	-14.98	-5.54	-11.65	-3.78	4.00		180.00	20.00	-16.72	-17.54	-16.02	-19.67	4.00	-12.75	-5.27	-10.30	-3.67	4.00	-1.23	-6.61
180.00	30.00	-13.94	-5.29	-10.90	-4.16	4.00		180.00	30.00	-18.96	-28.19	-19.15	-13.36	4.00	-12.75	-5.27	-10.29	-3.67	4.00	-1.22	-6.61
180.00	40.00	-13.25	-5.32	-10.46	-4.84	4.00		180.00	40.00	-22.38	-25.03	-24.57	-9.92	4.00	-12.75	-5.27	-10.30	-3.67	4.00	-1.23	-6.61
180.00	50.00	-12.87	-5.61	-10.30	-5.87	4.00		180.00	50.00	-28.60	-16.52	-44.29	-7.67	4.00	-12.76	-5.27	-10.30	-3.67	4.00	-1.23	-6.61
180.00	60.00	-12.75	-6.19	-10.40	-7.35	4.00		180.00	60.00	-50.81	-12.47	-26.55	-6.10	4.00	-12.75	-5.27	-10.30	-3.67	4.00	-1.23	-6.61
180.00	70.00	-12.91	-7.10	-10.77	-9.46	4.00		180.00	70.00	-27.36	-9.91	-20.10	-5.00	4.00	-12.75	-5.27	-10.30	-3.67	4.00	-1.23	-6.61
180.00	80.00	-13.33	-8.42	-11.45	-12.63	4.00		180.00	80.00	-21.78	-8.15	-16.62	-4.26	4.00	-12.75	-5.27	-10.29	-3.67	4.00	-1.23	-6.61
180.00	90.00	-14.07	-10.30	-12.47	-18.15	4.00		180.00	90.00	-18.59	-6.91	-14.34	-3.83	4.00	-12.76	-5.27	-10.29	-3.67	4.00	-1.23	-6.61
180.00	100.00	-15.16	-13.05	-13.93	-39.93	4.00		180.00	100.00	-16.46	-6.06	-12.76	-3.67	4.00	-12.75	-5.27	-10.30	-3.67	4.00	-1.23	-6.61
180.00	110.00	-16.72	-17.54	-16.02	-19.67	4.00		180.00	110.00	-14.98	-5.54	-11.65	-3.78	4.00	-12.75	-5.27	-10.30	-3.67	4.00	-1.23	-6.61
180.00	120.00	-18.96	-28.19	-19.15	-13.36	4.00		180.00	120.00	-13.94	-5.29	-10.90	-4.16	4.00	-12.75	-5.27	-10.29	-3.67	4.00	-1.22	-6.61
180.00	130.00	-22.38	-25.03	-24.57	-9.92	4.00		180.00	130.00	-13.25	-5.32	-10.46	-4.84	4.00	-12.75	-5.27	-10.29	-3.67	4.00	-1.23	-6.61
180.00	140.00	-28.60	-16.52	-44.29	-7.67	4.00		180.00	140.00	-12.87	-5.61	-10.30	-5.87	4.00	-12.76	-5.27	-10.30	-3.67	4.00	-1.23	-6.61
180.00	150.00	-50.81	-12.47	-26.55	-6.10	4.00		180.00	150.00	-12.91	-7.10	-10.77	-9.46	4.00	-12.75	-5.27	-10.30	-3.67	4.00	-1.23	-6.61
180.00	160.00	-27.36	-9.91	-20.10	-5.00	4.00		180.00	160.00	-12.91	-7.10	-10.77	-9.46	4.00	-12.76	-5.27	-10.29	-3.67	4.00	-1.23	-6.61
180.00	170.00	-21.78	-8.15	-16.62	-4.26	4.00		180.00	170.00	-13.33	-8.42	-11.45	-12.63	4.00	-12.75	-5.27	-10.30	-3.67	4.00	-1.23	-6.61
180.00	180.00	-18.59	-6.91	-14.34	-3.83	4.00		180.00	180.00	-14.07	-10.30	-12.47	-18.15	4.00	-12.76	-5.27	-10.29	-3.67	4.00	-1.23	-6.61
180.00	190.00	-16.46	-6.06	-12.76	-3.67	4.00		180.00	190.00	-15.16	-13.05	-13.93	-39.93	4.00	-12.75	-5.27	-10.30	-3.67	4.00	-1.23	-6.61
180.00	200.00	-14.98	-5.54	-11.65	-3.78	4.00		180.00	200.00	-16.72	-17.54	-16.02	-19.67	4.00	-12.75	-5.27	-10.30	-3.67	4.00	-1.23	-6.61
180.00	210.00	-13.94	-5.29	-10.90	-4.16	4.00		180.00	210.00	-18.96	-28.19	-19.15	-13.36	4.00	-12.75	-5.27	-10.29	-3.67	4.00	-1.22	-6.61
180.00	220.00	-13.25	-5.32	-10.46	-4.84	4.00		180.00	220.00	-22.38	-25.03	-24.57	-9.92	4.00	-12.75	-5.27	-10.29	-3.67	4.00	-1.23	-6.61
180.00	230.00	-12.																			



Frequency: 5825MHz

Theta Polarization		Max Gain(dBi)				Nant	Phi Polarization		Max Gain(dBi)				Nant	Total				Max DG(dBi)		Max DG(dBi)						
Angle (θ)	Angle (φ)	Ant 1(G1)	Ant 2(G2)	Ant 3(G3)	Ant 4(G4)		Angle (θ)	Angle (φ)	Ant 1(G1)	Ant 2(G2)	Ant 3(G3)	Ant 4(G4)		Angle (θ)	Angle (φ)	Ant 1(G1)	Ant 2(G2)	Ant 3(G3)	Ant 4(G4)	Nant	g1k	g4k	1.74	1.74		
		1.44	3.58	4.09	3.49				0.50	3.58	-4.17	3.49				2.82	3.59	4.32	3.73						g1k	g4k
		Ant 1(G1)	Ant 2(G2)	Ant 3(G3)	Ant 4(G4)				Ant 1(G1)	Ant 2(G2)	Ant 3(G3)	Ant 4(G4)				Ant 1(G1)	Ant 2(G2)	Ant 3(G3)	Ant 4(G4)							
0.00	0.00	-24.33	3.44	-18.43	3.44	4.00	0.00	0.00	-3.31	-11.30	-8.14	-14.57	4.00	-3.28	3.58	-7.75	3.51	4.00	6.24	1.11						
0.00	10.00	-14.97	3.58	-14.61	3.49	4.00	0.00	10.00	-3.58	-36.42	-8.76	-22.63	4.00	-3.28	3.58	-7.76	3.50	4.00	6.24	1.10						
0.00	20.00	-10.73	3.46	-12.16	3.28	4.00	0.00	20.00	-4.14	-11.96	-9.71	-9.57	4.00	-3.28	3.58	-7.75	3.50	4.00	6.24	1.10						
0.00	30.00	-8.09	3.06	-10.47	2.80	4.00	0.00	30.00	-5.02	-5.90	-11.08	-4.72	4.00	-3.28	3.58	-7.75	3.51	4.00	6.24	1.11						
0.00	40.00	-6.27	2.37	-9.28	1.99	4.00	0.00	40.00	-6.30	-2.54	-13.04	-1.81	4.00	-3.27	3.59	-7.75	3.50	4.00	6.24	1.11						
0.00	50.00	-5.00	1.32	-8.47	0.81	4.00	0.00	50.00	-8.12	-0.32	-15.92	0.15	4.00	-3.28	3.59	-7.75	3.50	4.00	6.24	1.11						
0.00	60.00	-4.12	-0.19	-7.98	-0.87	4.00	0.00	60.00	-10.78	1.22	-20.72	1.53	4.00	-3.27	3.58	-7.75	3.51	4.00	6.24	1.11						
0.00	70.00	-3.57	-2.34	-7.77	-3.30	4.00	0.00	70.00	-15.06	2.30	-33.42	2.49	4.00	-3.27	3.58	-7.76	3.51	4.00	6.24	1.11						
0.00	80.00	-3.31	-5.58	-7.82	-7.09	4.00	0.00	80.00	-24.61	3.02	-26.02	3.11	4.00	-3.28	3.58	-7.75	3.51	4.00	6.24	1.11						
0.00	90.00	-3.31	-11.30	-8.14	-14.57	4.00	0.00	90.00	-24.33	3.44	-18.43	3.44	4.00	-3.28	3.58	-7.75	3.51	4.00	6.24	1.11						
0.00	100.00	-3.58	-36.42	-8.76	-22.63	4.00	0.00	100.00	-14.97	3.58	-14.61	3.49	4.00	-3.28	3.58	-7.76	3.50	4.00	6.24	1.10						
0.00	110.00	-4.14	-11.96	-9.71	-9.57	4.00	0.00	110.00	-10.73	3.46	-12.16	3.28	4.00	-3.28	3.58	-7.75	3.50	4.00	6.24	1.10						
0.00	120.00	-5.02	-5.90	-11.08	-4.72	4.00	0.00	120.00	-8.09	3.06	-10.47	2.80	4.00	-3.28	3.58	-7.75	3.51	4.00	6.24	1.11						
0.00	130.00	-6.30	-2.54	-13.04	-1.81	4.00	0.00	130.00	-6.27	2.37	-9.28	1.99	4.00	-3.27	3.59	-7.75	3.50	4.00	6.24	1.11						
0.00	140.00	-8.12	-0.32	-15.92	0.15	4.00	0.00	140.00	-5.00	1.32	-8.47	0.81	4.00	-3.28	3.59	-7.75	3.50	4.00	6.24	1.11						
0.00	150.00	-10.78	1.22	-20.72	1.53	4.00	0.00	150.00	-4.12	-0.19	-7.98	-0.87	4.00	-3.27	3.58	-7.75	3.50	4.00	6.24	1.11						
0.00	160.00	-15.06	2.30	-33.42	2.49	4.00	0.00	160.00	-3.57	-2.34	-7.77	-3.30	4.00	-3.27	3.58	-7.76	3.51	4.00	6.24	1.11						
0.00	170.00	-24.61	3.02	-26.02	3.11	4.00	0.00	170.00	-3.31	-5.58	-7.82	-7.09	4.00	-3.28	3.58	-7.75	3.51	4.00	6.24	1.11						
0.00	180.00	-24.33	3.44	-18.43	3.44	4.00	0.00	180.00	-3.31	-11.30	-8.14	-14.57	4.00	-3.28	3.58	-7.75	3.51	4.00	6.24	1.11						
0.00	190.00	-14.97	3.58	-14.61	3.49	4.00	0.00	190.00	-3.58	-36.42	-8.76	-22.63	4.00	-3.28	3.58	-7.76	3.50	4.00	6.24	1.10						
0.00	200.00	-10.73	3.46	-12.16	3.28	4.00	0.00	200.00	-4.14	-11.96	-9.71	-9.57	4.00	-3.28	3.58	-7.75	3.50	4.00	6.24	1.10						
0.00	210.00	-8.09	3.06	-10.47	2.80	4.00	0.00	210.00	-5.02	-5.90	-11.08	-4.72	4.00	-3.28	3.58	-7.75	3.51	4.00	6.24	1.11						
0.00	220.00	-6.27	2.37	-9.28	1.99	4.00	0.00	220.00	-6.30	-2.54	-13.04	-1.81	4.00	-3.27	3.59	-7.75	3.50	4.00	6.24	1.11						
0.00	230.00	-5.00	1.32	-8.47	0.81	4.00	0.00	230.00	-8.12	-0.32	-15.92	0.15	4.00	-3.28	3.59	-7.75	3.50	4.00	6.24	1.11						
0.00	240.00	-4.12	-0.19	-7.98	-0.87	4.00	0.00	240.00	-10.78	1.22	-20.72	1.53	4.00	-3.27	3.58	-7.75	3.50	4.00	6.24	1.11						
0.00	250.00	-3.57	-2.34	-7.77	-3.30	4.00	0.00	250.00	-15.06	2.30	-33.42	2.49	4.00	-3.27	3.58	-7.76	3.51	4.00	6.24	1.11						
0.00	260.00	-3.31	-5.58	-7.82	-7.09	4.00	0.00	260.00	-24.61	3.02	-26.02	3.11	4.00	-3.28	3.58	-7.75	3.51	4.00	6.24	1.11						
0.00	270.00	-3.31	-11.30	-8.14	-14.57	4.00	0.00	270.00	-24.33	3.44	-18.43	3.44	4.00	-3.28	3.58	-7.75	3.51	4.00	6.24	1.11						
0.00	280.00	-3.58	-36.42	-8.76	-22.63	4.00	0.00	280.00	-14.97	3.58	-14.61	3.49	4.00	-3.28	3.58	-7.76	3.50	4.00	6.24	1.10						
0.00	290.00	-4.14	-11.96	-9.71	-9.57	4.00	0.00	290.00	-10.73	3.46	-12.16	3.28	4.00	-3.28	3.58	-7.75	3.50	4.00	6.24	1.10						
0.00	300.00	-5.02	-5.90	-11.08	-4.72	4.00	0.00	300.00	-8.09	3.06	-10.47	2.80	4.00	-3.28	3.58	-7.75	3.51	4.00	6.24	1.11						
0.00	310.00	-6.30	-2.54	-13.04	-1.81	4.00	0.00	310.00	-6.27	2.37	-9.28	1.99	4.00	-3.27	3.59	-7.75	3.50	4.00	6.24	1.11						
0.00	320.00	-8.12	-0.32	-15.92	0.15	4.00	0.00	320.00	-5.00	1.32	-8.47	0.81	4.00	-3.28	3.59	-7.75	3.50	4.00	6.24	1.11						
0.00	330.00	-10.78	1.22	-20.72	1.53	4.00	0.00	330.00	-4.12	-0.19	-7.98	-0.87	4.00	-3.27	3.58	-7.75	3.50	4.00	6.24	1.11						
0.00	340.00	-15.06	2.30	-33.42	2.49	4.00	0.00	340.00	-3.57	-2.34	-7.77	-3.30	4.00	-3.27	3.58	-7.76	3.51	4.00	6.24	1.11						
0.00	350.00	-24.61	3.02	-26.02	3.11	4.00	0.00	350.00	-3.31	-5.58	-7.82	-7.09	4.00	-3.28	3.58	-7.75	3.51	4.00	6.24	1.11						
15.00	0.00	-14.69	1.62	-5.73	1.77	4.00	15.00	0.00	-0.07	-11.35	-6.87	-18.12	4.00	0.08	1.83	-3.25	1.81	4.00	6.37	0.54						
15.00	10.00	-12.19	1.61	-5.50	1.31	4.00	15.00	10.00	-0.08	-14.21	-7.19	-12.00	4.00	0.18	1.72	-3.25	1.51	4.00	6.27	0.43						
15.00	20.00	-18.38	1.95	-5.26	0.56	4.00	15.00	20.00	-3.32	-15.56	-10.04	-7.28	4.00	-3.19	2.03	-4.01	1.22	4.00	5.43	-0.23						
15.00	30.00	-19.98	0.94	-4.92	-0.42	4.00	15.00	30.00	-5.32	-10.68	-10.24	-5.10	4.00	-5.17	1.23	-3.80	0.85	4.00	4.74	-0.88						
15.00	40.00	-11.32	0.40	-4.53	-2.51	4.00	15.00	40.00	-4.65	-6.08	-12.04	-3.53	4.00	-3.80	1.28	-3.82	0.02	4.00	4.74	-1.00						
15.00	50.00	-10.16	-0.60	-5.04	-4.54	4.00	15.00	50.00	-7.17	-3.78	-15.65	-1.71	4.00	-5.40	1.11	-4.68	0.11	4.00	4.27	-1.33						
15.00	60.00	-8.94	-1.60	-4.56	-6.64	4.00	15.00	60.00	-10.50	-1.62	-18.62	-0.93	4.00	-6.64	1.40	-4.39	0.10	4.00	4.23	-1.27						
15.00	70.00	-7.34	-3.93	-5.12	-9.70	4.00	15.00	70.00	-16.86	-0.28	-22.91	-0.22	4.00	-6.88	1.28	-5.05	0.24	4.00	4.08	-1.37						
15.00	80.00	-7.42	-7.07	-5.10	-16.05	4.00	15.00	80.00	-21.04	0.12	-26.01	0.45	4.00	-7.24	0.88	-5.06	0.55	4.00	3.98	-1.46						
15.00	90.00	-7.52	-11.55	-4.96	-24.73	4.00	15.00	90.00	-12.26	0.13	-22.21	0.78	4.00	-6.26	0.42	-4.88	0.79	4.00	4.09	-1.45						
15.00	100.00	-9.05	-20.30	-4.80	-9.93	4.00	15.00	100.00	-9.36	0.68	-25.04	0.68	4.00	-6.19	0.71	-4.76	1.04	4.00	4.30	-1.32						
15.00	110.00	-11.23	-34.91	-3.84	-5.29	4.00	15.00	110.00	-6.91	0.95	-38.35	-0.24	4.00	-5.54	0.38	-3.94	0.94	4.00	4.43	-1.21						
15.00	120.00	-15.58	-9.15	-3.41	-2.12	4.00	15.00	120.00	-4.78	0.27	-22.29	-1.98	4.00	-4.43	0.74	-3.95	0.96	4.00	4.83	-0.89						
15.00	130.00	-24.66	-4.47	-3.47	-0.32	4.00	15.00	130.00	-4.07	-0.18	-16.71	-3.80	4.00	-4.03	1.19	-3.27	1.29	4.00	5.16	-0.54						
15.00	140.00	-26.06	-2.17	-3.54	0.92	4.00	15.00	140.00	-3.23	-1.07	-13.57	-7.39	4.00	-3.21	1.43	-3.13	1.52	4.00	5.48	-0.26						
15.00	150.00	-16.48	-0.53	-4.43	1.56	4.00	15.00	150.00	-3.12	-2.10	-10.72	-14.35	4.00	-2.92	1.77	-3.51	1.67	4.00	5.62	-0.08						
15.00	160.00	-11.72	0.63	-6.50	2.33	4.00	15.00	160.00	-3.65	-5.44	-9.47	-19.84	4.00	-3.02	1.59	-4.73	2.36	4.00	5.57	0.00						
15.00	170.00	-9.33	1.77	-8.99	2.62	4.00	15.00	170.00	-4.74	-8.70	-9.78	-13.93	4.00	-3.44	2.14	-6.36	2.72	4.00	5.58	0.20						
15.00	180.00	-7.75	2.35	-10.09	2.93	4.00	15.00	180.00	-5.38	-11.80	-9.58	-9.73	4.00	-3.39	2.51	-6.82	3.16	4.00	5.82	0.53						
15.00	190.00	-5.85	2.61	-11.75	3.04	4.00	15.00	190.00	-5.01	-9.68	-11.04	-6.82	4.00	-2.40	2.86	-8.37	3.47	4.00	6.06	0.86						
15.00	200.00	-4.68	1.99	-12.38	2.92	4.00	15.00	200.00	-6.26	-8.01	-10.59	-3.98	4.00	-2.39	2.40	-8.38	3.73	4.00	6.01	0.81						
15.00	210.00	-4.41	1.28	-11.95	2.35	4.00	15.00	210.00	-7.13	-5.09	-10.84	-1.91	4.00	-2.55	2.18	-8.35	3.73									



45.00	190.00	1.44	0.94	0.98	0.50	4.00	45.00	190.00	-6.81	-17.30	-8.43	-18.44	4.00
45.00	200.00	0.95	-3.15	-0.28	-1.09	4.00	45.00	200.00	-9.90	-10.91	-9.45	-11.38	4.00
45.00	210.00	0.34	-4.40	-2.00	-2.09	4.00	45.00	210.00	-9.72	-9.37	-10.27	-6.68	4.00
45.00	220.00	-0.72	-5.18	-3.63	-3.01	4.00	45.00	220.00	-12.98	-9.79	-10.29	-5.34	4.00
45.00	230.00	-0.65	-8.57	-2.69	-5.08	4.00	45.00	230.00	-12.09	-9.69	-9.47	-4.44	4.00
45.00	240.00	-1.00	-14.78	-3.68	-7.09	4.00	45.00	240.00	-17.84	-8.42	-8.17	-4.47	4.00
45.00	250.00	-2.13	-21.77	-4.69	-6.11	4.00	45.00	250.00	-19.11	-8.60	-8.99	-4.51	4.00
45.00	260.00	-3.16	-30.82	-5.30	-7.33	4.00	45.00	260.00	-20.87	-3.21	-10.37	-3.41	4.00
45.00	270.00	-1.06	-18.47	-5.86	-8.88	4.00	45.00	270.00	-19.54	-5.36	-14.98	-1.96	4.00
45.00	280.00	-0.18	-13.48	-4.90	-12.97	4.00	45.00	280.00	-12.78	-2.46	-13.57	-0.85	4.00
45.00	290.00	-0.37	-9.31	-3.46	-11.77	4.00	45.00	290.00	-10.92	-1.76	-10.36	-0.28	4.00
45.00	300.00	-1.99	-7.94	-1.88	-10.26	4.00	45.00	300.00	-9.43	-3.05	-8.69	0.43	4.00
45.00	310.00	-0.41	-7.88	-1.08	-8.02	4.00	45.00	310.00	-7.57	-7.64	-9.93	0.74	4.00
45.00	320.00	-0.45	-5.78	-1.12	-4.20	4.00	45.00	320.00	-5.82	-6.72	-8.46	0.25	4.00
45.00	330.00	-1.67	-5.32	-1.18	-5.36	4.00	45.00	330.00	-3.77	-8.40	-6.15	-2.74	4.00
45.00	340.00	-4.20	-8.28	-0.99	-6.18	4.00	45.00	340.00	-3.85	-7.55	-5.94	-7.26	4.00
45.00	350.00	-3.59	-7.25	-0.04	-7.18	4.00	45.00	350.00	-1.77	-5.66	-7.16	-24.12	4.00
60.00	0.00	-2.98	-9.88	0.52	-8.79	4.00	60.00	0.00	-2.98	-9.33	-9.17	-9.38	4.00
60.00	10.00	-3.42	-8.18	0.21	-12.97	4.00	60.00	10.00	-1.66	-13.13	-13.45	-8.41	4.00
60.00	20.00	-4.14	-8.51	0.28	-15.32	4.00	60.00	20.00	-1.48	-14.60	-13.27	-4.60	4.00
60.00	30.00	-6.63	-10.20	-0.52	-12.77	4.00	60.00	30.00	-2.26	-8.78	-13.22	-4.50	4.00
60.00	40.00	-11.10	-13.14	-1.07	-13.81	4.00	60.00	40.00	-3.15	-3.32	-19.57	-4.05	4.00
60.00	50.00	-15.06	-13.42	-1.37	-12.70	4.00	60.00	50.00	-3.58	-2.01	-11.09	-5.24	4.00
60.00	60.00	-14.34	-13.39	-0.51	-12.51	4.00	60.00	60.00	-4.98	-0.91	-9.56	-9.34	4.00
60.00	70.00	-13.57	-16.09	-0.79	-12.03	4.00	60.00	70.00	-8.02	0.46	-15.54	-6.56	4.00
60.00	80.00	-16.09	-18.58	-1.55	-11.39	4.00	60.00	80.00	-12.50	1.44	-23.87	-4.72	4.00
60.00	90.00	-13.71	-14.67	-1.27	-18.93	4.00	60.00	90.00	-13.41	1.67	-16.03	-3.58	4.00
60.00	100.00	-13.40	-13.37	-1.00	-17.70	4.00	60.00	100.00	-8.85	2.03	-13.70	-3.23	4.00
60.00	110.00	-10.54	-9.68	-0.72	-12.87	4.00	60.00	110.00	-7.71	1.90	-12.22	-4.16	4.00
60.00	120.00	-7.53	-5.68	-0.29	-13.47	4.00	60.00	120.00	-5.06	1.07	-10.91	-4.06	4.00
60.00	130.00	-5.38	-3.67	0.86	-23.12	4.00	60.00	130.00	-2.94	-1.13	-9.89	-4.54	4.00
60.00	140.00	-4.17	-3.23	1.41	-20.77	4.00	60.00	140.00	-1.32	-5.18	-10.71	-2.32	4.00
60.00	150.00	-1.69	-3.39	2.35	-10.50	4.00	60.00	150.00	-1.44	-5.45	-10.87	-5.96	4.00
60.00	160.00	-0.96	-1.65	2.74	-14.04	4.00	60.00	160.00	-1.26	-5.59	-9.12	-7.28	4.00
60.00	170.00	-1.11	-1.38	3.19	-8.43	4.00	60.00	170.00	-1.43	-3.95	-8.95	-4.40	4.00
60.00	180.00	0.70	1.30	3.11	-0.67	4.00	60.00	180.00	-2.48	-5.06	-6.69	-11.85	4.00
60.00	190.00	0.36	-5.23	1.77	-0.47	4.00	60.00	190.00	-4.66	-18.95	-4.17	-10.63	4.00
60.00	200.00	0.16	-12.01	-0.65	-0.07	4.00	60.00	200.00	-7.76	-16.74	-6.30	-8.48	4.00
60.00	210.00	-0.38	-12.57	-1.09	-1.20	4.00	60.00	210.00	-16.54	-11.32	-10.47	-3.53	4.00
60.00	220.00	-0.86	-22.35	0.29	-2.78	4.00	60.00	220.00	-18.81	-8.78	-7.97	-3.93	4.00
60.00	230.00	-3.22	-12.71	-0.22	-12.40	4.00	60.00	230.00	-10.40	-6.79	-6.16	-3.35	4.00
60.00	240.00	-1.04	-15.34	-3.16	-5.79	4.00	60.00	240.00	-16.94	-4.68	-5.78	-1.17	4.00
60.00	250.00	-2.32	-15.97	-4.92	-9.58	4.00	60.00	250.00	-13.87	-6.30	-10.14	-0.17	4.00
60.00	260.00	-2.11	-20.06	-3.89	-18.75	4.00	60.00	260.00	-12.27	-3.27	-19.52	0.07	4.00
60.00	270.00	-2.93	-14.00	-2.22	-19.99	4.00	60.00	270.00	-9.74	-2.55	-10.85	0.24	4.00
60.00	280.00	-6.17	-11.65	-1.34	-14.22	4.00	60.00	280.00	-12.66	-2.28	-6.85	0.03	4.00
60.00	290.00	-3.33	-14.41	-0.49	-12.81	4.00	60.00	290.00	-17.26	-2.62	-5.94	-0.97	4.00
60.00	300.00	-1.40	-15.72	0.81	-12.64	4.00	60.00	300.00	-17.74	-1.76	-7.36	-2.46	4.00
60.00	310.00	-3.51	-13.74	1.68	-10.27	4.00	60.00	310.00	-9.77	-3.82	-7.87	-7.77	4.00
60.00	320.00	0.01	-10.64	0.06	-6.43	4.00	60.00	320.00	-5.67	-7.82	-8.05	0.00	4.00
60.00	330.00	-1.28	-7.81	-2.25	-3.95	4.00	60.00	330.00	-5.73	-9.42	-7.29	-2.91	4.00
60.00	340.00	-2.15	-9.25	-1.05	-4.15	4.00	60.00	340.00	-3.23	-8.03	-6.45	-6.66	4.00
60.00	350.00	-3.59	-12.97	-0.32	-5.18	4.00	60.00	350.00	-3.40	-7.54	-8.30	-11.76	4.00
75.00	0.00	-3.92	-21.34	-0.75	-12.97	4.00	75.00	0.00	-3.76	-24.39	-11.04	-23.85	4.00
75.00	10.00	-3.60	-29.98	-0.78	-10.96	4.00	75.00	10.00	-2.72	-11.39	-11.01	-12.22	4.00
75.00	20.00	-3.58	-19.24	-0.43	-12.13	4.00	75.00	20.00	-3.32	-17.50	-15.43	-7.28	4.00
75.00	30.00	-3.76	-14.34	-0.53	-7.72	4.00	75.00	30.00	-4.86	-9.19	-12.84	-9.40	4.00
75.00	40.00	-2.10	-13.13	-0.83	-7.04	4.00	75.00	40.00	-3.72	-11.26	-17.17	-11.15	4.00
75.00	50.00	-3.18	-14.05	-0.32	-12.93	4.00	75.00	50.00	-5.05	-13.48	-20.68	-6.93	4.00
75.00	60.00	-6.23	-17.93	-2.11	-8.74	4.00	75.00	60.00	-8.32	-15.51	-9.82	-8.39	4.00
75.00	70.00	-7.53	-18.37	-1.72	-14.14	4.00	75.00	70.00	-12.08	-10.42	-10.51	-4.96	4.00
75.00	80.00	-6.18	-12.06	-0.21	-11.87	4.00	75.00	80.00	-10.47	-5.04	-11.69	-1.72	4.00
75.00	90.00	-7.52	-10.17	0.6	-21.51	4.00	75.00	90.00	-12.8	-3.71	-8.08	-1.28	4.00
75.00	100.00	-6.7	-11.31	-0.04	-14.96	4.00	75.00	100.00	-5.69	-2.44	-5.31	-3.04	4.00
75.00	110.00	-5.6	-16.07	-0.90	-10.15	4.00	75.00	110.00	-3.18	-1.15	-4.35	-4.49	4.00
75.00	120.00	-5.3	-14.61	-0.74	-13.24	4.00	75.00	120.00	-0.63	-1.85	-5.30	-1.60	4.00
75.00	130.00	-2.35	-8.23	0.84	-10.26	4.00	75.00	130.00	0.18	-6.49	-6.94	-1.41	4.00
75.00	140.00	-1.00	-5.45	0.70	-16.67	4.00	75.00	140.00	0.50	-9.33	-9.68	-3.46	4.00
75.00	150.00	-1.85	-5.81	1.81	-8.35	4.00	75.00	150.00	0.32	-11.77	-10.35	-2.40	4.00
75.00	160.00	-2.34	-4.09	3.13	-4.15	4.00	75.00	160.00	-0.67	-12.48	-9.03	-6.33	4.00
75.00	170.00	-1.23	-7.81	3.78	-10.43	4.00	75.00	170.00	-1.48	-6.93	-8.97	-9.55	4.00
75.00	180.00	0.44	-8.36	4.09	-5.22	4.00	75.00	180.00	-1.48	-3.66	-8.61	-16.27	4.00
75.00	190.00	-0.77	-10.66	2.36	-8.11	4.00	75.00	190.00	-4.56	-6.97	-4.97	-13.22	4.00
75.00	200.00	0.52	-6.47	0.90	-3.86	4.00	75.00	200.00	-9.32	-13.47	-7.87	-11.72	4.00
75.00	210.00	-0.88	-12.86	1.55	-8.20	4.00	75.00	210.00	-16.68	-11.11	-12.11	-13.96	4.00
75.00	220.00	-2.36	-8.75	2.06	-13.39	4.00	75.00	220.00	-14.16	-8.66	-8.48	-6.46	4.00
75.00	230.00	-1.20	-10.46	0.46	-12.26	4.00	75.00	230.00	-8.85	-4.18	-5.18	-4.36	4.00
75.00	240.00	-1.29	-14.62	-3.55	-9.25	4.00	75.00	240.00	-10.13	-2.22	-5.47	-3.43	4.00
75.00	250.00	-3.01	-15.87	-4.11	-9.29	4.00	75.00	250.00	-8.47	-1.95	-9.33	-1.35	4.00
75.00	260.00	-1.29	-17.44	-1.86	-8.70	4.00	75.00	260.00	-9.14	-0.99	-23.82	-0.58	4.00
75.00	270.00	0.61	-20.74	-0.23	-10.28	4.00	75.00	270.00	-15.41	1.45	-12.48	-0.65	4.00
75.00	280.00	-0.67	-10.77	-0.37	-11.95	4.00	75.00	280.00	0.42	-6.80	-0.74	-4.00	4.00
75.00	290.00	-0.64	-8.30	-0.55	-13.81	4.00	75.00	290.00	-12.59	-4.32	-5.82	-2.44	4.00
75.00	300.00	-1.60	-7.11	0.31	-21.70	4.00	75.00	300.00	-9.06	-1.47	-6.52	-5.34	4.00
75.00	310.00	-1.63	-13.51	1.85	-11.31	4.00	75.00	310.00	-9.23	-1.37	-5.98	-5.48	4.00
75.00	320.00	-2.38	-23.57	1.66	-11.19	4.00	75.00	320.00	-14.67	-6.06	-8.19	-5.69	4.00
75.00	330.00	-3.22	-15.57	0.74	-16.50	4.00	75.00	330.00	-5.00	-9.40	-10.07	-8.39	4.00
75.00	340.00	-3.13	-25.86	0.27	-14.75	4.00	75.00	340.00	-5.34	-17.76	-10.95	-13.25	4.00
75.00	350.00	-4.07	-15.53	0.33	-14.11	4.00	75.00	350.00	-4.30				



105.00	100.00	-2.47	-15.63	-2.09	-16.13	4.00	105.00	100.00	-10.67	-1.40	-10.55	-6.62	4.00	-1.86	-1.24	-1.51	-6.16	4.00	3.54	-2.31
105.00	110.00	-2.49	-14.65	-8.41	-12.48	4.00	105.00	110.00	-5.71	-3.75	-9.15	-9.10	4.00	-0.80	-3.41	-5.75	-7.46	4.00	2.03	-3.63
105.00	120.00	-2.98	-11.67	-8.49	-8.23	4.00	105.00	120.00	-3.47	-16.12	-15.04	-11.79	4.00	-0.21	-10.34	-7.62	-6.64	4.00	0.68	-4.45
105.00	130.00	-1.84	-13.37	-2.81	-15.74	4.00	105.00	130.00	-1.45	-16.16	-24.24	-18.15	4.00	1.37	-11.53	-2.78	-13.77	4.00	1.46	-2.99
105.00	140.00	-1.96	-21.67	-3.74	-8.98	4.00	105.00	140.00	-1.90	-9.40	-22.64	-7.11	4.00	1.08	-9.52	-3.68	-4.93	4.00	2.57	-2.71
105.00	150.00	-2.34	-13.70	-3.63	-9.43	4.00	105.00	150.00	-1.70	-9.40	-37.97	-10.87	4.00	1.00	-8.03	-3.63	-7.08	4.00	2.35	-2.91
105.00	160.00	-3.94	-10.63	-1.10	-12.42	4.00	105.00	160.00	-1.66	-9.52	-15.88	-16.44	4.00	0.36	-7.03	-0.96	-9.52	4.00	2.50	-2.66
105.00	170.00	-5.04	-7.07	-1.37	-13.39	4.00	105.00	170.00	-2.28	-6.44	-18.77	-18.34	4.00	-0.43	-3.73	-1.29	-12.18	4.00	2.64	-2.73
105.00	180.00	-5.26	-7.03	0.10	-4.91	4.00	105.00	180.00	-3.51	-5.51	-18.60	-18.57	4.00	-1.29	-3.19	0.16	-4.73	4.00	3.95	-1.88
105.00	190.00	-6.15	-11.25	-0.22	-5.70	4.00	105.00	190.00	-3.86	-21.64	-7.55	-10.30	4.00	-1.85	-10.87	0.52	-4.41	4.00	2.79	-2.55
105.00	200.00	-8.63	-16.07	-2.21	-8.67	4.00	105.00	200.00	-8.87	-13.40	-8.23	-14.61	4.00	-4.47	-11.52	-1.24	-5.14	4.00	1.88	-4.30
105.00	210.00	-6.43	-16.07	-0.12	-5.12	4.00	105.00	210.00	-6.86	-9.89	-21.25	-25.59	4.00	-5.64	-9.85	-0.09	-5.08	4.00	1.68	-3.74
105.00	220.00	-7.40	-26.92	-1.30	-7.22	4.00	105.00	220.00	-10.39	-24.09	-19.52	-7.92	4.00	-5.63	-22.27	-1.24	-4.60	4.00	0.24	-4.63
105.00	230.00	-6.85	-18.55	-4.57	-16.61	4.00	105.00	230.00	-12.48	-12.15	-14.57	-2.68	4.00	-5.80	-11.25	-4.16	-2.51	4.00	0.65	-4.94
105.00	240.00	-6.96	-9.90	-9.60	-11.03	4.00	105.00	240.00	-14.68	-11.09	-11.71	-1.24	4.00	-6.28	-7.44	-7.52	-0.81	4.00	0.99	-4.49
105.00	250.00	-19.84	-21.00	-5.56	-9.81	4.00	105.00	250.00	-13.61	-15.84	-16.88	-0.67	4.00	-12.68	-14.68	-5.25	-10.17	4.00	-0.25	-4.72
105.00	260.00	-6.89	-23.47	-2.24	-11.07	4.00	105.00	260.00	-17.90	-5.06	-21.82	0.15	4.00	-6.56	-5.00	-2.19	-0.47	4.00	3.12	-2.49
105.00	270.00	-7.64	-34.59	-1.66	-13.46	4.00	105.00	270.00	-19.96	-2.73	-11.60	0.07	4.00	-7.39	-2.73	-1.24	0.26	4.00	3.68	-1.99
105.00	280.00	-14.24	-35.29	-2.61	-15.18	4.00	105.00	280.00	-21.86	-4.47	-9.95	-3.70	4.00	-13.55	-4.47	-1.87	-1.51	4.00	1.78	-3.57
105.00	290.00	-11.89	-18.77	-6.15	-10.98	4.00	105.00	290.00	-22.83	-8.65	-6.33	-3.44	4.00	-11.55	-8.25	-3.23	-8.65	4.00	0.30	-5.13
105.00	300.00	-6.23	-9.88	-6.96	-5.76	4.00	105.00	300.00	-22.32	-3.63	-5.09	-5.84	4.00	-6.12	-2.71	-2.91	-2.79	4.00	2.50	-3.43
105.00	310.00	-8.88	-10.68	-4.41	-2.19	4.00	105.00	310.00	-35.73	-4.29	-7.22	-2.19	4.00	-8.87	-3.09	-2.58	-1.08	4.00	2.49	-3.19
105.00	320.00	-5.67	-7.84	-6.78	-1.44	4.00	105.00	320.00	-17.73	-10.66	-10.26	-7.38	4.00	-5.41	-6.01	-5.17	-0.45	4.00	2.07	-3.61
105.00	330.00	-8.01	-5.50	-8.92	-3.57	4.00	105.00	330.00	-9.99	-15.12	-11.22	-6.17	4.00	-5.88	-5.05	-6.91	-1.67	4.00	1.38	-4.39
105.00	340.00	-11.37	-9.96	-10.48	-5.67	4.00	105.00	340.00	-11.89	-11.67	-11.36	-4.19	4.00	-8.61	-6.72	-7.89	-1.86	4.00	-0.03	-5.52
105.00	350.00	-15.23	-7.13	-4.20	-6.14	4.00	105.00	350.00	-16.32	-17.08	-19.68	-7.43	4.00	-12.73	-7.71	-4.08	-3.73	4.00	-0.14	-5.68
120.00	0.00	-6.73	-7.04	-5.30	-3.52	4.00	120.00	0.00	-7.93	-16.18	-12.91	-13.89	4.00	-4.28	-6.54	-4.61	-3.14	4.00	1.46	-4.48
120.00	10.00	-4.67	-8.86	-1.86	-3.91	4.00	120.00	10.00	-9.45	-15.42	-16.13	-7.51	4.00	-3.42	-7.99	-1.70	-2.34	4.00	2.47	-3.29
120.00	20.00	-4.86	-4.89	-2.06	-3.47	4.00	120.00	20.00	-9.24	-14.12	-16.92	-8.67	4.00	-3.51	-4.40	-1.92	-2.32	4.00	3.04	-2.93
120.00	30.00	-7.58	-6.27	-3.53	-7.72	4.00	120.00	30.00	-8.04	-21.04	-9.39	-2.02	4.00	-4.79	-6.13	-2.53	-0.98	4.00	2.64	-3.16
120.00	40.00	-4.03	-9.48	-3.01	-6.95	4.00	120.00	40.00	-5.60	-10.64	-12.88	-2.91	4.00	-1.73	-7.01	-2.58	-1.47	4.00	3.08	-2.73
120.00	50.00	-0.76	-7.61	-4.66	-10.46	4.00	120.00	50.00	-3.47	-8.62	-26.27	-4.64	4.00	1.10	0.01	-4.63	-3.63	4.00	4.56	-1.15
120.00	60.00	-0.81	-7.77	-10.20	-16.16	4.00	120.00	60.00	-4.05	-0.27	-12.77	-5.34	4.00	0.88	0.06	-9.50	-2.72	4.00	4.03	-1.42
120.00	70.00	-1.62	-9.20	-7.84	-16.33	4.00	120.00	70.00	-6.22	-6.15	-12.44	-9.71	4.00	-1.33	-4.40	-6.55	-8.85	4.00	1.57	-3.87
120.00	80.00	-2.05	-11.96	-3.88	-13.75	4.00	120.00	80.00	-8.22	-6.14	-11.96	-20.53	4.00	-1.22	-5.13	-3.18	-1.32	4.00	1.35	-4.00
120.00	90.00	-2.45	-20.25	-3.84	-13.62	4.00	120.00	90.00	-9.13	-1.96	-1.65	-14.10	4.00	-1.61	-1.30	-1.91	-10.84	4.00	2.33	-3.23
120.00	100.00	-2.42	-18.28	-5.49	-13.62	4.00	120.00	100.00	-9.91	-0.48	-15.46	-14.61	4.00	-1.71	-4.01	-5.07	-11.03	4.00	2.33	-3.06
120.00	110.00	-2.97	-11.91	-12.96	-29.53	4.00	120.00	110.00	-8.31	-1.70	-12.29	-20.62	4.00	-1.86	-1.30	-9.60	-20.09	4.00	0.42	-4.22
120.00	120.00	-3.09	-8.53	-9.24	-20.04	4.00	120.00	120.00	-5.76	-6.38	-12.06	-8.19	4.00	-1.21	-4.31	-7.41	-7.92	4.00	1.24	-4.35
120.00	130.00	-2.80	-11.79	-5.09	-8.48	4.00	120.00	130.00	-7.82	-12.40	-30.36	-11.19	4.00	-1.61	-9.07	-5.08	-6.62	4.00	0.85	-4.74
120.00	140.00	-3.63	-14.02	-8.46	-6.83	4.00	120.00	140.00	-9.23	-2.40	-10.73	-3.55	4.00	-2.57	-8.23	-6.44	-6.56	4.00	1.63	-4.04
120.00	150.00	-5.44	-10.86	-9.83	-11.41	4.00	120.00	150.00	-7.00	-16.12	-11.46	-8.62	4.00	-3.14	-9.73	-7.56	-6.78	4.00	-0.45	-6.12
120.00	160.00	-4.82	-5.99	-2.47	-7.47	4.00	120.00	160.00	-10.87	-17.81	-15.55	-10.83	4.00	-3.86	-5.71	-2.26	-5.82	4.00	1.73	-4.16
120.00	170.00	-6.04	-6.41	-4.12	-4.40	4.00	120.00	170.00	-6.84	-16.13	-20.80	-11.34	4.00	-3.41	-5.97	-4.03	-3.60	4.00	1.83	-4.14
120.00	180.00	-7.83	-6.10	-4.72	-3.64	4.00	120.00	180.00	-10.96	-12.77	-16.68	-15.89	4.00	-6.11	-5.25	-4.45	-3.38	4.00	1.28	-4.68
120.00	190.00	-10.24	-3.21	-5.12	-2.82	4.00	120.00	190.00	-12.44	-16.40	-9.77	-10.90	4.00	-8.19	-3.01	-3.84	-2.56	4.00	1.88	-3.93
120.00	200.00	-12.55	-6.17	-8.41	-1.60	4.00	120.00	200.00	-11.55	-18.34	-10.50	-14.02	4.00	-9.01	-5.91	-6.32	-1.02	4.00	0.96	-4.54
120.00	210.00	-15.03	-9.41	-7.75	-2.72	4.00	120.00	210.00	-12.51	-10.58	-15.65	-25.03	4.00	-10.58	-6.95	-7.10	-2.69	4.00	-0.35	-5.92
120.00	220.00	-18.09	-8.90	-5.39	-5.00	4.00	120.00	220.00	-23.16	-18.22	-15.42	-6.69	4.00	-16.91	-8.42	-4.98	-2.75	4.00	-0.85	-5.97
120.00	230.00	-25.56	-17.26	-10.58	-12.72	4.00	120.00	230.00	-18.09	-12.08	-15.82	-2.96	4.00	-17.37	-10.93	-9.44	-2.52	4.00	-2.47	-7.14
120.00	240.00	-21.28	-20.18	-18.50	-11.43	4.00	120.00	240.00	-15.69	-10.40	-27.18	-2.23	4.00	-14.63	-9.97	-17.95	-1.74	4.00	-2.80	-6.87
120.00	250.00	-35.80	-18.66	-9.02	-12.61	4.00	120.00	250.00	-16.64	-22.74	-19.41	-3.38	4.00	-16.59	-17.23	-8.64	-4.63	4.00	-4.13	-8.84
120.00	260.00	-25.02	-18.79	-4.46	-13.72	4.00	120.00	260.00	-19.55	-11.85	-15.32	-5.90	4.00	-18.47	-11.05	-4.12	-6.89	4.00	-2.65	-7.66
120.00	270.00	-19.95	-13.72	-3.41	-13.07	4.00	120.00	270.00	-27.36	-7.23	-11.22	-6.85	4.00	-19.23	-6.35	-2.74	-5.92	4.00	-0.79	-5.89
120.00	280.00	-21.39	-10.26	-4.64	-12.20	4.00	120.00	280.00	-15.71	-5.44	-8.93	-6.93	4.00	-14.67	-4.20	-3.27	-5.80	4.00	0.00	-5.42
120.00	290.00	-12.56	-11.85	-7.67	-10.15	4.00	120.00	290.00	-24.49	-3.63	-8.56	-5.59	4.00	-12.29	-3.02	-5.08	-4.26	4.00	0.50	-5.08
120.00	300.00	-12.25	-10.92	-8.97	-15.07	4.00	120.00	300.00	-8.40	-2.25	-11.41	-7.52	4.00	-6.83	-1.70	-7.01	-6.63	4.00	0.75	-4.91
120.00	310.00	-21.64	-9.99	-7.04	-9.61	4.00	120.00	310.00	-4.04	-4.34	-13.11	-12.86	4.00	-8.09	-3.29	-6.06	-7.93	4.00	-0.27	-6.00
120.00	320.00	-11.93	-8.05	-4.64	-5.19	4.00	120.00	320.00	-12.93	-9.81	-8.50	-17.03	4.00	-9.38	-5.83	-3.81	-3.01	4.00	0.48	-6.98
120.00	330.00	-13.65	-3.87	-4.47	-1.65	4.00	120.00	330.00	-12.54	-9.16	-7.12	-15.87	4.00	-10.05	-2.74	-2.59	-1.49			



165.00	10.00	-27.09	-3.46	-9.23	-4.00	4.00			165.00	10.00	-12.47	-3.58	-9.91	-5.31	4.00			-12.32	-0.51	-6.55	-1.60	4.00	1.90	-3.32
165.00	20.00	-11.58	-3.11	-8.50	-5.11	4.00			165.00	20.00	-9.62	-1.90	-10.53	-4.80	4.00			-7.48	0.55	-6.39	-1.94	4.00	2.82	-2.63
165.00	30.00	-8.46	-3.21	-8.95	-6.00	4.00			165.00	30.00	-9.26	-0.79	-14.64	-5.66	4.00			-5.83	1.18	-7.91	-2.82	4.00	2.86	-2.49
165.00	40.00	-7.98	-5.20	-12.39	-7.16	4.00			165.00	40.00	-11.90	-0.07	-15.60	-8.89	4.00			-6.50	1.09	-10.69	-4.93	4.00	1.82	-3.20
165.00	50.00	-11.59	-6.52	-17.96	-8.90	4.00			165.00	50.00	-13.10	-0.46	-16.09	-11.57	4.00			-9.27	0.50	-13.91	-7.02	4.00	0.22	-4.32
165.00	60.00	-17.18	-11.03	-17.06	-12.51	4.00			165.00	60.00	-20.88	-2.36	-15.89	-15.83	4.00			-15.64	-1.81	-13.43	-10.85	4.00	-2.63	-6.91
165.00	70.00	-21.29	-14.16	-16.03	-11.41	4.00			165.00	70.00	-23.63	-3.57	-17.80	-15.68	4.00			-19.29	-3.21	-13.82	-10.03	4.00	-3.62	-8.02
165.00	80.00	-10.71	-21.69	-17.94	-10.91	4.00			165.00	80.00	-23.68	-4.83	-14.25	-10.70	4.00			-10.50	-4.74	-12.70	-7.79	4.00	-2.40	-7.93
165.00	90.00	-6.47	-16.21	-16.22	-14.37	4.00			165.00	90.00	-16.12	-4.38	-16.46	-7.78	4.00			-6.02	-4.10	-13.33	-6.92	4.00	-0.96	-6.53
165.00	100.00	-5.47	-10.87	-16.85	-23.01	4.00			165.00	100.00	-13.02	-5.24	-16.59	-8.61	4.00			-4.77	-4.19	-13.71	-8.46	4.00	-1.02	-6.48
165.00	110.00	-4.17	-10.45	-14.70	-15.76	4.00			165.00	110.00	-10.18	-7.61	-15.48	-12.40	4.00			-3.20	-5.79	-12.06	-10.75	4.00	-1.19	-6.53
165.00	120.00	-5.55	-9.72	-12.48	-10.48	4.00			165.00	120.00	-8.80	-1.85	-11.82	-15.45	4.00			-3.87	-7.65	-9.13	-9.28	4.00	-1.17	-6.87
165.00	130.00	-7.67	-10.66	-11.86	-8.51	4.00			165.00	130.00	-7.40	-24.98	-11.89	-20.25	4.00			-4.52	-10.50	-8.86	-8.23	4.00	-1.72	-7.43
165.00	140.00	-9.19	-10.33	-12.42	-7.63	4.00			165.00	140.00	-8.74	-24.68	-11.67	-13.95	4.00			-5.95	-10.17	-9.02	-6.72	4.00	-1.78	-7.64
165.00	150.00	-9.99	-8.08	-9.93	-7.91	4.00			165.00	150.00	-12.30	-17.04	-13.52	-10.98	4.00			-7.98	-7.56	-8.35	-6.17	4.00	-1.46	-7.43
165.00	160.00	-8.64	-3.72	-9.01	-6.94	4.00			165.00	160.00	-19.78	-18.92	-13.73	-9.60	4.00			-8.32	-3.59	-7.75	-5.06	4.00	0.06	-5.75
165.00	170.00	-9.10	-3.47	-9.37	-5.56	4.00			165.00	170.00	-21.12	-28.45	-19.73	-11.61	4.00			-8.84	-3.46	-8.99	-4.60	4.00	-0.10	-5.79
165.00	180.00	-12.82	-4.71	-8.94	-7.20	4.00			165.00	180.00	-14.19	-16.18	-25.32	-13.05	4.00			-10.44	-4.41	-8.84	-6.20	4.00	-1.14	-6.87
165.00	190.00	-14.57	-5.45	-9.90	-13.37	4.00			165.00	190.00	-14.97	-17.94	-33.51	-16.18	4.00			-11.76	-5.21	-9.88	-11.54	4.00	-3.14	-8.69
165.00	200.00	-15.12	-5.16	-11.58	-23.67	4.00			165.00	200.00	-18.17	-22.27	-19.71	-17.95	4.00			-13.37	-5.08	-10.96	-16.92	4.00	-4.45	-9.42
165.00	210.00	-14.79	-6.27	-13.35	-15.28	4.00			165.00	210.00	-20.00	-20.29	-19.06	-15.71	4.00			-13.65	-6.10	-12.32	-12.48	4.00	-4.56	-9.96
165.00	220.00	-21.34	-7.03	-14.30	-14.31	4.00			165.00	220.00	-15.94	-15.89	-13.78	-11.75	4.00			-14.84	-6.50	-11.02	-9.83	4.00	-4.03	-9.59
165.00	230.00	-22.24	-7.58	-15.08	-15.51	4.00			165.00	230.00	-13.85	-10.73	-12.46	-11.24	4.00			-13.26	-5.87	-10.57	-9.86	4.00	-3.45	-9.05
165.00	240.00	-12.44	-10.30	-13.02	-15.88	4.00			165.00	240.00	-13.40	-9.92	-13.92	-15.17	4.00			-9.88	-7.10	-10.44	-12.50	4.00	-3.74	-9.54
165.00	250.00	-7.58	-20.75	-12.49	-18.64	4.00			165.00	250.00	-12.51	-11.28	-11.14	-16.63	4.00			-6.37	-10.82	-8.75	-14.51	4.00	-3.60	-9.19
165.00	260.00	-6.57	-29.83	-10.82	-22.95	4.00			165.00	260.00	-11.98	-11.44	-9.97	-12.35	4.00			-5.47	-11.38	-7.36	-11.99	4.00	-2.60	-8.22
165.00	270.00	-6.46	-16.85	-11.05	-22.67	4.00			165.00	270.00	-9.07	-8.53	-9.27	-11.03	4.00			-4.56	-7.93	-7.06	-10.74	4.00	-1.28	-7.03
165.00	280.00	-8.10	-16.88	-14.41	-17.37	4.00			165.00	280.00	-9.12	-4.45	-9.00	-9.13	4.00			-5.57	-4.21	-7.90	-8.52	4.00	-0.35	-6.20
165.00	290.00	-9.41	-19.22	-16.43	-11.19	4.00			165.00	290.00	-9.88	-3.22	-7.37	-7.32	4.00			-6.63	-3.11	-6.86	-5.83	4.00	0.55	-5.33
165.00	300.00	-10.36	-14.43	-15.44	-8.05	4.00			165.00	300.00	-10.55	-2.88	-8.83	-5.07	4.00			-7.44	-2.59	-7.97	-4.30	4.00	1.02	-4.69
165.00	310.00	-10.17	-15.83	-13.62	-4.23	4.00			165.00	310.00	-10.10	-4.31	-10.40	-4.37	4.00			-7.12	-4.01	-8.71	-1.29	4.00	1.21	-4.35
165.00	320.00	-13.11	-15.34	-13.75	-1.69	4.00			165.00	320.00	-9.22	-6.18	-13.76	-4.99	4.00			-7.73	-5.68	-10.74	-0.02	4.00	0.90	-4.21
165.00	330.00	-17.70	-11.13	-12.76	-0.56	4.00			165.00	330.00	-9.31	-6.63	-13.86	-6.98	4.00			-8.72	-5.31	-10.26	0.33	4.00	1.04	-3.97
165.00	340.00	-18.40	-7.15	-13.25	-0.53	4.00			165.00	340.00	-8.37	-6.32	-13.62	-18.25	4.00			-7.96	-3.70	-10.42	-0.46	4.00	1.22	-4.04
165.00	350.00	-20.42	-4.21	-13.06	-1.42	4.00			165.00	350.00	-11.51	-6.19	-12.29	-14.15	4.00			-10.98	-2.08	-9.65	-1.19	4.00	1.10	-4.07
180.00	0.00	-20.72	-4.60	-13.81	-3.22	4.00			180.00	0.00	-13.88	-12.26	-11.97	-16.88	4.00			-13.06	-3.91	-9.78	-3.04	4.00	-0.50	-5.78
180.00	10.00	-18.01	-4.12	-12.23	-3.04	4.00			180.00	10.00	-14.74	-17.21	-13.44	-33.49	4.00			-13.06	-3.91	-9.78	-3.04	4.00	-0.50	-5.78
180.00	20.00	-16.16	-3.92	-11.13	-3.12	4.00			180.00	20.00	-15.99	-31.16	-15.54	-19.87	4.00			-13.06	-3.91	-9.79	-3.03	4.00	-0.49	-5.77
180.00	30.00	-14.85	-3.98	-10.38	-3.48	4.00			180.00	30.00	-17.78	-21.58	-18.69	-13.10	4.00			-13.06	-3.91	-9.78	-3.03	4.00	-0.49	-5.77
180.00	40.00	-13.96	-4.32	-9.95	-5.14	4.00			180.00	40.00	-20.37	-14.34	-24.15	-9.52	4.00			-13.07	-3.91	-9.79	-3.03	4.00	-0.50	-5.78
180.00	50.00	-13.39	-4.95	-9.79	-5.14	4.00			180.00	50.00	-24.51	-10.62	-44.73	-7.19	4.00			-13.06	-3.91	-9.78	-3.03	4.00	-0.49	-5.77
180.00	60.00	-13.10	-5.92	-9.89	-6.57	4.00			180.00	60.00	-33.38	-8.22	-25.92	-5.57	4.00			-13.06	-3.91	-9.78	-3.03	4.00	-0.49	-5.77
180.00	70.00	-13.09	-7.32	-10.27	-8.62	4.00			180.00	70.00	-35.24	-6.55	-19.54	-4.44	4.00			-13.06	-3.91	-9.78	-3.04	4.00	-0.50	-5.77
180.00	80.00	-13.34	-9.31	-10.95	-11.67	4.00			180.00	80.00	-25.11	-5.39	-16.08	-3.67	4.00			-13.06	-3.91	-9.79	-3.03	4.00	-0.50	-5.77
180.00	90.00	-13.88	-12.26	-11.97	-16.88	4.00			180.00	90.00	-20.72	-4.60	-13.81	-3.22	4.00			-13.06	-3.91	-9.78	-3.04	4.00	-0.50	-5.78
180.00	100.00	-14.74	-17.21	-13.44	-33.49	4.00			180.00	100.00	-18.01	-4.12	-12.23	-3.04	4.00			-13.06	-3.91	-9.78	-3.04	4.00	-0.50	-5.78
180.00	110.00	-15.99	-31.16	-15.54	-19.87	4.00			180.00	110.00	-16.16	-3.92	-11.13	-3.12	4.00			-13.06	-3.91	-9.79	-3.03	4.00	-0.49	-5.77
180.00	120.00	-17.78	-21.58	-18.69	-13.10	4.00			180.00	120.00	-14.85	-3.98	-10.38	-3.48	4.00			-13.06	-3.91	-9.78	-3.03	4.00	-0.49	-5.77
180.00	130.00	-20.37	-14.34	-24.15	-9.52	4.00			180.00	130.00	-13.96	-4.32	-9.95	-4.14	4.00			-13.07	-3.91	-9.79	-3.03	4.00	-0.50	-5.78
180.00	140.00	-24.51	-10.62	-44.73	-7.19	4.00			180.00	140.00	-13.39	-4.95	-9.79	-5.14	4.00			-13.07	-3.91	-9.79	-3.03	4.00	-0.50	-5.78
180.00	150.00	-33.38	-8.22	-25.92	-5.57	4.00			180.00	150.00	-13.10	-5.92	-9.89	-6.57	4.00			-13.06	-3.91	-9.78	-3.03	4.00	-0.49	-5.77
180.00	160.00	-35.24	-6.55	-19.54	-4.44	4.00			180.00	160.00	-13.09	-7.32	-10.27	-8.62	4.00			-13.06	-3.91	-9.78	-3.04	4.00	-0.50	-5.77
180.00	170.00	-25.11	-5.39	-16.08	-3.67	4.00			180.00	170.00	-13.34	-9.31	-10.95	-11.67	4.00			-13.06	-3.91	-9.79	-3.03	4.00	-0.50	-5.77
180.00	180.00	-20.72	-4.60	-13.81	-3.22	4.00			180.00	180.00	-13.88	-12.26	-11.97	-16.88	4.00			-13.06	-3.91	-9.78	-3.04	4.00	-0.50	-5.78
180.00	190.00	-18.01	-4.12	-12.23	-3.04	4.00			180.00	190.00	-14.74	-17.21	-13.44	-33.49	4.00			-13.06	-3.91	-9.78	-3.04	4.00	-0.50	-5.78
180.00	200.00	-16.16																						



Frequency: 5955MHz

Theta Polarization		Max Gain(dBi)				Nant	Phi Polarization		Max Gain(dBi)				Nant	Total				Max DG(dBi)		Max DG(dBi)						
Angle (θ)	Angle (φ)	Ant 1(G1)	Ant 2(G2)	Ant 3(G3)	Ant 4(G4)		Angle (θ)	Angle (φ)	Ant 1(G1)	Ant 2(G2)	Ant 3(G3)	Ant 4(G4)		Ant 1(G1)	Ant 2(G2)	Ant 3(G3)	Ant 4(G4)	Nant	7.21	1.34	g1k	g4k				
		1.10	4.15	3.71	3.78				-0.13	4.15	-4.59	3.63											2.94	4.15	3.99	3.84
		Ant 1(G1)	Ant 2(G2)	Ant 3(G3)	Ant 4(G4)				Ant 1(G1)	Ant 2(G2)	Ant 3(G3)	Ant 4(G4)											Ant 1(G1)	Ant 2(G2)	Ant 3(G3)	Ant 4(G4)
0.00	0.00	-18.40	4.02	-15.48	3.61	4.00	0.00	0.00	-5.92	-11.29	-10.97	-16.47	4.00	-5.68	4.15	-9.65	3.65	4.00	5.98	1.22						
0.00	10.00	-13.71	4.15	-13.35	3.63	4.00	0.00	10.00	-6.42	-35.85	-12.06	-18.75	4.00	-5.68	4.15	-9.65	3.66	4.00	5.99	1.22						
0.00	20.00	-10.87	4.01	-11.87	3.38	4.00	0.00	20.00	-7.25	-10.83	-13.63	-8.46	4.00	-5.68	4.15	-9.65	3.66	4.00	5.99	1.22						
0.00	30.00	-8.94	3.59	-10.83	2.85	4.00	0.00	30.00	-8.45	-5.06	-15.87	-4.04	4.00	-5.68	4.15	-9.65	3.66	4.00	5.99	1.22						
0.00	40.00	-7.59	2.88	-10.15	1.99	4.00	0.00	40.00	-10.17	-1.80	-19.29	-1.32	4.00	-5.68	4.15	-9.65	3.65	4.00	5.99	1.22						
0.00	50.00	-6.65	1.80	-9.76	0.74	4.00	0.00	50.00	-12.65	0.36	-25.53	0.54	4.00	-5.68	4.15	-9.65	3.65	4.00	5.99	1.22						
0.00	60.00	-6.05	0.26	-9.65	-1.03	4.00	0.00	60.00	-16.55	1.87	-47.29	1.85	4.00	-5.68	4.15	-9.65	3.65	4.00	5.99	1.22						
0.00	70.00	-5.74	-1.94	-9.80	-3.62	4.00	0.00	70.00	-24.44	2.92	-24.23	2.75	4.00	-5.68	4.15	-9.65	3.65	4.00	5.99	1.22						
0.00	80.00	-5.70	-5.28	-10.23	-7.72	4.00	0.00	80.00	-30.28	3.62	-18.66	3.33	4.00	-5.68	4.15	-9.65	3.66	4.00	5.99	1.22						
0.00	90.00	-5.92	-11.29	-10.97	-16.47	4.00	0.00	90.00	-18.40	4.02	-15.48	3.61	4.00	-5.68	4.15	-9.65	3.65	4.00	5.98	1.22						
0.00	100.00	-6.42	-35.85	-12.06	-18.75	4.00	0.00	100.00	-13.71	4.15	-13.35	3.63	4.00	-5.68	4.15	-9.65	3.66	4.00	5.99	1.22						
0.00	110.00	-7.25	-10.83	-13.63	-8.46	4.00	0.00	110.00	-10.87	4.01	-11.87	3.38	4.00	-5.68	4.15	-9.65	3.66	4.00	5.99	1.22						
0.00	120.00	-8.45	-5.06	-15.87	-4.04	4.00	0.00	120.00	-8.94	3.59	-10.83	2.85	4.00	-5.68	4.15	-9.65	3.66	4.00	5.99	1.22						
0.00	130.00	-10.17	-1.80	-19.29	-1.32	4.00	0.00	130.00	-7.59	2.88	-10.15	1.99	4.00	-5.68	4.15	-9.65	3.65	4.00	5.99	1.22						
0.00	140.00	-12.65	0.36	-25.53	0.54	4.00	0.00	140.00	-6.65	1.80	-9.76	0.74	4.00	-5.68	4.15	-9.65	3.65	4.00	5.99	1.22						
0.00	150.00	-16.55	1.87	-47.29	1.85	4.00	0.00	150.00	-6.05	0.26	-9.65	-1.03	4.00	-5.68	4.15	-9.65	3.65	4.00	5.99	1.22						
0.00	160.00	-24.44	2.92	-24.23	2.75	4.00	0.00	160.00	-5.74	-1.94	-9.80	-3.62	4.00	-5.68	4.15	-9.65	3.65	4.00	5.99	1.22						
0.00	170.00	-30.28	3.62	-18.66	3.33	4.00	0.00	170.00	-5.70	-5.28	-10.23	-7.72	4.00	-5.68	4.15	-9.65	3.66	4.00	5.99	1.22						
0.00	180.00	-18.40	4.02	-15.48	3.61	4.00	0.00	180.00	-5.92	-11.29	-10.97	-16.47	4.00	-5.68	4.15	-9.65	3.65	4.00	5.98	1.22						
0.00	190.00	-13.71	4.15	-13.35	3.63	4.00	0.00	190.00	-6.42	-35.85	-12.06	-18.75	4.00	-5.68	4.15	-9.65	3.66	4.00	5.99	1.22						
0.00	200.00	-10.87	4.01	-11.87	3.38	4.00	0.00	200.00	-7.25	-10.83	-13.63	-8.46	4.00	-5.68	4.15	-9.65	3.66	4.00	5.99	1.22						
0.00	210.00	-8.94	3.59	-10.83	2.85	4.00	0.00	210.00	-8.45	-5.06	-15.87	-4.04	4.00	-5.68	4.15	-9.65	3.66	4.00	5.99	1.22						
0.00	220.00	-7.59	2.88	-10.15	1.99	4.00	0.00	220.00	-10.17	-1.80	-19.29	-1.32	4.00	-5.68	4.15	-9.65	3.65	4.00	5.99	1.22						
0.00	230.00	-6.65	1.80	-9.76	0.74	4.00	0.00	230.00	-12.65	0.36	-25.53	0.54	4.00	-5.68	4.15	-9.65	3.65	4.00	5.99	1.22						
0.00	240.00	-6.05	0.26	-9.65	-1.03	4.00	0.00	240.00	-16.55	1.87	-47.29	1.85	4.00	-5.68	4.15	-9.65	3.65	4.00	5.99	1.22						
0.00	250.00	-5.74	-1.94	-9.80	-3.62	4.00	0.00	250.00	-24.44	2.92	-24.23	2.75	4.00	-5.68	4.15	-9.65	3.65	4.00	5.99	1.22						
0.00	260.00	-5.70	-5.28	-10.23	-7.72	4.00	0.00	260.00	-30.28	3.62	-18.66	3.33	4.00	-5.68	4.15	-9.65	3.66	4.00	5.99	1.22						
0.00	270.00	-5.92	-11.29	-10.97	-16.47	4.00	0.00	270.00	-18.40	4.02	-15.48	3.61	4.00	-5.68	4.15	-9.65	3.65	4.00	5.98	1.22						
0.00	280.00	-6.42	-35.85	-12.06	-18.75	4.00	0.00	280.00	-13.71	4.15	-13.35	3.63	4.00	-5.68	4.15	-9.65	3.66	4.00	5.99	1.22						
0.00	290.00	-7.25	-10.83	-13.63	-8.46	4.00	0.00	290.00	-10.87	4.01	-11.87	3.38	4.00	-5.68	4.15	-9.65	3.66	4.00	5.99	1.22						
0.00	300.00	-8.45	-5.06	-15.87	-4.04	4.00	0.00	300.00	-8.94	3.59	-10.83	2.85	4.00	-5.68	4.15	-9.65	3.66	4.00	5.99	1.22						
0.00	310.00	-10.17	-1.80	-19.29	-1.32	4.00	0.00	310.00	-7.59	2.88	-10.15	1.99	4.00	-5.68	4.15	-9.65	3.65	4.00	5.99	1.22						
0.00	320.00	-12.65	0.36	-25.53	0.54	4.00	0.00	320.00	-6.65	1.80	-9.76	0.74	4.00	-5.68	4.15	-9.65	3.65	4.00	5.99	1.22						
0.00	330.00	-16.55	1.87	-47.29	1.85	4.00	0.00	330.00	-6.05	0.26	-9.65	-1.03	4.00	-5.68	4.15	-9.65	3.65	4.00	5.99	1.22						
0.00	340.00	-24.44	2.92	-24.23	2.75	4.00	0.00	340.00	-5.74	-1.94	-9.80	-3.62	4.00	-5.68	4.15	-9.65	3.65	4.00	5.99	1.22						
0.00	350.00	-30.28	3.62	-18.66	3.33	4.00	0.00	350.00	-5.70	-5.28	-10.23	-7.72	4.00	-5.68	4.15	-9.65	3.66	4.00	5.99	1.22						
15.00	0.00	-14.11	1.94	-5.48	1.92	4.00	15.00	0.00	-0.36	-10.37	-9.31	-17.01	4.00	-0.18	2.19	-3.98	1.98	4.00	6.35	0.60						
15.00	10.00	-12.55	1.89	-4.03	1.37	4.00	15.00	10.00	-1.36	-11.59	-11.69	-10.53	4.00	-1.04	2.08	-3.34	1.64	4.00	6.12	0.34						
15.00	20.00	-15.50	1.25	-3.85	0.22	4.00	15.00	20.00	-4.51	-9.55	-12.16	-5.61	4.00	-4.18	1.60	-3.25	1.23	4.00	5.25	-0.43						
15.00	30.00	-19.97	0.15	-3.66	-0.58	4.00	15.00	30.00	-6.10	-8.73	-12.55	-2.74	4.00	-5.93	0.68	-3.13	1.48	4.00	4.79	-0.81						
15.00	40.00	-19.10	-0.42	-4.49	-0.87	4.00	15.00	40.00	-5.71	-5.68	-15.45	-1.84	4.00	-5.52	0.71	-4.16	1.68	4.00	4.73	-0.81						
15.00	50.00	-20.90	-0.76	-4.66	-2.96	4.00	15.00	50.00	-8.06	-5.02	-17.14	-0.78	4.00	-7.84	0.62	-4.42	1.28	4.00	4.19	-1.22						
15.00	60.00	-16.74	-2.54	-5.63	-4.92	4.00	15.00	60.00	-10.74	-3.25	-18.92	-0.67	4.00	-9.77	0.08	-5.43	0.72	4.00	3.39	-1.89						
15.00	70.00	-16.57	-3.40	-5.41	-1.36	4.00	15.00	70.00	-14.30	-2.19	-17.24	-0.16	4.00	-12.28	0.26	-5.13	0.33	4.00	3.13	-2.03						
15.00	80.00	-14.44	-6.35	-5.61	-15.07	4.00	15.00	80.00	-21.54	-0.91	-15.20	-0.04	4.00	-13.67	0.18	-5.16	0.09	4.00	2.90	-2.20						
15.00	90.00	-11.50	-9.73	-5.21	-18.08	4.00	15.00	90.00	-23.60	0.18	-19.50	0.50	4.00	-11.24	0.60	-5.05	0.56	4.00	3.44	-1.75						
15.00	100.00	-10.83	-11.64	-4.58	-8.72	4.00	15.00	100.00	-13.39	0.30	-20.08	0.63	4.00	-8.91	0.57	-4.28	1.11	4.00	4.01	-1.35						
15.00	110.00	-11.48	-8.24	-3.81	-4.48	4.00	15.00	110.00	-9.94	-0.36	-25.76	-0.07	4.00	-7.63	0.57	-3.78	1.77	4.00	4.37	-1.15						
15.00	120.00	-12.66	-6.32	-4.51	-2.36	4.00	15.00	120.00	-7.62	0.17	-28.46	-0.58	4.00	-6.44	0.75	-4.49	1.63	4.00	4.53	-0.93						
15.00	130.00	-19.56	-5.20	-3.03	0.20	4.00	15.00	130.00	-5.33	-0.32	-24.00	-2.00	4.00	-5.17	0.90	-3.00	2.00	4.00	5.17	-0.43						
15.00	140.00	-25.31	-1.79	-3.02	1.72	4.00	15.00	140.00	-4.95	-0.65	-17.10	-1.11	4.00	-4.91	1.83	-2.85	2.73	4.00	5.78	0.25						
15.00	150.00	-13.58	-0.28	-3.67	2.42	4.00	15.00	150.00	-3.70	-2.16	-13.10	-7.04	4.00	-3.28	2.24	-3.20	2.89	4.00	6.16	0.58						
15.00	160.00	-10.37	1.83	-4.69	2.96	4.00	15.00	160.00	-3.21	-5.09	-13.49	-9.69	4.00	-2.45	2.63	-4.15	3.19	4.00	6.39	0.86						
15.00	170.00	-7.37	2.25	-5.98	3.30	4.00	15.00	170.00	-3.99	-10.71	-11.60	-13.13	4.00	-2.35	2.46	-4.93	3.40	4.00	6.31	0.84						
15.00	180.00	-7.00	2.74	-6.67	3.78	4.00	15.00	180.00	-6.24	-14.44	-11.26	-15.10	4.00	-3.59	2.82	-5.37	3.84	4.00	6.32	1.02						
15.00	190.00	-8.78	2.25	-7.21	3.54	4.00	15.00	190.00	-7.68	-8.49	-12.01	-10.22	4.00	-5.18	2.60	-5.97	3.72	4.00	5.88	0.73						
15.00	200.00	-6.43	2.07	-8.64	2.88	4.00	15.00	200.00	-9.18	-5.68	-11.02	-5.25	4.00	-4.58	2.74	-6.66	3.50	4.00	5.85	0.69						
15.00	210.00	-5.64	1.99	-8.60	1.77	4.00	15.00	210.00	-9.05	-4.44	-9.70	-2.19	4.00	-4.01	2.18	-6.10	3.24</									



45.00	190.00	0.00	-1.16	1.05	-0.97	4.00	45.00	190.00	-5.48	-11.00	-10.05	-6.59	4.00	1.08	-0.73	1.37	-0.86	4.00	6.30	0.34
45.00	200.00	0.82	-2.00	0.38	-1.67	4.00	45.00	200.00	-8.92	-12.04	-9.06	-8.80	4.00	1.26	-1.59	0.85	-0.90	4.00	6.00	0.06
45.00	210.00	0.25	-4.30	-0.52	-2.38	4.00	45.00	210.00	-11.14	-10.20	-9.59	-6.88	4.00	0.55	-3.31	-0.01	-1.06	4.00	5.18	-0.73
45.00	220.00	0.05	-3.61	-1.25	-4.34	4.00	45.00	220.00	-11.89	-7.08	-9.57	-5.31	4.00	0.32	-2.00	-0.65	-1.79	4.00	5.04	-0.93
45.00	230.00	-0.32	-4.30	-1.88	-5.72	4.00	45.00	230.00	-12.55	-5.09	-10.57	-4.72	4.00	-0.07	-1.67	-1.33	-2.18	4.00	4.75	-1.24
45.00	240.00	-1.59	-8.14	-2.86	-6.35	4.00	45.00	240.00	-16.21	-3.60	-9.27	-3.50	4.00	-1.44	-2.29	-1.97	-1.68	4.00	4.18	-1.83
45.00	250.00	-3.09	-15.35	-5.43	-6.97	4.00	45.00	250.00	-19.31	-7.15	-10.18	-2.86	4.00	-2.99	-2.52	-4.18	-1.31	4.00	3.34	-2.63
45.00	260.00	-1.70	-22.61	-6.14	-9.24	4.00	45.00	260.00	-26.25	-2.31	-14.76	-1.68	4.00	-1.68	-2.27	-5.58	-0.98	4.00	3.56	-2.32
45.00	270.00	-0.96	-17.07	-5.11	-13.05	4.00	45.00	270.00	-18.73	-1.93	-22.95	-0.63	4.00	-0.89	-1.80	-5.04	-0.39	4.00	4.17	-1.70
45.00	280.00	0.13	-12.59	-4.54	-18.40	4.00	45.00	280.00	-18.18	-1.58	-17.98	-0.55	4.00	0.19	-1.25	-4.35	-0.87	4.00	4.61	-1.28
45.00	290.00	-0.33	-2.94	-2.84	-23.14	4.00	45.00	290.00	-11.86	-1.72	-12.92	-1.99	4.00	-0.03	-1.17	-2.40	-1.96	4.00	4.68	-1.30
45.00	300.00	-0.68	-6.27	-1.50	-14.53	4.00	45.00	300.00	-10.80	-5.13	-10.91	-1.54	4.00	-0.28	-2.65	-1.07	-1.33	4.00	4.73	-1.25
45.00	310.00	-0.68	-4.87	-0.84	-11.10	4.00	45.00	310.00	-8.93	-4.98	-10.74	-0.82	4.00	0.45	-1.91	-0.42	-0.43	4.00	5.48	-0.50
45.00	320.00	-0.69	-6.38	-1.60	-6.78	4.00	45.00	320.00	-6.09	-5.38	-8.35	-1.17	4.00	0.41	-2.84	-0.77	-0.12	4.00	5.28	-0.67
45.00	330.00	-2.19	-8.54	-1.94	-7.12	4.00	45.00	330.00	-3.18	-8.83	-7.04	-4.13	4.00	0.35	-5.67	-0.77	-2.36	4.00	4.19	-1.59
45.00	340.00	-3.06	-11.45	-0.09	-7.22	4.00	45.00	340.00	-2.69	-8.07	-7.04	-7.06	4.00	0.14	-6.43	0.71	-4.13	4.00	4.08	-1.51
45.00	350.00	-2.72	-5.07	0.39	-5.40	4.00	45.00	350.00	-2.32	-6.77	-7.48	-15.90	4.00	0.49	-2.83	1.05	-5.03	4.00	4.78	-0.93
60.00	0.00	-3.71	-7.40	0.91	-8.79	4.00	60.00	0.00	-3.97	-7.89	-13.86	-10.80	4.00	-0.83	-4.63	1.05	-6.67	4.00	3.78	-1.77
60.00	10.00	-4.25	-7.88	0.97	-9.38	4.00	60.00	10.00	-3.54	-12.66	-15.56	-6.80	4.00	-0.87	-6.63	1.07	-4.89	4.00	3.72	-1.81
60.00	20.00	-4.55	-8.43	0.72	-15.37	4.00	60.00	20.00	-2.47	-23.92	-13.74	-4.51	4.00	-0.38	-8.31	0.87	-4.17	4.00	3.71	-1.76
60.00	30.00	-7.03	-7.63	0.96	-10.77	4.00	60.00	30.00	-2.29	-8.72	-9.43	-4.62	4.00	-1.03	-5.13	1.34	-3.68	4.00	4.25	-1.42
60.00	40.00	-11.12	-6.91	0.08	-13.05	4.00	60.00	40.00	-3.58	-6.18	-12.01	-7.41	4.00	-2.88	-3.52	0.34	-6.36	4.00	3.24	-2.45
60.00	50.00	-7.89	-8.25	-1.17	-21.86	4.00	60.00	50.00	-3.91	-2.66	-15.34	-6.02	4.00	-2.45	-1.60	-1.01	-5.91	4.00	3.47	-2.38
60.00	60.00	-8.05	-12.52	-1.51	-14.57	4.00	60.00	60.00	-5.62	-0.20	-12.12	-8.20	4.00	-3.66	0.05	-1.15	-8.34	4.00	3.29	-2.30
60.00	70.00	-10.32	-15.85	-1.58	-11.05	4.00	60.00	70.00	-9.37	0.45	-13.25	-8.74	4.00	-6.81	-3.20	-5.20	-3.20	4.00	3.93	-1.14
60.00	80.00	-12.14	-16.36	-1.88	-15.44	4.00	60.00	80.00	-10.21	0.21	-21.66	-4.73	4.00	-11.16	0.30	-6.10	-4.38	4.00	1.63	-3.57
60.00	90.00	-12.03	-12.25	-1.87	-31.03	4.00	60.00	90.00	-18.16	0.33	-15.32	-4.16	4.00	-11.08	0.56	-6.20	-4.15	4.00	1.78	-3.37
60.00	100.00	-13.11	-12.17	-1.89	-17.31	4.00	60.00	100.00	-9.77	0.48	-12.44	-4.71	4.00	-8.12	0.71	-1.62	-4.48	4.00	3.24	-2.26
60.00	110.00	-10.41	-14.42	-2.26	-15.76	4.00	60.00	110.00	-5.75	0.36	-11.36	-4.47	4.00	-4.47	0.50	-1.76	-4.16	4.00	3.79	-1.99
60.00	120.00	-6.20	-7.83	-1.71	-14.66	4.00	60.00	120.00	-4.49	-0.57	-10.38	-3.51	4.00	-2.25	0.18	-1.16	-3.19	4.00	4.51	-1.42
60.00	130.00	-3.85	-4.28	0.01	-17.72	4.00	60.00	130.00	-4.57	-1.43	-7.73	-2.75	4.00	-1.18	0.39	0.69	-2.61	4.00	5.44	-0.49
60.00	140.00	-2.80	-3.21	1.22	-11.15	4.00	60.00	140.00	-1.84	-2.66	-8.26	-3.29	4.00	0.72	0.08	1.68	-2.66	4.00	6.12	0.23
60.00	150.00	-1.35	-2.85	2.59	-15.18	4.00	60.00	150.00	-1.62	-4.81	-11.94	-6.73	4.00	1.53	-0.71	2.74	-6.15	4.00	5.97	0.41
60.00	160.00	-0.78	-0.85	2.83	-14.44	4.00	60.00	160.00	-1.86	-4.67	-9.93	-7.75	4.00	1.72	0.66	3.05	-6.91	4.00	6.38	0.86
60.00	170.00	-0.79	-0.82	2.58	-6.82	4.00	60.00	170.00	-1.29	-7.20	-8.38	-10.52	4.00	1.98	0.08	2.91	-0.82	4.00	6.82	1.03
60.00	180.00	1.10	-2.43	2.03	-0.45	4.00	60.00	180.00	-1.69	-5.86	-8.91	-16.73	4.00	2.94	-0.80	2.37	0.35	4.00	7.21	1.34
60.00	190.00	0.59	-4.27	1.31	-0.87	4.00	60.00	190.00	-4.27	-10.91	-6.75	-11.60	4.00	1.82	-3.42	1.94	-0.52	4.00	6.23	0.44
60.00	200.00	0.89	-8.28	-0.50	-1.05	4.00	60.00	200.00	-6.56	-15.19	-5.74	-6.80	4.00	1.61	-7.47	0.64	-0.03	4.00	5.34	-0.25
60.00	210.00	0.41	-7.41	-0.85	-2.18	4.00	60.00	210.00	-11.52	-13.68	-7.76	-4.21	4.00	0.68	-6.49	-0.04	-0.07	4.00	4.97	-0.75
60.00	220.00	-1.45	-13.39	-0.19	-2.45	4.00	60.00	220.00	-33.38	-11.14	-7.70	-4.58	4.00	-1.45	-9.11	0.52	-0.38	4.00	4.13	-1.42
60.00	230.00	-2.82	-16.66	-1.35	-3.68	4.00	60.00	230.00	-12.21	-11.15	-6.71	-3.17	4.00	-2.35	-10.27	-0.24	-0.41	4.00	3.53	-1.98
60.00	240.00	-1.99	-15.69	-3.37	-10.24	4.00	60.00	240.00	-16.81	-7.06	-6.23	-5.44	4.00	-1.85	-6.50	-1.56	0.80	4.00	4.12	-1.58
60.00	250.00	-2.65	-17.93	-5.00	-10.92	4.00	60.00	250.00	-10.80	-5.53	-9.06	0.51	4.00	-2.03	-5.29	-3.56	0.81	4.00	3.80	-1.92
60.00	260.00	-1.73	-18.61	-3.93	-15.21	4.00	60.00	260.00	-9.50	-4.01	-14.83	0.30	4.00	-1.06	-3.86	-3.59	0.42	4.00	4.18	-1.65
60.00	270.00	-2.97	-17.00	-3.06	-14.96	4.00	60.00	270.00	-8.64	-3.08	-11.02	0.67	4.00	-1.93	-2.91	-2.42	0.79	4.00	4.53	-1.36
60.00	280.00	-4.97	-19.71	-2.30	-16.78	4.00	60.00	280.00	-11.44	-4.90	-5.62	0.53	4.00	-4.09	-4.76	-0.64	0.61	4.00	4.09	-1.65
60.00	290.00	-1.21	-20.54	-1.12	-20.11	4.00	60.00	290.00	-13.21	-4.87	-5.89	0.58	4.00	-0.94	-4.75	0.13	0.62	4.00	5.02	-0.81
60.00	300.00	-1.07	-18.91	0.55	-17.08	4.00	60.00	300.00	-15.54	-3.57	-8.48	-0.89	4.00	-0.92	-3.44	1.06	-0.79	4.00	5.14	-0.74
60.00	310.00	-4.27	-10.12	1.22	-11.98	4.00	60.00	310.00	-10.17	-5.74	-10.48	-1.68	4.00	-3.28	-3.63	1.50	-1.29	4.00	4.60	-1.16
60.00	320.00	-1.23	-9.56	-0.33	-6.79	4.00	60.00	320.00	-3.98	-8.88	-11.03	-0.18	4.00	0.62	-6.20	0.02	0.68	4.00	5.22	-0.50
60.00	330.00	-1.54	-7.19	-1.97	-6.11	4.00	60.00	330.00	-5.50	-6.65	-9.57	-2.87	4.00	-0.07	-3.90	-1.27	-1.18	4.00	4.52	-1.40
60.00	340.00	-2.16	-10.01	-1.37	-5.18	4.00	60.00	340.00	-3.56	-6.60	-8.26	-8.68	4.00	0.21	-4.97	-0.56	-3.58	4.00	4.05	-1.73
60.00	350.00	-2.89	-11.71	-0.54	-16.45	4.00	60.00	350.00	-4.37	-10.07	-10.65	-13.45	4.00	-0.56	-5.02	-0.14	-5.02	4.00	3.65	-2.08
75.00	0.00	-4.24	-24.80	-2.31	-9.72	4.00	75.00	0.00	-5.64	-21.39	-15.91	-21.40	4.00	-1.87	-19.76	-2.12	-1.94	4.00	3.13	-4.60
75.00	10.00	-4.68	-26.45	-2.98	-14.63	4.00	75.00	10.00	-5.09	-13.42	-14.73	-17.89	4.00	-1.87	-13.21	-2.70	-12.95	4.00	0.07	-4.93
75.00	20.00	-3.63	-29.67	-0.67	-19.16	4.00	75.00	20.00	-4.85	-17.17	-15.84	-7.48	4.00	-1.19	-16.93	-0.54	-1.79	4.00	1.55	-3.34
75.00	30.00	-3.22	-20.07	0.26	-9.44	4.00	75.00	30.00	-5.23	-8.48	-21.5	-8.00	4.00	-1.10	-8.19	0.29	-5.65	4.00	3.00	-2.46
75.00	40.00	-2.81	-18.48	-0.48	-6.11	4.00	75.00	40.00	-3.88	-8.70	-11.05	-8.83	4.00	-0.30	-8.27	-0.30	-1.25	4.00	3.13	-3.46
75.00	50.00	-4.36	-17.82	-0.84	-7.42	4.00	75.00	50.00	-4.30	-10.39	-9.74	-8.55	4.00	-1.27	-9.67	-0.61	-1.39	4.00	2.30	-3.04
75.00	60.00	-6.55	-15.83	-2.53	-10.06	4.00	75.00	60.00	-6.91	-10.01	-13.24	-6.01	4.00	-3.72	-9.90	-1.14	-4.57	4.00	1.73	-3.86
75.00	70.00	-6.6	-18.16	-2.7	-9.28	4.00	75.00	70.00	-11.33	-8.29	-14.74	-5.48	4.00	-5.34	-7.86	-2.44	-3.97	4.00	1.34	-4.47



105.00	100.00	-3.34	-16.43	-2.18	-17.55	4.00	105.00	100.00	-10.1	-4.76	-8.43	-4.92	4.00	-2.51	-4.47	-1.26	-4.69	4.00	2.91	-3.00	
105.00	110.00	-3.9	-25.11	-12.68	-11.91	4.00	105.00	110.00	-6.02	-6.90	-7.59	-10.73	4.00	-1.82	-6.83	-6.42	-8.27	4.00	0.55	-5.08	
105.00	120.00	-3.32	-15.64	-6.22	-10.79	4.00	105.00	120.00	-3.85	-13.12	-14.76	-11.75	4.00	-0.57	-11.19	-5.65	-9.99	4.00	0.22	-4.79	
105.00	130.00	-2.61	-14.40	-2.68	-17.10	4.00	105.00	130.00	-2.47	-18.71	-26.99	-25.20	4.00	0.47	-13.03	-2.66	-16.47	4.00	0.69	-3.64	
105.00	140.00	-3.16	-14.72	-5.23	-10.21	4.00	105.00	140.00	-2.06	-7.85	-22.87	-10.00	4.00	0.44	-7.04	-5.16	-7.12	4.00	1.90	-3.46	
105.00	150.00	-3.49	-12.78	-2.45	-9.24	4.00	105.00	150.00	-1.88	-9.59	-21.87	-8.99	4.00	0.40	-7.89	-2.40	-6.10	4.00	2.62	-2.84	
105.00	160.00	-4.41	-9.95	-1.80	-15.59	4.00	105.00	160.00	-1.79	-10.04	-20.77	-11.05	4.00	0.10	-6.98	-1.75	-11.74	4.00	2.06	-3.10	
105.00	170.00	-6.49	-7.24	-3.42	-11.22	4.00	105.00	170.00	-3.20	-7.04	-20.86	-9.90	4.00	-1.53	-4.13	-3.34	-7.50	4.00	2.15	-3.64	
105.00	180.00	-6.96	-12.34	0.14	-9.31	4.00	105.00	180.00	-3.87	-7.23	-15.98	-35.54	4.00	-2.14	-6.06	0.24	-9.30	4.00	2.45	-2.94	
105.00	190.00	-8.78	-16.72	-0.77	-8.20	4.00	105.00	190.00	-4.44	-25.62	-7.74	-11.71	4.00	-3.08	-16.19	0.03	-6.60	4.00	1.32	-3.61	
105.00	200.00	-5.78	-21.59	-1.67	-5.38	4.00	105.00	200.00	-10.31	-11.63	-8.96	-13.58	4.00	-4.47	-11.21	-1.73	-3.42	4.00	1.46	-4.09	
105.00	210.00	-7.45	-20.93	-1.63	-6.38	4.00	105.00	210.00	-7.19	-7.46	-23.93	-17.14	4.00	-4.31	-7.27	-1.62	-5.10	4.00	1.68	-4.10	
105.00	220.00	-7.93	-17.70	-1.26	-11.21	4.00	105.00	220.00	-14.91	-25.00	-22.19	-9.19	4.00	-7.14	-16.96	-1.23	-6.11	4.00	-0.49	-5.37	
105.00	230.00	-8.24	-20.99	-3.75	-11.45	4.00	105.00	230.00	-12.40	-8.80	-14.94	-5.21	4.00	-6.83	-8.55	-3.43	-4.28	4.00	0.48	-5.32	
105.00	240.00	-8.29	-12.45	-8.76	-7.27	4.00	105.00	240.00	-22.79	-6.70	-13.69	-2.55	4.00	-8.14	-5.68	-7.55	-1.29	4.00	0.80	-4.74	
105.00	250.00	-21.53	-42.56	-5.34	-10.05	4.00	105.00	250.00	-17.10	-26.80	-19.32	-1.53	4.00	-15.76	-26.69	-5.17	-26.96	4.00	-1.64	-5.47	
105.00	260.00	-7.09	-24.39	-2.10	-18.28	4.00	105.00	260.00	-22.41	-4.20	-19.85	-1.53	4.00	-6.96	-4.16	-2.03	-1.44	4.00	2.63	-3.17	
105.00	270.00	-6.57	-19.80	-0.78	-18.78	4.00	105.00	270.00	-34.57	-1.10	-16.91	-2.30	4.00	-6.56	-1.04	-0.68	-2.20	4.00	3.69	-2.10	
105.00	280.00	-11.30	-20.09	-1.79	-17.72	4.00	105.00	280.00	-15.92	-3.78	-13.83	-3.93	4.00	-10.01	-3.68	-1.53	-3.75	4.00	1.79	-3.84	
105.00	290.00	-14.64	-19.67	-4.81	-13.26	4.00	105.00	290.00	-16.53	-12.44	-8.78	-3.95	4.00	-12.47	-11.69	-3.35	-3.47	4.00	-0.68	-5.86	
105.00	300.00	-7.67	-11.00	-4.71	-6.49	4.00	105.00	300.00	-23.31	-2.37	-5.39	-5.62	4.00	-7.55	-1.81	-2.03	-3.02	4.00	2.70	-3.10	
105.00	310.00	-7.78	-9.90	-3.53	-8.58	4.00	105.00	310.00	-23.04	-4.85	-6.52	-8.58	4.00	-7.65	-3.67	-1.76	-2.62	4.00	2.36	-3.43	
105.00	320.00	-8.18	-5.68	-5.06	-2.72	4.00	105.00	320.00	-23.03	-12.00	-10.28	-7.86	4.00	-8.04	-4.77	-3.92	-1.56	4.00	1.75	-3.99	
105.00	330.00	-8.61	-6.06	-11.36	-4.70	4.00	105.00	330.00	-10.21	-11.18	-10.68	-6.94	4.00	-6.33	-4.90	-8.00	-2.67	4.00	0.77	-5.03	
105.00	340.00	-9.42	-12.72	-13.32	-4.54	4.00	105.00	340.00	-14.05	-8.60	-11.71	-4.11	4.00	-8.13	-7.18	-9.43	-1.31	4.00	0.12	-5.23	
105.00	350.00	-14.84	-12.78	-6.08	-5.27	4.00	105.00	350.00	-24.09	-17.26	-19.61	-12.08	4.00	-14.35	-11.46	-5.89	-4.45	4.00	-2.13	-7.42	
120.00	0.00	-5.01	-7.00	-5.81	-3.03	4.00	120.00	0.00	-7.60	-13.58	-15.16	-25.09	4.00	-3.10	-6.14	-5.33	-3.00	4.00	1.73	-4.18	
120.00	10.00	-4.18	-11.06	-3.97	-4.74	4.00	120.00	10.00	-10.61	-19.59	-19.08	-4.74	4.00	-3.29	-10.49	-3.84	-3.34	4.00	1.24	-4.45	
120.00	20.00	-6.86	-6.46	-4.60	-5.44	4.00	120.00	20.00	-8.25	-11.23	-18.77	-13.97	4.00	-4.49	-5.21	-4.44	-4.87	4.00	1.27	-4.74	
120.00	30.00	-5.64	-8.66	-5.20	-7.38	4.00	120.00	30.00	-7.23	-14.07	-9.76	-7.81	4.00	-3.35	-7.56	-3.90	-2.90	4.00	1.77	-4.09	
120.00	40.00	-2.74	-9.10	-4.54	-9.97	4.00	120.00	40.00	-6.20	-12.15	-12.89	-5.31	4.00	-1.12	-7.35	-3.95	-4.03	4.00	2.18	-3.58	
120.00	50.00	-0.52	-6.60	-3.92	-20.82	4.00	120.00	50.00	-4.11	-1.28	-16.03	-6.45	4.00	1.06	-0.16	-4.11	-3.66	-6.29	4.00	4.22	-1.39
120.00	60.00	-0.25	-6.33	-9.83	-10.03	4.00	120.00	60.00	-4.90	-1.37	-16.81	-7.73	4.00	1.03	-0.17	-9.04	-5.72	4.00	3.46	-1.83	
120.00	70.00	-2.02	-6.72	-10.23	-13.17	4.00	120.00	70.00	-7.94	-6.99	-14.12	-12.25	4.00	-2.03	-3.84	-8.71	-9.64	4.00	0.93	-4.42	
120.00	80.00	-2.75	-6.22	-11.51	-10.51	4.00	120.00	80.00	-10.41	-10.25	-14.12	-27.26	4.00	-1.06	-4.77	-3.84	-3.97	4.00	0.57	-4.61	
120.00	90.00	-2.95	-14.03	-3.44	-13.52	4.00	120.00	90.00	-10.55	-3.83	-11.73	-13.94	4.00	-2.25	-3.43	-3.28	-10.67	4.00	1.67	-3.97	
120.00	100.00	-2.87	-21.49	-5.90	-15.73	4.00	120.00	100.00	-7.43	-2.03	-14.52	-11.12	4.00	-1.57	-1.98	-5.34	-3.93	4.00	1.92	-3.85	
120.00	110.00	-3.61	-13.49	-16.35	-26.54	4.00	120.00	110.00	-7.81	-2.64	-12.09	-16.83	4.00	-2.21	-2.30	-10.71	-16.39	4.00	-0.06	-4.89	
120.00	120.00	-3.72	-11.83	-8.83	-16.56	4.00	120.00	120.00	-5.89	-6.44	-13.81	-12.58	4.00	-1.66	-5.34	-7.63	-6.44	4.00	0.26	-5.14	
120.00	130.00	-2.88	-10.44	-4.54	-9.13	4.00	120.00	130.00	-4.67	-16.55	-25.75	-10.66	4.00	-0.67	-9.49	-4.51	-6.90	4.00	1.24	-4.38	
120.00	140.00	-4.06	-10.88	-11.12	-11.86	4.00	120.00	140.00	-8.27	-9.80	-9.82	-5.69	4.00	-2.66	-14.30	-7.41	-9.80	4.00	0.72	-5.07	
120.00	150.00	-5.95	-8.21	-11.91	-9.25	4.00	120.00	150.00	-7.21	-13.01	-12.48	-7.43	4.00	-3.52	-6.97	-9.18	-5.24	4.00	0.04	-5.74	
120.00	160.00	-8.31	-3.90	-3.52	-5.65	4.00	120.00	160.00	-9.79	-19.47	-17.67	-8.43	4.00	-5.98	-3.78	-3.36	-3.81	4.00	1.85	-4.12	
120.00	170.00	-9.39	-4.03	-5.72	-5.56	4.00	120.00	170.00	-8.74	-24.41	-20.05	-10.27	4.00	-6.04	-3.99	-5.56	-4.30	4.00	1.09	-4.89	
120.00	180.00	-12.03	-4.55	-4.27	-3.41	4.00	120.00	180.00	-9.76	-12.55	-22.09	-15.07	4.00	-7.74	-3.91	-4.20	-3.12	4.00	1.45	-4.43	
120.00	190.00	-10.04	-5.58	-6.54	-1.21	4.00	120.00	190.00	-15.24	-13.27	-12.30	-12.05	4.00	-8.89	-4.90	-5.52	-0.87	4.00	1.45	-4.11	
120.00	200.00	-14.87	-5.79	-13.12	-1.03	4.00	120.00	200.00	-16.12	-13.21	-14.39	-9.40	4.00	-12.44	-5.07	-10.70	-0.44	4.00	0.17	-4.69	
120.00	210.00	-15.61	-11.96	-6.31	-4.33	4.00	120.00	210.00	-11.61	-12.19	-12.33	-24.00	4.00	-10.15	-9.06	-5.34	-4.28	4.00	-0.85	-6.55	
120.00	220.00	-14.74	-10.61	-4.70	-7.66	4.00	120.00	220.00	-17.12	-16.66	-15.62	-8.46	4.00	-12.76	-9.65	-4.36	-5.63	4.00	-1.28	-6.77	
120.00	230.00	-23.22	-18.77	-8.61	-8.70	4.00	120.00	230.00	-16.93	-8.87	-24.27	-4.94	4.00	-16.01	-8.45	-8.49	-3.41	4.00	-2.01	-7.18	
120.00	240.00	-18.64	-21.69	-27.00	-9.28	4.00	120.00	240.00	-16.91	-11.50	-25.83	-4.74	4.00	-14.68	-11.10	-16.91	-23.37	4.00	-4.40	-8.46	
120.00	250.00	-24.74	-22.91	-9.07	-10.89	4.00	120.00	250.00	-14.28	-15.74	-23.61	-7.73	4.00	-13.91	-14.98	-8.92	-6.02	4.00	-4.16	-9.48	
120.00	260.00	-13.84	-24.53	-5.31	-19.99	4.00	120.00	260.00	-20.83	-9.79	-21.67	-8.17	4.00	-13.05	-9.65	-5.21	-7.89	4.00	-2.48	-8.08	
120.00	270.00	-17.06	-12.45	-3.20	-19.28	4.00	120.00	270.00	-22.30	-7.99	-11.54	-7.17	4.00	-15.92	-6.66	-2.61	-6.91	4.00	-0.84	-6.05	
120.00	280.00	-22.62	-12.74	-3.81	-13.52	4.00	120.00	280.00	-16.82	-7.67	-7.80	-8.27	4.00	-15.81	-6.49	-2.35	-7.14	4.00	-0.73	-5.91	
120.00	290.00	-10.65	-11.29	-6.40	-14.40	4.00	120.00	290.00	-23.24	-4.11	-8.78	-8.53	4.00	-10.42	-3.35	-4.42	-7.92	4.00	-0.07	-5.70	
120.00	300.00	-12.46	-7.99	-8.26	-26.70	4.00	120.00	300.00	-6.08	-2.12	-10.00	-7.47	4.00	-8.18	-1.12	-6.03	-7.38	4.00	1.42	-4.24	
120.00	310.00	-15.79	-8.40	-7.60	-7.74	4.00	120.00	310.00	-9.01	-7.41	-9.87	-9.56	4.00	-5.18	-4.87	-5.61	-5.55	4.00	0.06	-5.88	
120.00	320.00	-11.54	-8.23	-4.52	-3.86	4.00	120.00	320.00	-10.51	-12.14	-8.95	-14.45	4.00	-7.98	-5.24	-3.24	-3.49	4.00	1.25	-6.49	
120.00	330.00	-15.52	-6.64	-4.19	-2.68	4.00	120.00	330.00	-11.16	-10.36	-16.11	-16.40	4.00	-9.80</							



165.00	10.00	-19.21	-5.86	-10.34	-5.83	4.00		165.00	10.00	-8.93	-6.13	-10.41	-8.08	4.00		-8.54	-2.98	-7.36	-3.80	4.00	0.66	-5.07
165.00	20.00	-11.46	-5.28	-8.94	-7.87	4.00		165.00	20.00	-7.78	-2.67	-11.53	-6.43	4.00		-6.23	-0.77	-7.03	-4.08	4.00	1.84	-3.81
165.00	30.00	-8.69	-4.90	-8.75	-6.93	4.00		165.00	30.00	-8.81	-1.40	-14.87	-6.74	4.00		-5.74	0.20	-7.80	-3.82	4.00	2.25	-3.24
165.00	40.00	-7.02	-6.90	-11.96	-8.78	4.00		165.00	40.00	-9.29	-0.71	-21.94	-7.41	4.00		-5.00	0.23	-11.54	-5.03	4.00	1.63	-3.58
165.00	50.00	-8.59	-8.22	-16.99	-9.53	4.00		165.00	50.00	-11.32	-0.80	-18.31	-9.85	4.00		-6.73	-0.08	-14.59	-6.68	4.00	0.43	-4.42
165.00	60.00	-18.19	-11.79	-25.72	-11.56	4.00		165.00	60.00	-18.47	-2.40	-19.41	-15.52	4.00		-15.32	-1.93	-18.50	-10.09	4.00	-3.07	-7.08
165.00	70.00	-24.82	-16.52	-22.42	-12.33	4.00		165.00	70.00	-23.97	-3.62	-19.14	-18.32	4.00		-21.36	-3.40	-17.47	-11.35	4.00	-4.69	-8.58
165.00	80.00	-12.01	-23.16	-20.88	-12.21	4.00		165.00	80.00	-22.37	-4.92	-18.92	-11.52	4.00		-11.63	-4.86	-16.78	-8.84	4.00	-3.48	-8.64
165.00	90.00	-6.20	-29.06	-15.33	-15.15	4.00		165.00	90.00	-24.35	-4.93	-17.51	-9.66	4.00		-6.13	-4.91	-13.27	-8.58	4.00	-1.67	-7.26
165.00	100.00	-4.97	-17.49	-17.13	-32.74	4.00		165.00	100.00	-15.30	-5.73	-17.26	-8.61	4.00		-4.59	-5.45	-14.18	-8.59	4.00	-1.46	-6.94
165.00	110.00	-4.65	-15.69	-12.94	-14.19	4.00		165.00	110.00	-10.40	-7.40	-17.14	-8.54	4.00		-3.63	-6.80	-11.54	-7.49	4.00	-0.90	-6.52
165.00	120.00	-5.09	-12.78	-10.68	-8.68	4.00		165.00	120.00	-8.97	-13.75	-12.69	-13.74	4.00		-3.60	-10.23	-9.56	-7.50	4.00	-1.09	-6.73
165.00	130.00	-5.43	-12.38	-10.37	-7.84	4.00		165.00	130.00	-8.96	-15.06	-11.16	-14.13	4.00		-3.84	-10.51	-7.74	-6.76	4.00	-0.86	-6.57
165.00	140.00	-7.64	-11.03	-10.22	-8.23	4.00		165.00	140.00	-9.80	-27.85	-11.32	-14.92	4.00		-5.58	-10.94	-7.72	-7.39	4.00	-1.68	-7.52
165.00	150.00	-8.63	-7.84	-8.41	-8.45	4.00		165.00	150.00	-13.76	-22.55	-13.66	-10.71	4.00		-7.47	-7.70	-7.28	-6.42	4.00	-1.18	-7.19
165.00	160.00	-9.85	-5.33	-8.22	-7.61	4.00		165.00	160.00	-16.94	-25.72	-15.05	-10.77	4.00		-9.07	-5.29	-7.40	-5.90	4.00	-0.78	-6.68
165.00	170.00	-11.94	-4.00	-7.88	-7.20	4.00		165.00	170.00	-20.79	-21.52	-16.82	-11.74	4.00		-11.41	-3.92	-7.36	-5.89	4.00	-0.72	-6.39
165.00	180.00	-14.29	-5.56	-7.12	-11.21	4.00		165.00	180.00	-28.35	-21.74	-24.82	-15.32	4.00		-14.12	-5.46	-7.05	-9.79	4.00	-2.51	-8.06
165.00	190.00	-16.57	-7.76	-9.14	-14.76	4.00		165.00	190.00	-22.97	-28.23	-31.39	-17.49	4.00		-15.67	-7.72	-9.11	-12.90	4.00	-4.79	-10.34
165.00	200.00	-13.16	-6.66	-10.77	-20.69	4.00		165.00	200.00	-30.25	-21.36	-19.86	-24.66	4.00		-13.08	-6.52	-10.27	-19.23	4.00	-5.11	-10.24
165.00	210.00	-13.61	-6.19	-13.56	-21.18	4.00		165.00	210.00	-21.88	-16.98	-18.33	-18.87	4.00		-13.01	-5.84	-12.31	-16.86	4.00	-5.04	-10.11
165.00	220.00	-20.38	-6.82	-13.95	-16.42	4.00		165.00	220.00	-14.03	-13.47	-11.95	-17.33	4.00		-13.12	-5.97	-9.83	-13.84	4.00	-4.09	-9.52
165.00	230.00	-19.18	-7.16	-17.99	-13.99	4.00		165.00	230.00	-11.64	-12.35	-14.09	-17.57	4.00		-10.94	-6.01	-12.61	-12.41	4.00	-4.02	-9.55
165.00	240.00	-10.78	-11.28	-13.70	-14.64	4.00		165.00	240.00	-15.89	-11.70	-14.18	-14.76	4.00		-9.61	-8.47	-10.92	-11.69	4.00	-4.07	-10.00
165.00	250.00	-7.76	-17.09	-13.41	-15.72	4.00		165.00	250.00	-13.71	-12.41	-12.87	-12.13	4.00		-6.78	-11.14	-10.12	-10.55	4.00	-3.45	-9.28
165.00	260.00	-5.98	-28.80	-11.67	-19.08	4.00		165.00	260.00	-11.80	-9.64	-10.67	-9.57	4.00		-4.97	-9.59	-8.13	-9.11	4.00	-1.73	-7.54
165.00	270.00	-5.72	-27.36	-13.36	-27.79	4.00		165.00	270.00	-10.42	-6.07	-8.62	-7.90	4.00		-4.45	-6.04	-7.36	-7.86	4.00	-0.30	-6.22
165.00	280.00	-7.73	-17.48	-21.85	-20.79	4.00		165.00	280.00	-9.82	-3.61	-8.50	-6.59	4.00		-5.64	-3.44	-8.30	-6.43	4.00	0.25	-5.60
165.00	290.00	-9.06	-14.59	-22.67	-12.42	4.00		165.00	290.00	-9.33	-2.30	-7.54	-4.80	4.00		-6.18	-2.05	-7.41	-4.11	4.00	1.33	-4.45
165.00	300.00	-9.56	-11.03	-15.88	-7.24	4.00		165.00	300.00	-9.32	-2.09	-8.51	-4.81	4.00		-6.43	-1.57	-7.78	-2.85	4.00	1.73	-3.95
165.00	310.00	-10.22	-9.26	-13.43	-4.61	4.00		165.00	310.00	-8.41	-3.51	-10.57	-3.38	4.00		-6.21	-2.49	-8.76	-0.94	4.00	1.95	-3.61
165.00	320.00	-11.28	-12.72	-12.10	-2.35	4.00		165.00	320.00	-7.34	-5.21	-13.19	-5.23	4.00		-5.87	-4.50	-9.60	-0.55	4.00	1.49	-3.96
165.00	330.00	-12.09	-19.33	-12.35	-0.90	4.00		165.00	330.00	-6.97	-6.35	-14.50	-6.14	4.00		-5.81	-6.14	-10.28	0.24	4.00	1.36	-3.83
165.00	340.00	-15.62	-16.19	-16.71	-0.75	4.00		165.00	340.00	-8.47	-7.08	-12.21	-14.33	4.00		-7.70	-6.58	-10.89	-0.56	4.00	0.44	-4.72
165.00	350.00	-21.46	-10.63	-14.71	-2.26	4.00		165.00	350.00	-9.08	-8.67	-10.84	-20.34	4.00		-8.84	-6.53	-9.35	-2.19	4.00	-0.22	-5.72
180.00	0.00	-17.62	-3.33	-12.84	-3.00	4.00		180.00	0.00	-14.54	-12.87	-13.94	-13.82	4.00		-12.80	-2.87	-10.34	-2.65	4.00	-0.05	-5.22
180.00	10.00	-15.80	-2.96	-11.72	-2.70	4.00		180.00	10.00	-15.81	-19.53	-16.01	-22.19	4.00		-12.79	-2.87	-10.35	-2.65	4.00	-0.05	-5.21
180.00	20.00	-14.53	-2.87	-10.96	-2.68	4.00		180.00	20.00	-17.63	-34.18	-19.11	-25.90	4.00		-12.80	-2.87	-10.34	-2.66	4.00	-0.05	-5.21
180.00	30.00	-13.65	-3.05	-10.52	-2.92	4.00		180.00	30.00	-20.29	-16.83	-24.44	-15.01	4.00		-12.80	-2.87	-10.35	-2.66	4.00	-0.05	-5.22
180.00	40.00	-13.10	-3.50	-10.35	-3.44	4.00		180.00	40.00	-24.56	-11.56	-42.71	-10.49	4.00		-12.80	-2.87	-10.35	-2.66	4.00	-0.05	-5.22
180.00	50.00	-12.83	-4.26	-10.44	-4.28	4.00		180.00	50.00	-34.06	-8.49	-26.83	-7.72	4.00		-12.80	-2.87	-10.34	-2.66	4.00	-0.05	-5.22
180.00	60.00	-12.83	-5.39	-10.81	-5.51	4.00		180.00	60.00	-33.93	-6.43	-20.26	-5.83	4.00		-12.80	-2.87	-10.34	-2.66	4.00	-0.05	-5.21
180.00	70.00	-13.10	-7.00	-11.48	-7.26	4.00		180.00	70.00	-24.52	-4.99	-16.74	-4.50	4.00		-12.80	-2.87	-10.34	-2.66	4.00	-0.05	-5.21
180.00	80.00	-13.66	-9.31	-12.49	-9.80	4.00		180.00	80.00	-20.27	-3.99	-14.44	-3.59	4.00		-12.80	-2.87	-10.35	-2.66	4.00	-0.05	-5.22
180.00	90.00	-14.54	-12.87	-13.94	-13.82	4.00		180.00	90.00	-17.62	-3.33	-12.84	-3.00	4.00		-12.80	-2.87	-10.34	-2.65	4.00	-0.05	-5.22
180.00	100.00	-15.81	-19.53	-16.01	-22.19	4.00		180.00	100.00	-15.80	-2.96	-11.72	-2.70	4.00		-12.79	-2.87	-10.35	-2.65	4.00	-0.05	-5.21
180.00	110.00	-17.63	-34.18	-19.11	-25.90	4.00		180.00	110.00	-14.53	-2.87	-10.96	-2.68	4.00		-12.80	-2.87	-10.34	-2.66	4.00	-0.05	-5.21
180.00	120.00	-20.29	-16.83	-24.44	-15.01	4.00		180.00	120.00	-13.65	-3.05	-10.52	-2.92	4.00		-12.80	-2.87	-10.35	-2.66	4.00	-0.05	-5.22
180.00	130.00	-24.56	-11.56	-42.71	-10.49	4.00		180.00	130.00	-13.10	-3.50	-10.35	-3.44	4.00		-12.80	-2.87	-10.35	-2.66	4.00	-0.05	-5.22
180.00	140.00	-34.06	-8.49	-26.83	-7.72	4.00		180.00	140.00	-12.83	-4.26	-10.44	-4.28	4.00		-12.80	-2.87	-10.34	-2.66	4.00	-0.05	-5.22
180.00	150.00	-33.93	-6.43	-20.26	-5.83	4.00		180.00	150.00	-12.83	-5.39	-10.81	-5.51	4.00		-12.80	-2.87	-10.34	-2.66	4.00	-0.05	-5.21
180.00	160.00	-24.52	-4.99	-16.74	-4.50	4.00		180.00	160.00	-13.10	-7.00	-11.48	-7.26	4.00		-12.80	-2.87	-10.35	-2.65	4.00	-0.05	-5.21
180.00	170.00	-20.27	-3.99	-14.44	-3.59	4.00		180.00	170.00	-13.66	-9.31	-12.49	-9.80	4.00		-12.80	-2.87	-10.35	-2.66	4.00	-0.05	-5.22
180.00	180.00	-17.62	-3.33	-12.84	-3.00	4.00		180.00	180.00	-14.54	-12.87	-13.94	-13.82	4.00		-12.80	-2.87	-10.34	-2.65	4.00	-0.05	-5.22
180.00	190.00	-15.80	-2.96	-11.72	-2.70	4.00		180.00	190.00	-15.81	-19.53	-16.01	-22.19	4.00		-12.79	-2.87	-10.35	-2.65	4.00	-0.05	-5.21
180.00	200.00	-14.53	-2.87	-10.96	-2.68	4.00		180.00	200.00	-17.63	-34.18	-19.11	-25.90	4.00		-12.80	-2.87	-10.34	-2.66	4.00	-0.05	-5.21
180.00	210.00	-13.65	-3.05	-10.52	-2.92	4.00		180.00	210.00	-20.29	-16.83	-24.44	-15.01	4.00		-12.80	-2.87	-10.35	-2.66	4.00	-0.05	-5.22
180.00																						



Frequency: 6175MHz

Theta Polarization										Phi Polarization										Total									
Angle (θ)	Angle (φ)	Max Gain(dBi)				Nant	Angle (θ)	Angle (φ)	Max Gain(dBi)				Nant	Max Gain(dBi)				Nant	Max Dg(dBi)										
		1.54	2.71	0.94	4.98				2.11	3.90	1.79	-4.70		2.94	4.65	3.86	5.02		7.79	1.83									
		Ant 1(G1)	Ant 2(G2)	Ant 3(G3)	Ant 4(G4)				Ant 1(G1)	Ant 2(G2)	Ant 3(G3)	Ant 4(G4)		Ant 1(G1)	Ant 2(G2)	Ant 3(G3)	Ant 4(G4)		g1k	g3k									
0.00	0.00	-7.30	1.93	-14.85	-13.94	4.00	0.00	0.00	-0.78	-9.75	-0.21	-9.42	4.00	0.09	2.22	-0.06	-8.11	4.00	5.31	-0.19									
0.00	10.00	-4.67	2.19	-9.18	-11.81	4.00	0.00	10.00	-1.67	-19.69	-0.64	-10.52	4.00	0.09	2.22	-0.07	-8.11	4.00	5.31	-0.19									
0.00	20.00	-2.87	2.18	-5.96	-10.33	4.00	0.00	20.00	-2.96	-18.31	-1.36	-12.08	4.00	0.10	2.22	-0.07	-8.11	4.00	5.31	-0.19									
0.00	30.00	-1.61	1.90	-3.82	-9.29	4.00	0.00	30.00	-4.79	-9.30	-2.45	-14.32	4.00	0.10	2.22	-0.07	-8.11	4.00	5.31	-0.19									
0.00	40.00	-0.74	1.34	-2.32	-8.61	4.00	0.00	40.00	-7.48	-5.13	-4.00	-17.74	4.00	0.09	2.22	-0.07	-8.11	4.00	5.31	-0.19									
0.00	50.00	-0.20	0.45	-1.27	-8.22	4.00	0.00	50.00	-11.80	-2.52	-6.22	-23.97	4.00	0.09	2.22	-0.06	-8.11	4.00	5.32	-0.19									
0.00	60.00	0.06	-0.85	-0.58	-8.11	4.00	0.00	60.00	-21.59	-0.73	-9.60	-45.98	4.00	0.09	2.22	-0.07	-8.11	4.00	5.31	-0.19									
0.00	70.00	0.06	-2.69	-0.19	-8.26	4.00	0.00	70.00	-20.63	0.53	-15.72	-22.71	4.00	0.10	2.22	-0.07	-8.11	4.00	5.32	-0.19									
0.00	80.00	-0.22	-5.39	-0.07	-8.69	4.00	0.00	80.00	-11.49	1.39	-40.07	-17.13	4.00	0.09	2.22	-0.07	-8.11	4.00	5.31	-0.19									
0.00	90.00	-0.78	-9.75	-0.21	-9.42	4.00	0.00	90.00	-7.30	1.93	-14.85	-13.94	4.00	0.09	2.22	-0.06	-8.11	4.00	5.31	-0.19									
0.00	100.00	-1.67	-19.69	-0.64	-10.52	4.00	0.00	100.00	-4.67	2.19	-9.18	-11.81	4.00	0.09	2.22	-0.07	-8.11	4.00	5.31	-0.19									
0.00	110.00	-2.96	-18.31	-1.36	-12.08	4.00	0.00	110.00	-2.87	2.18	-5.96	-10.33	4.00	0.10	2.22	-0.07	-8.11	4.00	5.31	-0.19									
0.00	120.00	-4.79	-9.30	-2.45	-14.32	4.00	0.00	120.00	-1.61	1.90	-3.82	-9.29	4.00	0.10	2.22	-0.07	-8.11	4.00	5.31	-0.19									
0.00	130.00	-7.48	-5.13	-4.00	-17.74	4.00	0.00	130.00	-0.74	1.34	-2.32	-8.61	4.00	0.09	2.22	-0.07	-8.11	4.00	5.31	-0.19									
0.00	140.00	-11.80	-2.52	-6.22	-23.97	4.00	0.00	140.00	-0.20	0.45	-1.27	-8.22	4.00	0.09	2.22	-0.06	-8.11	4.00	5.32	-0.19									
0.00	150.00	-21.59	-0.73	-9.60	-45.98	4.00	0.00	150.00	0.06	-0.85	-0.58	-8.11	4.00	0.09	2.22	-0.07	-8.11	4.00	5.31	-0.19									
0.00	160.00	-20.63	0.53	-15.72	-22.71	4.00	0.00	160.00	0.06	-2.69	-0.19	-8.26	4.00	0.10	2.22	-0.07	-8.11	4.00	5.32	-0.19									
0.00	170.00	-11.49	1.39	-40.07	-17.13	4.00	0.00	170.00	-0.22	-5.39	-0.07	-8.69	4.00	0.09	2.22	-0.07	-8.11	4.00	5.31	-0.19									
0.00	180.00	-7.30	1.93	-14.85	-13.94	4.00	0.00	180.00	-0.78	-9.75	-0.21	-9.42	4.00	0.09	2.22	-0.06	-8.11	4.00	5.31	-0.19									
0.00	190.00	-4.67	2.19	-9.18	-11.81	4.00	0.00	190.00	-1.67	-19.69	-0.64	-10.52	4.00	0.09	2.22	-0.07	-8.11	4.00	5.31	-0.19									
0.00	200.00	-2.87	2.18	-5.96	-10.33	4.00	0.00	200.00	-2.96	-18.31	-1.36	-12.08	4.00	0.10	2.22	-0.07	-8.11	4.00	5.31	-0.19									
0.00	210.00	-1.61	1.90	-3.82	-9.29	4.00	0.00	210.00	-4.79	-9.30	-2.45	-14.32	4.00	0.10	2.22	-0.07	-8.11	4.00	5.31	-0.19									
0.00	220.00	-0.74	1.34	-2.32	-8.61	4.00	0.00	220.00	-7.48	-5.13	-4.00	-17.74	4.00	0.09	2.22	-0.07	-8.11	4.00	5.31	-0.19									
0.00	230.00	-0.20	0.45	-1.27	-8.22	4.00	0.00	230.00	-11.80	-2.52	-6.22	-23.97	4.00	0.09	2.22	-0.06	-8.11	4.00	5.32	-0.19									
0.00	240.00	0.06	-0.85	-0.58	-8.11	4.00	0.00	240.00	-21.59	-0.73	-9.60	-45.98	4.00	0.09	2.22	-0.07	-8.11	4.00	5.31	-0.19									
0.00	250.00	0.06	-2.69	-0.19	-8.26	4.00	0.00	250.00	-20.63	0.53	-15.72	-22.71	4.00	0.10	2.22	-0.07	-8.11	4.00	5.32	-0.19									
0.00	260.00	-0.22	-5.39	-0.07	-8.69	4.00	0.00	260.00	-11.49	1.39	-40.07	-17.13	4.00	0.09	2.22	-0.07	-8.11	4.00	5.31	-0.19									
0.00	270.00	-0.78	-9.75	-0.21	-9.42	4.00	0.00	270.00	-7.30	1.93	-14.85	-13.94	4.00	0.09	2.22	-0.06	-8.11	4.00	5.31	-0.19									
0.00	280.00	-1.67	-19.69	-0.64	-10.52	4.00	0.00	280.00	-4.67	2.19	-9.18	-11.81	4.00	0.09	2.22	-0.07	-8.11	4.00	5.31	-0.19									
0.00	290.00	-2.96	-18.31	-1.36	-12.08	4.00	0.00	290.00	-2.87	2.18	-5.96	-10.33	4.00	0.10	2.22	-0.07	-8.11	4.00	5.31	-0.19									
0.00	300.00	-4.79	-9.30	-2.45	-14.32	4.00	0.00	300.00	-1.61	1.90	-3.82	-9.29	4.00	0.10	2.22	-0.07	-8.11	4.00	5.31	-0.19									
0.00	310.00	-7.48	-5.13	-4.00	-17.74	4.00	0.00	310.00	-0.74	1.34	-2.32	-8.61	4.00	0.09	2.22	-0.07	-8.11	4.00	5.31	-0.19									
0.00	320.00	-11.80	-2.52	-6.22	-23.97	4.00	0.00	320.00	-0.20	0.45	-1.27	-8.22	4.00	0.09	2.22	-0.06	-8.11	4.00	5.32	-0.19									
0.00	330.00	-21.59	-0.73	-9.60	-45.98	4.00	0.00	330.00	0.06	-0.85	-0.58	-8.11	4.00	0.09	2.22	-0.07	-8.11	4.00	5.31	-0.19									
0.00	340.00	-20.63	0.53	-15.72	-22.71	4.00	0.00	340.00	0.06	-2.69	-0.19	-8.26	4.00	0.10	2.22	-0.07	-8.11	4.00	5.32	-0.19									
0.00	350.00	-11.49	1.39	-40.07	-17.13	4.00	0.00	350.00	-0.22	-5.39	-0.07	-8.69	4.00	0.09	2.22	-0.07	-8.11	4.00	5.31	-0.19									
15.00	0.00	-8.87	0.64	-3.83	-12.40	4.00	15.00	0.00	0.20	-16.86	-0.94	-13.49	4.00	0.71	0.72	0.86	-9.90	4.00	5.09	-0.36									
15.00	10.00	-11.03	-0.69	-2.50	-10.47	4.00	15.00	10.00	-1.10	-11.60	-1.25	-15.51	4.00	-0.59	-0.35	1.18	-9.29	4.00	4.57	-0.93									
15.00	20.00	-10.22	-3.12	-2.05	-11.21	4.00	15.00	20.00	-1.00	-10.84	-2.88	-15.23	4.00	-0.60	-2.44	0.57	-9.76	4.00	3.75	-1.73									
15.00	30.00	-6.71	-4.39	-0.47	-12.47	4.00	15.00	30.00	-1.39	-7.15	-5.69	-15.30	4.00	-0.27	-2.54	0.67	-10.65	4.00	3.78	-1.63									
15.00	40.00	-4.14	-3.71	0.41	-13.12	4.00	15.00	40.00	-2.51	-4.06	-8.44	-16.88	4.00	-0.24	-0.87	0.94	-11.59	4.00	4.23	-1.14									
15.00	50.00	-3.02	-3.03	0.57	-13.87	4.00	15.00	50.00	-4.41	-0.68	-17.53	-22.99	4.00	-0.65	1.31	0.64	-13.37	4.00	4.56	-0.68									
15.00	60.00	-2.81	-4.47	0.31	-12.39	4.00	15.00	60.00	-6.96	1.02	-16.55	-22.96	4.00	-1.40	2.10	0.40	-11.95	4.00	4.67	-0.57									
15.00	70.00	-3.05	-5.72	0.00	-12.50	4.00	15.00	70.00	-9.45	2.09	-14.70	-18.67	4.00	-2.15	2.76	0.14	-11.56	4.00	4.70	-0.46									
15.00	80.00	-1.96	-8.36	0.29	-11.55	4.00	15.00	80.00	-16.39	2.30	-12.89	-12.90	4.00	-1.81	2.66	0.49	-9.16	4.00	5.05	-0.29									
15.00	90.00	-2.33	-11.76	0.60	-11.73	4.00	15.00	90.00	-26.67	2.32	-12.73	-12.46	4.00	-2.31	2.49	0.80	-9.07	4.00	4.97	-0.36									
15.00	100.00	-2.11	-9.91	0.01	-12.47	4.00	15.00	100.00	-18.55	1.47	-10.35	-11.64	4.00	-2.01	1.78	0.39	-9.02	4.00	4.66	-0.77									
15.00	110.00	-2.15	-5.75	-0.27	-13.04	4.00	15.00	110.00	-13.04	0.29	-6.75	-10.91	4.00	-1.81	1.26	0.43	-8.87	4.00	4.56	-0.83									
15.00	120.00	-2.84	-3.97	-0.47	-11.43	4.00	15.00	120.00	-8.73	2.24	-6.75	-10.73	4.00	-1.84	-0.38	0.73	-8.06	4.00	4.12	-1.50									
15.00	130.00	-3.08	-5.67	-0.70	-10.54	4.00	15.00	130.00	-7.04	6.26	-6.15	-11.52	4.00	-1.61	-2.94	0.39	-7.99	4.00	3.48	-2.13									
15.00	140.00	-4.47	-6.03	-0.51	-10.99	4.00	15.00	140.00	-4.98	-7.04	-5.01	-12.36	4.00	-1.71	-3.50	0.81	-8.61	4.00	3.40	-2.10									
15.00	150.00	-6.22	-6.06	-0.75	-10.82	4.00	15.00	150.00	-3.87	-5.36	-3.03	-13.22	4.00	-1.88	-2.69	1.27	-8.85	4.00	3.69	-1.78									
15.00	160.00	-8.92	-2.67	-1.23	-8.90	4.00	15.00	160.00	-2.64	-4.85	-1.27	-11.69	4.00	-1.72	-0.61	1.76	-7.06	4.00	4.66	-0.92									
15.00	170.00	-12.15	-1.39	-2.83	-8.70	4.00	15.00	170.00	-1.83	-5.57	0.57	-12.43	4.00	-1.44	0.01	2.20	-5.77	4.00	5.05	-0.49									
15.00	180.00	-15.32	-0.14	-7.71	-8.37	4.00	15.00	180.00	-1.06	-7.72	0.54	-15.34	4.00	-0.90	0.56	1.15	-7.57	4.00	4.93	-0.67									
15.00	190.00	-14.51	-0.22	-13.33	-8.55	4.00	15.00	190.00	-0.23	-8.61	1.07	-14.92	4.00	-0.07	0.37	1.22	-7.65	4.00	5.11	-0.49									
15.00	200.00	-8.72	0.21	-18.81	-8.40	4.00	15.00	200.00	-0.28	-7.32	1.48	-17.66	4.00	0.30	0.92	1.52	-7.91	4.00	5.44	-0.12									
15.00	210.00	-4.35	-0.67	-14.80	-8.27	4.00	15.00	210.00	-1.16	-5.83	1.06	-17.99	4.00	0.54	0.49	1.17	-7.83	4.00	5.28	-0.31									
15.00	220.00	-3.31	-1.21	-8.74	-8.28	4.00	15.00	220.00	-1.41	-2.89	-0.37	-15.16	4.00	0.75															



45.00	190.00	-15.29	-7.56	-5.88	-5.06	4.00	45.00	190.00	0.37	-20.53	1.24	-26.92	4.00	0.49	-7.35	2.01	-5.03	4.00	4.37	-0.96
45.00	200.00	-10.73	-3.82	-8.28	-3.57	4.00	45.00	200.00	1.95	-9.66	1.29	-32.39	4.00	2.18	-2.81	1.74	-3.56	4.00	5.79	0.12
45.00	210.00	-5.50	-4.77	-13.00	-3.60	4.00	45.00	210.00	0.75	-5.97	1.06	-23.26	4.00	1.67	-2.32	1.23	-3.55	4.00	5.56	-0.19
45.00	220.00	-2.98	-6.32	-14.03	-4.50	4.00	45.00	220.00	0.84	-5.10	-0.13	-21.12	4.00	2.35	-2.66	0.04	-4.41	4.00	5.23	-0.42
45.00	230.00	-2.07	-4.60	-16.25	-5.46	4.00	45.00	230.00	-1.51	-5.67	-0.72	-18.75	4.00	1.23	-2.09	-0.60	-5.26	4.00	4.65	-1.09
45.00	240.00	-2.46	-4.07	-20.00	-5.86	4.00	45.00	240.00	-4.99	-3.86	-3.21	-18.45	4.00	-0.53	-0.95	-3.12	-5.63	4.00	3.69	-2.13
45.00	250.00	-2.80	-4.62	-14.54	-5.68	4.00	45.00	250.00	-10.55	-1.92	-6.87	-19.95	4.00	-2.13	-0.05	-5.83	-5.52	4.00	2.98	-2.71
45.00	260.00	-2.78	-4.76	-14.47	-5.90	4.00	45.00	260.00	-16.59	-0.48	-20.78	-16.93	4.00	-2.60	0.90	-13.56	-5.57	4.00	2.23	-2.80
45.00	270.00	-2.35	-6.99	-15.12	-4.72	4.00	45.00	270.00	-18.40	0.81	-17.40	-17.55	4.00	-2.24	1.48	-13.10	-4.50	4.00	2.84	-2.21
45.00	280.00	-1.55	-13.27	-16.40	-4.27	4.00	45.00	280.00	-13.14	1.13	-8.17	-22.36	4.00	-1.26	1.28	-7.56	-4.20	4.00	3.69	-1.79
45.00	290.00	-1.72	-14.07	-16.77	-2.28	4.00	45.00	290.00	-8.54	1.67	-4.79	-19.85	4.00	-0.80	1.78	-4.52	-2.20	4.00	4.86	-0.87
45.00	300.00	-2.39	-7.38	-23.57	-2.47	4.00	45.00	300.00	-5.94	0.06	-2.46	-17.47	4.00	-0.80	0.95	-2.43	-2.33	4.00	4.96	-0.93
45.00	310.00	-4.18	-5.63	-13.19	-1.67	4.00	45.00	310.00	-1.35	-0.77	-1.81	-20.78	4.00	0.47	0.46	-1.50	-3.82	4.00	5.53	-0.43
45.00	320.00	-6.31	-2.18	-6.89	-1.33	4.00	45.00	320.00	-1.54	-0.66	1.35	-17.64	4.00	-0.29	1.66	1.96	-1.23	4.00	6.64	0.72
45.00	330.00	-6.20	-4.84	-6.72	-0.75	4.00	45.00	330.00	-1.07	-3.67	0.97	-31.98	4.00	0.09	-1.21	1.65	-0.75	4.00	6.04	0.09
45.00	340.00	-11.42	-5.43	-4.21	-1.50	4.00	45.00	340.00	-0.46	-11.31	0.91	-12.08	4.00	0.73	-4.43	2.07	-1.14	4.00	5.66	-0.08
45.00	350.00	-18.83	-2.58	0.43	-3.47	4.00	45.00	350.00	-0.27	-21.71	1.24	-8.25	4.00	-0.21	-2.53	3.86	-2.22	4.00	6.15	0.56
60.00	0.00	-10.46	-0.93	-1.83	-0.85	4.00	60.00	0.00	0.54	-12.91	0.21	-19.55	4.00	0.87	-0.66	2.32	-0.79	4.00	6.55	0.63
60.00	10.00	-15.68	1.98	-0.22	-0.83	4.00	60.00	10.00	0.91	-4.79	-0.21	-22.43	4.00	1.00	2.81	2.80	-0.80	4.00	7.60	1.69
60.00	20.00	-15.75	1.33	-3.53	-2.59	4.00	60.00	20.00	1.13	-6.09	-0.98	-21.76	4.00	1.22	2.05	0.94	-2.54	4.00	6.60	0.73
60.00	30.00	-18.50	-2.72	-3.01	-6.86	4.00	60.00	30.00	-0.72	1.28	-6.96	-27.53	4.00	-0.65	2.74	-1.54	-6.82	4.00	5.09	-0.40
60.00	40.00	-17.10	-3.19	-4.61	-15.12	4.00	60.00	40.00	-2.63	-0.24	-5.75	-11.79	4.00	-2.48	1.54	-2.13	-10.13	4.00	3.64	-1.71
60.00	50.00	-11.38	-4.01	-7.79	-18.55	4.00	60.00	50.00	-4.11	-3.67	-8.93	-9.70	4.00	-3.36	-0.83	-5.31	-9.17	4.00	1.86	-3.71
60.00	60.00	-9.20	-8.18	-6.39	-17.95	4.00	60.00	60.00	-5.05	-1.67	-22.63	-15.17	4.00	-3.64	-0.79	-6.29	-13.33	4.00	1.10	-4.13
60.00	70.00	-8.71	-19.31	-5.32	-26.19	4.00	60.00	70.00	-7.21	0.80	-11.33	-11.58	4.00	-4.89	-3.20	-5.20	3.20	4.00	4.23	-0.98
60.00	80.00	-9.27	-15.23	-6.11	-34.57	4.00	60.00	80.00	-11.73	0.39	-10.59	-13.18	4.00	-7.32	0.51	-6.10	-13.15	4.00	0.85	-3.97
60.00	90.00	-7.78	-15.22	-6.76	-17.57	4.00	60.00	90.00	-21.23	-0.56	-15.67	-15.31	4.00	-7.59	-0.41	-6.20	-13.28	4.00	0.33	-4.65
60.00	100.00	-7.15	-18.64	-7.65	-15.40	4.00	60.00	100.00	-11.46	-3.64	-11.78	-21.84	4.00	-5.78	-3.47	-6.23	-14.51	4.00	-0.63	-6.07
60.00	110.00	-6.19	-13.66	-6.66	-14.66	4.00	60.00	110.00	-5.05	-3.64	-9.23	-23.76	4.00	-2.57	-3.23	-4.75	-14.16	4.00	0.86	-4.55
60.00	120.00	-5.17	-11.54	-3.75	-12.91	4.00	60.00	120.00	-1.64	-0.47	-9.90	-17.82	4.00	-0.05	-12.04	-2.81	-11.69	4.00	3.41	-1.96
60.00	130.00	-5.99	-9.92	-3.73	-8.38	4.00	60.00	130.00	-0.61	-1.18	-9.23	-22.18	4.00	0.50	-0.64	-2.65	-8.20	4.00	3.85	-1.74
60.00	140.00	-12.62	-4.86	-2.15	-5.93	4.00	60.00	140.00	-0.28	-6.06	-2.58	-16.06	4.00	-0.03	-2.41	0.65	-5.53	4.00	4.51	-1.24
60.00	150.00	-17.42	-5.80	-3.40	-3.87	4.00	60.00	150.00	-0.15	-7.74	-4.30	-14.12	4.00	-0.07	-3.65	-0.82	-3.92	4.00	4.16	-1.72
60.00	160.00	-20.87	-7.03	-3.93	-3.12	4.00	60.00	160.00	-1.90	-12.92	-2.32	-16.42	4.00	-1.85	-6.61	-0.04	-2.48	4.00	3.48	-2.27
60.00	170.00	-26.43	-2.87	-12.37	-3.45	4.00	60.00	170.00	-2.10	-12.94	-2.19	-21.61	4.00	-2.08	-3.59	0.00	-3.88	4.00	3.24	-2.19
60.00	180.00	-22.60	-9.85	-6.04	-2.68	4.00	60.00	180.00	-0.46	-21.08	-1.72	-23.69	4.00	-0.43	-9.53	0.00	2.61	4.00	3.59	1.94
60.00	190.00	-16.16	-6.33	-6.95	-1.92	4.00	60.00	190.00	-0.09	-16.78	-0.68	-39.75	4.00	0.02	-5.96	0.29	-1.92	4.00	4.46	-1.29
60.00	200.00	-11.61	-5.88	-6.82	-2.22	4.00	60.00	200.00	-0.89	-14.97	-0.73	-24.80	4.00	-0.54	-5.20	0.23	-2.20	4.00	4.33	-1.48
60.00	210.00	-8.75	-4.96	-7.76	-3.45	4.00	60.00	210.00	-0.15	-9.81	-1.30	-33.34	4.00	0.41	-3.73	0.42	-3.45	4.00	4.42	-1.42
60.00	220.00	-4.38	-4.01	-10.27	-3.88	4.00	60.00	220.00	-1.29	-6.07	-1.39	-26.82	4.00	0.44	-1.91	-0.86	-3.86	4.00	4.61	-1.27
60.00	230.00	-3.38	-4.13	-11.06	-4.22	4.00	60.00	230.00	-1.52	-5.91	-1.91	-24.77	4.00	0.66	-1.92	-1.41	-4.18	4.00	4.48	-1.38
60.00	240.00	-3.54	-3.45	-13.28	-3.66	4.00	60.00	240.00	-3.79	-7.77	-3.82	-22.25	4.00	-0.65	-2.08	-3.35	-3.60	4.00	3.68	-2.26
60.00	250.00	-5.14	-6.10	-9.75	-3.23	4.00	60.00	250.00	-7.86	-4.88	-6.77	-18.24	4.00	-3.28	-2.44	-5.00	-3.10	4.00	2.62	-3.36
60.00	260.00	-7.14	-11.62	-10.23	-1.77	4.00	60.00	260.00	-10.59	-3.16	-14.76	-14.95	4.00	-5.52	-2.58	-8.92	-1.57	4.00	1.82	-3.82
60.00	270.00	-8.82	-16.35	-9.98	-0.99	4.00	60.00	270.00	-15.27	-2.04	-16.89	-16.79	4.00	-7.93	-1.88	-9.17	-0.88	4.00	1.79	-3.60
60.00	280.00	-10.33	-10.29	-9.28	-0.93	4.00	60.00	280.00	-17.76	-0.66	-7.81	-13.17	4.00	-9.61	-0.21	-5.47	-0.68	4.00	2.81	-2.59
60.00	290.00	-7.38	-10.63	-9.12	-0.89	4.00	60.00	290.00	-11.02	-0.01	-3.25	-10.73	4.00	-5.82	0.35	-2.25	-0.46	4.00	4.28	-1.49
60.00	300.00	-5.04	-15.27	-7.81	-1.23	4.00	60.00	300.00	-6.95	0.60	-1.78	-10.75	4.00	-2.88	0.71	-0.81	-1.07	4.00	5.17	-0.76
60.00	310.00	-5.28	-6.84	-6.94	-1.17	4.00	60.00	310.00	-4.80	0.92	-1.33	-18.38	4.00	-2.02	1.59	-0.28	-0.79	4.00	5.68	-0.24
60.00	320.00	-8.10	-2.56	-4.87	-1.26	4.00	60.00	320.00	-2.34	-1.87	1.33	-16.50	4.00	-1.32	0.81	2.26	-1.13	4.00	6.30	0.41
60.00	330.00	-6.41	-3.52	-3.06	0.72	4.00	60.00	330.00	-0.90	-3.87	0.53	-23.29	4.00	0.18	-0.68	2.11	0.74	4.00	6.67	0.71
60.00	340.00	-12.48	-4.54	-3.33	-0.11	4.00	60.00	340.00	0.93	-10.31	0.73	-14.63	4.00	1.12	-3.52	2.17	0.04	4.00	6.22	0.41
60.00	350.00	-11.68	0.01	-1.74	0.01	4.00	60.00	350.00	1.81	-9.90	1.55	-12.90	4.00	2.00	4.43	3.22	1.18	4.00	7.79	1.83
75.00	0.00	-9.10	-0.82	-4.73	0.86	4.00	75.00	0.00	1.78	-18.03	0.02	-17.81	4.00	2.12	-0.74	1.27	0.92	4.00	6.98	1.01
75.00	10.00	-14.28	1.34	-2.62	-0.85	4.00	75.00	10.00	2.11	-15.38	-1.24	-23.18	4.00	2.21	1.43	1.13	-0.82	4.00	7.08	1.12
75.00	20.00	-18.99	-0.95	-6.73	-3.33	4.00	75.00	20.00	1.50	-7.46	-3.23	-19.74	4.00	1.54	-0.07	-1.63	-3.23	4.00	5.35	-0.49
75.00	30.00	-13.49	-4.77	-3.74	-1.95	4.00	75.00	30.00	-0.66	-3.18	-4.67	-13.42	4.00	-0.44	-0.73	-3.17	-6.87	4.00	4.08	-1.68
75.00	40.00	-12.97	-5.66	-1.30	-4.00	4.00	75.00	40.00	-0.96	-2.34	-6.93	-20.93	4.00	-0.84	-0.38	-3.24	-10.58	4.00	3.14	-2.32
75.00	50.00	-10.96	-11.61	-6.61	-16.43	4.00	75.00	50.00	-2.09	-6.43	-6.52	-19.90	4.00	-1.01	-3.03	-1.45	-14.82	4.00	1.71	-0.87
75.00	60.00	-7.39	-7.81	-36.67	4.00	75.00	60.00	-7.09	-6.19	-10.16	-22.05	4.00	-0.97	-5.98	-5.82	-21.90	4.00	-0.04	-2.81	-4.81
75.00	70.00	-8.25	-10.57	-9.14	-14.49	4.00	75.00	70.00	-3.44	-3.31	-11.71	-14.84	4.00	-2.20	-2.56	-7.23	-11.65	4.00		



105.00	100.00	-6.13	-18.57	-12.99	-18.14	4.00	105.00	100.00	-14.33	-7.16	-18.38	-15.97	4.00	-5.52	-6.86	-11.89	-13.91	4.00	-2.85	-8.30	
105.00	110.00	-11.27	-9.61	-25.42	-18.44	4.00	105.00	110.00	-7.69	-14.01	-10.57	-10.68	4.00	-6.11	-8.26	-10.43	-10.01	4.00	-2.51	-8.75	
105.00	120.00	-13.94	-11.25	-14.56	-11.03	4.00	105.00	120.00	-9.35	-7.25	-9.55	-8.33	4.00	-8.05	-5.79	-8.36	-6.46	4.00	-1.08	-7.04	
105.00	130.00	-11.71	-11.94	-14.94	-6.02	4.00	105.00	130.00	-9.38	-27.46	-13.61	-11.21	4.00	-7.38	-11.82	-11.21	-4.87	4.00	-2.33	-7.89	
105.00	140.00	-15.36	-10.53	-13.08	-2.78	4.00	105.00	140.00	-6.60	-18.84	-10.01	-18.58	4.00	-6.06	-9.93	-8.27	-2.67	4.00	-0.27	-5.85	
105.00	150.00	-20.08	-7.20	-12.16	-0.78	4.00	105.00	150.00	-7.84	-13.30	-25.79	-15.46	4.00	-7.59	-6.25	-11.98	-0.63	4.00	0.37	-4.75	
105.00	160.00	-14.15	-5.52	-9.19	0.03	4.00	105.00	160.00	-6.76	-24.55	-20.58	-14.65	4.00	-6.03	-5.47	-8.89	-0.18	4.00	1.63	-3.71	
105.00	170.00	-15.90	-4.85	-8.57	1.38	4.00	105.00	170.00	-4.46	-15.67	-19.98	-14.06	4.00	-4.16	-4.50	-8.27	1.50	4.00	2.89	-2.40	
105.00	180.00	-21.50	-12.64	-6.13	2.14	4.00	105.00	180.00	-4.29	-18.83	-12.33	-13.63	4.00	-4.21	-11.70	-5.20	2.25	4.00	2.68	-2.17	
105.00	190.00	-20.44	-13.25	-5.24	3.78	4.00	105.00	190.00	-7.06	-17.70	-10.91	-13.00	4.00	-6.87	-11.92	-4.20	3.87	4.00	3.18	-1.12	
105.00	200.00	-11.74	-9.27	-5.87	4.06	4.00	105.00	200.00	-9.34	-13.00	-11.85	-11.69	4.00	-7.37	-7.74	-4.89	4.17	4.00	3.59	-0.85	
105.00	210.00	-10.50	-15.21	-3.25	3.75	4.00	105.00	210.00	-10.79	-14.05	-9.51	-20.49	4.00	-7.63	-11.74	-2.59	3.72	4.00	3.46	1.00	
105.00	220.00	-13.13	-22.61	-4.01	2.49	4.00	105.00	220.00	-4.82	-18.60	-6.23	-14.66	4.00	-4.22	-11.15	-1.97	2.57	4.00	3.21	1.49	
105.00	230.00	-12.35	-14.85	-2.48	1.46	4.00	105.00	230.00	-5.45	-11.96	-4.99	-17.10	4.00	-3.92	-10.16	-0.55	1.52	4.00	3.74	-1.54	
105.00	240.00	-16.94	-14.15	-3.64	-0.97	4.00	105.00	240.00	-7.29	-8.20	-5.58	-20.68	4.00	-6.84	-7.22	-1.49	-0.92	4.00	2.38	-3.20	
105.00	250.00	-32.54	-10.83	-2.85	-1.39	4.00	105.00	250.00	-16.35	-5.65	-12.33	-19.10	4.00	-16.25	-4.50	-2.39	-1.32	4.00	1.47	-3.73	
105.00	260.00	-33.65	-10.15	-3.26	1.23	4.00	105.00	260.00	-19.87	-5.98	-16.92	-19.63	4.00	-19.69	-4.57	-3.08	1.27	4.00	2.12	-2.62	
105.00	270.00	-17.42	-12.20	-2.78	2.88	4.00	105.00	270.00	-11.41	-5.43	-29.80	-18.25	4.00	-10.44	-4.60	-2.77	2.91	4.00	3.56	-1.37	
105.00	280.00	-9.86	-18.96	-2.77	3.94	4.00	105.00	280.00	-7.61	-5.11	-16.70	-16.28	4.00	-5.58	-4.93	-2.60	3.98	4.00	4.65	-0.40	
105.00	290.00	-8.85	-13.39	-2.58	4.98	4.00	105.00	290.00	-4.99	-5.92	-8.74	-15.41	4.00	-3.49	-5.20	-1.64	5.02	4.00	5.64	0.62	
105.00	300.00	-12.21	-13.55	-2.67	4.56	4.00	105.00	300.00	-3.21	-11.63	-4.78	-18.02	4.00	-2.70	-9.47	-0.59	4.58	4.00	5.34	0.41	
105.00	310.00	-12.97	-10.75	-3.18	2.83	4.00	105.00	310.00	-3.07	-10.81	-3.95	-16.21	4.00	-2.65	-7.77	-0.54	2.88	4.00	4.81	-0.53	
105.00	320.00	-11.45	-6.14	-5.64	0.09	4.00	105.00	320.00	-6.88	-6.23	-1.74	-15.57	4.00	-5.58	-3.17	-0.26	0.21	4.00	4.12	-1.63	
105.00	330.00	-10.17	-4.16	-5.88	-1.34	4.00	105.00	330.00	-5.29	-5.50	-1.37	-15.82	4.00	-4.07	-1.77	-0.05	-1.19	4.00	4.37	-1.54	
105.00	340.00	-14.23	-4.67	-7.51	-1.14	4.00	105.00	340.00	-4.12	-7.77	-1.52	-12.16	4.00	-3.72	-2.94	-0.54	-0.81	4.00	4.12	-1.80	
105.00	350.00	-11.78	-4.50	-7.95	0.74	4.00	105.00	350.00	-5.78	-6.17	-2.06	-18.94	4.00	-4.81	-2.24	-1.06	0.79	4.00	4.42	-1.38	
120.00	0.00	-10.92	-11.12	-11.96	-2.61	4.00	120.00	0.00	-6.39	-4.49	-1.35	-23.97	4.00	-5.08	-3.64	-0.99	-2.58	4.00	3.08	-2.81	
120.00	10.00	-12.22	-4.09	-12.15	-0.79	4.00	120.00	10.00	-3.55	-12.95	-4.75	-17.13	4.00	-3.00	-3.56	-4.02	-0.69	4.00	3.00	-2.61	
120.00	20.00	-10.71	-4.70	-8.18	-3.90	4.00	120.00	20.00	-5.01	-7.20	-4.87	-11.79	4.00	-3.97	-2.76	-3.21	-3.25	4.00	2.73	-3.28	
120.00	30.00	-11.22	-4.05	-14.00	-7.93	4.00	120.00	30.00	-8.02	-5.70	-8.19	-6.84	4.00	-6.32	-1.79	-7.18	-4.34	4.00	1.37	-4.39	
120.00	40.00	-10.98	-4.51	-7.00	-8.45	4.00	120.00	40.00	-12.68	-2.60	-9.83	-11.04	4.00	-8.74	-0.44	-5.18	-1.65	4.00	1.36	-4.08	
120.00	50.00	-5.20	-2.78	-11.03	-8.74	4.00	120.00	50.00	-9.41	0.74	-10.67	-16.65	4.00	-3.80	2.34	-7.84	-8.09	4.00	2.78	-2.13	
120.00	60.00	-6.64	-11.61	-18.18	-14.81	4.00	120.00	60.00	-5.13	-15.34	-4.23	-13.80	4.00	-2.81	-10.08	-4.06	-11.27	4.00	-0.28	-5.65	
120.00	70.00	-7.82	-26.51	-22.29	2.90	4.00	120.00	70.00	-14.66	0.22	-7.66	-13.70	4.00	-7.00	1.05	-7.60	-13.14	4.00	0.88	-3.73	
120.00	80.00	-22.58	-11.21	-24.56	-26.04	4.00	120.00	80.00	-8.31	-4.84	-8.24	-10.12	4.00	-8.15	-3.94	-6.84	-2.33	4.00	3.24	-7.90	
120.00	90.00	-5.44	-11.76	-23.48	-15.77	4.00	120.00	90.00	-7.35	-9.63	-5.05	-19.61	4.00	-3.28	-7.56	-4.99	-14.27	4.00	-0.63	6.02	
120.00	100.00	-5.28	-11.09	-18.90	-25.46	4.00	120.00	100.00	-9.06	-4.69	-9.63	-10.80	4.00	-3.76	-3.79	-9.14	-10.65	4.00	-0.28	-5.83	
120.00	110.00	-12.13	-11.46	-14.05	-19.88	4.00	120.00	110.00	-19.83	-15.34	-11.02	-8.71	4.00	-11.45	-9.97	-9.27	-8.39	4.00	-3.68	-9.63	
120.00	120.00	-18.24	-11.46	-12.42	-12.07	4.00	120.00	120.00	-9.71	-8.87	-8.48	-14.40	4.00	-9.14	-6.96	-7.01	-10.07	4.00	-2.17	-8.09	
120.00	130.00	-14.86	-25.83	-13.20	-8.19	4.00	120.00	130.00	-10.15	-9.35	-18.56	-15.82	4.00	-8.89	-9.25	-12.09	-7.50	4.00	-3.26	-9.14	
120.00	140.00	-9.44	-7.55	-12.15	-4.53	4.00	120.00	140.00	-14.29	-12.29	-18.37	-17.47	4.00	-8.21	-6.29	-14.22	-4.31	4.00	-1.13	-6.82	
120.00	150.00	-16.97	-12.22	-13.84	-4.45	4.00	120.00	150.00	-10.14	-26.15	-8.03	-12.15	4.00	-9.32	-12.05	-7.02	-3.77	4.00	-1.49	-7.00	
120.00	160.00	-12.80	-4.11	-11.47	-0.20	4.00	120.00	160.00	-4.99	-16.10	-14.52	-14.56	4.00	-4.32	-3.84	-9.72	-0.10	4.00	2.18	-3.28	
120.00	170.00	-11.92	-3.67	-10.51	0.80	4.00	120.00	170.00	-8.61	-29.09	-10.83	-13.93	4.00	-6.95	-3.66	-7.66	0.94	4.00	2.39	-2.91	
120.00	180.00	-10.66	-8.31	-8.23	1.88	4.00	120.00	180.00	-15.04	-15.18	-11.64	-11.45	4.00	-9.31	-7.50	-15.60	2.08	4.00	1.95	-2.74	
120.00	190.00	-20.01	-15.26	-6.59	2.55	4.00	120.00	190.00	-12.22	-20.73	-6.71	-13.20	4.00	-11.55	-14.18	-3.64	2.66	4.00	1.86	-2.24	
120.00	200.00	-11.84	-19.37	-4.73	2.43	4.00	120.00	200.00	-8.63	-9.30	-7.77	-12.12	4.00	-6.93	-8.89	-2.98	2.58	4.00	3.12	-1.79	
120.00	210.00	-15.07	-10.80	-3.31	2.32	4.00	120.00	210.00	-5.15	-10.58	-5.31	-23.12	4.00	-4.73	-7.68	-1.19	2.33	4.00	4.01	-1.28	
120.00	220.00	-27.90	-15.26	-3.97	1.18	4.00	120.00	220.00	-7.64	-9.85	-3.69	-22.96	4.00	-7.60	-2.20	-8.75	-0.82	1.20	4.00	3.05	-2.12
120.00	230.00	-21.11	-17.60	-3.33	-1.31	4.00	120.00	230.00	-11.18	-5.28	-7.15	-19.63	4.00	-10.76	-5.03	-1.82	-1.25	4.00	2.03	-3.45	
120.00	240.00	-13.71	-18.79	-3.73	-4.90	4.00	120.00	240.00	-9.94	-4.82	-8.08	-13.67	4.00	-8.42	-4.65	-2.37	-4.36	4.00	1.33	-4.46	
120.00	250.00	-14.99	-19.13	-3.87	-4.92	4.00	120.00	250.00	-12.29	-9.93	-10.21	-11.70	4.00	-10.42	-9.44	-2.96	-4.09	4.00	-0.11	-5.61	
120.00	260.00	-11.86	-25.92	-3.25	-1.17	4.00	120.00	260.00	-10.44	-17.64	-9.41	-14.81	4.00	-8.08	-17.04	-2.31	-3.99	4.00	0.81	-4.09	
120.00	270.00	-11.64	-12.22	-3.37	1.40	4.00	120.00	270.00	-9.10	-16.16	-12.66	-16.67	4.00	-7.18	-10.75	-2.89	1.47	4.00	2.38	-2.61	
120.00	280.00	-9.86	-5.97	-2.00	2.69	4.00	120.00	280.00	-9.63	-13.84	-11.92	-11.91	4.00	-6.73	-5.31	-9.58	2.84	4.00	4.15	-1.07	
120.00	290.00	-6.77	-5.13	-1.36	2.94	4.00	120.00	290.00	-8.08	-17.90	-6.00	-11.16	4.00	-4.37	-4.91	-0.08	3.11	4.00	5.09	-0.32	
120.00	300.00	-6.74	-4.65	-2.47	2.44	4.00	120.00	300.00	-5.29	-11.54	-1.17	-16.22	4.00	-2.94	-3.84	1.24	2.50	4.00	5.67	0.03	
120.00	310.00	-9.96	-4.96	-1.14	1.40	4.00	120.00	310.00	-5.45	-6.58	-0.20	-12.72	4.00	-4.13	-2.52	3.79	1.01	4.00	5.36	-0.37	
120.00	320.00	-17.24	-8.13	-3.56	-0.65	4.00	120.00	320.00	-8.94	-0.60	-0.60	-17.74	4.00	-7.63	-6.45	0.75	-0.32	4.00	4.15	-1.46	
120.00	330.00	-24.34	-3.18	-13.60	-3.98	4.00	120.00	330.00	-6.20	-0.75	-0.51	-16.76	4.00								



165.00	10.00	-11.24	-0.75	-19.52	-19.83	4.00		165.00	10.00	-9.93	-13.65	-7.72	-10.09	4.00	-7.53	-0.53	-7.44	-9.65	4.00	0.48	-4.72
165.00	20.00	-14.30	0.85	-16.12	-25.11	4.00		165.00	20.00	-11.53	-8.77	-7.54	-11.10	4.00	-9.69	1.30	-6.98	-10.93	4.00	0.91	-3.62
165.00	30.00	-17.23	-1.88	-10.41	-25.92	4.00		165.00	30.00	-11.52	-5.33	-7.34	-10.52	4.00	-10.49	-0.26	-5.60	-10.40	4.00	0.41	-4.57
165.00	40.00	-19.30	-10.27	-9.68	-23.06	4.00		165.00	40.00	-14.41	-7.30	-9.36	-9.75	4.00	-13.19	-5.53	-6.51	-9.55	4.00	-2.19	-7.81
165.00	50.00	-18.44	-19.87	-9.41	-21.72	4.00		165.00	50.00	-21.16	-10.60	-15.53	-11.47	4.00	-16.58	-10.11	-8.46	-11.08	4.00	-5.06	-10.71
165.00	60.00	-21.93	-16.37	-10.73	-36.08	4.00		165.00	60.00	-23.29	-6.13	-26.94	-16.45	4.00	-19.55	-5.74	-10.63	-16.40	4.00	-5.45	-10.14
165.00	70.00	-16.89	-27.78	-13.49	-23.93	4.00		165.00	70.00	-22.62	-1.83	-14.95	-15.22	4.00	-15.86	-1.82	-11.15	-14.67	4.00	-2.89	-7.02
165.00	80.00	-14.87	-18.83	-18.81	-20.80	4.00		165.00	80.00	-16.14	-1.16	-12.78	-14.15	4.00	-12.45	-1.09	-11.81	-13.30	4.00	-1.97	-6.25
165.00	90.00	-15.41	-12.26	-14.76	-17.74	4.00		165.00	90.00	-17.93	-1.51	-14.50	-17.09	4.00	-13.48	-1.16	-11.62	-14.39	4.00	-2.27	-6.40
165.00	100.00	-15.36	-9.63	-12.67	-15.43	4.00		165.00	100.00	-23.80	-3.44	-15.77	-17.09	4.00	-14.78	-2.50	-10.94	-13.17	4.00	-2.88	-7.42
165.00	110.00	-16.73	-9.83	-11.68	-11.35	4.00		165.00	110.00	-21.05	-7.82	-12.88	-20.79	4.00	-15.36	-5.58	-9.23	-10.88	4.00	-3.56	-8.97
165.00	120.00	-14.32	-15.71	-11.68	-11.94	4.00		165.00	120.00	-20.35	-9.63	-9.87	-25.53	4.00	-13.35	-8.67	-7.67	-11.75	4.00	-4.05	-9.79
165.00	130.00	-15.37	-20.86	-10.72	-13.40	4.00		165.00	130.00	-14.60	-9.43	-8.20	-28.41	4.00	-11.96	-9.13	-6.27	-13.27	4.00	-3.71	-9.31
165.00	140.00	-14.82	-10.81	-13.29	-16.05	4.00		165.00	140.00	-15.25	-9.25	-5.95	-24.08	4.00	-12.02	-6.95	-5.21	-15.42	4.00	-2.99	-8.28
165.00	150.00	-15.60	-7.53	-14.16	-26.48	4.00		165.00	150.00	-12.51	-8.45	-4.70	-20.91	4.00	-10.78	-4.96	-4.23	-19.85	4.00	-2.10	-7.04
165.00	160.00	-14.15	-6.58	-13.91	-33.53	4.00		165.00	160.00	-14.44	-7.51	-5.31	-17.93	4.00	-11.28	-4.01	-4.75	-17.81	4.00	-1.88	-6.87
165.00	170.00	-13.70	-8.40	-11.98	-18.85	4.00		165.00	170.00	-12.25	-9.41	-5.91	-14.78	4.00	-9.90	-5.87	-4.95	-13.34	4.00	-1.89	-7.40
165.00	180.00	-13.11	-18.48	-11.10	-22.89	4.00		165.00	180.00	-11.51	-15.83	-8.40	-13.29	4.00	-9.23	-13.95	-6.53	-12.84	4.00	-4.11	-9.65
165.00	190.00	-7.83	-14.71	-8.02	-19.27	4.00		165.00	190.00	-12.95	-21.62	-8.90	-17.18	4.00	-6.67	-13.90	-5.43	-15.09	4.00	-3.24	-8.43
165.00	200.00	-5.20	-12.96	-6.89	-18.40	4.00		165.00	200.00	-23.60	-15.20	-9.66	-16.06	4.00	-5.14	-10.93	-5.05	-14.06	4.00	-1.97	-7.33
165.00	210.00	-6.01	-13.86	-8.03	-21.77	4.00		165.00	210.00	-28.70	-7.92	-11.39	-19.00	4.00	-5.99	-6.93	-6.38	-17.16	4.00	-2.10	-7.55
165.00	220.00	-5.45	-17.45	-9.99	-20.84	4.00		165.00	220.00	-20.85	-3.93	-16.59	-17.32	4.00	-5.33	-3.74	-9.13	-15.72	4.00	-1.39	-6.65
165.00	230.00	-6.77	-20.37	-11.64	-16.04	4.00		165.00	230.00	-12.86	-2.72	-14.59	-13.07	4.00	-5.81	-2.65	-9.86	-11.30	4.00	-0.71	-6.09
165.00	240.00	-7.60	-27.01	-14.26	-15.33	4.00		165.00	240.00	-11.96	-2.85	-10.84	-11.95	4.00	-6.24	-2.83	-9.21	-10.31	4.00	-0.63	-6.15
165.00	250.00	-11.37	-19.41	-17.31	-14.95	4.00		165.00	250.00	-9.45	-3.17	-11.72	-9.55	4.00	-7.29	-3.07	-10.66	-8.45	4.00	-0.89	-6.44
165.00	260.00	-21.18	-14.46	-22.13	-13.21	4.00		165.00	260.00	-7.72	-5.21	-9.78	-7.60	4.00	-7.53	-4.72	-9.53	-6.55	4.00	-0.89	-6.74
165.00	270.00	-32.75	-12.49	-18.78	-15.26	4.00		165.00	270.00	-6.32	-8.63	-8.69	-7.33	4.00	-6.31	-7.13	-8.28	-6.68	4.00	-1.05	-7.04
165.00	280.00	-14.99	-10.09	-25.30	-12.43	4.00		165.00	280.00	-6.50	-18.54	-6.93	-5.23	4.00	-5.92	-9.51	-6.87	-4.47	4.00	-0.49	-6.33
165.00	290.00	-10.78	-9.77	-17.97	-10.71	4.00		165.00	290.00	-5.64	-25.20	-5.58	-4.74	4.00	-4.48	-9.65	-5.34	-3.76	4.00	0.49	-5.31
165.00	300.00	-10.71	-7.72	-18.03	-17.24	4.00		165.00	300.00	-5.87	-20.29	-5.81	-7.25	4.00	-4.64	-30.49	-5.56	-4.23	4.00	0.63	-5.31
165.00	310.00	-14.25	-3.95	-16.24	-6.34	4.00		165.00	310.00	-6.67	-9.57	-6.50	-7.85	4.00	-5.97	-2.90	-6.06	-4.02	4.00	1.39	-4.53
165.00	320.00	-17.57	-1.51	-14.80	-5.29	4.00		165.00	320.00	-7.29	-10.15	-5.70	-11.60	4.00	-6.90	-0.95	-5.20	-4.38	4.00	1.94	-3.78
165.00	330.00	-21.01	-0.15	-24.29	-5.65	4.00		165.00	330.00	-6.07	-13.53	-4.22	-12.44	4.00	-5.93	0.04	-4.18	-4.82	4.00	2.61	-3.06
165.00	340.00	-19.03	-0.88	-14.15	-8.00	4.00		165.00	340.00	-7.19	-17.21	-4.53	-8.95	4.00	-6.91	-0.78	-4.08	-5.44	4.00	2.02	-3.68
165.00	350.00	-16.79	-6.58	-11.52	-9.32	4.00		165.00	350.00	-8.04	-19.26	-4.69	-7.57	4.00	-7.50	-6.35	-3.87	-6.35	4.00	0.36	-5.56
180.00	0.00	-16.40	-4.39	-10.71	-7.94	4.00		180.00	0.00	-12.95	-15.73	-30.13	-12.74	4.00	-11.33	-4.08	-10.66	-6.70	4.00	-1.66	-7.19
180.00	10.00	-14.51	-4.12	-10.68	-7.23	4.00		180.00	10.00	-14.18	-25.00	-34.02	-16.06	4.00	-11.33	-4.08	-10.66	-6.70	4.00	-1.66	-7.19
180.00	20.00	-13.18	-4.12	-10.92	-6.83	4.00		180.00	20.00	-15.93	-25.57	-23.05	-21.99	4.00	-11.33	-4.09	-10.66	-6.70	4.00	-1.66	-7.19
180.00	30.00	-12.26	-4.38	-11.44	-6.70	4.00		180.00	30.00	-18.47	-15.92	-18.51	-46.70	4.00	-11.33	-4.09	-10.66	-6.70	4.00	-1.66	-7.19
180.00	40.00	-11.68	-4.93	-12.28	-6.83	4.00		180.00	40.00	-22.48	-11.62	-15.73	-21.82	4.00	-11.33	-4.09	-10.66	-6.69	4.00	-1.66	-7.19
180.00	50.00	-11.38	-5.80	-13.51	-7.24	4.00		180.00	50.00	-30.82	-8.95	-13.84	-15.97	4.00	-11.33	-4.09	-10.66	-6.69	4.00	-1.66	-7.19
180.00	60.00	-11.35	-7.07	-15.26	-7.95	4.00		180.00	60.00	-34.64	-7.12	-12.52	-12.69	4.00	-11.33	-4.09	-10.66	-6.69	4.00	-1.66	-7.19
180.00	70.00	-11.59	-8.88	-17.79	-9.02	4.00		180.00	70.00	-37.71	-5.84	-11.60	-10.52	4.00	-11.33	-4.09	-10.66	-6.70	4.00	-1.66	-7.19
180.00	80.00	-12.11	-11.51	-21.80	-10.55	4.00		180.00	80.00	-19.17	-4.95	-11.01	-9.00	4.00	-11.33	-4.08	-10.66	-6.70	4.00	-1.66	-7.19
180.00	90.00	-12.95	-15.73	-30.13	-12.74	4.00		180.00	90.00	-16.40	-4.39	-10.71	-7.94	4.00	-11.33	-4.08	-10.66	-6.70	4.00	-1.66	-7.19
180.00	100.00	-14.18	-25.00	-34.02	-16.06	4.00		180.00	100.00	-14.51	-4.12	-10.68	-7.23	4.00	-11.33	-4.08	-10.66	-6.70	4.00	-1.66	-7.19
180.00	110.00	-15.93	-25.57	-23.05	-21.99	4.00		180.00	110.00	-11.59	-8.88	-17.79	-9.02	4.00	-11.33	-4.09	-10.66	-6.70	4.00	-1.66	-7.19
180.00	120.00	-18.47	-15.92	-18.51	-46.70	4.00		180.00	120.00	-12.26	-4.38	-11.44	-6.70	4.00	-11.33	-4.09	-10.66	-6.70	4.00	-1.66	-7.19
180.00	130.00	-22.48	-11.62	-15.73	-21.82	4.00		180.00	130.00	-11.68	-4.93	-12.28	-6.83	4.00	-11.33	-4.09	-10.66	-6.69	4.00	-1.66	-7.19
180.00	140.00	-30.82	-8.95	-13.84	-15.97	4.00		180.00	140.00	-11.38	-5.80	-13.51	-7.24	4.00	-11.33	-4.09	-10.66	-6.69	4.00	-1.66	-7.19
180.00	150.00	-34.64	-7.12	-12.52	-12.69	4.00		180.00	150.00	-11.35	-7.07	-15.26	-7.95	4.00	-11.33	-4.08	-10.66	-6.69	4.00	-1.66	-7.19
180.00	160.00	-23.71	-5.84	-11.60	-10.52	4.00		180.00	160.00	-11.59	-8.88	-17.79	-9.02	4.00	-11.33	-4.09	-10.66	-6.70	4.00	-1.66	-7.19
180.00	170.00	-19.17	-4.95	-11.01	-9.00	4.00		180.00	170.00	-12.11	-11.51	-21.80	-10.55	4.00	-11.33	-4.08	-10.66	-6.70	4.00	-1.66	-7.19
180.00	180.00	-16.40	-4.39	-10.71	-7.94	4.00		180.00	180.00	-12.95	-15.73	-30.13	-12.74	4.00	-11.33	-4.08	-10.66	-6.70	4.00	-1.66	-7.19
180.00	190.00	-14.51	-4.12	-10.68	-7.23	4.00		180.00	190.00	-14.18	-25.00	-34.02	-16.06	4.00	-11.33	-4.09	-10.66	-6.70	4.00	-1.66	-7.19
180.00	200.00	-13.18	-4.12	-10.92	-6.83	4.00		180.00	200.00	-15.93	-25.57	-23.05	-21.99	4.00	-11.33	-4.09	-10.66	-6.70	4.00	-1.66	-7.19
180.00	210.00	-12.26	-4.38	-11.44	-6.70	4.00		180.00	210.00	-18.47	-15.92	-18.51	-46.70	4.00	-11.33	-4.09	-10.66	-6.70	4.00	-1.66	-7.19
180.00	220.00	-11.68	-4.93	-12.28	-6.83	4.00		180.00	220.00	-22.48	-11.62	-15.73	-21.82	4.00	-11.33	-4.09	-10.66	-6.69	4.00	-1.66	-7.19



Frequency: 6415MHz

Theta Polarization		Max Gain(dBi)				Nant	Phi Polarization		Max Gain(dBi)				Nant	Total				Max DG(dBi)	Max Dg(dBi)				
Angle (θ)	Angle (ψ)	Ant 1(G1)	Ant 2(G2)	Ant 3(G3)	Ant 4(G4)		Angle (θ)	Angle (ψ)	Ant 1(G1)	Ant 2(G2)	Ant 3(G3)	Ant 4(G4)		Ant 1(G1)	Max Gain(dBi)					Nant	Max DG(dBi)	Max Dg(dBi)	
		0.98	1.06	0.53	3.13				1.59	3.34	1.81	-5.58			1.87	4.55	2.55						3.31
		Ant 1(G1)	Ant 2(G2)	Ant 3(G3)	Ant 4(G4)				Ant 1(G1)	Ant 2(G2)	Ant 3(G3)	Ant 4(G4)			Ant 1(G1)	Ant 2(G2)	Ant 3(G3)						Ant 4(G4)
0.00	0.00	-10.54	-1.30	-15.89	-12.32	4.00	0.00	0.00	-1.38	-10.22	-0.54	-10.41	4.00	-0.88	-0.78	-0.42	-8.25	4.00	3.97	-1.69			
0.00	10.00	-7.11	-0.90	-9.86	-10.72	4.00	0.00	10.00	-2.06	-16.24	-0.94	-11.87	4.00	-0.88	-0.77	-0.42	-8.25	4.00	3.97	-1.69			
0.00	20.00	-4.87	-0.78	-6.52	-9.61	4.00	0.00	20.00	-3.09	-40.78	-1.64	-13.96	4.00	-0.88	-0.78	-0.42	-8.25	4.00	3.97	-1.69			
0.00	30.00	-3.30	-0.92	-4.31	-8.86	4.00	0.00	30.00	-4.58	-15.74	-2.69	-17.07	4.00	-0.88	-0.78	-0.41	-8.25	4.00	3.97	-1.69			
0.00	40.00	-2.20	-1.33	-2.77	-8.42	4.00	0.00	40.00	-6.69	-9.97	-4.20	-22.46	4.00	-0.88	-0.77	-0.42	-8.25	4.00	3.97	-1.69			
0.00	50.00	-1.47	-2.05	-1.69	-8.25	4.00	0.00	50.00	-9.87	-6.72	-6.35	-41.62	4.00	-0.88	-0.78	-0.41	-8.25	4.00	3.97	-1.69			
0.00	60.00	-1.03	-3.13	-0.97	-8.35	4.00	0.00	60.00	-15.42	-4.56	-9.61	-24.59	4.00	-0.87	-0.78	-0.41	-8.25	4.00	3.97	-1.69			
0.00	70.00	-0.88	-4.67	-0.56	-8.72	4.00	0.00	70.00	-37.95	-3.05	-15.36	-18.10	4.00	-0.88	-0.77	-0.42	-8.25	4.00	3.97	-1.69			
0.00	80.00	-0.99	-6.87	-0.41	-9.39	4.00	0.00	80.00	-16.81	-2.00	-40.41	-14.60	4.00	-0.88	-0.78	-0.41	-8.25	4.00	3.97	-1.69			
0.00	90.00	-1.38	-10.22	-0.54	-10.41	4.00	0.00	90.00	-10.54	-1.30	-15.89	-12.32	4.00	-0.88	-0.78	-0.42	-8.25	4.00	3.97	-1.69			
0.00	100.00	-2.06	-16.24	-0.94	-11.87	4.00	0.00	100.00	-7.11	-0.90	-9.86	-10.72	4.00	-0.88	-0.77	-0.42	-8.25	4.00	3.97	-1.69			
0.00	110.00	-3.09	-40.78	-1.64	-13.96	4.00	0.00	110.00	-4.87	-0.78	-6.52	-9.61	4.00	-0.88	-0.78	-0.42	-8.25	4.00	3.97	-1.69			
0.00	120.00	-4.58	-15.74	-2.69	-17.07	4.00	0.00	120.00	-3.30	-0.92	-4.31	-8.86	4.00	-0.88	-0.78	-0.41	-8.25	4.00	3.97	-1.69			
0.00	130.00	-6.69	-9.97	-4.20	-22.46	4.00	0.00	130.00	-2.20	-1.33	-2.77	-8.42	4.00	-0.88	-0.77	-0.42	-8.25	4.00	3.97	-1.69			
0.00	140.00	-9.87	-6.72	-6.35	-41.62	4.00	0.00	140.00	-1.47	-2.05	-1.69	-8.25	4.00	-0.88	-0.78	-0.41	-8.25	4.00	3.97	-1.69			
0.00	150.00	-15.42	-4.56	-9.61	-24.59	4.00	0.00	150.00	-1.03	-3.13	-0.97	-8.35	4.00	-0.87	-0.78	-0.41	-8.25	4.00	3.97	-1.69			
0.00	160.00	-37.95	-3.05	-15.36	-18.10	4.00	0.00	160.00	-0.88	-4.67	-0.56	-8.72	4.00	-0.88	-0.77	-0.42	-8.25	4.00	3.97	-1.69			
0.00	170.00	-16.81	-2.00	-40.41	-14.60	4.00	0.00	170.00	-0.99	-6.87	-0.41	-9.39	4.00	-0.88	-0.78	-0.41	-8.25	4.00	3.97	-1.69			
0.00	180.00	-10.54	-1.30	-15.89	-12.32	4.00	0.00	180.00	-1.38	-10.22	-0.54	-10.41	4.00	-0.88	-0.78	-0.42	-8.25	4.00	3.97	-1.69			
0.00	190.00	-7.11	-0.90	-9.86	-10.72	4.00	0.00	190.00	-2.06	-16.24	-0.94	-11.87	4.00	-0.88	-0.77	-0.42	-8.25	4.00	3.97	-1.69			
0.00	200.00	-4.87	-0.78	-6.52	-9.61	4.00	0.00	200.00	-3.09	-40.78	-1.64	-13.96	4.00	-0.88	-0.78	-0.42	-8.25	4.00	3.97	-1.69			
0.00	210.00	-3.30	-0.92	-4.31	-8.86	4.00	0.00	210.00	-4.58	-15.74	-2.69	-17.07	4.00	-0.88	-0.78	-0.41	-8.25	4.00	3.97	-1.69			
0.00	220.00	-2.20	-1.33	-2.77	-8.42	4.00	0.00	220.00	-6.69	-9.97	-4.20	-22.46	4.00	-0.88	-0.77	-0.42	-8.25	4.00	3.97	-1.69			
0.00	230.00	-1.47	-2.05	-1.69	-8.25	4.00	0.00	230.00	-9.87	-6.72	-6.35	-41.62	4.00	-0.88	-0.78	-0.41	-8.25	4.00	3.97	-1.69			
0.00	240.00	-1.03	-3.13	-0.97	-8.35	4.00	0.00	240.00	-15.42	-4.56	-9.61	-24.59	4.00	-0.87	-0.78	-0.41	-8.25	4.00	3.97	-1.69			
0.00	250.00	-0.88	-4.67	-0.56	-8.72	4.00	0.00	250.00	-37.95	-3.05	-15.36	-18.10	4.00	-0.88	-0.77	-0.42	-8.25	4.00	3.97	-1.69			
0.00	260.00	-0.99	-6.87	-0.41	-9.39	4.00	0.00	260.00	-16.81	-2.00	-40.41	-14.60	4.00	-0.88	-0.78	-0.41	-8.25	4.00	3.97	-1.69			
0.00	270.00	-1.38	-10.22	-0.54	-10.41	4.00	0.00	270.00	-10.54	-1.30	-15.89	-12.32	4.00	-0.88	-0.78	-0.42	-8.25	4.00	3.97	-1.69			
0.00	280.00	-2.06	-16.24	-0.94	-11.87	4.00	0.00	280.00	-7.11	-0.90	-9.86	-10.72	4.00	-0.88	-0.77	-0.42	-8.25	4.00	3.97	-1.69			
0.00	290.00	-3.09	-40.78	-1.64	-13.96	4.00	0.00	290.00	-4.87	-0.78	-6.52	-9.61	4.00	-0.88	-0.78	-0.42	-8.25	4.00	3.97	-1.69			
0.00	300.00	-4.58	-15.74	-2.69	-17.07	4.00	0.00	300.00	-3.30	-0.92	-4.31	-8.86	4.00	-0.88	-0.78	-0.41	-8.25	4.00	3.97	-1.69			
0.00	310.00	-6.69	-9.97	-4.20	-22.46	4.00	0.00	310.00	-2.20	-1.33	-2.77	-8.42	4.00	-0.88	-0.77	-0.42	-8.25	4.00	3.97	-1.69			
0.00	320.00	-9.87	-6.72	-6.35	-41.62	4.00	0.00	320.00	-1.47	-2.05	-1.69	-8.25	4.00	-0.88	-0.78	-0.41	-8.25	4.00	3.97	-1.69			
0.00	330.00	-15.42	-4.56	-9.61	-24.59	4.00	0.00	330.00	-1.03	-3.13	-0.97	-8.35	4.00	-0.87	-0.78	-0.41	-8.25	4.00	3.97	-1.69			
0.00	340.00	-37.95	-3.05	-15.36	-18.10	4.00	0.00	340.00	-0.88	-4.67	-0.56	-8.72	4.00	-0.88	-0.77	-0.42	-8.25	4.00	3.97	-1.69			
0.00	350.00	-16.81	-2.00	-40.41	-14.60	4.00	0.00	350.00	-0.99	-6.87	-0.41	-9.39	4.00	-0.88	-0.78	-0.41	-8.25	4.00	3.97	-1.69			
15.00	0.00	-11.95	-1.17	-6.18	-11.10	4.00	15.00	0.00	-0.20	-16.82	-2.48	-8.71	4.00	0.08	-1.05	-0.94	-6.73	4.00	4.23	-1.52			
15.00	10.00	-7.73	-0.36	-5.10	-11.36	4.00	15.00	10.00	-1.18	-14.30	-2.75	-9.40	4.00	-0.31	-0.19	-0.76	-7.26	4.00	4.33	-1.37			
15.00	20.00	-7.04	-0.64	-3.70	-13.21	4.00	15.00	20.00	-2.25	-10.07	-4.42	-12.37	4.00	-1.01	-0.17	-1.03	-9.76	4.00	3.76	-1.79			
15.00	30.00	-8.02	-2.11	-2.31	-12.21	4.00	15.00	30.00	-4.52	-7.19	-6.46	-15.96	4.00	-2.92	-0.94	-0.90	-10.68	4.00	2.94	-2.56			
15.00	40.00	-10.12	-3.81	-2.12	-10.52	4.00	15.00	40.00	-4.95	-8.34	-8.06	-19.08	4.00	-3.80	-2.50	-1.13	-9.95	4.00	2.25	-3.35			
15.00	50.00	-7.31	-5.23	-2.94	-12.00	4.00	15.00	50.00	-6.23	-7.13	-13.06	-24.70	4.00	-3.73	-3.07	-0.68	-11.77	4.00	2.06	-3.38			
15.00	60.00	-5.08	-5.77	-1.00	-13.03	4.00	15.00	60.00	-9.03	-6.00	-22.84	-23.84	4.00	-3.61	-1.54	-0.97	-12.68	4.00	2.36	-3.03			
15.00	70.00	-4.37	-6.67	-1.07	-12.63	4.00	15.00	70.00	-13.69	-1.47	-29.61	-13.68	4.00	-3.89	-0.32	-1.06	-10.11	4.00	2.92	-2.56			
15.00	80.00	-4.03	-9.62	-0.97	-16.75	4.00	15.00	80.00	-20.96	-1.21	-14.73	-10.92	4.00	-3.94	-0.62	-0.79	-9.21	4.00	2.92	-2.59			
15.00	90.00	-4.61	-16.35	-0.78	-14.48	4.00	15.00	90.00	-21.25	-1.49	-10.78	-9.79	4.00	-4.52	-1.35	-0.37	-8.52	4.00	2.87	-2.70			
15.00	100.00	-4.82	-18.75	-1.72	-11.64	4.00	15.00	100.00	-13.07	-1.56	-8.59	-8.31	4.00	-4.21	-1.48	-0.59	-6.65	4.00	3.10	-2.64			
15.00	110.00	-4.72	-16.59	-1.25	-11.63	4.00	15.00	110.00	-8.71	-1.93	-6.89	-7.77	4.00	-3.26	-1.78	-0.74	-6.29	4.00	3.41	-2.36			
15.00	120.00	-5.91	-12.64	-0.82	-10.04	4.00	15.00	120.00	-5.87	-2.93	-6.93	-9.85	4.00	-2.88	-2.49	0.13	-6.93	4.00	3.33	-2.38			
15.00	130.00	-7.36	-8.96	-0.70	-8.69	4.00	15.00	130.00	-4.40	-2.75	-4.96	-11.34	4.00	-2.69	-1.82	0.68	-6.81	4.00	3.76	-1.91			
15.00	140.00	-7.90	-7.60	-0.67	-7.98	4.00	15.00	140.00	-3.35	-2.18	-3.26	-12.08	4.00	-2.04	-1.08	1.24	-6.55	4.00	4.34	-1.32			
15.00	150.00	-10.07	-5.42	-1.48	-7.36	4.00	15.00	150.00	-2.30	-1.83	-1.37	-13.14	4.00	-1.63	-0.25	1.59	-6.34	4.00	4.82	-0.83			
15.00	160.00	-12.12	-4.20	-3.81	-7.17	4.00	15.00	160.00	-1.62	-2.88	-0.47	-15.54	4.00	-1.25	-0.48	1.18	-6.59	4.00	4.68	-1.00			
15.00	170.00	-11.50	-1.66	-5.40	-7.27	4.00	15.00	170.00	-0.98	-4.14	0.63	-15.85	4.00	-0.61	0.28	1.60	-6.71	4.00	5.18	-0.46			
15.00	180.00	-9.68	-0.64	-8.54	-6.99	4.00	15.00	180.00	-0.62	-7.37	1.39	-18.46	4.00	-0.11	0.20	1.81	-6.69	4.00	5.35	-0.28			
15.00	190.00	-8.31	-0.75	-14.36	-7.34	4.00	15.00	190.00	-0.41	-12.96	1.21	-17.52	4.00	0.24	-0.50	1.33	-6.94	4.00	5.08	-0.57			
15.00	200.00	-7.23	-0.70	-24.70	-7.31	4.00	15.00	200.00	-0.65	-16.62	0.54	-17.95	4.00	0.21	-0.59	0.55	-6.95	4.00	4.80	-0.89			
15.00	210.00	-4.54	-1.13	-13.67	-8.57	4.00	15.00	210.00	-0.96	-11.81	-0.20	-18.23	4.00	0.62	-0.77	-0.01	-8.12	4.00	4.56	-1.05			
15.00	220.00	-3.47	-1.5																				



45.00	190.00	-14.07	-3.91	-6.01	-4.35	4.00	45.00	190.00	-0.68	-23.44	1.10	-27.55	4.00	-0.49	-3.86	1.87	-4.33	4.00	4.70	-0.95
45.00	200.00	-8.91	-2.43	-7.93	-4.16	4.00	45.00	200.00	-1.25	-16.79	1.15	-44.99	4.00	-0.56	-2.27	1.66	-4.16	4.00	4.95	-0.81
45.00	210.00	-4.88	-5.03	-9.57	-4.13	4.00	45.00	210.00	0.21	-15.92	0.01	-40.67	4.00	1.38	-4.69	0.92	-4.13	4.00	4.83	-0.79
45.00	220.00	-2.05	-4.25	-14.64	-5.95	4.00	45.00	220.00	-0.58	-7.13	-0.13	-18.06	4.00	1.76	-2.45	0.02	-5.69	4.00	4.86	-0.78
45.00	230.00	-1.66	-6.82	-18.66	-6.04	4.00	45.00	230.00	-2.21	-6.42	-0.02	-14.99	4.00	1.08	-3.61	0.04	-5.52	4.00	4.42	-1.24
45.00	240.00	-2.79	-7.63	-15.41	-6.21	4.00	45.00	240.00	-3.71	-2.63	-2.60	-16.12	4.00	-0.22	-1.44	-2.38	-5.59	4.00	3.80	-2.02
45.00	250.00	-4.32	-7.68	-13.02	-6.00	4.00	45.00	250.00	-6.66	0.34	-7.53	-15.40	4.00	-2.32	0.98	-6.45	-5.73	4.00	3.20	-2.32
45.00	260.00	-5.41	-5.67	-14.76	-6.98	4.00	45.00	260.00	-14.12	1.74	-15.24	-19.93	4.00	-4.86	2.46	-11.98	-6.77	4.00	2.31	-2.28
45.00	270.00	-5.10	-5.01	-18.02	-6.52	4.00	45.00	270.00	-24.83	2.01	-21.02	-20.13	4.00	-5.05	2.80	-16.26	-6.33	4.00	2.19	-2.09
45.00	280.00	-3.97	-6.20	-20.58	-5.92	4.00	45.00	280.00	-21.54	2.09	-7.01	-18.36	4.00	-3.89	2.69	-6.82	-5.68	4.00	3.46	-1.64
45.00	290.00	-2.94	-8.47	-19.57	-4.20	4.00	45.00	290.00	-10.89	1.57	-3.97	-23.98	4.00	-2.24	1.98	-3.85	-4.45	4.00	4.26	-1.34
45.00	300.00	-2.03	-14.85	-14.28	-4.28	4.00	45.00	300.00	-4.67	-0.34	-1.82	-16.55	4.00	-0.14	-0.23	-1.61	-3.98	4.00	4.66	-1.24
45.00	310.00	-1.82	-8.23	-10.71	-3.08	4.00	45.00	310.00	-2.43	0.31	-1.37	-15.75	4.00	0.90	0.88	-0.89	-2.85	4.00	5.66	-0.24
45.00	320.00	-4.33	-5.34	-10.32	-2.58	4.00	45.00	320.00	-1.17	-1.09	-0.29	-20.60	4.00	0.54	0.30	0.12	-2.51	4.00	5.72	-0.23
45.00	330.00	-6.23	-3.02	-6.15	-2.32	4.00	45.00	330.00	-0.15	-2.42	-0.46	-22.61	4.00	0.81	0.30	0.58	-2.28	4.00	5.96	0.01
45.00	340.00	-11.34	-4.83	-3.84	-1.22	4.00	45.00	340.00	-0.05	-6.18	0.73	-15.78	4.00	0.26	-2.44	2.03	-1.07	4.00	5.87	0.01
45.00	350.00	-13.58	-3.93	-3.19	-2.12	4.00	45.00	350.00	1.16	-17.41	-0.83	-12.13	4.00	1.30	-3.74	1.16	-1.48	4.00	5.57	-0.23
60.00	0.00	-10.08	-1.90	-2.60	-0.53	4.00	60.00	0.00	-0.52	-11.80	-0.72	-14.20	4.00	-0.06	-1.48	1.45	-0.35	4.00	5.97	0.02
60.00	10.00	-13.48	-1.49	-1.60	-3.63	4.00	60.00	10.00	-0.32	-3.49	-2.26	-28.49	4.00	-0.12	0.63	1.09	-3.62	4.00	5.70	-0.16
60.00	20.00	-21.53	-0.42	-2.30	-5.08	4.00	60.00	20.00	-0.36	-5.38	-2.09	-20.73	4.00	-0.33	0.78	1.71	-4.96	4.00	5.66	-0.08
60.00	30.00	-12.96	-3.10	-5.37	-7.33	4.00	60.00	30.00	-1.12	-3.54	-4.50	-27.49	4.00	-0.84	-0.30	-1.90	-7.29	4.00	3.83	-1.89
60.00	40.00	-20.43	-6.69	-7.28	-12.92	4.00	60.00	40.00	-3.24	-1.07	-8.64	-11.58	4.00	-3.16	1.74	-4.90	-9.19	4.00	3.03	-2.18
60.00	50.00	-21.00	-6.49	-9.21	-18.04	4.00	60.00	50.00	-7.53	-1.66	-6.00	-10.73	4.00	-7.34	-0.43	-4.30	-9.99	4.00	1.24	-4.08
60.00	60.00	-10.98	-8.50	-9.35	-17.61	4.00	60.00	60.00	-10.88	-3.10	-11.87	-13.28	4.00	-7.92	-2.00	-7.42	-11.92	4.00	-0.56	-5.86
60.00	70.00	-9.57	-13.10	-8.33	-21.12	4.00	60.00	70.00	-10.32	-5.76	-17.83	-25.44	4.00	-6.92	-3.20	-5.20	3.20	4.00	3.91	-1.14
60.00	80.00	-11.80	-19.33	-9.62	-17.98	4.00	60.00	80.00	-11.56	-3.98	-7.07	-14.40	4.00	-8.67	-3.86	-6.10	-12.82	4.00	-1.24	-6.75
60.00	90.00	-17.17	-17.28	-9.83	-18.47	4.00	60.00	90.00	-21.41	-3.53	-9.93	-13.54	4.00	-15.78	-3.35	-6.20	-12.33	4.00	-2.08	-7.06
60.00	100.00	-13.11	-11.48	-10.36	-15.42	4.00	60.00	100.00	-12.08	-7.54	-14.24	-22.87	4.00	-9.55	-6.07	-8.87	-14.74	4.00	-3.26	-8.85
60.00	110.00	-11.23	-12.33	-9.05	-16.52	4.00	60.00	110.00	-7.41	-5.92	-11.96	-16.76	4.00	-5.90	-5.03	-7.26	-13.63	4.00	-1.36	-6.97
60.00	120.00	-11.06	-11.09	-8.88	-11.89	4.00	60.00	120.00	-5.63	-11.89	-12.73	-15.94	4.00	-4.54	-1.02	-5.06	-10.45	4.00	1.33	-4.18
60.00	130.00	-17.75	-6.78	-4.05	-8.33	4.00	60.00	130.00	-4.16	-1.16	-5.97	-19.38	4.00	-3.97	-0.11	-1.89	-8.00	4.00	2.99	-2.63
60.00	140.00	-17.04	-6.15	-4.21	-8.98	4.00	60.00	140.00	-2.16	-2.52	-3.90	-13.45	4.00	-2.02	-0.96	-1.04	-7.65	4.00	3.49	-2.24
60.00	150.00	-22.46	-5.90	-5.36	-3.86	4.00	60.00	150.00	-1.92	-6.98	-3.11	-16.04	4.00	-1.88	-3.40	-1.08	-3.60	4.00	2.59	-2.36
60.00	160.00	-22.94	-10.49	-5.14	-5.69	4.00	60.00	160.00	-2.91	-9.22	-3.35	-20.35	4.00	-2.87	-6.80	-1.02	-5.54	4.00	3.26	-3.48
60.00	170.00	-21.17	-9.59	-6.64	-3.83	4.00	60.00	170.00	-1.61	-11.45	-1.28	-21.20	4.00	-1.56	-7.36	-1.39	-6.07	4.00	2.52	-3.99
60.00	180.00	-14.97	9.06	6.52	-3.83	4.00	60.00	180.00	-1.22	-10.74	-1.28	-21.31	4.00	-1.04	-6.81	-0.14	-3.75	4.00	3.45	-2.25
60.00	190.00	-12.56	-5.05	-4.95	-3.71	4.00	60.00	190.00	-1.42	-16.20	-1.58	-34.79	4.00	-1.10	-4.73	0.06	-3.71	4.00	3.87	-1.95
60.00	200.00	-7.32	-5.34	-7.21	-4.68	4.00	60.00	200.00	0.02	-14.94	-1.91	-24.87	4.00	0.76	-4.89	-0.79	-4.64	4.00	3.97	-1.72
60.00	210.00	-6.33	-7.42	-5.05	4.00	4.00	60.00	210.00	-0.09	-10.96	-1.28	-24.53	4.00	0.84	-5.02	-0.33	-5.00	4.00	4.05	-1.60
60.00	220.00	-6.52	-4.92	-8.53	-4.75	4.00	60.00	220.00	-0.15	-6.03	-1.61	-21.02	4.00	0.75	-2.43	-0.81	-4.65	4.00	4.46	-1.35
60.00	230.00	-7.43	-5.12	-9.74	-5.67	4.00	60.00	230.00	-2.09	-6.67	-1.24	-24.69	4.00	-0.98	-2.77	-2.09	-6.56	4.00	3.72	-2.11
60.00	240.00	-9.21	-6.84	-10.33	-5.25	4.00	60.00	240.00	-8.44	-1.78	-3.23	-23.57	4.00	-5.80	-0.60	-2.42	-5.19	4.00	2.78	-2.99
60.00	250.00	-7.01	-10.14	-11.45	-3.86	4.00	60.00	250.00	-15.25	-0.82	-8.06	-16.86	4.00	-6.40	-0.34	-6.42	-3.65	4.00	2.19	-3.44
60.00	260.00	-4.90	-12.47	-14.51	-3.75	4.00	60.00	260.00	-30.70	-2.14	-14.84	-20.61	4.00	-4.89	-1.76	-11.66	-3.66	4.00	1.23	-4.29
60.00	270.00	-4.74	-17.62	-15.77	-3.31	4.00	60.00	270.00	-11.99	-3.90	-3.24	-20.02	4.00	-3.99	-3.72	-11.38	-3.22	4.00	1.00	-4.64
60.00	280.00	-6.63	-17.99	-13.73	-2.20	4.00	60.00	280.00	-8.92	-4.24	-6.87	-22.45	4.00	-4.62	-4.06	-6.06	-2.16	4.00	1.91	-3.99
60.00	290.00	-8.84	-11.04	-9.37	-1.69	4.00	60.00	290.00	-7.18	-3.91	-4.39	-19.08	4.00	-4.92	-3.14	-3.19	-1.61	4.00	2.88	-3.06
60.00	300.00	-10.07	-8.30	-7.95	-2.52	4.00	60.00	300.00	-7.55	-0.93	-1.75	-15.46	4.00	-5.62	-0.20	-0.82	-2.30	4.00	4.02	-1.79
60.00	310.00	-7.75	-15.80	-7.21	-2.81	4.00	60.00	310.00	-5.69	-1.22	0.14	-13.80	4.00	-3.59	-1.07	0.87	-2.22	4.00	4.62	-1.24
60.00	320.00	-8.66	-10.98	-6.21	-2.95	4.00	60.00	320.00	-1.47	-1.94	-0.87	-20.07	4.00	-0.71	-1.43	0.24	-2.87	4.00	4.90	-1.05
60.00	330.00	-9.13	-5.24	-6.05	-0.79	4.00	60.00	330.00	-1.56	-1.83	0.06	-12.27	4.00	-0.86	-0.20	1.48	-0.49	4.00	6.05	0.08
60.00	340.00	-8.42	-4.44	-3.27	-0.10	4.00	60.00	340.00	0.27	-9.39	-1.53	-18.19	4.00	0.82	-3.23	0.70	-0.03	4.00	5.73	-0.17
60.00	350.00	-11.14	-2.63	-1.26	-0.45	4.00	60.00	350.00	0.34	-11.26	-1.72	-11.30	4.00	0.64	-2.07	1.53	-0.11	4.00	6.12	0.19
75.00	0.00	-9.06	-4.30	-6.11	0.54	4.00	75.00	0.00	-1.15	-28.89	-1.08	-15.88	4.00	-0.50	-4.28	0.11	1.64	4.00	5.21	-0.65
75.00	10.00	-14.16	0.13	-5.89	-1.23	4.00	75.00	10.00	0.61	-13.15	-2.14	-21.53	4.00	0.75	0.33	-0.61	-0.68	4.00	5.88	-0.11
75.00	20.00	-18.24	-0.35	-7.23	-5.20	4.00	75.00	20.00	1.59	-4.77	-3.24	-31.99	4.00	1.63	-1.28	-1.78	-3.79	4.00	5.41	-0.26
75.00	30.00	-12.52	-5.93	-6.08	-12.19	4.00	75.00	30.00	0.13	-6.76	-4.67	-17.80	4.00	0.36	-3.21	-2.31	-11.14	4.00	2.83	-2.62
75.00	40.00	-17.37	-9.41	-8.19	-13.89	4.00	75.00	40.00	-4.17	-6.93	-6.93	-14.63	4.00	-3.97	-1.01	-6.50	-3.23	4.00	1.56	-3.56
75.00	50.00	-12.10	-21.12	-8.99	-14.47	4.00	75.00	50.00	-3.49	1.03	-9.99	-12.12	4.00	-2.93	0.06	-6.03	-12.58	4.00	1.66	-4.48
75.00	60.00	-11.53	-25.73	-7.72	-14.66	4.00	75.00	60.00	-4.14	0.76	-10.17	-26.21	4.00	-4.31	-2.74	-5.78	-18.63	4.00	0.16	-4.99
75.00	70.00	-14.81	-11.69	-10.4	-11.98	4.00	75.00	70.00	-4.71	-8.38	-8.06	-17.76	4.00	-4.31	-6.72	-6.06				



105.00	100.00	-9.13	-16.38	-13.88	-26.68	4.00	105.00	100.00	-14.3	-16.58	-13.44	-13.26	4.00
105.00	110.00	-14.41	-12.64	-32.51	-19.29	4.00	105.00	110.00	-9.78	-6.84	-8.49	-11.62	4.00
105.00	120.00	-14.58	-9.92	-12.48	-10.62	4.00	105.00	120.00	-13.01	-7.62	-12.05	-7.93	4.00
105.00	130.00	-9.91	-13.57	-13.86	-6.41	4.00	105.00	130.00	-7.03	-15.50	-14.50	-13.86	4.00
105.00	140.00	-24.15	-14.52	-13.64	-1.63	4.00	105.00	140.00	-5.83	-17.24	-12.77	-18.11	4.00
105.00	150.00	-26.04	-5.01	-13.62	-1.40	4.00	105.00	150.00	-7.47	-8.12	-24.93	-17.11	4.00
105.00	160.00	-20.23	-3.95	-9.21	-0.59	4.00	105.00	160.00	-9.26	-16.22	-13.82	-16.34	4.00
105.00	170.00	-30.34	-7.31	-7.88	1.08	4.00	105.00	170.00	-7.11	-9.73	-10.41	-23.00	4.00
105.00	180.00	-16.66	-11.02	-7.58	1.51	4.00	105.00	180.00	-6.75	-23.62	-10.83	-11.55	4.00
105.00	190.00	-24.40	-10.46	-5.84	2.91	4.00	105.00	190.00	-3.98	-15.39	-16.04	-14.05	4.00
105.00	200.00	-9.19	-10.27	-4.81	3.13	4.00	105.00	200.00	-6.61	-22.36	-11.45	-18.32	4.00
105.00	210.00	-14.81	-15.74	-5.40	2.27	4.00	105.00	210.00	-8.74	-14.24	-9.25	-18.32	4.00
105.00	220.00	-19.67	-11.27	-3.88	1.76	4.00	105.00	220.00	-9.11	-15.47	-7.45	-15.92	4.00
105.00	230.00	-19.18	-12.08	-4.12	-0.53	4.00	105.00	230.00	-14.63	-11.43	-6.52	-18.01	4.00
105.00	240.00	-15.63	-19.66	-3.53	-2.68	4.00	105.00	240.00	-16.19	-3.49	-10.38	-20.84	4.00
105.00	250.00	-12.90	-16.14	-3.69	-1.66	4.00	105.00	250.00	-14.92	-4.62	-9.16	-18.55	4.00
105.00	260.00	-11.23	-17.76	-2.33	0.20	4.00	105.00	260.00	-21.78	-6.55	-17.03	-29.12	4.00
105.00	270.00	-11.00	-17.22	-1.33	1.77	4.00	105.00	270.00	-22.04	-6.38	-14.26	-28.13	4.00
105.00	280.00	-9.17	-14.86	-1.79	2.52	4.00	105.00	280.00	-15.84	-5.57	-8.88	-17.46	4.00
105.00	290.00	-10.23	-14.47	-2.56	3.07	4.00	105.00	290.00	-9.37	-6.95	-4.94	-16.34	4.00
105.00	300.00	-15.05	-10.66	-3.48	2.96	4.00	105.00	300.00	-4.40	-12.25	-3.76	-20.80	4.00
105.00	310.00	-17.87	-8.95	-3.83	1.42	4.00	105.00	310.00	-3.43	-10.45	-1.61	-22.11	4.00
105.00	320.00	-14.32	-9.22	-6.67	-2.27	4.00	105.00	320.00	-5.54	-8.06	-1.96	-17.11	4.00
105.00	330.00	-11.14	-5.34	-7.83	-3.23	4.00	105.00	330.00	-7.20	-5.89	-1.09	-17.11	4.00
105.00	340.00	-20.90	-4.58	-8.52	-2.42	4.00	105.00	340.00	-3.70	-7.20	-1.34	-18.99	4.00
105.00	350.00	-17.99	-5.16	-10.12	0.29	4.00	105.00	350.00	-6.37	-5.06	-1.67	-12.85	4.00
120.00	0.00	-12.11	-5.55	-15.62	-1.17	4.00	120.00	0.00	-6.09	-11.53	-1.56	-15.50	4.00
120.00	10.00	-9.83	-5.51	-17.54	-2.50	4.00	120.00	10.00	-5.32	-3.98	-3.98	-19.49	4.00
120.00	20.00	-8.20	-5.21	-10.12	-2.19	4.00	120.00	20.00	-6.28	-3.89	-5.38	-23.46	4.00
120.00	30.00	-11.23	-4.23	-12.85	-6.91	4.00	120.00	30.00	-7.43	-7.82	-9.84	-8.93	4.00
120.00	40.00	-10.39	-7.80	-12.54	-9.33	4.00	120.00	40.00	-16.10	-4.55	-12.83	-7.23	4.00
120.00	50.00	-6.17	-3.34	-10.32	-10.85	4.00	120.00	50.00	-24.06	1.19	-9.42	-9.82	4.00
120.00	60.00	-5.58	-11.54	-15.14	-14.84	4.00	120.00	60.00	-9.13	-6.85	-5.94	-17.63	4.00
120.00	70.00	-7.57	-7.25	-15.84	-38.83	4.00	120.00	70.00	-15.33	-2.60	-5.39	-16.01	4.00
120.00	80.00	-11.95	-2.95	-21.11	-21.11	4.00	120.00	80.00	-2.55	-13.79	-17.48	-17.48	4.00
120.00	90.00	-9.23	-14.39	-37.78	-20.36	4.00	120.00	90.00	-6.00	-15.93	-11.88	-18.20	4.00
120.00	100.00	-8.36	-18.12	-27.61	-26.74	4.00	120.00	100.00	-8.77	-9.64	-9.60	-13.19	4.00
120.00	110.00	-11.14	-13.35	-16.65	-16.44	4.00	120.00	110.00	-30.21	-28.20	-7.63	-9.98	4.00
120.00	120.00	-9.84	-9.27	-12.51	-10.71	4.00	120.00	120.00	-7.78	-6.75	-6.58	-16.37	4.00
120.00	130.00	-8.48	-25.76	-15.34	-7.96	4.00	120.00	130.00	-8.95	-17.83	-15.96	-22.59	4.00
120.00	140.00	-11.88	-5.51	-15.51	-4.72	4.00	120.00	140.00	-17.70	-4.69	-26.44	-30.68	4.00
120.00	150.00	-31.06	-4.76	-13.77	-5.11	4.00	120.00	150.00	-11.92	-8.84	-11.31	-15.96	4.00
120.00	160.00	-16.40	-3.88	-9.22	-0.89	4.00	120.00	160.00	-5.16	-21.22	-25.69	-14.58	4.00
120.00	170.00	-14.80	-3.10	-9.99	0.16	4.00	120.00	170.00	-9.39	-21.82	-14.38	-19.72	4.00
120.00	180.00	-11.22	-5.49	-10.86	1.44	4.00	120.00	180.00	-6.34	-16.38	-14.19	-12.63	4.00
120.00	190.00	-24.64	-17.84	-6.83	1.23	4.00	120.00	190.00	-13.14	-15.50	-10.37	-15.77	4.00
120.00	200.00	-9.15	-11.25	-6.07	2.56	4.00	120.00	200.00	-17.51	-7.39	-10.61	-16.57	4.00
120.00	210.00	-13.82	-18.99	-5.54	1.40	4.00	120.00	210.00	-12.99	-18.53	-7.24	-19.40	4.00
120.00	220.00	-19.82	-26.39	-4.40	-0.69	4.00	120.00	220.00	-13.72	-15.74	-7.81	-15.11	4.00
120.00	230.00	-14.32	-17.78	-4.05	-2.67	4.00	120.00	230.00	-9.42	-7.35	-6.62	-23.53	4.00
120.00	240.00	-12.12	-19.77	-3.59	-5.58	4.00	120.00	240.00	-10.87	-16.51	-5.57	-14.18	4.00
120.00	250.00	-12.45	-16.62	-4.98	-5.70	4.00	120.00	250.00	-10.53	-14.06	-6.44	-12.47	4.00
120.00	260.00	-13.17	-19.09	-4.06	-2.05	4.00	120.00	260.00	-9.67	-7.88	-9.31	-13.33	4.00
120.00	270.00	-11.09	-17.01	-2.71	1.02	4.00	120.00	270.00	-8.75	-7.88	-23.25	-23.12	4.00
120.00	280.00	-9.57	-11.93	-1.63	2.76	4.00	120.00	280.00	-7.38	-5.62	-10.29	-12.42	4.00
120.00	290.00	-8.27	-9.36	-1.75	3.05	4.00	120.00	290.00	-6.81	-4.90	-5.24	-9.07	4.00
120.00	300.00	-7.71	-8.84	-1.86	2.51	4.00	120.00	300.00	-5.19	-5.55	-3.65	-10.23	4.00
120.00	310.00	-8.54	-6.04	-4.47	4.00	4.00	120.00	310.00	-3.23	-3.28	-0.81	-26.83	4.00
120.00	320.00	-12.58	-6.62	-5.95	-2.95	4.00	120.00	320.00	-6.04	-4.56	-0.81	-35.80	4.00
120.00	330.00	-13.40	-3.46	-8.65	-6.65	4.00	120.00	330.00	-7.28	-3.37	-2.58	-26.14	4.00
120.00	340.00	-25.67	-7.31	-19.56	-5.94	4.00	120.00	340.00	-5.50	-3.47	-0.09	-33.10	4.00
120.00	350.00	-17.55	-1.45	-21.51	-3.60	4.00	120.00	350.00	-4.93	-8.78	-2.34	-10.28	4.00
135.00	0.00	-7.23	-6.85	-10.70	-3.76	4.00	135.00	0.00	-2.54	-8.56	-4.38	-20.37	4.00
135.00	10.00	-9.90	-10.04	-17.64	-4.73	4.00	135.00	10.00	-6.08	-12.15	-5.03	-35.99	4.00
135.00	20.00	-11.67	-2.91	-12.18	-6.14	4.00	135.00	20.00	-13.07	-5.55	-3.22	-12.61	4.00
135.00	30.00	-13.56	-34.15	-12.16	-1.16	4.00	135.00	30.00	-19.04	-8.26	-6.29	-13.76	4.00
135.00	40.00	-5.72	-17.68	-21.83	-7.51	4.00	135.00	40.00	-35.78	-2.57	-13.42	-11.68	4.00
135.00	50.00	-9.58	-11.08	-13.80	-7.15	4.00	135.00	50.00	-18.11	-2.73	-19.56	-10.06	4.00
135.00	60.00	-7.44	-14.05	-13.08	-8.63	4.00	135.00	60.00	-9.46	-1.77	-12.52	-9.47	4.00
135.00	70.00	-6.75	-18.48	-14.76	-11.57	4.00	135.00	70.00	-12.65	-2.23	-11.88	-10.52	4.00
135.00	80.00	-6.05	-14.79	-20.24	-14.97	4.00	135.00	80.00	-36.43	-3.97	-13.04	-11.49	4.00
135.00	90.00	-9.46	-9.78	-21.56	-18.04	4.00	135.00	90.00	-30.22	-6.78	-16.43	-16.33	4.00
135.00	100.00	-14.41	-8.64	-24.29	-27.35	4.00	135.00	100.00	-12.38	-4.41	-24.63	-17.15	4.00
135.00	110.00	-16.55	-9.46	-14.27	-20.34	4.00	135.00	110.00	-3.70	-2.91	-12.78	-9.98	4.00
135.00	120.00	-11.17	-20.26	-11.04	-15.10	4.00	135.00	120.00	-4.33	-4.48	-12.80	-7.83	4.00
135.00	130.00	-14.29	-10.74	-16.69	-12.89	4.00	135.00	130.00	-25.24	-12.26	-17.80	-13.25	4.00
135.00	140.00	-22.88	-11.80	-10.36	-10.89	4.00	135.00	140.00	-11.13	-5.50	-8.96	-11.41	4.00
135.00	150.00	-9.02	-16.37	-12.28	-5.53	4.00	135.00	150.00	-11.82	-8.00	-13.40	-7.77	4.00
135.00	160.00	-8.28	-4.77	-7.67	-4.17	4.00	135.00	160.00	-12.07	-29.30	-12.46	-10.04	4.00
135.00	170.00	-8.74	-1.45	-10.06	-1.85	4.00	135.00	170.00	-8.18	-17.91	-12.91	-11.09	4.00
135.00	180.00	-10.47	-3.11	-3.97	-0.26	4.00	135.00	180.00	-9.82	-15.71	-5.69	-14.25	4.00
135.00	190.00	-9.49	-6.16	-26.00	-2.11	4.00	135.00	190.00	-13.71	-12.14	-6.86	-12.14	4.00
135.00	200.00	-8.06	-6.16	-0.55	4.00	4.00	135.00	200.00	-5.74	-20.20	-5.38	-28.30	4.00
135.00	210.00	-10.17	-8.43	-3.12	-0.39	4.00	135.00	210.00	-5.74	-12.08	-7.34	-17.69	4.00
135.00	220.00	-13.53	-6.48	-5.98	-2.22	4.00	135.00	220.00	-9.36	-7.12	-5.88	-20.45	4.00
135.00	230.00	-12.11	-7.05	-5.20	-7.72	4.00	135.00	230.00	-8.93	-4.69	-7.91	-11.53	4.00
135.00	240.00	-14.60	-12.36	-4.40	-15.95								



165.00	10.00	-15.04	-15.16	-20.92	-13.54	4.00	165.00	10.00	-7.75	-6.78	-8.77	-8.84	4.00	-7.01	-6.19	-8.51	-7.57	4.00	-1.26	-7.24
165.00	20.00	-18.40	-3.12	-26.98	-22.04	4.00	165.00	20.00	-9.92	-11.53	-9.76	-11.83	4.00	-9.34	-2.53	-9.68	-11.43	4.00	-1.49	-6.71
165.00	30.00	-18.45	-2.76	-15.64	-21.61	4.00	165.00	30.00	-13.87	-9.28	-8.52	-10.70	4.00	-12.57	-1.89	-7.75	-10.36	4.00	-1.14	-6.18
165.00	40.00	-17.48	-7.36	-12.68	-21.79	4.00	165.00	40.00	-16.60	-6.74	-7.27	-9.45	4.00	-14.01	-4.03	-6.17	-9.20	4.00	-1.59	-7.01
165.00	50.00	-16.59	-25.75	-9.19	-24.29	4.00	165.00	50.00	-18.52	-7.63	-8.75	-8.97	4.00	-14.44	-7.56	-5.95	-8.84	4.00	-2.65	-8.27
165.00	60.00	-16.73	-16.94	-10.28	-23.78	4.00	165.00	60.00	-18.12	-8.46	-11.99	-13.54	4.00	-14.36	-7.88	-8.04	-13.15	4.00	-4.36	-9.95
165.00	70.00	-17.07	-16.14	-12.53	-27.47	4.00	165.00	70.00	-22.38	-5.08	-27.85	-14.82	4.00	-15.95	-4.75	-12.40	-14.59	4.00	-4.70	-9.47
165.00	80.00	-16.13	-16.50	-19.04	-33.90	4.00	165.00	80.00	-20.78	-3.46	-30.26	-16.92	4.00	-14.85	-3.25	-18.72	-16.83	4.00	-4.97	-8.70
165.00	90.00	-14.52	-9.88	-24.29	-22.37	4.00	165.00	90.00	-23.96	-3.81	-26.90	-13.61	4.00	-14.05	-2.85	-22.39	-13.07	4.00	-4.32	-8.14
165.00	100.00	-15.46	-8.24	-20.95	-18.20	4.00	165.00	100.00	-47.92	-5.39	-17.68	-17.97	4.00	-15.46	-3.57	-16.00	-15.07	4.00	-4.69	-8.83
165.00	110.00	-15.74	-6.96	-17.29	-16.25	4.00	165.00	110.00	-23.50	-7.75	-15.43	-22.52	4.00	-15.07	-4.33	-13.25	-15.33	4.00	-4.64	-9.24
165.00	120.00	-16.38	-8.65	-17.68	-14.12	4.00	165.00	120.00	-28.62	-6.88	-11.20	-33.06	4.00	-15.77	-4.67	-10.32	-14.06	4.00	-4.08	-9.03
165.00	130.00	-13.92	-9.59	-14.95	-14.59	4.00	165.00	130.00	-17.66	-7.02	-8.87	-23.30	4.00	-12.39	-5.11	-7.91	-14.04	4.00	-3.12	-8.48
165.00	140.00	-14.08	-8.72	-15.45	-19.02	4.00	165.00	140.00	-15.15	-9.72	-6.86	-21.19	4.00	-11.57	-6.18	-6.30	-16.96	4.00	-3.22	-8.50
165.00	150.00	-18.02	-7.36	-14.35	-24.42	4.00	165.00	150.00	-16.65	-7.92	-7.62	-18.97	4.00	-14.27	-4.62	-6.78	-17.88	4.00	-3.31	-8.18
165.00	160.00	-21.87	-7.21	-11.80	-25.18	4.00	165.00	160.00	-15.73	-7.53	-6.96	-14.47	4.00	-14.78	-4.36	-5.73	-14.12	4.00	-2.49	-7.53
165.00	170.00	-21.02	-7.74	-12.69	-31.49	4.00	165.00	170.00	-13.86	-10.87	-9.50	-12.62	4.00	-13.10	-6.02	-7.80	-12.56	4.00	-3.32	-8.86
165.00	180.00	-12.24	-8.59	-10.83	-20.65	4.00	165.00	180.00	-11.38	-14.49	-13.12	-13.85	4.00	-8.78	-7.60	-8.82	-13.03	4.00	-3.31	-9.14
165.00	190.00	-8.91	-9.52	-10.74	-22.22	4.00	165.00	190.00	-14.48	-16.92	-13.90	-12.80	4.00	-7.85	-8.79	-9.03	-12.33	4.00	-3.32	-9.21
165.00	200.00	-7.70	-8.85	-13.20	-33.03	4.00	165.00	200.00	-24.41	-9.84	-13.83	-12.81	4.00	-7.61	-6.31	-10.49	-12.77	4.00	-2.92	-8.62
165.00	210.00	-10.60	-11.62	-13.18	-23.76	4.00	165.00	210.00	-16.46	-5.79	-18.83	-14.56	4.00	-9.60	-4.78	-12.13	-14.07	4.00	-3.39	-8.68
165.00	220.00	-8.37	-14.49	-12.27	-20.91	4.00	165.00	220.00	-16.16	-2.53	-14.94	-16.23	4.00	-7.70	-2.26	-10.39	-14.96	4.00	-1.60	-6.54
165.00	230.00	-7.76	-24.05	-15.21	-17.83	4.00	165.00	230.00	-15.26	-2.15	-13.79	-16.11	4.00	-7.05	-2.12	-11.43	-13.88	4.00	-1.42	-6.37
165.00	240.00	-8.34	-31.15	-18.79	-15.04	4.00	165.00	240.00	-14.13	-1.04	-10.08	-15.71	4.00	-7.32	-1.04	-9.53	-12.35	4.00	-0.48	-5.44
165.00	250.00	-14.28	-23.08	-25.44	-15.37	4.00	165.00	250.00	-10.56	-1.31	-9.89	-13.21	4.00	-9.02	-1.28	-9.77	-11.15	4.00	-0.83	-5.80
165.00	260.00	-23.85	-14.81	-26.39	-16.29	4.00	165.00	260.00	-9.47	-2.30	-7.46	-11.60	4.00	-9.31	-2.06	-7.40	-10.33	4.00	-0.62	-5.96
165.00	270.00	-20.96	-11.15	-30.25	-12.37	4.00	165.00	270.00	-6.13	-4.45	-7.28	-9.05	4.00	-5.99	-3.61	-7.26	-7.39	4.00	0.10	-5.78
165.00	280.00	-12.73	-12.57	-26.17	-12.36	4.00	165.00	280.00	-6.09	-8.56	-6.96	-8.05	4.00	-5.24	-7.11	-6.91	-6.68	4.00	-0.43	-6.42
165.00	290.00	-10.41	-13.30	-35.93	-10.35	4.00	165.00	290.00	-6.81	-17.93	-6.58	-6.50	4.00	-5.24	-12.01	-6.57	-5.00	4.00	-0.77	-6.49
165.00	300.00	-10.54	-11.22	-23.12	-10.91	4.00	165.00	300.00	-5.69	-15.66	-4.98	-7.32	4.00	-4.46	-9.89	-4.91	-5.74	4.00	0.01	-5.81
165.00	310.00	-9.48	-9.14	-22.25	-8.39	4.00	165.00	310.00	-5.27	-16.71	-5.85	-6.12	4.00	-3.87	-8.44	-5.75	-4.10	4.00	0.66	-5.20
165.00	320.00	-12.14	-4.52	-15.29	-7.01	4.00	165.00	320.00	-7.38	-14.00	-7.39	-8.84	4.00	-6.13	-4.06	-6.74	-4.82	4.00	0.65	-5.31
165.00	330.00	-15.13	-1.79	-13.55	-6.24	4.00	165.00	330.00	-6.85	-12.64	-7.17	-9.71	4.00	-6.25	-1.45	-6.27	-4.63	4.00	1.61	-4.16
165.00	340.00	-19.77	0.18	-15.41	-7.26	4.00	165.00	340.00	-6.67	-15.30	-6.64	-9.96	4.00	-6.46	0.30	-6.10	-5.39	4.00	2.99	-3.39
165.00	350.00	-16.07	-1.40	-15.39	-9.29	4.00	165.00	350.00	-6.73	-13.30	-5.66	-8.64	4.00	-6.25	-1.13	-5.22	-5.94	4.00	1.65	-4.08
180.00	0.00	-14.01	-6.17	-11.96	-10.07	4.00	180.00	0.00	-15.92	-14.18	-19.16	-13.65	4.00	-11.85	-5.53	-11.20	-8.49	4.00	-2.88	-8.52
180.00	10.00	-12.99	-5.71	-11.45	-9.25	4.00	180.00	10.00	-18.20	-19.40	-23.78	-16.47	4.00	-11.85	-5.53	-11.20	-8.50	4.00	-2.88	-8.52
180.00	20.00	-12.32	-5.53	-11.22	-8.74	4.00	180.00	20.00	-21.70	-36.12	-35.27	-21.11	4.00	-11.85	-5.53	-11.20	-8.50	4.00	-2.88	-8.52
180.00	30.00	-11.95	-5.62	-11.26	-8.51	4.00	180.00	30.00	-28.19	-22.33	-30.24	-32.69	4.00	-11.85	-5.53	-11.21	-8.49	4.00	-2.88	-8.52
180.00	40.00	-11.85	-5.98	-11.56	-8.55	4.00	180.00	40.00	-45.16	-15.59	-22.18	-27.46	4.00	-11.85	-5.53	-11.20	-8.49	4.00	-2.88	-8.52
180.00	50.00	-12.02	-6.64	-12.16	-8.86	4.00	180.00	50.00	-26.05	-12.01	-18.24	-19.44	4.00	-11.85	-5.53	-11.20	-8.49	4.00	-2.88	-8.52
180.00	60.00	-12.46	-7.64	-13.09	-9.45	4.00	180.00	60.00	-20.67	-9.68	-15.73	-15.51	4.00	-11.85	-5.53	-11.20	-8.49	4.00	-2.88	-8.52
180.00	70.00	-13.21	-9.07	-14.43	-10.38	4.00	180.00	70.00	-17.55	-8.07	-14.00	-13.01	4.00	-11.85	-5.53	-11.20	-8.49	4.00	-2.88	-8.52
180.00	80.00	-14.33	-11.12	-16.35	-11.73	4.00	180.00	80.00	-15.47	-6.93	-12.79	-11.29	4.00	-11.85	-5.53	-11.20	-8.49	4.00	-2.88	-8.52
180.00	90.00	-15.92	-14.18	-19.16	-13.65	4.00	180.00	90.00	-14.01	-6.17	-11.96	-10.07	4.00	-11.85	-5.53	-11.20	-8.49	4.00	-2.88	-8.52
180.00	100.00	-18.20	-19.40	-23.78	-16.47	4.00	180.00	100.00	-12.99	-5.71	-11.45	-9.25	4.00	-11.85	-5.53	-11.20	-8.49	4.00	-2.88	-8.52
180.00	110.00	-21.70	-36.12	-35.27	-21.11	4.00	180.00	110.00	-12.32	-5.53	-11.22	-8.74	4.00	-11.85	-5.53	-11.20	-8.50	4.00	-2.88	-8.52
180.00	120.00	-28.19	-22.33	-30.24	-32.69	4.00	180.00	120.00	-11.95	-5.62	-11.26	-8.51	4.00	-11.85	-5.53	-11.21	-8.49	4.00	-2.88	-8.52
180.00	130.00	-45.16	-15.59	-22.18	-27.46	4.00	180.00	130.00	-11.85	-5.98	-11.56	-8.55	4.00	-11.85	-5.53	-11.20	-8.49	4.00	-2.88	-8.52
180.00	140.00	-26.05	-12.01	-18.24	-19.44	4.00	180.00	140.00	-12.02	-6.64	-12.16	-8.86	4.00	-11.85	-5.53	-11.20	-8.50	4.00	-2.88	-8.52
180.00	150.00	-20.67	-9.68	-15.73	-15.51	4.00	180.00	150.00	-12.46	-7.64	-13.09	-9.45	4.00	-11.85	-5.53	-11.20	-8.49	4.00	-2.88	-8.52
180.00	160.00	-17.55	-8.07	-14.00	-13.01	4.00	180.00	160.00	-13.21	-9.07	-14.43	-10.38	4.00	-11.85	-5.53	-11.20	-8.49	4.00	-2.88	-8.52
180.00	170.00	-15.47	-6.93	-12.79	-11.29	4.00	180.00	170.00	-14.33	-11.12	-16.35	-11.73	4.00	-11.85	-5.53	-11.20	-8.49	4.00	-2.88	-8.52
180.00	180.00	-14.01	-6.17	-11.96	-10.07	4.00	180.00	180.00	-15.92	-14.18	-19.16	-13.65	4.00	-11.85	-5.53	-11.20	-8.49	4.00	-2.88	-8.52
180.00	190.00	-12.99	-5.71	-11.45	-9.25	4.00	180.00	190.00	-18.20	-19.40	-23.78	-16.47	4.00	-11.85	-5.53	-11.20	-8.50	4.00	-2.88	-8.52
180.00	200.00	-12.32	-5.53	-11.22	-8.74	4.00	180.00	200.00	-21.70	-36.12	-35.27	-21.11	4.00	-11.85	-5.53	-11.20	-8.50	4.00	-2.88	-8.52
180.00	210.00	-11.95	-5.62	-11.26	-8.51	4.00	180.00	210.00	-28.19	-22.33	-30.24	-32.69	4.00	-11.85	-5.53	-11.21	-8.49	4.00	-2.88	-8.52
180.00	220.00	-11.85	-5.98	-11.56	-8.55	4.00	180.00	220.00	-45.16	-15.59	-22.18	-27.46	4.00	-11.85	-5.53	-11.20	-8.49	4.00	-2.88	-8.52
180.00	230.00	-12.02	-6.64	-12.16	-8.86	4.00	180.00	230.00	-26.05	-12.01	-18.24	-19.44	4.00	-11.85	-5.53	-11.20	-8.50	4.00	-2.88	-8.52
180.00																				



Frequency: 6435MHz

Theta Florization		Max Gain(dBi)				Nant	Phi Florization		Max Gain(dBi)				Nant	Total				Max DG(dBi)						
Angle (θ)	Angle (φ)	Ant 1(G1)	Ant 2(G2)	Ant 3(G3)	Ant 4(G4)		Angle (θ)	Angle (φ)	Ant 1(G1)	Ant 2(G2)	Ant 3(G3)	Ant 4(G4)		Ant 1(G1)	Ant 2(G2)	Ant 3(G3)	Ant 4(G4)	Nant	6.25	0.49				
		1.11	1.32	0.57	3.02				1.53	3.71	2.19	-5.50									2.23	4.83	3.22	3.20
		Ant 1(G1)	Ant 2(G2)	Ant 3(G3)	Ant 4(G4)				Ant 1(G1)	Ant 2(G2)	Ant 3(G3)	Ant 4(G4)									Ant 1(G1)	Ant 2(G2)	Ant 3(G3)	Ant 4(G4)
0.00	0.00	-11.69	-1.54	-14.11	-12.83	4.00	0.00	0.00	-0.53	-9.08	-0.11	-11.19	4.00	-0.21	-0.84	0.06	-8.92	4.00	4.22	-1.37				
0.00	10.00	-7.54	-1.06	-8.74	-11.29	4.00	0.00	10.00	-1.09	-13.94	-0.55	-12.69	4.00	-0.20	-0.84	0.06	-8.92	4.00	4.22	-1.37				
0.00	20.00	-4.93	-0.85	-5.63	-10.21	4.00	0.00	20.00	-1.99	-27.12	-1.31	-14.85	4.00	-0.21	-0.84	0.06	-8.93	4.00	4.21	-1.37				
0.00	30.00	-3.15	-0.91	-3.55	-9.49	4.00	0.00	30.00	-3.29	-18.85	-2.42	-18.09	4.00	-0.21	-0.84	0.06	-8.93	4.00	4.21	-1.37				
0.00	40.00	-1.89	-1.24	-2.10	-9.07	4.00	0.00	40.00	-5.13	-11.41	-4.02	-23.81	4.00	-0.20	-0.84	0.06	-8.93	4.00	4.21	-1.37				
0.00	50.00	-1.03	-1.86	-1.08	-8.92	4.00	0.00	50.00	-7.84	-7.63	-6.31	-48.92	4.00	-0.21	-0.84	0.06	-8.92	4.00	4.21	-1.37				
0.00	60.00	-0.49	-2.82	-0.41	-9.05	4.00	0.00	60.00	-12.21	-5.21	-9.81	-24.46	4.00	-0.21	-0.84	0.06	-8.93	4.00	4.21	-1.37				
0.00	70.00	-0.23	-4.20	-0.04	-9.44	4.00	0.00	70.00	-22.24	-3.53	-16.33	-18.40	4.00	-0.20	-0.84	0.06	-8.92	4.00	4.22	-1.37				
0.00	80.00	-0.24	-6.17	0.06	-10.14	4.00	0.00	80.00	-20.63	-2.35	-32.97	-15.04	4.00	-0.20	-0.84	0.06	-8.92	4.00	4.22	-1.37				
0.00	90.00	-0.53	-9.08	-0.11	-11.19	4.00	0.00	90.00	-11.69	-1.54	-14.11	-12.83	4.00	-0.21	-0.84	0.06	-8.92	4.00	4.22	-1.37				
0.00	100.00	-1.09	-13.94	-0.55	-12.69	4.00	0.00	100.00	-7.54	-1.06	-8.74	-11.29	4.00	-0.20	-0.84	0.06	-8.92	4.00	4.22	-1.37				
0.00	110.00	-1.99	-27.12	-1.31	-14.85	4.00	0.00	110.00	-4.93	-0.85	-5.63	-10.21	4.00	-0.21	-0.84	0.06	-8.93	4.00	4.21	-1.37				
0.00	120.00	-3.29	-18.85	-2.42	-18.09	4.00	0.00	120.00	-3.15	-0.91	-3.55	-9.49	4.00	-0.21	-0.84	0.06	-8.93	4.00	4.21	-1.37				
0.00	130.00	-5.13	-11.41	-4.02	-23.81	4.00	0.00	130.00	-1.89	-1.24	-2.10	-9.07	4.00	-0.20	-0.84	0.06	-8.93	4.00	4.21	-1.37				
0.00	140.00	-7.84	-7.63	-6.31	-48.92	4.00	0.00	140.00	-1.03	-1.86	-1.08	-8.92	4.00	-0.21	-0.84	0.06	-8.92	4.00	4.21	-1.37				
0.00	150.00	-12.21	-5.21	-9.81	-24.46	4.00	0.00	150.00	-0.49	-2.82	-0.41	-9.05	4.00	-0.21	-0.84	0.06	-8.93	4.00	4.21	-1.37				
0.00	160.00	-22.24	-3.53	-16.33	-18.40	4.00	0.00	160.00	-0.23	-4.20	-0.04	-9.44	4.00	-0.20	-0.84	0.06	-8.92	4.00	4.22	-1.37				
0.00	170.00	-20.63	-2.35	-32.97	-15.04	4.00	0.00	170.00	-0.24	-7.06	0.06	-10.14	4.00	-0.20	-0.84	0.06	-8.92	4.00	4.22	-1.37				
0.00	180.00	-11.69	-1.54	-14.11	-12.83	4.00	0.00	180.00	-0.53	-9.08	-0.11	-11.19	4.00	-0.21	-0.84	0.06	-8.92	4.00	4.22	-1.37				
0.00	190.00	-7.54	-1.06	-8.74	-11.29	4.00	0.00	190.00	-1.09	-13.94	-0.55	-12.69	4.00	-0.20	-0.84	0.06	-8.92	4.00	4.22	-1.37				
0.00	200.00	-4.93	-0.85	-5.63	-10.21	4.00	0.00	200.00	-1.99	-27.12	-1.31	-14.85	4.00	-0.21	-0.84	0.06	-8.93	4.00	4.21	-1.37				
0.00	210.00	-3.15	-0.91	-3.55	-9.49	4.00	0.00	210.00	-3.29	-18.85	-2.42	-18.09	4.00	-0.21	-0.84	0.06	-8.93	4.00	4.21	-1.37				
0.00	220.00	-1.89	-1.24	-2.10	-9.07	4.00	0.00	220.00	-5.13	-11.41	-4.02	-23.81	4.00	-0.20	-0.84	0.06	-8.93	4.00	4.21	-1.37				
0.00	230.00	-1.03	-1.86	-1.08	-8.92	4.00	0.00	230.00	-7.84	-7.63	-6.31	-48.92	4.00	-0.21	-0.84	0.06	-8.92	4.00	4.21	-1.37				
0.00	240.00	-0.49	-2.82	-0.41	-9.05	4.00	0.00	240.00	-12.21	-5.21	-9.81	-24.46	4.00	-0.21	-0.84	0.06	-8.93	4.00	4.21	-1.37				
0.00	250.00	-0.23	-4.20	-0.04	-9.44	4.00	0.00	250.00	-22.24	-3.53	-16.33	-18.40	4.00	-0.20	-0.84	0.06	-8.92	4.00	4.22	-1.37				
0.00	260.00	-0.24	-6.17	0.06	-10.14	4.00	0.00	260.00	-20.63	-2.35	-32.97	-15.04	4.00	-0.20	-0.84	0.06	-8.92	4.00	4.22	-1.37				
0.00	270.00	-0.53	-9.08	-0.11	-11.19	4.00	0.00	270.00	-11.69	-1.54	-14.11	-12.83	4.00	-0.21	-0.84	0.06	-8.92	4.00	4.22	-1.37				
0.00	280.00	-1.09	-13.94	-0.55	-12.69	4.00	0.00	280.00	-7.54	-1.06	-8.74	-11.29	4.00	-0.20	-0.84	0.06	-8.92	4.00	4.22	-1.37				
0.00	290.00	-1.99	-27.12	-1.31	-14.85	4.00	0.00	290.00	-4.93	-0.85	-5.63	-10.21	4.00	-0.21	-0.84	0.06	-8.93	4.00	4.21	-1.37				
0.00	300.00	-3.29	-18.85	-2.42	-18.09	4.00	0.00	300.00	-3.15	-0.91	-3.55	-9.49	4.00	-0.21	-0.84	0.06	-8.93	4.00	4.21	-1.37				
0.00	310.00	-5.13	-11.41	-4.02	-23.81	4.00	0.00	310.00	-1.89	-1.24	-2.10	-9.07	4.00	-0.20	-0.84	0.06	-8.93	4.00	4.21	-1.37				
0.00	320.00	-7.84	-7.63	-6.31	-48.92	4.00	0.00	320.00	-1.03	-1.86	-1.08	-8.92	4.00	-0.21	-0.84	0.06	-8.92	4.00	4.21	-1.37				
0.00	330.00	-12.21	-5.21	-9.81	-24.46	4.00	0.00	330.00	-0.49	-2.82	-0.41	-9.05	4.00	-0.21	-0.84	0.06	-8.93	4.00	4.21	-1.37				
0.00	340.00	-22.24	-3.53	-16.33	-18.40	4.00	0.00	340.00	-0.23	-4.20	-0.04	-9.44	4.00	-0.20	-0.84	0.06	-8.92	4.00	4.22	-1.37				
0.00	350.00	-20.63	-2.35	-32.97	-15.04	4.00	0.00	350.00	-0.24	-7.06	0.06	-10.14	4.00	-0.20	-0.84	0.06	-8.92	4.00	4.22	-1.37				
15.00	0.00	-12.22	-1.96	-5.10	-10.33	4.00	15.00	0.00	0.16	-17.93	-1.61	-9.68	4.00	0.40	-1.85	0.00	-6.98	4.00	4.36	-1.32				
15.00	10.00	-8.33	-0.77	-5.03	-11.98	4.00	15.00	10.00	-1.06	-16.63	-2.00	-9.37	4.00	-0.31	-0.66	-0.25	-7.47	4.00	4.31	-1.38				
15.00	20.00	-6.75	-0.64	-3.57	-11.91	4.00	15.00	20.00	-2.26	-10.01	-3.47	-12.67	4.00	-0.94	-0.16	-0.51	-9.26	4.00	3.99	-1.59				
15.00	30.00	-7.71	-1.29	-2.49	-12.38	4.00	15.00	30.00	-3.89	-7.84	-6.30	-15.15	4.00	-2.38	-0.42	-0.98	-10.54	4.00	3.24	-2.27				
15.00	40.00	-8.59	-3.97	-1.60	-10.42	4.00	15.00	40.00	-5.26	-8.51	-9.17	-19.42	4.00	-3.60	-2.66	-0.90	-9.91	4.00	2.34	-3.25				
15.00	50.00	-8.01	-4.73	-1.63	-10.48	4.00	15.00	50.00	-6.56	-6.31	-15.02	-22.33	4.00	-4.21	-2.44	-1.44	-10.21	4.00	2.03	-3.56				
15.00	60.00	-5.96	-5.43	-1.06	-11.40	4.00	15.00	60.00	-8.52	-4.01	-20.78	-20.19	4.00	-4.04	-6.15	-1.01	-10.67	4.00	2.38	-3.12				
15.00	70.00	-4.51	-7.13	-0.77	-12.59	4.00	15.00	70.00	-13.21	-1.68	-24.08	-14.69	4.00	-3.96	-6.59	-0.75	-10.50	4.00	2.87	-2.59				
15.00	80.00	-4.38	-10.31	-0.70	-14.90	4.00	15.00	80.00	-20.87	-1.62	-15.80	-10.05	4.00	-4.28	-1.07	-0.57	-8.82	4.00	2.90	-2.67				
15.00	90.00	-5.14	-13.21	-0.84	-12.04	4.00	15.00	90.00	-17.27	-0.78	-10.61	-8.42	4.00	-4.88	-0.54	-0.40	-6.85	4.00	3.28	-2.36				
15.00	100.00	-4.13	-17.05	-1.34	-12.09	4.00	15.00	100.00	-14.17	-1.71	-8.29	-7.27	4.00	-4.62	-1.58	-0.54	-6.03	4.00	3.11	-2.65				
15.00	110.00	-5.76	-15.08	-0.57	-11.01	4.00	15.00	110.00	-9.17	-2.98	-6.51	-8.40	4.00	-4.13	-2.15	-0.42	-5.60	4.00	3.30	-2.37				
15.00	120.00	-6.38	-12.53	-0.78	-10.15	4.00	15.00	120.00	-5.65	-2.76	-5.21	-8.48	4.00	-2.98	-2.32	0.56	-6.22	4.00	3.60	-2.11				
15.00	130.00	-7.59	-9.83	-0.01	-7.74	4.00	15.00	130.00	-4.47	-2.73	-5.01	-11.09	4.00	-2.75	-1.96	1.18	-6.09	4.00	4.00	-1.66				
15.00	140.00	-8.03	-9.55	-0.31	-7.15	4.00	15.00	140.00	-2.93	-1.89	-3.23	-11.36	4.00	-1.76	-1.20	1.48	-5.75	4.00	4.58	-1.11				
15.00	150.00	-10.61	-6.72	-1.41	-7.36	4.00	15.00	150.00	-2.39	-1.87	-1.84	-14.25	4.00	-1.78	-0.64	1.39	-6.55	4.00	4.58	-1.07				
15.00	160.00	-11.79	-4.78	-3.55	-6.47	4.00	15.00	160.00	-0.90	-2.20	0.22	-14.75	4.00	-0.56	-0.29	1.74	-5.87	4.00	5.19	-0.50				
15.00	170.00	-12.42	-2.57	-5.79	-6.17	4.00	15.00	170.00	-0.46	-2.56	1.30	-13.86	4.00	-0.19	-0.07	2.08	-5.49	4.00	5.19	-0.18				
15.00	180.00	-9.71	-0.99	-8.34	-7.27	4.00	15.00	180.00	0.22	-7.29	1.89	-14.11	4.00	0.64	-0.08	2.28	-6.45	4.00	5.68	0.06				
15.00	190.00	-8.06	-0.93	-15.07	-6.80	4.00	15.00	190.00	0.48	-15.41	1.46	-6.87	4.00	1.05	-0.78	1.56	-6.46	4.00	5.38	-0.26				
15.00	200.00	-6.11	-0.63	-22.96	-8.02	4.00	15.00	200.00	-0.34	-17.96	0.75	-16.24	4.00	0.68	-0.55	0.77	-7.41	4.00	4.96	-0.67				
15.00	210.00	-4.68	-0.81	-15.11	-7.80	4.00	15.00	210.00	-1.17	-12.36	0.26	-13.43	4.00	0.43	-0.52	0.38	-6.75	4.00	4.86	-0.84				



45.00	190.00	-13.57	-3.53	-6.03	-4.79	4.00	45.00	190.00	-0.03	-21.01	1.11	-23.66	4.00
45.00	200.00	-8.34	-2.97	-8.78	-3.28	4.00	45.00	200.00	0.01	-15.89	1.52	-24.72	4.00
45.00	210.00	-4.24	-4.47	-9.56	-3.69	4.00	45.00	210.00	0.79	-10.92	0.95	-27.39	4.00
45.00	220.00	-1.63	-3.94	-13.18	-5.74	4.00	45.00	220.00	-0.07	-6.54	0.86	-17.92	4.00
45.00	230.00	-1.05	-6.69	-14.98	-5.43	4.00	45.00	230.00	-1.95	-7.23	0.17	-18.10	4.00
45.00	240.00	-3.16	-7.82	-13.03	-5.59	4.00	45.00	240.00	-2.95	-1.67	-2.35	-14.79	4.00
45.00	250.00	-3.97	-7.45	-13.40	-6.02	4.00	45.00	250.00	-6.19	-1.24	-7.15	-13.04	4.00
45.00	260.00	-5.10	-5.05	-14.77	-5.74	4.00	45.00	260.00	-12.10	2.12	-14.20	-19.49	4.00
45.00	270.00	-4.95	-4.67	-17.13	-5.85	4.00	45.00	270.00	-23.48	2.37	-20.82	-22.62	4.00
45.00	280.00	-4.14	-5.52	-18.07	-6.66	4.00	45.00	280.00	-18.28	3.21	-8.82	-17.31	4.00
45.00	290.00	-3.47	-7.66	-21.04	-4.30	4.00	45.00	290.00	-11.63	2.38	-2.58	-24.73	4.00
45.00	300.00	-2.16	-13.66	-15.84	-4.14	4.00	45.00	300.00	-4.93	0.05	-0.93	-16.34	4.00
45.00	310.00	-2.14	-9.26	-9.67	-2.92	4.00	45.00	310.00	-1.51	0.41	-1.10	-13.47	4.00
45.00	320.00	-3.96	-6.20	-9.75	-3.21	4.00	45.00	320.00	-0.70	-0.09	0.34	-18.32	4.00
45.00	330.00	-6.62	-3.26	-6.50	-2.51	4.00	45.00	330.00	0.18	-2.54	-0.48	-23.32	4.00
45.00	340.00	-10.73	-5.40	-4.09	-0.94	4.00	45.00	340.00	0.05	-5.84	0.87	-12.20	4.00
45.00	350.00	-15.30	-3.85	-2.83	-1.98	4.00	45.00	350.00	1.12	-14.34	-0.86	-10.18	4.00
60.00	0.00	-9.53	-1.04	-3.44	-1.13	4.00	60.00	0.00	-0.35	-10.92	-0.05	-12.66	4.00
60.00	10.00	-14.70	-0.97	-1.82	-3.66	4.00	60.00	10.00	0.58	-3.17	-1.99	-20.70	4.00
60.00	20.00	-21.45	-0.32	-2.15	-5.33	4.00	60.00	20.00	0.40	-4.81	-0.58	-17.35	4.00
60.00	30.00	-13.89	-2.75	-5.23	-7.44	4.00	60.00	30.00	-0.91	-3.08	-3.88	-31.12	4.00
60.00	40.00	-21.00	-6.52	-7.41	-12.02	4.00	60.00	40.00	-2.92	-1.28	-7.25	-12.35	4.00
60.00	50.00	-21.97	-6.38	-9.69	-16.65	4.00	60.00	50.00	-6.51	-1.81	-5.43	-9.88	4.00
60.00	60.00	-11.13	-7.32	-9.57	-18.11	4.00	60.00	60.00	-9.94	-2.11	-10.80	-11.65	4.00
60.00	70.00	-9.59	-11.68	-9.02	-23.05	4.00	60.00	70.00	-11.23	-4.82	-19.39	-26.91	4.00
60.00	80.00	-13.00	-19.77	-9.75	-15.41	4.00	60.00	80.00	-13.84	-8.90	-7.06	-14.35	4.00
60.00	90.00	-17.02	-16.13	-9.30	-16.82	4.00	60.00	90.00	-17.51	-3.16	-10.36	-13.48	4.00
60.00	100.00	-13.80	-10.78	-9.82	-17.89	4.00	60.00	100.00	-11.18	-6.94	-12.88	-22.33	4.00
60.00	110.00	-11.00	-12.43	-8.83	-18.81	4.00	60.00	110.00	-7.01	-5.99	-11.68	-22.40	4.00
60.00	120.00	-12.15	-11.86	-5.62	-10.20	4.00	60.00	120.00	-6.51	-0.88	-10.69	-18.43	4.00
60.00	130.00	-18.03	-6.60	-4.05	-7.79	4.00	60.00	130.00	-3.09	-1.20	-4.99	-16.89	4.00
60.00	140.00	-15.46	-7.79	-4.74	-8.27	4.00	60.00	140.00	-1.76	-2.97	-4.05	-17.07	4.00
60.00	150.00	-24.91	-6.17	-5.69	-3.55	4.00	60.00	150.00	-1.81	-8.03	-1.76	-16.17	4.00
60.00	160.00	-22.92	-11.14	-5.31	-5.21	4.00	60.00	160.00	-2.66	-9.10	-3.06	-16.75	4.00
60.00	170.00	-18.15	-8.98	-6.52	-17.69	4.00	60.00	170.00	-1.18	-12.49	-3.18	-19.18	4.00
60.00	180.00	-14.10	-9.78	-6.93	-4.25	4.00	60.00	180.00	-0.81	-9.93	-0.81	-22.65	4.00
60.00	190.00	-10.93	-5.17	-5.39	-4.16	4.00	60.00	190.00	-1.21	-16.65	-1.29	-38.26	4.00
60.00	200.00	-8.05	-6.17	-6.08	-4.42	4.00	60.00	200.00	0.17	-18.96	-1.32	-25.06	4.00
60.00	210.00	-6.24	-6.15	-7.07	-5.08	4.00	60.00	210.00	-0.04	-10.84	-0.41	-21.00	4.00
60.00	220.00	-6.38	-5.02	-8.86	-5.28	4.00	60.00	220.00	-0.37	-6.60	-0.78	-26.06	4.00
60.00	230.00	-8.00	-5.94	-8.93	-5.28	4.00	60.00	230.00	-2.35	-6.40	-0.49	-27.91	4.00
60.00	240.00	-10.18	-8.12	-10.88	-4.71	4.00	60.00	240.00	-7.82	-1.76	-2.99	-21.49	4.00
60.00	250.00	-7.09	-10.20	-12.36	-3.09	4.00	60.00	250.00	-15.06	-0.14	-6.92	-17.59	4.00
60.00	260.00	-5.12	-11.89	-14.89	-4.06	4.00	60.00	260.00	-32.02	-1.36	-13.52	-20.65	4.00
60.00	270.00	-4.65	-15.03	-14.48	-3.09	4.00	60.00	270.00	-13.34	-1.83	-12.13	-21.14	4.00
60.00	280.00	-6.43	-17.43	-13.12	-1.90	4.00	60.00	280.00	-8.42	-3.15	-6.02	-30.17	4.00
60.00	290.00	-8.28	-11.71	-10.97	-1.74	4.00	60.00	290.00	-6.53	-3.47	-4.24	-20.55	4.00
60.00	300.00	-10.25	-8.98	-7.84	-2.17	4.00	60.00	300.00	-6.30	-0.62	-2.02	-15.68	4.00
60.00	310.00	-8.33	-13.70	-7.16	-3.45	4.00	60.00	310.00	-5.86	-0.42	0.11	-13.75	4.00
60.00	320.00	-7.65	-11.86	-7.15	-2.87	4.00	60.00	320.00	-1.67	-1.52	-0.84	-18.73	4.00
60.00	330.00	-8.97	-6.03	-3.95	-0.94	4.00	60.00	330.00	-0.91	-2.55	0.95	-12.24	4.00
60.00	340.00	-8.13	-4.19	-3.44	-0.17	4.00	60.00	340.00	0.70	-8.27	-0.76	-22.38	4.00
60.00	350.00	-12.02	-3.13	-1.26	-0.52	4.00	60.00	350.00	0.86	-10.83	-2.07	-11.35	4.00
75.00	0.00	-8.25	-4.46	-6.74	1.09	4.00	75.00	0.00	-0.51	-29.44	-0.95	-17.12	4.00
75.00	10.00	-13.77	-0.44	-5.42	-1.16	4.00	75.00	10.00	1.51	-10.98	-2.08	-21.46	4.00
75.00	20.00	-21.94	-0.01	-6.57	-4.81	4.00	75.00	20.00	1.46	-3.27	-3.18	-26.82	4.00
75.00	30.00	-14.29	-5.66	-6.45	-10.95	4.00	75.00	30.00	1.09	-6.71	-3.91	-16.86	4.00
75.00	40.00	-14.23	-9.67	-8.68	-15.56	4.00	75.00	40.00	2.06	-2.06	-7.72	-15.76	4.00
75.00	50.00	-12.55	-24.57	-8.84	-12.88	4.00	75.00	50.00	-2.32	-0.83	-0.85	-16.83	4.00
75.00	60.00	-11.07	-20.59	-8.34	-24.46	4.00	75.00	60.00	-3.42	-2.14	-1.08	-28.11	4.00
75.00	70.00	-14.07	-12.47	-10.05	-13.52	4.00	75.00	70.00	-4.78	-8.64	-8.34	-16.10	4.00
75.00	80.00	-11.14	-14.17	-10.09	-13.36	4.00	75.00	80.00	-9.52	0.88	-7.48	-16.10	4.00
75.00	90.00	-7.69	-11.60	-8.79	-22.12	4.00	75.00	90.00	-16.74	1.63	-11.92	-13.25	4.00
75.00	100.00	-9.97	-7.59	-8.19	-20.89	4.00	75.00	100.00	-10.68	-2.84	-12.83	-12.82	4.00
75.00	110.00	-13.76	-8.79	-13.72	-12.28	4.00	75.00	110.00	-6.25	-9.15	-9.86	-18.32	4.00
75.00	120.00	-10.86	-13.44	-10.30	-12.91	4.00	75.00	120.00	-5.64	-4.85	-8.40	-14.37	4.00
75.00	130.00	-15.36	-9.65	-6.62	-6.80	4.00	75.00	130.00	-2.13	-0.37	-11.09	-15.48	4.00
75.00	140.00	-20.70	-11.78	-6.59	-4.82	4.00	75.00	140.00	-2.65	-2.46	-9.48	-13.71	4.00
75.00	150.00	-20.41	-6.34	-6.68	-4.22	4.00	75.00	150.00	-3.01	-8.68	-9.35	-11.91	4.00
75.00	160.00	-19.98	-7.51	-7.47	-3.53	4.00	75.00	160.00	-2.67	-13.01	-11.11	-17.93	4.00
75.00	170.00	-24.49	-16.71	-5.47	-1.70	4.00	75.00	170.00	-0.47	-9.86	-8.44	-15.06	4.00
75.00	180.00	-22.28	-22.11	-5.34	-0.61	4.00	75.00	180.00	-0.70	-13.47	-4.10	-22.62	4.00
75.00	190.00	-14.41	-14.57	-4.22	-0.42	4.00	75.00	190.00	-1.14	-16.59	-6.56	-24.90	4.00
75.00	200.00	-8.83	-11.15	-4.70	-0.31	4.00	75.00	200.00	-0.70	-11.30	-5.37	-17.03	4.00
75.00	210.00	-8.84	-8.89	-5.82	-1.09	4.00	75.00	210.00	-0.81	-9.55	-3.34	-21.00	4.00
75.00	220.00	-7.05	-6.93	-5.42	-2.63	4.00	75.00	220.00	-2.15	-6.30	-3.16	-14.41	4.00
75.00	230.00	-9.74	-9.97	-4.08	-2.50	4.00	75.00	230.00	-4.82	-5.94	-4.09	-11.98	4.00
75.00	240.00	-8.52	-14.64	-4.70	-2.83	4.00	75.00	240.00	-8.69	-6.92	-6.92	-14.18	4.00
75.00	250.00	-6.11	-8.98	-5.18	-2.71	4.00	75.00	250.00	-13.52	-2.00	-6.90	-20.02	4.00
75.00	260.00	-4.16	-9.13	-5.27	-0.61	4.00	75.00	260.00	-13.04	-0.70	-9.53	-32.96	4.00
75.00	270.00	-4.35	-13.62	-5.39	0.45	4.00	75.00	270.00	-14.27	-3.73	-13.95	-18.59	4.00
75.00	280.00	-6.81	-23.57	-5.91	0.05	4.00	75.00	280.00	-3.89	-3.89	-7.77	-23.34	4.00
75.00	290.00	-13.37	-16.93	-6.27	1.08	4.00	75.00	290.00	-15.74	-3.39	-3.08	-23.18	4.00
75.00	300.00	-13.64	-16.77	-5.56	1.34	4.00	75.00	300.00	-7.95	-0.66	-3.09	-22.19	4.00
75.00	310.00	-10.52	-10.33	-3.60	1.59	4.00	75.00	310.00	-5.57	0.38	-1.46	-14.33	4.00
75.00	320.00	-8.60	-12.54	-4.69	-0.94	4.00	75.00	320.00	-3.02	-0.08	0.41	-17.39	4.00
75.00	330.00	-8.92	-11.56	-3.75	-1.04	4.00	75.00	330.00	-2.57	-3.11	-1.03	-15.93	4.00
75.00	340.00	-7.40	-7.83	-2.74	0.10	4.00	75.00	340.00	-1.90	-4.12	-1.71	-14.53	4.00
75.00	350.00	-11.40	-5.86	-4.07									



105.00	100.00	-7.64	-14.33	-16.96	-29.71	4.00	105.00	100.00	-14.26	-18.00	-13.28	-12.21	4.00	-6.78	-12.78	-11.73	-12.13	4.00	-4.48	-10.10	
105.00	110.00	-18.71	-11.24	-27.48	-14.39	4.00	105.00	110.00	-9.39	-5.92	-7.55	-10.78	4.00	-8.91	-4.80	-7.51	-9.21	4.00	-1.40	-7.23	
105.00	120.00	-14.23	-9.90	-12.31	-10.89	4.00	105.00	120.00	-14.78	-6.66	-12.55	-7.63	4.00	-11.49	-4.97	-9.42	-5.95	4.00	-1.55	-7.23	
105.00	130.00	-10.42	-14.41	-14.51	-5.53	4.00	105.00	130.00	-6.67	-15.07	-12.77	-14.30	4.00	-5.14	-11.72	-10.54	-4.99	4.00	-1.55	-7.11	
105.00	140.00	-20.00	-16.43	-15.51	-1.90	4.00	105.00	140.00	-5.24	-13.39	-12.42	-15.32	4.00	-5.10	-11.64	-10.69	-1.71	4.00	-0.30	-5.46	
105.00	150.00	-26.52	-5.00	-17.07	-1.54	4.00	105.00	150.00	-8.11	-6.89	-28.31	-20.20	4.00	-8.05	-2.83	-16.76	-1.48	4.00	0.45	-4.53	
105.00	160.00	-17.65	-4.63	-7.58	-0.82	4.00	105.00	160.00	-7.41	-14.42	-13.01	-15.10	4.00	-7.02	-4.20	-6.49	-0.66	4.00	1.81	-3.81	
105.00	170.00	-18.81	-8.47	-7.75	0.77	4.00	105.00	170.00	-7.74	-9.08	-8.68	-21.85	4.00	-7.41	-5.75	-5.18	0.79	4.00	2.24	-3.12	
105.00	180.00	-16.24	-9.52	-7.19	1.79	4.00	105.00	180.00	-5.64	-19.28	-10.38	-12.57	4.00	-5.28	-0.98	-5.49	1.95	4.00	2.54	-2.46	
105.00	190.00	-22.10	-11.39	-5.77	2.81	4.00	105.00	190.00	-3.65	-14.59	-15.31	-15.14	4.00	-3.59	-9.69	-5.31	2.88	4.00	3.30	-1.58	
105.00	200.00	-9.83	-10.98	-4.25	2.42	4.00	105.00	200.00	-4.96	-18.67	-14.41	-16.00	4.00	-3.73	-10.30	-3.85	2.99	4.00	3.55	-1.37	
105.00	210.00	-15.74	-10.87	-5.54	2.42	4.00	105.00	210.00	-9.10	-12.86	-8.55	-17.52	4.00	-8.25	-10.36	-3.78	2.46	4.00	2.43	-2.30	
105.00	220.00	-22.23	-10.30	-3.64	1.35	4.00	105.00	220.00	-9.76	-19.40	-6.17	-15.95	4.00	-9.52	-9.80	-1.71	2.43	4.00	2.07	-2.44	
105.00	230.00	-28.40	-13.73	-4.56	-7.70	4.00	105.00	230.00	-15.70	-9.68	-6.06	-15.31	4.00	-15.47	-8.24	-2.24	-0.55	4.00	1.49	-3.83	
105.00	240.00	-15.97	-19.34	-4.15	-2.23	4.00	105.00	240.00	-13.85	-3.62	-9.40	-17.47	4.00	-11.77	-3.51	-3.02	-2.10	4.00	1.65	-3.90	
105.00	250.00	-13.20	-17.13	-3.64	-2.40	4.00	105.00	250.00	-13.07	-4.30	-8.80	-20.14	4.00	-10.12	-4.08	-2.48	-2.33	4.00	1.77	-3.88	
105.00	260.00	-10.30	-22.40	-2.00	-0.17	4.00	105.00	260.00	-20.60	-7.29	-20.67	-24.58	4.00	-9.91	-7.16	-1.94	-0.15	4.00	2.08	-3.24	
105.00	270.00	-8.76	-17.44	-1.89	1.86	4.00	105.00	270.00	-18.70	-8.81	-20.26	-27.32	4.00	-8.34	-8.25	-1.83	-1.87	4.00	2.98	-2.06	
105.00	280.00	-7.63	-15.24	-1.63	2.45	4.00	105.00	280.00	-13.28	-7.62	-7.27	-17.23	4.00	-6.58	-6.93	-0.58	2.50	4.00	4.05	-1.14	
105.00	290.00	-8.51	-14.23	-2.73	2.72	4.00	105.00	290.00	-8.34	-7.20	-4.86	-13.65	4.00	-5.41	-6.41	-0.66	2.82	4.00	4.41	-0.85	
105.00	300.00	-16.27	-11.99	-4.11	2.75	4.00	105.00	300.00	-4.69	-12.42	-3.39	-16.86	4.00	-4.40	-9.19	-0.72	2.80	4.00	4.22	-0.92	
105.00	310.00	-15.17	-9.82	-3.95	1.13	4.00	105.00	310.00	-2.82	-10.48	-0.88	-22.89	4.00	-2.57	-7.13	0.86	1.15	4.00	4.68	-0.88	
105.00	320.00	-12.62	-10.03	-5.76	-2.13	4.00	105.00	320.00	-4.42	-8.38	-1.34	-12.47	4.00	-3.81	-6.12	0.00	-1.75	4.00	3.40	-2.35	
105.00	330.00	-12.34	-5.71	-8.21	-3.14	4.00	105.00	330.00	-5.82	-4.80	-0.61	-15.48	4.00	-4.95	-2.22	0.09	-2.89	4.00	3.71	-2.12	
105.00	340.00	-21.63	-5.03	-10.03	-2.45	4.00	105.00	340.00	-3.49	-5.47	-0.77	-17.95	4.00	-3.42	-2.23	-0.28	-2.33	4.00	4.03	-1.91	
105.00	350.00	-16.20	-5.40	-10.88	0.27	4.00	105.00	350.00	-5.87	-5.78	-0.88	-13.63	4.00	-5.49	-2.58	-0.47	0.44	4.00	4.28	-1.49	
120.00	0.00	-11.76	-5.01	-17.68	-2.13	4.00	120.00	0.00	-4.76	-9.22	-1.38	-13.04	4.00	-3.97	-3.61	-1.28	-1.79	4.00	3.43	-2.51	
120.00	10.00	-12.02	-5.33	-19.59	-1.87	4.00	120.00	10.00	-5.07	-5.70	-3.51	-19.45	4.00	-4.27	-2.50	-3.40	-1.79	4.00	3.08	-2.89	
120.00	20.00	-8.40	-5.16	-10.91	-2.18	4.00	120.00	20.00	-6.17	-2.77	-4.34	-24.88	4.00	-4.13	-0.79	-3.48	-2.16	4.00	3.48	-2.45	
120.00	30.00	-11.97	-3.78	-12.66	-6.54	4.00	120.00	30.00	-7.81	-6.06	-11.49	-9.10	4.00	-6.40	-3.76	-9.03	-4.62	4.00	0.97	-4.67	
120.00	40.00	-9.54	-9.04	-11.26	-10.86	4.00	120.00	40.00	-14.47	-4.13	-10.56	-6.72	4.00	-8.33	-2.91	-7.89	-5.20	4.00	0.19	-5.55	
120.00	50.00	-6.43	-3.15	-10.80	-11.24	4.00	120.00	50.00	-21.59	1.77	-8.29	-7.97	4.00	-6.30	2.98	-6.36	-6.39	4.00	3.11	-1.73	
120.00	60.00	-6.13	-11.71	-14.80	-16.40	4.00	120.00	60.00	-8.66	-7.02	-6.12	-14.56	4.00	-4.20	-5.75	-5.57	-12.37	4.00	0.45	-6.10	
120.00	70.00	-7.93	-7.31	-17.19	-29.94	4.00	120.00	70.00	-15.00	-2.11	-5.37	-15.83	4.00	-7.15	-0.96	-5.09	-15.66	4.00	-0.24	-4.78	
120.00	80.00	-11.06	-26.43	-25.74	-8.00	4.00	120.00	80.00	-9.29	-15.09	-10.23	-20.74	4.00	-9.05	-0.76	-14.78	-13.40	4.00	-2.34	-6.04	
120.00	90.00	-9.95	-15.05	-31.22	-20.67	4.00	120.00	90.00	-6.24	-13.07	-7.20	-15.58	4.00	-4.70	-10.94	-7.18	-14.45	4.00	-2.54	-7.91	
120.00	100.00	-7.47	-16.14	-35.33	-31.76	4.00	120.00	100.00	-7.22	-9.23	-7.83	-13.82	4.00	-4.33	-8.42	-7.82	-13.73	4.00	-1.95	-7.45	
120.00	110.00	-12.97	-11.36	-21.28	-20.83	4.00	120.00	110.00	-29.13	-39.26	-7.55	-11.90	4.00	-12.87	-11.35	-7.37	-11.38	4.00	-4.47	-10.21	
120.00	120.00	-10.44	-10.34	-13.52	-11.61	4.00	120.00	120.00	-7.38	-6.34	-7.49	-14.20	4.00	-5.64	-4.88	-6.52	-9.70	4.00	-0.48	-6.35	
120.00	130.00	-8.89	-21.28	-12.96	-8.10	4.00	120.00	130.00	-10.78	-20.93	-21.97	-19.07	4.00	-6.72	-18.09	-12.45	-7.77	4.00	-4.20	-9.47	
120.00	140.00	-11.68	-5.05	-13.28	-4.68	4.00	120.00	140.00	-15.93	-4.33	-18.55	-25.01	4.00	-10.29	-1.72	-12.15	-4.64	-18.55	4.00	-0.18	-5.33
120.00	150.00	-28.23	-3.86	-13.24	-5.54	4.00	120.00	150.00	-10.21	-8.44	-10.18	-16.31	4.00	-10.14	-2.56	-8.44	-5.19	4.00	-0.07	-5.62	
120.00	160.00	-16.49	-3.52	-9.88	-1.21	4.00	120.00	160.00	-5.73	-25.48	-23.74	-13.11	4.00	-5.38	-3.49	-9.71	-0.94	4.00	1.70	-3.85	
120.00	170.00	-14.14	-3.50	-10.47	0.16	4.00	120.00	170.00	-8.87	-18.61	-13.41	-17.21	4.00	-7.74	-3.37	-8.69	0.24	4.00	1.88	-3.42	
120.00	180.00	-10.77	-5.32	-9.13	1.28	4.00	120.00	180.00	-6.54	-13.63	-15.31	-13.16	4.00	-5.15	-4.72	-8.19	1.43	4.00	2.61	-2.63	
120.00	190.00	-9.230	-15.21	-5.87	1.52	4.00	120.00	190.00	-11.38	-15.45	-9.88	-13.25	4.00	-11.35	-12.32	-4.42	1.66	4.00	1.31	-3.10	
120.00	200.00	-8.10	-11.29	-5.11	2.42	4.00	120.00	200.00	-13.88	-7.26	-10.85	-20.37	4.00	-7.08	-5.81	-4.08	2.44	4.00	3.24	-1.86	
120.00	210.00	-14.14	-20.25	-5.51	1.69	4.00	120.00	210.00	-14.45	-17.19	-7.02	-17.33	4.00	-11.28	-15.45	-3.19	1.74	4.00	1.43	-2.85	
120.00	220.00	-19.60	-30.32	-4.55	-0.60	4.00	120.00	220.00	-11.95	-20.13	-7.23	-13.43	4.00	-11.26	-19.73	-2.68	-0.38	4.00	0.29	-4.14	
120.00	230.00	-14.95	-19.83	-4.85	-2.22	4.00	120.00	230.00	-9.75	-6.57	-6.46	-22.77	4.00	-8.60	-6.37	-2.57	-2.18	4.00	1.49	-4.18	
120.00	240.00	-11.37	-17.42	-3.77	-6.07	4.00	120.00	240.00	-14.74	-14.35	-6.08	-12.26	4.00	-9.73	-12.61	-1.76	-5.13	4.00	-0.31	-5.47	
120.00	250.00	-12.22	-16.12	-4.38	-5.66	4.00	120.00	250.00	-13.46	-14.05	-5.82	-11.91	4.00	-9.79	-11.95	-2.03	-4.74	4.00	-0.23	-5.48	
120.00	260.00	-11.40	-18.37	-4.36	-1.85	4.00	120.00	260.00	-8.91	-10.28	-8.84	-14.48	4.00	-6.97	-9.65	-3.04	-1.62	4.00	1.26	-4.27	
120.00	270.00	-10.58	-14.63	-2.53	0.89	4.00	120.00	270.00	-6.54	-7.42	-22.76	-23.39	4.00	-5.10	-6.66	-2.49	0.91	4.00	3.17	-2.36	
120.00	280.00	-10.20	-12.77	-2.28	2.64	4.00	120.00	280.00	-6.92	-5.59	-11.01	-12.19	4.00	-5.25	-4.83	-6.92	-1.73	2.78	4.00	4.39	-0.98
120.00	290.00	-8.95	-11.48	-1.79	3.02	4.00	120.00	290.00	-6.54	-4.76	-5.56	-10.78	4.00	-4.57	-3.92	-0.27	3.20	4.00	5.21	-0.24	
120.00	300.00	-7.42	-8.54	-1.95	2.43	4.00	120.00	300.00	-4.61	-5.14	-3.39	-9.83	4.00	-2.78	-3.51	0.40	2.68	4.00	5.58	-0.08	
120.00	310.00	-8.08	-1.08	-1.00	0.00	4.00	120.00	310.00	-3.73	-3.36	-0.77	-33.25	4.00	-2.53	-1.82	0.66	0.00	4.00	5.73	-0.73	
120.00	320.00	-12.12	-5.64	-6.32	-4.31	4.00	120.00	320.00	-5.05	-3.03	-0.66	-16.26	4.00	-4.27	-1.13	-3.13	-3.51	4.00	4.08	-0.74	
120.00	330.00	-11.58	-4.28	-9.23	-5.84	4.00	120.00	330.00	-6.51	-3.54	-2.23	-2									



165.00	10.00	-14.37	-14.68	-19.42	-15.65	4.00	165.00	10.00	-7.29	-5.79	-8.17	-9.18	4.00	-6.51	-5.26	-7.86	-8.30	4.00	-0.88	-6.82
165.00	20.00	-18.06	-4.37	-25.60	-19.46	4.00	165.00	20.00	-8.93	-11.44	-8.79	-12.36	4.00	-8.43	-3.59	-8.70	-11.59	4.00	-1.56	-7.07
165.00	30.00	-19.97	-2.81	-16.91	-23.05	4.00	165.00	30.00	-11.97	-9.77	-8.26	-9.51	4.00	-11.33	-2.01	-7.70	-9.32	4.00	-0.83	-6.07
165.00	40.00	-18.47	-7.79	-11.53	-19.27	4.00	165.00	40.00	-17.57	-6.41	-6.57	-8.54	4.00	-14.99	-4.04	-5.37	-8.19	4.00	-1.23	-6.63
165.00	50.00	-16.02	-22.35	-10.36	-22.06	4.00	165.00	50.00	-21.88	-7.08	-7.84	-8.84	4.00	-15.02	-6.95	-5.91	-8.64	4.00	-2.48	-8.05
165.00	60.00	-16.27	-16.11	-9.07	-27.33	4.00	165.00	60.00	-21.20	-7.20	-13.54	-13.60	4.00	-15.06	-6.67	-7.74	-13.42	4.00	-3.99	-9.39
165.00	70.00	-18.35	-14.02	-11.99	-29.16	4.00	165.00	70.00	-19.24	-5.06	-31.22	-14.79	4.00	-15.76	-4.54	-11.94	-14.63	4.00	-4.48	-9.24
165.00	80.00	-17.49	-14.58	-16.47	-32.53	4.00	165.00	80.00	-19.54	-3.43	-27.81	-16.33	4.00	-15.38	-3.11	-16.16	-16.23	4.00	-4.59	-8.49
165.00	90.00	-15.05	-10.22	-23.31	-22.35	4.00	165.00	90.00	-21.62	-3.30	-29.01	-17.68	4.00	-14.19	-2.50	-22.27	-16.41	4.00	-4.63	-8.03
165.00	100.00	-13.23	-8.30	-24.93	-19.53	4.00	165.00	100.00	-25.00	-5.33	-22.75	-20.59	4.00	-12.95	-3.56	-20.69	-17.02	4.00	-5.02	-8.86
165.00	110.00	-15.47	-7.22	-16.45	-14.23	4.00	165.00	110.00	-27.85	-7.23	-18.03	-22.89	4.00	-15.23	-4.21	-14.16	-13.68	4.00	-4.50	-9.12
165.00	120.00	-13.00	-8.21	-15.24	-12.74	4.00	165.00	120.00	-25.01	-7.31	-11.97	-20.08	4.00	-12.73	-4.73	-10.29	-12.00	4.00	-3.30	-8.64
165.00	130.00	-12.55	-8.88	-15.47	-14.02	4.00	165.00	130.00	-18.33	-6.32	-7.50	-24.51	4.00	-11.53	-4.40	-6.86	-13.85	4.00	-2.33	-7.68
165.00	140.00	-14.12	-9.28	-13.97	-19.50	4.00	165.00	140.00	-14.94	-7.90	-6.90	-26.70	4.00	-11.50	-5.53	-6.12	-18.74	4.00	-3.07	-8.18
165.00	150.00	-14.93	-7.54	-13.42	-22.81	4.00	165.00	150.00	-15.06	-7.86	-7.13	-19.06	4.00	-11.98	-4.69	-6.21	-17.53	4.00	-2.75	-7.83
165.00	160.00	-21.64	-7.47	-13.55	-22.30	4.00	165.00	160.00	-13.15	-8.01	-8.84	-14.75	4.00	-12.57	-4.72	-7.58	-14.05	4.00	-2.90	-8.19
165.00	170.00	-17.28	-7.57	-10.03	-21.43	4.00	165.00	170.00	-10.43	-9.27	-10.26	-12.40	4.00	-9.61	-5.33	-7.33	-11.89	4.00	-2.12	-7.82
165.00	180.00	-10.57	-7.46	-10.10	-20.39	4.00	165.00	180.00	-9.82	-14.23	-10.59	-13.02	4.00	-7.17	-6.63	-7.33	-12.29	4.00	-2.06	-7.87
165.00	190.00	-8.60	-8.83	-11.75	-21.49	4.00	165.00	190.00	-16.33	-20.12	-10.74	-13.84	4.00	-7.92	-8.52	-8.21	-13.15	4.00	-3.19	-9.02
165.00	200.00	-7.95	-9.79	-15.63	-24.43	4.00	165.00	200.00	-19.39	-10.68	-16.92	-11.16	4.00	-7.65	-7.20	-13.22	-10.96	4.00	-3.40	-9.12
165.00	210.00	-9.75	-13.45	-13.96	-24.25	4.00	165.00	210.00	-16.75	-6.29	-21.10	-14.92	4.00	-8.96	-5.53	-13.19	-14.44	4.00	-3.78	-9.11
165.00	220.00	-8.29	-15.47	-12.59	-21.43	4.00	165.00	220.00	-15.20	-2.70	-14.74	-16.83	4.00	-7.48	-2.48	-10.52	-15.54	4.00	-1.73	-6.67
165.00	230.00	-7.43	-20.64	-15.95	-16.01	4.00	165.00	230.00	-14.88	-0.52	-12.38	-16.68	4.00	-6.71	-0.48	-10.80	-13.32	4.00	-0.39	-5.09
165.00	240.00	-9.30	-26.28	-22.50	-16.77	4.00	165.00	240.00	-13.05	-0.42	-10.98	-14.70	4.00	-7.77	-0.41	-10.68	-12.60	4.00	-0.49	-5.17
165.00	250.00	-15.89	-19.59	-26.11	-16.64	4.00	165.00	250.00	-11.59	-0.40	-9.19	-13.36	4.00	-10.22	-0.35	-9.10	-11.69	4.00	-0.54	-5.20
165.00	260.00	-20.98	-14.59	-29.34	-14.40	4.00	165.00	260.00	-8.55	-1.49	-8.16	-10.49	4.00	-8.31	-1.28	-8.13	-9.01	4.00	-0.03	-5.33
165.00	270.00	-20.44	-10.94	-24.93	-13.52	4.00	165.00	270.00	-6.36	-4.96	-7.29	-7.89	4.00	-6.19	-3.98	-7.22	-6.84	4.00	0.06	-5.86
165.00	280.00	-11.92	-11.46	-31.83	-12.50	4.00	165.00	280.00	-5.26	-8.44	-6.83	-7.78	4.00	-4.41	-6.68	-6.82	-6.54	4.00	-0.03	-5.99
165.00	290.00	-11.19	-15.65	-22.62	-10.86	4.00	165.00	290.00	-6.12	-16.28	-5.82	-5.80	4.00	-4.94	-12.94	-5.73	-4.62	4.00	-0.46	-6.09
165.00	300.00	-9.01	-12.57	-22.01	-11.15	4.00	165.00	300.00	-4.57	-14.84	-5.95	-6.18	4.00	-3.24	-10.55	-5.84	-4.98	4.00	0.26	-5.45
165.00	310.00	-10.16	-8.97	-18.00	-8.83	4.00	165.00	310.00	-4.74	-26.93	-5.33	-6.58	4.00	-3.64	-8.90	-5.10	-4.55	4.00	0.69	-5.16
165.00	320.00	-11.68	-3.81	-13.62	-7.08	4.00	165.00	320.00	-6.96	-16.25	-7.76	-8.54	4.00	-5.70	-3.57	-6.76	-4.74	4.00	0.91	-5.03
165.00	330.00	-13.12	-2.04	-12.74	-6.76	4.00	165.00	330.00	-5.76	-12.76	-6.52	-9.58	4.00	-5.03	-1.69	-5.59	-4.93	4.00	1.85	-4.01
165.00	340.00	-18.64	0.20	-17.02	-7.55	4.00	165.00	340.00	-6.43	-14.83	-5.92	-9.87	4.00	-6.18	0.33	-5.60	-5.55	4.00	2.22	-3.29
165.00	350.00	-16.34	-0.37	-18.57	-8.96	4.00	165.00	350.00	-7.08	-13.01	-5.38	-9.21	4.00	-6.59	-0.14	-5.18	-6.07	4.00	1.94	-3.62
180.00	0.00	-13.52	-5.86	-12.34	-8.88	4.00	180.00	0.00	-13.90	-15.36	-18.31	-13.50	4.00	-10.70	-5.40	-11.36	-7.59	4.00	-2.40	-8.09
180.00	10.00	-12.29	-5.50	-11.74	-8.16	4.00	180.00	10.00	-15.80	-21.98	-22.19	-16.73	4.00	-10.69	-5.40	-11.37	-7.59	4.00	-2.41	-8.09
180.00	20.00	-11.46	-5.40	-11.42	-7.74	4.00	180.00	20.00	-18.59	-37.16	-30.01	-22.43	4.00	-10.69	-5.40	-11.36	-7.59	4.00	-2.40	-8.09
180.00	30.00	-10.94	-5.57	-11.38	-7.59	4.00	180.00	30.00	-23.17	-19.42	-36.20	-47.59	4.00	-10.69	-5.39	-11.37	-7.59	4.00	-2.40	-8.09
180.00	40.00	-10.71	-6.02	-11.60	-7.71	4.00	180.00	40.00	-34.39	-14.13	-24.14	-23.18	4.00	-10.69	-5.40	-11.36	-7.59	4.00	-2.40	-8.09
180.00	50.00	-10.74	-6.78	-12.10	-8.11	4.00	180.00	50.00	-29.95	-11.04	-19.42	-17.09	4.00	-10.69	-5.40	-11.36	-7.59	4.00	-2.40	-8.09
180.00	60.00	-11.05	-7.91	-12.92	-8.80	4.00	180.00	60.00	-21.75	-8.98	-16.58	-13.73	4.00	-10.70	-5.40	-11.37	-7.59	4.00	-2.40	-8.09
180.00	70.00	-11.64	-9.51	-14.12	-9.85	4.00	180.00	70.00	-17.78	-7.53	-14.64	-11.51	4.00	-10.69	-5.40	-11.36	-7.59	4.00	-2.40	-8.09
180.00	80.00	-12.56	-11.82	-15.83	-11.35	4.00	180.00	80.00	-15.25	-6.52	-13.28	-9.96	4.00	-10.69	-5.40	-11.36	-7.59	4.00	-2.40	-8.09
180.00	90.00	-13.90	-15.36	-18.31	-13.50	4.00	180.00	90.00	-13.52	-5.86	-12.34	-8.88	4.00	-10.70	-5.40	-11.36	-7.59	4.00	-2.40	-8.09
180.00	100.00	-15.80	-21.98	-22.19	-16.73	4.00	180.00	100.00	-12.29	-5.50	-11.74	-8.16	4.00	-10.69	-5.40	-11.37	-7.59	4.00	-2.41	-8.09
180.00	110.00	-18.59	-37.16	-30.01	-22.43	4.00	180.00	110.00	-11.46	-5.40	-11.42	-7.74	4.00	-10.69	-5.40	-11.36	-7.59	4.00	-2.40	-8.09
180.00	120.00	-23.17	-19.42	-36.20	-47.59	4.00	180.00	120.00	-10.94	-5.57	-11.38	-7.59	4.00	-10.69	-5.39	-11.37	-7.59	4.00	-2.40	-8.09
180.00	130.00	-34.39	-14.13	-24.14	-23.18	4.00	180.00	130.00	-10.71	-6.02	-11.60	-7.71	4.00	-10.69	-5.40	-11.36	-7.59	4.00	-2.40	-8.09
180.00	140.00	-29.95	-11.04	-19.42	-17.09	4.00	180.00	140.00	-10.74	-6.78	-12.10	-8.11	4.00	-10.69	-5.40	-11.36	-7.59	4.00	-2.40	-8.09
180.00	150.00	-21.75	-8.98	-16.58	-13.73	4.00	180.00	150.00	-11.05	-7.91	-12.92	-8.80	4.00	-10.70	-5.40	-11.37	-7.59	4.00	-2.40	-8.09
180.00	160.00	-17.78	-7.53	-14.64	-11.51	4.00	180.00	160.00	-11.64	-9.51	-14.12	-9.85	4.00	-10.69	-5.40	-11.36	-7.59	4.00	-2.40	-8.09
180.00	170.00	-15.25	-6.52	-13.28	-9.96	4.00	180.00	170.00	-12.56	-11.82	-15.83	-11.35	4.00	-10.69	-5.40	-11.36	-7.59	4.00	-2.40	-8.09
180.00	180.00	-13.52	-5.86	-12.34	-8.88	4.00	180.00	180.00	-13.90	-15.36	-18.31	-13.50	4.00	-10.70	-5.40	-11.36	-7.59	4.00	-2.40	-8.09
180.00	190.00	-12.29	-5.50	-11.74	-8.16	4.00	180.00	190.00	-15.80	-21.98	-22.19	-16.73	4.00	-10.69	-5.40	-11.37	-7.59	4.00	-2.41	-8.09
180.00	200.00	-11.46	-5.40	-11.42	-7.74	4.00	180.00	200.00	-18.59	-37.16	-30.01	-22.43	4.00	-10.69	-5.40	-11.36	-7.59	4.00	-2.40	-8.09
180.00	210.00	-10.94	-5.57	-11.38	-7.59	4.00	180.00	210.00	-23.17	-19.42	-36.20	-47.59	4.00	-10.69	-5.39	-11.37	-7.59	4.00	-2.40	-8.09
180.00	220.00	-10.71	-6.02	-11.60	-7.71	4.00	180.00	220.00	-34.39	-14.13	-24.14	-23.18	4.00	-10.69	-5.40	-11.36	-7.59	4.00	-2.40	-8.09
180.00	230.00	-10.74	-6.78	-12.10	-8.11	4.00	180.00	230.00	-29.95	-11.04	-19.42	-17.09	4.00	-10.69	-5.40	-11.36	-7.59	4.00	-2.40	-8.09
180.00	240.																			



Frequency: 6475MHz

Theta Polarization		Max Gain(dBi)				Nant	Phi Polarization		Max Gain(dBi)				Nant	Total				Max DG(dBi)						
Angle (θ)	Angle (φ)	Ant 1(G1)	Ant 2(G2)	Ant 3(G3)	Ant 4(G4)		Angle (θ)	Angle (φ)	Ant 1(G1)	Ant 2(G2)	Ant 3(G3)	Ant 4(G4)		Ant 1(G1)	Ant 2(G2)	Ant 3(G3)	Ant 4(G4)	Nant	6.16	0.23				
		1.34	1.53	0.94	3.31				0.98	3.42	1.14	-5.79									2.01	4.34	2.97	3.46
		Ant 1(G1)	Ant 2(G2)	Ant 3(G3)	Ant 4(G4)				Ant 1(G1)	Ant 2(G2)	Ant 3(G3)	Ant 4(G4)									Ant 1(G1)	Ant 2(G2)	Ant 3(G3)	Ant 4(G4)
0.00	0.00	-10.44	-3.18	-12.57	-13.52	4.00	0.00	0.00	-2.04	-10.72	-0.91	-14.58	4.00	-1.45	-2.48	-0.62	-11.01	4.00	2.95	-2.54				
0.00	10.00	-7.27	-2.70	-8.22	-12.39	4.00	0.00	10.00	-2.78	-15.58	-1.45	-16.65	4.00	-1.46	-2.48	-0.62	-11.01	4.00	2.95	-2.54				
0.00	20.00	-5.15	-2.49	-5.53	-11.63	4.00	0.00	20.00	-3.87	-28.75	-2.31	-19.73	4.00	-1.45	-2.48	-0.62	-11.00	4.00	2.96	-2.54				
0.00	30.00	-3.67	-2.55	-3.68	-11.18	4.00	0.00	30.00	-5.44	-20.50	-3.57	-25.02	4.00	-1.46	-2.48	-0.61	-11.00	4.00	2.96	-2.54				
0.00	40.00	-2.63	-2.88	-2.39	-11.01	4.00	0.00	40.00	-7.69	-13.05	-5.37	-42.72	4.00	-1.45	-2.48	-0.62	-11.00	4.00	2.96	-2.54				
0.00	50.00	-1.95	-3.50	-1.50	-11.10	4.00	0.00	50.00	-11.12	-9.27	-7.98	-27.60	4.00	-1.45	-2.48	-0.62	-11.00	4.00	2.96	-2.54				
0.00	60.00	-1.57	-4.45	-0.94	-11.47	4.00	0.00	60.00	-17.39	-6.84	-12.16	-20.97	4.00	-1.46	-2.47	-0.62	-11.01	4.00	2.95	-2.54				
0.00	70.00	-1.46	-5.84	-0.66	-12.13	4.00	0.00	70.00	-38.42	-5.16	-21.21	-17.43	4.00	-1.46	-2.48	-0.62	-11.01	4.00	2.95	-2.55				
0.00	80.00	-1.61	-7.81	-0.65	-13.14	4.00	0.00	80.00	-15.99	-3.98	-22.47	-15.12	4.00	-1.45	-2.48	-0.62	-11.01	4.00	2.95	-2.54				
0.00	90.00	-2.04	-10.72	-0.91	-14.58	4.00	0.00	90.00	-10.44	-3.18	-12.57	-13.52	4.00	-1.45	-2.48	-0.62	-11.01	4.00	2.95	-2.54				
0.00	100.00	-2.78	-15.58	-1.45	-16.65	4.00	0.00	100.00	-7.27	-2.70	-8.22	-12.39	4.00	-1.46	-2.48	-0.62	-11.01	4.00	2.95	-2.55				
0.00	110.00	-3.87	-28.75	-2.31	-19.73	4.00	0.00	110.00	-5.15	-2.49	-5.53	-11.63	4.00	-1.45	-2.48	-0.62	-11.00	4.00	2.96	-2.54				
0.00	120.00	-5.44	-20.50	-3.57	-25.02	4.00	0.00	120.00	-3.67	-2.55	-3.68	-11.18	4.00	-1.46	-2.48	-0.61	-11.00	4.00	2.96	-2.54				
0.00	130.00	-7.69	-13.05	-5.37	-42.72	4.00	0.00	130.00	-2.63	-2.88	-2.39	-11.01	4.00	-1.45	-2.48	-0.62	-11.01	4.00	2.96	-2.54				
0.00	140.00	-11.12	-9.27	-7.98	-27.60	4.00	0.00	140.00	-1.95	-3.50	-1.50	-11.10	4.00	-1.45	-2.48	-0.62	-11.00	4.00	2.96	-2.54				
0.00	150.00	-17.39	-6.84	-12.16	-20.97	4.00	0.00	150.00	-1.57	-4.45	-0.94	-11.47	4.00	-1.46	-2.47	-0.62	-11.01	4.00	2.95	-2.54				
0.00	160.00	-38.42	-5.16	-21.21	-17.43	4.00	0.00	160.00	-1.46	-5.84	-0.66	-12.13	4.00	-1.46	-2.48	-0.62	-11.01	4.00	2.95	-2.55				
0.00	170.00	-15.99	-3.98	-22.47	-15.12	4.00	0.00	170.00	-1.61	-7.81	-0.65	-13.14	4.00	-1.45	-2.48	-0.62	-11.01	4.00	2.95	-2.54				
0.00	180.00	-10.44	-3.18	-12.57	-13.52	4.00	0.00	180.00	-2.04	-10.72	-0.91	-14.58	4.00	-1.45	-2.48	-0.62	-11.01	4.00	2.95	-2.54				
0.00	190.00	-7.27	-2.70	-8.22	-12.39	4.00	0.00	190.00	-2.78	-15.58	-1.45	-16.65	4.00	-1.46	-2.48	-0.62	-11.01	4.00	2.95	-2.55				
0.00	200.00	-5.15	-2.49	-5.53	-11.63	4.00	0.00	200.00	-3.87	-28.75	-2.31	-19.73	4.00	-1.45	-2.48	-0.62	-11.00	4.00	2.96	-2.54				
0.00	210.00	-3.67	-2.55	-3.68	-11.18	4.00	0.00	210.00	-5.44	-20.50	-3.57	-25.02	4.00	-1.46	-2.48	-0.61	-11.00	4.00	2.96	-2.54				
0.00	220.00	-2.63	-2.88	-2.39	-11.01	4.00	0.00	220.00	-7.69	-13.05	-5.37	-42.72	4.00	-1.45	-2.48	-0.62	-11.01	4.00	2.96	-2.54				
0.00	230.00	-1.95	-3.50	-1.50	-11.10	4.00	0.00	230.00	-11.12	-9.27	-7.98	-27.60	4.00	-1.45	-2.48	-0.62	-11.00	4.00	2.96	-2.54				
0.00	240.00	-1.57	-4.45	-0.94	-11.47	4.00	0.00	240.00	-17.39	-6.84	-12.16	-20.97	4.00	-1.46	-2.47	-0.62	-11.01	4.00	2.95	-2.54				
0.00	250.00	-1.46	-5.84	-0.66	-12.13	4.00	0.00	250.00	-38.42	-5.16	-21.21	-17.43	4.00	-1.46	-2.48	-0.62	-11.01	4.00	2.95	-2.55				
0.00	260.00	-1.61	-7.81	-0.65	-13.14	4.00	0.00	260.00	-15.99	-3.98	-22.47	-15.12	4.00	-1.45	-2.48	-0.62	-11.01	4.00	2.95	-2.54				
0.00	270.00	-2.04	-10.72	-0.91	-14.58	4.00	0.00	270.00	-10.44	-3.18	-12.57	-13.52	4.00	-1.45	-2.48	-0.62	-11.01	4.00	2.95	-2.54				
0.00	280.00	-2.78	-15.58	-1.45	-16.65	4.00	0.00	280.00	-7.27	-2.70	-8.22	-12.39	4.00	-1.46	-2.48	-0.62	-11.01	4.00	2.95	-2.55				
0.00	290.00	-3.87	-28.75	-2.31	-19.73	4.00	0.00	290.00	-5.15	-2.49	-5.53	-11.63	4.00	-1.45	-2.48	-0.62	-11.00	4.00	2.96	-2.54				
0.00	300.00	-5.44	-20.50	-3.57	-25.02	4.00	0.00	300.00	-3.67	-2.55	-3.68	-11.18	4.00	-1.46	-2.48	-0.61	-11.00	4.00	2.96	-2.54				
0.00	310.00	-7.69	-13.05	-5.37	-42.72	4.00	0.00	310.00	-2.63	-2.88	-2.39	-11.01	4.00	-1.45	-2.48	-0.62	-11.01	4.00	2.96	-2.54				
0.00	320.00	-11.12	-9.27	-7.98	-27.60	4.00	0.00	320.00	-1.95	-3.50	-1.50	-11.10	4.00	-1.45	-2.48	-0.62	-11.00	4.00	2.96	-2.54				
0.00	330.00	-17.39	-6.84	-12.16	-20.97	4.00	0.00	330.00	-1.57	-4.45	-0.94	-11.47	4.00	-1.46	-2.47	-0.62	-11.01	4.00	2.95	-2.54				
0.00	340.00	-38.42	-5.16	-21.21	-17.43	4.00	0.00	340.00	-1.46	-5.84	-0.66	-12.13	4.00	-1.46	-2.48	-0.62	-11.01	4.00	2.95	-2.55				
0.00	350.00	-15.99	-3.98	-22.47	-15.12	4.00	0.00	350.00	-1.61	-7.81	-0.65	-13.14	4.00	-1.45	-2.48	-0.62	-11.01	4.00	2.95	-2.54				
15.00	0.00	-12.64	-2.70	-4.28	-10.74	4.00	15.00	0.00	-1.43	-19.24	-1.90	-9.99	4.00	-1.11	-2.60	0.08	-7.34	4.00	3.69	-2.00				
15.00	10.00	-8.48	-2.34	-4.43	-10.68	4.00	15.00	10.00	-1.89	-18.49	-3.15	-12.74	4.00	-1.03	-2.24	-0.73	-8.58	4.00	3.38	-2.27				
15.00	20.00	-5.80	-0.70	-3.50	-12.62	4.00	15.00	20.00	-3.62	-12.70	-4.45	-12.11	4.00	-1.56	-0.43	-0.94	-9.35	4.00	3.59	-2.00				
15.00	30.00	-6.57	-1.24	-1.94	-13.02	4.00	15.00	30.00	-4.57	-8.69	-5.71	-17.62	4.00	-2.45	-0.52	-0.42	-11.73	4.00	3.25	-2.16				
15.00	40.00	-6.79	-3.70	-1.42	-10.56	4.00	15.00	40.00	-6.10	-7.59	-10.03	-16.82	4.00	-3.42	-2.21	-0.86	-8.81	4.00	2.66	-2.99				
15.00	50.00	-7.00	-5.28	-0.57	-9.73	4.00	15.00	50.00	-7.91	-7.18	-14.71	-27.66	4.00	-4.42	-3.12	-0.41	-9.66	4.00	2.22	-3.31				
15.00	60.00	-6.30	-6.81	-0.56	-10.96	4.00	15.00	60.00	-11.31	-4.78	-23.74	-35.02	4.00	-5.11	-6.27	-0.54	-10.94	4.00	1.99	-3.44				
15.00	70.00	-5.73	-7.06	-0.55	-11.97	4.00	15.00	70.00	-18.33	-2.49	-28.17	-15.77	4.00	-5.50	-1.19	-0.54	-10.46	4.00	2.42	-2.98				
15.00	80.00	-5.82	-10.92	-0.33	-12.98	4.00	15.00	80.00	-32.45	-1.76	-15.60	-11.85	4.00	-5.81	-1.26	-0.20	-9.37	4.00	2.59	-2.84				
15.00	90.00	-6.16	-13.55	-0.70	-14.07	4.00	15.00	90.00	-19.29	-1.73	-11.15	-10.45	4.00	-5.95	-1.45	-0.33	-8.88	4.00	2.52	-2.95				
15.00	100.00	-5.17	-20.92	-0.71	-13.82	4.00	15.00	100.00	-12.43	-2.40	-9.01	-8.82	4.00	-4.42	-2.34	-0.11	-7.63	4.00	2.82	-2.81				
15.00	110.00	-5.37	-16.23	-0.50	-12.59	4.00	15.00	110.00	-9.58	-3.38	-7.91	-9.19	4.00	-3.98	-3.16	0.30	-3.56	4.00	2.90	-2.69				
15.00	120.00	-5.83	-11.87	-0.01	-9.87	4.00	15.00	120.00	-6.48	-3.53	-7.24	-9.77	4.00	-3.13	-2.94	0.74	-6.81	4.00	3.39	-2.24				
15.00	130.00	-6.66	-11.43	0.13	-8.84	4.00	15.00	130.00	-5.54	-3.33	-5.30	-11.66	4.00	-3.05	-2.70	1.22	-7.01	4.00	3.62	-1.95				
15.00	140.00	-7.51	-10.81	0.27	-7.38	4.00	15.00	140.00	-4.09	-3.53	-3.32	-15.46	4.00	-2.46	-2.79	1.48	-6.75	4.00	3.87	-1.69				
15.00	150.00	-10.62	-8.53	-1.24	-6.35	4.00	15.00	150.00	-2.30	-3.34	-1.65	-13.34	4.00	-1.70	-2.19	1.57	-5.56	4.00	4.41	-1.26				
15.00	160.00	-15.50	-4.55	-2.76	-5.18	4.00	15.00	160.00	-0.95	-3.46	-0.48	-14.70	4.00	-0.80	-0.96	1.54	-4.72	4.00	5.06	-0.71				
15.00	170.00	-14.12	-1.77	-4.85	-5.15	4.00	15.00	170.00	-0.34	-5.41	0.28	-18.06	4.00	-0.16	-0.21	1.44	-4.93	4.00	5.36	-0.42				
15.00	180.00	-9.37	-0.99	-7.46	-6.18	4.00	15.00	180.00	0.17	-10.20	0.70	-18.22	4.00	0.63	-0.50	1.32	-5.92	4.00	5.32	-0.39				
15.00	190.00	-7.22	-1.37	-14.50	-7.10	4.00	15.00	190.00	-0.08	-15.93	1.04	-18.57	4.00	0.69	-1.22	1.16	-6.89	4.00	4.97	-0.66				
15.00	200.00	-5.60	-0.84	-26.32	-7.23	4.00	15.00	200.00	-0.93	-20.29	0.33	-17.24	4.00	0.34	-0.79	0.34	-6.82	4.00	4.73	-0.96				
15.00	210.00	-4.33	-0.49	-15.10	-8.93	4.00	15.00	210.00	-2.09	-15.24	-0.66	-15.61	4.00	-0.06	-0.3									



45.00	190.00	-11.78	-2.64	-5.44	-4.99	4.00	45.00	190.00	-0.66	-26.47	0.60	-27.10	4.00	-0.34	-2.62	1.57	-4.96	4.00	4.77	-0.94	
45.00	200.00	-7.28	-3.78	-7.17	-3.84	4.00	45.00	200.00	-1.36	-12.99	0.34	-27.66	4.00	-0.37	-3.29	1.05	-3.82	4.00	4.65	-1.14	
45.00	210.00	-4.00	-3.30	-7.86	-4.32	4.00	45.00	210.00	-0.27	-7.65	0.37	-27.10	4.00	1.26	-1.94	0.98	-4.30	4.00	5.31	-0.46	
45.00	220.00	-1.14	-2.75	-13.46	-5.71	4.00	45.00	220.00	-1.59	-8.83	-0.49	-28.23	4.00	1.65	-1.79	-0.28	-5.69	4.00	4.89	-0.79	
45.00	230.00	-1.38	-5.52	-15.40	-5.56	4.00	45.00	230.00	-2.97	-7.12	-0.94	-20.00	4.00	0.91	-3.24	-0.79	-7.51	4.00	4.21	-1.50	
45.00	240.00	-1.66	-8.49	-14.21	-5.36	4.00	45.00	240.00	-4.12	-1.66	-3.59	-17.53	4.00	0.29	-0.84	-3.23	-5.16	4.00	4.04	-1.75	
45.00	250.00	-2.67	-7.93	-13.36	-5.44	4.00	45.00	250.00	-7.64	0.40	-6.37	-18.68	4.00	-1.47	1.00	-5.58	-0.40	3.64	-1.96		
45.00	260.00	-3.99	-5.33	-15.50	-5.86	4.00	45.00	260.00	-13.35	1.87	-15.77	-21.38	4.00	-3.51	2.63	-12.62	-5.74	4.00	2.83	-1.87	
45.00	270.00	-4.46	-3.87	-18.02	-5.36	4.00	45.00	270.00	-20.69	2.21	-16.45	-30.61	4.00	-4.36	3.17	-14.15	-5.75	4.00	2.87	-1.59	
45.00	280.00	-4.24	-3.95	-20.65	-6.03	4.00	45.00	280.00	-24.52	2.13	-9.54	-27.11	4.00	-4.20	3.09	-9.22	-6.00	4.00	3.20	-1.57	
45.00	290.00	-3.27	-6.57	-24.94	-4.24	4.00	45.00	290.00	-15.25	2.26	-3.21	-23.64	4.00	-3.00	2.79	-3.15	-1.18	4.00	4.51	-0.88	
45.00	300.00	-2.01	-11.50	-14.29	-3.86	4.00	45.00	300.00	-6.54	-0.40	-4.42	-16.09	4.00	-1.37	-0.78	-2.10	-3.61	4.00	3.50	-1.39	
45.00	310.00	-2.01	-9.39	-9.88	-2.41	4.00	45.00	310.00	-2.54	-1.12	-1.78	-12.50	4.00	0.74	-0.52	-1.15	-2.91	4.00	5.16	-0.77	
45.00	320.00	-3.58	-6.18	-8.27	-2.84	4.00	45.00	320.00	-1.04	-0.80	-0.84	-20.10	4.00	0.88	0.31	-0.12	-2.76	4.00	5.70	-0.22	
45.00	330.00	-5.42	-3.98	-6.16	-2.65	4.00	45.00	330.00	-0.64	-3.86	-1.23	-23.95	4.00	0.61	-0.91	-0.02	-2.62	4.00	5.37	-0.58	
45.00	340.00	-9.02	-4.67	-2.51	-0.42	4.00	45.00	340.00	-0.31	-6.94	-0.46	-15.04	4.00	0.24	-2.65	1.65	-0.27	4.00	5.90	0.00	
45.00	350.00	-16.41	-3.71	-2.91	-1.61	4.00	45.00	350.00	0.85	-14.73	-1.43	-11.02	4.00	0.93	-3.38	0.90	-1.14	4.00	5.52	-0.34	
60.00	0.00	-9.26	-1.26	-2.78	-0.42	4.00	60.00	0.00	-1.22	-10.69	-0.59	-12.57	4.00	-0.59	-0.79	1.46	-0.16	4.00	6.05	0.08	
60.00	10.00	-11.62	-0.34	-2.09	-3.22	4.00	60.00	10.00	-1.25	-3.09	-3.15	-16.46	4.00	-0.87	1.51	0.42	-3.02	4.00	5.69	-0.18	
60.00	20.00	-24.88	-0.02	-1.31	-5.13	4.00	60.00	20.00	-0.97	-5.40	-2.43	-18.59	4.00	-0.95	1.09	1.18	-4.94	4.00	5.44	-0.32	
60.00	30.00	-12.52	-1.40	-6.19	-8.59	4.00	60.00	30.00	-2.61	-4.89	-4.33	-26.77	4.00	-2.19	0.21	-2.15	-8.52	4.00	3.40	-2.21	
60.00	40.00	-21.45	-5.08	-6.89	-13.69	4.00	60.00	40.00	-3.20	-0.36	-8.41	-12.22	4.00	-3.14	1.45	-4.57	-9.88	4.00	2.89	-2.34	
60.00	50.00	-24.30	-5.18	-8.18	-13.91	4.00	60.00	50.00	-8.34	-3.24	-6.14	-10.45	4.00	-8.23	-1.09	-4.03	-8.83	4.00	1.06	-4.40	
60.00	60.00	-14.56	-6.01	-10.07	-19.09	4.00	60.00	60.00	-9.95	-3.63	-10.08	-15.40	4.00	-8.66	-1.65	-7.06	-13.85	4.00	-0.71	-5.78	
60.00	70.00	-11.73	-11.08	-8.01	-21.32	4.00	60.00	70.00	-14.89	-5.11	-28.12	-21.25	4.00	-10.02	-3.20	-5.20	3.20	4.00	3.53	-1.29	
60.00	80.00	-11.97	-18.28	-10.24	-18.82	4.00	60.00	80.00	-18.59	-5.31	-8.90	-13.89	4.00	-11.11	-5.10	-18.59	-6.31	-12.68	4.00	-2.15	-7.68
60.00	90.00	-19.47	-16.95	-9.41	-16.87	4.00	60.00	90.00	-20.24	-4.95	-10.29	-19.04	4.00	-16.83	-4.68	-6.20	-14.81	4.00	-3.11	-8.00	
60.00	100.00	-13.56	-11.05	-9.71	-13.69	4.00	60.00	100.00	-12.94	-8.92	-13.92	-22.93	4.00	-10.23	-6.78	-8.31	-13.92	4.00	-3.29	-9.03	
60.00	110.00	-9.69	-11.48	-8.71	-14.71	4.00	60.00	110.00	-8.63	-5.62	-13.00	-26.65	4.00	-6.12	-4.62	-7.34	-14.44	4.00	-1.40	-6.93	
60.00	120.00	-10.82	-11.34	-6.73	-12.00	4.00	60.00	120.00	-6.17	-1.60	-10.07	-23.24	4.00	-4.89	-1.16	-5.08	-11.69	4.00	1.07	-4.35	
60.00	130.00	-16.06	-7.10	-4.58	-7.68	4.00	60.00	130.00	-5.53	-2.57	-5.75	-18.00	4.00	-5.16	-1.26	-2.12	-7.29	4.00	2.39	-3.34	
60.00	140.00	-16.35	-6.33	-4.74	-7.05	4.00	60.00	140.00	-3.37	-4.58	-4.11	-13.80	4.00	-3.16	-2.36	-1.40	-6.22	4.00	2.91	-2.95	
60.00	150.00	-21.00	-7.21	-5.42	-4.93	4.00	60.00	150.00	-3.08	-6.94	-3.17	-19.63	4.00	-3.01	-4.06	-1.14	-4.79	4.00	2.88	-3.02	
60.00	160.00	-19.31	-10.62	-6.46	-6.34	4.00	60.00	160.00	-2.70	-11.02	-2.89	-17.60	4.00	-2.61	-7.81	-0.68	-6.03	4.00	2.19	-3.42	
60.00	170.00	-12.78	-5.69	-6.28	-11.88	4.00	60.00	170.00	-1.88	-11.49	-3.65	-17.50	4.00	-1.54	-6.58	-1.46	-4.42	4.00	2.77	-3.02	
60.00	180.00	-11.38	-9.10	-5.41	-4.34	4.00	60.00	180.00	-1.38	-11.59	-1.99	-25.38	4.00	-0.97	-7.16	-0.36	-4.31	4.00	3.23	-2.43	
60.00	190.00	-12.47	-4.33	-4.69	-3.92	4.00	60.00	190.00	-1.69	-15.17	-1.77	-32.33	4.00	-1.34	-3.99	0.02	-3.91	4.00	3.89	-1.96	
60.00	200.00	-7.52	-5.57	-5.92	-4.36	4.00	60.00	200.00	-1.04	-21.84	-1.82	-24.87	4.00	-0.16	-5.47	-0.39	-4.32	4.00	3.75	-1.99	
60.00	210.00	-5.84	-5.62	-6.58	-5.05	4.00	60.00	210.00	-0.85	-12.67	-1.38	-24.50	4.00	0.39	-4.84	-0.23	-5.00	4.00	3.96	-1.73	
60.00	220.00	-6.09	-5.23	-7.68	-4.84	4.00	60.00	220.00	-1.68	-9.41	-1.61	-29.01	4.00	-0.34	-3.83	-0.65	-4.82	4.00	3.83	-1.99	
60.00	230.00	-7.06	-7.58	-8.41	-5.26	4.00	60.00	230.00	-3.61	-8.21	-1.22	-39.32	4.00	-1.99	-4.87	-0.46	-5.26	4.00	3.11	-2.69	
60.00	240.00	-9.31	-7.87	-9.43	-4.67	4.00	60.00	240.00	-8.01	-2.25	-3.53	-22.03	4.00	-5.60	-1.20	-2.54	-4.59	4.00	2.71	-3.14	
60.00	250.00	-7.40	-10.91	-11.31	-3.08	4.00	60.00	250.00	-14.95	-1.48	-6.67	-19.26	4.00	-6.70	-1.01	-5.39	-1.48	4.00	2.28	-3.47	
60.00	260.00	-4.08	-10.05	-14.07	-2.73	4.00	60.00	260.00	-26.06	-1.08	-14.96	-18.09	4.00	-4.05	-0.56	-11.48	-2.61	4.00	2.18	-3.25	
60.00	270.00	-3.96	-12.51	-12.14	-3.77	4.00	60.00	270.00	-12.79	-0.44	-13.56	-23.06	4.00	-3.43	-0.18	-9.78	-3.72	4.00	2.38	-3.13	
60.00	280.00	-5.02	-19.14	-12.11	-1.64	4.00	60.00	280.00	-8.96	-1.64	-6.35	-29.11	4.00	-3.55	-1.56	-5.33	-1.63	4.00	3.14	-2.76	
60.00	290.00	-7.12	-10.37	-11.03	-1.30	4.00	60.00	290.00	-7.15	-2.80	-5.06	-18.59	4.00	-4.12	-2.10	-4.08	-1.22	4.00	3.23	-2.70	
60.00	300.00	-10.09	-7.09	-7.82	-1.93	4.00	60.00	300.00	-5.93	-1.65	-3.60	-18.92	4.00	-4.52	-0.56	-2.21	-1.84	4.00	3.85	-2.06	
60.00	310.00	-8.31	-9.91	-7.74	-3.76	4.00	60.00	310.00	-5.40	-0.98	-1.49	-14.89	4.00	-3.61	0.35	-0.56	-3.44	4.00	4.38	-1.47	
60.00	320.00	-7.52	-16.98	-6.89	-2.78	4.00	60.00	320.00	-1.87	-2.69	-1.71	-16.96	4.00	-0.82	-2.53	-0.56	-2.62	4.00	4.44	-1.53	
60.00	330.00	-9.03	-6.37	-2.39	-0.48	4.00	60.00	330.00	-0.94	-2.88	-0.01	-11.67	4.00	-0.31	-3.30	-1.27	1.97	-0.16	4.00	6.16	0.23
60.00	340.00	-8.71	-5.27	-4.61	-0.04	4.00	60.00	340.00	0.61	-9.41	-1.18	-16.25	4.00	1.09	-3.85	0.45	0.06	4.00	5.66	-0.20	
60.00	350.00	-11.76	-2.50	-1.27	0.00	4.00	60.00	350.00	0.98	-13.05	-4.16	-15.36	4.00	1.21	-2.12	0.53	0.12	4.00	6.04	0.10	
75.00	0.00	-7.11	-3.98	-5.68	1.31	4.00	75.00	0.00	-0.87	-25.89	-2.53	-17.75	4.00	0.06	-3.95	-0.82	1.36	4.00	5.39	-0.44	
75.00	10.00	-13.14	-0.47	-6.13	-0.22	4.00	75.00	10.00	0.53	-11.46	-2.69	-21.48	4.00	0.71	-0.14	-1.07	-1.19	4.00	5.87	-0.12	
75.00	20.00	-18.19	0.13	-7.01	-4.85	4.00	75.00	20.00	0.83	-3.74	-4.03	-28.48	4.00	0.88	1.62	-2.26	-3.74	4.00	5.24	-0.46	
75.00	30.00	-13.76	-5.01	-6.45	-12.00	4.00	75.00	30.00	0.56	-7.36	-5.56	-17.10	4.00	0.72	-3.02	-2.97	-10.83	4.00	2.89	-2.47	
75.00	40.00	-10.41	-19.75	-10.13	-12.41	4.00	75.00	40.00	-4.61	-3.55	-9.11	-21.40	4.00	-4.34	-2.74	-3.99	-11.99	4.00	3.74	-5.17	
75.00	50.00	-12.70	-19.93	-9.33	-11.67	4.00	75.00	50.00	-4.03	-0.05	-8.88	-15.60	4.00	-3.48	-0.01	-6.09	-10.88	4.00	1.85	-2.89	
75.00	60.00	-9.01	-25.68	-6.66	-2.92	4.00	75.00	60.00	-5.42	-2.08	-11.14	-19.56	4.00	-3.84	-2.06	-5.34	-17.52	4.00	0.45	-4.73	
75.00	70.00	-16.19	-15.30	-8.64	-13.81	4.00	75.00	70.00	-6.3	-12.39	-9.32	-20.81	4.00	-5.88	-10.60</						



105.00	100.00	-6.77	-14.60	-14.90	-20.15	4.00	105.00	100.00	-15.22	-17.28	-13.53	-13.91	4.00	-6.19	-12.73	-11.15	-12.98	4.00	-4.27	-9.78
105.00	110.00	-18.05	-10.10	-26.76	-14.23	4.00	105.00	110.00	-9.72	-7.06	-9.13	-11.37	4.00	-9.12	-5.31	-9.06	-9.56	4.00	-2.06	-7.88
105.00	120.00	-15.40	-11.04	-13.55	-12.17	4.00	105.00	120.00	-16.18	-8.31	-14.37	-16.80	4.00	-12.76	-6.45	-16.93	-7.02	4.00	-2.88	-8.55
105.00	130.00	-10.72	-17.66	-14.32	-4.82	4.00	105.00	130.00	-7.22	-17.42	-17.10	-14.73	4.00	-5.62	-14.53	-12.48	-4.40	4.00	-2.20	-7.39
105.00	140.00	-19.21	-18.18	-14.54	-1.63	4.00	105.00	140.00	-6.66	-14.24	-14.88	-16.75	4.00	-6.43	-12.77	-11.70	-1.49	4.00	-0.87	-5.78
105.00	150.00	-20.68	-3.70	-15.75	-1.17	4.00	105.00	150.00	-8.59	-8.43	-24.46	-16.12	4.00	-8.33	-2.44	-15.20	-1.03	4.00	0.83	-4.16
105.00	160.00	-26.00	-3.53	-8.45	-0.27	4.00	105.00	160.00	-8.64	-14.24	-12.81	-18.63	4.00	-8.56	-3.18	-7.09	-0.21	4.00	1.89	-3.54
105.00	170.00	-18.85	-9.90	-7.29	0.93	4.00	105.00	170.00	-8.50	-10.48	-10.44	-23.65	4.00	-8.12	-7.17	-5.58	0.94	4.00	1.84	-3.31
105.00	180.00	-15.96	-9.64	-6.93	1.72	4.00	105.00	180.00	-6.76	-30.56	-10.40	-14.21	4.00	-6.27	-9.61	-5.32	1.86	4.00	2.27	-2.85
105.00	190.00	-21.11	-8.84	-5.24	3.16	4.00	105.00	190.00	-3.54	-16.40	-15.02	-17.19	4.00	-3.46	-8.14	-4.81	3.20	4.00	3.76	-1.22
105.00	200.00	-9.61	-12.63	-4.38	2.75	4.00	105.00	200.00	-9.63	-21.34	-11.35	-19.79	4.00	-4.06	-12.08	-3.58	2.79	4.00	2.71	-1.66
105.00	210.00	-15.08	-13.98	-3.90	1.41	4.00	105.00	210.00	-9.45	-13.34	-9.88	-19.31	4.00	-8.40	-10.23	-7.06	2.94	4.00	2.75	-1.82
105.00	220.00	-23.14	-10.32	-3.90	1.47	4.00	105.00	220.00	-10.40	-15.53	-7.62	-15.00	4.00	-10.17	-9.18	-2.36	1.57	4.00	2.34	-2.53
105.00	230.00	-24.08	-12.42	-4.37	-1.06	4.00	105.00	230.00	-13.66	-11.18	-6.37	-14.49	4.00	-13.28	-8.75	-2.25	-0.87	4.00	1.06	-3.99
105.00	240.00	-16.01	-19.58	-3.79	-2.01	4.00	105.00	240.00	-11.52	-5.23	-8.34	-20.41	4.00	-10.20	-5.07	-2.48	-1.95	4.00	1.65	-3.95
105.00	250.00	-13.28	-15.96	-3.33	-1.87	4.00	105.00	250.00	-13.96	-6.09	-9.07	-18.78	4.00	-10.60	-5.66	-2.30	-1.78	4.00	1.58	-3.95
105.00	260.00	-9.65	-16.56	-2.31	0.03	4.00	105.00	260.00	-22.35	-7.86	-17.53	-26.22	4.00	-9.42	-7.31	-2.38	1.04	4.00	2.12	-3.20
105.00	270.00	-8.92	-16.14	-1.40	1.86	4.00	105.00	270.00	-18.63	-8.67	-17.95	-28.26	4.00	-8.48	-7.95	-1.30	0.86	4.00	3.16	-1.91
105.00	280.00	-8.32	-12.39	-1.93	2.68	4.00	105.00	280.00	-11.56	-7.94	-8.83	-18.50	4.00	-6.63	-6.61	-1.12	2.71	4.00	4.02	-1.14
105.00	290.00	-9.98	-12.41	-2.62	2.90	4.00	105.00	290.00	-7.62	-7.85	-4.85	-15.11	4.00	-5.63	-6.55	-0.58	2.97	4.00	4.44	-0.77
105.00	300.00	-17.16	-11.97	-3.45	3.20	4.00	105.00	300.00	-5.45	-11.96	-3.79	-20.02	4.00	-5.17	-8.95	-0.61	3.22	4.00	4.32	-0.71
105.00	310.00	-15.34	-7.97	-4.18	1.47	4.00	105.00	310.00	-3.67	-10.21	-1.86	-17.36	4.00	-3.98	-5.94	0.14	1.53	4.00	4.59	-1.01
105.00	320.00	-15.24	-9.78	-4.82	-1.34	4.00	105.00	320.00	-5.48	-10.75	-1.91	-13.58	4.00	-5.04	-7.23	-0.12	-1.09	4.00	3.12	-2.49
105.00	330.00	-14.46	-6.55	-8.40	-3.15	4.00	105.00	330.00	-6.57	-6.97	-1.84	-13.59	4.00	-5.92	-3.74	-0.97	-2.77	4.00	2.85	-3.00
105.00	340.00	-28.04	-5.97	-7.81	-2.66	4.00	105.00	340.00	-5.38	-6.92	-1.19	-19.96	4.00	-5.36	-3.41	-0.33	-2.58	4.00	3.29	-2.55
105.00	350.00	-15.85	-4.96	-9.74	0.53	4.00	105.00	350.00	-8.19	-6.62	-1.76	-13.68	4.00	-7.50	-2.70	-1.12	0.69	4.00	3.85	-1.77
120.00	0.00	-13.69	-3.72	-19.43	-1.83	4.00	120.00	0.00	-5.24	-14.87	-2.25	-13.60	4.00	-4.66	-3.40	-2.17	-1.55	4.00	3.16	-2.79
120.00	10.00	-10.83	-3.84	-20.46	-1.61	4.00	120.00	10.00	-6.01	-6.79	-4.91	-21.46	4.00	-4.77	-2.10	-4.79	-1.57	4.00	2.84	-3.05
120.00	20.00	-7.53	-5.72	-12.11	-1.95	4.00	120.00	20.00	-7.30	-3.13	-5.50	-22.15	4.00	-4.40	-1.22	-4.64	-1.91	4.00	3.11	-2.79
120.00	30.00	-12.19	-3.91	-12.66	-5.72	4.00	120.00	30.00	-7.78	-6.89	-9.22	-10.05	4.00	-6.44	-2.14	-7.80	-4.35	4.00	1.14	-4.62
120.00	40.00	-10.49	-8.54	-10.99	-10.07	4.00	120.00	40.00	-17.05	-5.69	-11.36	-6.85	4.00	-9.62	-3.87	-8.16	-5.16	4.00	-0.38	-6.12
120.00	50.00	-6.09	-4.05	-10.00	-6.94	4.00	120.00	50.00	-17.16	0.64	-10.04	-7.98	4.00	-5.76	1.91	-7.01	-5.72	4.00	2.69	-2.43
120.00	60.00	-5.59	-11.28	-13.93	-14.79	4.00	120.00	60.00	-13.10	-1.11	-5.47	-15.37	4.00	-4.88	-5.70	-4.89	-12.06	4.00	-0.41	-6.11
120.00	70.00	-7.15	-6.49	-13.89	-28.10	4.00	120.00	70.00	-18.44	-7.29	-7.03	-14.78	4.00	-6.84	-0.89	-6.22	-14.58	4.00	1.14	-4.90
120.00	80.00	-20.45	-11.23	-22.11	-2.81	4.00	120.00	80.00	-10.34	-1.68	-13.62	-16.36	4.00	-9.04	-1.22	-3.15	-13.15	4.00	-2.01	-3.90
120.00	90.00	-11.05	-14.49	-27.41	-18.44	4.00	120.00	90.00	-5.94	-14.37	-8.55	-17.08	4.00	-5.77	-11.42	-8.49	-14.70	4.00	-3.06	-8.38
120.00	100.00	-8.38	-17.60	-29.68	-36.18	4.00	120.00	100.00	-8.91	-10.97	-9.34	-13.33	4.00	-4.63	-10.09	-9.30	-13.31	4.00	-3.13	-8.73
120.00	110.00	-15.54	-11.82	-16.27	-15.93	4.00	120.00	110.00	-20.95	-26.76	-7.12	-11.29	4.00	-14.44	-11.68	-6.62	-10.01	4.00	-4.20	-9.77
120.00	120.00	-11.03	-9.59	-13.24	-12.29	4.00	120.00	120.00	-9.84	-6.68	-7.71	-16.26	4.00	-7.38	-4.89	-6.64	-10.83	4.00	-1.16	-6.95
120.00	130.00	-7.49	-22.50	-11.49	-6.90	4.00	120.00	130.00	-9.90	-26.75	-20.37	-17.65	4.00	-5.52	-2.11	-10.96	-6.55	4.00	-3.28	-8.31
120.00	140.00	-11.94	-5.07	-15.53	-5.21	4.00	120.00	140.00	-13.17	-3.85	-20.30	-29.49	4.00	-9.50	-1.11	-14.28	-5.19	4.00	-0.32	-5.32
120.00	150.00	-22.75	-3.41	-13.57	-3.65	4.00	120.00	150.00	-11.24	-9.33	-13.71	-19.34	4.00	-10.94	-2.42	-10.63	-3.53	4.00	0.00	-5.29
120.00	160.00	-15.36	-3.59	-8.36	-0.51	4.00	120.00	160.00	-6.64	-29.72	-24.34	-14.69	4.00	-6.09	-3.58	-8.25	-0.34	4.00	1.96	-3.57
120.00	170.00	-20.18	-4.01	-9.61	0.48	4.00	120.00	170.00	-9.81	-18.20	-15.56	-15.82	4.00	-9.43	-3.85	-8.63	0.58	4.00	1.65	-3.45
120.00	180.00	-12.54	-4.17	-10.20	1.28	4.00	120.00	180.00	-6.98	-14.95	-15.83	-11.72	4.00	-5.91	-3.82	-9.15	1.49	4.00	2.56	-2.59
120.00	190.00	-26.33	-14.95	-5.88	1.99	4.00	120.00	190.00	-10.97	-20.44	-14.97	-14.92	4.00	-10.85	-13.87	-5.38	2.08	4.00	1.21	-2.95
120.00	200.00	-7.24	-8.94	-5.83	2.63	4.00	120.00	200.00	-20.02	-7.63	-9.02	-20.18	4.00	-7.02	-5.23	-4.13	2.65	4.00	3.44	-1.66
120.00	210.00	-12.45	-19.68	-5.89	1.51	4.00	120.00	210.00	-17.20	-15.95	-8.00	-14.83	4.00	-11.20	-14.42	-3.81	1.61	4.00	1.27	-3.06
120.00	220.00	-17.81	-37.06	-4.99	-0.35	4.00	120.00	220.00	-13.53	-37.20	-8.40	-15.70	4.00	-12.15	-18.14	-3.36	-0.23	4.00	0.11	-4.30
120.00	230.00	-13.74	-17.03	-3.57	-2.03	4.00	120.00	230.00	-11.06	-8.25	-6.07	-21.15	4.00	-9.19	-7.71	-1.63	-1.98	4.00	1.53	-3.95
120.00	240.00	-13.56	-16.61	-4.07	-6.13	4.00	120.00	240.00	-12.87	-22.29	-6.16	-12.84	4.00	-10.19	-15.57	-1.98	-5.29	4.00	-0.84	-5.80
120.00	250.00	-13.12	-15.77	-5.32	-4.86	4.00	120.00	250.00	-11.50	-14.61	-6.63	-11.45	4.00	-9.22	-12.14	-2.92	-4.00	4.00	-0.27	-5.65
120.00	260.00	-12.47	-18.79	-3.76	-1.71	4.00	120.00	260.00	-9.69	-12.22	-10.43	-17.24	4.00	-7.85	-7.85	-2.91	-1.59	4.00	1.43	-4.17
120.00	270.00	-10.59	-19.00	-2.69	1.34	4.00	120.00	270.00	-7.95	-7.26	-19.59	-24.17	4.00	-6.06	-6.98	-2.60	1.35	4.00	3.09	-2.29
120.00	280.00	-8.76	-14.59	-1.87	3.25	4.00	120.00	280.00	-7.38	-4.97	-10.62	-15.34	4.00	-5.01	-4.52	-1.33	3.31	4.00	4.81	-0.52
120.00	290.00	-9.28	-12.84	-1.88	3.31	4.00	120.00	290.00	-6.38	-4.39	-6.12	-11.19	4.00	-4.58	-3.81	-0.49	3.46	4.00	5.27	-0.14
120.00	300.00	-8.74	-7.87	-1.85	3.10	4.00	120.00	300.00	-4.98	-6.20	-5.45	-10.91	4.00	-3.45	-4.28	-0.28	3.27	4.00	5.36	-0.33
120.00	310.00	-9.12	-7.60	-3.66	-0.48	4.00	120.00	310.00	-4.18	-5.37	-2.66	-30.56	4.00	-2.97	-3.33	-0.12	-0.48	4.00	4.41	-1.89
120.00	320.00	-12.17	-8.87	-6.00	-3.02	4.00	120.00	320.00	-5.64	-3.56	-6.63	-11.64	4.00	-4.77	-1.85	-5.64	-2.60	4.00	3.83	-2.07
120.00	330.00	-11.29	-2.40	-7.92	-5.71	4.00	120.00	330.00	-7.31	-4.65	-2.98	-20.16	4.0							



165.00	10.00	-13.14	-16.13	-20.60	-12.77	4.00		165.00	10.00	-8.04	-6.66	-9.08	-9.85	4.00
165.00	20.00	-18.72	-4.98	-30.17	-22.24	4.00		165.00	20.00	-10.85	-10.30	-10.31	-12.42	4.00
165.00	30.00	-19.20	-3.19	-16.82	-19.39	4.00		165.00	30.00	-14.07	-11.26	-8.57	-10.73	4.00
165.00	40.00	-20.91	-6.67	-11.95	-21.16	4.00		165.00	40.00	-18.96	-7.59	-7.33	-9.42	4.00
165.00	50.00	-16.46	-19.16	-8.18	-20.88	4.00		165.00	50.00	-20.77	-8.37	-8.99	-9.20	4.00
165.00	60.00	-17.03	-15.87	-8.08	-25.91	4.00		165.00	60.00	-19.98	-8.70	-13.35	-12.70	4.00
165.00	70.00	-17.66	-14.76	-12.27	-24.53	4.00		165.00	70.00	-19.12	-6.12	-21.50	-15.29	4.00
165.00	80.00	-18.76	-15.59	-15.61	-27.45	4.00		165.00	80.00	-20.61	-4.62	-25.69	-15.85	4.00
165.00	90.00	-16.86	-9.90	-21.91	-23.41	4.00		165.00	90.00	-26.59	-4.17	-33.77	-18.48	4.00
165.00	100.00	-18.06	-6.53	-20.83	-17.25	4.00		165.00	100.00	-27.25	-6.08	-31.90	-17.26	4.00
165.00	110.00	-17.88	-6.76	-18.27	-14.24	4.00		165.00	110.00	-32.53	-7.44	-17.46	-19.94	4.00
165.00	120.00	-13.41	-7.70	-15.10	-13.61	4.00		165.00	120.00	-29.78	-7.30	-13.65	-31.17	4.00
165.00	130.00	-12.12	-8.28	-16.64	-15.16	4.00		165.00	130.00	-23.83	-8.24	-9.97	-26.45	4.00
165.00	140.00	-11.42	-8.10	-14.48	-19.77	4.00		165.00	140.00	-18.52	-8.90	-8.65	-23.08	4.00
165.00	150.00	-15.39	-6.57	-12.36	-20.05	4.00		165.00	150.00	-16.17	-7.92	-8.99	-16.32	4.00
165.00	160.00	-19.91	-6.33	-10.87	-22.48	4.00		165.00	160.00	-13.63	-7.46	-9.65	-14.16	4.00
165.00	170.00	-19.99	-6.13	-10.15	-20.79	4.00		165.00	170.00	-14.48	-9.66	-10.44	-14.11	4.00
165.00	180.00	-11.60	-7.49	-10.41	-21.39	4.00		165.00	180.00	-13.09	-14.12	-12.50	-12.98	4.00
165.00	190.00	-8.37	-8.57	-12.30	-21.48	4.00		165.00	190.00	-17.62	-20.68	-14.94	-11.86	4.00
165.00	200.00	-10.11	-9.15	-11.49	-37.49	4.00		165.00	200.00	-23.15	-10.58	-14.42	-12.45	4.00
165.00	210.00	-11.75	-10.31	-12.18	-24.85	4.00		165.00	210.00	-17.02	-5.92	-18.85	-13.66	4.00
165.00	220.00	-8.57	-13.80	-15.94	-17.22	4.00		165.00	220.00	-16.77	-3.00	-16.27	-17.30	4.00
165.00	230.00	-6.97	-19.07	-18.30	-16.93	4.00		165.00	230.00	-15.80	-1.82	-12.40	-17.76	4.00
165.00	240.00	-8.41	-27.14	-23.97	-16.86	4.00		165.00	240.00	-14.87	-1.51	-11.33	-15.02	4.00
165.00	250.00	-14.77	-16.80	-25.22	-15.75	4.00		165.00	250.00	-12.62	-1.39	-10.19	-14.34	4.00
165.00	260.00	-23.43	-15.88	-24.31	-15.43	4.00		165.00	260.00	-8.53	-2.99	-7.90	-11.27	4.00
165.00	270.00	-17.29	-10.75	-23.50	-16.03	4.00		165.00	270.00	-7.80	-5.20	-8.23	-8.70	4.00
165.00	280.00	-11.08	-10.73	-46.89	-12.71	4.00		165.00	280.00	-6.80	-10.56	-6.74	-8.31	4.00
165.00	290.00	-8.80	-13.13	-30.78	-10.06	4.00		165.00	290.00	-6.07	-19.17	-6.75	-6.31	4.00
165.00	300.00	-8.83	-10.53	-25.64	-10.46	4.00		165.00	300.00	-5.56	-17.15	-5.37	-6.08	4.00
165.00	310.00	-8.37	-6.88	-20.73	-8.59	4.00		165.00	310.00	-6.26	-21.89	-5.62	-7.10	4.00
165.00	320.00	-9.96	-3.45	-13.59	-7.01	4.00		165.00	320.00	-7.86	-15.16	-8.66	-8.46	4.00
165.00	330.00	-12.37	-1.96	-12.89	-5.82	4.00		165.00	330.00	-8.21	-15.22	-7.97	-10.40	4.00
165.00	340.00	-16.36	0.34	-13.21	-6.53	4.00		165.00	340.00	-7.69	-16.78	-7.15	-10.62	4.00
165.00	350.00	-20.82	-0.47	-13.86	-8.30	4.00		165.00	350.00	-7.76	-13.29	-6.42	-9.83	4.00
180.00	0.00	-14.87	-5.96	-11.84	-7.14	4.00		180.00	0.00	-17.63	-15.36	-15.85	-14.30	4.00
180.00	10.00	-13.95	-5.59	-11.06	-6.63	4.00		180.00	10.00	-20.17	-21.87	-18.84	-18.90	4.00
180.00	20.00	-13.37	-5.49	-10.59	-6.40	4.00		180.00	20.00	-24.19	-38.53	-23.88	-30.20	4.00
180.00	30.00	-13.07	-5.66	-10.40	-6.43	4.00		180.00	30.00	-32.55	-19.66	-38.65	-25.56	4.00
180.00	40.00	-13.04	-6.10	-10.47	-6.74	4.00		180.00	40.00	-36.28	-14.29	-27.75	-17.41	4.00
180.00	50.00	-13.28	-6.85	-10.81	-7.33	4.00		180.00	50.00	-25.39	-11.18	-20.69	-13.45	4.00
180.00	60.00	-13.80	-7.97	-11.45	-8.25	4.00		180.00	60.00	-20.86	-9.10	-17.02	-10.93	4.00
180.00	70.00	-14.65	-9.56	-12.43	-9.59	4.00		180.00	70.00	-18.09	-7.64	-14.64	-9.20	4.00
180.00	80.00	-15.88	-11.85	-13.84	-11.50	4.00		180.00	80.00	-16.20	-6.63	-13.00	-7.98	4.00
180.00	90.00	-17.63	-15.36	-15.85	-14.30	4.00		180.00	90.00	-14.87	-5.96	-11.84	-7.14	4.00
180.00	100.00	-20.17	-21.87	-18.84	-18.90	4.00		180.00	100.00	-13.95	-5.59	-11.06	-6.63	4.00
180.00	110.00	-24.19	-38.53	-23.88	-30.20	4.00		180.00	110.00	-13.37	-5.49	-10.59	-6.40	4.00
180.00	120.00	-32.55	-19.66	-38.65	-25.56	4.00		180.00	120.00	-13.07	-5.66	-10.40	-6.43	4.00
180.00	130.00	-36.28	-14.29	-27.75	-17.41	4.00		180.00	130.00	-13.04	-6.10	-10.47	-6.74	4.00
180.00	140.00	-25.39	-11.18	-20.69	-13.45	4.00		180.00	140.00	-13.28	-6.85	-10.81	-7.33	4.00
180.00	150.00	-20.86	-9.10	-17.02	-10.93	4.00		180.00	150.00	-13.80	-7.97	-11.45	-8.25	4.00
180.00	160.00	-18.09	-7.64	-14.64	-9.20	4.00		180.00	160.00	-14.65	-9.56	-12.43	-9.59	4.00
180.00	170.00	-16.20	-6.63	-13.00	-7.98	4.00		180.00	170.00	-15.88	-11.85	-13.84	-11.50	4.00
180.00	180.00	-14.87	-5.96	-11.84	-7.14	4.00		180.00	180.00	-17.63	-15.36	-15.85	-14.30	4.00
180.00	190.00	-13.95	-5.59	-11.06	-6.63	4.00		180.00	190.00	-20.17	-21.87	-18.84	-18.90	4.00
180.00	200.00	-13.37	-5.49	-10.59	-6.40	4.00		180.00	200.00	-24.19	-38.53	-23.88	-30.20	4.00
180.00	210.00	-13.07	-5.66	-10.40	-6.43	4.00		180.00	210.00	-32.55	-19.66	-38.65	-25.56	4.00
180.00	220.00	-13.04	-6.10	-10.47	-6.74	4.00		180.00	220.00	-25.39	-11.18	-20.69	-13.45	4.00
180.00	230.00	-13.28	-6.85	-10.81	-7.33	4.00		180.00	230.00	-20.86	-9.10	-17.02	-10.93	4.00
180.00	240.00	-13.80	-7.97	-11.45	-8.25	4.00		180.00	240.00	-18.09	-7.64	-14.64	-9.20	4.00
180.00	250.00	-14.65	-9.56	-12.43	-9.59	4.00		180.00	250.00	-16.20	-6.63	-13.00	-7.98	4.00
180.00	260.00	-15.88	-11.85	-13.84	-11.50	4.00		180.00	260.00	-14.87	-5.96	-11.84	-7.14	4.00
180.00	270.00	-17.63	-15.36	-15.85	-14.30	4.00		180.00	270.00	-14.87	-5.96	-11.84	-7.14	4.00
180.00	280.00	-20.17	-21.87	-18.84	-18.90	4.00		180.00	280.00	-13.95	-5.59	-11.06	-6.63	4.00
180.00	290.00	-24.19	-38.53	-23.88	-30.20	4.00		180.00	290.00	-13.37	-5.49	-10.59	-6.40	4.00
180.00	300.00	-32.55	-19.66	-38.65	-25.56	4.00		180.00	300.00	-13.07	-5.66	-10.40	-6.43	4.00
180.00	310.00	-36.28	-14.29	-27.75	-17.41	4.00		180.00	310.00	-13.04	-6.10	-10.47	-6.74	4.00
180.00	320.00	-25.39	-11.18	-20.69	-13.45	4.00		180.00	320.00	-13.28	-6.85	-10.81	-7.33	4.00
180.00	330.00	-20.86	-9.10	-17.02	-10.93	4.00		180.00	330.00	-13.80	-7.97	-11.45	-8.25	4.00
180.00	340.00	-18.09	-7.64	-14.64	-9.20	4.00		180.00	340.00	-14.65	-9.56	-12.43	-9.59	4.00
180.00	350.00	-16.20	-6.63	-13.00	-7.98	4.00		180.00	350.00	-15.88	-11.85	-13.84	-11.50	4.00

-6.87	-6.20	-8.78	-8.06	4.00	-1.40	-7.36
-10.19	-3.86	-10.27	-11.99	4.00	-2.45	-7.80
-12.91	-2.56	-7.96	-10.18	4.00	-1.51	-6.67
-16.82	-4.10	-6.04	-9.14	4.00	-1.85	-7.09
-15.09	-8.02	-5.56	-8.91	4.00	-2.74	-8.27
-15.25	-7.94	-6.95	-12.50	4.00	-4.01	-9.50
-15.32	-5.56	-11.78	-14.80	4.00	-4.90	-9.93
-16.58	-4.29	-15.20	-15.56	4.00	-5.20	-9.46
-16.42	-3.14	-21.64	-17.27	4.00	-5.45	-8.75
-17.57	-3.29	-20.50	-14.24	4.00	-5.15	-8.75
-17.73	-4.08	-14.84	-13.20	4.00	-4.77	-9.13
-13.31	-4.49	-11.90	-13.53	4.00	-3.77	-8.85
-11.84	-5.25	-9.12	-14.85	4.00	-3.52	-8.87
-10.25	-5.47	-7.64	-18.11	4.00	-3.23	-8.49
-12.75	-4.18	-7.35	-14.79	4.00	-2.74	-7.88
-12.71	-3.85	-7.21	-13.56	4.00	-2.39	-7.57
-13.40	-4.54	-7.28	-13.27	4.00	-2.75	-8.02
-9.27	-6.64	-8.32	-12.39	4.00	-2.89	-8.70
-7.88	-8.31	-10.41	-11.41	4.00	-3.36	-9.27
-9.90	-6.80	-9.70	-12.44	4.00	-3.46	-9.25
-10.62	-4.57	-11.33	-13.34	4.00	-3.28	-8.57
-7.96	-2.65	-13.09	-14.25	4.00	-2.20	-7.05
-6.44	-1.74	-11.41	-14.31	4.00	-1.13	-5.99
-7.53	-1.50	-11.10	-12.83	4.00	-1.07	-5.96
-10.55	-1.27	-10.06	-11.98	4.00	-1.27	-6.03
-8.39	-2.77	-7				



Frequency: 6515MHz

Theta Polarization		Max Gain(dBi)				Nant	Phi Polarization		Max Gain(dBi)				Nant	Total				Max DG(dBi)						
Angle (θ)	Angle (φ)	Ant 1(G1)	Ant 2(G2)	Ant 3(G3)	Ant 4(G4)		Angle (θ)	Angle (φ)	Ant 1(G1)	Ant 2(G2)	Ant 3(G3)	Ant 4(G4)		Ant 1(G1)	Ant 2(G2)	Ant 3(G3)	Ant 4(G4)	Nant	6.04	0.12				
		0.61	0.97	1.02	2.94				1.60	3.85	1.60	-5.78									2.29	4.46	2.99	3.20
		Ant 1(G1)	Ant 2(G2)	Ant 3(G3)	Ant 4(G4)				Ant 1(G1)	Ant 2(G2)	Ant 3(G3)	Ant 4(G4)									Ant 1(G1)	Ant 2(G2)	Ant 3(G3)	Ant 4(G4)
0.00	0.00	-11.13	-3.70	-12.52	-14.54	4.00	0.00	0.00	-1.10	-9.46	-0.23	-13.72	4.00	-0.69	-2.68	0.02	-11.10	4.00	3.34	4.64				
0.00	10.00	-7.40	-3.08	-7.91	-13.13	4.00	0.00	10.00	-1.73	-13.24	-0.74	-15.37	4.00	-0.69	-2.68	0.02	-11.10	4.00	3.35	-2.08				
0.00	20.00	-5.00	-2.75	-5.11	-12.16	4.00	0.00	20.00	-2.70	-20.66	-1.57	-17.75	4.00	-0.69	-2.68	0.02	-11.10	4.00	3.34	-2.08				
0.00	30.00	-3.33	-2.69	-3.20	-11.52	4.00	0.00	30.00	-4.09	-29.06	-2.79	-21.44	4.00	-0.68	-2.68	0.02	-11.10	4.00	3.35	-2.08				
0.00	40.00	-2.17	-2.89	-1.86	-11.18	4.00	0.00	40.00	-6.08	-15.80	-4.52	-28.56	4.00	-0.69	-2.67	0.02	-11.10	4.00	3.35	-2.08				
0.00	50.00	-1.37	-3.38	-0.93	-11.11	4.00	0.00	50.00	-9.03	-10.93	-7.04	-39.02	4.00	-0.68	-2.68	0.02	-11.10	4.00	3.35	-2.08				
0.00	60.00	-0.89	-4.18	-0.34	-11.30	4.00	0.00	60.00	-13.97	-8.01	-10.99	-24.53	4.00	-0.68	-2.68	0.02	-11.10	4.00	3.35	-2.08				
0.00	70.00	-0.69	-5.36	-0.03	-11.77	4.00	0.00	70.00	-27.87	-6.04	-19.10	-19.51	4.00	-0.68	-2.68	0.02	-11.09	4.00	3.35	-2.08				
0.00	80.00	-0.76	-7.04	0.00	-12.56	4.00	0.00	80.00	-18.38	-4.66	-23.91	-16.54	4.00	-0.69	-2.68	0.02	-11.10	4.00	3.34	-2.08				
0.00	90.00	-1.10	-9.46	-0.23	-13.72	4.00	0.00	90.00	-11.13	-3.70	-12.52	-14.54	4.00	-0.69	-2.68	0.02	-11.10	4.00	3.34	-2.08				
0.00	100.00	-1.73	-13.24	-0.74	-15.37	4.00	0.00	100.00	-7.40	-3.08	-7.91	-13.13	4.00	-0.69	-2.68	0.02	-11.10	4.00	3.35	-2.08				
0.00	110.00	-2.70	-20.66	-1.57	-17.75	4.00	0.00	110.00	-5.00	-2.75	-5.11	-12.16	4.00	-0.69	-2.68	0.02	-11.10	4.00	3.34	-2.08				
0.00	120.00	-4.09	-29.06	-2.79	-21.44	4.00	0.00	120.00	-3.33	-2.69	-3.20	-11.52	4.00	-0.68	-2.68	0.02	-11.10	4.00	3.35	-2.08				
0.00	130.00	-6.08	-15.80	-4.52	-28.56	4.00	0.00	130.00	-2.17	-2.89	-1.86	-11.18	4.00	-0.69	-2.67	0.02	-11.10	4.00	3.35	-2.08				
0.00	140.00	-9.03	-10.93	-7.04	-39.02	4.00	0.00	140.00	-1.37	-3.38	-0.93	-11.11	4.00	-0.68	-2.68	0.02	-11.10	4.00	3.35	-2.08				
0.00	150.00	-13.97	-8.01	-10.99	-24.53	4.00	0.00	150.00	-0.89	-4.18	-0.34	-11.30	4.00	-0.68	-2.68	0.02	-11.10	4.00	3.35	-2.08				
0.00	160.00	-27.87	-6.04	-19.10	-19.51	4.00	0.00	160.00	-0.69	-5.36	-0.03	-11.77	4.00	-0.68	-2.68	0.02	-11.09	4.00	3.35	-2.08				
0.00	170.00	-18.38	-4.66	-23.91	-16.54	4.00	0.00	170.00	-0.76	-7.04	0.00	-12.56	4.00	-0.69	-2.68	0.02	-11.10	4.00	3.34	-2.08				
0.00	180.00	-11.13	-3.70	-12.52	-14.54	4.00	0.00	180.00	-1.10	-9.46	-0.23	-13.72	4.00	-0.69	-2.68	0.02	-11.10	4.00	3.34	-2.08				
0.00	190.00	-7.40	-3.08	-7.91	-13.13	4.00	0.00	190.00	-1.73	-13.24	-0.74	-15.37	4.00	-0.69	-2.68	0.02	-11.10	4.00	3.35	-2.08				
0.00	200.00	-5.00	-2.75	-5.11	-12.16	4.00	0.00	200.00	-2.70	-20.66	-1.57	-17.75	4.00	-0.69	-2.68	0.02	-11.10	4.00	3.34	-2.08				
0.00	210.00	-3.33	-2.69	-3.20	-11.52	4.00	0.00	210.00	-4.09	-29.06	-2.79	-21.44	4.00	-0.68	-2.68	0.02	-11.10	4.00	3.35	-2.08				
0.00	220.00	-2.17	-2.89	-1.86	-11.18	4.00	0.00	220.00	-6.08	-15.80	-4.52	-28.56	4.00	-0.69	-2.67	0.02	-11.10	4.00	3.35	-2.08				
0.00	230.00	-1.37	-3.38	-0.93	-11.11	4.00	0.00	230.00	-9.03	-10.93	-7.04	-39.02	4.00	-0.68	-2.68	0.02	-11.10	4.00	3.35	-2.08				
0.00	240.00	-0.89	-4.18	-0.34	-11.30	4.00	0.00	240.00	-13.97	-8.01	-10.99	-24.53	4.00	-0.68	-2.68	0.02	-11.10	4.00	3.35	-2.08				
0.00	250.00	-0.69	-5.36	-0.03	-11.77	4.00	0.00	250.00	-18.38	-4.66	-23.91	-16.54	4.00	-0.68	-2.68	0.02	-11.09	4.00	3.35	-2.08				
0.00	260.00	-0.76	-7.04	0.00	-12.56	4.00	0.00	260.00	-11.13	-3.70	-12.52	-14.54	4.00	-0.69	-2.68	0.02	-11.10	4.00	3.34	-2.08				
0.00	270.00	-1.10	-9.46	-0.23	-13.72	4.00	0.00	270.00	-7.40	-3.08	-7.91	-13.13	4.00	-0.69	-2.68	0.02	-11.10	4.00	3.35	-2.08				
0.00	280.00	-1.73	-13.24	-0.74	-15.37	4.00	0.00	280.00	-5.00	-2.75	-5.11	-12.16	4.00	-0.69	-2.68	0.02	-11.10	4.00	3.34	-2.08				
0.00	290.00	-2.70	-20.66	-1.57	-17.75	4.00	0.00	290.00	-3.33	-2.69	-3.20	-11.52	4.00	-0.68	-2.68	0.02	-11.10	4.00	3.35	-2.08				
0.00	300.00	-4.09	-29.06	-2.79	-21.44	4.00	0.00	300.00	-2.17	-2.89	-1.86	-11.18	4.00	-0.69	-2.67	0.02	-11.10	4.00	3.35	-2.08				
0.00	310.00	-6.08	-15.80	-4.52	-28.56	4.00	0.00	310.00	-1.37	-3.38	-0.93	-11.11	4.00	-0.68	-2.68	0.02	-11.10	4.00	3.35	-2.08				
0.00	320.00	-9.03	-10.93	-7.04	-39.02	4.00	0.00	320.00	-0.89	-4.18	-0.34	-11.30	4.00	-0.68	-2.68	0.02	-11.10	4.00	3.35	-2.08				
0.00	330.00	-13.97	-8.01	-10.99	-24.53	4.00	0.00	330.00	-0.69	-5.36	-0.03	-11.77	4.00	-0.68	-2.68	0.02	-11.09	4.00	3.35	-2.08				
0.00	340.00	-27.87	-6.04	-19.10	-19.51	4.00	0.00	340.00	-0.69	-5.36	-0.03	-11.77	4.00	-0.68	-2.68	0.02	-11.09	4.00	3.35	-2.08				
0.00	350.00	-18.38	-4.66	-23.91	-16.54	4.00	0.00	350.00	-0.76	-7.04	0.00	-12.56	4.00	-0.69	-2.68	0.02	-11.10	4.00	3.34	-2.08				
15.00	0.00	-14.30	-4.29	-3.66	-10.49	4.00	15.00	0.00	-1.16	-18.66	-1.65	-8.21	4.00	-0.69	-4.13	0.47	-6.19	4.00	3.70	-1.97				
15.00	10.00	-10.02	-3.95	-3.73	-10.32	4.00	15.00	10.00	-2.35	-20.07	-3.28	-10.74	4.00	-1.66	-3.85	-0.49	-7.51	4.00	3.03	-2.67				
15.00	20.00	-5.84	-2.29	-3.86	-12.63	4.00	15.00	20.00	-3.78	-16.69	-3.71	-12.38	4.00	-1.68	-2.14	-0.77	-9.49	4.00	3.10	-2.52				
15.00	30.00	-5.93	-2.51	-2.15	-16.44	4.00	15.00	30.00	-4.51	-9.96	-5.41	-14.65	4.00	-2.15	-1.79	-0.47	-12.44	4.00	2.86	-2.55				
15.00	40.00	-6.69	-4.61	-1.28	-12.90	4.00	15.00	40.00	-6.56	-8.91	-9.05	-14.90	4.00	-3.61	-3.24	-0.61	-10.54	4.00	2.20	-3.31				
15.00	50.00	-7.02	-5.61	-1.01	-11.19	4.00	15.00	50.00	-8.85	-6.67	-13.40	-18.35	4.00	-4.83	-3.10	-0.77	-10.43	4.00	1.90	-3.60				
15.00	60.00	-8.69	-7.40	-0.95	-10.50	4.00	15.00	60.00	-10.77	-5.50	-23.40	-22.08	4.00	-6.60	-3.34	-0.93	-10.21	4.00	1.43	-4.02				
15.00	70.00	-7.79	-8.60	-0.66	-12.24	4.00	15.00	70.00	-17.85	-3.01	-20.73	-16.68	4.00	-7.38	-1.95	-0.62	-10.91	4.00	1.74	-3.54				
15.00	80.00	-6.73	-11.36	-0.57	-13.28	4.00	15.00	80.00	-21.71	-2.40	-13.53	-11.88	4.00	-6.59	-1.88	-0.36	-9.51	4.00	2.17	-3.23				
15.00	90.00	-6.40	-15.64	-1.20	-13.47	4.00	15.00	90.00	-18.50	-1.74	-10.59	-11.18	4.00	-6.14	-1.57	-0.73	-9.17	4.00	2.27	-3.22				
15.00	100.00	-4.85	-15.90	-0.77	-13.80	4.00	15.00	100.00	-13.55	-1.37	-10.05	-9.11	4.00	-4.30	-2.94	-0.29	-7.84	4.00	2.59	-3.05				
15.00	110.00	-6.76	-13.70	-0.63	-12.35	4.00	15.00	110.00	-10.02	-3.37	-5.52	-8.42	4.00	-4.73	-2.99	0.18	-6.37	4.00	2.80	-2.83				
15.00	120.00	-5.87	-11.43	0.16	-10.11	4.00	15.00	120.00	-7.75	-4.29	-6.82	-10.07	4.00	-3.70	-3.52	0.72	-7.08	4.00	3.07	-2.50				
15.00	130.00	-5.81	-15.66	0.36	-8.91	4.00	15.00	130.00	-5.35	-4.63	-4.18	-11.57	4.00	-2.56	-4.30	1.67	-7.03	4.00	3.55	-1.88				
15.00	140.00	-7.41	-12.43	-0.55	-7.33	4.00	15.00	140.00	-3.08	-3.23	-2.95	-13.42	4.00	-1.72	-2.74	1.42	-6.37	4.00	4.11	-1.51				
15.00	150.00	-9.37	-10.55	-1.42	-5.96	4.00	15.00	150.00	-1.06	-2.83	-0.95	-16.44	4.00	-0.46	-2.15	1.83	-5.59	4.00	4.83	-0.82				
15.00	160.00	-17.14	-4.42	-3.18	-5.44	4.00	15.00	160.00	-0.14	-3.41	0.24	-13.15	4.00	-1.02	-0.88	1.87	-4.76	4.00	5.38	-0.37				
15.00	170.00	-16.44	-1.92	-6.02	-5.04	4.00	15.00	170.00	1.14	-5.45	1.06	-15.87	4.00	1.22	-0.33	1.84	-4.70	4.00	5.87	0.12				
15.00	180.00	-11.55	-1.58	-9.99	-5.92	4.00	15.00	180.00	1.29	-9.56	1.60	-19.03	4.00	1.51	-0.94	1.89	-5.71	4.00	5.69	0.04				
15.00	190.00	-7.27	-1.99	-16.57	-6.94	4.00	15.00	190.00	0.66	-16.92	1.27	-19.24	4.00	1.31	-1.85	1.34	-6.69	4.00	5.11	-0.48				
15.00	200.00	-5.15	-1.14	-29.89	-7.73	4.00	15.00	200.00	-0.10	-28.83	1.10	-15.68	4.00	1.08	-1.13	1.10	-7.08	4.00	5.08	-0.53				
15.00	210.00	-4.00	-0.99	-13.34	-8.87	4.00	15.00	210.00	-1.44	-11.05	0.49	-13.94	4.00	0.48	-									



45.00	190.00	-12.49	-2.70	-5.81	-5.50	4.00	45.00	190.00	0.23	-23.48	0.95	-24.53	4.00	0.46	-2.66	1.78	-5.45	4.00	4.99	-0.65
45.00	200.00	-6.83	-4.20	-6.87	-4.33	4.00	45.00	200.00	-0.19	-9.92	1.05	-36.43	4.00	0.66	-3.17	1.70	-4.33	4.00	5.10	-0.59
45.00	210.00	-3.63	-2.29	-8.18	-5.31	4.00	45.00	210.00	-0.28	-5.40	0.98	-41.83	4.00	1.37	-0.56	1.48	-5.31	4.00	5.66	-0.06
45.00	220.00	-1.70	-2.22	-12.34	-5.81	4.00	45.00	220.00	-1.92	-8.01	0.18	-19.67	4.00	1.20	-1.20	0.42	-5.64	4.00	5.08	-0.64
45.00	230.00	-1.19	-5.34	-14.48	-5.34	4.00	45.00	230.00	-2.30	-4.18	-0.21	-24.61	4.00	1.30	-1.71	-0.05	-5.29	4.00	4.91	-0.83
45.00	240.00	-1.97	-8.82	-13.40	-6.36	4.00	45.00	240.00	-3.42	-0.56	-2.82	-16.06	4.00	0.38	0.04	-2.46	-5.92	4.00	4.37	-1.36
45.00	250.00	-2.48	-9.98	-15.23	-5.90	4.00	45.00	250.00	-6.79	-1.05	-5.46	-16.55	4.00	-1.11	1.38	-5.02	-5.54	4.00	3.92	-1.64
45.00	260.00	-2.84	-6.94	-15.01	-5.17	4.00	45.00	260.00	-10.87	2.76	-11.98	-19.93	4.00	-2.21	3.20	-10.23	-5.03	4.00	3.78	-1.11
45.00	270.00	-3.40	-4.73	-18.11	-5.13	4.00	45.00	270.00	-18.16	3.06	-21.16	-26.60	4.00	-3.26	3.73	-16.36	-5.10	4.00	3.32	-1.02
45.00	280.00	-4.26	-4.52	-16.78	-6.15	4.00	45.00	280.00	-20.31	3.35	-9.13	-31.56	4.00	-4.15	4.01	-8.44	-6.14	4.00	3.74	-0.85
45.00	290.00	-4.01	-5.85	-17.74	-5.78	4.00	45.00	290.00	-12.87	3.55	-3.65	-16.12	4.00	-3.42	4.02	-3.48	-3.40	4.00	4.79	-0.32
45.00	300.00	-2.58	-7.88	-14.49	-4.35	4.00	45.00	300.00	-1.84	1.93	-0.67	-14.37	4.00	-1.16	2.36	-0.49	-3.94	4.00	5.70	-0.24
45.00	310.00	-2.19	-10.26	-10.72	-4.31	4.00	45.00	310.00	-1.87	-1.25	-1.42	-11.89	4.00	0.98	-0.74	-0.94	-3.61	4.00	5.10	-0.78
45.00	320.00	-3.47	-5.73	-7.28	-2.86	4.00	45.00	320.00	-0.61	-0.69	-0.42	-13.67	4.00	1.20	0.49	-0.39	-2.51	4.00	6.02	0.10
45.00	330.00	-5.72	-4.53	-6.23	-2.69	4.00	45.00	330.00	0.08	-2.73	-0.71	-15.47	4.00	1.09	-0.53	0.36	-2.47	4.00	5.74	-0.19
45.00	340.00	-8.34	-9.22	-3.28	-0.99	4.00	45.00	340.00	0.48	-7.57	-0.45	-18.94	4.00	1.02	-2.57	-1.37	-0.92	4.00	5.89	0.00
45.00	350.00	-15.11	-4.11	-2.57	-1.51	4.00	45.00	350.00	0.80	-10.32	-1.39	-11.17	4.00	0.91	-3.18	1.07	-1.06	4.00	5.62	-0.25
60.00	0.00	-8.92	-1.27	-3.75	-1.63	4.00	60.00	0.00	-0.52	-10.67	-0.14	-13.19	4.00	0.07	-0.80	1.43	-1.34	4.00	5.92	-0.03
60.00	10.00	-12.22	-0.66	-2.72	-4.14	4.00	60.00	10.00	-0.86	-2.83	-2.42	-14.00	4.00	-0.55	1.40	0.44	-3.71	4.00	5.62	-0.23
60.00	20.00	-22.09	0.05	-1.43	-4.89	4.00	60.00	20.00	-0.39	-5.23	-2.91	-20.79	4.00	-0.36	1.18	0.90	-4.78	4.00	5.55	-0.23
60.00	30.00	-13.77	-0.88	-6.03	-7.79	4.00	60.00	30.00	-1.94	-4.04	-4.05	-27.09	4.00	-1.66	0.83	-1.92	-7.74	4.00	3.91	-1.70
60.00	40.00	-19.61	-5.14	-6.36	-10.82	4.00	60.00	40.00	-2.42	-0.63	-6.44	-13.15	4.00	-2.34	1.65	-2.39	-8.82	4.00	3.56	-1.81
60.00	50.00	-24.97	-4.94	-8.16	-11.76	4.00	60.00	50.00	-6.11	-1.99	-6.03	-11.49	4.00	-6.05	-0.21	-3.96	-8.61	4.00	1.87	-3.61
60.00	60.00	-15.57	-5.64	-9.38	-18.31	4.00	60.00	60.00	-9.47	-3.06	-9.17	-11.24	4.00	-8.52	-1.15	-6.26	-10.46	4.00	0.16	-5.11
60.00	70.00	-12.50	-11.26	-8.02	-31.21	4.00	60.00	70.00	-15.39	-3.84	-27.42	-17.31	4.00	-10.70	-3.20	-5.20	3.20	4.00	3.46	-1.31
60.00	80.00	-13.06	-16.71	-9.25	-22.68	4.00	60.00	80.00	-16.85	-3.95	-9.20	-15.54	4.00	-11.54	-3.73	-6.10	-14.77	4.00	-1.97	-7.14
60.00	90.00	-14.43	-17.51	-9.64	-17.26	4.00	60.00	90.00	-22.81	-4.64	-9.57	-16.19	4.00	-13.84	-4.42	-6.20	-13.68	4.00	-2.49	-7.66
60.00	100.00	-15.17	-13.64	-9.92	-15.90	4.00	60.00	100.00	-12.81	-8.56	-10.94	-30.60	4.00	-10.82	-7.39	-7.39	-15.76	4.00	-3.71	-9.26
60.00	110.00	-11.98	-15.01	-9.74	-16.24	4.00	60.00	110.00	-8.50	-3.59	-9.86	-22.60	4.00	-6.89	-3.19	-6.79	-15.44	4.00	-1.08	-6.42
60.00	120.00	-12.10	-11.03	-6.66	-10.13	4.00	60.00	120.00	-6.16	-0.52	-8.32	-22.26	4.00	-5.17	-0.25	-4.40	-5.87	4.00	1.79	-3.63
60.00	130.00	-14.81	-7.52	-5.23	-8.56	4.00	60.00	130.00	-3.97	-2.37	-4.64	-13.91	4.00	-3.63	-1.21	-1.91	-7.45	4.00	2.78	-2.98
60.00	140.00	-20.59	-7.82	-4.29	-8.47	4.00	60.00	140.00	-3.02	-4.49	-4.33	-11.69	4.00	-2.94	-2.87	-3.02	-6.78	4.00	2.77	-3.06
60.00	150.00	-23.60	-9.63	-6.84	-4.55	4.00	60.00	150.00	-3.55	-6.79	-2.12	-17.43	4.00	-3.51	-4.97	-0.86	-4.33	4.00	2.75	-3.11
60.00	160.00	-18.53	-13.46	-4.58	-6.75	4.00	60.00	160.00	-3.80	-11.03	-2.50	-17.12	4.00	-3.66	-9.07	-0.41	-6.37	4.00	1.74	-3.73
60.00	170.00	-13.59	-9.43	-17.02	-5.17	4.00	60.00	170.00	-1.52	-12.18	-4.39	-21.54	4.00	-1.26	-7.79	-2.10	-5.01	4.00	2.34	-2.36
60.00	180.00	-11.16	-10.75	-5.39	-4.95	4.00	60.00	180.00	-0.73	-13.96	-1.51	-33.67	4.00	-0.35	-8.92	-0.02	-4.94	4.00	3.17	-2.28
60.00	190.00	-10.64	-3.98	-5.44	-4.59	4.00	60.00	190.00	-1.28	-15.18	-0.37	-34.77	4.00	-0.80	-3.66	0.81	-4.59	4.00	4.23	-1.53
60.00	200.00	-7.91	-5.54	-5.04	-5.02	4.00	60.00	200.00	-1.44	-25.36	-1.26	-21.96	4.00	-0.56	-5.49	0.26	-4.93	4.00	3.71	-1.96
60.00	210.00	-6.90	-4.06	-7.16	-5.93	4.00	60.00	210.00	-0.85	-10.90	-0.85	-22.13	4.00	0.11	-3.24	0.06	-5.83	4.00	4.14	-1.59
60.00	220.00	-5.80	-6.46	-8.47	-7.24	4.00	60.00	220.00	-1.64	-10.90	-0.58	-24.50	4.00	-0.23	-5.13	0.07	-7.16	4.00	3.45	-2.10
60.00	230.00	-7.71	-9.75	-8.85	-6.88	4.00	60.00	230.00	-3.88	-10.00	-0.60	-21.07	4.00	-2.38	-6.86	0.01	-6.18	4.00	2.63	-2.95
60.00	240.00	-9.30	-10.79	-10.62	-5.63	4.00	60.00	240.00	-7.69	-2.84	-3.88	-21.56	4.00	-5.41	-2.19	-3.05	-5.52	4.00	2.10	-3.80
60.00	250.00	-6.39	-11.03	-12.32	-4.46	4.00	60.00	250.00	-12.69	-6.67	-17.32	4.00	-5.48	-0.39	-5.62	-4.78	-4.24	4.00	2.36	-3.35
60.00	260.00	-4.57	-9.17	-13.09	-3.83	4.00	60.00	260.00	-16.31	0.13	-14.19	-18.76	4.00	-4.29	0.61	-10.59	-3.69	4.00	2.39	-2.93
60.00	270.00	-4.00	-10.05	-12.46	-4.15	4.00	60.00	270.00	-12.79	0.73	-12.94	-20.46	4.00	-3.46	1.08	-9.68	-4.05	4.00	2.79	-2.53
60.00	280.00	-5.28	-24.08	-12.10	-3.02	4.00	60.00	280.00	-8.48	0.33	-6.18	-20.98	4.00	-3.58	0.35	-5.19	-2.95	4.00	3.42	-2.35
60.00	290.00	-7.06	-10.93	-11.35	-2.09	4.00	60.00	290.00	-7.87	-0.61	-5.54	-17.28	4.00	-4.44	-0.22	-4.53	-0.61	4.00	3.42	-2.41
60.00	300.00	-9.10	-6.58	-7.57	-1.74	4.00	60.00	300.00	-4.22	-1.12	-4.97	-16.97	4.00	-3.00	-0.03	-3.07	-1.61	4.00	4.18	-1.74
60.00	310.00	-9.38	-8.52	-6.29	-4.19	4.00	60.00	310.00	-4.38	-0.52	-1.52	-14.14	4.00	-3.19	0.62	-0.27	-0.77	4.00	4.57	-1.26
60.00	320.00	-7.43	-21.61	-8.46	-3.44	4.00	60.00	320.00	-1.29	-2.51	-1.37	-24.60	4.00	-0.34	-2.46	-0.59	-3.41	4.00	4.41	-1.52
60.00	330.00	-11.40	-6.43	-2.80	-1.62	4.00	60.00	330.00	-0.62	-2.16	-0.35	-9.69	4.00	-0.27	-0.78	1.61	-0.99	4.00	5.97	0.02
60.00	340.00	-9.88	-5.63	-4.98	-0.13	4.00	60.00	340.00	0.56	-7.75	-0.59	-12.76	4.00	0.94	-3.55	0.76	0.10	4.00	5.76	-0.11
60.00	350.00	-11.44	-3.69	-1.77	-0.48	4.00	60.00	350.00	1.55	-17.39	-3.51	-16.86	4.00	1.76	-3.51	0.46	-0.38	4.00	5.81	-0.03
75.00	0.00	-7.96	-4.19	-5.96	1.45	4.00	75.00	0.00	-0.40	-19.23	-3.21	-21.12	4.00	0.30	-4.06	-1.36	1.46	4.00	5.34	-0.46
75.00	10.00	-12.28	-2.02	-6.38	-0.54	4.00	75.00	10.00	0.86	-11.02	-2.42	-17.83	4.00	1.07	-1.51	0.86	-0.95	4.00	5.61	-0.35
75.00	20.00	-21.67	-0.05	-6.84	-5.02	4.00	75.00	20.00	1.42	-3.28	-3.97	-22.81	4.00	1.44	-1.64	-2.16	-4.95	4.00	5.42	-0.25
75.00	30.00	-15.24	-3.54	-6.61	-12.89	4.00	75.00	30.00	0.67	-6.39	-5	-17.10	4.00	0.98	1.72	-5.72	-11.49	4.00	3.33	-1.99
75.00	40.00	-15.58	-9.43	-12.33	-13.08	4.00	75.00	40.00	4.26	-12.33	-6.78	-22.32	4.00	-3.95	-1.76	-5.71	-6.59	4.00	2.84	-5.58
75.00	50.00	-14.05	-16.46	-10.54	-12.75	4.00	75.00	50.00	-3.12	0.41	-7.68	-10.49	4.00	-2.78	0.50	-1.12	-8.87	4.00	3.30	-3.00
75.00	60.00	-10.07	-22.63	-6.87	-6.53	4.00	75.00	60.00	-5.95	-1.24	-12.97	-17.02	4.00	-4.53	-1.21	-5.92	-15.36	4.00	0.59	-4.58
75.00	70.00	-15.71	-16.96	-8.7	-15.21	4.00	75.00	70.00	-6.35	-11.07	-10.39	-18.52	4.00	-5.87	-10.07	-6.45	-13			



105.00	100.00	-8.64	-14.84	-17.10	-34.54	4.00	105.00	100.00	-18.89	-12.71	-13.64	-11.31	4.00	-8.25	-10.64	-12.02	-11.29	4.00	-4.41	-10.30
105.00	110.00	-19.78	-11.51	-24.59	-17.27	4.00	105.00	110.00	-9.42	-5.72	-8.18	-10.24	4.00	-9.04	-4.70	-8.08	-9.45	4.00	-1.59	-7.37
105.00	120.00	-12.11	-13.15	-13.37	-9.57	4.00	105.00	120.00	-17.70	-5.77	-13.24	-8.40	4.00	-11.05	-5.87	-10.29	-5.99	4.00	-1.94	-7.66
105.00	130.00	-11.14	-21.90	-15.49	-5.72	4.00	105.00	130.00	-9.22	-18.01	-11.22	-14.71	4.00	-7.06	-16.52	-9.84	-5.20	4.00	-2.71	-8.07
105.00	140.00	-23.44	-19.64	-16.03	-1.71	4.00	105.00	140.00	-7.07	-13.54	-15.15	-18.27	4.00	-6.97	-12.59	-12.56	-16.27	4.00	-1.17	-6.02
105.00	150.00	-26.17	-4.44	-21.61	-1.71	4.00	105.00	150.00	-8.34	-7.62	-19.95	-16.85	4.00	-8.27	-2.73	-17.69	-1.58	4.00	0.34	-4.58
105.00	160.00	-21.64	-4.05	-8.73	-1.29	4.00	105.00	160.00	-8.18	-9.66	-12.22	-14.78	4.00	-7.99	-3.00	-7.12	-11.40	4.00	1.69	-3.90
105.00	170.00	-15.18	-11.17	-8.39	0.56	4.00	105.00	170.00	-8.03	-11.13	-8.97	-18.32	4.00	-7.26	-8.14	-5.66	0.62	4.00	1.65	-3.55
105.00	180.00	-16.57	-10.15	-6.17	1.78	4.00	105.00	180.00	-6.24	-27.12	-10.93	-11.44	4.00	-5.86	-10.06	-4.92	1.98	4.00	2.44	-2.48
105.00	190.00	-18.25	-9.39	-6.22	2.94	4.00	105.00	190.00	-3.48	-15.43	-12.64	-12.78	4.00	-3.34	-8.42	-5.33	3.05	4.00	3.59	-1.36
105.00	200.00	-11.84	-13.69	-4.87	2.39	4.00	105.00	200.00	-5.12	-19.73	-12.08	-15.25	4.00	-4.38	-12.72	-4.11	2.45	4.00	2.89	-1.81
105.00	210.00	-15.31	-5.67	-1.94	4.00	4.00	105.00	210.00	-9.51	-9.15	-10.36	-16.71	4.00	-8.50	-7.72	-4.00	2.00	4.00	2.44	-2.48
105.00	220.00	-21.08	-4.02	0.90	4.00	4.00	105.00	220.00	-10.68	-16.00	-6.31	-14.00	4.00	-10.30	-9.00	-2.01	1.04	4.00	2.22	-2.76
105.00	230.00	-21.68	-19.15	-4.23	-1.23	4.00	105.00	230.00	-10.39	-10.73	-7.73	-16.39	4.00	-10.08	-10.15	-2.63	-1.10	4.00	1.00	-4.21
105.00	240.00	-17.44	-19.74	-4.99	-2.69	4.00	105.00	240.00	-9.00	-6.53	-7.72	-20.83	4.00	-8.42	-6.33	-3.13	-2.62	4.00	1.21	-4.53
105.00	250.00	-10.98	-18.19	-3.34	-2.86	4.00	105.00	250.00	-11.25	-7.01	-9.64	-21.37	4.00	-8.10	-6.69	-2.43	-2.80	4.00	1.35	-4.36
105.00	260.00	-10.06	-17.64	-2.71	-0.57	4.00	105.00	260.00	-20.59	-9.20	-20.77	-18.96	4.00	-9.69	-8.62	-2.64	-0.51	4.00	1.51	-3.77
105.00	270.00	-7.88	-15.91	-2.49	1.08	4.00	105.00	270.00	-14.52	-10.44	-16.76	-21.24	4.00	-7.03	-9.36	-2.33	1.11	4.00	2.56	-2.62
105.00	280.00	-8.09	-15.37	-2.04	2.23	4.00	105.00	280.00	-9.80	-10.52	-9.04	-25.19	4.00	-5.85	-9.29	-1.25	2.24	4.00	3.56	-1.55
105.00	290.00	-9.24	-15.59	-3.22	2.53	4.00	105.00	290.00	-7.11	-9.89	-4.09	-16.71	4.00	-5.04	-8.85	-0.62	2.58	4.00	4.08	-1.08
105.00	300.00	-17.94	-11.01	-3.60	2.80	4.00	105.00	300.00	-5.08	-12.47	-2.82	-20.30	4.00	-4.86	-8.67	-0.18	2.82	4.00	4.36	-0.79
105.00	310.00	-14.13	-8.19	-4.85	0.92	4.00	105.00	310.00	-4.53	-7.87	-1.64	-17.69	4.00	-4.08	-5.02	0.06	0.98	4.00	4.38	-1.29
105.00	320.00	-12.73	-9.29	-5.87	-1.64	4.00	105.00	320.00	-4.18	-7.68	-0.90	-12.16	4.00	-3.61	-5.40	0.30	-1.27	4.00	3.79	-1.97
105.00	330.00	-15.12	-7.25	-7.61	-4.38	4.00	105.00	330.00	-5.44	-5.77	-1.81	-13.45	4.00	-5.00	-3.44	-0.80	-3.87	4.00	2.89	-2.98
105.00	340.00	-23.99	-6.80	-9.15	-3.28	4.00	105.00	340.00	-5.23	-5.54	-0.91	-16.64	4.00	-5.17	-3.11	-0.30	-3.08	4.00	3.28	-2.56
105.00	350.00	-13.60	-6.52	-10.58	0.25	4.00	105.00	350.00	-8.33	-7.02	-0.58	-14.94	4.00	-7.20	-3.75	-0.17	0.38	4.00	3.84	-1.76
120.00	0.00	-11.72	-3.62	-13.43	-2.13	4.00	120.00	0.00	-4.07	-18.93	-2.14	-10.56	4.00	-3.38	-3.49	-1.83	-1.55	4.00	3.50	-2.47
120.00	10.00	-11.06	-3.44	-19.62	-2.00	4.00	120.00	10.00	-4.97	-8.13	-3.99	-18.18	4.00	-4.01	-2.17	-3.87	-1.90	4.00	3.09	-2.88
120.00	20.00	-8.58	-5.00	-11.41	-2.10	4.00	120.00	20.00	-6.69	-2.85	-5.01	-22.16	4.00	-4.52	-0.78	-4.11	-2.06	4.00	3.29	-2.60
120.00	30.00	-11.79	-4.23	-12.14	-6.15	4.00	120.00	30.00	-8.74	-5.70	-8.65	-10.40	4.00	-6.99	-1.89	-7.04	-4.76	4.00	1.11	-4.63
120.00	40.00	-9.19	-8.17	-14.79	-9.52	4.00	120.00	40.00	-15.15	-5.68	-11.80	-6.36	4.00	-8.21	-3.74	-10.03	-4.65	4.00	-0.27	-5.95
120.00	50.00	-7.61	-4.03	-11.06	-11.04	4.00	120.00	50.00	-13.95	0.33	-9.21	-7.44	4.00	-6.70	-1.69	-7.03	-5.87	4.00	2.38	-2.71
120.00	60.00	-6.12	-13.40	-13.03	-16.40	4.00	120.00	60.00	-15.86	-5.80	-6.73	-14.40	4.00	-5.68	-5.10	-5.82	-12.28	4.00	0.77	-6.48
120.00	70.00	-8.10	-6.40	-13.54	-18.44	4.00	120.00	70.00	-16.46	-1.48	-5.46	-16.69	4.00	-7.51	-0.27	-4.83	-16.39	4.00	-0.49	-4.35
120.00	80.00	-11.47	-11.47	-21.75	-19.72	4.00	120.00	80.00	-9.46	-0.46	-14.00	-15.19	4.00	-9.47	-0.13	-13.33	-13.85	4.00	-1.21	-5.33
120.00	90.00	-10.84	-12.77	-25.39	-18.06	4.00	120.00	90.00	-5.72	-12.43	-8.28	-16.26	4.00	-4.56	-9.59	-8.21	-14.08	4.00	-2.17	-8.33
120.00	100.00	-9.64	-16.82	-22.25	-42.93	4.00	120.00	100.00	-8.85	-9.85	-8.52	-14.19	4.00	-6.02	-9.05	-8.34	-14.18	4.00	-2.91	-8.55
120.00	110.00	-15.46	-13.01	-19.99	-14.99	4.00	120.00	110.00	-25.25	-30.36	-7.30	-11.76	4.00	-15.03	-12.93	-7.07	-10.07	4.00	-4.73	-10.26
120.00	120.00	-10.74	-11.13	-16.05	-11.50	4.00	120.00	120.00	-8.47	-6.04	-7.85	-20.36	4.00	-6.45	-4.87	-7.24	-10.97	4.00	-1.09	-6.87
120.00	130.00	-8.13	-39.36	-12.55	-8.18	4.00	120.00	130.00	-9.02	-19.23	-30.15	-16.50	4.00	-5.54	-19.19	-12.48	-7.58	4.00	-3.78	-8.84
120.00	140.00	-13.27	-4.76	-14.27	-5.00	4.00	120.00	140.00	-12.67	-5.04	-16.72	-29.04	4.00	-9.95	-5.00	-12.31	-5.48	4.00	0.16	-4.77
120.00	150.00	-29.04	-3.47	-13.41	-4.45	4.00	120.00	150.00	-9.90	-7.88	-12.12	-18.58	4.00	-9.85	-2.13	-9.71	-4.29	4.00	0.18	-5.24
120.00	160.00	-19.97	-3.61	-8.31	-1.36	4.00	120.00	160.00	-6.62	-30.48	-24.29	-13.79	4.00	-6.42	-3.60	-8.20	-11.22	4.00	1.61	-4.01
120.00	170.00	-17.66	-4.93	-10.35	0.02	4.00	120.00	170.00	-9.87	-18.77	-17.27	-16.56	4.00	-9.20	-4.75	-9.55	0.11	4.00	1.11	-4.00
120.00	180.00	-12.64	-4.47	-11.43	1.08	4.00	120.00	180.00	-7.46	-18.19	-14.15	-10.12	4.00	-6.31	-4.29	-9.57	1.10	4.00	2.28	-2.81
120.00	190.00	-26.97	-13.62	-5.38	1.35	4.00	120.00	190.00	-10.59	-24.14	-14.92	-12.88	4.00	-10.49	-13.25	-4.92	1.51	4.00	1.11	-3.29
120.00	200.00	-10.25	-9.23	-5.92	1.92	4.00	120.00	200.00	-21.73	-7.00	-9.83	-16.42	4.00	-9.95	-4.96	-4.44	1.98	4.00	2.73	-2.29
120.00	210.00	-11.95	-16.99	-7.12	0.74	4.00	120.00	210.00	-19.62	-15.33	-9.06	-13.97	4.00	-11.26	-13.07	-4.97	0.88	4.00	0.70	-3.80
120.00	220.00	-15.40	-26.46	-3.95	-0.36	4.00	120.00	220.00	-11.29	-16.50	-7.36	-14.94	4.00	-9.87	-16.08	-2.32	-0.21	4.00	0.91	-3.80
120.00	230.00	-15.33	-20.17	-4.71	-2.29	4.00	120.00	230.00	-11.23	-8.28	-5.66	-18.79	4.00	-9.80	-8.01	-2.15	-2.19	4.00	1.13	-4.33
120.00	240.00	-13.14	-16.48	-4.14	-5.61	4.00	120.00	240.00	-13.26	-19.50	-5.02	-10.68	4.00	-10.19	-14.72	-1.55	-4.43	4.00	-0.31	-5.27
120.00	250.00	-14.77	-15.88	-5.07	-4.72	4.00	120.00	250.00	-9.98	-9.75	-5.94	-14.27	4.00	-8.74	-8.80	-2.47	-4.26	4.00	0.40	-5.21
120.00	260.00	-14.36	-19.22	-3.36	-1.41	4.00	120.00	260.00	-7.94	-8.71	-11.29	-15.32	4.00	-7.05	-7.51	-2.71	-1.24	4.00	1.81	-3.81
120.00	270.00	-11.38	-20.70	-2.42	0.73	4.00	120.00	270.00	-8.00	-7.40	-18.22	-25.16	4.00	-6.36	-7.20	-2.31	0.74	4.00	2.84	-2.60
120.00	280.00	-11.14	-19.13	-1.61	2.94	4.00	120.00	280.00	-8.60	-4.93	-10.22	-17.85	4.00	-6.68	-4.77	-1.05	2.98	4.00	4.44	-0.81
120.00	290.00	-11.39	-18.42	-2.01	2.89	4.00	120.00	290.00	-5.63	-4.70	-5.32	-10.44	4.00	-4.61	-4.52	-0.35	3.09	4.00	5.03	-0.39
120.00	300.00	-9.74	-13.30	-1.82	2.82	4.00	120.00	300.00	-4.48	-6.39	-4.64	-11.60	4.00	-3.27	-5.58	0.01	2.97	4.00	5.16	-0.30
120.00	310.00	-10.73	-10.01	-3.16	0.79	4.00	120.00	310.00	-4.37	-4.74	-2.18	-22.46	4.00	-3.55	-3.61	0.37	1.12	4.00	4.56	-1.84
120.00	320.00	-11.17	-5.99	-7.25	-4.31	4.00	120.00	320.00	-4.95	-2.24	-1.14	-13.92	4.00	-4.02	-0.71	-3.19	-2.24	4.00	-1.03	-4.02
120.00	330.00	-10.16	-3.40	-7.68	-6.78	4.00	120.00	330.00	-5.19	-5.03	-2.84	-16.29	4.00</							



165.00	10.00	-13.50	-12.14	-21.46	-12.73	4.00			165.00	10.00	-8.54	-6.32	-8.65	-9.96	4.00			-7.34	-5.31	-8.43	-8.12	4.00	-1.19	-7.12
165.00	20.00	-18.69	-6.99	-18.71	-19.93	4.00			165.00	20.00	-9.74	-9.69	-9.67	-12.38	4.00			-9.22	-5.12	-9.16	-11.68	4.00	-2.44	-8.12
165.00	30.00	-23.74	-4.58	-21.03	-19.03	4.00			165.00	30.00	-11.12	-11.37	-8.23	-9.89	4.00			-10.89	-3.75	-8.01	-9.39	4.00	-1.56	-7.12
165.00	40.00	-16.62	-6.91	-12.00	-18.68	4.00			165.00	40.00	-20.14	-7.54	-8.02	-10.31	4.00			-15.02	-4.20	-6.56	-9.72	4.00	-1.99	-7.33
165.00	50.00	-14.93	-17.75	-9.37	-21.99	4.00			165.00	50.00	-24.31	-7.30	-6.88	-8.24	4.00			-14.46	-6.93	-4.94	-8.06	4.00	-1.93	-7.47
165.00	60.00	-13.59	-20.49	-8.42	-25.70	4.00			165.00	60.00	-20.49	-7.90	-10.72	-11.52	4.00			-12.78	-7.67	-6.41	-11.36	4.00	-3.15	-8.81
165.00	70.00	-19.69	-12.98	-10.13	-34.21	4.00			165.00	70.00	-21.41	-5.58	-20.94	-14.45	4.00			-17.46	-4.85	-9.78	-14.40	4.00	-4.29	-9.15
165.00	80.00	-19.34	-13.76	-15.57	-34.49	4.00			165.00	80.00	-17.73	-3.61	-21.73	-16.02	4.00			-15.45	-3.21	-14.63	-15.96	4.00	-4.40	-8.49
165.00	90.00	-17.08	-10.00	-22.73	-26.34	4.00			165.00	90.00	-19.47	-3.61	-26.14	-26.44	4.00			-15.10	-2.71	-21.10	-23.38	4.00	-5.49	-8.40
165.00	100.00	-14.34	-7.30	-24.46	-21.26	4.00			165.00	100.00	-20.65	-5.48	-25.96	-19.48	4.00			-13.43	-3.29	-22.14	-17.27	4.00	-5.09	-8.70
165.00	110.00	-16.71	-6.35	-21.66	-14.50	4.00			165.00	110.00	-27.78	-6.21	-15.60	-18.77	4.00			-16.38	-3.27	-14.64	-13.12	4.00	-4.12	-8.41
165.00	120.00	-15.76	-7.57	-19.45	-14.74	4.00			165.00	120.00	-28.79	-6.70	-11.99	-25.90	4.00			-15.55	-4.10	-11.27	-14.42	4.00	-4.06	-8.80
165.00	130.00	-13.42	-8.36	-15.22	-15.60	4.00			165.00	130.00	-20.14	-7.51	-10.78	-28.78	4.00			-12.58	-4.90	-9.45	-15.40	4.00	-3.67	-8.85
165.00	140.00	-12.18	-8.45	-13.03	-17.69	4.00			165.00	140.00	-24.50	-8.14	-8.09	-19.40	4.00			-11.93	-5.28	-6.88	-15.45	4.00	-2.98	-8.28
165.00	150.00	-15.16	-8.31	-11.04	-21.34	4.00			165.00	150.00	-22.42	-7.77	-9.06	-17.73	4.00			-14.41	-5.02	-6.93	-16.16	4.00	-3.37	-8.40
165.00	160.00	-18.89	-7.35	-11.53	-20.32	4.00			165.00	160.00	-14.16	-7.47	-10.21	-14.48	4.00			-12.90	-4.40	-7.81	-13.47	4.00	-2.81	-8.06
165.00	170.00	-18.13	-7.64	-10.02	-20.68	4.00			165.00	170.00	-12.53	-10.34	-11.32	-13.72	4.00			-11.47	-5.77	-7.61	-12.92	4.00	-2.95	-8.54
165.00	180.00	-13.36	-6.89	-9.67	-21.34	4.00			165.00	180.00	-11.21	-19.41	-10.54	-13.51	4.00			-9.14	-6.65	-7.07	-12.85	4.00	-2.59	-8.34
165.00	190.00	-9.78	-7.94	-13.05	-23.72	4.00			165.00	190.00	-19.34	-20.61	-12.03	-11.84	4.00			-9.32	-7.71	-9.50	-11.57	4.00	-3.40	-9.32
165.00	200.00	-13.02	-9.83	-14.85	-23.68	4.00			165.00	200.00	-19.67	-10.69	-20.29	-14.22	4.00			-12.17	-7.23	-13.76	-13.75	4.00	-5.26	-10.78
165.00	210.00	-12.02	-14.03	-12.77	-17.11	4.00			165.00	210.00	-15.54	-6.04	-15.72	-15.66	4.00			-10.42	-5.40	-10.99	-13.31	4.00	-3.50	-8.98
165.00	220.00	-7.92	-14.90	-15.24	-20.41	4.00			165.00	220.00	-14.20	-2.84	-14.28	-21.08	4.00			-7.00	-2.58	-11.72	-17.72	4.00	-2.05	-6.80
165.00	230.00	-8.46	-16.20	-15.68	-16.30	4.00			165.00	230.00	-13.41	-0.84	-13.08	-18.70	4.00			-7.25	-0.72	-11.18	-14.33	4.00	-0.80	-5.42
165.00	240.00	-9.82	-17.02	-24.82	-16.58	4.00			165.00	240.00	-12.29	-0.03	-10.32	-16.14	4.00			-7.87	0.06	-10.17	-13.34	4.00	-0.28	-4.82
165.00	250.00	-14.23	-24.64	-24.69	-18.91	4.00			165.00	250.00	-10.07	-0.86	-8.62	-11.27	4.00			-8.66	-0.84	-8.51	-10.58	4.00	-0.23	-5.27
165.00	260.00	-19.54	-15.57	-23.97	-17.98	4.00			165.00	260.00	-8.74	-2.52	-8.17	-9.95	4.00			-8.39	-2.31	-8.06	-9.32	4.00	-0.52	-6.00
165.00	270.00	-18.31	-11.40	-28.92	-15.46	4.00			165.00	270.00	-7.09	-5.08	-7.12	-7.50	4.00			-6.77	-4.17	-7.09	-6.86	4.00	-0.12	-6.04
165.00	280.00	-11.66	-10.77	-31.30	-13.24	4.00			165.00	280.00	-6.25	-8.91	-6.60	-6.88	4.00			-5.15	-6.73	-6.59	-5.98	4.00	-0.07	-6.07
165.00	290.00	-8.59	-14.61	-30.06	-10.47	4.00			165.00	290.00	-6.10	-14.57	-5.84	-6.19	4.00			-4.16	-11.58	-5.82	-4.81	4.00	-0.13	-5.83
165.00	300.00	-8.64	-11.14	-36.19	-10.65	4.00			165.00	300.00	-5.81	-13.90	-5.18	-6.66	4.00			-3.99	-9.29	-5.18	-5.20	4.00	0.32	-5.52
165.00	310.00	-8.26	-6.81	-22.23	-8.57	4.00			165.00	310.00	-5.17	-21.38	-5.30	-8.03	4.00			-3.44	-6.66	-5.21	-5.28	4.00	0.95	-4.99
165.00	320.00	-10.11	-3.63	-13.48	-6.94	4.00			165.00	320.00	-7.83	-12.69	-8.51	-8.27	4.00			-5.81	-3.12	-7.31	-4.54	4.00	0.96	-4.93
165.00	330.00	-11.65	-1.95	-12.31	-6.35	4.00			165.00	330.00	-8.27	-18.16	-7.84	-9.62	4.00			-6.63	-1.85	-6.51	-4.67	4.00	1.33	-4.45
165.00	340.00	-16.93	0.15	-15.98	-6.43	4.00			165.00	340.00	-7.43	-13.90	-6.67	-10.11	4.00			-6.97	0.32	-6.19	-4.88	4.00	2.10	-3.37
165.00	350.00	-21.48	-0.48	-15.92	-8.11	4.00			165.00	350.00	-8.77	-14.75	-5.98	-9.24	4.00			-8.54	-0.32	-5.47	-5.63	4.00	1.56	-3.91
180.00	0.00	-15.23	-6.79	-13.39	-8.69	4.00			180.00	0.00	-16.10	-18.13	-14.69	-12.65	4.00			-12.63	-6.48	-10.98	-7.22	4.00	-2.94	-8.63
180.00	10.00	-14.08	-6.52	-12.29	-7.90	4.00			180.00	10.00	-18.12	-27.38	-16.82	-15.62	4.00			-12.64	-6.48	-10.98	-7.22	4.00	-2.94	-8.63
180.00	20.00	-13.30	-6.52	-11.56	-7.43	4.00			180.00	20.00	-21.12	-27.99	-20.01	-20.62	4.00			-12.64	-6.49	-10.98	-7.23	4.00	-2.95	-8.63
180.00	30.00	-12.83	-6.78	-11.13	-7.23	4.00			180.00	30.00	-26.19	-18.32	-25.59	-34.94	4.00			-12.63	-6.49	-10.98	-7.22	4.00	-2.94	-8.63
180.00	40.00	-12.64	-7.33	-10.98	-7.30	4.00			180.00	40.00	-41.29	-14.02	-49.05	-24.75	4.00			-12.63	-6.49	-10.99	-7.22	4.00	-2.94	-8.63
180.00	50.00	-12.72	-8.20	-11.10	-7.64	4.00			180.00	50.00	-29.89	-11.35	-26.83	-17.59	4.00			-12.64	-6.49	-10.99	-7.22	4.00	-2.94	-8.63
180.00	60.00	-13.06	-9.47	-11.48	-8.28	4.00			180.00	60.00	-22.89	-9.52	-20.60	-13.90	4.00			-12.63	-6.48	-10.98	-7.23	4.00	-2.94	-8.63
180.00	70.00	-13.71	-11.28	-12.17	-9.25	4.00			180.00	70.00	-19.23	-8.24	-17.19	-11.51	4.00			-12.64	-6.49	-10.98	-7.22	4.00	-2.94	-8.63
180.00	80.00	-14.69	-13.91	-13.21	-10.66	4.00			180.00	80.00	-16.87	-7.35	-14.95	-9.85	4.00			-12.63	-6.48	-10.98	-7.23	4.00	-2.94	-8.63
180.00	90.00	-16.10	-18.13	-14.69	-12.65	4.00			180.00	90.00	-15.23	-6.79	-13.39	-8.69	4.00			-12.63	-6.48	-10.98	-7.22	4.00	-2.94	-8.63
180.00	100.00	-18.12	-27.38	-16.82	-15.62	4.00			180.00	100.00	-14.08	-6.52	-12.29	-7.90	4.00			-12.64	-6.48	-10.98	-7.22	4.00	-2.94	-8.63
180.00	110.00	-21.12	-27.99	-20.01	-20.62	4.00			180.00	110.00	-13.30	-6.52	-11.56	-7.43	4.00			-12.64	-6.49	-10.98	-7.23	4.00	-2.95	-8.63
180.00	120.00	-26.19	-18.32	-25.59	-34.94	4.00			180.00	120.00	-12.83	-6.78	-11.13	-7.23	4.00			-12.63	-6.49	-10.98	-7.22	4.00	-2.94	-8.63
180.00	130.00	-41.29	-14.02	-49.05	-24.75	4.00			180.00	130.00	-12.64	-7.33	-10.98	-7.30	4.00			-12.63	-6.49	-10.98	-7.22	4.00	-2.94	-8.63
180.00	140.00	-29.89	-11.35	-26.83	-17.59	4.00			180.00	140.00	-12.72	-8.20	-11.10	-7.64	4.00			-12.64	-6.49	-10.99	-7.22	4.00	-2.94	-8.63
180.00	150.00	-22.89	-9.52	-20.60	-13.90	4.00			180.00	150.00	-13.06	-9.47	-11.48	-8.28	4.00			-12.63	-6.48	-10.98	-7.23	4.00	-2.94	-8.63
180.00	160.00	-19.23	-8.24	-17.19	-11.51	4.00			180.00	160.00	-13.71	-11.28	-12.17	-9.25	4.00			-12.64	-6.49	-10.98	-7.22	4.00	-2.94	-8.63
180.00	170.00	-16.87	-7.35	-14.95	-9.85	4.00			180.00	170.00	-14.69	-13.91	-13.21	-10.66	4.00			-12.63	-6.48	-10.98	-7.23	4.00	-2.94	-8.63
180.00	180.00	-15.23	-6.79	-13.39	-8.69	4.00			180.00	180.00	-16.10	-18.13	-14.69	-12.65	4.00			-12.63	-6.48	-10.98	-7.22	4.00	-2.94	-8.63
180.00	190.00	-14.08	-6.52	-12.29	-7.90	4.00			180.00	190.00	-18.12	-27.38	-16.82	-15.62	4.00			-12.64	-6.48	-10.98	-7.22	4.0		



Frequency: 6535MHz

Theta Polarization		Max Gain(dBi)				Nant	Angle (θ)	Angle (φ)	Phi Polarization				Nant	Total				Max D2G(dBi)	Max D3K(dBi)	
Angle (θ)	Angle (φ)	Ant 1(G1)	Ant 2(G2)	Ant 3(G3)	Ant 4(G4)				Ant 1(G1)	Ant 2(G2)	Ant 3(G3)	Ant 4(G4)		Ant 1(G1)	Ant 2(G2)	Ant 3(G3)	Ant 4(G4)			Nant
		1.42	1.26	1.56	3.81	1.22	3.33	1.14	-6.24	2.44	4.52	2.98	3.92	2.44	4.52	2.98	3.92	g1k	g3k	
		Ant 1(G1)	Ant 2(G2)	Ant 3(G3)	Ant 4(G4)			Ant 1(G1)	Ant 2(G2)	Ant 3(G3)	Ant 4(G4)			Ant 1(G1)	Ant 2(G2)	Ant 3(G3)	Ant 4(G4)			
0.00	0.00	-10.61	-2.97	-12.62	-14.87	4.00	0.00	0.00	-1.56	-9.12	-1.13	-13.27	4.00	-1.05	-2.03	-0.83	-10.99	4.00	3.13	-2.37
0.00	10.00	-7.22	-2.38	-8.34	-13.33	4.00	0.00	10.00	-2.25	-13.10	-1.69	-14.78	4.00	-1.05	-2.03	-0.84	-10.98	4.00	3.13	-2.37
0.00	20.00	-4.99	-2.08	-5.68	-12.26	4.00	0.00	20.00	-3.29	-21.31	-2.56	-16.95	4.00	-1.05	-2.03	-0.84	-10.99	4.00	3.13	-2.37
0.00	30.00	-3.44	-2.05	-3.86	-11.54	4.00	0.00	30.00	-4.79	-25.68	-3.84	-20.21	4.00	-1.05	-2.03	-0.84	-10.99	4.00	3.13	-2.37
0.00	40.00	-2.35	-2.28	-2.58	-11.13	4.00	0.00	40.00	-6.92	-14.50	-5.65	-26.00	4.00	-1.05	-2.03	-0.84	-10.99	4.00	3.13	-2.37
0.00	50.00	-1.62	-2.80	-1.70	-10.99	4.00	0.00	50.00	-10.13	-9.92	-8.29	-50.99	4.00	-1.05	-2.03	-0.84	-10.99	4.00	3.13	-2.37
0.00	60.00	-1.20	-3.63	-1.14	-11.11	4.00	0.00	60.00	-15.78	-7.13	-12.54	-26.39	4.00	-1.05	-2.03	-0.84	-10.98	4.00	3.13	-2.37
0.00	70.00	-1.05	-4.86	-0.87	-11.51	4.00	0.00	70.00	-41.05	-5.23	-21.91	-20.40	4.00	-1.05	-2.03	-0.84	-10.98	4.00	3.13	-2.37
0.00	80.00	-1.17	-6.60	-0.87	-12.22	4.00	0.00	80.00	-16.76	-3.90	-22.15	-17.07	4.00	-1.05	-2.03	-0.84	-10.99	4.00	3.13	-2.37
0.00	90.00	-1.56	-9.12	-1.13	-13.27	4.00	0.00	90.00	-10.61	-2.97	-12.62	-14.87	4.00	-1.05	-2.03	-0.83	-10.99	4.00	3.13	-2.37
0.00	100.00	-2.25	-13.10	-1.69	-14.78	4.00	0.00	100.00	-7.22	-2.38	-8.34	-13.33	4.00	-1.05	-2.03	-0.84	-10.98	4.00	3.13	-2.37
0.00	110.00	-3.29	-21.31	-2.56	-16.95	4.00	0.00	110.00	-4.99	-2.08	-5.68	-12.26	4.00	-1.05	-2.03	-0.84	-10.99	4.00	3.13	-2.37
0.00	120.00	-4.79	-25.68	-3.84	-20.21	4.00	0.00	120.00	-3.44	-2.05	-3.86	-11.54	4.00	-1.05	-2.03	-0.84	-10.99	4.00	3.13	-2.37
0.00	130.00	-6.92	-14.50	-5.65	-26.00	4.00	0.00	130.00	-2.35	-2.28	-2.58	-11.13	4.00	-1.05	-2.03	-0.84	-10.99	4.00	3.13	-2.37
0.00	140.00	-10.13	-9.92	-8.29	-50.99	4.00	0.00	140.00	-1.62	-2.80	-1.70	-10.99	4.00	-1.05	-2.03	-0.84	-10.99	4.00	3.13	-2.37
0.00	150.00	-15.78	-7.13	-12.54	-26.39	4.00	0.00	150.00	-1.20	-3.63	-1.14	-11.11	4.00	-1.05	-2.03	-0.84	-10.98	4.00	3.13	-2.37
0.00	160.00	-41.05	-5.23	-21.91	-20.40	4.00	0.00	160.00	-1.05	-4.86	-0.87	-11.51	4.00	-1.05	-2.03	-0.84	-10.98	4.00	3.13	-2.37
0.00	170.00	-16.76	-3.90	-22.15	-17.07	4.00	0.00	170.00	-1.17	-6.60	-0.87	-12.22	4.00	-1.05	-2.03	-0.84	-10.99	4.00	3.13	-2.37
0.00	180.00	-10.61	-2.97	-12.62	-14.87	4.00	0.00	180.00	-1.56	-9.12	-1.13	-13.27	4.00	-1.05	-2.03	-0.83	-10.99	4.00	3.13	-2.37
0.00	190.00	-7.22	-2.38	-8.34	-13.33	4.00	0.00	190.00	-2.25	-13.10	-1.69	-14.78	4.00	-1.05	-2.03	-0.84	-10.98	4.00	3.13	-2.37
0.00	200.00	-4.99	-2.08	-5.68	-12.26	4.00	0.00	200.00	-3.29	-21.31	-2.56	-16.95	4.00	-1.05	-2.03	-0.84	-10.99	4.00	3.13	-2.37
0.00	210.00	-3.44	-2.05	-3.86	-11.54	4.00	0.00	210.00	-4.79	-25.68	-3.84	-20.21	4.00	-1.05	-2.03	-0.84	-10.99	4.00	3.13	-2.37
0.00	220.00	-2.35	-2.28	-2.58	-11.13	4.00	0.00	220.00	-6.92	-14.50	-5.65	-26.00	4.00	-1.05	-2.03	-0.84	-10.99	4.00	3.13	-2.37
0.00	230.00	-1.62	-2.80	-1.70	-10.99	4.00	0.00	230.00	-10.13	-9.92	-8.29	-50.99	4.00	-1.05	-2.03	-0.84	-10.99	4.00	3.13	-2.37
0.00	240.00	-1.20	-3.63	-1.14	-11.11	4.00	0.00	240.00	-15.78	-7.13	-12.54	-26.39	4.00	-1.05	-2.03	-0.84	-10.98	4.00	3.13	-2.37
0.00	250.00	-1.05	-4.86	-0.87	-11.51	4.00	0.00	250.00	-41.05	-5.23	-21.91	-20.40	4.00	-1.05	-2.03	-0.84	-10.98	4.00	3.13	-2.37
0.00	260.00	-1.17	-6.60	-0.87	-12.22	4.00	0.00	260.00	-16.76	-3.90	-22.15	-17.07	4.00	-1.05	-2.03	-0.84	-10.99	4.00	3.13	-2.37
0.00	270.00	-1.56	-9.12	-1.13	-13.27	4.00	0.00	270.00	-10.61	-2.97	-12.62	-14.87	4.00	-1.05	-2.03	-0.83	-10.99	4.00	3.13	-2.37
0.00	280.00	-2.25	-13.10	-1.69	-14.78	4.00	0.00	280.00	-7.22	-2.38	-8.34	-13.33	4.00	-1.05	-2.03	-0.84	-10.99	4.00	3.13	-2.37
0.00	290.00	-3.29	-21.31	-2.56	-16.95	4.00	0.00	290.00	-4.99	-2.08	-5.68	-12.26	4.00	-1.05	-2.03	-0.84	-10.99	4.00	3.13	-2.37
0.00	300.00	-4.79	-25.68	-3.84	-20.21	4.00	0.00	300.00	-3.44	-2.05	-3.86	-11.54	4.00	-1.05	-2.03	-0.84	-10.99	4.00	3.13	-2.37
0.00	310.00	-6.92	-14.50	-5.65	-26.00	4.00	0.00	310.00	-2.35	-2.28	-2.58	-11.13	4.00	-1.05	-2.03	-0.84	-10.99	4.00	3.13	-2.37
0.00	320.00	-10.13	-9.92	-8.29	-50.99	4.00	0.00	320.00	-1.62	-2.80	-1.70	-10.99	4.00	-1.05	-2.03	-0.84	-10.99	4.00	3.13	-2.37
0.00	330.00	-15.78	-7.13	-12.54	-26.39	4.00	0.00	330.00	-1.20	-3.63	-1.14	-11.11	4.00	-1.05	-2.03	-0.84	-10.98	4.00	3.13	-2.37
0.00	340.00	-41.05	-5.23	-21.91	-20.40	4.00	0.00	340.00	-1.05	-4.86	-0.87	-11.51	4.00	-1.05	-2.03	-0.84	-10.98	4.00	3.13	-2.37
0.00	350.00	-16.76	-3.90	-22.15	-17.07	4.00	0.00	350.00	-1.17	-6.60	-0.87	-12.22	4.00	-1.05	-2.03	-0.84	-10.99	4.00	3.13	-2.37
15.00	0.00	-12.88	-3.92	-2.83	-10.14	4.00	15.00	0.00	-1.77	-17.59	-1.92	-10.72	4.00	-1.45	-3.74	0.66	-7.41	4.00	3.53	-2.07
15.00	10.00	-7.91	-4.24	-2.15	-8.55	4.00	15.00	10.00	-3.35	-32.72	-2.69	-12.14	4.00	-2.05	-4.23	0.60	-6.97	4.00	3.30	-2.31
15.00	20.00	-5.94	-2.70	-2.37	-12.65	4.00	15.00	20.00	-3.67	-16.63	-4.68	-12.90	4.00	-1.65	-2.53	-0.36	-9.76	4.00	3.10	-2.46
15.00	30.00	-5.31	-2.57	-1.36	-13.42	4.00	15.00	30.00	-5.33	-11.67	-5.91	-14.12	4.00	-2.31	-2.07	-0.05	-10.75	4.00	3.04	-2.44
15.00	40.00	-5.43	-4.41	-0.66	-11.79	4.00	15.00	40.00	-7.31	-10.64	-8.48	-11.98	4.00	-3.26	-3.48	0.00	-10.09	4.00	2.51	-2.97
15.00	50.00	-5.76	-5.76	-0.22	-10.05	4.00	15.00	50.00	-10.23	-8.60	-13.79	-23.11	4.00	-4.43	-3.94	-0.03	-9.84	4.00	2.12	-3.33
15.00	60.00	-6.21	-6.33	0.75	-10.37	4.00	15.00	60.00	-11.84	-6.19	-21.86	-21.78	4.00	-5.16	-6.25	-0.72	-10.07	4.00	1.85	-3.65
15.00	70.00	-7.23	-8.49	-0.24	-10.84	4.00	15.00	70.00	-14.72	-4.02	-26.41	-21.57	4.00	-6.52	-2.69	-0.23	-10.49	4.00	1.86	-3.47
15.00	80.00	-6.07	-10.32	-0.21	-12.52	4.00	15.00	80.00	-17.76	-2.76	-15.17	-13.59	4.00	-6.03	-2.06	-0.07	-10.01	4.00	2.26	-3.11
15.00	90.00	-5.01	-14.48	-0.32	-12.93	4.00	15.00	90.00	-17.76	-2.37	-12.71	-12.15	4.00	-4.79	-2.11	-0.08	-9.51	4.00	2.56	-2.92
15.00	100.00	-4.75	-18.02	0.24	-12.18	4.00	15.00	100.00	-15.26	-3.58	-9.25	-9.79	4.00	-4.38	-3.43	0.77	-8.71	4.00	2.66	-2.90
15.00	110.00	-5.22	-16.12	0.18	-9.88	4.00	15.00	110.00	-10.46	-4.63	-8.18	-10.24	4.00	-4.16	-4.93	0.27	-7.85	4.00	2.81	-2.71
15.00	120.00	-4.95	-13.19	0.83	-9.34	4.00	15.00	120.00	-8.06	-4.29	-6.25	-11.03	4.00	-3.47	-3.76	1.46	-7.07	4.00	3.36	-2.10
15.00	130.00	-5.44	-16.81	0.94	-7.14	4.00	15.00	130.00	-6.06	-5.41	-5.71	-12.16	4.00	-2.73	-5.11	1.79	-5.95	4.00	3.58	-1.86
15.00	140.00	-6.07	-16.01	0.35	-6.98	4.00	15.00	140.00	-3.92	-3.58	-3.71	-14.00	4.00	-1.85	-3.34	1.79	-6.19	4.00	4.10	-1.45
15.00	150.00	-9.76	-8.91	-1.27	-5.60	4.00	15.00	150.00	-1.96	-3.91	-1.93	-13.57	4.00	-1.29	-2.72	1.42	-4.96	4.00	4.44	-1.27
15.00	160.00	-18.91	-2.95	-2.98	-4.07	4.00	15.00	160.00	-0.28	-4.27	-0.28	-14.41	4.00	-0.22	-0.55	1.59	-3.69	4.00	5.50	-0.34
15.00	170.00	-21.47	-1.09	-5.08	-4.90	4.00	15.00	170.00	0.88	-6.26	0.47	-16.25	4.00	0.91	1.06	0.88	-4.25	4.00	5.80	0.02
15.00	180.00	-10.26	-0.72	-8.48	-5.51	4.00	15.00	180.00	0.80	-11.21	0.73	-21.87	4.00	1.13	-0.35	1.22	-5.41	4.00	5.54	-0.19
15.00	190.00	-5.89	-1.97	-14.08	-6.39	4.00	15.00	190.00	0.18	-19.68	0.65	-23.80	4.00	1.14	-1.90	0.79	-6.31	4.00	4.92	-0.73
15.00	200.00	-4.37	-0.43	-26.11	-7.39	4.00	15.00	200.00	-0.45	-26.97	0.06	-19.34	4.00	1.03	-0.42	0.07	-7.12	4.00	4.93	-0.72
15.00	210.00	-3.36	-0.36																	



45.00	190.00	-9.29	-2.28	-4.51	-5.22	4.00	45.00	190.00	-0.13	-20.31	0.48	-19.87	4.00	
45.00	200.00	-5.80	-4.26	-6.45	-3.52	4.00	45.00	200.00	-0.65	-10.15	0.27	-28.73	4.00	
45.00	210.00	-3.06	-1.08	-7.75	-4.98	4.00	45.00	210.00	-1.10	-4.67	-0.06	-26.02	4.00	
45.00	220.00	-1.60	-1.34	-12.30	-5.59	4.00	45.00	220.00	-2.34	-8.27	-0.20	-19.65	4.00	
45.00	230.00	-1.57	-5.42	-4.00	-12.56	4.00	45.00	230.00	-2.48	-4.02	-1.23	-16.58	4.00	
45.00	240.00	-1.18	-8.08	-14.37	-5.31	4.00	45.00	240.00	-3.72	-1.25	-3.47	-18.36	4.00	
45.00	250.00	-1.50	-9.36	-16.50	-4.47	4.00	45.00	250.00	-6.85	0.43	-6.64	-17.87	4.00	
45.00	260.00	-2.34	-7.17	-16.89	-4.02	4.00	45.00	260.00	-11.14	1.86	-12.70	-22.92	4.00	
45.00	270.00	-3.11	-4.77	-18.33	-4.98	4.00	45.00	270.00	-4.37	-18.47	2.65	-18.32	-25.04	4.00
45.00	280.00	-3.46	-3.87	-17.12	-5.58	4.00	45.00	280.00	-19.21	2.86	-9.44	-32.49	4.00	
45.00	290.00	-2.10	-5.24	-18.11	-4.40	4.00	45.00	290.00	-11.72	3.23	-0.97	-18.46	4.00	
45.00	300.00	-1.43	-7.44	-12.81	-5.72	4.00	45.00	300.00	-7.90	-0.99	-3.56	-10.00	4.00	
45.00	310.00	-1.73	-8.92	-10.23	-4.13	4.00	45.00	310.00	-2.84	-1.52	-2.05	-12.51	4.00	
45.00	320.00	-3.21	-5.20	-5.48	-2.26	4.00	45.00	320.00	-0.91	-0.87	-0.97	-15.34	4.00	
45.00	330.00	-5.41	-4.63	-4.34	-2.37	4.00	45.00	330.00	-0.68	-3.41	-0.97	-18.90	4.00	
45.00	340.00	-7.22	-3.77	-2.37	-0.39	4.00	45.00	340.00	-0.46	-7.79	-1.50	-17.87	4.00	
45.00	350.00	-16.91	-4.14	-1.49	-1.01	4.00	45.00	350.00	0.31	-11.51	-1.31	-12.69	4.00	
60.00	0.00	-9.00	-0.12	-2.67	-0.78	4.00	60.00	0.00	-1.23	-12.03	-0.76	-12.78	4.00	
60.00	10.00	-12.76	0.36	-2.36	-3.28	4.00	60.00	10.00	-1.46	-3.25	-2.38	-13.50	4.00	
60.00	20.00	-34.75	1.14	-1.02	-4.93	4.00	60.00	20.00	-1.28	-5.19	-2.98	-21.92	4.00	
60.00	30.00	-14.22	-0.26	-5.99	-8.04	4.00	60.00	30.00	-2.09	-4.23	-3.80	-30.06	4.00	
60.00	40.00	-16.54	-3.55	-5.56	-12.93	4.00	60.00	40.00	-3.09	-3.02	-6.83	-12.89	4.00	
60.00	50.00	-19.89	-3.58	-9.22	-11.18	4.00	60.00	50.00	-7.49	-2.96	-6.37	-10.91	4.00	
60.00	60.00	-16.39	-4.68	-9.99	-9.89	-16.21	4.00	60.00	60.00	-10.06	-3.76	-9.83	-10.94	4.00
60.00	70.00	-12.21	-10.22	-6.86	-32.72	4.00	60.00	70.00	-13.15	-4.95	-26.46	-19.19	4.00	
60.00	80.00	-11.65	-13.89	-7.72	-19.53	4.00	60.00	80.00	-17.35	-5.13	-9.95	-17.11	4.00	
60.00	90.00	-16.94	-18.79	-7.75	-12.86	4.00	60.00	90.00	-24.81	-4.91	-9.84	-16.86	4.00	
60.00	100.00	-16.14	-9.30	-7.30	-12.79	4.00	60.00	100.00	-11.33	-8.13	-11.33	-26.18	4.00	
60.00	110.00	-10.04	-14.26	-8.70	-13.78	4.00	60.00	110.00	-8.21	-3.64	-10.00	-26.90	4.00	
60.00	120.00	-9.80	-12.36	-5.64	-3.40	4.00	60.00	120.00	-6.30	-1.34	-8.37	-52.93	4.00	
60.00	130.00	-14.08	-7.45	-4.89	-8.05	4.00	60.00	130.00	-5.19	-3.53	-6.44	-15.87	4.00	
60.00	140.00	-23.32	-7.01	-3.98	-6.34	4.00	60.00	140.00	-4.13	-4.94	-4.32	-14.63	4.00	
60.00	150.00	-21.56	-10.58	-6.39	-4.99	4.00	60.00	150.00	-4.40	-6.82	-2.81	-23.34	4.00	
60.00	160.00	-19.22	-13.99	-3.44	-6.50	4.00	60.00	160.00	-3.62	-13.83	-3.04	-15.66	4.00	
60.00	170.00	-11.66	-8.67	-4.80	-17.02	4.00	60.00	170.00	-1.39	-10.94	-4.67	-19.73	4.00	
60.00	180.00	-11.41	-9.44	-4.05	-4.93	4.00	60.00	180.00	-1.43	-14.02	-2.22	-28.20	4.00	
60.00	190.00	-9.61	-3.55	-4.09	-3.62	4.00	60.00	190.00	-1.30	-17.10	-1.55	-31.60	4.00	
60.00	200.00	-8.02	-4.61	-4.24	-4.84	4.00	60.00	200.00	-2.39	-25.51	-1.26	-22.19	4.00	
60.00	210.00	-5.17	-3.52	-6.33	-5.11	4.00	60.00	210.00	-1.57	-11.79	-1.31	-24.77	4.00	
60.00	220.00	-5.17	-7.68	-7.55	-6.76	4.00	60.00	220.00	-1.89	-11.55	-0.85	-25.53	4.00	
60.00	230.00	-6.84	-10.83	-8.63	-5.39	4.00	60.00	230.00	-3.76	-10.59	-0.95	-32.06	4.00	
60.00	240.00	-8.64	-10.11	-8.54	-3.70	4.00	60.00	240.00	-7.83	-2.94	-3.75	-20.72	4.00	
60.00	250.00	-5.26	-8.34	-11.38	-3.45	4.00	60.00	250.00	-13.47	-13.47	-7.37	-19.48	4.00	
60.00	260.00	-3.49	-7.05	-11.88	-3.32	4.00	60.00	260.00	-15.21	-0.62	-15.53	-18.19	4.00	
60.00	270.00	-3.06	-9.31	-11.58	-3.41	4.00	60.00	270.00	-15.99	0.63	-12.64	-20.01	4.00	
60.00	280.00	-4.78	-21.02	-11.01	-3.12	4.00	60.00	280.00	-9.32	1.00	-7.40	-24.21	4.00	
60.00	290.00	-5.47	-9.42	-9.96	-1.01	4.00	60.00	290.00	-6.73	-1.29	-5.06	-23.71	4.00	
60.00	300.00	-8.32	-6.21	-6.95	-1.72	4.00	60.00	300.00	-3.68	-1.37	-4.77	-16.05	4.00	
60.00	310.00	-9.10	-5.74	-5.36	-3.80	4.00	60.00	310.00	-3.45	-0.03	-2.16	-15.88	4.00	
60.00	320.00	-7.42	-28.17	-7.25	-2.98	4.00	60.00	320.00	-1.84	-3.26	-1.27	-24.29	4.00	
60.00	330.00	-9.78	-6.08	-1.73	-1.81	4.00	60.00	330.00	-0.67	-2.66	-0.73	-9.05	4.00	
60.00	340.00	-7.91	-6.05	-4.25	0.55	4.00	60.00	340.00	-0.16	-7.85	-0.30	-11.79	4.00	
60.00	350.00	-12.26	-3.56	-0.77	-0.06	4.00	60.00	350.00	1.13	-19.34	-3.59	-16.44	4.00	
75.00	0.00	-7.97	-3.24	-4.87	2.13	4.00	75.00	0.00	-0.19	-24.75	-3.53	-28.04	4.00	
75.00	10.00	-13.55	-1.64	-5.76	0.14	4.00	75.00	10.00	0.78	-11.76	-2.29	-19.27	4.00	
75.00	20.00	-26.17	0.52	-5.42	-4.48	4.00	75.00	20.00	0.77	-3.31	-4.4	-31.05	4.00	
75.00	30.00	-13.04	-8.23	-6.59	-12.45	4.00	75.00	30.00	4.78	-6.06	-7.23	-22.32	4.00	
75.00	40.00	-11.48	-8.47	-11.55	-12.00	4.00	75.00	40.00	-0.96	-2.96	-7.71	-23.79	4.00	
75.00	50.00	-12.23	-14.79	-10.30	-4.00	4.00	75.00	50.00	-4.47	-0.48	-7.84	-14.91	4.00	
75.00	60.00	-8.71	-23.67	-6.49	-19.80	4.00	75.00	60.00	-6.41	-0.90	-14.49	-17.77	4.00	
75.00	70.00	-13.73	-18.00	-8.62	-13.53	4.00	75.00	70.00	-6.9	-11.99	-8.81	-26.46	4.00	
75.00	80.00	-10.78	-21.42	-7.54	-10.06	4.00	75.00	80.00	-10.26	-1.58	-6.84	-19.38	4.00	
75.00	90.00	-8.41	-8.72	-8.15	-20.71	4.00	75.00	90.00	-2.63	-0.72	-1.17	-14.99	4.00	
75.00	100.00	-9.83	-7.20	-9.88	-15.29	4.00	75.00	100.00	-12.04	-4.79	-13.71	-15.11	4.00	
75.00	110.00	-13.39	-8.89	-13.91	-12.72	4.00	75.00	110.00	-7.85	-9.63	-8.76	-23.77	4.00	
75.00	120.00	-10	-8.59	-7.13	-12.88	4.00	75.00	120.00	-6.25	-5.37	-10.45	-14.55	4.00	
75.00	130.00	-21.21	-11.27	-6.38	-5.86	4.00	75.00	130.00	-3.58	-0.16	-11.82	-16.33	4.00	
75.00	140.00	-14.84	-13.17	-6.77	-5.93	4.00	75.00	140.00	-3.08	-4.85	-13.72	-10.87	4.00	
75.00	150.00	-17.42	-6.75	-5.94	-3.42	4.00	75.00	150.00	-3.46	-5.49	-9.68	-12.08	4.00	
75.00	160.00	-20.01	-8.25	-7.22	-3.47	4.00	75.00	160.00	-3.43	-10.12	-10.81	-18.40	4.00	
75.00	170.00	-16.50	-13.18	-5.63	-1.26	4.00	75.00	170.00	-1.73	-12.70	-9.15	-17.27	4.00	
75.00	180.00	-12.65	-32.02	-5.92	-0.19	4.00	75.00	180.00	-0.66	-10.89	-6.81	-39.55	4.00	
75.00	190.00	-12.26	-15.56	-3.40	0.73	4.00	75.00	190.00	-0.35	-13.85	-8.14	-25.34	4.00	
75.00	200.00	-8.91	-10.11	-5.36	0.14	4.00	75.00	200.00	-0.83	-14.19	-6.15	-18.30	4.00	
75.00	210.00	-9.93	-7.77	-4.94	-0.85	4.00	75.00	210.00	-0.83	-8.55	-3.11	-19.41	4.00	
75.00	220.00	-8.27	-6.30	-3.48	-2.41	4.00	75.00	220.00	-4.82	-4.61	-10.80	-10.80	4.00	
75.00	230.00	-11.52	-11.23	-5.05	-3.33	4.00	75.00	230.00	-6.76	-4.06	-5.82	-11.21	4.00	
75.00	240.00	-8.23	-11.17	-4.82	-4.44	4.00	75.00	240.00	-11.33	-0.12	-6.36	-17.46	4.00	
75.00	250.00	-4.96	-6.44	-4.77	-2.18	4.00	75.00	250.00	-10.59	-1.55	-6.73	-22.78	4.00	
75.00	260.00	-4.17	-6.27	-5.41	0.09	4.00	75.00	260.00	-10.75	-3.42	-12.12	-22.99	4.00	
75.00	270.00	-4.03	-9.17	-4.83	1.31	4.00	75.00	270.00	-12.89	-6.00	-16.70	-22.54	4.00	
75.00	280.00	-9.09	-6.03	-23.43	-6.40	4.00	75.00	280.00	-19.33	-7.20	-8.67	-22.59	4.00	
75.00	290.00	-11.43	-20.51	-4.82	0.95	4.00	75.00	290.00	-12.04	-3.84	-3.80	-23.59	4.00	
75.00	300.00	-11.40	-12.56	-4.87	-0.10	4.00	75.00	300.00	-9.60	-1.24	-2.43	-18.18	4.00	
75.00	310.00	-9.17	-12.98	-4.37	-0.93	4.00	75.00	310.00	-8.24	0.21	-2.60	-16.53	4.00	
75.00	320.00	-7.86	-8.23	-2.65	-0.37	4.00	75.00	320.00	-3.53	-1.00	-0.99	-25.94	4.00	
75.00	330.00	-10.21	-6.92	-4.79	-0.76	4.00	75.00	330.00	-1.55	-5.58	-0.31	-27.61	4.00	
75.00	340.00	-8.01	-6.36	-1.62	0.71	4.00	75.00	340.00	-3.17	-5.42	-2.74	-14.31	4.00	
75.00	350.00	-17.54	-6.25</											



105.00	100.00	-7.24	-16.26	-15.25	-25.63	4.00	105.00	100.00	-15.28	-10.90	-12.39	-12.84	4.00	-6.61	-9.79	-10.58	-12.62	4.00	-3.60	-9.34
105.00	110.00	-22.49	-11.61	-27.49	-13.74	4.00	105.00	110.00	-9.55	-6.21	-9.22	-11.38	4.00	-9.33	-5.11	-9.16	-9.39	4.00	-2.02	-7.82
105.00	120.00	-11.04	-11.60	-12.04	-11.00	4.00	105.00	120.00	-18.32	-7.41	-13.45	-11.29	4.00	-10.30	-12.01	-9.68	-7.01	4.00	-2.05	-7.90
105.00	130.00	-10.04	-18.36	-17.67	-4.08	4.00	105.00	130.00	-10.38	-19.84	-11.81	-13.72	4.00	-7.20	-16.03	-10.81	-3.63	4.00	-2.26	-7.38
105.00	140.00	-25.00	-17.42	-15.88	-1.38	4.00	105.00	140.00	-9.22	-11.06	-15.60	-17.27	4.00	-9.11	-10.16	-12.73	-11.27	4.00	-1.13	-5.94
105.00	150.00	-30.22	-3.69	-14.42	-1.54	4.00	105.00	150.00	-8.22	-9.50	-23.52	-17.59	4.00	-8.19	-2.68	-13.92	-1.43	4.00	0.72	-4.40
105.00	160.00	-22.94	-2.82	-17.77	-0.35	4.00	105.00	160.00	-9.09	-10.31	-12.55	-13.98	4.00	-8.91	-2.11	-7.25	-0.17	4.00	2.14	-3.24
105.00	170.00	-16.30	-11.84	-9.15	1.11	4.00	105.00	170.00	-7.40	-9.88	-10.58	-20.57	4.00	-6.87	-7.74	-6.80	1.14	4.00	1.80	-3.27
105.00	180.00	-12.73	-8.84	-6.23	2.09	4.00	105.00	180.00	-6.50	-21.42	-12.11	-11.44	4.00	-5.57	-8.61	-5.23	2.28	4.00	2.75	-2.21
105.00	190.00	-21.18	-6.42	-5.08	3.64	4.00	105.00	190.00	-3.00	-16.78	-12.11	-13.34	4.00	-2.93	-8.69	-4.29	3.73	4.00	4.15	-0.74
105.00	200.00	-11.22	-16.89	-4.37	3.32	4.00	105.00	200.00	-5.93	-15.91	-13.32	-15.26	4.00	-4.80	-13.36	-3.85	3.38	4.00	3.25	-1.30
105.00	210.00	-14.62	-11.57	-4.63	2.93	4.00	105.00	210.00	-11.92	-9.96	-9.95	-18.12	4.00	-10.05	-7.66	-3.51	2.96	4.00	2.93	-1.72
105.00	220.00	-17.76	-11.16	-3.77	1.45	4.00	105.00	220.00	-12.20	-15.58	-6.89	-13.92	4.00	-11.13	-9.82	-2.05	1.57	4.00	2.24	-2.51
105.00	230.00	-15.55	-18.58	-4.18	-0.53	4.00	105.00	230.00	-9.47	-12.55	-9.19	-16.26	4.00	-8.51	-11.58	-2.99	-0.42	4.00	1.22	-3.92
105.00	240.00	-14.87	-23.62	-3.71	-2.53	4.00	105.00	240.00	-8.62	-7.98	-8.66	-20.37	4.00	-7.70	-7.86	-2.50	-2.46	4.00	1.29	-4.37
105.00	250.00	-9.57	-19.41	-2.90	-1.44	4.00	105.00	250.00	-12.29	-8.11	-9.68	-20.44	4.00	-7.71	-7.80	-2.07	-8.17	4.00	1.47	-4.16
105.00	260.00	-9.17	-20.10	-2.21	0.26	4.00	105.00	260.00	-20.40	-7.84	-18.37	-19.89	4.00	-8.85	-7.59	-2.11	0.30	4.00	2.27	-3.03
105.00	270.00	-7.54	-17.93	-1.77	1.82	4.00	105.00	270.00	-16.45	-8.91	-13.24	-20.21	4.00	-7.01	-8.40	-1.47	1.85	4.00	3.25	-1.89
105.00	280.00	-8.40	-16.05	-1.58	2.98	4.00	105.00	280.00	-9.95	-9.83	-8.41	-23.76	4.00	-6.10	-8.90	-0.76	2.99	4.00	4.03	-0.96
105.00	290.00	-10.58	-15.64	-2.80	3.15	4.00	105.00	290.00	-6.84	-9.83	-4.24	-18.63	4.00	-5.31	-8.82	-0.45	3.18	4.00	4.34	-0.70
105.00	300.00	-18.24	-10.30	-2.89	3.48	4.00	105.00	300.00	-6.14	-14.16	-3.11	-14.97	4.00	-5.88	-8.80	0.01	3.54	4.00	4.55	-0.39
105.00	310.00	-15.52	-6.80	-4.03	1.34	4.00	105.00	310.00	-5.61	-9.65	-2.00	-21.89	4.00	-5.19	-4.98	0.11	3.36	4.00	4.34	-1.23
105.00	320.00	-13.28	-9.96	-4.17	-1.90	4.00	105.00	320.00	-5.00	-9.54	-1.09	-10.99	4.00	-4.40	-6.73	0.65	-1.40	4.00	3.50	-2.11
105.00	330.00	-15.74	-7.76	-7.41	-3.59	4.00	105.00	330.00	-5.66	-6.27	-1.68	-13.16	4.00	-5.25	-3.94	-0.65	-3.14	4.00	2.94	-2.91
105.00	340.00	-21.13	-5.80	-8.42	-2.41	4.00	105.00	340.00	-6.21	-5.08	-1.66	-15.48	4.00	-6.07	-2.41	-0.85	-2.20	4.00	3.34	-2.51
105.00	350.00	-11.69	-5.44	-10.05	1.36	4.00	105.00	350.00	-8.43	-7.50	-1.02	-15.63	4.00	-6.75	-3.45	-0.51	1.45	4.00	4.23	-1.33
120.00	0.00	-12.25	-2.62	-15.13	-1.24	4.00	120.00	0.00	-4.88	-19.06	-3.12	-10.78	4.00	-4.15	-2.52	-2.85	-0.78	4.00	3.53	-2.41
120.00	10.00	-9.00	-2.45	-22.37	-1.46	4.00	120.00	10.00	-4.39	-3.99	-4.05	-18.32	4.00	-3.10	-1.66	-3.99	-1.37	4.00	3.56	-2.40
120.00	20.00	-8.36	-4.94	-12.02	-2.04	4.00	120.00	20.00	-6.78	-5.19	-5.71	-25.17	4.00	-4.49	-0.97	-4.80	-3.02	4.00	3.10	-2.77
120.00	30.00	-10.18	-4.15	-11.75	-4.45	4.00	120.00	30.00	-8.66	-5.53	-8.31	-11.46	4.00	-6.34	-1.78	-6.69	-3.66	4.00	1.64	-4.14
120.00	40.00	-7.48	-8.68	-14.51	-9.89	4.00	120.00	40.00	-13.20	-6.07	-14.33	-6.58	4.00	-6.45	-4.17	-11.41	-4.92	4.00	-0.30	-6.00
120.00	50.00	-8.95	-4.36	-9.10	-9.86	4.00	120.00	50.00	-15.46	-6.06	-9.02	-7.41	4.00	-8.07	1.31	-15.46	-5.45	4.00	2.24	-2.92
120.00	60.00	-6.02	-12.28	-15.35	-14.11	4.00	120.00	60.00	-14.76	-4.73	-7.93	-14.08	4.00	-5.48	-4.03	-7.21	-11.09	4.00	-0.55	-6.26
120.00	70.00	-5.89	-4.84	-15.11	-38.86	4.00	120.00	70.00	-18.43	-1.63	-6.18	-16.18	4.00	-5.65	0.07	-5.66	-16.11	4.00	0.86	-4.02
120.00	80.00	-16.47	-10.83	-18.78	-18.16	4.00	120.00	80.00	-10.18	-0.20	-11.07	-19.04	4.00	-6.06	0.16	-10.16	-13.90	4.00	-0.63	-0.93
120.00	90.00	-12.32	-13.22	-26.34	-15.73	4.00	120.00	90.00	-5.28	-14.30	-7.66	-14.49	4.00	-4.50	-10.72	-7.60	-12.06	4.00	-2.19	-7.72
120.00	100.00	-8.88	-18.93	-29.16	-19.48	4.00	120.00	100.00	-8.76	-9.35	-8.89	-13.74	4.00	-5.81	-8.90	-8.85	-12.71	4.00	-2.71	-8.42
120.00	110.00	-13.28	-12.67	-18.08	-14.54	4.00	120.00	110.00	-20.95	-33.68	-7.97	-11.61	4.00	-12.59	-12.64	-7.57	-9.82	4.00	-4.37	-10.12
120.00	120.00	-8.30	-10.92	-11.72	-11.08	4.00	120.00	120.00	-9.86	-5.03	-8.66	-19.28	4.00	-6.00	-4.03	-6.92	-10.47	4.00	-0.54	-6.29
120.00	130.00	-7.69	-24.90	-11.50	-6.53	4.00	120.00	130.00	-10.42	-17.43	-20.74	-17.25	4.00	-5.83	-16.71	-11.01	-6.18	4.00	-2.92	-8.22
120.00	140.00	-10.86	-4.23	-12.51	-2.22	4.00	120.00	140.00	-11.56	-3.68	-17.19	-23.62	4.00	-8.19	-0.94	-11.24	-5.16	4.00	0.48	-4.76
120.00	150.00	-27.08	-2.71	-12.32	-3.79	4.00	120.00	150.00	-10.57	-7.56	-13.01	-19.70	4.00	-10.47	-1.48	-9.64	-3.68	4.00	0.53	-4.76
120.00	160.00	-17.23	-3.75	-7.09	-0.71	4.00	120.00	160.00	-8.15	-24.75	-29.51	-13.49	4.00	-7.64	-3.72	-7.07	-24.49	4.00	1.78	-3.75
120.00	170.00	-18.01	-4.34	-9.26	0.45	4.00	120.00	170.00	-9.77	-18.01	-16.97	-14.69	4.00	-9.16	-4.16	-8.58	0.58	4.00	1.62	-3.50
120.00	180.00	-12.37	-4.20	-11.01	1.77	4.00	120.00	180.00	-7.41	-18.01	-18.17	-10.91	4.00	-6.21	-3.98	-10.25	2.00	4.00	2.57	-2.37
120.00	190.00	-21.62	-16.03	-4.76	2.11	4.00	120.00	190.00	-8.68	-42.21	-15.85	-13.81	4.00	-8.46	-16.02	-4.43	2.22	4.00	1.68	-2.61
120.00	200.00	-8.28	-9.58	-4.43	2.68	4.00	120.00	200.00	-17.16	-7.06	-10.88	-16.08	4.00	-7.75	-5.13	-3.54	2.74	4.00	3.52	-1.56
120.00	210.00	-12.26	-17.31	-6.40	1.68	4.00	120.00	210.00	-15.57	-14.64	-10.45	-14.53	4.00	-10.60	-12.76	-4.96	1.78	4.00	1.28	-3.08
120.00	220.00	-15.76	-24.16	-3.59	0.26	4.00	120.00	220.00	-11.72	-18.04	-8.12	-15.75	4.00	-10.28	-17.09	-2.28	0.37	4.00	1.06	-3.48
120.00	230.00	-12.97	-22.56	-3.38	-1.68	4.00	120.00	230.00	-11.60	-8.58	-6.36	-17.12	4.00	-9.22	-8.41	-1.61	-1.56	4.00	1.56	-3.84
120.00	240.00	-13.66	-18.83	-3.82	-5.02	4.00	120.00	240.00	-14.09	-16.89	-6.64	-11.63	4.00	-10.86	-14.74	-1.99	-4.16	4.00	-0.52	-5.49
120.00	250.00	-13.23	-16.34	-4.63	-4.18	4.00	120.00	250.00	-9.83	-11.00	-6.67	-15.11	4.00	-8.20	-9.89	-2.52	-3.84	4.00	0.42	-5.13
120.00	260.00	-12.49	-18.76	-3.49	-0.63	4.00	120.00	260.00	-8.07	-8.16	-13.47	-16.23	4.00	-6.73	-7.80	-3.07	-0.51	4.00	1.98	-3.57
120.00	270.00	-11.56	-20.63	-1.61	1.58	4.00	120.00	270.00	-7.93	-6.58	-17.65	-20.98	4.00	-6.37	-6.41	-1.50	1.60	4.00	3.53	-1.85
120.00	280.00	-9.73	-21.12	-1.28	3.19	4.00	120.00	280.00	-9.05	-5.47	-11.87	-15.67	4.00	-6.37	-5.35	-0.92	3.25	4.00	4.54	-0.65
120.00	290.00	-12.01	-21.09	-1.02	3.81	4.00	120.00	290.00	-7.11	-4.26	-5.53	-12.23	4.00	-5.89	-4.17	0.30	3.92	4.00	5.41	-0.19
120.00	300.00	-10.81	-12.65	-1.03	3.29	4.00	120.00	300.00	-4.99	-8.59	-5.14	-11.10	4.00	-3.98	-7.15	0.39	3.45	4.00	5.12	0.19
120.00	310.00	-11.16	-10.40	-3.25	0.35	4.00	120.00	310.00	-6.43	-4.83	-2.87	-10.07	4.00	-5.12	-0.87	-0.05	0.40	4.00	4.23	-1.52
120.00	320.00	-11.92	-5.45	-6.57	3.77	4.00	120.00	320.00	-6.14	-2.43	-3.36	-13.60	4.00	-3.82	-0.67	-0.12	-4.14	4.00	3.84	-3.87
120.00	330.00	-10.24	-3.03	-7.03	-7.14	4.00	120.00	330.00	-5.90	-6.53	-2.29	-15.59	4.00							



165.00	10.00	-15.98	-12.27	-17.00	-11.38	4.00		165.00	10.00	-8.82	-6.73	-7.69	-11.46	4.00		-8.06	-5.66	-7.21	-8.41	4.00	-1.25	-7.20
165.00	20.00	-16.79	-6.92	-21.81	-18.07	4.00		165.00	20.00	-10.37	-9.14	-11.55	-11.86	4.00		-9.48	-4.88	-11.16	-10.93	4.00	-2.69	-8.27
165.00	30.00	-21.33	-3.54	-16.66	-17.08	4.00		165.00	30.00	-12.90	-12.15	-8.73	-11.03	4.00		-12.32	-2.98	-8.08	-10.07	4.00	-1.62	-6.90
165.00	40.00	-18.90	-6.21	-10.63	-16.33	4.00		165.00	40.00	-16.94	-9.88	-7.48	-9.05	4.00		-14.80	-4.66	-5.77	-8.31	4.00	-1.59	-7.05
165.00	50.00	-16.72	-14.77	-8.57	-19.97	4.00		165.00	50.00	-24.86	-9.50	-8.16	-10.41	4.00		-16.10	-8.37	-5.35	-9.95	4.00	-3.12	-8.52
165.00	60.00	-14.74	-18.43	-8.44	-23.97	4.00		165.00	60.00	-34.01	-7.68	-13.11	-12.02	4.00		-14.69	-7.33	-7.17	-11.75	4.00	-3.67	-9.23
165.00	70.00	-18.73	-13.03	-10.24	-27.66	4.00		165.00	70.00	-24.86	-6.51	-18.76	-16.71	4.00		-17.78	-5.64	-9.67	-16.37	4.00	-4.94	-9.78
165.00	80.00	-17.17	-13.28	-14.58	-26.48	4.00		165.00	80.00	-22.74	-5.34	-23.88	-17.61	4.00		-16.11	-4.69	-14.10	-17.08	4.00	-5.38	-9.76
165.00	90.00	-17.13	-9.81	-20.47	-22.42	4.00		165.00	90.00	-26.70	-4.61	-33.08	-20.58	4.00		-16.68	-3.46	-20.24	-18.39	4.00	-5.72	-9.07
165.00	100.00	-17.50	-7.68	-26.39	-18.00	4.00		165.00	100.00	-24.62	-5.73	-27.22	-20.81	4.00		-16.73	-3.59	-23.77	-16.17	4.00	-5.78	-9.14
165.00	110.00	-15.27	-5.58	-19.96	-13.91	4.00		165.00	110.00	-34.53	-6.79	-17.41	-20.54	4.00		-15.22	-3.13	-15.45	-13.06	4.00	-4.00	-8.28
165.00	120.00	-15.09	-6.57	-16.73	-12.93	4.00		165.00	120.00	-25.11	-7.92	-13.11	-27.64	4.00		-14.68	-3.78	-11.54	-12.79	4.00	-3.57	-8.42
165.00	130.00	-12.85	-7.35	-17.14	-14.36	4.00		165.00	130.00	-20.91	-7.36	-10.04	-41.55	4.00		-12.22	-4.34	-9.27	-14.35	4.00	-3.18	-8.37
165.00	140.00	-11.55	-8.25	-12.05	-15.35	4.00		165.00	140.00	-19.62	-8.60	-9.92	-31.09	4.00		-10.92	-5.41	-7.85	-15.24	4.00	-3.10	-8.52
165.00	150.00	-14.15	-8.53	-14.82	-20.51	4.00		165.00	150.00	-18.43	-9.17	-8.95	-14.43	4.00		-12.77	-5.83	-7.95	-13.47	4.00	-3.39	-8.87
165.00	160.00	-17.79	-6.14	-11.32	-23.02	4.00		165.00	160.00	-13.02	-7.46	-10.17	-16.38	4.00		-11.77	-3.74	-7.70	-15.53	4.00	-2.57	-7.65
165.00	170.00	-16.10	-5.31	-8.92	-24.43	4.00		165.00	170.00	-11.10	-10.10	-10.86	-13.50	4.00		-9.91	-4.07	-6.77	-13.16	4.00	-1.81	-7.25
165.00	180.00	-14.21	-6.06	-9.50	-18.24	4.00		165.00	180.00	-12.83	-17.47	-13.56	-12.62	4.00		-10.46	-5.76	-8.06	-11.57	4.00	-2.65	-8.37
165.00	190.00	-9.20	-8.10	-12.58	-21.33	4.00		165.00	190.00	-38.06	-21.82	-17.93	-11.48	4.00		-9.19	-7.92	-11.47	-11.05	4.00	-3.77	-9.67
165.00	200.00	-10.82	-8.34	-11.77	-22.67	4.00		165.00	200.00	-21.94	-10.45	-18.86	-13.77	4.00		-10.50	-6.26	-10.99	-13.24	4.00	-3.84	-9.46
165.00	210.00	-11.31	-10.33	-12.04	-22.96	4.00		165.00	210.00	-14.88	-5.19	-16.66	-17.87	4.00		-9.73	-4.03	-10.75	-16.70	4.00	-3.15	-8.19
165.00	220.00	-8.57	-13.74	-13.12	-15.00	4.00		165.00	220.00	-15.83	-2.75	-14.58	-16.16	4.00		-7.82	-2.42	-10.78	-12.53	4.00	-1.47	-6.59
165.00	230.00	-8.65	-15.28	-22.04	-14.37	4.00		165.00	230.00	-18.23	-1.34	-12.84	-17.60	4.00		-8.20	-1.17	-12.35	-12.68	4.00	-1.22	-5.90
165.00	240.00	-8.68	-22.74	-20.82	-20.81	4.00		165.00	240.00	-13.10	-1.00	-10.51	-14.24	4.00		-7.34	-0.97	-10.12	-13.38	4.00	-0.68	-5.50
165.00	250.00	-15.90	-20.55	-22.47	-16.88	4.00		165.00	250.00	-11.89	-2.12	-9.42	-11.26	4.00		-10.44	-2.06	-9.21	-10.21	4.00	-1.19	-6.34
165.00	260.00	-17.32	-14.32	-24.06	-17.15	4.00		165.00	260.00	-10.43	-3.20	-8.20	-12.06	4.00		-9.62	-2.88	-8.09	-10.89	4.00	-1.27	-6.67
165.00	270.00	-15.56	-12.76	-29.21	-13.27	4.00		165.00	270.00	-8.08	-6.19	-7.70	-7.79	4.00		-7.37	-5.33	-7.67	-6.71	4.00	-0.70	-6.67
165.00	280.00	-10.69	-10.85	-27.84	-13.08	4.00		165.00	280.00	-7.34	-12.03	-7.12	-6.24	4.00		-5.69	-8.39	-7.08	-5.42	4.00	-0.55	-6.49
165.00	290.00	-8.34	-13.13	-25.02	-9.24	4.00		165.00	290.00	-7.51	-14.74	-5.70	-6.59	4.00		-4.89	-11.76	-5.65	-4.71	4.00	-0.31	-6.01
165.00	300.00	-7.07	-10.14	-29.96	-9.45	4.00		165.00	300.00	-7.24	-17.42	-5.50	-6.90	4.00		-4.14	-8.84	-5.48	-4.98	4.00	0.33	-5.54
165.00	310.00	-6.79	-6.01	-21.09	-7.39	4.00		165.00	310.00	-6.61	-19.04	-5.38	-8.22	4.00		-3.69	-5.80	-5.26	-4.77	4.00	1.17	-4.81
165.00	320.00	-8.42	-2.29	-13.46	-5.81	4.00		165.00	320.00	-8.72	-12.88	-7.46	-7.07	4.00		-5.56	-3.93	-6.49	-3.38	4.00	1.87	-3.97
165.00	330.00	-9.58	-0.99	-12.68	-4.92	4.00		165.00	330.00	-8.29	-15.85	-7.18	-9.97	4.00		-5.88	-0.85	-6.10	-3.74	4.00	2.15	-3.59
165.00	340.00	-13.89	0.63	-11.63	-5.99	4.00		165.00	340.00	-9.07	-13.38	-6.89	-12.40	4.00		-7.83	0.80	-5.63	-5.10	4.00	2.22	-3.12
165.00	350.00	-18.01	0.37	-12.28	-7.71	4.00		165.00	350.00	-9.15	-13.62	-6.52	-10.03	4.00		-8.62	0.54	-5.50	-5.71	4.00	1.88	-3.42
180.00	0.00	-13.85	-5.93	-12.22	-7.60	4.00		180.00	0.00	-14.61	-20.54	-14.08	-13.90	4.00		-11.20	-5.78	-10.04	-6.67	4.00	-2.11	-7.86
180.00	10.00	-12.68	-5.78	-11.19	-7.01	4.00		180.00	10.00	-16.60	-45.78	-16.36	-17.81	4.00		-11.20	-5.78	-10.04	-6.66	4.00	-2.11	-7.86
180.00	20.00	-11.89	-5.90	-10.52	-6.71	4.00		180.00	20.00	-19.55	-21.46	-19.83	-26.16	4.00		-11.20	-5.78	-10.04	-6.66	4.00	-2.11	-7.86
180.00	30.00	-11.41	-6.29	-10.15	-6.68	4.00		180.00	30.00	-24.51	-15.33	-26.25	-29.97	4.00		-11.20	-5.78	-10.04	-6.66	4.00	-2.11	-7.86
180.00	40.00	-11.21	-6.99	-10.04	-6.92	4.00		180.00	40.00	-38.45	-11.94	-44.33	-19.04	4.00		-11.20	-5.78	-10.04	-6.66	4.00	-2.11	-7.86
180.00	50.00	-11.28	-8.03	-10.20	-7.44	4.00		180.00	50.00	-28.88	-9.72	-24.35	-14.50	4.00		-11.20	-5.78	-10.04	-6.66	4.00	-2.11	-7.86
180.00	60.00	-11.62	-9.53	-10.64	-8.28	4.00		180.00	60.00	-21.64	-8.17	-18.91	-11.73	4.00		-11.20	-5.78	-10.04	-6.66	4.00	-2.11	-7.86
180.00	70.00	-12.25	-11.66	-11.39	-9.51	4.00		180.00	70.00	-17.91	-7.08	-15.78	-9.84	4.00		-11.20	-5.78	-10.04	-6.66	4.00	-2.11	-7.86
180.00	80.00	-13.22	-14.88	-12.50	-11.26	4.00		180.00	80.00	-15.51	-6.35	-13.68	-8.51	4.00		-11.20	-5.78	-10.04	-6.66	4.00	-2.11	-7.86
180.00	90.00	-14.61	-20.54	-14.08	-13.80	4.00		180.00	90.00	-13.85	-5.93	-12.22	-7.60	4.00		-11.20	-5.78	-10.04	-6.67	4.00	-2.11	-7.86
180.00	100.00	-16.60	-45.78	-16.36	-17.81	4.00		180.00	100.00	-12.68	-5.78	-11.19	-7.01	4.00		-11.20	-5.78	-10.04	-6.66	4.00	-2.11	-7.86
180.00	110.00	-19.55	-21.46	-19.83	-26.16	4.00		180.00	110.00	-11.89	-5.90	-10.52	-6.71	4.00		-11.20	-5.78	-10.04	-6.66	4.00	-2.11	-7.86
180.00	120.00	-24.51	-15.33	-26.25	-29.97	4.00		180.00	120.00	-11.41	-6.29	-10.15	-6.68	4.00		-11.20	-5.78	-10.04	-6.66	4.00	-2.11	-7.86
180.00	130.00	-38.45	-11.94	-44.33	-19.04	4.00		180.00	130.00	-11.21	-6.99	-10.04	-6.92	4.00		-11.20	-5.78	-10.04	-6.66	4.00	-2.11	-7.86
180.00	140.00	-28.88	-9.72	-24.35	-14.50	4.00		180.00	140.00	-11.28	-8.03	-10.20	-7.44	4.00		-11.21	-5.78	-10.04	-6.66	4.00	-2.11	-7.86
180.00	150.00	-21.64	-8.17	-18.91	-11.73	4.00		180.00	150.00	-11.62	-9.53	-10.64	-8.28	4.00		-11.21	-5.79	-10.04	-6.66	4.00	-2.11	-7.86
180.00	160.00	-17.91	-7.08	-15.78	-9.84	4.00		180.00	160.00	-12.25	-11.66	-11.39	-9.51	4.00		-11.21	-5.78	-10.04	-6.66	4.00	-2.11	-7.86
180.00	170.00	-15.51	-6.35	-13.68	-8.51	4.00		180.00	170.00	-13.22	-14.88	-12.50	-11.26	4.00		-11.21	-5.78	-10.04	-6.66	4.00	-2.11	-7.86
180.00	180.00	-13.85	-5.93	-12.22	-7.60	4.00		180.00	180.00	-14.61	-20.54	-14.08	-13.80	4.00		-11.20	-5.78	-10.04	-6.66	4.00	-2.11	-7.86
180.00	190.00	-12.68	-5.78	-11.19	-7.01	4.00		180.00	190.00	-16.60	-45.78	-16.36	-17.81	4.00		-11.20	-5.78	-10.04	-6.66	4.00	-2.11	-7.86
180.00	200.00	-11.89	-5.90	-10.52	-6.71	4.00		180.00	200.00	-19.55	-21.46	-19.83	-26.16	4.00		-11.20	-5.78	-10.04	-6.66	4.00	-2.11	-7.86
180.00	210.00	-11.41	-6.29	-10.15	-6.68	4.00		180.00	210.00	-24.51	-15.33	-26.25	-29.97	4.00		-11.20	-5.78	-10.04	-6.66	4.00	-2.11	-7.86
180.00	220.00	-11.21	-6.9																			



Frequency: 6695MHz

Theta Polarization		Max Gain(dBi)				Nant	Phi Polarization		Max Gain(dBi)				Nant	Total				Max DG(dBi)	Max Dg(dBi)							
Angle (θ)	Angle (ψ)	Ant 1(G1)	Ant 2(G2)	Ant 3(G3)	Ant 4(G4)		Angle (θ)	Angle (ψ)	Ant 1(G1)	Ant 2(G2)	Ant 3(G3)	Ant 4(G4)		Ant 1(G1)	Ant 2(G2)	Ant 3(G3)	Ant 4(G4)			Nant	g1K	g1SAT				
		2.27	2.58	1.89	3.84				3.14	4.23	2.19	-3.78											3.89	5.05	3.40	3.96
		Ant 1(G1)	Ant 2(G2)	Ant 3(G3)	Ant 4(G4)				Ant 1(G1)	Ant 2(G2)	Ant 3(G3)	Ant 4(G4)											Ant 1(G1)	Ant 2(G2)	Ant 3(G3)	Ant 4(G4)
0.00	0.00	-14.82	-0.78	-15.18	-16.43	4.00	0.00	0.00	2.04	-11.30	-0.72	-15.44	4.00	2.13	-0.41	-0.57	-12.90	4.00	4.60	-0.62						
0.00	10.00	-7.99	-0.47	-9.60	-15.00	4.00	0.00	10.00	1.69	-19.22	-1.15	-17.06	4.00	2.13	-0.41	-0.57	-12.90	4.00	4.60	-0.61						
0.00	20.00	-4.39	-0.43	-6.41	-14.00	4.00	0.00	20.00	1.04	-24.92	-1.88	-19.40	4.00	2.13	-0.41	-0.57	-12.90	4.00	4.60	-0.61						
0.00	30.00	-2.05	-0.65	-4.28	-13.35	4.00	0.00	30.00	0.04	-13.10	-2.98	-22.99	4.00	2.13	-0.41	-0.57	-12.90	4.00	4.60	-0.62						
0.00	40.00	-0.42	-1.16	-2.80	-12.99	4.00	0.00	40.00	-1.39	-8.43	-4.54	-29.77	4.00	2.13	-0.41	-0.57	-12.90	4.00	4.59	-0.62						
0.00	50.00	0.72	-1.98	-1.76	-12.90	4.00	0.00	50.00	-3.43	-5.59	-6.78	-43.16	4.00	2.13	-0.41	-0.57	-12.90	4.00	4.60	-0.61						
0.00	60.00	1.49	-3.19	-1.07	-13.08	4.00	0.00	60.00	-6.46	-3.67	-10.19	-26.71	4.00	2.14	-0.41	-0.57	-12.90	4.00	4.60	-0.61						
0.00	70.00	1.95	-4.90	-0.69	-13.54	4.00	0.00	70.00	-11.63	-2.32	-16.42	-21.52	4.00	2.14	-0.41	-0.58	-12.90	4.00	4.60	-0.61						
0.00	80.00	2.13	-7.39	-0.57	-14.31	4.00	0.00	80.00	-27.78	-1.38	-38.65	-18.47	4.00	2.13	-0.41	-0.57	-12.90	4.00	4.60	-0.61						
0.00	90.00	2.04	-11.30	-0.72	-15.44	4.00	0.00	90.00	-14.82	-0.78	-15.18	-16.43	4.00	2.13	-0.41	-0.57	-12.90	4.00	4.60	-0.62						
0.00	100.00	1.69	-19.22	-1.15	-17.06	4.00	0.00	100.00	-7.99	-0.47	-9.60	-15.00	4.00	2.13	-0.41	-0.57	-12.90	4.00	4.60	-0.61						
0.00	110.00	1.04	-24.92	-1.88	-19.40	4.00	0.00	110.00	-4.39	-0.43	-6.41	-14.00	4.00	2.13	-0.41	-0.57	-12.90	4.00	4.60	-0.61						
0.00	120.00	0.04	-13.10	-2.98	-22.99	4.00	0.00	120.00	-2.05	-0.65	-4.28	-13.35	4.00	2.13	-0.41	-0.57	-12.90	4.00	4.60	-0.62						
0.00	130.00	-1.39	-8.43	-4.54	-29.77	4.00	0.00	130.00	-0.42	-1.16	-2.80	-12.99	4.00	2.13	-0.41	-0.57	-12.90	4.00	4.59	-0.62						
0.00	140.00	-3.43	-5.59	-6.78	-43.16	4.00	0.00	140.00	0.72	-1.98	-1.76	-12.90	4.00	2.13	-0.41	-0.57	-12.90	4.00	4.60	-0.61						
0.00	150.00	-6.46	-3.67	-10.19	-26.71	4.00	0.00	150.00	1.49	-3.19	-1.07	-13.08	4.00	2.14	-0.41	-0.57	-12.90	4.00	4.60	-0.61						
0.00	160.00	-11.63	-2.32	-16.42	-21.52	4.00	0.00	160.00	1.95	-4.90	-0.69	-13.54	4.00	2.14	-0.41	-0.58	-12.90	4.00	4.60	-0.61						
0.00	170.00	-27.78	-1.38	-38.65	-18.47	4.00	0.00	170.00	2.13	-7.39	-0.57	-17.39	4.00	2.13	-0.41	-0.57	-12.90	4.00	4.60	-0.61						
0.00	180.00	-14.82	-0.78	-15.18	-16.43	4.00	0.00	180.00	2.04	-11.30	-0.72	-15.44	4.00	2.13	-0.41	-0.57	-12.90	4.00	4.60	-0.62						
0.00	190.00	-7.99	-0.47	-9.60	-15.00	4.00	0.00	190.00	1.69	-19.22	-1.15	-17.06	4.00	2.13	-0.41	-0.57	-12.90	4.00	4.60	-0.61						
0.00	200.00	-4.39	-0.43	-6.41	-14.00	4.00	0.00	200.00	1.04	-24.92	-1.88	-19.40	4.00	2.13	-0.41	-0.57	-12.90	4.00	4.60	-0.61						
0.00	210.00	-2.05	-0.65	-4.28	-13.35	4.00	0.00	210.00	0.04	-13.10	-2.98	-22.99	4.00	2.13	-0.41	-0.57	-12.90	4.00	4.60	-0.62						
0.00	220.00	-0.42	-1.16	-2.80	-12.99	4.00	0.00	220.00	-1.39	-8.43	-4.54	-29.77	4.00	2.13	-0.41	-0.57	-12.90	4.00	4.59	-0.62						
0.00	230.00	0.72	-1.98	-1.76	-12.90	4.00	0.00	230.00	-3.43	-5.59	-6.78	-43.16	4.00	2.13	-0.41	-0.57	-12.90	4.00	4.60	-0.61						
0.00	240.00	1.49	-3.19	-1.07	-13.08	4.00	0.00	240.00	-6.46	-3.67	-10.19	-26.71	4.00	2.14	-0.41	-0.57	-12.90	4.00	4.60	-0.61						
0.00	250.00	1.95	-4.90	-0.69	-13.54	4.00	0.00	250.00	-11.63	-2.32	-16.42	-21.52	4.00	2.14	-0.41	-0.58	-12.90	4.00	4.60	-0.61						
0.00	260.00	2.13	-7.39	-0.57	-14.31	4.00	0.00	260.00	-27.78	-1.38	-38.65	-18.47	4.00	2.13	-0.41	-0.57	-12.90	4.00	4.60	-0.61						
0.00	270.00	2.04	-11.30	-0.72	-15.44	4.00	0.00	270.00	-14.82	-0.78	-15.18	-16.43	4.00	2.13	-0.41	-0.57	-12.90	4.00	4.60	-0.62						
0.00	280.00	1.69	-19.22	-1.15	-17.06	4.00	0.00	280.00	-7.99	-0.47	-9.60	-15.00	4.00	2.13	-0.41	-0.57	-12.90	4.00	4.60	-0.61						
0.00	290.00	1.04	-24.92	-1.88	-19.40	4.00	0.00	290.00	-4.39	-0.43	-6.41	-14.00	4.00	2.13	-0.41	-0.57	-12.90	4.00	4.60	-0.61						
0.00	300.00	0.04	-13.10	-2.98	-22.99	4.00	0.00	300.00	-2.05	-0.65	-4.28	-13.35	4.00	2.13	-0.41	-0.57	-12.90	4.00	4.60	-0.62						
0.00	310.00	-1.39	-8.43	-4.54	-29.77	4.00	0.00	310.00	-0.42	-1.16	-2.80	-12.99	4.00	2.13	-0.41	-0.57	-12.90	4.00	4.59	-0.62						
0.00	320.00	-3.43	-5.59	-6.78	-43.16	4.00	0.00	320.00	0.72	-1.98	-1.76	-12.90	4.00	2.13	-0.41	-0.57	-12.90	4.00	4.60	-0.61						
0.00	330.00	-6.46	-3.67	-10.19	-26.71	4.00	0.00	330.00	1.49	-3.19	-1.07	-13.08	4.00	2.14	-0.41	-0.57	-12.90	4.00	4.60	-0.61						
0.00	340.00	-11.63	-2.32	-16.42	-21.52	4.00	0.00	340.00	1.95	-4.90	-0.69	-13.54	4.00	2.14	-0.41	-0.58	-12.90	4.00	4.60	-0.61						
0.00	350.00	-27.78	-1.38	-38.65	-18.47	4.00	0.00	350.00	2.13	-7.39	-0.57	-17.39	4.00	2.13	-0.41	-0.57	-12.90	4.00	4.60	-0.61						
15.00	0.00	-19.32	-3.48	-3.61	-11.28	4.00	15.00	0.00	-0.84	-17.18	-3.11	-14.31	4.00	-0.78	-3.30	-0.34	-6.61	4.00	3.60	-2.14						
15.00	10.00	-9.57	-3.15	-2.07	-11.11	4.00	15.00	10.00	-1.02	-28.86	-3.02	-7.84	4.00	-0.45	-3.14	0.49	-6.16	4.00	4.07	-1.63						
15.00	20.00	-6.84	-3.48	-1.16	-13.15	4.00	15.00	20.00	-3.87	-20.60	-5.72	-8.64	4.00	-2.10	-3.40	0.14	-7.32	4.00	3.25	-2.42						
15.00	30.00	-5.65	-3.70	-1.76	-15.12	4.00	15.00	30.00	-4.15	-13.10	-7.26	-10.00	4.00	-1.83	-3.23	-0.68	-8.84	4.00	2.88	-2.76						
15.00	40.00	-4.16	-5.01	-1.75	-13.76	4.00	15.00	40.00	-5.11	-10.97	-9.62	-11.10	4.00	-1.60	-3.13	-1.09	-9.22	4.00	2.79	-2.85						
15.00	50.00	-3.63	-8.17	-1.35	-14.39	4.00	15.00	50.00	-5.86	-7.77	-11.71	-17.22	4.00	-1.59	-4.96	-0.97	-12.57	4.00	2.03	-3.31						
15.00	60.00	-3.57	-11.62	-0.80	-12.73	4.00	15.00	60.00	-8.99	-8.14	-17.62	-17.04	4.00	-2.47	-6.53	-0.71	-11.36	4.00	1.64	-3.69						
15.00	70.00	-3.36	-12.15	-1.84	-11.72	4.00	15.00	70.00	-11.59	-8.93	-30.44	-20.53	4.00	-2.75	-7.24	-1.83	-11.18	4.00	1.02	-4.40						
15.00	80.00	-3.01	-15.87	-1.50	-12.54	4.00	15.00	80.00	-15.44	-7.60	-19.27	-19.03	4.00	-2.77	-8.00	-1.43	-11.66	4.00	1.15	-4.21						
15.00	90.00	-3.79	-11.68	-0.85	-11.74	4.00	15.00	90.00	-25.22	-6.62	-24.67	-14.28	4.00	-3.76	-5.44	-0.83	-9.82	4.00	1.64	-3.88						
15.00	100.00	-3.66	-13.58	-1.05	-9.13	4.00	15.00	100.00	-20.88	-6.44	-16.47	-11.63	4.00	-3.58	-4.82	-0.83	-7.19	4.00	2.19	-3.55						
15.00	110.00	-3.52	-13.10	-0.80	-8.95	4.00	15.00	110.00	-13.47	-4.28	-11.88	-9.31	4.00	-3.10	-3.74	-0.47	-6.19	4.00	2.82	-2.95						
15.00	120.00	-3.64	-22.06	0.34	-7.13	4.00	15.00	120.00	-0.79	-1.79	-9.03	-8.48	4.00	-2.02	-1.75	0.21	-5.58	4.00	3.98	-1.83						
15.00	130.00	-4.69	-12.98	0.71	-7.13	4.00	15.00	130.00	-3.64	0.02	-5.66	-7.54	4.00	-1.12	0.23	0.50	-4.32	4.00	5.04	-0.81						
15.00	140.00	-6.76	-5.52	-1.07	-5.71	4.00	15.00	140.00	-1.38	0.17	-2.92	-8.83	4.00	-0.27	1.21	1.11	-3.99	4.00	5.77	-0.05						
15.00	150.00	-9.80	-3.02	-1.74	-4.52	4.00	15.00	150.00	0.17	-0.86	-0.98	-11.05	4.00	0.59	1.20	1.67	-3.65	4.00	6.21	0.38						
15.00	160.00	-12.98	-1.93	-2.20	-4.81	4.00	15.00	160.00	1.19	-3.70	0.53	-12.66	4.00	1.35	0.28	2.39	-4.15	4.00	6.32	0.56						
15.00	170.00	-25.72	-2.32	-4.89	-4.13	4.00	15.00	170.00	2.52	-8.72	1.49	-21.43	4.00	2.53	-1.42	2.39	-4.05	4.00	6.30	0.64						
15.00	180.00	-17.40	-1.28	-7.93	-4.68	4.00	15.00	180.00	3.09	-13.75	1.42	-26.17	4.00	3.13	-1.04	1.90	-4.65	4.00	6.34	0.73						
15.00	190.00	-8.40	0.01	-14.01	-4.98	4.00	15.00	190.00	3.14	-24.23	2.15	-22.78	4.00	3.43	0.03	3.14	-2.25	-4.89	4.00	6.76	1.15					
15.00	200.00	-4.05	-0.58	-46.52	-6.07	4.00	15.00	200.00	2.23	-10.97	0.90	-18.18	4.00	3.15	-0.20	0.90	-5.81	4.00	6.10	0.52						
15.00	210.00	-1.40	-0.59	-12.20	-5.64	4.00	15.00	210.00	1.83	-4.37	0.69	-15.27	4.00	3.												



45.00	190.00	-9.59	-3.97	-2.48	-5.10	4.00	45.00	190.00	1.37	-19.92	0.79	-15.12	4.00	1.70	-3.86	2.47	-4.69	4.00	5.50	0.00	
45.00	200.00	-6.64	-2.95	-3.58	-5.73	4.00	45.00	200.00	1.97	-7.19	1.35	-20.33	4.00	2.53	-1.56	2.56	-5.58	4.00	6.11	0.58	
45.00	210.00	-3.30	-1.11	-7.11	-5.43	4.00	45.00	210.00	1.21	-3.34	-0.45	-18.08	4.00	2.97	-0.78	1.18	-6.25	4.00	5.92	0.38	
45.00	220.00	-1.33	-4.55	-7.90	-6.86	4.00	45.00	220.00	0.95	-3.15	0.61	-15.10	4.00	2.34	-1.01	-0.12	-5.27	4.00	5.41	-0.25	
45.00	230.00	-0.77	-5.69	-10.59	-5.69	4.00	45.00	230.00	-0.58	-2.82	-0.53	-15.59	4.00	1.35	0.00	-1.79	-4.38	4.00	5.07	-0.72	
45.00	240.00	-1.20	-6.25	-14.95	-4.44	4.00	45.00	240.00	-2.18	-1.18	-2.01	-23.26	4.00	0.60	1.17	-4.40	0.34	4.00	4.67	-0.98	
45.00	250.00	-0.50	-11.66	-13.61	-4.40	4.00	45.00	250.00	-5.92	0.94	-4.95	-22.98	4.00	-0.03	2.21	-8.66	-2.05	4.00	4.72	-0.69	
45.00	260.00	-0.31	-10.02	-14.94	-2.18	4.00	45.00	260.00	-12.09	1.94	-9.83	-17.49	4.00	0.11	3.05	-15.66	-2.02	4.00	4.56	-0.35	
45.00	270.00	0.01	-6.73	-17.19	-2.41	4.00	45.00	270.00	-16.20	-2.57	-20.95	-14.04	4.00	0.05	4.41	-10.46	-2.74	4.00	5.42	0.48	
45.00	280.00	0.06	-3.91	-14.46	-2.95	4.00	45.00	280.00	-11.50	3.72	-12.66	-15.97	4.00	0.08	4.36	-4.28	-6.42	4.00	5.84	1.04	
45.00	290.00	0.06	-5.02	-11.72	-5.49	4.00	45.00	290.00	-6.22	3.48	-5.14	-23.53	4.00	1.03	4.26	-3.28	-5.52	4.00	6.54	1.06	
45.00	300.00	-0.72	-6.17	-8.78	4.00	4.00	45.00	300.00	-3.37	3.73	-1.63	-17.93	4.00	0.98	3.06	0.38	-3.92	4.00	6.49	0.77	
45.00	310.00	-1.89	-5.77	-4.94	-2.53	4.00	45.00	310.00	-2.51	2.45	-1.13	-12.78	4.00	3.18	-1.96	-0.10	-1.91	4.00	6.09	0.35	
45.00	320.00	-1.37	-7.10	-5.03	-2.57	4.00	45.00	320.00	1.30	-3.55	-1.79	-10.45	4.00	3.73	0.86	1.54	-0.74	4.00	7.52	1.65	
45.00	330.00	-2.36	-1.95	-2.47	-1.01	4.00	45.00	330.00	2.51	-2.37	-0.66	-12.98	4.00	2.31	-0.51	1.88	-0.65	4.00	6.88	0.96	
45.00	340.00	-4.50	-2.09	-2.17	-0.76	4.00	45.00	340.00	1.30	-5.68	-0.29	-16.82	4.00	0.75	-4.86	2.22	-0.18	4.00	5.87	0.15	
45.00	350.00	-15.08	-5.31	-0.96	-0.33	4.00	45.00	350.00	0.63	-14.96	-0.63	-15.01	4.00	0.24	-1.19	2.42	-0.75	4.00	6.31	0.42	
60.00	0.00	-11.04	-1.84	-0.74	-0.88	4.00	60.00	0.00	-0.10	-9.73	-0.45	-16.21	4.00	-0.20	2.39	1.86	-2.55	4.00	6.61	0.78	
60.00	10.00	-9.07	0.69	-2.88	-2.91	4.00	60.00	10.00	-0.80	-2.50	0.09	-13.58	4.00	-0.20	3.59	2.18	-5.77	4.00	6.63	1.10	
60.00	20.00	-18.03	2.39	-0.86	-5.81	4.00	60.00	20.00	-0.27	-2.58	-0.80	-25.93	4.00	-0.29	3.19	0.32	-5.91	4.00	5.92	0.37	
60.00	30.00	-10.52	1.94	-4.14	-5.95	4.00	60.00	30.00	-0.72	-2.82	-1.61	-26.26	4.00	-2.80	2.80	-2.50	-8.94	4.00	4.12	-1.08	
60.00	40.00	-10.75	-1.47	-6.17	-9.99	4.00	60.00	40.00	-3.56	0.77	-4.94	-15.64	4.00	-5.28	1.52	-2.74	-8.44	4.00	3.06	-2.24	
60.00	50.00	-17.58	-4.31	-7.95	-11.55	4.00	60.00	50.00	-5.54	0.20	-4.29	-11.61	4.00	-14.10	-0.53	-4.77	-11.01	4.00	-0.02	-4.76	
60.00	60.00	-26.35	-2.19	-8.78	-13.50	4.00	60.00	60.00	-14.37	-5.52	-6.97	-14.46	4.00	-9.84	-3.20	-5.20	3.20	4.00	3.55	-1.29	
60.00	70.00	-19.55	-8.49	-9.38	-27.84	4.00	60.00	70.00	-10.33	-14.01	-12.91	-16.53	4.00	-11.43	-6.32	-6.10	-16.35	4.00	-3.10	-8.43	
60.00	80.00	-17.01	-13.80	-8.50	-18.60	4.00	60.00	80.00	-12.83	-7.17	-15.19	-20.29	4.00	-14.90	-5.89	-6.20	-12.07	4.00	-2.94	-8.30	
60.00	90.00	-15.46	-20.64	-9.60	-14.18	4.00	60.00	90.00	-24.09	-6.04	-8.49	-16.23	4.00	-13.89	-8.39	-6.98	-10.00	4.00	-3.43	-9.15	
60.00	100.00	-16.31	-24.38	-11.40	-10.78	4.00	60.00	100.00	-17.58	-8.50	-8.92	-17.84	4.00	-10.44	-2.27	-6.94	-12.69	4.00	-1.15	-6.29	
60.00	110.00	-14.90	-23.95	-12.18	-13.69	4.00	60.00	110.00	-12.36	-2.30	-8.48	-19.55	4.00	-5.87	-0.05	-6.25	-12.15	4.00	1.64	-3.59	
60.00	120.00	-16.43	-13.12	-5.25	-12.40	4.00	60.00	120.00	-6.27	-0.27	-8.23	-24.69	4.00	-6.69	-0.25	-1.33	-7.75	4.00	2.61	-2.88	
60.00	130.00	-22.38	-12.36	-4.23	-8.90	4.00	60.00	130.00	-6.81	-0.53	-4.45	-14.10	4.00	-6.75	-0.77	-0.30	-5.63	4.00	3.12	-2.49	
60.00	140.00	-18.55	-12.51	-2.88	-6.57	4.00	60.00	140.00	-7.05	-1.07	-3.78	-12.76	4.00	-3.78	-0.70	-0.45	-5.65	4.00	2.61	-3.16	
60.00	150.00	-13.46	-11.79	-5.42	-6.71	4.00	60.00	150.00	-4.27	-5.65	-2.11	-12.28	4.00	-1.44	-7.84	-1.37	-4.35	4.00	2.65	-3.06	
60.00	160.00	-15.91	-17.12	-3.58	-5.70	4.00	60.00	160.00	-1.60	-8.38	-5.36	-10.07	4.00	-0.10	-1.63	-3.23	-10.70	4.00	2.64	-2.52	
60.00	170.00	-13.18	-16.87	-4.27	-5.96	4.00	60.00	170.00	-0.33	-13.18	-4.71	-18.03	4.00	1.62	-8.68	1.08	-4.47	4.00	4.36	-0.93	
60.00	180.00	-12.61	-9.73	1.54	-4.71	4.00	60.00	180.00	1.45	-15.36	2.35	-17.09	4.00	1.49	6.27	1.20	-3.70	4.00	4.73	-0.75	
60.00	190.00	-7.28	-7.37	-2.88	-3.74	4.00	60.00	190.00	0.87	-15.28	-0.95	-24.35	4.00	1.29	-2.63	1.37	-4.06	4.00	5.34	-0.39	
60.00	200.00	-7.11	-4.37	-3.48	-4.30	4.00	60.00	200.00	0.61	-7.43	-0.35	-16.70	4.00	1.71	-2.14	1.49	-4.50	4.00	5.53	-0.16	
60.00	210.00	-4.18	-4.44	-4.93	-4.61	4.00	60.00	210.00	0.41	-5.99	0.37	-20.47	4.00	0.79	-4.93	1.75	-4.31	4.00	4.85	-0.72	
60.00	220.00	-5.38	-9.02	-5.59	-4.61	4.00	60.00	220.00	-0.41	-7.08	0.87	-16.11	4.00	-0.12	-2.49	0.68	-3.47	4.00	4.45	-1.29	
60.00	230.00	-5.54	-9.39	-5.59	-5.82	4.00	60.00	230.00	-1.59	-3.48	-0.49	-21.24	4.00	-0.55	-2.65	-0.96	-3.54	4.00	4.38	-1.76	
60.00	240.00	-3.27	-11.86	-9.23	-3.73	4.00	60.00	240.00	-3.87	-3.20	-1.66	-17.31	4.00	-0.58	-1.74	-3.33	-2.64	4.00	3.74	-2.18	
60.00	250.00	-2.59	-9.01	-10.68	-3.88	4.00	60.00	250.00	-4.90	-0.60	-4.21	-26.95	4.00	-1.55	0.39	-6.16	-2.98	4.00	3.76	-1.97	
60.00	260.00	-2.72	-6.53	-11.56	-2.99	4.00	60.00	260.00	-7.80	-0.60	-7.64	-31.13	4.00	-2.40	-0.23	-8.09	-1.26	4.00	3.11	-2.56	
60.00	270.00	-2.44	-7.22	-9.58	-2.70	4.00	60.00	270.00	-23.15	-1.20	-13.47	-24.58	4.00	-2.61	-0.52	-4.70	-2.34	4.00	3.61	-2.29	
60.00	280.00	-3.25	-13.32	-8.05	-2.35	4.00	60.00	280.00	-11.21	-0.75	-7.39	-27.08	4.00	-2.12	1.08	-2.44	-1.82	4.00	4.82	-1.07	
60.00	290.00	-4.06	-30.79	-8.03	-1.86	4.00	60.00	290.00	-6.54	1.08	-3.84	-22.17	4.00	-1.86	2.37	-0.79	-1.13	4.00	5.82	-0.02	
60.00	300.00	-3.91	-6.75	-6.82	-1.30	4.00	60.00	300.00	-6.11	1.80	-2.04	-15.40	4.00	-0.44	3.06	-0.37	2.13	4.00	6.48	0.64	
60.00	310.00	-4.74	-4.10	-5.02	-1.48	4.00	60.00	310.00	-2.46	0.33	-0.91	-12.15	4.00	1.32	1.14	1.19	-2.68	4.00	6.41	0.52	
60.00	320.00	-5.82	-6.55	-2.98	-3.20	4.00	60.00	320.00	0.39	0.33	-0.91	-12.15	4.00	2.47	-2.02	0.83	-2.08	4.00	6.04	0.24	
60.00	330.00	-9.16	-9.74	-3.43	-2.32	4.00	60.00	330.00	2.16	-1.21	-1.21	-14.77	4.00	0.46	-1.33	2.67	1.35	4.00	6.93	1.02	
60.00	340.00	-8.25	-4.40	-1.36	0.97	4.00	60.00	340.00	-0.17	-4.29	0.49	-9.46	4.00	1.46	-2.83	0.89	-4.23	1.39	4.00	6.85	1.01
60.00	350.00	-7.67	-3.29	-2.66	1.15	4.00	60.00	350.00	0.89	-12.80	0.82	-11.34	4.00	1.39	-3.97	-0.95	3.04	4.00	6.28	0.60	
75.00	0.00	-10.00	-4.24	-5.27	3.03	4.00	75.00	0.00	1.06	-16.13	-2.95	-24.45	4.00	1.14	-1.52	0.60	-10.42	0.55	4.00	5.90	-0.06
75.00	10.00	-8.20	-2.12	-8.15	0.50	4.00	75.00	10.00	0.60	-3.43	-0.64	-21.68	4.00	0.65	1.65	0.19	-2.96	4.00	6.17	0.26	
75.00	20.00	-19.21	0.04	-7.39	-2.41	4.00	75.00	20.00	0.29	-3.94	-5.74	-25.29	4.00	0.48	1.27	-3.39	-9.69	4.00	4.33	-1.22	
75.00	30.00	-13.21	-3.18	-7.19	-9.81	4.00	75.00	30.00	0.29	-3.94	-5.74	-25.29	4.00	-1.53	0.17	-2.00	-13.54	4.00	3.34	-0.86	
75.00	40.00	-7.84	-5.15	-8.95	-13.62	4.00	75.00	40.00	-1.34	-4.27	-3.12	-31.16	4.00	-4.33	-2.96	-3.26	-11.37	4.00	1.12	-4.50	
75.00	50.00	-12.50	-11.17	-13.40	4.00	4.00	75.00	50.00	-5.05	-4.00	-4.03	-36.66	4.00	4.67	-1.43	-5.67	-10.24	4.00	1.06	-4.84	
75.00	60.00	-8.92	-6.72	-14.85	4.00	4.00	75.00	60.00	-6.72	-1.49	-12.36	-12.08	4.00	-6.19	-6.88	-4.82	-11.13	4.00	-0.94	-6.71	
75.00	70.00	-19.88	-20.91	-7.72	-12.16	4.00	75.00	70.00	-6.38	-7.05	-8.56	-17.87	4.00	-8.98	-0.78	-3.73	-8.				



105.00	100.00	-9.26	-22.67	-13.64	-16.15	4.00	105.00	100.00	-13.38	-5.11	-13.55	-13.34	4.00
105.00	110.00	-24.78	-15.28	-18.24	-13.51	4.00	105.00	110.00	-9.51	-7.87	-10.39	-10.51	4.00
105.00	120.00	-9.85	-16.84	-12.19	-10.46	4.00	105.00	120.00	-25.48	-7.47	-14.37	-10.83	4.00
105.00	130.00	-9.13	-29.84	-15.30	-2.63	4.00	105.00	130.00	-8.06	-25.90	-17.37	-11.89	4.00
105.00	140.00	-26.84	-16.81	-25.08	-0.80	4.00	105.00	140.00	-13.79	-12.05	-19.76	-16.12	4.00
105.00	150.00	-14.19	-3.70	-11.10	-0.81	4.00	105.00	150.00	-7.70	-5.92	-12.60	-12.42	4.00
105.00	160.00	-15.80	-2.70	-8.04	0.70	4.00	105.00	160.00	-4.36	-6.59	-10.39	-15.40	4.00
105.00	170.00	-12.82	-8.20	-9.39	1.43	4.00	105.00	170.00	-3.04	-11.25	-9.27	-12.44	4.00
105.00	180.00	-13.26	-9.75	-4.60	2.74	4.00	105.00	180.00	-4.47	-18.12	-13.95	-10.25	4.00
105.00	190.00	-19.45	-8.49	-5.23	3.84	4.00	105.00	190.00	-1.11	-16.79	-9.16	-11.77	4.00
105.00	200.00	-13.83	-7.91	-4.44	3.72	4.00	105.00	200.00	-3.60	-13.52	-9.73	-26.81	4.00
105.00	210.00	-10.52	-16.36	-9.16	-1.82	4.00	105.00	210.00	-7.95	-9.53	-4.89	-8.09	4.00
105.00	220.00	-12.92	-9.98	-3.69	1.70	4.00	105.00	220.00	-7.62	-14.33	-6.42	-11.89	4.00
105.00	230.00	-14.80	-14.40	-3.54	-0.31	4.00	105.00	230.00	-6.96	-23.11	-7.39	-22.93	4.00
105.00	240.00	-15.11	-14.47	-3.17	-2.25	4.00	105.00	240.00	-8.20	-15.98	-5.80	-15.74	4.00
105.00	250.00	-9.76	-18.30	-3.09	-3.28	4.00	105.00	250.00	-9.66	-12.12	-10.63	-13.61	4.00
105.00	260.00	-9.82	-15.42	-2.57	-0.16	4.00	105.00	260.00	-13.40	-8.20	-27.93	-14.81	4.00
105.00	270.00	-7.94	-12.99	-1.66	2.11	4.00	105.00	270.00	-12.41	-8.60	-11.47	-20.32	4.00
105.00	280.00	-9.54	-14.48	-1.38	3.71	4.00	105.00	280.00	-6.75	-13.35	-5.84	-17.88	4.00
105.00	290.00	-16.07	-22.89	-1.81	3.15	4.00	105.00	290.00	-4.18	-19.27	-1.75	-13.11	4.00
105.00	300.00	-17.42	-9.36	-3.12	3.38	4.00	105.00	300.00	-5.70	-20.24	-0.40	-13.96	4.00
105.00	310.00	-12.72	-5.16	-3.54	1.89	4.00	105.00	310.00	-6.10	-17.45	0.12	-15.34	4.00
105.00	320.00	-11.06	-7.34	-5.41	-1.09	4.00	105.00	320.00	-3.88	-8.29	-0.34	-20.46	4.00
105.00	330.00	-22.78	-7.49	-4.36	-2.85	4.00	105.00	330.00	-3.91	-5.65	-0.79	-20.48	4.00
105.00	340.00	-23.49	-4.77	-7.19	-1.52	4.00	105.00	340.00	-6.59	-5.41	-0.20	-10.94	4.00
105.00	350.00	-12.88	-7.21	-10.92	0.96	4.00	105.00	350.00	-7.24	-9.51	-0.38	-12.07	4.00
120.00	0.00	-13.46	-2.74	-12.18	-1.60	4.00	120.00	0.00	-3.63	-13.06	-2.41	-10.21	4.00
120.00	10.00	-9.34	-1.20	-15.44	-1.89	4.00	120.00	10.00	-2.84	-13.68	-3.40	-13.68	4.00
120.00	20.00	-13.67	-7.90	-14.02	-2.61	4.00	120.00	20.00	-3.57	-5.13	-8.07	-18.74	4.00
120.00	30.00	-13.60	-6.59	-14.82	-3.96	4.00	120.00	30.00	-11.52	-4.66	-5.77	-14.24	4.00
120.00	40.00	-6.61	-6.61	-16.48	-11.20	4.00	120.00	40.00	-18.16	-1.90	-12.11	-5.48	4.00
120.00	50.00	-11.18	-6.99	-8.79	-11.34	4.00	120.00	50.00	-11.98	-0.97	-9.52	-5.45	4.00
120.00	60.00	-6.79	-21.15	-17.30	-16.50	4.00	120.00	60.00	-13.63	-2.58	-8.43	-9.52	4.00
120.00	70.00	-5.83	-6.96	-15.60	-25.35	4.00	120.00	70.00	-13.94	-1.26	-8.59	-19.96	4.00
120.00	80.00	-11.49	-10.78	-22.16	-20.51	4.00	120.00	80.00	-10.74	1.42	-13.67	-16.49	4.00
120.00	90.00	15.70	12.55	-18.23	-12.84	4.00	120.00	90.00	-5.42	-6.71	-8.53	-12.01	4.00
120.00	100.00	-10.41	-21.08	-22.25	-17.12	4.00	120.00	100.00	-8.12	-11.74	-7.57	-12.15	4.00
120.00	110.00	-17.12	-20.73	-13.34	-16.30	4.00	120.00	110.00	-15.01	-13.40	-6.56	-11.98	4.00
120.00	120.00	-7.78	-12.65	-13.10	-12.15	4.00	120.00	120.00	-6.43	-1.91	-10.88	-17.29	4.00
120.00	130.00	-8.59	-27.31	-10.15	-5.08	4.00	120.00	130.00	-7.91	-12.52	-23.34	-14.35	4.00
120.00	140.00	-18.78	-3.39	-10.07	-5.19	4.00	120.00	140.00	-7.72	-1.92	-12.77	-27.60	4.00
120.00	150.00	-23.14	-1.72	-15.93	-2.43	4.00	120.00	150.00	-8.30	-4.45	-23.58	-22.22	4.00
120.00	160.00	-18.76	-6.65	-7.64	-0.67	4.00	120.00	160.00	-10.60	-2.19	-16.02	-14.40	4.00
120.00	170.00	-29.91	-7.55	-10.43	0.33	4.00	120.00	170.00	-13.43	-12.41	-21.45	-16.12	4.00
120.00	180.00	-13.21	-4.87	-9.96	2.20	4.00	120.00	180.00	-5.47	-14.55	-18.83	-10.52	4.00
120.00	190.00	-15.76	-8.61	-5.73	2.85	4.00	120.00	190.00	-3.83	-13.23	-19.43	-15.80	4.00
120.00	200.00	-8.33	-8.47	-4.29	2.93	4.00	120.00	200.00	-8.49	-6.46	-11.95	-10.65	4.00
120.00	210.00	-12.53	-9.10	-5.69	1.24	4.00	120.00	210.00	-14.19	-18.99	-8.95	-10.40	4.00
120.00	220.00	-16.81	-10.89	-3.81	0.26	4.00	120.00	220.00	-10.99	-15.68	-5.27	-22.74	4.00
120.00	230.00	-18.58	-11.77	-4.17	-1.42	4.00	120.00	230.00	-17.10	-8.35	-7.30	-10.66	4.00
120.00	240.00	-16.09	-19.27	-5.15	-5.26	4.00	120.00	240.00	-11.79	-8.20	-6.22	-12.19	4.00
120.00	250.00	-10.51	-17.44	-3.86	-5.01	4.00	120.00	250.00	-9.42	-7.21	-10.76	-14.69	4.00
120.00	260.00	-12.47	-22.13	-2.86	-0.68	4.00	120.00	260.00	-10.55	-7.22	-22.42	-11.75	4.00
120.00	270.00	-14.46	-17.75	-1.04	1.62	4.00	120.00	270.00	-8.41	-9.50	-16.75	-14.62	4.00
120.00	280.00	-17.20	-15.42	-1.04	2.71	4.00	120.00	280.00	-6.90	-8.41	-9.93	-25.36	4.00
120.00	290.00	-16.80	-11.03	-1.11	3.70	4.00	120.00	290.00	-5.86	-6.13	-5.04	-10.55	4.00
120.00	300.00	-17.05	-6.67	-1.96	2.78	4.00	120.00	300.00	-4.52	-7.31	-2.61	-8.59	4.00
120.00	310.00	-24.80	-8.13	-2.43	-1.18	4.00	120.00	310.00	-3.72	-3.22	-3.22	-16.50	4.00
120.00	320.00	-13.40	-7.09	-4.06	-3.30	4.00	120.00	320.00	-3.87	-2.56	-4.11	-20.09	4.00
120.00	330.00	-10.99	-3.40	-7.72	4.00	4.00	120.00	330.00	-3.04	-6.34	0.28	-20.79	4.00
120.00	340.00	-13.99	-2.78	-8.57	-7.13	4.00	120.00	340.00	-2.89	-4.59	-0.94	-12.06	4.00
120.00	350.00	-21.73	-4.70	-14.00	-4.66	4.00	120.00	350.00	-5.37	-10.39	-1.05	-10.43	4.00
135.00	0.00	-9.84	-6.21	-11.60	-5.10	4.00	135.00	0.00	-3.33	-11.65	-3.53	-34.76	4.00
135.00	10.00	-8.03	-9.79	-18.89	-4.54	4.00	135.00	10.00	-2.87	-9.27	-4.63	-32.38	4.00
135.00	20.00	-15.33	-0.33	-15.31	-4.77	4.00	135.00	20.00	-8.41	-1.03	-3.17	-23.56	4.00
135.00	30.00	-15.59	-3.55	-13.25	-6.69	4.00	135.00	30.00	-4.78	-8.78	-3.04	-13.94	4.00
135.00	40.00	-5.51	-8.06	-10.87	-8.48	4.00	135.00	40.00	-5.40	-1.00	-6.70	-9.45	4.00
135.00	50.00	-12.04	-19.10	-18.67	-8.51	4.00	135.00	50.00	-14.60	-19.12	-32.04	-5.69	4.00
135.00	60.00	-11.42	-13.19	-12.42	-8.94	4.00	135.00	60.00	-8.24	-0.75	-6.77	-6.13	4.00
135.00	70.00	-9.09	-17.69	-12.01	-14.13	4.00	135.00	70.00	-8.97	-0.19	-11.19	-7.34	4.00
135.00	80.00	-6.60	-21.61	-19.93	-13.38	4.00	135.00	80.00	-18.82	-2.44	-8.45	-8.55	4.00
135.00	90.00	-6.42	-16.86	-29.44	-15.35	4.00	135.00	90.00	-14.34	-5.34	-9.47	-10.41	4.00
135.00	100.00	-8.89	-10.17	-17.19	-15.60	4.00	135.00	100.00	-13.65	-2.18	-23.55	-35.23	4.00
135.00	110.00	-16.65	-8.50	-35.85	-13.73	4.00	135.00	110.00	-5.42	-1.65	-19.07	-6.91	4.00
135.00	120.00	-11.94	-25.90	-12.90	-12.64	4.00	135.00	120.00	-3.85	-3.03	-20.39	-8.51	4.00
135.00	130.00	-15.56	-5.25	-13.51	-17.53	4.00	135.00	130.00	-17.20	0.15	-16.62	-8.14	4.00
135.00	140.00	-13.90	-2.83	-9.49	-7.05	4.00	135.00	140.00	-6.16	0.43	-13.91	-7.13	4.00
135.00	150.00	-5.68	-13.07	-8.48	-6.11	4.00	135.00	150.00	-9.08	-11.19	-33.48	-3.88	4.00
135.00	160.00	-11.56	-3.69	-6.41	-3.33	4.00	135.00	160.00	-6.75	-12.26	-19.52	-8.18	4.00
135.00	170.00	-15.47	-1.74	-7.63	-1.69	4.00	135.00	170.00	-7.25	-16.42	-12.03	-8.19	4.00
135.00	180.00	-18.08	-6.00	-4.08	1.05	4.00	135.00	180.00	-4.80	-16.82	-6.70	-9.08	4.00
135.00	190.00	-7.38	-5.02	-5.55	0.02	4.00	135.00	190.00	-7.68	-23.84	-5.30	-13.58	4.00
135.00	200.00	-7.22	-4.85	-4.04	0.25	4.00	135.00	200.00	-6.23	-7.27	-7.46	-13.39	4.00
135.00	210.00	-15.45	-10.65	-4.68	0.18	4.00	135.00	210.00	-6.97	-8.93	-4.53	-22.30	4.00
135.00	220.00	-15.03	-11.36	-4.83	-4.26	4.00	135.00	220.00	-6.06	-0.77	-5.86	-4.73	4.00
135.00	230.00	-10.97	-11.82	-3.57	-9.87	4.00	135.00	230.00	-4.25	-5.40	-5.60	-11.44	4.00
135.00	240.00	-14.30	-17.38	-4.98	-11.28	4.00	135.00	240					



165.00	10.00	-18.57	-6.15	-13.59	-11.00	4.00	165.00	10.00	-9.39	-6.33	-6.50	-8.03	4.00
165.00	20.00	-19.51	-16.30	-15.68	-15.36	4.00	165.00	20.00	-9.08	-9.14	-8.52	-11.50	4.00
165.00	30.00	-18.78	-5.88	-16.17	-21.82	4.00	165.00	30.00	-10.04	-11.65	-7.79	-12.02	4.00
165.00	40.00	-19.65	-6.52	-12.16	-24.60	4.00	165.00	40.00	-14.08	-7.94	-6.10	-9.46	4.00
165.00	50.00	-13.99	-13.62	-9.46	-20.03	4.00	165.00	50.00	-16.90	-5.77	-6.64	-9.34	4.00
165.00	60.00	-14.32	-22.68	-7.50	-18.39	4.00	165.00	60.00	-24.79	-5.77	-8.37	-9.02	4.00
165.00	70.00	-17.25	-19.46	-9.16	-22.43	4.00	165.00	70.00	-26.33	-4.21	-10.52	-16.90	4.00
165.00	80.00	-21.55	-12.37	-10.32	-23.11	4.00	165.00	80.00	-21.11	-2.68	-15.92	-14.97	4.00
165.00	90.00	-24.31	-11.02	-14.48	-21.75	4.00	165.00	90.00	-25.43	-3.36	-16.11	-17.40	4.00
165.00	100.00	-19.33	-9.41	-21.91	-19.32	4.00	165.00	100.00	-16.98	-3.58	-31.02	-17.59	4.00
165.00	110.00	-16.58	-6.56	-23.07	-12.27	4.00	165.00	110.00	-21.74	-4.09	-19.72	-16.19	4.00
165.00	120.00	-12.56	-5.67	-20.47	-13.08	4.00	165.00	120.00	-22.26	-4.64	-14.99	-30.43	4.00
165.00	130.00	-9.66	-7.13	-14.31	-12.24	4.00	165.00	130.00	-29.57	-9.28	-11.98	-29.50	4.00
165.00	140.00	-11.08	-9.52	-10.45	-13.77	4.00	165.00	140.00	-22.68	-11.91	-9.77	-20.77	4.00
165.00	150.00	-12.75	-9.73	-9.28	-16.44	4.00	165.00	150.00	-18.24	-9.90	-11.28	-12.96	4.00
165.00	160.00	-18.02	-5.10	-7.36	-21.51	4.00	165.00	160.00	-13.70	-8.57	-10.70	-14.96	4.00
165.00	170.00	-15.20	-3.82	-7.57	-17.70	4.00	165.00	170.00	-11.31	-13.96	-13.10	-10.71	4.00
165.00	180.00	-14.56	-4.80	-11.09	-20.02	4.00	165.00	180.00	-18.18	-28.72	-19.03	-9.85	4.00
165.00	190.00	-10.74	-6.06	-15.89	-21.44	4.00	165.00	190.00	-22.36	-11.58	-21.27	-10.08	4.00
165.00	200.00	-14.75	-6.33	-12.97	-19.42	4.00	165.00	200.00	-19.79	-5.01	-18.92	-13.51	4.00
165.00	210.00	-14.86	-8.76	-13.94	-19.19	4.00	165.00	210.00	-18.24	-3.44	-13.62	-13.33	4.00
165.00	220.00	-12.77	-7.64	-16.89	-17.12	4.00	165.00	220.00	-19.82	-1.91	-11.59	-16.46	4.00
165.00	230.00	-12.51	-9.02	-18.21	-16.62	4.00	165.00	230.00	-24.49	-0.33	-10.39	-16.53	4.00
165.00	240.00	-15.72	-12.06	-19.51	-19.78	4.00	165.00	240.00	-18.91	-1.02	-9.00	-11.92	4.00
165.00	250.00	-35.82	-23.06	-22.57	-18.28	4.00	165.00	250.00	-17.61	-2.35	-8.17	-8.32	4.00
165.00	260.00	-12.17	-15.44	-16.49	-17.29	4.00	165.00	260.00	-13.83	-3.07	-7.09	-7.72	4.00
165.00	270.00	-8.71	-15.98	-17.93	-16.44	4.00	165.00	270.00	-10.02	-5.25	-5.96	-5.65	4.00
165.00	280.00	-6.69	-13.65	-20.28	-15.77	4.00	165.00	280.00	-8.42	-9.43	-5.44	-5.60	4.00
165.00	290.00	-4.89	-13.49	-20.20	-11.60	4.00	165.00	290.00	-7.92	-13.13	-4.79	-4.15	4.00
165.00	300.00	-4.34	-10.56	-21.69	-9.27	4.00	165.00	300.00	-9.67	-10.57	-4.07	-4.97	4.00
165.00	310.00	-3.78	-4.68	-21.90	-7.27	4.00	165.00	310.00	-8.42	-11.35	-3.25	-6.23	4.00
165.00	320.00	-5.41	-0.59	-20.72	-6.18	4.00	165.00	320.00	-8.71	-8.59	-5.13	-4.83	4.00
165.00	330.00	-5.63	1.64	-15.42	-4.68	4.00	165.00	330.00	-9.24	-11.11	-5.31	-7.39	4.00
165.00	340.00	-9.35	2.58	-12.54	-4.32	4.00	165.00	340.00	-8.23	-13.89	-6.34	-6.62	4.00
165.00	350.00	-12.92	2.25	-12.10	-4.32	4.00	165.00	350.00	-10.23	-14.55	-7.71	-7.71	4.00
180.00	0.00	-19.38	-5.98	-12.58	-7.10	4.00	180.00	0.00	-12.65	-15.93	-13.34	-11.14	4.00
180.00	10.00	-16.70	-5.54	-11.41	-6.32	4.00	180.00	10.00	-13.52	-23.21	-15.33	-14.13	4.00
180.00	20.00	-14.86	-5.48	-10.62	-5.86	4.00	180.00	20.00	-14.78	-32.51	-18.28	-19.19	4.00
180.00	30.00	-13.57	-5.68	-10.14	-5.67	4.00	180.00	30.00	-16.58	-18.73	-23.23	-34.17	4.00
180.00	40.00	-12.69	-6.16	-9.94	-5.74	4.00	180.00	40.00	-19.21	-13.80	-37.16	-22.95	4.00
180.00	50.00	-12.12	-6.95	-10.01	-6.09	4.00	180.00	50.00	-23.40	-10.85	-27.61	-15.93	4.00
180.00	60.00	-11.85	-8.12	-10.34	-6.73	4.00	180.00	60.00	-11.84	-9.79	-10.97	-7.71	4.00
180.00	70.00	-11.84	-9.79	-10.97	-7.11	4.00	180.00	70.00	-32.55	-8.87	-20.37	-12.27	4.00
180.00	80.00	-12.10	-12.20	-11.94	-9.12	4.00	180.00	80.00	-23.70	-6.51	-14.24	-8.26	4.00
180.00	90.00	-12.65	-15.93	-13.34	-11.14	4.00	180.00	90.00	-19.38	-5.88	-12.58	-7.10	4.00
180.00	100.00	-13.52	-23.21	-15.33	-14.13	4.00	180.00	100.00	-16.70	-5.54	-11.41	-6.32	4.00
180.00	110.00	-14.78	-32.51	-18.28	-19.19	4.00	180.00	110.00	-14.86	-5.48	-10.62	-5.86	4.00
180.00	120.00	-16.58	-18.73	-23.23	-34.17	4.00	180.00	120.00	-13.57	-5.68	-10.14	-5.67	4.00
180.00	130.00	-19.21	-13.80	-37.16	-22.95	4.00	180.00	130.00	-12.69	-6.16	-9.94	-5.74	4.00
180.00	140.00	-23.40	-10.85	-27.61	-15.93	4.00	180.00	140.00	-12.12	-6.95	-10.01	-6.09	4.00
180.00	150.00	-32.55	-8.87	-20.37	-12.27	4.00	180.00	150.00	-11.85	-8.12	-10.34	-6.73	4.00
180.00	160.00	-33.48	-7.47	-16.64	-9.90	4.00	180.00	160.00	-11.84	-9.79	-10.97	-7.71	4.00
180.00	170.00	-23.70	-6.51	-14.24	-8.26	4.00	180.00	170.00	-12.10	-12.20	-11.94	-9.12	4.00
180.00	180.00	-19.38	-5.88	-12.58	-7.10	4.00	180.00	180.00	-12.65	-15.93	-13.34	-11.14	4.00
180.00	190.00	-16.70	-5.54	-11.41	-6.32	4.00	180.00	190.00	-13.52	-23.21	-15.33	-14.13	4.00
180.00	200.00	-14.86	-5.48	-10.62	-5.86	4.00	180.00	200.00	-14.78	-32.51	-18.28	-19.19	4.00
180.00	210.00	-13.57	-5.68	-10.14	-5.67	4.00	180.00	210.00	-16.58	-18.73	-23.23	-34.17	4.00
180.00	220.00	-12.69	-6.16	-9.94	-5.74	4.00	180.00	220.00	-19.21	-13.80	-37.16	-22.95	4.00
180.00	230.00	-12.12	-6.95	-10.01	-6.09	4.00	180.00	230.00	-23.40	-10.85	-27.61	-15.93	4.00
180.00	240.00	-11.85	-8.12	-10.34	-6.73	4.00	180.00	240.00	-32.55	-8.87	-20.37	-12.27	4.00
180.00	250.00	-11.84	-9.79	-10.97	-7.11	4.00	180.00	250.00	-33.48	-7.47	-16.64	-9.90	4.00
180.00	260.00	-12.10	-12.20	-11.94	-9.12	4.00	180.00	260.00	-23.70	-6.51	-14.24	-8.26	4.00
180.00	270.00	-12.65	-15.93	-13.34	-11.14	4.00	180.00	270.00	-19.38	-5.88	-12.58	-7.10	4.00
180.00	280.00	-13.52	-23.21	-15.33	-14.13	4.00	180.00	280.00	-16.70	-5.54	-11.41	-6.32	4.00
180.00	290.00	-14.78	-32.51	-18.28	-19.19	4.00	180.00	290.00	-14.86	-5.48	-10.62	-5.86	4.00
180.00	300.00	-16.58	-18.73	-23.23	-34.17	4.00	180.00	300.00	-13.57	-5.68	-10.14	-5.67	4.00
180.00	310.00	-19.21	-13.80	-37.16	-22.95	4.00	180.00	310.00	-12.69	-6.16	-9.94	-5.74	4.00
180.00	320.00	-23.40	-10.85	-27.61	-15.93	4.00	180.00	320.00	-12.12	-6.95	-10.01	-6.09	4.00
180.00	330.00	-32.55	-8.87	-20.37	-12.27	4.00	180.00	330.00	-11.85	-8.12	-10.34	-6.73	4.00
180.00	340.00	-33.48	-7.47	-16.64	-9.90	4.00	180.00	340.00	-11.84	-9.79	-10.97	-7.71	4.00
180.00	350.00	-23.70	-6.51	-14.24	-8.26	4.00	180.00	350.00	-12.10	-12.20	-11.94	-9.12	4.00

-8.89	-3.23	-5.72	-6.26	4.00	0.23	-5.57
-8.70	-8.38	-7.76	-10.00	4.00	-2.65	-8.64
-9.50	-4.86	-7.20	-11.59	4.00	-1.90	-7.58
-13.02	-4.16	-5.14	-9.33	4.00	-1.22	-6.69
-12.20	-5.11	-4.81	-8.98	4.00	-1.26	-6.86
-13.95	-5.68	-4.90	-8.54	4.00	-1.60	-7.13
-16.74	-4.08	-6.78	-15.83	4.00	-3.16	-7.90
-18.31	-2.24	-9.26	-14.35	4.00	-2.91	-7.17
-21.82	-2.67	-12.21	-16.04	4.00	-4.30	-8.01
-14.99	-2.57	-21.41	-15.36	4.00	-4.60	-8.09
-15.42	-2.14	-18.07	-10.79	4.00	-3.32	-7.34
-12.12	-2.11	-13.91	-13.00	4.00	-2.75	-7.17
-9.62	-5.06	-9.98	-12.16	4.00	-2.78	-8.37
-10.79	-7.54	-7.09	-12.98	4.00	-3.25	-8.98
-11.67	-6.80	-7.16	-11.35	4.00	-2.93	-8.68
-12.33	-3.49	-5.71	-14.09	4.00	-1.79	-6.91
-9.82	-3.42	-6.50	-9.92	4.00	-0.96	-6.55
-12.99	-4.78	-10.44	-9.45	4.00	-2.87	-8.34
-10.45	-4.99	-14.78	-9.77	4.00	-3.28	-8.65
-13.57	-2.61	-11.99	-12.52	4.00	-2.86	-7.50
-13.22	-2.32	-10.77	-12.33	4.00	-2.41	-7.12
-11.99	-0.88	-10.47	-13.77	4.00	-1.62	-5.97
-12.24	0.22	-9.73	-13.56	4.00	-0.89	-5.01
-14.02	-0.69	-8.63	-11.26	4.00	-1.08	-5.59
-17.54	-2.31	-8.02	-7.90	4.00	-1.42	-6.36
-9.91	-2.83	-6.62	-7.27	4.00	-0.26	-5.89
-6.31	-4.90	-5.69	-5.30	4.00	0.49	-5.52
-4.46	-8.04	-5.30	-9.43	4.00	0.37	-5.56
-3.14	-10.30	-4.67	-3.43	4.00	1.06	-4.64
-3.22	-7.55	-4.00	-3.60	4.00	1.59	-4.30



Frequency: 6875MHz

Theta Polarization		Max Gain(dB)				Nant	Phi Polarization		Max Gain(dB)				Nant	Total							
Angle (θ)	Angle (ψ)	Ant 1(G1)	Ant 2(G2)	Ant 3(G3)	Ant 4(G4)		Angle (θ)	Angle (ψ)	Ant 1(G1)	Ant 2(G2)	Ant 3(G3)	Ant 4(G4)		Nant	Ant 1(G1)	Ant 2(G2)	Ant 3(G3)	Ant 4(G4)	Nant	Max DG(dB)	Max DG(dB)
		2.18	4.23	2.33	5.24				2.50	4.70	1.73	-3.22			4.11	4.85	3.63	5.26		8.04	2.18
		Ant 1(G1)	Ant 2(G2)	Ant 3(G3)	Ant 4(G4)				Ant 1(G1)	Ant 2(G2)	Ant 3(G3)	Ant 4(G4)			Ant 1(G1)	Ant 2(G2)	Ant 3(G3)	Ant 4(G4)		g/k	g/k
0.00	0.00	-13.26	0.90	-15.58	-7.72	4.00	0.00	0.00	1.84	-11.37	-2.23	-11.92	4.00	1.97	1.15	-2.03	-6.32	4.00	5.27	-0.29	
0.00	10.00	-7.36	1.13	-10.51	-6.95	4.00	0.00	10.00	1.43	-22.66	-2.70	-14.98	4.00	1.97	1.15	-2.03	-6.32	4.00	5.27	-0.30	
0.00	20.00	-4.06	1.09	-7.52	-6.50	4.00	0.00	20.00	0.72	-18.05	-3.48	-20.21	4.00	1.97	1.14	-2.04	-6.32	4.00	5.27	-0.30	
0.00	30.00	-1.87	0.79	-5.50	-6.32	4.00	0.00	30.00	-0.34	-9.89	-4.64	-37.08	4.00	1.97	1.15	-2.04	-6.32	4.00	5.27	-0.30	
0.00	40.00	-0.35	0.20	-4.09	-6.41	4.00	0.00	40.00	-1.86	-5.92	-6.28	-23.09	4.00	1.97	1.15	-2.04	-6.32	4.00	5.27	-0.30	
0.00	50.00	0.72	-0.73	-3.11	-6.77	4.00	0.00	50.00	-4.04	-3.41	-8.65	-16.36	4.00	1.97	1.14	-2.04	-6.32	4.00	5.27	-0.30	
0.00	60.00	1.43	-2.07	-2.47	-7.43	4.00	0.00	60.00	-7.33	-1.67	-12.31	-12.79	4.00	1.97	1.14	-2.04	-6.32	4.00	5.27	-0.30	
0.00	70.00	1.84	-3.97	-2.12	-8.43	4.00	0.00	70.00	-13.21	-0.45	-19.32	-10.46	4.00	1.97	1.15	-2.04	-6.32	4.00	5.27	-0.30	
0.00	80.00	1.97	-6.77	-2.04	-9.87	4.00	0.00	80.00	-38.03	0.38	-30.58	-8.85	4.00	1.97	1.15	-2.03	-6.32	4.00	5.27	-0.30	
0.00	90.00	1.84	-11.37	-2.23	-11.92	4.00	0.00	90.00	-13.26	0.90	-2.70	-15.58	4.00	1.97	1.15	-2.03	-6.32	4.00	5.27	-0.29	
0.00	100.00	1.43	-22.66	-2.70	-14.98	4.00	0.00	100.00	-7.36	1.13	-10.51	-6.95	4.00	1.97	1.15	-2.03	-6.32	4.00	5.27	-0.30	
0.00	110.00	0.72	-18.05	-3.48	-20.21	4.00	0.00	110.00	-4.06	1.09	-7.52	-6.50	4.00	1.97	1.14	-2.04	-6.32	4.00	5.27	-0.30	
0.00	120.00	-0.34	-9.89	-4.64	-37.08	4.00	0.00	120.00	-1.87	0.79	-5.50	-6.32	4.00	1.97	1.15	-2.04	-6.32	4.00	5.27	-0.30	
0.00	130.00	-1.86	-5.92	-6.28	-23.09	4.00	0.00	130.00	-0.35	0.20	-4.09	-6.41	4.00	1.97	1.15	-2.04	-6.32	4.00	5.27	-0.30	
0.00	140.00	-4.04	-3.41	-8.65	-16.36	4.00	0.00	140.00	0.72	-0.73	-3.11	-6.77	4.00	1.97	1.14	-2.04	-6.32	4.00	5.27	-0.30	
0.00	150.00	-7.33	-1.67	-12.31	-12.79	4.00	0.00	150.00	1.43	-2.07	-2.47	-7.43	4.00	1.97	1.14	-2.04	-6.32	4.00	5.27	-0.30	
0.00	160.00	-13.21	-0.45	-19.32	-10.46	4.00	0.00	160.00	1.84	-3.97	-2.12	-8.43	4.00	1.97	1.15	-2.04	-6.32	4.00	5.27	-0.30	
0.00	170.00	-38.03	0.38	-30.58	-8.85	4.00	0.00	170.00	1.97	-6.77	-2.04	-9.87	4.00	1.97	1.15	-2.03	-6.32	4.00	5.27	-0.30	
0.00	180.00	-13.26	0.90	-15.58	-7.72	4.00	0.00	180.00	1.84	-11.37	-2.23	-11.92	4.00	1.97	1.15	-2.03	-6.32	4.00	5.27	-0.29	
0.00	190.00	-7.36	1.13	-10.51	-6.95	4.00	0.00	190.00	1.43	-22.66	-2.70	-14.98	4.00	1.97	1.15	-2.03	-6.32	4.00	5.27	-0.30	
0.00	200.00	-4.06	1.09	-7.52	-6.50	4.00	0.00	200.00	0.72	-18.05	-3.48	-20.21	4.00	1.97	1.14	-2.04	-6.32	4.00	5.27	-0.30	
0.00	210.00	-1.87	0.79	-5.50	-6.32	4.00	0.00	210.00	-0.34	-9.89	-4.64	-37.08	4.00	1.97	1.15	-2.04	-6.32	4.00	5.27	-0.30	
0.00	220.00	-0.35	0.20	-4.09	-6.41	4.00	0.00	220.00	-1.86	-5.92	-6.28	-23.09	4.00	1.97	1.15	-2.04	-6.32	4.00	5.27	-0.30	
0.00	230.00	0.72	-0.73	-3.11	-6.77	4.00	0.00	230.00	-4.04	-3.41	-8.65	-16.36	4.00	1.97	1.14	-2.04	-6.32	4.00	5.27	-0.30	
0.00	240.00	1.43	-2.07	-2.47	-7.43	4.00	0.00	240.00	-7.33	-1.67	-12.31	-12.79	4.00	1.97	1.14	-2.04	-6.32	4.00	5.27	-0.30	
0.00	250.00	1.84	-3.97	-2.12	-8.43	4.00	0.00	250.00	-13.21	-0.45	-19.32	-10.46	4.00	1.97	1.15	-2.04	-6.32	4.00	5.27	-0.30	
0.00	260.00	1.97	-6.77	-2.04	-9.87	4.00	0.00	260.00	-38.03	0.38	-30.58	-8.85	4.00	1.97	1.15	-2.03	-6.32	4.00	5.27	-0.30	
0.00	270.00	1.84	-11.37	-2.23	-11.92	4.00	0.00	270.00	-13.26	0.90	-2.70	-15.58	4.00	1.97	1.15	-2.03	-6.32	4.00	5.27	-0.29	
0.00	280.00	1.43	-22.66	-2.70	-14.98	4.00	0.00	280.00	-7.36	1.13	-10.51	-6.95	4.00	1.97	1.15	-2.03	-6.32	4.00	5.27	-0.30	
0.00	290.00	0.72	-18.05	-3.48	-20.21	4.00	0.00	290.00	-4.06	1.09	-7.52	-6.50	4.00	1.97	1.14	-2.04	-6.32	4.00	5.27	-0.30	
0.00	300.00	-0.34	-9.89	-4.64	-37.08	4.00	0.00	300.00	-1.87	0.79	-5.50	-6.32	4.00	1.97	1.15	-2.04	-6.32	4.00	5.27	-0.30	
0.00	310.00	-1.86	-5.92	-6.28	-23.09	4.00	0.00	310.00	-0.35	0.20	-4.09	-6.41	4.00	1.97	1.15	-2.04	-6.32	4.00	5.27	-0.30	
0.00	320.00	-4.04	-3.41	-8.65	-16.36	4.00	0.00	320.00	0.72	-0.73	-3.11	-6.77	4.00	1.97	1.14	-2.04	-6.32	4.00	5.27	-0.30	
0.00	330.00	-7.33	-1.67	-12.31	-12.79	4.00	0.00	330.00	1.43	-2.07	-2.47	-7.43	4.00	1.97	1.14	-2.04	-6.32	4.00	5.27	-0.30	
0.00	340.00	-13.21	-0.45	-19.32	-10.46	4.00	0.00	340.00	1.84	-3.97	-2.12	-8.43	4.00	1.97	1.15	-2.04	-6.32	4.00	5.27	-0.30	
0.00	350.00	-38.03	0.38	-30.58	-8.85	4.00	0.00	350.00	1.97	-6.77	-2.04	-9.87	4.00	1.97	1.15	-2.03	-6.32	4.00	5.27	-0.30	
15.00	0.00	-21.01	-1.98	-3.39	-14.54	4.00	15.00	0.00	0.67	-12.92	-2.13	-15.67	4.00	0.70	-1.64	0.30	-12.06	4.00	4.07	-1.26	
15.00	10.00	-13.19	-2.97	-3.43	-13.24	4.00	15.00	10.00	1.16	-22.37	-3.74	-11.32	4.00	1.32	-2.92	-0.57	-9.16	4.00	3.98	-1.45	
15.00	20.00	-5.37	-0.77	-2.35	-17.92	4.00	15.00	20.00	-0.45	-12.33	-5.58	-10.92	4.00	0.76	-0.48	-0.66	-10.13	4.00	4.29	-1.19	
15.00	30.00	-4.72	-0.70	-1.10	-24.25	4.00	15.00	30.00	-0.96	-8.55	-7.33	-9.96	4.00	0.57	-0.04	-0.17	-9.80	4.00	4.52	-0.98	
15.00	40.00	-3.55	-1.13	-1.25	-14.37	4.00	15.00	40.00	-3.40	-8.16	-11.56	-11.46	4.00	-0.46	-0.34	-0.86	-9.16	4.00	3.93	-1.63	
15.00	50.00	-3.27	-1.79	-0.48	-18.03	4.00	15.00	50.00	-4.14	-4.90	-9.17	-12.79	4.00	-0.67	-0.06	0.07	-11.65	4.00	4.05	-1.36	
15.00	60.00	-1.96	-3.63	-0.71	-16.29	4.00	15.00	60.00	-6.52	-3.44	-8.70	-17.53	4.00	-0.68	-0.52	-0.07	-13.86	4.00	3.70	-1.60	
15.00	70.00	-1.50	-6.33	-0.83	-19.92	4.00	15.00	70.00	-11.41	-2.55	-14.58	-14.38	4.00	-1.08	-1.03	-0.65	-15.31	4.00	3.27	-2.08	
15.00	80.00	-1.52	-10.10	-0.66	-12.76	4.00	15.00	80.00	-14.11	-2.12	-18.67	-16.85	4.00	-1.29	-1.48	-0.59	-10.39	4.00	3.33	-2.19	
15.00	90.00	-1.17	-11.44	-0.90	-10.92	4.00	15.00	90.00	-22.65	-1.50	-19.29	-8.28	4.00	-1.14	-1.08	-0.84	-6.39	4.00	3.94	-1.67	
15.00	100.00	-1.10	-9.89	-0.28	-8.30	4.00	15.00	100.00	-9.84	-0.48	-17.02	-8.15	4.00	-1.05	-0.02	-0.19	-5.21	4.00	4.64	-1.19	
15.00	110.00	-1.94	-7.58	-0.36	-8.42	4.00	15.00	110.00	-0.47	-0.07	-15.26	-6.18	4.00	-1.23	0.64	-0.22	-4.15	4.00	4.96	-0.81	
15.00	120.00	-3.04	-5.61	0.39	-5.74	4.00	15.00	120.00	-7.16	1.06	-10.03	-5.60	4.00	-1.62	1.91	0.77	-2.66	4.00	5.81	-0.03	
15.00	130.00	-3.86	-2.74	-0.12	-4.46	4.00	15.00	130.00	-3.50	1.14	-9.42	-5.92	4.00	-0.67	2.63	0.36	-2.12	4.00	6.25	0.41	
15.00	140.00	-7.18	-2.63	0.19	-2.99	4.00	15.00	140.00	-1.63	-0.05	-4.42	-7.73	4.00	-0.56	1.86	1.48	-1.73	4.00	6.40	0.50	
15.00	150.00	-7.34	-2.43	0.04	-2.17	4.00	15.00	150.00	-0.50	-1.93	-0.88	-9.94	4.00	0.32	0.84	2.61	-1.50	4.00	6.71	0.81	
15.00	160.00	-14.54	-0.88	-1.70	-2.23	4.00	15.00	160.00	0.26	-2.89	0.17	-10.98	4.00	0.40	1.24	2.35	-1.69	4.00	6.72	0.81	
15.00	170.00	-20.20	0.26	-4.47	-2.75	4.00	15.00	170.00	1.44	-4.47	1.37	-10.95	4.00	1.47	1.52	2.79	-1.98	4.00	7.14	1.27	
15.00	180.00	-13.47	1.15	-6.69	-4.05	4.00	15.00	180.00	1.10	-7.69	0.73	-12.59	4.00	1.25	1.68	1.45	-3.48	4.00	6.49	0.66	
15.00	190.00	-8.55	1.99	-8.51	-3.63	4.00	15.00	190.00	1.98	-17.52	0.77	-18.81	4.00	2.35	2.04	1.25	-3.50	4.00	6.85	1.05	
15.00	200.00	-4.52	2.09	-13.60	-5.96	4.00	15.00	200.00	1.47	-15.70	0.26	-14.30	4.00	2.45	2.16	0.43	-5.37	4.00	6.44	0.79	
15.00	210.00	-1.85	0.95	-28.76	-8.98	4.00	15.00	210.00	0.73	-6.99	0.54	-13.68	4.00	2.64	2.64	0.55	-7.71	4.00	6.09	0.59	
15.00	220.00	-0.62</																			



45.00	190.00	-8.45	-5.08	-1.78	-6.51	4.00	45.00	190.00	1.79	-11.65	-1.26	-15.03	4.00
45.00	200.00	-3.37	-1.08	-5.01	-6.31	4.00	45.00	200.00	2.40	-11.29	-0.79	-12.04	4.00
45.00	210.00	-1.34	-0.96	-6.24	-7.50	4.00	45.00	210.00	0.81	-5.27	0.49	-12.93	4.00
45.00	220.00	-1.00	-5.56	-7.06	-6.90	4.00	45.00	220.00	0.21	-4.49	0.35	-21.43	4.00
45.00	230.00	-0.92	-7.36	-11.14	-6.66	4.00	45.00	230.00	-1.84	-0.19	-1.36	-26.84	4.00
45.00	240.00	1.09	-10.18	-11.53	-5.94	4.00	45.00	240.00	-4.04	1.64	-2.40	-24.69	4.00
45.00	250.00	1.05	-12.46	-15.15	-1.32	4.00	45.00	250.00	-7.02	2.28	-6.48	-20.07	4.00
45.00	260.00	1.20	-18.99	-9.67	-0.73	4.00	45.00	260.00	-7.04	3.35	-13.94	-16.50	4.00
45.00	270.00	0.64	-12.86	-11.35	-1.03	4.00	45.00	270.00	-12.01	2.64	-16.62	-15.55	4.00
45.00	280.00	1.07	-7.47	-11.54	-1.97	4.00	45.00	280.00	-20.57	2.23	-6.42	-22.99	4.00
45.00	290.00	-0.34	-3.30	-10.27	-4.41	4.00	45.00	290.00	-7.28	1.33	-4.76	-33.01	4.00
45.00	300.00	-0.49	-1.99	-8.78	-4.49	4.00	45.00	300.00	-4.91	-0.12	-2.08	-14.42	4.00
45.00	310.00	-0.43	-3.33	-5.94	-6.69	4.00	45.00	310.00	-0.78	-2.59	-1.15	-14.74	4.00
45.00	320.00	0.81	-3.92	-4.20	-1.23	4.00	45.00	320.00	1.37	-3.97	-3.64	-12.42	4.00
45.00	330.00	-1.70	-3.69	-4.11	-1.62	4.00	45.00	330.00	2.13	-6.52	-1.96	-11.03	4.00
45.00	340.00	-6.70	-1.77	-0.03	0.62	4.00	45.00	340.00	0.90	-5.11	-0.27	-28.12	4.00
45.00	350.00	-10.25	-2.27	-0.41	0.38	4.00	45.00	350.00	0.29	-7.55	0.45	-12.44	4.00
60.00	0.00	-10.98	-3.37	0.99	0.35	4.00	60.00	0.00	-1.18	-10.66	-0.05	-12.90	4.00
60.00	10.00	-7.26	-1.07	-1.74	-3.84	4.00	60.00	10.00	-0.43	-7.07	-0.01	-17.84	4.00
60.00	20.00	-17.25	0.80	-0.99	-4.74	4.00	60.00	20.00	-1.87	-1.73	-0.15	-19.78	4.00
60.00	30.00	-9.81	2.14	-3.43	-5.19	4.00	60.00	30.00	-1.50	-7.68	0.09	-13.13	4.00
60.00	40.00	-10.80	1.26	-5.42	-10.35	4.00	60.00	40.00	-3.95	-5.40	-6.37	-27.66	4.00
60.00	50.00	-13.33	-3.26	-7.90	-8.22	4.00	60.00	50.00	-6.76	-3.32	-2.81	-11.42	4.00
60.00	60.00	-17.47	-3.83	-8.47	-11.32	4.00	60.00	60.00	-10.41	-4.09	-5.62	-12.03	4.00
60.00	70.00	-25.56	-6.40	-8.96	-15.22	4.00	60.00	70.00	-15.01	-7.67	-9.11	-29.74	4.00
60.00	80.00	-36.05	-11.75	-8.75	-17.31	4.00	60.00	80.00	-16.85	-19.33	-21.68	-25.24	4.00
60.00	90.00	-20.92	-15.82	-6.73	-14.42	4.00	60.00	90.00	-20.64	-10.75	-12.43	-14.91	4.00
60.00	100.00	-12.50	-15.69	-10.95	-13.95	4.00	60.00	100.00	-15.72	-4.48	-10.28	-11.81	4.00
60.00	110.00	-14.48	-15.67	-6.06	-24.05	4.00	60.00	110.00	-10.94	-1.17	-9.46	-16.24	4.00
60.00	120.00	-22.53	-13.49	-4.78	-11.67	4.00	60.00	120.00	-4.70	1.70	-8.13	-21.59	4.00
60.00	130.00	-17.83	-14.67	-5.04	-7.01	4.00	60.00	130.00	-3.93	0.55	-4.98	-11.69	4.00
60.00	140.00	-16.64	-9.40	-4.81	-9.26	4.00	60.00	140.00	-2.83	-0.52	-5.12	-8.91	4.00
60.00	150.00	-17.13	-10.54	-5.15	-7.12	4.00	60.00	150.00	-3.32	-4.40	-4.96	-12.29	4.00
60.00	160.00	-16.99	-13.85	-3.02	-4.31	4.00	60.00	160.00	-1.95	-4.67	-7.24	-9.00	4.00
60.00	170.00	-14.79	-18.01	-17.01	-1.01	4.00	60.00	170.00	-0.12	6.35	-0.31	-21.19	4.00
60.00	180.00	-14.93	-9.05	-2.55	-4.55	4.00	60.00	180.00	1.33	-18.76	-2.71	-10.92	4.00
60.00	190.00	-5.68	-5.18	-1.58	-2.21	4.00	60.00	190.00	-0.02	-21.85	-2.38	-32.74	4.00
60.00	200.00	-4.79	-1.40	-3.97	-2.60	4.00	60.00	200.00	-0.16	-3.90	-0.90	-24.47	4.00
60.00	210.00	-4.12	-3.08	-5.58	-5.29	4.00	60.00	210.00	0.17	-8.45	-0.40	-19.00	4.00
60.00	220.00	-3.32	-8.60	-3.76	-5.30	4.00	60.00	220.00	-0.72	-1.41	0.67	-37.46	4.00
60.00	230.00	-2.16	-9.58	-6.68	-1.92	4.00	60.00	230.00	-2.72	-0.80	-0.19	-18.32	4.00
60.00	240.00	-1.71	-8.84	-11.78	-4.73	4.00	60.00	240.00	-3.25	-0.39	-2.87	-23.01	4.00
60.00	250.00	-1.47	-8.88	-10.11	-5.09	4.00	60.00	250.00	-9.16	-2.49	-4.50	-24.37	4.00
60.00	260.00	-1.83	-7.11	-8.86	-1.45	4.00	60.00	260.00	-25.87	-2.24	-10.66	-20.33	4.00
60.00	270.00	-2.41	-5.67	-7.78	-0.91	4.00	60.00	270.00	-12.41	0.12	-21.45	-17.61	4.00
60.00	280.00	-3.15	-6.40	-8.11	-0.77	4.00	60.00	280.00	-8.01	1.70	-14.25	-20.25	4.00
60.00	290.00	-1.85	-11.98	-7.39	-0.39	4.00	60.00	290.00	-9.27	1.86	-6.98	-15.01	4.00
60.00	300.00	-1.86	-7.44	-6.17	-1.11	4.00	60.00	300.00	-5.38	-0.06	-1.74	-12.11	4.00
60.00	310.00	-3.01	-4.13	-6.73	-2.05	4.00	60.00	310.00	-2.12	-0.22	-2.22	-12.62	4.00
60.00	320.00	-5.24	-4.60	-5.06	-3.10	4.00	60.00	320.00	0.04	-2.01	-0.89	-11.96	4.00
60.00	330.00	-5.40	-3.63	-3.12	0.43	4.00	60.00	330.00	1.84	-6.87	-1.24	-20.59	4.00
60.00	340.00	-8.22	-5.16	-1.06	0.63	4.00	60.00	340.00	0.19	-9.22	-0.43	-16.58	4.00
60.00	350.00	-9.81	-4.48	-0.01	1.18	4.00	60.00	350.00	-1.41	-10.10	-1.38	-13.12	4.00
75.00	0.00	-10.39	-5.95	-3.89	3.02	4.00	75.00	0.00	-0.08	-12.56	-0.04	-16.64	4.00
75.00	10.00	-6.87	-0.54	-5.14	0.96	4.00	75.00	10.00	0.89	-14.62	-1.79	-25.31	4.00
75.00	20.00	-10.70	-0.57	-8.04	-3.05	4.00	75.00	20.00	-0.24	-7.83	-0.59	-20.70	4.00
75.00	30.00	-8.98	0.63	-8.09	-5.39	4.00	75.00	30.00	-1.79	-5.15	-2.02	-19.55	4.00
75.00	40.00	-9.21	-1.49	-6.2	-11.45	4.00	75.00	40.00	-5.60	-6.03	-3.23	-16.23	4.00
75.00	50.00	-9.96	-7.60	-6.2	-11.85	4.00	75.00	50.00	-7.52	-6.62	-3.6	-22.49	4.00
75.00	60.00	-13.39	-20.35	-7.59	-10.09	4.00	75.00	60.00	-5.10	-5.1	-5.5	-14.24	4.00
75.00	70.00	-19.8	-17.33	-4.63	-9.32	4.00	75.00	70.00	-8.15	-7.12	-6.05	-21.71	4.00
75.00	80.00	-19.6	-12.80	-6.64	-7.42	4.00	75.00	80.00	-8.62	-1.17	-8.69	-21.08	4.00
75.00	90.00	-10.51	-14.35	-3.67	-13.68	4.00	75.00	90.00	-15.56	1.17	-12.26	-21.85	4.00
75.00	100.00	-10.1	-12.22	-5.38	-11.47	4.00	75.00	100.00	-11.52	-2.50	-7.77	-30.14	4.00
75.00	110.00	-15.09	-13.85	-14.47	-11.75	4.00	75.00	110.00	-7.69	-4.51	-8.43	-15.27	4.00
75.00	120.00	-16.49	-27.34	-13.23	-8.22	4.00	75.00	120.00	-5.81	-0.15	-12.43	-12.73	4.00
75.00	130.00	-18.50	-19.37	-10.49	-6.19	4.00	75.00	130.00	-4.61	-2.18	-13.07	-6.43	4.00
75.00	140.00	-13.15	-7.54	-8.26	-4.14	4.00	75.00	140.00	-3.37	-7.09	-7.08	-6.58	4.00
75.00	150.00	-13.82	-6.51	-12.15	-2.14	4.00	75.00	150.00	-1.81	-4.81	-13.27	-9.41	4.00
75.00	160.00	-12.91	-12.68	-5.78	-0.59	4.00	75.00	160.00	-1.15	-8.02	-13.75	-10.13	4.00
75.00	170.00	-10.09	-17.41	-7.26	0.72	4.00	75.00	170.00	0.91	-5.15	-9.33	-12.04	4.00
75.00	180.00	-11.27	-17.42	-2.11	2.60	4.00	75.00	180.00	1.59	-12.32	-7.16	-13.17	4.00
75.00	190.00	-6.93	-9.43	-2.94	2.72	4.00	75.00	190.00	1.43	-9.87	-3.69	-19.48	4.00
75.00	200.00	-6.00	-8.91	-3.22	1.90	4.00	75.00	200.00	0.01	-27.07	-6.45	-25.34	4.00
75.00	210.00	-8.13	-13.40	-2.25	1.16	4.00	75.00	210.00	0.42	-11.15	-4.87	-17.33	4.00
75.00	220.00	-8.27	-14.65	-4.51	-1.83	4.00	75.00	220.00	-1.93	-8.48	-5.51	-17.30	4.00
75.00	230.00	-3.95	-13.06	-4.38	-4.46	4.00	75.00	230.00	-3.98	-2.82	-5.43	-14.93	4.00
75.00	240.00	-3.32	-10.74	-2.69	-2.27	4.00	75.00	240.00	-3.40	-5.44	-4.99	-15.77	4.00
75.00	250.00	-3.98	-6.20	-2.73	-1.88	4.00	75.00	250.00	-5.88	-2.60	-7.59	-13.09	4.00
75.00	260.00	-7.27	-8.81	-2.40	0.34	4.00	75.00	260.00	-11.46	1.61	-11.50	-15.61	4.00
75.00	270.00	-9.69	-11.08	-3.30	0.63	4.00	75.00	270.00	-16.62	2.21	-15.19	-15.99	4.00
75.00	280.00	-10.69	-2.87	-2.76	-2.92	4.00	75.00	280.00	-9.13	-6.57	-7.13	-22.17	4.00
75.00	290.00	-8.74	-9.05	-6.47	2.09	4.00	75.00	290.00	-8.19	-2.96	-4.53	-23.22	4.00
75.00	300.00	-6.03	-8.81	-5.09	2.00	4.00	75.00	300.00	-6.98	-6.33	-0.90	-15.61	4.00
75.00	310.00	-5.68	-7.58	-3.28	0.44	4.00	75.00	310.00	-6.22	-2.21	-0.60	-0.89	4.00
75.00	320.00	-12.51	-3.79	-4.70	0.15	4.00	75.00	320.00	-3.25	1.60	-0.18	-13.63	4.00
75.00	330.00	-9.06	-1.35	-2.00	0.98	4.00	75.00	330.00	-0.23	-0.18	1.60	-11.52	4.00
75.00	340.00	-7.86	-3.96	-3.45	2.76	4.00	75.00	340.00	-0.21	-9.35	0.94	-13.97	4.00
75.00	350.00	-12.64	-2.28	-2.69	3.48	4.00	75.00	350.00					



105.00	100.00	-11.05	-20.16	-8.66	-21.10	4.00	105.00	100.00	-15	-6.04	-15.07	-18.28	4.00	-9.58	-5.87	-7.77	-16.45	4.00	-3.10	-8.55
105.00	110.00	-18.14	-15.76	-17.40	-23.04	4.00	105.00	110.00	-15.34	-19.91	-11.69	-8.43	4.00	-13.51	-14.35	-10.66	-8.28	4.00	-5.34	-11.03
105.00	120.00	-10.49	-32.74	-11.02	-7.81	4.00	105.00	120.00	-16.03	-15.43	-11.69	-7.17	4.00	-9.42	-15.35	-9.61	-4.47	4.00	-2.87	-8.17
105.00	130.00	-12.43	-14.93	-15.46	-1.71	4.00	105.00	130.00	-7.76	-8.66	-19.40	-10.63	4.00	-6.49	-7.74	-13.99	-1.19	4.00	-0.19	-5.25
105.00	140.00	-14.24	-8.70	-18.12	0.13	4.00	105.00	140.00	-15.53	-8.74	-21.41	-14.75	4.00	-11.83	-5.71	-16.45	0.27	4.00	-0.19	-4.50
105.00	150.00	-9.80	-2.29	-8.23	-0.84	4.00	105.00	150.00	-7.13	-4.70	-9.26	-12.05	4.00	-5.25	-0.32	-5.70	-0.52	4.00	3.44	-2.25
105.00	160.00	-11.40	-5.51	-7.58	1.40	4.00	105.00	160.00	-1.99	-8.05	-8.35	-18.11	4.00	-1.52	-3.99	-4.94	1.45	4.00	4.21	-1.46
105.00	170.00	-12.17	-5.24	-8.97	2.58	4.00	105.00	170.00	-2.77	-14.05	-8.88	-15.62	4.00	-2.30	-4.70	-5.91	2.65	4.00	4.11	-1.22
105.00	180.00	-19.15	-10.07	-5.26	3.86	4.00	105.00	180.00	-4.33	-16.68	-12.53	-16.11	4.00	-4.19	-9.21	-4.51	3.90	4.00	3.88	-0.82
105.00	190.00	-10.98	-10.00	-5.50	5.24	4.00	105.00	190.00	-2.39	-14.11	-11.08	-19.18	4.00	-1.83	-8.58	-4.44	5.26	4.00	5.14	0.52
105.00	200.00	-11.56	-11.44	-5.55	4.49	4.00	105.00	200.00	-3.77	-12.26	-4.94	-13.95	4.00	-3.10	-8.82	-2.29	4.55	4.00	4.92	0.08
105.00	210.00	-13.52	-14.48	-4.04	3.70	4.00	105.00	210.00	-5.69	-6.23	-4.92	-15.95	4.00	-5.02	-3.34	-1.45	3.75	4.00	5.17	-0.15
105.00	220.00	-12.43	-13.35	-3.55	1.73	4.00	105.00	220.00	-6.69	-10.18	-7.01	-21.18	4.00	-5.66	-8.47	-1.93	1.75	4.00	3.29	1.95
105.00	230.00	-11.72	-7.11	-3.46	-0.96	4.00	105.00	230.00	-8.78	-9.19	-4.54	-19.09	4.00	-6.00	-5.02	-0.96	-0.90	4.00	2.94	-2.74
105.00	240.00	-9.95	-11.97	-2.69	-3.62	4.00	105.00	240.00	-10.64	-12.75	-6.89	-25.38	4.00	-7.27	-9.33	-1.29	-3.59	4.00	1.21	-4.31
105.00	250.00	-8.05	-17.06	-3.25	-2.18	4.00	105.00	250.00	-9.66	-21.87	-12.37	-29.64	4.00	-5.85	-15.82	-2.75	-2.17	4.00	0.75	-4.49
105.00	260.00	-9.66	-15.88	-1.93	1.08	4.00	105.00	260.00	-10.94	-12.09	-18.71	-27.59	4.00	-7.24	-10.57	-1.84	1.09	4.00	2.52	-2.57
105.00	270.00	-8.78	-16.62	-1.80	2.64	4.00	105.00	270.00	-11.10	-16.57	-11.71	-20.27	4.00	-6.78	-13.58	-1.38	2.66	4.00	3.17	-1.51
105.00	280.00	-10.09	-35.57	-0.94	3.57	4.00	105.00	280.00	-10.39	-18.20	-6.35	-26.42	4.00	-7.23	-18.12	0.16	3.57	4.00	3.77	-0.56
105.00	290.00	-13.51	-15.56	-0.43	3.39	4.00	105.00	290.00	-8.48	-20.42	-2.01	-12.24	4.00	-7.29	-14.33	1.86	3.51	4.00	4.51	0.00
105.00	300.00	-11.50	-9.41	-1.59	3.35	4.00	105.00	300.00	-5.49	-14.68	-1.28	-13.08	4.00	-4.52	-8.28	1.58	3.45	4.00	5.26	0.16
105.00	310.00	-6.28	-5.39	-2.85	2.82	4.00	105.00	310.00	-5.42	-14.55	0.62	-12.02	4.00	-2.82	-4.89	2.23	2.96	4.00	6.00	0.51
105.00	320.00	-6.11	-2.92	-5.20	0.32	4.00	105.00	320.00	-4.64	-6.51	0.18	-17.45	4.00	-2.30	-1.34	1.29	0.39	4.00	5.64	-0.27
105.00	330.00	-10.61	-6.13	-3.16	-3.66	4.00	105.00	330.00	-3.90	-6.30	-0.44	-15.89	4.00	-3.06	-3.20	1.42	-3.41	4.00	4.21	-1.53
105.00	340.00	-16.54	-5.56	-4.08	-0.50	4.00	105.00	340.00	-5.97	-7.61	0.23	-9.72	4.00	-5.60	-3.45	1.60	-0.01	4.00	4.60	-1.01
105.00	350.00	-13.73	-4.58	-11.83	1.39	4.00	105.00	350.00	-3.29	-6.30	-1.15	-10.26	4.00	-2.91	-2.35	-0.79	1.68	4.00	5.12	-0.71
120.00	0.00	-19.98	-2.39	-14.31	-0.50	4.00	120.00	0.00	-2.29	-13.58	-3.41	-12.88	4.00	-2.22	-2.07	-3.07	-0.26	4.00	4.18	-1.78
120.00	10.00	-11.41	-2.26	-14.14	-0.23	4.00	120.00	10.00	-4.16	-5.89	-3.44	-8.28	4.00	-3.41	-0.70	-3.09	4.00	4.47	-1.40	-1.78
120.00	20.00	-12.00	-5.28	-19.94	-2.84	4.00	120.00	20.00	-3.28	-13.22	-9.83	-15.09	4.00	-2.73	-4.63	-9.43	-2.59	4.00	1.57	-4.14
120.00	30.00	-11.40	-12.19	-17.17	-7.43	4.00	120.00	30.00	-10.08	-6.15	-9.38	-28.14	4.00	-7.68	-3.18	-7.54	-7.39	4.00	-0.87	-6.82
120.00	40.00	-6.09	-4.61	-25.59	-10.47	4.00	120.00	40.00	-11.64	-0.35	-8.99	-7.04	4.00	-5.02	1.03	-8.90	-5.41	4.00	2.22	-3.01
120.00	50.00	-7.74	-10.01	-7.81	-12.16	4.00	120.00	50.00	-28.33	-4.37	-12.20	-5.58	4.00	-7.70	0.08	-6.46	-0.37	4.00	1.86	-3.59
120.00	60.00	-4.88	-14.40	-12.77	-17.25	4.00	120.00	60.00	-8.51	-2.72	-11.42	-8.40	4.00	-3.32	-2.43	-9.03	-7.87	4.00	0.81	-4.80
120.00	70.00	-7.52	-9.67	-10.53	-21.30	4.00	120.00	70.00	-10.88	-7.87	-13.90	-12.37	4.00	-5.87	-5.67	-8.89	-11.85	4.00	-1.70	-7.42
120.00	80.00	-9.03	-9.42	-15.70	-8.21	4.00	120.00	80.00	-28.21	-1.24	-21.16	-15.69	4.00	-8.98	-0.63	-16.72	-12.68	4.00	-1.60	-5.74
120.00	90.00	-22.35	-11.66	-21.04	-14.03	4.00	120.00	90.00	-13.16	-6.28	-11.61	-10.92	4.00	-12.67	-5.17	-11.14	-9.19	4.00	-3.60	-8.58
120.00	100.00	-18.33	-13.83	-19.72	-16.12	4.00	120.00	100.00	-12.69	-15.48	-7.71	-9.44	4.00	-11.64	-11.57	-7.44	-8.60	4.00	-3.60	-9.43
120.00	110.00	-12.42	-18.36	-12.10	-11.17	4.00	120.00	110.00	-12.44	-11.36	-7.06	-13.24	4.00	-9.42	-10.57	-5.88	-9.07	4.00	-2.53	-8.35
120.00	120.00	-10.32	-19.41	-9.33	-9.52	4.00	120.00	120.00	-8.42	-4.10	-12.22	-23.16	4.00	-6.26	-3.97	-7.53	-9.34	4.00	-0.53	-6.33
120.00	130.00	-7.36	-16.72	-12.05	-3.55	4.00	120.00	130.00	-9.82	-19.49	-17.18	-17.68	4.00	-5.41	-14.88	-10.89	-3.39	4.00	-1.52	-6.67
120.00	140.00	-20.97	-2.51	-10.86	-5.42	4.00	120.00	140.00	-11.14	-1.19	-9.29	-24.62	4.00	-10.71	1.21	-6.99	-5.37	4.00	1.68	-3.24
120.00	150.00	-14.80	-1.12	-13.01	-2.29	4.00	120.00	150.00	-8.05	-6.49	-21.08	-23.36	4.00	-7.22	-0.01	-12.38	-2.26	4.00	1.75	-3.37
120.00	160.00	-19.51	-7.57	-8.60	-0.42	4.00	120.00	160.00	-14.89	-11.24	-12.39	-12.19	4.00	-13.60	-6.02	-14.89	-0.14	4.00	0.57	-4.38
120.00	170.00	-25.78	-14.20	-11.76	0.76	4.00	120.00	170.00	-15.22	-9.32	-17.20	-13.94	4.00	-14.85	-8.10	-10.67	0.90	4.00	-0.10	-4.25
120.00	180.00	-17.60	-8.48	-8.19	3.18	4.00	120.00	180.00	-4.52	-10.56	-13.79	-19.22	4.00	-4.31	-6.39	-7.13	3.20	4.00	3.45	-1.42
120.00	190.00	-11.36	-7.38	-5.73	2.71	4.00	120.00	190.00	-2.77	-10.14	-9.92	-13.90	4.00	-2.21	-5.53	-4.33	2.75	4.00	4.31	-1.06
120.00	200.00	-7.96	-11.20	-5.06	2.68	4.00	120.00	200.00	-8.28	-14.45	-10.14	-17.71	4.00	-5.11	-9.52	-3.89	2.78	4.00	3.25	-1.67
120.00	210.00	-15.93	-3.73	-4.38	1.78	4.00	120.00	210.00	-15.66	-11.71	-6.06	-16.74	4.00	-12.78	-3.09	-2.13	1.84	4.00	3.37	-1.73
120.00	220.00	-43.83	-10.82	-4.49	0.70	4.00	120.00	220.00	-11.58	-12.93	-7.00	-12.74	4.00	-11.58	-8.74	-2.56	0.89	4.00	1.88	-3.04
120.00	230.00	-17.93	-9.48	-4.02	-1.89	4.00	120.00	230.00	-29.06	-4.88	-6.11	-11.67	4.00	-17.61	-3.59	-1.93	-1.46	4.00	1.73	-3.44
120.00	240.00	-12.57	-11.81	-4.91	-4.43	4.00	120.00	240.00	-19.46	-5.78	-8.30	-21.92	4.00	-11.76	-4.81	-3.27	-4.35	4.00	0.53	-5.11
120.00	250.00	-12.49	-9.69	-2.70	-3.02	4.00	120.00	250.00	-17.20	-8.80	-11.73	-13.64	4.00	-11.23	-6.21	-2.19	-2.66	4.00	1.13	-4.37
120.00	260.00	-12.12	-13.40	-1.84	-0.02	4.00	120.00	260.00	-9.96	-6.29	-18.47	-10.11	4.00	-7.90	-5.52	-1.75	0.39	4.00	2.91	-2.59
120.00	270.00	-13.77	-18.16	-1.22	2.53	4.00	120.00	270.00	-9.93	-3.66	-25.35	-13.04	4.00	-8.43	-3.51	-1.20	2.65	4.00	4.28	-0.99
120.00	280.00	-12.25	-12.57	-0.96	3.08	4.00	120.00	280.00	-9.66	-12.57	-7.74	-7.59	4.00	-7.75	-4.86	-0.13	3.44	4.00	4.74	-0.37
120.00	290.00	-10.74	-6.78	-1.33	3.47	4.00	120.00	290.00	-8.59	-6.57	-5.16	-10.18	4.00	-6.52	-3.81	0.17	3.65	4.00	5.25	0.00
120.00	300.00	-9.17	-4.45	-2.96	3.38	4.00	120.00	300.00	-6.27	-8.65	-2.22	-6.92	4.00	-4.47	-3.05	0.44	3.63	4.00	5.74	-0.28
120.00	310.00	-9.26	-5.74	-2.87	1.16	4.00	120.00	310.00	-3.49	-4.83	-1.58	-12.80	4.00	-2.47	-2.25	0.83	1.81	4.00	5.70	0.12
120.00	320.00	-10.61	-8.27	-4.97	-2.00	4.00	120.00	320.00	-4.58	-3.69	-0.35	-20.81	4.00	-3.62	-2.93	0.43	-1.97	4.00	4.26	-1.63
120.00	330.00	-11.04	-6.45	-6.92	-8.76	4.00	120.00	330.00	-2.67	-10.33	-1.46	-18.03	4.00	-2.06	-4.96					



165.00	10.00	-20.79	-0.95	-9.63	-8.74	4.00	165.00	10.00	-8.03	-5.61	-5.98	-8.84	4.00
165.00	20.00	-23.59	-15.39	-14.39	-18.77	4.00	165.00	20.00	-6.21	-7.53	-7.31	-10.29	4.00
165.00	30.00	-32.09	-7.79	-11.56	-22.08	4.00	165.00	30.00	-5.76	-24.05	-11.07	-9.16	4.00
165.00	40.00	-16.85	-8.02	-10.42	-31.20	4.00	165.00	40.00	-8.50	-14.45	-8.19	-9.75	4.00
165.00	50.00	-16.10	-8.45	-8.69	-22.36	4.00	165.00	50.00	-12.45	-8.69	-7.03	-9.92	4.00
165.00	60.00	-12.98	-12.56	-7.17	-15.67	4.00	165.00	60.00	-19.69	-6.89	-7.40	-9.37	4.00
165.00	70.00	-11.14	-31.68	-9.35	-17.01	4.00	165.00	70.00	-16.88	-4.56	-8.67	-9.80	4.00
165.00	80.00	-14.98	-17.84	-9.90	-27.33	4.00	165.00	80.00	-17.27	-1.81	-10.18	-13.64	4.00
165.00	90.00	-14.41	-12.69	-11.72	-26.92	4.00	165.00	90.00	-19.78	-1.25	-12.33	-18.53	4.00
165.00	100.00	-13.20	-9.04	-19.26	-13.89	4.00	165.00	100.00	-30.74	-2.05	-18.77	-13.94	4.00
165.00	110.00	-18.20	-6.73	-19.75	-13.74	4.00	165.00	110.00	-18.52	-3.23	-22.96	-22.10	4.00
165.00	120.00	-26.22	-6.13	-20.78	-10.71	4.00	165.00	120.00	-14.80	-6.96	-12.86	-27.57	4.00
165.00	130.00	-13.61	-5.27	-12.62	-12.18	4.00	165.00	130.00	-20.42	-14.48	-14.06	-27.25	4.00
165.00	140.00	-11.96	-9.94	-11.19	-9.93	4.00	165.00	140.00	-26.01	-9.74	-13.49	-20.09	4.00
165.00	150.00	-12.46	-14.48	-7.26	-12.88	4.00	165.00	150.00	-28.42	-10.00	-17.86	-18.59	4.00
165.00	160.00	-20.10	-6.14	-8.35	-15.76	4.00	165.00	160.00	-22.65	-10.99	-21.30	-11.43	4.00
165.00	170.00	-21.80	-5.61	-10.98	-16.14	4.00	165.00	170.00	-21.22	-19.91	-22.97	-7.89	4.00
165.00	180.00	-15.57	-6.68	-16.75	-15.64	4.00	165.00	180.00	-19.16	-17.49	-14.57	-10.68	4.00
165.00	190.00	-13.45	-5.74	-28.10	-19.89	4.00	165.00	190.00	-23.09	-8.74	-13.18	-12.92	4.00
165.00	200.00	-20.96	-6.31	-23.29	-17.39	4.00	165.00	200.00	-23.22	-6.17	-15.92	-13.70	4.00
165.00	210.00	-21.28	-7.28	-19.76	-13.54	4.00	165.00	210.00	-20.34	-4.27	-15.41	-11.60	4.00
165.00	220.00	-18.29	-7.68	-19.53	-18.51	4.00	165.00	220.00	-24.28	-1.88	-12.45	-13.56	4.00
165.00	230.00	-38.32	-5.35	-14.39	-27.93	4.00	165.00	230.00	-16.47	-2.07	-10.49	-12.44	4.00
165.00	240.00	-18.63	-8.52	-14.24	-15.62	4.00	165.00	240.00	-12.15	-1.65	-8.76	-12.80	4.00
165.00	250.00	-10.21	-13.61	-11.95	-19.58	4.00	165.00	250.00	-32.50	-1.53	-9.86	-9.19	4.00
165.00	260.00	-5.71	-14.18	-10.56	-12.22	4.00	165.00	260.00	-20.04	-4.17	-7.16	-7.83	4.00
165.00	270.00	-5.10	-12.50	-15.68	-13.15	4.00	165.00	270.00	-14.45	-5.63	-7.14	-5.72	4.00
165.00	280.00	-3.39	-14.01	-14.92	-12.24	4.00	165.00	280.00	-9.50	-8.66	-5.77	-5.36	4.00
165.00	290.00	-2.56	-13.90	-13.93	-12.51	4.00	165.00	290.00	-10.06	-8.43	-5.18	-5.26	4.00
165.00	300.00	-2.71	-6.43	-11.12	-7.77	4.00	165.00	300.00	-15.90	-8.68	-6.56	-3.22	4.00
165.00	310.00	-2.18	-2.50	-17.31	-5.80	4.00	165.00	310.00	-10.74	-10.65	-4.51	-6.02	4.00
165.00	320.00	-3.35	0.34	-22.82	-4.02	4.00	165.00	320.00	-9.12	-6.67	-4.27	-3.57	4.00
165.00	330.00	-4.85	2.82	-13.61	-3.18	4.00	165.00	330.00	-8.76	-8.80	-5.76	-5.52	4.00
165.00	340.00	-6.23	3.63	-12.40	-3.90	4.00	165.00	340.00	-8.66	-15.64	-6.88	-6.74	4.00
165.00	350.00	-15.64	4.23	-9.30	-3.46	4.00	165.00	350.00	-8.00	-15.88	-8.05	-6.01	4.00
180.00	0.00	-22.34	-5.56	-14.60	-7.29	4.00	180.00	0.00	-7.23	-31.19	-13.22	-14.94	4.00
180.00	10.00	-16.43	-5.61	-13.10	-6.81	4.00	180.00	10.00	-7.63	-23.83	-14.77	-19.89	4.00
180.00	20.00	-13.13	-5.94	-12.05	-6.61	4.00	180.00	20.00	-8.34	-16.23	-16.99	-33.78	4.00
180.00	30.00	-10.94	-6.55	-11.36	-6.67	4.00	180.00	30.00	-9.40	-12.41	-20.37	-24.29	4.00
180.00	40.00	-9.41	-7.50	-10.97	-7.01	4.00	180.00	40.00	-10.92	-9.96	-26.48	-17.04	4.00
180.00	50.00	-8.35	-8.87	-10.85	-7.64	4.00	180.00	50.00	-13.10	-8.27	-50.85	-13.31	4.00
180.00	60.00	-7.64	-10.83	-10.99	-8.61	4.00	180.00	60.00	-7.23	-13.71	-11.41	-10.00	4.00
180.00	70.00	-7.23	-13.71	-11.41	-11.99	4.00	180.00	70.00	-22.26	-6.27	-19.97	-9.25	4.00
180.00	80.00	-7.09	-18.51	-12.14	-11.99	4.00	180.00	80.00	-47.09	-5.77	-16.74	-8.08	4.00
180.00	90.00	-7.23	-31.19	-13.22	-14.94	4.00	180.00	90.00	-22.34	-5.56	-14.60	-7.29	4.00
180.00	100.00	-7.63	-23.83	-14.77	-19.89	4.00	180.00	100.00	-16.43	-5.61	-13.10	-6.81	4.00
180.00	110.00	-8.34	-16.23	-16.99	-33.78	4.00	180.00	110.00	-13.13	-5.94	-12.05	-6.61	4.00
180.00	120.00	-9.40	-12.41	-20.37	-24.29	4.00	180.00	120.00	-10.94	-6.55	-11.36	-6.67	4.00
180.00	130.00	-10.92	-9.96	-26.48	-17.04	4.00	180.00	130.00	-9.41	-7.50	-10.97	-7.01	4.00
180.00	140.00	-13.10	-8.27	-50.85	-13.31	4.00	180.00	140.00	-8.35	-8.87	-10.85	-7.64	4.00
180.00	150.00	-16.39	-7.08	-25.65	-10.91	4.00	180.00	150.00	-7.64	-10.83	-10.99	-8.61	4.00
180.00	160.00	-22.26	-6.27	-19.97	-9.25	4.00	180.00	160.00	-7.23	-13.71	-11.41	-10.00	4.00
180.00	170.00	-47.09	-5.77	-16.74	-8.08	4.00	180.00	170.00	-7.09	-18.51	-12.14	-11.99	4.00
180.00	180.00	-22.34	-5.56	-14.60	-7.29	4.00	180.00	180.00	-7.23	-31.19	-13.22	-14.94	4.00
180.00	190.00	-16.43	-5.61	-13.10	-6.81	4.00	180.00	190.00	-7.63	-23.83	-14.77	-19.89	4.00
180.00	200.00	-13.13	-5.94	-12.05	-6.61	4.00	180.00	200.00	-8.34	-16.23	-16.99	-33.78	4.00
180.00	210.00	-10.94	-6.55	-11.36	-6.67	4.00	180.00	210.00	-9.40	-12.41	-20.37	-24.29	4.00
180.00	220.00	-9.41	-7.50	-10.97	-7.01	4.00	180.00	220.00	-10.92	-9.96	-26.48	-17.04	4.00
180.00	230.00	-8.35	-8.87	-10.85	-7.64	4.00	180.00	230.00	-13.10	-8.27	-50.85	-13.31	4.00
180.00	240.00	-7.64	-10.83	-10.99	-8.61	4.00	180.00	240.00	-7.08	-25.65	-10.91	-8.61	4.00
180.00	250.00	-7.23	-13.71	-11.41	-11.99	4.00	180.00	250.00	-22.26	-6.27	-19.97	-9.25	4.00
180.00	260.00	-7.09	-18.51	-12.14	-11.99	4.00	180.00	260.00	-47.09	-5.77	-16.74	-8.08	4.00
180.00	270.00	-7.23	-31.19	-13.22	-14.94	4.00	180.00	270.00	-22.34	-5.56	-14.60	-7.29	4.00
180.00	280.00	-7.63	-23.83	-14.77	-19.89	4.00	180.00	280.00	-16.43	-5.61	-13.10	-6.81	4.00
180.00	290.00	-8.34	-16.23	-16.99	-33.78	4.00	180.00	290.00	-13.13	-5.94	-12.05	-6.61	4.00
180.00	300.00	-9.40	-12.41	-20.37	-24.29	4.00	180.00	300.00	-10.94	-6.55	-11.36	-6.67	4.00
180.00	310.00	-10.92	-9.96	-26.48	-17.04	4.00	180.00	310.00	-9.41	-7.50	-10.97	-7.01	4.00
180.00	320.00	-13.10	-8.27	-50.85	-13.31	4.00	180.00	320.00	-8.35	-8.87	-10.85	-7.64	4.00
180.00	330.00	-16.39	-7.08	-25.65	-10.91	4.00	180.00	330.00	-7.64	-10.83	-10.99	-8.61	4.00
180.00	340.00	-22.26	-6.27	-19.97	-9.25	4.00	180.00	340.00	-7.23	-13.71	-11.41	-10.00	4.00
180.00	350.00	-47.09	-5.77	-16.74	-8.08	4.00	180.00	350.00	-7.09	-18.51	-12.14	-11.99	4.00

-7.81	0.33	-4.42	-5.78	4.00	2.15	-3.30	-6.13	-6.87	-6.53	-9.71	4.00	-1.18	-7.11
-5.75	-7.69	-8.30	-8.94	4.00	-1.56	-7.50	-7.91	-7.13	-6.15	-9.72	4.00	-1.61	-7.54
-10.89	-5.56	-4.77	-9.68	4.00	-1.32	-6.99	-12.14	-5.85	-4.27	-8.46	4.00	-1.18	-6.79
-10.11	-4.55	-5.99	-9.04	4.00	-1.11	-6.86	-12.97	-1.70	-7.03	-13.46	4.00	-1.39	-6.16
-13.30	-0.95	-9.00	-17.94	4.00	-1.97	-6.05	-13.12	-1.26	-16.00	-10.90	4.00	-2.33	-6.46
-15.35	-1.63	-18.05	-13.15	4.00	-3.44	-7.09	-14.50	-3.51	-12.21	-10.62	4.00	-3.13	-8.04
-12.79	-4.78	-10.27	-12.05	4.00	-3.33	-8.68	-11.79	-6.83	-9.18	-9.53	4.00	-3.13	-8.98
-12.35	-8.68	-6.90	-11.85	4.00	-3.63	-9.36	-18.18	-4.91	-8.14	-10.07	4.00	-3.11	-8.31
-18.49	-5.45	-10.71	-7.28	4.00	-3.25	-8.46	-13.99	-6.33	-12.51	-9.48	4.00	-4.05	-9.57
-13.00	-3.98	-13.04	-12.12	4.00	-3.56	-8.53	-18.93	-3.23	-15.19	-12.15	4.00	-4.27	-8.39
-17.77	-2.51	-14.05	-9.45	4.00	-3.01	-7.38	-17.31	-0.87	-11.67	-12.35	4.00	-2.25	-6.18
-16.44	-0.40	-9.01	-12.32	4.00	-1.40	-5.53	-11.27	-0.84	-7.68	-10.97	4.00	-0.55	-5.41
-10.18	-1.27	-7.77	-8.81	4.00	-0.24	-5.45	-5.55	-3.76	-5.53	-6.48	4.00	0.75	-5.21
-4.62	-4.82	-6.57	-5.00	4.00	0.80	-5.19	-2.44	-7.55	-5.27	-8.65	4.00	1.26	-4.58
-1.85	-7.35	-4.64	-4.51	4.00	1.65	-4.16	-2.51	-4.40	-5.26	-1.91	4.00	2.61	-3.31
-1.61	-1.88	-4.29	-2.90	4.00	3.41	-2.55	-2.33	1.13	-4.21	-0.78	4.00		



Frequency: 6995MHz

Theta Polarization		Max Gain(dBi)				Nant	Phi Polarization		Max Gain(dBi)				Nant	Total				Max DG(dBi)	Max DG(dBi)			
Angle (θ)	Angle (ψ)	Ant 1(G1)	Ant 2(G2)	Ant 3(G3)	Ant 4(G4)		Angle (θ)	Angle (ψ)	Ant 1(G1)	Ant 2(G2)	Ant 3(G3)	Ant 4(G4)		Ant 1(G1)	Ant 2(G2)	Ant 3(G3)	Ant 4(G4)			Nant	g1k	g2k
		2.33	3.21	1.73	4.76				3.43	4.21	3.47	-2.30										
		Ant 1(G1)	Ant 2(G2)	Ant 3(G3)	Ant 4(G4)			Ant 1(G1)	Ant 2(G2)	Ant 3(G3)	Ant 4(G4)											
0.00	0.00	-13.90	2.62	-16.63	-7.50	4.00	0.00	0.00	2.23	-8.17	-0.93	-11.42	4.00	2.33	2.97	-0.81	-6.02	4.00	6.29	0.77		
0.00	10.00	-7.47	2.92	-10.43	-6.71	4.00	0.00	10.00	1.85	-16.48	-1.32	-14.37	4.00	2.33	2.97	-0.81	-6.02	4.00	6.29	0.76		
0.00	20.00	-3.99	2.95	-7.02	-6.23	4.00	0.00	20.00	1.18	-20.42	-2.00	-19.32	4.00	2.33	2.97	-0.81	-6.02	4.00	6.29	0.77		
0.00	30.00	-1.71	2.71	-4.78	-6.03	4.00	0.00	30.00	0.16	-9.43	-3.04	-33.26	4.00	2.34	2.97	-0.81	-6.02	4.00	6.29	0.77		
0.00	40.00	-0.13	2.19	-3.22	-6.10	4.00	0.00	40.00	-1.31	-4.89	-4.53	-23.70	4.00	2.33	2.97	-0.82	-6.03	4.00	6.29	0.76		
0.00	50.00	0.98	1.35	-2.12	-6.44	4.00	0.00	50.00	-3.40	-2.11	-6.66	-16.46	4.00	2.33	2.97	-0.81	-6.03	4.00	6.29	0.76		
0.00	60.00	1.73	0.12	-1.39	-7.07	4.00	0.00	60.00	-6.53	-0.22	-9.85	-12.73	4.00	2.33	2.96	-0.81	-6.03	4.00	6.29	0.76		
0.00	70.00	2.17	-1.63	-0.97	-8.04	4.00	0.00	70.00	-11.96	1.11	-15.45	-10.33	4.00	2.33	2.96	-0.82	-6.03	4.00	6.29	0.76		
0.00	80.00	2.33	-4.16	-0.81	-9.43	4.00	0.00	80.00	-31.82	2.03	-39.23	-8.67	4.00	2.33	2.97	-0.81	-6.02	4.00	6.29	0.76		
0.00	90.00	2.23	-8.17	-0.93	-11.42	4.00	0.00	90.00	-13.90	2.62	-16.63	-7.50	4.00	2.33	2.97	-0.81	-6.02	4.00	6.29	0.77		
0.00	100.00	1.85	-16.48	-1.32	-14.37	4.00	0.00	100.00	-7.47	2.92	-10.43	-6.71	4.00	2.33	2.97	-0.82	-6.02	4.00	6.29	0.76		
0.00	110.00	1.18	-20.42	-2.00	-19.32	4.00	0.00	110.00	-3.99	2.95	-7.02	-6.23	4.00	2.33	2.97	-0.81	-6.02	4.00	6.29	0.77		
0.00	120.00	0.16	-9.43	-3.04	-33.26	4.00	0.00	120.00	-1.71	2.71	-4.78	-6.03	4.00	2.34	2.97	-0.81	-6.02	4.00	6.29	0.77		
0.00	130.00	-1.31	-4.89	-4.53	-23.70	4.00	0.00	130.00	-0.13	2.19	-3.22	-6.10	4.00	2.33	2.97	-0.82	-6.03	4.00	6.29	0.76		
0.00	140.00	-3.40	-2.11	-6.66	-16.46	4.00	0.00	140.00	0.98	1.35	-2.12	-6.44	4.00	2.33	2.97	-0.81	-6.03	4.00	6.29	0.76		
0.00	150.00	-6.53	-0.22	-9.85	-12.73	4.00	0.00	150.00	1.73	0.12	-1.39	-7.07	4.00	2.33	2.96	-0.81	-6.03	4.00	6.29	0.76		
0.00	160.00	-11.96	1.11	-15.45	-10.33	4.00	0.00	160.00	2.17	-1.63	-0.97	-8.04	4.00	2.33	2.96	-0.82	-6.03	4.00	6.29	0.76		
0.00	170.00	-31.82	2.03	-39.23	-8.67	4.00	0.00	170.00	2.33	-4.16	-0.81	-9.43	4.00	2.33	2.97	-0.81	-6.02	4.00	6.29	0.76		
0.00	180.00	-13.90	2.62	-16.63	-7.50	4.00	0.00	180.00	2.23	-8.17	-0.93	-11.42	4.00	2.33	2.97	-0.81	-6.02	4.00	6.29	0.77		
0.00	190.00	-7.47	2.92	-10.43	-6.71	4.00	0.00	190.00	1.85	-16.48	-1.32	-14.37	4.00	2.33	2.97	-0.82	-6.03	4.00	6.29	0.76		
0.00	200.00	-3.99	2.95	-7.02	-6.23	4.00	0.00	200.00	1.18	-20.42	-2.00	-19.32	4.00	2.33	2.97	-0.81	-6.02	4.00	6.29	0.77		
0.00	210.00	-1.71	2.71	-4.78	-6.03	4.00	0.00	210.00	0.16	-9.43	-3.04	-33.26	4.00	2.34	2.97	-0.81	-6.02	4.00	6.29	0.77		
0.00	220.00	-0.13	2.19	-3.22	-6.10	4.00	0.00	220.00	-1.31	-4.89	-4.53	-23.70	4.00	2.33	2.97	-0.82	-6.03	4.00	6.29	0.76		
0.00	230.00	0.98	1.35	-2.12	-6.44	4.00	0.00	230.00	-3.40	-2.11	-6.66	-16.46	4.00	2.33	2.97	-0.81	-6.03	4.00	6.29	0.76		
0.00	240.00	1.73	0.12	-1.39	-7.07	4.00	0.00	240.00	-6.53	-0.22	-9.85	-12.73	4.00	2.33	2.96	-0.81	-6.03	4.00	6.29	0.76		
0.00	250.00	2.17	-1.63	-0.97	-8.04	4.00	0.00	250.00	-11.96	1.11	-15.45	-10.33	4.00	2.33	2.96	-0.82	-6.03	4.00	6.29	0.76		
0.00	260.00	2.33	-4.16	-0.81	-9.43	4.00	0.00	260.00	-31.82	2.03	-39.23	-8.67	4.00	2.33	2.97	-0.81	-6.02	4.00	6.29	0.76		
0.00	270.00	2.23	-8.17	-0.93	-11.42	4.00	0.00	270.00	-13.90	2.62	-16.63	-7.50	4.00	2.33	2.97	-0.82	-6.03	4.00	6.29	0.77		
0.00	280.00	1.85	-16.48	-1.32	-14.37	4.00	0.00	280.00	-7.47	2.92	-10.43	-6.71	4.00	2.33	2.97	-0.81	-6.02	4.00	6.29	0.76		
0.00	290.00	1.18	-20.42	-2.00	-19.32	4.00	0.00	290.00	-3.99	2.95	-7.02	-6.23	4.00	2.33	2.97	-0.81	-6.02	4.00	6.29	0.77		
0.00	300.00	0.16	-9.43	-3.04	-33.26	4.00	0.00	300.00	-1.71	2.71	-4.78	-6.03	4.00	2.34	2.97	-0.81	-6.02	4.00	6.29	0.77		
0.00	310.00	-1.31	-4.89	-4.53	-23.70	4.00	0.00	310.00	-0.13	2.19	-3.22	-6.10	4.00	2.33	2.97	-0.82	-6.03	4.00	6.29	0.76		
0.00	320.00	-3.40	-2.11	-6.66	-16.46	4.00	0.00	320.00	0.98	1.35	-2.12	-6.44	4.00	2.33	2.97	-0.81	-6.03	4.00	6.29	0.76		
0.00	330.00	-6.53	-0.22	-9.85	-12.73	4.00	0.00	330.00	1.73	0.12	-1.39	-7.07	4.00	2.33	2.96	-0.81	-6.03	4.00	6.29	0.76		
0.00	340.00	-11.96	1.11	-15.45	-10.33	4.00	0.00	340.00	2.17	-1.63	-0.97	-8.04	4.00	2.33	2.96	-0.82	-6.03	4.00	6.29	0.76		
0.00	350.00	-31.82	2.03	-39.23	-8.67	4.00	0.00	350.00	2.33	-4.16	-0.81	-9.43	4.00	2.33	2.97	-0.81	-6.02	4.00	6.29	0.76		
15.00	0.00	-19.97	2.09	-3.18	-15.03	4.00	15.00	0.00	2.53	-12.17	-2.63	-9.78	4.00	2.55	2.44	0.11	-8.65	4.00	6.13	0.72		
15.00	10.00	-18.47	1.05	-2.68	-35.68	4.00	15.00	10.00	1.83	-10.57	-3.05	-14.77	4.00	1.87	1.34	0.15	-14.73	4.00	5.12	-0.03		
15.00	20.00	-6.16	-0.58	-4.03	-19.99	4.00	15.00	20.00	1.94	-10.43	-3.22	-8.72	4.00	2.57	-0.15	1.94	-0.60	-8.41	4.00	5.20	-0.24	
15.00	30.00	-5.33	-0.74	-3.36	-19.17	4.00	15.00	30.00	1.06	-5.48	-4.37	-9.99	4.00	1.96	0.52	-0.83	-9.49	4.00	5.01	-0.42		
15.00	40.00	-4.21	-0.76	-2.25	-20.71	4.00	15.00	40.00	-1.60	-3.16	-9.94	-7.52	4.00	0.30	1.21	-1.57	-7.32	4.00	4.74	-0.87		
15.00	50.00	-3.88	-1.74	-2.40	-17.37	4.00	15.00	50.00	-3.14	-2.86	-6.81	-9.30	4.00	-0.48	0.75	-1.06	-8.67	4.00	4.32	-1.25		
15.00	60.00	-3.09	-2.78	-2.02	-12.90	4.00	15.00	60.00	-6.52	-0.58	-9.61	-12.96	4.00	-1.46	1.47	-1.32	-9.77	4.00	4.12	-1.31		
15.00	70.00	-3.14	-5.66	-2.56	-13.17	4.00	15.00	70.00	-6.22	0.07	-13.20	-13.99	4.00	-1.40	1.10	-2.20	-10.55	4.00	3.69	-1.70		
15.00	80.00	-1.91	-8.16	-2.11	-11.98	4.00	15.00	80.00	-9.40	0.38	-10.61	-14.40	4.00	-1.20	0.95	-1.54	-10.01	4.00	3.92	-1.54		
15.00	90.00	-1.99	-10.68	-0.58	-12.04	4.00	15.00	90.00	-18.03	1.83	-18.04	-9.94	4.00	-1.88	2.07	-0.50	-7.85	4.00	4.67	-0.82		
15.00	100.00	-2.16	-12.61	-0.84	-10.49	4.00	15.00	100.00	-13.78	2.26	-18.92	-6.21	4.00	-1.87	2.40	-0.77	-4.83	4.00	5.14	-0.51		
15.00	110.00	-2.58	-9.21	-0.64	-8.44	4.00	15.00	110.00	-11.00	-6.66	-22.38	-5.41	4.00	-1.70	3.13	-0.01	-3.66	4.00	5.83	0.17		
15.00	120.00	-3.93	-4.95	0.43	-5.91	4.00	15.00	120.00	-6.16	2.64	-9.84	-6.58	4.00	-1.89	3.34	0.82	-3.22	4.00	6.15	0.50		
15.00	130.00	-5.68	-3.24	-0.10	-4.17	4.00	15.00	130.00	-3.17	1.19	-4.75	-5.08	4.00	-1.24	2.53	1.18	-1.59	4.00	6.41	0.56		
15.00	140.00	-6.95	-1.83	-0.12	-4.20	4.00	15.00	140.00	-1.45	-0.92	-1.87	-4.36	4.00	-0.37	1.66	2.10	-1.27	4.00	6.66	0.75		
15.00	150.00	-9.72	-0.54	-1.01	-3.17	4.00	15.00	150.00	0.09	-0.85	0.04	-6.16	4.00	0.52	2.32	2.56	-1.40	4.00	7.16	1.27		
15.00	160.00	-12.89	-0.29	-2.12	-3.76	4.00	15.00	160.00	2.04	-2.72	1.04	-9.94	4.00	2.18	1.67	2.75	-2.82	4.00	7.22	1.40		
15.00	170.00	-15.50	-0.17	-4.12	-5.16	4.00	15.00	170.00	1.68	-5.09	2.24	-12.90	4.00	1.76	1.04	3.14	-4.08	4.00	6.82	1.13		
15.00	180.00	-23.38	0.18	-6.75	-4.63	4.00	15.00	180.00	2.20	-10.02	1.94	-13.41	4.00	2.21	0.58	2.49	-4.09	4.00	6.68	0.94		
15.00	190.00	-11.05	0.78	-9.85	-5.27	4.00	15.00	190.00	2.54	-19.43	1.77	-14.03	4.00	2.73	0.82	2.06	-1.43	4.00	6.68	0.99		
15.00	200.00	-5.80	1.04	-21.95	-7.51	4.00	15.00	200.00	1.69	-14.54	2.22	-12.97	4.00	2.40	-1.16	2.24	-6.42	4.00	6.51	0.92		
15.00	210.00	-2.72	-1.14	-17.17	-11.18	4.00	15.00	210.00	0.73	-7.52	1.75	-13.55	4.00	2.35	-0.20	0.73	-9.19	4.00	5.71	0.31		
15.00	220.00																					



45.00	190.00	-7.34	-3.24	-2.03	-8.44	4.00	45.00	190.00	1.77	-7.20	0.33	-13.41	4.00	2.27	-1.77	2.32	-7.24	4.00	5.70	0.26
45.00	200.00	-3.80	-0.88	-5.29	-6.92	4.00	45.00	200.00	2.04	-8.98	1.47	-18.98	4.00	3.05	-0.25	2.30	-6.66	4.00	6.36	0.86
45.00	210.00	-1.49	-2.16	-5.05	-7.98	4.00	45.00	210.00	1.18	-7.58	0.52	-14.12	4.00	3.06	-1.06	1.58	-7.03	4.00	5.91	0.46
45.00	220.00	-2.94	-6.09	-8.71	-6.79	4.00	45.00	220.00	0.66	-2.09	0.14	-19.55	4.00	2.23	-0.63	0.67	-6.57	4.00	5.51	-0.08
45.00	230.00	-1.29	-7.05	-11.49	-11.95	4.00	45.00	230.00	-2.22	-1.52	-0.90	-22.82	4.00	1.28	2.09	-2.22	-11.61	4.00	5.18	-0.10
45.00	240.00	-1.07	-5.96	-10.49	-4.26	4.00	45.00	240.00	-7.39	3.74	-2.17	-56.81	4.00	-0.16	4.18	-1.57	-7.26	4.00	6.12	0.66
45.00	250.00	-0.91	-11.31	-8.69	-1.87	4.00	45.00	250.00	-10.25	3.99	-6.76	-23.62	4.00	-0.43	4.12	-4.61	-1.84	4.00	5.92	0.50
45.00	260.00	0.04	-31.56	-8.81	-2.25	4.00	45.00	260.00	-12.98	2.29	-14.92	-15.06	4.00	0.25	2.29	-7.86	-2.03	4.00	4.93	-0.52
45.00	270.00	-0.09	-20.17	-10.15	-1.55	4.00	45.00	270.00	-37.94	2.44	-16.86	-25.37	4.00	-0.09	2.46	-9.31	-1.53	4.00	4.86	-0.50
45.00	280.00	-0.27	-6.96	-12.10	-2.80	4.00	45.00	280.00	-16.81	3.34	-7.69	-21.15	4.00	-0.17	3.73	-6.35	-2.74	4.00	5.41	0.09
45.00	290.00	-1.14	-3.44	-8.03	-6.71	4.00	45.00	290.00	2.88	-5.66	-26.12	4.00	0.25	3.87	-4.02	-6.66	4.00	5.31	0.12	
45.00	300.00	1.08	-1.34	-8.53	-9.74	4.00	45.00	300.00	-1.38	2.71	-3.72	-14.22	4.00	3.03	4.15	-2.48	-8.42	4.00	6.36	1.24
45.00	310.00	0.61	-1.41	-4.72	-8.27	4.00	45.00	310.00	1.69	1.58	-0.63	-11.64	4.00	4.19	3.35	0.80	-6.63	4.00	7.34	1.91
45.00	320.00	-0.45	-5.31	-3.90	-4.63	4.00	45.00	320.00	2.20	-0.72	-1.24	-17.77	4.00	4.08	0.58	0.64	-4.42	4.00	6.74	1.16
45.00	330.00	-1.88	-3.58	-4.82	-3.33	4.00	45.00	330.00	2.88	-2.04	-3.00	-10.66	4.00	4.13	0.27	-0.81	-2.59	4.00	6.64	1.00
45.00	340.00	-4.48	-1.89	0.27	-0.67	4.00	45.00	340.00	1.97	-9.25	-1.88	-12.91	4.00	2.86	-1.16	2.34	-0.42	4.00	7.09	1.24
45.00	350.00	-8.93	-4.08	-0.41	-0.80	4.00	45.00	350.00	1.48	-9.35	-0.18	-12.50	4.00	1.86	-2.95	2.72	-0.52	4.00	6.57	0.79
60.00	0.00	-12.55	-3.37	1.35	-0.05	4.00	60.00	0.00	-0.16	-14.31	1.02	-22.21	4.00	0.08	-3.03	4.20	-0.02	4.00	6.72	1.09
60.00	10.00	-7.01	-1.18	-0.78	-5.12	4.00	60.00	10.00	1.04	-13.02	0.65	-13.03	4.00	1.67	-0.90	3.00	-4.47	4.00	6.29	0.64
60.00	20.00	-10.68	-2.21	-1.96	-5.34	4.00	60.00	20.00	-0.58	-4.65	1.31	-22.05	4.00	-0.18	-0.25	2.99	-5.25	4.00	5.82	0.20
60.00	30.00	-10.82	0.97	-5.06	-4.41	4.00	60.00	30.00	-1.42	-22.66	0.59	-17.53	4.00	-0.95	0.99	1.64	-4.20	4.00	5.67	-0.11
60.00	40.00	-7.89	0.93	-4.42	-7.28	4.00	60.00	40.00	-1.95	-12.27	-2.47	-14.41	4.00	-0.96	1.13	-0.33	-6.51	4.00	4.79	-0.90
60.00	50.00	-9.93	-1.40	-8.19	-7.46	4.00	60.00	50.00	-3.85	-13.00	-3.27	-14.72	4.00	-2.89	-1.11	-2.06	-6.71	4.00	3.07	-2.75
60.00	60.00	-15.06	-6.30	-11.04	-12.70	4.00	60.00	60.00	-5.54	-4.89	-4.37	-9.39	4.00	-5.08	-2.53	-3.52	-7.73	4.00	1.52	-4.31
60.00	70.00	-17.41	-8.71	-8.60	-12.73	4.00	60.00	70.00	-16.75	-5.58	-8.98	-28.96	4.00	-14.06	-3.20	-5.20	-3.20	4.00	3.18	-1.38
60.00	80.00	-16.09	-12.57	-8.04	-12.88	4.00	60.00	80.00	-12.65	-7.89	-14.69	-15.76	4.00	-11.03	-6.62	-6.10	-11.08	4.00	-2.37	-8.09
60.00	90.00	-10.25	-13.70	-8.07	-9.43	4.00	60.00	90.00	-11.92	-5.89	-13.40	-11.67	4.00	-7.99	-5.22	-6.20	-7.40	4.00	-0.62	-6.57
60.00	100.00	-14.40	-16.13	-10.96	-15.22	4.00	60.00	100.00	-12.16	-4.08	-10.25	-10.91	4.00	-10.13	-10.32	-7.58	-9.54	4.00	-1.37	-7.00
60.00	110.00	-14.25	-9.38	-6.27	-14.42	4.00	60.00	110.00	-8.62	0.10	-10.40	-11.57	4.00	-7.57	0.56	-4.85	-9.75	4.00	1.52	-3.60
60.00	120.00	-28.01	-12.95	-5.93	-15.88	4.00	60.00	120.00	-7.40	2.93	-7.36	-16.34	4.00	-7.36	3.04	-3.58	-13.09	4.00	2.71	-1.73
60.00	130.00	-15.37	-8.48	-6.15	-9.14	4.00	60.00	130.00	-6.52	1.33	-6.90	-8.77	4.00	-5.99	1.76	-3.50	-5.94	4.00	3.23	-2.12
60.00	140.00	-14.55	-9.75	-6.56	-9.78	4.00	60.00	140.00	-3.16	1.33	-4.07	-10.18	4.00	-2.86	1.66	-2.13	-6.97	4.00	3.98	-1.56
60.00	150.00	-25.82	-11.20	-5.91	-6.51	4.00	60.00	150.00	-0.80	-3.40	-5.42	-9.94	4.00	-0.79	-2.73	-2.65	-4.88	4.00	3.38	-2.53
60.00	160.00	-16.18	-9.47	-3.45	-3.60	4.00	60.00	160.00	0.39	-3.30	-6.10	-10.36	4.00	0.48	-2.36	-1.57	-2.77	4.00	4.56	-1.36
60.00	170.00	-13.23	-21.67	-3.17	-3.17	4.00	60.00	170.00	1.58	-5.15	-2.74	-10.47	4.00	0.72	-5.06	-3.15	-2.43	4.00	4.92	-0.77
60.00	180.00	-10.65	-6.80	-3.54	-2.71	4.00	60.00	180.00	0.73	-16.05	-0.67	-22.93	4.00	1.03	-6.31	1.14	-2.67	4.00	4.82	-0.78
60.00	190.00	-6.53	-3.43	-2.58	-1.67	4.00	60.00	190.00	1.10	-18.76	-1.23	-18.59	4.00	1.79	-3.30	1.16	-1.58	4.00	5.78	-0.02
60.00	200.00	-4.21	-3.03	-6.46	-3.07	4.00	60.00	200.00	1.16	-5.20	0.04	-18.80	4.00	2.27	-0.97	0.92	-2.96	4.00	6.05	0.24
60.00	210.00	-4.66	-7.42	-3.59	-5.18	4.00	60.00	210.00	0.15	-8.19	1.40	-17.06	4.00	2.08	-4.78	2.60	-4.91	4.00	5.49	0.10
60.00	220.00	-2.92	-10.52	-6.11	-4.22	4.00	60.00	220.00	-0.86	0.44	0.25	-16.24	4.00	1.24	0.77	1.15	-3.96	4.00	6.07	0.25
60.00	230.00	-3.26	-7.17	-8.14	-5.04	4.00	60.00	230.00	-2.96	0.27	0.09	-17.44	4.00	-0.10	0.99	0.70	-0.80	4.00	5.50	-0.29
60.00	240.00	-1.15	-11.19	-8.15	-4.94	4.00	60.00	240.00	-3.78	-1.83	-1.49	-19.13	4.00	0.74	-1.35	-0.64	-4.78	4.00	4.74	-1.09
60.00	250.00	-3.82	-8.67	-7.16	-2.66	4.00	60.00	250.00	-8.72	-5.64	-4.76	-25.33	4.00	-2.60	-3.82	-8.72	-5.64	4.00	3.07	-2.93
60.00	260.00	-4.69	-9.64	-7.91	-1.66	4.00	60.00	260.00	-21.15	-2.44	-9.51	-20.01	4.00	-4.59	-1.68	-5.63	-1.56	4.00	2.84	-3.01
60.00	270.00	-4.66	-6.76	-8.31	-0.81	4.00	60.00	270.00	-10.76	-1.03	-22.29	-18.09	4.00	-3.71	0.72	-8.14	-0.17	4.00	3.66	-1.87
60.00	280.00	-3.02	-9.60	-6.57	-1.72	4.00	60.00	280.00	-8.08	0.33	-10.42	-16.51	4.00	-1.84	0.75	-5.07	-1.00	4.00	4.48	-1.32
60.00	290.00	-3.33	-10.81	-7.68	-1.14	4.00	60.00	290.00	-5.52	1.46	-4.28	-10.52	4.00	-1.28	1.71	-2.65	-1.20	4.00	5.32	-0.54
60.00	300.00	-1.68	-10.72	-7.22	-1.59	4.00	60.00	300.00	-4.98	-0.65	-2.82	-13.44	4.00	-0.01	-0.24	-1.47	-1.32	4.00	5.28	-0.71
60.00	310.00	-1.91	-4.01	-5.12	-1.19	4.00	60.00	310.00	-0.24	-3.07	0.51	-11.40	4.00	2.02	-0.50	1.56	-1.70	4.00	6.49	0.60
60.00	320.00	-4.05	-1.74	-2.87	-3.20	4.00	60.00	320.00	1.34	-0.99	-0.48	-11.52	4.00	2.44	1.66	1.50	-1.20	4.00	6.98	1.12
60.00	330.00	-6.49	-4.98	-2.43	-1.63	4.00	60.00	330.00	2.54	-9.15	-1.18	-11.80	4.00	3.05	-3.57	1.25	-2.63	4.00	6.25	0.55
60.00	340.00	-6.92	-3.15	-2.22	0.72	4.00	60.00	340.00	1.49	-10.61	1.09	-14.66	4.00	2.08	-2.43	2.75	0.84	4.00	7.04	1.21
60.00	350.00	-11.16	-6.21	-0.39	0.59	4.00	60.00	350.00	3.44	-28.64	-0.61	-13.05	4.00	0.64	-6.19	2.51	0.77	4.00	6.01	0.39
75.00	0.00	-13.32	-5.71	-7.91	2.33	4.00	75.00	0.00	0.79	-24.65	0.43	-15.17	4.00	0.96	-5.65	1.02	2.41	4.00	6.20	0.54
75.00	10.00	-8.66	-1.64	-5.93	0.44	4.00	75.00	10.00	3.11	-30.13	-0.29	-17.07	4.00	0.83	-1.63	0.76	0.52	4.00	6.19	0.23
75.00	20.00	-10.29	-3.08	-10.71	-3.18	4.00	75.00	20.00	0.58	-12.66	0.4	-31.85	4.00	0.92	-2.63	0.72	-3.09	4.00	5.20	-0.64
75.00	30.00	-8.84	1.57	-10.1	-5.93	4.00	75.00	30.00	-1.36	-4.00	-1.85	-15.05	4.00	-0.65	1.81	-1.24	-5.43	4.00	5.01	-0.69
75.00	40.00	-9.89	5.59	-7.48	-4.876	4.00	75.00	40.00	-5.78	-11.39	-2.86	-13.77	4.00	-4.37	1.78	-1.57	-3.77	4.00	3.77	-1.63
75.00	50.00	-11.66	-11.29	-14.9	-8.176	4.00	75.00	50.00	-4.07	-1.95	-3.33	-14.25	4.00	-3.37	-4.35	-4.88	-11.24	4.00	0.54	-5.13
75.00	60.00	-17.28	-14.41	-6.83	-10.16	4.00	75.00	60.00	-6.03	-1.83	-2.2	-19.63	4.00	-4.76	-1.62	-0.91	-7.90	4.00	2.20	-3.29
75.00	70.00	-23.11	-16.92	-4.98	-10.23	4.00	75.00	70.00	-5.56	-9.54	-6.6	-24.49	4.00	-5.48	-8.81	-2.70	-10.07	4.00	-0.26	-5.81
75.00																				



105.00	100.00	-15.1	-13.04	-8.22	-19.03	4.00	105.00	100.00	-13.82	-7.20	-10.60	-15.20	4.00	-11.40	-6.19	-6.24	-13.70	4.00	-2.77	-8.29	
105.00	110.00	-18.62	-15.03	-16.61	-15.89	4.00	105.00	110.00	-16.07	-11.21	-9.43	-6.69	4.00	-14.15	-9.70	-8.67	-6.20	4.00	-3.21	-8.85	
105.00	120.00	-9.99	-24.64	-9.61	-7.86	4.00	105.00	120.00	-13.42	-11.01	-9.50	-2.99	4.00	-8.36	-10.83	-6.54	-1.77	4.00	-0.19	-5.54	
105.00	130.00	-17.37	-12.50	-18.27	-2.43	4.00	105.00	130.00	-10.73	-6.52	-19.11	-12.87	4.00	-9.88	-5.54	-15.66	-0.05	4.00	-0.90	-5.88	
105.00	140.00	-11.66	-7.80	-16.42	-1.01	4.00	105.00	140.00	-7.27	-5.14	-18.53	-19.83	4.00	-5.92	-3.26	-14.34	-2.95	4.00	1.14	-4.07	
105.00	150.00	-9.80	-4.26	-7.54	-1.13	4.00	105.00	150.00	-3.67	-3.12	-4.94	-9.37	4.00	-2.72	-0.64	-3.04	-0.52	4.00	4.37	-1.58	
105.00	160.00	-12.10	-7.85	-11.31	0.04	4.00	105.00	160.00	-3.43	-7.46	-7.42	-28.55	4.00	-2.88	-4.64	-5.93	0.05	4.00	2.97	-2.75	
105.00	170.00	-11.36	-6.16	-9.09	2.39	4.00	105.00	170.00	-2.17	-12.42	-8.62	-15.17	4.00	-1.68	-5.24	-5.84	2.47	4.00	4.11	-1.24	
105.00	180.00	-17.25	-11.96	-5.73	3.17	4.00	105.00	180.00	-0.90	-25.38	-10.77	-16.82	4.00	-0.80	-11.77	-4.55	3.21	4.00	4.11	-0.78	
105.00	190.00	-10.34	-9.04	-6.66	4.76	4.00	105.00	190.00	-1.26	-11.87	-8.26	-16.44	4.00	-0.75	-7.22	-4.38	4.79	4.00	5.33	0.42	
105.00	200.00	-9.83	-9.65	-7.16	4.16	4.00	105.00	200.00	-2.89	-8.58	-3.23	-13.86	4.00	-2.09	-6.07	-1.75	4.23	4.00	5.41	0.19	
105.00	210.00	-16.88	-9.40	-3.87	3.32	4.00	105.00	210.00	-2.28	-6.84	-5.33	-20.48	4.00	-2.13	-4.92	-1.53	3.34	4.00	5.24	-0.23	
105.00	220.00	-9.04	-11.09	-4.83	0.82	4.00	105.00	220.00	-7.11	-8.49	-3.23	-21.73	4.00	-4.96	-6.59	-0.95	0.84	4.00	3.61	-1.94	
105.00	230.00	-9.74	-6.64	-5.00	-1.38	4.00	105.00	230.00	-10.64	-5.90	-4.14	-18.11	4.00	-7.16	-3.24	-1.54	-1.29	4.00	3.01	-2.78	
105.00	240.00	-11.16	-11.14	-4.93	-3.86	4.00	105.00	240.00	-8.93	-11.58	-5.42	-17.73	4.00	-6.89	-8.34	-2.16	-3.69	4.00	1.10	-4.60	
105.00	250.00	-12.26	-19.43	-3.21	-4.43	4.00	105.00	250.00	-6.02	-7.91	-16.62	-21.25	4.00	-5.09	-7.61	-3.02	-4.34	4.00	1.16	-4.72	
105.00	260.00	-11.68	-17.96	-3.81	0.00	4.00	105.00	260.00	-6.87	-9.91	-22.35	-14.23	4.00	-5.63	-9.28	-3.75	0.16	4.00	2.06	-3.35	
105.00	270.00	-12.26	-23.69	-3.26	1.40	4.00	105.00	270.00	-14.58	-13.13	-10.31	-11.96	4.00	-10.26	-12.76	-2.48	1.60	4.00	1.91	-2.68	
105.00	280.00	-19.25	-28.37	-1.00	2.10	4.00	105.00	280.00	-8.80	-26.85	-6.78	-17.42	4.00	-8.43	-24.53	0.02	2.15	4.00	2.67	-1.56	
105.00	290.00	-13.87	-14.20	-0.99	2.96	4.00	105.00	290.00	-6.02	-16.50	-1.90	-10.75	4.00	-5.36	-12.19	1.59	3.14	4.00	4.66	-0.16	
105.00	300.00	-7.83	-10.54	-2.02	2.32	4.00	105.00	300.00	-3.09	-14.20	0.43	-12.65	4.00	-1.83	-8.99	2.39	2.46	4.00	5.59	0.29	
105.00	310.00	-4.86	-5.04	-4.16	1.98	4.00	105.00	310.00	-6.02	-5.52	0.86	-14.99	4.00	-2.39	-2.26	2.05	2.07	4.00	6.16	0.40	
105.00	320.00	-6.74	-3.97	-4.34	0.47	4.00	105.00	320.00	-6.97	-8.63	0.95	-12.13	4.00	-3.84	-2.69	2.08	0.70	4.00	5.41	-0.29	
105.00	330.00	-6.78	-6.90	-5.45	-3.01	4.00	105.00	330.00	-2.98	-4.83	0.07	-6.96	4.00	-1.47	-2.73	1.14	-1.54	4.00	4.99	-0.90	
105.00	340.00	-10.00	-4.73	-3.27	-2.14	4.00	105.00	340.00	-3.47	-7.62	0.48	-8.32	4.00	-2.60	-2.93	2.01	-1.20	4.00	5.07	-0.70	
105.00	350.00	-16.02	-4.71	-11.53	1.55	4.00	105.00	350.00	-2.51	-7.54	-1.24	-10.01	4.00	-2.32	-2.89	-0.85	1.84	4.00	5.17	-0.64	
120.00	0.00	-17.36	-2.19	-16.01	-0.51	4.00	120.00	0.00	1.02	-17.33	-2.92	-12.67	4.00	1.08	-2.06	-2.71	-0.25	4.00	5.16	-0.73	
120.00	10.00	-27.45	-4.52	-11.89	0.14	4.00	120.00	10.00	-4.08	-4.98	-5.06	-7.73	4.00	-4.06	-1.73	-4.24	0.80	4.00	3.96	-1.80	
120.00	20.00	-13.00	-5.91	-26.07	-3.61	4.00	120.00	20.00	-2.81	-6.91	-7.59	-9.52	4.00	-2.41	-3.37	-7.53	-2.62	4.00	2.26	-3.57	
120.00	30.00	-7.70	-14.30	-20.28	-8.11	4.00	120.00	30.00	-5.34	-11.65	-8.68	-16.52	4.00	-3.35	-9.77	-8.39	-7.52	4.00	-0.89	-6.53	
120.00	40.00	-7.50	-5.71	-38.27	-12.75	4.00	120.00	40.00	-11.24	-1.54	-4.55	-8.78	4.00	-5.97	-0.13	-4.55	-7.32	4.00	1.98	-3.57	
120.00	50.00	-5.92	-10.41	-7.00	-10.21	4.00	120.00	50.00	-15.10	-0.61	-19.78	-4.89	4.00	-5.42	0.94	-6.78	0.67	4.00	2.78	-2.68	
120.00	60.00	-6.47	-11.64	-14.48	-14.85	4.00	120.00	60.00	-8.58	-0.94	-10.24	-5.89	4.00	-4.39	-0.59	-8.85	-5.37	4.00	1.72	-3.82	
120.00	70.00	-6.12	-10.09	-10.54	-13.97	4.00	120.00	70.00	-7.74	-12.61	-8.18	-10.77	4.00	-3.84	-0.16	-6.19	-9.07	4.00	-0.56	-6.34	
120.00	80.00	-10.25	-10.12	-12.19	-15.06	4.00	120.00	80.00	-13.68	-1.91	-21.89	-11.61	4.00	-3.84	-1.30	-1.75	-10.08	4.00	-1.36	-6.04	
120.00	90.00	-22.68	-11.55	-19.30	-11.15	4.00	120.00	90.00	-9.71	-5.19	-13.28	8.65	4.00	-9.50	-4.29	-12.31	6.71	4.00	-1.67	-1.23	
120.00	100.00	-22.04	-16.39	-22.10	-19.68	4.00	120.00	100.00	-17.01	-8.74	-6.07	-10.04	4.00	-15.82	-8.05	-5.96	-9.59	4.00	-3.15	-8.65	
120.00	110.00	-10.80	-22.44	-9.71	-11.49	4.00	120.00	110.00	-12.06	-7.90	-3.78	-12.08	4.00	-8.37	-7.75	-2.79	-8.76	4.00	-0.53	-6.14	
120.00	120.00	-9.16	-23.76	-9.13	-11.42	4.00	120.00	120.00	-6.92	-5.33	-14.20	-22.59	4.00	-4.89	-5.27	-7.95	-5.33	-11.10	4.00	-0.95	-6.68
120.00	130.00	-8.30	-12.10	-10.45	-2.55	4.00	120.00	130.00	-14.61	-17.25	-11.66	-19.02	4.00	-7.39	-10.94	-8.00	-2.45	4.00	-0.62	-6.07	
120.00	140.00	-31.61	-3.61	-8.72	-6.75	4.00	120.00	140.00	-13.06	-2.71	-5.21	-25.19	4.00	-13.00	-0.13	-3.61	-6.69	4.00	1.34	-3.79	
120.00	150.00	-13.58	-1.77	-15.26	-4.06	4.00	120.00	150.00	-9.63	-5.65	-16.40	-13.05	4.00	-8.16	-0.28	-12.78	-3.54	4.00	1.04	-4.02	
120.00	160.00	-18.49	-14.23	-11.21	-9.33	4.00	120.00	160.00	-14.18	-13.42	-8.94	-12.52	4.00	-12.81	-10.80	-6.92	-0.08	4.00	-0.18	-4.81	
120.00	170.00	-16.27	-21.52	-11.59	0.43	4.00	120.00	170.00	-10.38	-10.86	-22.38	-18.31	4.00	-9.38	-10.50	-11.24	2.49	4.00	-0.13	-4.56	
120.00	180.00	-17.35	-11.13	-8.19	2.62	4.00	120.00	180.00	-1.85	-9.34	-9.52	-22.33	4.00	-1.73	-7.13	-5.79	0.63	4.00	3.88	-1.30	
120.00	190.00	-13.70	-10.08	-8.50	2.95	4.00	120.00	190.00	-5.02	-18.00	-10.46	-9.56	4.00	-4.47	-9.43	-6.36	3.19	4.00	3.11	-1.57	
120.00	200.00	-10.17	-9.97	-6.65	1.37	4.00	120.00	200.00	-11.81	-13.84	-6.75	-12.71	4.00	-7.90	-8.48	-3.69	1.54	4.00	2.37	-2.68	
120.00	210.00	-18.41	-3.41	-4.90	1.71	4.00	120.00	210.00	-7.62	-12.55	-5.09	-10.15	4.00	-7.27	-2.91	-1.98	1.98	4.00	4.08	-1.38	
120.00	220.00	-27.35	-8.34	-4.68	-0.18	4.00	120.00	220.00	-7.27	-12.43	-5.56	-9.08	4.00	-7.23	-6.91	-2.09	0.35	4.00	2.65	-2.81	
120.00	230.00	-16.21	-7.58	-7.17	-2.82	4.00	120.00	230.00	-15.19	-4.42	-2.80	-11.56	4.00	-12.66	-2.71	-1.45	-2.28	4.00	2.22	-3.24	
120.00	240.00	-13.99	-10.28	-4.91	-4.65	4.00	120.00	240.00	-19.23	-6.56	-4.23	-13.35	4.00	-12.85	-5.02	-1.55	-4.10	4.00	1.02	-4.39	
120.00	250.00	-14.69	-11.48	-2.71	-4.45	4.00	120.00	250.00	-29.13	-8.47	-6.00	-9.22	4.00	-14.54	-6.71	-1.04	-3.10	4.00	0.94	-4.22	
120.00	260.00	-18.66	-15.44	-2.50	-5.53	4.00	120.00	260.00	-12.52	-12.52	-10.51	-21.40	4.00	-14.09	-2.97	-2.09	-0.17	4.00	2.52	-2.75	
120.00	270.00	-13.78	-22.06	-1.97	1.49	4.00	120.00	270.00	-12.44	-0.75	-20.20	-6.80	4.00	-10.05	-0.72	-1.91	2.09	4.00	4.38	-0.96	
120.00	280.00	-8.88	-12.08	-2.16	1.92	4.00	120.00	280.00	-14.18	-2.18	-6.42	-10.24	4.00	-7.76	-2.23	-0.78	2.18	4.00	4.56	-0.90	
120.00	290.00	-7.23	-7.21	-1.49	2.88	4.00	120.00	290.00	-9.54	-8.67	-1.57	-7.40	4.00	-5.22	-4.87	1.48	3.27	4.00	5.49	0.17	
120.00	300.00	-8.84	-6.53	-3.43	2.23	4.00	120.00	300.00	-6.05	-10.68	-1.31	-9.05	4.00	-4.59	-5.12	0.77	2.54	4.00	5.06	-0.40	
120.00	310.00	-6.47	-5.84	-2.16	0.85	4.00	120.00	310.00	-3.21	-5.59	-2.87	-12.41	4.00	-1.38	-2.06	0.66	1.15	4.00	3.57	-0.33	
120.00	320.00	-9.37	-11.33	-2.80	-3.82	4.00	120.00	320.00	-3.22	-3.20	-8.67	-12.66	4.00	-2.28	-2.59	0.68	-3.26	4.00	4.28	-1.59	
120.00	330.00	-13.47	-6.73	6.59	-5.93	4.00	120.00	330.00	-2.22	-7.83	-2.29	-12.93	4.00	-1.91	-4.23	-2.92	1.14				



165.00	10.00	-21.40	0.52	-8.42	-11.60	4.00	165.00	10.00	-6.11	-4.01	-5.64	-5.69	4.00
165.00	20.00	-17.32	-7.66	-13.78	-18.01	4.00	165.00	20.00	-4.17	-4.69	-5.51	-7.99	4.00
165.00	30.00	-20.94	-8.72	-13.96	-25.71	4.00	165.00	30.00	-4.08	-12.11	-7.24	-7.44	4.00
165.00	40.00	-16.98	-7.25	-12.31	-30.00	4.00	165.00	40.00	-7.07	-15.71	-6.29	-8.68	4.00
165.00	50.00	-10.08	-10.41	-10.98	-23.78	4.00	165.00	50.00	-7.61	-9.70	-5.62	-7.12	4.00
165.00	60.00	-8.78	-12.23	-8.26	-15.82	4.00	165.00	60.00	-14.12	-6.40	-6.28	-7.58	4.00
165.00	70.00	-9.92	-19.68	-9.46	-18.44	4.00	165.00	70.00	-14.21	-5.54	-5.61	-9.27	4.00
165.00	80.00	-8.26	-28.09	-9.76	-23.99	4.00	165.00	80.00	-17.64	-3.51	-8.05	-8.05	4.00
165.00	90.00	-10.76	-16.92	-13.05	-18.26	4.00	165.00	90.00	-22.25	-3.25	-10.20	-11.35	4.00
165.00	100.00	-11.46	-13.04	-13.39	-17.16	4.00	165.00	100.00	-23.14	-2.28	-18.67	-11.92	4.00
165.00	110.00	-16.04	-7.98	-13.27	-10.52	4.00	165.00	110.00	-19.68	-3.13	-14.95	-16.62	4.00
165.00	120.00	-29.67	-7.25	-13.36	-12.05	4.00	165.00	120.00	-18.20	-6.36	-14.97	-13.85	4.00
165.00	130.00	-21.12	-7.13	-15.21	-8.86	4.00	165.00	130.00	-13.72	-18.58	-12.16	-18.72	4.00
165.00	140.00	-11.49	-11.79	-9.52	-10.98	4.00	165.00	140.00	-20.82	-14.40	-15.32	-12.90	4.00
165.00	150.00	-14.97	-18.19	-10.69	-15.59	4.00	165.00	150.00	-14.33	-6.99	-13.72	-14.05	4.00
165.00	160.00	-18.52	-12.90	-9.37	-15.05	4.00	165.00	160.00	-16.50	-9.39	-23.15	-13.64	4.00
165.00	170.00	-16.83	-6.51	-11.73	-11.47	4.00	165.00	170.00	-30.08	-12.02	-23.51	-10.81	4.00
165.00	180.00	-19.23	-7.41	-18.65	-13.31	4.00	165.00	180.00	-18.48	-13.79	-19.52	-9.32	4.00
165.00	190.00	-14.20	-6.25	-14.84	-16.21	4.00	165.00	190.00	-22.26	-9.03	-11.54	-7.29	4.00
165.00	200.00	-16.41	-8.37	-23.65	-17.47	4.00	165.00	200.00	-14.87	-5.75	-11.28	-12.84	4.00
165.00	210.00	-15.66	-6.08	-12.73	-12.28	4.00	165.00	210.00	-17.49	-4.96	-15.34	-19.31	4.00
165.00	220.00	-22.58	-5.66	-10.35	-15.30	4.00	165.00	220.00	-9.38	-1.04	-17.63	-15.11	4.00
165.00	230.00	-15.41	-7.04	-9.39	-18.41	4.00	165.00	230.00	-7.64	0.09	-10.73	-11.49	4.00
165.00	240.00	-10.86	-8.14	-8.85	-16.80	4.00	165.00	240.00	-9.01	0.01	-11.49	-11.19	4.00
165.00	250.00	-8.26	-16.74	-12.94	-13.16	4.00	165.00	250.00	-13.16	-2.24	-11.12	-8.91	4.00
165.00	260.00	-5.45	-15.74	-8.65	-11.62	4.00	165.00	260.00	-25.43	-5.96	-10.01	-9.84	4.00
165.00	270.00	-4.02	-12.26	-9.83	-14.08	4.00	165.00	270.00	-31.27	-8.91	-6.94	-5.60	4.00
165.00	280.00	-4.22	-15.09	-16.42	-12.15	4.00	165.00	280.00	-13.51	-5.44	-5.86	-5.16	4.00
165.00	290.00	-3.86	-15.33	-10.26	-10.56	4.00	165.00	290.00	-10.94	-5.61	-5.07	-3.79	4.00
165.00	300.00	-3.98	-6.63	-13.46	-6.41	4.00	165.00	300.00	-14.42	-4.55	-7.15	-6.41	4.00
165.00	310.00	-2.28	-4.22	-13.57	-5.71	4.00	165.00	310.00	-11.87	-5.27	-4.40	-5.29	4.00
165.00	320.00	-4.22	-0.41	-15.02	-4.96	4.00	165.00	320.00	-8.57	-6.27	-3.23	-4.48	4.00
165.00	330.00	-5.70	1.45	-9.33	-3.78	4.00	165.00	330.00	-8.37	-4.88	-5.71	-4.13	4.00
165.00	340.00	-7.92	3.16	-9.40	-2.50	4.00	165.00	340.00	-8.18	-13.01	-6.49	-4.41	4.00
165.00	350.00	-14.92	3.21	-6.84	-3.18	4.00	165.00	350.00	-6.87	-15.08	-7.14	-5.48	4.00
180.00	0.00	-22.86	-7.06	-16.23	-8.35	4.00	180.00	0.00	-9.67	-21.80	-11.70	-10.48	4.00
180.00	10.00	-17.87	-6.92	-14.11	-7.36	4.00	180.00	10.00	-10.15	-46.92	-12.80	-12.84	4.00
180.00	20.00	-14.90	-7.04	-12.62	-6.72	4.00	180.00	20.00	-10.93	-22.46	-14.36	-16.46	4.00
180.00	30.00	-12.90	-7.44	-11.58	-6.36	4.00	180.00	30.00	-12.10	-16.40	-16.60	-23.37	4.00
180.00	40.00	-11.50	-8.13	-10.89	-6.28	4.00	180.00	40.00	-13.75	-13.04	-20.01	-35.58	4.00
180.00	50.00	-10.52	-9.18	-10.51	-6.47	4.00	180.00	50.00	-16.14	-10.82	-26.22	-19.95	4.00
180.00	60.00	-9.89	-10.69	-10.39	-6.93	4.00	180.00	60.00	-19.83	-9.28	-48.73	-14.82	4.00
180.00	70.00	-9.55	-12.84	-10.54	-7.71	4.00	180.00	70.00	-26.99	-8.20	-25.02	-11.80	4.00
180.00	80.00	-9.48	-16.08	-10.97	-8.85	4.00	180.00	80.00	-37.20	-7.48	-19.43	-9.77	4.00
180.00	90.00	-9.67	-21.80	-11.70	-10.48	4.00	180.00	90.00	-22.86	-7.06	-16.23	-8.35	4.00
180.00	100.00	-10.15	-46.92	-12.80	-12.84	4.00	180.00	100.00	-17.87	-6.92	-14.11	-7.36	4.00
180.00	110.00	-10.93	-22.46	-14.36	-16.46	4.00	180.00	110.00	-14.90	-7.04	-12.62	-6.72	4.00
180.00	120.00	-12.10	-16.40	-16.60	-23.37	4.00	180.00	120.00	-12.90	-7.44	-11.58	-6.36	4.00
180.00	130.00	-13.75	-13.04	-20.01	-35.58	4.00	180.00	130.00	-11.50	-8.13	-10.89	-6.28	4.00
180.00	140.00	-16.14	-10.82	-26.22	-19.95	4.00	180.00	140.00	-10.52	-9.18	-10.51	-6.47	4.00
180.00	150.00	-19.83	-9.28	-48.73	-14.82	4.00	180.00	150.00	-9.89	-10.69	-10.39	-6.93	4.00
180.00	160.00	-26.99	-8.20	-25.02	-11.80	4.00	180.00	160.00	-9.55	-12.84	-10.54	-7.71	4.00
180.00	170.00	-37.20	-7.48	-19.43	-9.77	4.00	180.00	170.00	-9.48	-16.08	-10.97	-8.85	4.00
180.00	180.00	-22.86	-7.06	-16.23	-8.35	4.00	180.00	180.00	-9.67	-21.80	-11.70	-10.48	4.00
180.00	190.00	-17.87	-6.92	-14.11	-7.36	4.00	180.00	190.00	-10.15	-46.92	-12.80	-12.84	4.00
180.00	200.00	-14.90	-7.04	-12.62	-6.72	4.00	180.00	200.00	-10.93	-22.46	-14.36	-16.46	4.00
180.00	210.00	-12.90	-7.44	-11.58	-6.36	4.00	180.00	210.00	-12.10	-16.40	-16.60	-23.37	4.00
180.00	220.00	-11.50	-8.13	-10.89	-6.28	4.00	180.00	220.00	-13.75	-13.04	-20.01	-35.58	4.00
180.00	230.00	-10.52	-9.18	-10.51	-6.47	4.00	180.00	230.00	-16.14	-10.82	-26.22	-19.95	4.00
180.00	240.00	-9.89	-10.69	-10.39	-6.93	4.00	180.00	240.00	-19.83	-9.28	-48.73	-14.82	4.00
180.00	250.00	-9.55	-12.84	-10.54	-7.71	4.00	180.00	250.00	-26.99	-8.20	-25.02	-11.80	4.00
180.00	260.00	-9.48	-16.08	-10.97	-8.85	4.00	180.00	260.00	-37.20	-7.48	-19.43	-9.77	4.00
180.00	270.00	-9.67	-21.80	-11.70	-10.48	4.00	180.00	270.00	-22.86	-7.06	-16.23	-8.35	4.00
180.00	280.00	-10.15	-46.92	-12.80	-12.84	4.00	180.00	280.00	-17.87	-6.92	-14.11	-7.36	4.00
180.00	290.00	-10.93	-22.46	-14.36	-16.46	4.00	180.00	290.00	-14.90	-7.04	-12.62	-6.72	4.00
180.00	300.00	-12.10	-16.40	-16.60	-23.37	4.00	180.00	300.00	-12.90	-7.44	-11.58	-6.36	4.00
180.00	310.00	-13.75	-13.04	-20.01	-35.58	4.00	180.00	310.00	-11.50	-8.13	-10.89	-6.28	4.00
180.00	320.00	-16.14	-10.82	-26.22	-19.95	4.00	180.00	320.00	-10.52	-9.18	-10.51	-6.47	4.00
180.00	330.00	-19.83	-9.28	-48.73	-14.82	4.00	180.00	330.00	-9.89	-10.69	-10.39	-6.93	4.00
180.00	340.00	-26.99	-8.20	-25.02	-11.80	4.00	180.00	340.00	-9.55	-12.84	-10.54	-7.71	4.00
180.00	350.00	-37.20	-7.48	-19.43	-9.77	4.00	180.00	350.00	-9.48	-16.08	-10.97	-8.85	4.00

-5.98	1.83	-3.80	-4.70	4.00	3.42	-1.99	-3.96	-2.92	-4.91	-7.58	4.00	1.34	-4.53
-3.99	-7.08	-6.40	-7.38	4.00	-0.09	-5.99	-6.65	-6.67	-5.32	-8.65	4.00	-0.72	-6.67
-5.66	-7.03	-4.51	-7.03	4.00	0.03	-5.93	-7.67	-5.39	-4.15	-6.97	4.00	0.08	-5.83
-8.55	-5.38	-4.11	-8.77	4.00	-0.45	-6.24	-7.79	-3.49	-5.81	-7.94	4.00	-0.04	-5.86
-10.46	-3.07	-8.38	-10.54	4.00	-1.51	-6.90	-11.17	-1.93	-12.11	-10.78	4.00	-1.86	-6.66
-14.48	-1.90	-11.02	-9.41	4.00	-1.87	-6.60	-16.01	-3.77	-11.08	-9.85	4.00	-3.05	-8.05
-12.99	-6.83	-10.41	-8.43	4.00	-3.35	-9.10	-11.01	-9.89	-8.51	-8.82	4.00	-3.48	-9.45
-11.63	-6.67	-8.94	-11.74	4.00	-3.46	-9.22	-14.38	-7.79	-9.19	-11.28	4.00	-4.30	-10.02
-16.63	-5.43	-11.45	-8.12	4.00	-3.46	-8.75	-15.83	-6.51	-16.05	-7.86	4.00	-4.46	-9.61
-13.57	-4.41	-9.87	-6.77	4.00	-1.99	-7.45	-12.56	-3.86	-11.04	-11.55	4.00	-2.96	-8.13
-13.47	-2.47	-10.83	-11.49	4.00	-2.40	-7.19	-9.18	0.25	-9.61	-12.19	4.00	-0.21	-4.72
-6.97	0.86	-7.00	-10.69	4.00	1.18	-3.70	-6.83	0.63	-6.96	-10.14	4.00	1.18	-3.82
-7.04	-2.09	-8.93	-7.52	4.00	0.04	-5.53	-5.41	-5.53	-6.27	-7.63	4.00	-0.14	-6.12
-4.01	-7.26	-5.14	-5.02	4.00	0.74	-5.21	-3.74	-4.99	-5.49	-5.43	4.00	1.40	-4.60
-3.08	-5.17	-3.92	-2.96	4.00	2.28	-3.70	-3.60	-1.25	-4.55	-2.10	4.00	3.24	-6.69
-1.83	-1.70	-3.90	-2.48	4.00	3.58	-2.40	-2.86	0.59	-2.95	-1.70	4.		



Frequency: 7115MHz

Theta Polarization		Max Gain(dB)				Nant	Phi Polarization		Max Gain(dB)				Nant	Total				Max DG(dB)	Max DG(dBi)			
Angle (θ)	Angle (ψ)	Ant 1(G1)	Ant 2(G2)	Ant 3(G3)	Ant 4(G4)		Angle (θ)	Angle (ψ)	Ant 1(G1)	Ant 2(G2)	Ant 3(G3)	Ant 4(G4)		Ant 1(G1)	Ant 2(G2)	Ant 3(G3)	Ant 4(G4)			Nant	7.73	1.92
		2.77	3.44	1.57	5.11				2.88	4.15	2.45	-2.49										
		Ant 1(G1)	Ant 2(G2)	Ant 3(G3)	Ant 4(G4)			Ant 1(G1)	Ant 2(G2)	Ant 3(G3)	Ant 4(G4)						g1k	g1k				
0.00	0.00	-18.67	3.13	-17.53	-7.08	4.00	0.00	0.00	2.77	-12.15	-2.90	-9.66	4.00	2.80	3.26	-2.75	-5.17	4.00	6.27	0.84		
0.00	10.00	-9.03	3.25	-11.86	-6.14	4.00	0.00	10.00	2.50	-36.75	-3.33	-12.15	4.00	2.80	3.25	-2.76	-5.17	4.00	6.26	0.84		
0.00	20.00	-4.73	3.11	-8.64	-5.54	4.00	0.00	20.00	1.95	-11.76	-4.05	-16.05	4.00	2.79	3.25	-2.75	-5.17	4.00	6.26	0.84		
0.00	30.00	-2.06	2.70	-6.50	-5.23	4.00	0.00	30.00	1.08	-5.97	-5.14	-23.95	4.00	2.80	3.25	-2.76	-5.17	4.00	6.26	0.84		
0.00	40.00	-0.24	1.98	-5.01	-5.19	4.00	0.00	40.00	-0.19	-2.71	-6.69	-29.73	4.00	2.80	3.25	-2.76	-5.17	4.00	6.26	0.84		
0.00	50.00	1.05	0.91	-3.96	-5.41	4.00	0.00	50.00	-2.00	-0.55	-8.91	-17.88	4.00	2.80	3.25	-2.75	-5.17	4.00	6.26	0.84		
0.00	60.00	1.93	-0.63	-3.27	-5.92	4.00	0.00	60.00	-4.63	0.97	-12.29	-13.19	4.00	2.80	3.25	-2.76	-5.17	4.00	6.26	0.84		
0.00	70.00	2.49	-2.83	-2.88	-6.74	4.00	0.00	70.00	-8.85	2.02	-18.42	-10.36	4.00	2.80	3.25	-2.76	-5.17	4.00	6.26	0.84		
0.00	80.00	2.76	-6.16	-2.76	-7.94	4.00	0.00	80.00	-18.13	2.72	-42.76	-8.43	4.00	2.80	3.25	-2.76	-5.17	4.00	6.26	0.84		
0.00	90.00	2.77	-12.15	-2.90	-9.66	4.00	0.00	90.00	-18.67	3.13	-17.53	-7.08	4.00	2.80	3.26	-2.75	-5.17	4.00	6.27	0.84		
0.00	100.00	2.50	-36.75	-3.33	-12.15	4.00	0.00	100.00	-9.03	3.25	-11.86	-6.14	4.00	2.80	3.25	-2.76	-5.17	4.00	6.26	0.84		
0.00	110.00	1.95	-11.76	-4.05	-16.05	4.00	0.00	110.00	-4.73	3.11	-8.64	-5.54	4.00	2.79	3.25	-2.75	-5.17	4.00	6.26	0.84		
0.00	120.00	1.08	-5.97	-5.14	-23.95	4.00	0.00	120.00	-2.06	2.70	-6.50	-5.23	4.00	2.80	3.25	-2.76	-5.17	4.00	6.26	0.84		
0.00	130.00	-0.19	-2.71	-6.69	-29.73	4.00	0.00	130.00	-0.24	1.98	-5.01	-5.19	4.00	2.80	3.25	-2.76	-5.17	4.00	6.26	0.84		
0.00	140.00	-2.00	-0.55	-8.91	-17.88	4.00	0.00	140.00	1.05	0.91	-3.96	-5.41	4.00	2.80	3.25	-2.75	-5.17	4.00	6.26	0.84		
0.00	150.00	-4.63	0.97	-12.29	-13.19	4.00	0.00	150.00	1.93	0.63	-3.27	-5.92	4.00	2.80	3.25	-2.76	-5.17	4.00	6.26	0.84		
0.00	160.00	-8.85	2.02	-18.42	-10.36	4.00	0.00	160.00	2.49	-2.83	-2.88	-6.74	4.00	2.80	3.25	-2.76	-5.17	4.00	6.26	0.84		
0.00	170.00	-18.13	2.72	-42.76	-8.43	4.00	0.00	170.00	2.76	-6.16	-2.76	-7.94	4.00	2.80	3.26	-2.76	-5.17	4.00	6.27	0.84		
0.00	180.00	-18.67	3.13	-17.53	-7.08	4.00	0.00	180.00	2.77	-12.15	-2.90	-9.66	4.00	2.80	3.26	-2.75	-5.17	4.00	6.27	0.84		
0.00	190.00	-9.03	3.25	-11.86	-6.14	4.00	0.00	190.00	2.50	-36.75	-3.33	-12.15	4.00	2.80	3.25	-2.76	-5.17	4.00	6.26	0.84		
0.00	200.00	-4.73	3.11	-8.64	-5.54	4.00	0.00	200.00	1.95	-11.76	-4.05	-16.05	4.00	2.79	3.25	-2.75	-5.17	4.00	6.26	0.84		
0.00	210.00	-2.06	2.70	-6.50	-5.23	4.00	0.00	210.00	1.08	-5.97	-5.14	-23.95	4.00	2.80	3.25	-2.76	-5.17	4.00	6.26	0.84		
0.00	220.00	-0.24	1.98	-5.01	-5.19	4.00	0.00	220.00	-0.19	-2.71	-6.69	-29.73	4.00	2.80	3.25	-2.76	-5.17	4.00	6.26	0.84		
0.00	230.00	1.05	0.91	-3.96	-5.41	4.00	0.00	230.00	-2.00	-0.55	-8.91	-17.88	4.00	2.80	3.25	-2.75	-5.17	4.00	6.26	0.84		
0.00	240.00	1.93	-0.63	-3.27	-5.92	4.00	0.00	240.00	-4.63	0.97	-12.29	-13.19	4.00	2.80	3.25	-2.76	-5.17	4.00	6.26	0.84		
0.00	250.00	2.49	-2.83	-2.88	-6.74	4.00	0.00	250.00	-8.85	2.02	-18.42	-10.36	4.00	2.80	3.25	-2.76	-5.17	4.00	6.26	0.84		
0.00	260.00	2.76	-6.16	-2.76	-7.94	4.00	0.00	260.00	-18.13	2.72	-42.76	-8.43	4.00	2.80	3.25	-2.76	-5.17	4.00	6.26	0.84		
0.00	270.00	2.77	-12.15	-2.90	-9.66	4.00	0.00	270.00	-18.67	3.13	-17.53	-7.08	4.00	2.80	3.26	-2.75	-5.17	4.00	6.27	0.84		
0.00	280.00	2.50	-36.75	-3.33	-12.15	4.00	0.00	280.00	-9.03	3.25	-11.86	-6.14	4.00	2.80	3.25	-2.76	-5.17	4.00	6.26	0.84		
0.00	290.00	1.95	-11.76	-4.05	-16.05	4.00	0.00	290.00	-4.73	3.11	-8.64	-5.54	4.00	2.79	3.25	-2.75	-5.17	4.00	6.26	0.84		
0.00	300.00	1.08	-5.97	-5.14	-23.95	4.00	0.00	300.00	-2.06	2.70	-6.50	-5.23	4.00	2.80	3.25	-2.76	-5.17	4.00	6.26	0.84		
0.00	310.00	-0.19	-2.71	-6.69	-29.73	4.00	0.00	310.00	-0.24	1.98	-5.01	-5.19	4.00	2.80	3.25	-2.76	-5.17	4.00	6.26	0.84		
0.00	320.00	-2.00	-0.55	-8.91	-17.88	4.00	0.00	320.00	1.05	0.91	-3.96	-5.41	4.00	2.80	3.25	-2.75	-5.17	4.00	6.26	0.84		
0.00	330.00	-4.63	0.97	-12.29	-13.19	4.00	0.00	330.00	1.93	0.63	-3.27	-5.92	4.00	2.80	3.25	-2.76	-5.17	4.00	6.26	0.84		
0.00	340.00	-8.85	2.02	-18.42	-10.36	4.00	0.00	340.00	2.49	-2.83	-2.88	-6.74	4.00	2.80	3.25	-2.76	-5.17	4.00	6.26	0.84		
0.00	350.00	-18.13	2.72	-42.76	-8.43	4.00	0.00	350.00	2.76	-6.16	-2.76	-7.94	4.00	2.80	3.25	-2.76	-5.17	4.00	6.26	0.84		
15.00	0.00	-17.53	2.76	-3.53	-16.50	4.00	15.00	0.00	2.88	-20.24	-6.91	-7.41	4.00	2.92	2.78	-1.89	-6.91	4.00	6.09	0.71		
15.00	10.00	-16.53	2.08	-3.34	-19.31	4.00	15.00	10.00	2.11	-14.60	-6.30	-7.64	4.00	2.17	2.17	-1.56	-7.35	4.00	5.65	0.19		
15.00	20.00	-9.79	0.59	-2.18	-20.67	4.00	15.00	20.00	0.91	-7.94	-4.87	-8.38	4.00	1.26	1.16	-0.31	-8.13	4.00	5.24	-0.30		
15.00	30.00	-5.46	-0.13	-4.09	-20.28	4.00	15.00	30.00	-0.54	-6.32	-5.40	-7.80	4.00	0.67	0.81	-1.69	-7.56	4.00	4.66	-0.94		
15.00	40.00	-3.67	0.49	-2.77	-18.74	4.00	15.00	40.00	-2.76	-2.48	-7.31	-8.80	4.00	-0.18	0.26	-1.46	-8.38	4.00	4.87	-0.58		
15.00	50.00	-2.54	-1.47	-2.76	-18.34	4.00	15.00	50.00	-3.72	-0.48	-13.10	-8.48	4.00	-0.08	2.06	-2.38	-8.05	4.00	4.65	-0.80		
15.00	60.00	-0.52	-2.54	-2.18	-13.77	4.00	15.00	60.00	-6.68	-0.17	-16.14	-10.23	4.00	0.42	1.82	-2.01	-8.64	4.00	4.72	-0.72		
15.00	70.00	-1.34	-5.14	-1.72	-14.76	4.00	15.00	70.00	-9.49	0.27	-16.15	-18.99	4.00	-0.72	1.37	-1.57	-13.37	4.00	3.92	-1.31		
15.00	80.00	-0.65	-8.15	-1.98	-14.38	4.00	15.00	80.00	-12.63	1.55	-19.77	-10.74	4.00	-0.38	1.99	-1.91	-9.17	4.00	4.52	-0.88		
15.00	90.00	-0.79	-12.72	-1.37	-11.86	4.00	15.00	90.00	-16.50	1.30	-16.56	-11.79	4.00	-0.67	1.47	-1.24	-8.81	4.00	4.45	-1.05		
15.00	100.00	-1.69	-13.96	-0.92	-7.85	4.00	15.00	100.00	-11.22	1.75	-27.07	-8.72	4.00	-1.23	1.87	-0.91	-5.25	4.00	4.99	-0.71		
15.00	110.00	-1.91	-9.50	-0.69	-8.36	4.00	15.00	110.00	-9.58	1.86	-11.03	-8.52	4.00	-1.22	2.17	0.25	-5.33	4.00	5.39	-0.28		
15.00	120.00	-4.60	-4.33	-0.32	-8.14	4.00	15.00	120.00	-4.26	1.59	-11.98	-6.39	4.00	-1.42	2.58	-0.03	-2.71	4.00	5.85	0.07		
15.00	130.00	-6.43	-1.94	-1.08	-5.52	4.00	15.00	130.00	-2.93	0.86	-4.46	-7.86	4.00	-1.33	2.89	0.56	-2.87	4.00	6.04	0.26		
15.00	140.00	-6.82	-0.65	-0.43	-4.22	4.00	15.00	140.00	-1.13	-1.30	-3.04	-7.64	4.00	-0.09	2.05	1.17	-2.59	4.00	6.41	0.54		
15.00	150.00	-7.24	0.39	-2.06	-4.68	4.00	15.00	150.00	-0.21	-1.94	-2.05	-9.27	4.00	0.58	2.39	1.80	-3.38	4.00	6.63	0.83		
15.00	160.00	-14.48	0.19	-3.11	-4.15	4.00	15.00	160.00	1.05	-4.35	-0.87	-15.58	4.00	1.17	1.50	1.16	-3.85	4.00	6.27	0.45		
15.00	170.00	-17.87	0.61	-4.31	-3.66	4.00	15.00	170.00	1.45	-6.08	-1.09	-12.90	4.00	1.50	1.16	0.60	-3.17	4.00	6.23	0.36		
15.00	180.00	-16.24	1.69	-6.10	-5.28	4.00	15.00	180.00	1.56	-12.97	0.13	-17.14	4.00	1.63	1.84	1.06	-5.01	4.00	6.31	0.58		
15.00	190.00	-15.14	1.01	-8.06	-6.89	4.00	15.00	190.00	1.97	-21.54	0.91	-10.50	4.00	2.05	1.03	1.43	-5.32	4.00	6.26	0.57		
15.00	200.00	-7.35	-0.33	-24.89	-9.08	4.00	15.00	200.00	0.98	-19.21	0.58	-14.96	4.00	1.58	-0.27	0.59	-8.08	4.00	5.18	-0.36		
15.00	210.00	-3.92	0.50	-27.02	-9.11	4.00	15.00	210.00	1.19	-6.25	-6.04	-9.96	4.00	2.36	1.17	0.65	-6.50	4.00	6.03	0.43		
15.00	220.00	-																				



45.00	190.00	-9.27	-3.11	-1.78	-9.33	4.00	45.00	190.00	1.28	-14.64	-0.54	-10.35	4.00
45.00	200.00	-4.96	-1.19	-5.12	-11.54	4.00	45.00	200.00	1.79	-13.39	-1.15	-15.62	4.00
45.00	210.00	-1.46	-4.89	-4.65	-11.83	4.00	45.00	210.00	0.73	-14.42	0.05	-11.83	4.00
45.00	220.00	-0.88	-4.59	-5.81	-8.89	4.00	45.00	220.00	-0.23	-2.15	-0.34	-17.76	4.00
45.00	230.00	-0.43	-6.73	-6.35	-7.97	4.00	45.00	230.00	-4.78	0.68	-1.77	-25.39	4.00
45.00	240.00	-0.97	-6.96	-7.70	-6.38	4.00	45.00	240.00	-7.17	2.53	-5.27	-23.71	4.00
45.00	250.00	0.00	-13.81	-7.83	-6.29	4.00	45.00	250.00	-6.62	1.05	-7.30	-24.56	4.00
45.00	260.00	-0.66	-23.13	-6.14	-3.94	4.00	45.00	260.00	-11.27	2.04	-15.26	-25.76	4.00
45.00	270.00	-0.80	-15.71	-9.67	-3.15	4.00	45.00	270.00	-16.03	1.83	-17.80	-17.37	4.00
45.00	280.00	0.61	-6.73	-14.96	-4.71	4.00	45.00	280.00	-11.30	2.24	-7.33	-15.35	4.00
45.00	290.00	-1.05	-2.59	-11.89	-9.79	4.00	45.00	290.00	-4.27	2.84	-5.51	-17.97	4.00
45.00	300.00	1.53	-2.98	-7.38	-9.59	4.00	45.00	300.00	-0.86	2.45	-3.56	-16.36	4.00
45.00	310.00	0.32	-2.86	-5.22	-10.29	4.00	45.00	310.00	0.47	2.10	-3.45	-12.11	4.00
45.00	320.00	-0.28	-4.55	-2.86	-4.55	4.00	45.00	320.00	0.77	-0.32	-0.29	-18.33	4.00
45.00	330.00	-1.08	-6.62	-3.70	-4.19	4.00	45.00	330.00	2.14	-4.05	-3.05	-13.76	4.00
45.00	340.00	-2.04	-0.21	-1.12	-2.50	4.00	45.00	340.00	1.66	-8.20	-1.86	-9.44	4.00
45.00	350.00	-5.19	-2.27	-0.12	-1.47	4.00	45.00	350.00	0.13	-17.98	-3.29	-12.27	4.00
60.00	0.00	-12.47	-7.17	-0.60	0.06	4.00	60.00	0.00	-0.29	-18.62	-0.49	-14.02	4.00
60.00	10.00	-6.56	-1.82	-0.86	-3.20	4.00	60.00	10.00	0.83	-22.04	0.65	-16.99	4.00
60.00	20.00	-6.89	-0.89	0.72	-4.61	4.00	60.00	20.00	-0.02	-8.40	-0.67	-21.73	4.00
60.00	30.00	-8.76	-2.19	-5.06	-6.77	4.00	60.00	30.00	-1.74	-12.70	-0.68	-19.09	4.00
60.00	40.00	-4.95	2.66	-6.92	-6.89	4.00	60.00	40.00	-2.73	-23.00	-1.71	-20.18	4.00
60.00	50.00	-5.15	-2.72	-7.19	-4.04	4.00	60.00	50.00	-4.73	-27.90	-5.54	-20.39	4.00
60.00	60.00	-13.55	-7.30	-14.44	-6.35	4.00	60.00	60.00	-5.36	-4.36	-5.40	-14.58	4.00
60.00	70.00	-16.14	-11.33	-6.81	-9.01	4.00	60.00	70.00	-14.75	-5.44	-10.36	-16.07	4.00
60.00	80.00	-11.85	-16.12	-8.40	-12.47	4.00	60.00	80.00	-10.62	-20.49	-9.31	-16.97	4.00
60.00	90.00	-12.42	-15.44	-7.81	-8.57	4.00	60.00	90.00	-13.54	-13.26	-19.13	-15.72	4.00
60.00	100.00	-11.85	-14.33	-14.29	-9.45	4.00	60.00	100.00	-12.88	-4.73	-13.01	-10.76	4.00
60.00	110.00	-11.94	-7.82	-9.15	-32.85	4.00	60.00	110.00	-10.14	-0.71	-15.56	-11.93	4.00
60.00	120.00	-14.36	-13.93	-12.05	-11.01	4.00	60.00	120.00	-11.14	1.19	-8.49	-14.02	4.00
60.00	130.00	-13.77	-12.16	-6.47	-7.96	4.00	60.00	130.00	-8.02	-1.14	-11.13	-9.39	4.00
60.00	140.00	-17.35	-9.02	-8.30	-6.49	4.00	60.00	140.00	-1.53	-0.66	-6.49	-13.10	4.00
60.00	150.00	-14.95	-9.66	-7.35	-6.02	4.00	60.00	150.00	-0.69	-4.47	-8.27	-4.85	4.00
60.00	160.00	-14.11	-9.82	-3.51	-2.79	4.00	60.00	160.00	-0.03	-5.76	-6.59	-15.51	4.00
60.00	170.00	-8.80	-15.92	-3.29	-3.29	4.00	60.00	170.00	0.06	-6.48	-6.84	-11.26	4.00
60.00	180.00	-12.87	-4.42	-2.46	-1.61	4.00	60.00	180.00	-0.32	-9.88	-3.41	-19.15	4.00
60.00	190.00	-8.44	-3.31	-3.92	-1.71	4.00	60.00	190.00	0.43	-18.43	-3.24	-25.85	4.00
60.00	200.00	-5.72	-5.79	-4.26	-3.11	4.00	60.00	200.00	-1.43	-10.52	-0.92	-14.83	4.00
60.00	210.00	-4.25	-10.31	-3.77	-4.66	4.00	60.00	210.00	-1.72	-4.84	-0.26	-22.13	4.00
60.00	220.00	-2.59	-5.46	-5.21	-2.40	4.00	60.00	220.00	-3.30	-1.72	-1.58	-15.20	4.00
60.00	230.00	-1.54	-10.19	-6.95	-4.39	4.00	60.00	230.00	-5.51	-0.67	-1.68	-4.81	4.00
60.00	240.00	-0.84	-8.58	-6.92	-6.20	4.00	60.00	240.00	-7.40	-4.13	-2.77	-19.28	4.00
60.00	250.00	-2.49	-8.99	-4.79	-2.25	4.00	60.00	250.00	-16.20	-0.32	-5.43	-15.65	4.00
60.00	260.00	-3.75	-11.30	-5.00	-0.71	4.00	60.00	260.00	-9.49	-0.21	-12.79	-22.53	4.00
60.00	270.00	-3.64	-10.31	-5.25	0.42	4.00	60.00	270.00	-7.63	0.32	-17.32	-12.25	4.00
60.00	280.00	-3.75	-9.76	-5.57	0.64	4.00	60.00	280.00	-8.20	-1.24	-7.19	-12.53	4.00
60.00	290.00	-2.26	-7.67	-4.32	-0.72	4.00	60.00	290.00	-9.09	-1.62	-4.21	-10.88	4.00
60.00	300.00	-1.50	-6.14	-4.27	-0.84	4.00	60.00	300.00	-2.15	-1.45	-2.20	-17.16	4.00
60.00	310.00	-1.18	-6.38	-5.64	-2.53	4.00	60.00	310.00	-0.53	-0.27	-1.68	-11.44	4.00
60.00	320.00	-1.87	-2.46	-4.33	-2.87	4.00	60.00	320.00	0.47	-1.53	-0.69	-9.99	4.00
60.00	330.00	-3.35	-5.48	-4.02	-1.69	4.00	60.00	330.00	-0.07	-0.62	-1.21	-9.32	4.00
60.00	340.00	-5.80	-0.94	-4.05	1.76	4.00	60.00	340.00	0.43	-26.54	-2.52	-16.54	4.00
60.00	350.00	-5.49	-3.50	-2.32	-2.71	4.00	60.00	350.00	-0.26	-25.11	-1.72	-18.69	4.00
75.00	0.00	-15.65	-4.33	-5.61	0.63	4.00	75.00	0.00	-0.23	-27.26	-1.38	-20.84	4.00
75.00	10.00	-6.48	-5.82	-7.23	0.32	4.00	75.00	10.00	-2.70	-15.09	-1.17	-16.65	4.00
75.00	20.00	-9.03	-0.24	-6.22	-1.70	4.00	75.00	20.00	0.48	-14.81	-1.11	-19.03	4.00
75.00	30.00	-8.01	0.70	-17.54	-6.15	4.00	75.00	30.00	-0.95	-13.09	-2.17	-13.43	4.00
75.00	40.00	-9.72	1.78	-8.12	-7.34	4.00	75.00	40.00	-5.76	-8.68	-3.26	-17.10	4.00
75.00	50.00	-9.92	-10.30	-14.26	-11.71	4.00	75.00	50.00	-4.17	-9.92	-7.42	-15.68	4.00
75.00	60.00	-18.37	-14.43	-9.12	-8.60	4.00	75.00	60.00	-1.91	-4.25	-2.83	-16.00	4.00
75.00	70.00	-20.13	-16.68	-4.74	-6.69	4.00	75.00	70.00	-5.03	-20.45	-7.68	-23.91	4.00
75.00	80.00	-17.71	-20.19	-6.05	-5.11	4.00	75.00	80.00	-3.83	-2.63	-5.35	-22.60	4.00
75.00	90.00	-12.41	-16.76	-4.77	-9.93	4.00	75.00	90.00	-13.58	-1.22	-17.69	-17.56	4.00
75.00	100.00	-14.02	-8.10	-6.7	-11.18	4.00	75.00	100.00	-11.91	-0.67	-7.41	-12.20	4.00
75.00	110.00	-16.32	-7.31	-20.25	-8.83	4.00	75.00	110.00	-4.66	-2.35	-10.88	-7.88	4.00
75.00	120.00	-15.47	-13.10	-12.08	-6.85	4.00	75.00	120.00	-6.09	-1.00	-10.42	-9.77	4.00
75.00	130.00	-14.83	-13.08	-12.30	-8.23	4.00	75.00	130.00	-4.94	-1.15	-11.74	-3.39	4.00
75.00	140.00	-12.16	-5.54	-7.83	-3.87	4.00	75.00	140.00	-2.71	-5.09	-12.82	-13.12	4.00
75.00	150.00	-14.92	-6.39	-11.36	-1.52	4.00	75.00	150.00	-3.61	-4.15	-18.61	-11.63	4.00
75.00	160.00	-11.93	-10.02	-4.80	1.76	4.00	75.00	160.00	-1.52	-8.11	-12.87	-11.18	4.00
75.00	170.00	-6.48	-9.17	-4.52	0.16	4.00	75.00	170.00	0.59	-7.82	-11.69	-14.22	4.00
75.00	180.00	-11.44	-13.43	-1.93	2.85	4.00	75.00	180.00	2.47	-15.29	-6.84	-15.62	4.00
75.00	190.00	-7.60	-5.31	-5.14	3.13	4.00	75.00	190.00	0.39	-11.65	-9.68	-19.17	4.00
75.00	200.00	-9.64	-5.57	-3.53	1.68	4.00	75.00	200.00	-0.08	-10.24	-4.65	-23.91	4.00
75.00	210.00	-8.47	-10.61	-2.64	1.21	4.00	75.00	210.00	-1.77	-17.37	-4.36	-10.18	4.00
75.00	220.00	-6.39	-11.68	-4.40	-3.28	4.00	75.00	220.00	-6.15	-5.42	-2.07	-12.37	4.00
75.00	230.00	-3.89	-12.85	-2.58	-3.71	4.00	75.00	230.00	-6.98	-12.89	-3.33	-20.95	4.00
75.00	240.00	-3.65	-7.75	-3.22	-3.97	4.00	75.00	240.00	-11.19	-7.30	-1.14	-14.08	4.00
75.00	250.00	-8.51	-11.67	-3.89	-2.64	4.00	75.00	250.00	-22.56	-0.37	-8.70	-9.18	4.00
75.00	260.00	-12.48	-12.42	-5.77	-1.61	4.00	75.00	260.00	-11.18	-0.76	-12.49	-9.91	4.00
75.00	270.00	-10.96	-10.77	-7.21	0.03	4.00	75.00	270.00	-11.73	-0.55	-26.11	-14.85	4.00
75.00	280.00	-10.97	-9.28	-5.85	0.49	4.00	75.00	280.00	-12.40	-2.18	-8.98	-14.90	4.00
75.00	290.00	-6.63	-7.43	-5.34	0.13	4.00	75.00	290.00	-10.86	-1.46	-4.57	-12.55	4.00
75.00	300.00	-6.96	-4.85	-3.97	0.61	4.00	75.00	300.00	-12.14	-2.06	0.05	-10.61	4.00
75.00	310.00	-9.65	-2.99	-4.58	1.14	4.00	75.00	310.00	-4.70	-2.24	1.55	-9.86	4.00
75.00	320.00	-8.37	-5.81	-5.47	-0.65	4.00	75.00	320.00	-2.40	-1.08	1.99	-10.12	4.00
75.00	330.00	-11.28	-2.83	-3.17	0.54	4.00	75.00	330.00	-1.09	-2.95	0.69	-10.09	4.00
75.00	340.00	-11.70	-3.67	-3.18	1.20	4.00	75.00	340.00	-2.15	-6.19	1.65	-8.30	4.00
75.00	350.00	-7.30	-6.10	-4.10	3.80	4.00	75.00	350.00					



105.00	100.00	-19.61	-12.63	-9.45	-21.78	4.00	105.00	100.00	-14.38	-12.11	-13.01	-13.70	4.00	-13.24	-9.35	-7.86	-13.07	4.00	-4.55	-10.27
105.00	110.00	-18.45	-17.13	-13.90	-24.48	4.00	105.00	110.00	-15.05	-13.10	-7.27	-6.25	4.00	-13.42	-11.65	-6.42	-6.19	4.00	-2.83	-8.37
105.00	120.00	-9.73	-20.22	-10.07	-8.16	4.00	105.00	120.00	-11.36	-12.21	-12.03	-5.40	4.00	-7.46	-11.57	-7.93	-3.55	4.00	-1.14	-6.72
105.00	130.00	-17.57	-7.45	-17.72	-2.10	4.00	105.00	130.00	-10.37	-5.43	-33.65	-12.83	4.00	-9.61	-3.31	-17.61	-1.75	4.00	-0.16	-5.01
105.00	140.00	-12.56	-7.45	-15.50	-1.19	4.00	105.00	140.00	-5.91	-3.45	-9.72	-12.37	4.00	-5.06	-1.99	-8.70	-0.87	4.00	2.36	-3.24
105.00	150.00	-12.09	-4.74	-10.06	-1.39	4.00	105.00	150.00	-4.06	-3.55	-5.74	-12.63	4.00	-3.43	-1.09	-4.37	-1.08	4.00	3.65	-2.26
105.00	160.00	-11.58	-7.74	-9.58	0.08	4.00	105.00	160.00	-3.59	-4.18	-9.11	-25.50	4.00	-2.95	-4.44	-6.42	0.09	4.00	2.92	-2.77
105.00	170.00	-17.18	-6.12	-6.96	2.39	4.00	105.00	170.00	-2.25	-12.16	-8.03	-15.03	4.00	-2.11	-5.15	-4.45	2.47	4.00	4.25	-1.19
105.00	180.00	-14.29	-7.46	-6.36	3.61	4.00	105.00	180.00	0.45	-15.55	-8.13	-15.97	4.00	0.59	-6.83	0.45	3.66	4.00	5.27	0.06
105.00	190.00	-8.72	-6.19	-6.54	4.61	4.00	105.00	190.00	-2.92	-12.05	-8.81	-13.87	4.00	-1.91	-5.19	-4.52	4.67	4.00	5.25	0.25
105.00	200.00	-9.91	-8.49	-7.05	4.36	4.00	105.00	200.00	-2.53	-11.09	-3.09	-10.59	4.00	-1.90	-6.59	-1.62	4.50	4.00	4.65	0.40
105.00	210.00	-11.45	-8.27	-3.31	3.31	4.00	105.00	210.00	-3.54	-10.35	-4.79	-14.70	4.00	-2.95	-7.69	-1.51	3.38	4.00	4.69	-0.51
105.00	220.00	-8.94	-12.44	-5.65	-0.15	4.00	105.00	220.00	-10.61	-8.67	-1.70	-17.85	4.00	-6.68	-7.15	-0.23	-1.08	4.00	3.13	-2.33
105.00	230.00	-9.87	-6.63	-2.92	-1.71	4.00	105.00	230.00	-19.41	-8.85	-4.38	-24.82	4.00	-9.41	-4.59	-0.88	-1.69	4.00	2.56	-2.98
105.00	240.00	-7.60	-11.06	-4.40	-5.53	4.00	105.00	240.00	-10.37	-7.16	-9.96	-19.55	4.00	-5.76	-5.68	-3.33	-5.36	4.00	1.05	-4.91
105.00	250.00	-11.97	-20.31	-4.04	-3.82	4.00	105.00	250.00	-7.87	-4.26	-12.50	-13.68	4.00	-6.44	-4.15	-3.46	-4.26	4.00	1.74	-4.20
105.00	260.00	-17.78	-15.68	-4.63	-0.51	4.00	105.00	260.00	-9.59	-7.99	-23.23	-15.08	4.00	-8.98	-7.31	-4.57	-0.36	4.00	1.35	-4.03
105.00	270.00	-17.56	-14.97	-3.11	-0.02	4.00	105.00	270.00	-22.11	-11.55	-12.04	-17.48	4.00	-16.25	-9.92	-2.59	0.06	4.00	0.91	-3.74
105.00	280.00	-20.64	-19.21	-1.18	1.78	4.00	105.00	280.00	-12.06	-17.34	-7.02	-11.95	4.00	-11.50	-15.16	-0.17	1.96	4.00	2.52	-1.82
105.00	290.00	-9.98	-21.24	-1.79	2.05	4.00	105.00	290.00	-9.39	-22.51	-2.39	-12.42	4.00	-6.66	-18.82	0.93	2.20	4.00	3.47	-1.07
105.00	300.00	-5.61	-10.90	-3.23	2.81	4.00	105.00	300.00	-6.07	-13.93	-0.06	-8.89	4.00	-2.82	-9.15	1.65	3.09	4.00	5.36	0.15
105.00	310.00	-3.87	-6.02	-4.95	2.21	4.00	105.00	310.00	-8.70	-7.69	0.78	-21.99	4.00	-2.64	-3.76	1.81	2.03	4.00	5.82	0.16
105.00	320.00	-8.20	-4.17	-3.21	1.20	4.00	105.00	320.00	-5.93	-9.10	1.28	-11.52	4.00	-3.91	-2.96	2.60	1.43	4.00	5.75	0.13
105.00	330.00	-9.25	-5.93	-5.25	-2.18	4.00	105.00	330.00	-5.58	-7.28	-0.90	-10.30	4.00	-4.03	-3.54	0.46	-1.56	4.00	4.04	-1.79
105.00	340.00	-9.97	-3.89	-4.47	-1.34	4.00	105.00	340.00	-1.69	-5.24	-0.52	-6.64	4.00	-1.09	-1.50	0.95	-0.22	4.00	5.61	-0.36
105.00	350.00	-9.73	-3.17	-11.71	1.32	4.00	105.00	350.00	-1.97	-9.39	-3.37	-10.92	4.00	-1.30	-2.24	-2.78	1.57	4.00	5.01	-0.83
120.00	0.00	-14.61	-1.81	-19.10	-0.48	4.00	120.00	0.00	0.60	-14.10	-5.00	-12.55	4.00	0.73	-1.56	-4.83	-0.22	4.00	4.79	-1.02
120.00	10.00	-17.10	-13.25	-12.46	0.76	4.00	120.00	10.00	-3.18	-5.92	-11.11	4.00	-3.01	-8.06	-5.05	1.03	4.00	2.89	-2.52	
120.00	20.00	-11.67	-5.13	-14.99	-4.98	4.00	120.00	20.00	-2.49	-7.05	-8.14	-9.24	4.00	-1.99	-2.97	-7.32	-3.60	4.00	2.27	-3.57
120.00	30.00	-8.89	-7.41	-13.67	-9.74	4.00	120.00	30.00	-4.68	-6.62	-7.56	-12.57	4.00	-3.28	-3.99	-6.61	-6.92	4.00	0.77	-5.06
120.00	40.00	-8.37	-8.54	-15.65	-13.31	4.00	120.00	40.00	-8.78	-3.43	-5.65	-8.10	4.00	-5.56	-2.26	-5.24	-12.07	4.00	4.00	-5.11
120.00	50.00	-5.99	-7.44	-7.77	-11.11	4.00	120.00	50.00	-14.17	-1.92	-15.05	-5.53	4.00	-5.38	-0.85	-7.03	-4.47	4.00	1.90	-3.80
120.00	60.00	-5.75	-7.58	-14.60	-18.43	4.00	120.00	60.00	-10.57	-3.42	-18.57	-6.17	4.00	-4.51	-2.01	-13.14	-5.92	4.00	0.48	-4.92
120.00	70.00	-8.95	-15.58	-10.12	-16.66	4.00	120.00	70.00	-8.21	-15.37	-9.00	-6.41	4.00	-5.51	-12.46	-6.51	-6.41	4.00	2.40	-6.93
120.00	80.00	-11.50	-10.23	-9.89	-15.17	4.00	120.00	80.00	-10.81	-6.61	-18.67	-13.03	4.00	-8.13	-5.12	-13.03	-9.71	4.00	2.32	-7.93
120.00	90.00	-20.52	-12.25	-19.14	-15.17	4.00	120.00	90.00	-10.64	-8.32	-13.45	-8.30	4.00	-10.22	-6.84	-12.41	-8.09	4.00	2.94	-8.72
120.00	100.00	-17.30	-10.41	-17.19	-19.50	4.00	120.00	100.00	-23.05	-8.20	-7.56	-6.50	4.00	-18.28	-6.16	-7.11	-6.29	4.00	-2.09	-7.60
120.00	110.00	-12.44	-15.30	-11.89	-8.73	4.00	120.00	110.00	-10.44	-7.90	-2.68	-12.10	4.00	-8.32	-7.17	-2.19	-7.09	4.00	0.18	-5.46
120.00	120.00	-10.04	-19.55	-7.12	-6.73	4.00	120.00	120.00	-7.48	-10.12	-13.41	-21.58	4.00	-5.56	-9.65	-6.20	-6.59	4.00	-0.85	-6.75
120.00	130.00	-14.37	-14.52	-13.63	-1.86	4.00	120.00	130.00	-16.68	-11.73	-8.03	-13.21	4.00	-12.36	-9.89	-6.97	-1.55	4.00	-0.70	-5.76
120.00	140.00	-27.30	-4.26	-7.75	-7.10	4.00	120.00	140.00	-12.48	-4.17	-6.22	-21.53	4.00	-12.34	-1.20	-3.91	-6.67	4.00	0.82	-4.48
120.00	150.00	-9.40	-3.59	-15.15	-2.55	4.00	120.00	150.00	-9.35	-9.18	-19.08	-17.54	4.00	-6.36	-2.53	-13.67	-2.41	4.00	0.80	-4.54
120.00	160.00	-16.27	-17.64	-18.40	-0.85	4.00	120.00	160.00	-21.88	-9.85	-10.89	-15.20	4.00	-15.22	-9.18	-10.18	-0.69	4.00	-1.14	-5.61
120.00	170.00	-17.19	-19.69	-15.99	0.26	4.00	120.00	170.00	-5.73	-12.25	-24.66	-13.69	4.00	-5.43	-11.53	-15.44	0.43	4.00	0.09	-4.29
120.00	180.00	-17.69	-11.31	-8.92	2.90	4.00	120.00	180.00	-5.71	-8.92	-9.21	-17.57	4.00	-5.44	-6.74	-6.05	2.94	4.00	3.21	-1.69
120.00	190.00	-15.44	-8.98	-10.60	2.58	4.00	120.00	190.00	-6.52	-20.86	-9.70	-8.13	4.00	-6.00	-8.71	-7.12	2.93	4.00	2.64	-1.96
120.00	200.00	-8.11	-10.06	-7.62	2.06	4.00	120.00	200.00	-6.93	-11.30	-7.13	-14.48	4.00	-4.47	-7.63	-4.36	2.16	4.00	3.23	-1.97
120.00	210.00	-18.36	-5.04	-6.08	2.31	4.00	120.00	210.00	-6.60	-15.12	-3.71	-10.22	4.00	-6.32	-4.63	-1.72	2.55	4.00	4.16	-1.18
120.00	220.00	-21.94	-8.48	-6.14	0.38	4.00	120.00	220.00	-13.50	-10.95	-3.86	-10.26	4.00	-12.92	-6.53	-1.84	0.74	4.00	2.26	-2.77
120.00	230.00	-11.97	-5.90	-6.63	-1.26	4.00	120.00	230.00	-21.81	-8.61	-2.16	-20.92	4.00	-11.54	-4.04	-0.83	-1.21	4.00	2.51	-2.91
120.00	240.00	-14.52	-7.65	-4.15	-5.18	4.00	120.00	240.00	-17.32	-10.31	-4.35	-12.74	4.00	-12.69	-5.77	-1.24	-4.48	4.00	0.87	-4.48
120.00	250.00	-13.23	-13.05	-2.81	-2.77	4.00	120.00	250.00	-12.23	-7.60	-6.46	-8.38	4.00	-9.69	-6.51	-1.25	-1.72	4.00	1.89	-3.58
120.00	260.00	-15.96	-21.15	-2.65	1.02	4.00	120.00	260.00	-12.34	-3.49	-14.65	-15.67	4.00	-10.77	-2.43	-2.38	-1.11	4.00	3.35	-2.00
120.00	270.00	-11.61	-12.08	-2.72	2.71	4.00	120.00	270.00	-14.82	-0.24	-16.88	-11.79	4.00	-9.91	0.04	-2.56	2.86	4.00	4.76	-0.46
120.00	280.00	-9.66	-9.98	-2.44	2.45	4.00	120.00	280.00	-2.84	-17.87	-7.54	-8.44	4.00	-9.05	-2.04	-1.27	2.79	4.00	4.57	-0.71
120.00	290.00	-6.28	-9.75	-1.51	2.63	4.00	120.00	290.00	-8.40	-8.96	-3.98	-4.96	4.00	-4.20	-6.33	0.44	3.33	4.00	5.15	-0.14
120.00	300.00	-6.95	-9.03	-1.89	1.59	4.00	120.00	300.00	-7.25	-18.15	-1.06	-5.93	4.00	-4.09	-8.53	1.56	2.30	4.00	4.86	-0.39
120.00	310.00	-4.40	-7.80	-4.78	-0.18	4.00	120.00	310.00	-6.32	-5.86	-3.38	-8.38	4.00	-2.24	-3.76	-1.01	3.33	4.00	4.51	-1.37
120.00	320.00	-3.41	-5.91	-2.24	0.24	4.00	120.00	320.00	-2.43	-5.02	-7.70	-10.02	4.00	-0.72	-2.43	-0.90	-0.87	4.00	4.55	-1.44
120.00	330.00	-15.66	-6.24	-7.18	-4.60	4.00	120.00	330.00	-1.58	-7.63	-2.70	-11.67	4.00	-1.79	-3.87	-1.38	-3.82	4.00	3.54	-2.39</



165.00	10.00	-17.47	0.35	-6.49	-9.27	4.00	165.00	10.00	-6.99	-7.64	-6.93	-7.11	4.00	-6.62	0.99	-3.69	-5.05	4.00	2.92	-2.57
165.00	20.00	-17.83	-7.04	-8.87	-14.90	4.00	165.00	20.00	-4.42	-5.38	-7.95	-7.80	4.00	-4.23	-3.12	-5.38	-7.03	4.00	1.20	-4.71
165.00	30.00	-17.10	-11.06	-11.23	-22.00	4.00	165.00	30.00	-3.83	-9.82	-9.44	-8.42	4.00	-3.63	-7.39	-7.23	-8.23	4.00	-0.41	-6.22
165.00	40.00	-11.84	-6.98	-10.69	-24.57	4.00	165.00	40.00	-6.96	-11.51	-9.27	-7.92	4.00	-5.74	-5.67	-6.91	-7.83	4.00	-0.47	-6.45
165.00	50.00	-7.56	-7.92	-10.51	-22.63	4.00	165.00	50.00	-7.54	-9.87	-6.09	-8.57	4.00	-4.54	-5.78	-4.75	-8.40	4.00	0.28	-5.62
165.00	60.00	-8.53	-13.04	-10.86	-13.03	4.00	165.00	60.00	-18.76	-9.37	-6.38	-8.41	4.00	-8.14	-7.82	-5.06	-7.12	4.00	-0.93	-6.86
165.00	70.00	-9.48	-16.68	-10.96	-19.26	4.00	165.00	70.00	-13.12	-6.85	-6.30	-11.18	4.00	-7.92	-6.42	-5.02	-10.55	4.00	-1.22	-7.03
165.00	80.00	-8.80	-21.66	-11.18	-23.78	4.00	165.00	80.00	-14.38	-5.69	-6.42	-8.87	4.00	-7.74	-5.58	-5.17	-8.73	4.00	-0.66	-6.56
165.00	90.00	-9.10	-16.67	-10.26	-17.89	4.00	165.00	90.00	-15.62	-4.71	-10.02	-13.02	4.00	-8.23	-4.44	-7.13	-11.80	4.00	-1.49	-7.16
165.00	100.00	-7.99	-10.80	-10.95	-19.21	4.00	165.00	100.00	-20.28	-4.06	-11.08	-13.84	4.00	-7.74	-3.19	-8.00	-12.73	4.00	-1.25	-6.68
165.00	110.00	-9.10	-10.05	-12.34	-10.91	4.00	165.00	110.00	-21.01	-7.84	-19.48	-11.82	4.00	-8.83	-5.80	-11.57	-8.33	4.00	-2.37	-9.16
165.00	120.00	-19.16	-7.53	-13.50	-13.04	4.00	165.00	120.00	-18.63	-8.97	-18.88	-12.89	4.00	-15.88	-5.18	-13.86	-9.95	4.00	-4.21	-9.29
165.00	130.00	-13.33	-9.26	-12.99	-11.18	4.00	165.00	130.00	-17.71	-15.90	-12.48	-14.72	4.00	-11.98	-8.41	-9.72	-9.59	4.00	-3.81	-9.74
165.00	140.00	-22.23	-12.70	-13.26	-12.90	4.00	165.00	140.00	-15.91	-21.13	-22.06	-18.20	4.00	-15.00	-12.12	-12.72	-11.78	4.00	-6.80	-12.74
165.00	150.00	-17.22	-18.06	-11.16	-13.70	4.00	165.00	150.00	-17.45	-9.60	-18.55	-12.65	4.00	-14.32	-9.02	-10.43	-10.13	4.00	-4.74	-10.58
165.00	160.00	-21.98	-17.15	-11.52	-14.25	4.00	165.00	160.00	-17.12	-15.05	-15.19	-9.73	4.00	-15.89	-12.96	-9.97	-8.42	4.00	-5.34	-10.96
165.00	170.00	-17.29	-13.01	-13.81	-13.71	4.00	165.00	170.00	-20.70	-13.22	-13.40	-11.46	4.00	-15.66	-10.10	-10.59	-9.43	4.00	-5.11	-10.89
165.00	180.00	-15.61	-7.94	-18.68	-9.56	4.00	165.00	180.00	-27.18	-18.34	-16.30	-8.97	4.00	-15.32	-7.56	-14.32	-6.24	4.00	-3.95	-9.22
165.00	190.00	-9.15	-6.51	-11.91	-13.59	4.00	165.00	190.00	-38.48	-9.87	-13.08	-10.68	4.00	-9.14	-4.86	-9.45	-8.89	4.00	-1.85	-7.63
165.00	200.00	-12.84	-7.50	-9.66	-14.76	4.00	165.00	200.00	-19.81	-5.47	-22.47	-16.53	4.00	-12.04	-3.36	-9.44	-12.55	4.00	-2.48	-7.61
165.00	210.00	-13.56	-6.09	-9.01	-18.19	4.00	165.00	210.00	-11.76	-3.35	-14.00	-16.68	4.00	-9.56	-1.50	-7.81	-14.36	4.00	-1.05	-5.93
165.00	220.00	-12.93	-6.66	-8.73	-11.58	4.00	165.00	220.00	-7.52	-2.39	-15.93	-11.14	4.00	-6.42	-1.01	-7.97	-8.34	4.00	0.63	-4.79
165.00	230.00	-12.96	-9.08	-7.41	-13.89	4.00	165.00	230.00	-6.95	-1.18	-16.70	-12.56	4.00	-5.98	-0.53	-6.93	-10.16	4.00	0.84	-4.45
165.00	240.00	-9.81	-10.35	-8.04	-17.09	4.00	165.00	240.00	-9.19	-1.22	-13.63	-9.75	4.00	-6.48	-0.72	-6.98	-9.01	4.00	0.81	-4.56
165.00	250.00	-7.14	-13.14	-11.28	-12.44	4.00	165.00	250.00	-12.98	-2.99	-13.37	-9.76	4.00	-6.13	-2.59	-9.19	-7.89	4.00	-0.06	-5.70
165.00	260.00	-4.32	-14.51	-10.87	-12.30	4.00	165.00	260.00	-15.87	-9.47	-9.23	-9.68	4.00	-4.03	-8.29	-6.96	-7.79	4.00	-0.58	-6.42
165.00	270.00	-3.42	-10.66	-12.74	-11.23	4.00	165.00	270.00	-19.44	-11.27	-5.80	-10.03	4.00	-3.31	-7.94	-5.00	-7.58	4.00	0.27	-5.54
165.00	280.00	-3.54	-20.04	-13.98	-10.27	4.00	165.00	280.00	-14.27	-8.45	-4.76	-5.80	4.00	-3.19	-8.16	-6.34	-8.45	4.00	0.68	-5.15
165.00	290.00	-3.53	-12.79	-16.10	-10.14	4.00	165.00	290.00	-18.79	-3.62	-6.77	-7.77	4.00	-3.40	-3.12	-6.29	-5.78	4.00	1.48	-4.43
165.00	300.00	-3.54	-7.03	-11.94	-6.76	4.00	165.00	300.00	-11.94	-2.19	-9.26	-5.69	4.00	-3.30	-0.96	-7.39	-3.18	4.00	2.61	-3.16
165.00	310.00	-4.39	-4.64	-14.23	-4.71	4.00	165.00	310.00	-18.73	-2.75	-6.37	-5.50	4.00	-4.23	-0.58	-5.71	-2.08	4.00	3.09	-2.72
165.00	320.00	-2.97	0.32	-14.20	-3.92	4.00	165.00	320.00	-10.10	-8.54	-5.82	-3.77	4.00	-2.20	0.85	-5.06	-0.83	4.00	4.47	-1.31
165.00	330.00	-6.58	2.06	-8.62	-3.47	4.00	165.00	330.00	-6.99	-5.63	-7.22	-4.68	4.00	-3.77	2.74	-4.85	-1.02	4.00	4.81	-0.68
165.00	340.00	-10.46	3.44	-5.74	-3.49	4.00	165.00	340.00	-6.76	-8.21	-7.60	-4.93	4.00	-5.22	3.73	-3.56	-1.14	4.00	5.37	-0.14
165.00	350.00	-13.84	3.40	-7.30	-3.60	4.00	165.00	350.00	-6.52	-16.58	-3.56	-4.64	4.00	-5.78	3.44	-4.87	-1.08	4.00	4.76	-0.48
180.00	0.00	-16.85	-8.43	-12.53	-7.41	4.00	180.00	0.00	-11.37	-15.84	-9.52	-11.71	4.00	-10.29	-7.67	-7.76	-6.04	4.00	-1.79	-7.69
180.00	10.00	-14.49	-7.92	-10.73	-6.66	4.00	180.00	10.00	-12.35	-20.28	-10.81	-14.81	4.00	-10.28	-7.67	-7.76	-6.04	4.00	-1.79	-7.69
180.00	20.00	-12.86	-7.69	-9.46	-6.21	4.00	180.00	20.00	-13.78	-31.83	-12.65	-20.15	4.00	-10.29	-7.67	-7.76	-6.04	4.00	-1.79	-7.69
180.00	30.00	-11.71	-7.73	-8.59	-6.04	4.00	180.00	30.00	-15.80	-26.67	-15.34	-38.51	4.00	-10.28	-7.67	-7.76	-6.04	4.00	-1.79	-7.69
180.00	40.00	-10.94	-8.04	-8.05	-6.14	4.00	180.00	40.00	-18.82	-18.63	-19.67	-22.51	4.00	-10.28	-7.68	-7.76	-6.04	4.00	-1.79	-7.69
180.00	50.00	-10.47	-8.63	-7.79	-6.51	4.00	180.00	50.00	-23.94	-14.70	-29.47	-15.95	4.00	-10.28	-7.67	-7.76	-6.04	4.00	-1.79	-7.69
180.00	60.00	-10.29	-9.57	-7.80	-7.17	4.00	180.00	60.00	-39.50	-12.20	-28.47	-12.43	4.00	-10.28	-7.68	-7.76	-6.04	4.00	-1.79	-7.69
180.00	70.00	-10.37	-10.91	-8.07	-8.18	4.00	180.00	70.00	-27.39	-10.47	-19.34	-10.13	4.00	-10.28	-7.67	-7.76	-6.04	4.00	-1.79	-7.69
180.00	80.00	-10.72	-12.82	-8.64	-9.64	4.00	180.00	80.00	-20.48	-9.26	-15.15	-8.53	4.00	-10.28	-7.67	-7.76	-6.04	4.00	-1.79	-7.69
180.00	90.00	-11.37	-15.64	-9.52	-11.71	4.00	180.00	90.00	-16.85	-8.43	-12.53	-7.41	4.00	-10.29	-7.67	-7.76	-6.04	4.00	-1.79	-7.69
180.00	100.00	-12.35	-20.28	-10.81	-14.81	4.00	180.00	100.00	-14.49	-7.92	-10.73	-6.66	4.00	-10.28	-7.67	-7.76	-6.04	4.00	-1.79	-7.69
180.00	110.00	-13.78	-31.83	-12.65	-20.15	4.00	180.00	110.00	-12.86	-7.69	-9.46	-6.21	4.00	-10.29	-7.67	-7.76	-6.04	4.00	-1.79	-7.69
180.00	120.00	-15.80	-26.67	-15.34	-38.51	4.00	180.00	120.00	-11.71	-7.73	-8.59	-6.04	4.00	-10.28	-7.67	-7.76	-6.04	4.00	-1.79	-7.69
180.00	130.00	-18.82	-18.63	-19.67	-22.51	4.00	180.00	130.00	-10.94	-8.04	-8.05	-6.14	4.00	-10.28	-7.68	-7.76	-6.04	4.00	-1.79	-7.69
180.00	140.00	-23.94	-14.70	-29.47	-15.95	4.00	180.00	140.00	-10.47	-8.63	-7.79	-6.51	4.00	-10.28	-7.67	-7.76	-6.04	4.00	-1.79	-7.69
180.00	150.00	-39.50	-12.20	-28.47	-12.43	4.00	180.00	150.00	-10.29	-9.57	-7.80	-7.17	4.00	-10.28	-7.68	-7.76	-6.04	4.00	-1.79	-7.69
180.00	160.00	-27.39	-10.47	-19.34	-10.13	4.00	180.00	160.00	-10.37	-10.91	-8.07	-8.18	4.00	-10.28	-7.67	-7.76	-6.04	4.00	-1.79	-7.69
180.00	170.00	-20.48	-9.26	-15.15	-8.53	4.00	180.00	170.00	-10.72	-12.82	-8.64	-9.64	4.00	-10.28	-7.67	-7.76	-6.04	4.00	-1.79	-7.69
180.00	180.00	-16.85	-8.43	-12.53	-7.41	4.00	180.00	180.00	-11.37	-15.84	-9.52	-11.71	4.00	-10.29	-7.67	-7.76	-6.04	4.00	-1.79	-7.69
180.00	190.00	-14.49	-7.92	-10.73	-6.66	4.00	180.00	190.00	-12.35	-20.28	-10.81	-14.81	4.00	-10.28	-7.67	-7.76	-6.04	4.00	-1.79	-7.69
180.00	200.00	-12.86	-7.69	-9.46	-6.21	4.00	180.00	200.00	-13.78	-31.83	-12.65	-20.15	4.00	-10.29	-7.67	-7.76	-6.04	4.00	-1.79	-7.69
180.00	210.00	-11.71	-7.73	-8.59	-6.04	4.00	180.00	210.00	-15.80	-26.67	-15.34	-38.51	4.00	-10.28	-7.67	-7.76	-6.04	4.00	-1.79	-7.69
180.00	220.00	-10.94	-8.04	-8.05	-6.14	4.00	180.00	220.00	-18.82	-18.63	-19.67	-22.51	4.00	-10.28	-7.68	-7.76	-6.04	4.00	-1.79	-7.69
180.00	230.00	-10.47	-8.63	-7.79	-6.51	4.00	180.00	230.00	-23.94	-14.70	-29.47	-15.95	4.00	-10.28	-7.67	-7.76	-6.04	4.00	-1.79	-7.69
180.00	240.00	-10.29	-9.57	-7.80	-7.17	4.00	180.00	240.00	-39.50	-12.20	-28.47	-12.43	4.00	-10.28	-7.68	-7.76	-6.04			