



RADIAN WRISTBANDS INSTALLATION INSTRUCTIONS

Version1.0

Last Modified Date: 15 January 2023

Prepared by:

Documentation & Support Team

Semnox Solutions, Punja Building Annexe, MG Rd, Lalbagh,
Mangalore, Karnataka - India



Contents

INTRODUCTION..... 3

- Key Functions..... 3**
- Facility Pre-Requisites..... 3**
- Module Pre-Requisites..... 4**

OVERVIEW..... 4

- Hardware Components..... 4**
 - [1. Card Reader](#) 4
 - [2. Radian Wristband and Magnetic Tag Detacher](#) 4
 - [3. Charging Station](#) 5
 - [4. Radian Gateway](#) 9
- Sanitization Needs..... 10**

SETUP INSTRUCTIONS..... 10

- [Gateway Configuration: Wiznet Tool/ Interface Board – Configuration](#) 10
- [Note:](#) 14

COMPLIANCE 15

- FCC compliance and advisory statements 15**
- Radiation Exposure Statement 15**
- Caution 16**

INTRODUCTION

Radian Wristband is a "communicate-with-notification" enabled wristband device which can be used to communicate specific alerts by glowing or vibrating, as per pre-defined setups for notifications.

Radian Wristbands can be used in facilities where the games/ activities/ attractions/ check in-checkout products are allotted based on time. For example, game zones, play areas, attractions etc. The wristband will be provided to the user of the facility/ attraction, and based on the time allotted, and the wristband user will receive notifications on the wristband. The wristbands are customizable using the Parafait Web Management Studio and Parafait POS applications. These wristbands when issued, need to be charged adequately, and must be accessible within the defined facility, to communicate constantly to a Gateway device.

Key Functions

The key function of the Radian wristbands include:

- Receiving and sending time-triggered notifications
- Notifications with glow and vibrate features.
- RFID enabled.
- Customizable based on requirements.

Facility Pre-Requisites

Before you setup your product, it is recommended that the following needs to be considered:

- The number of wristbands required for the business (Based on the number of visitors or expected visitors in the facility for which you would like to set up the Radian wristbands).
- The distance of the facility from the server/ issuing POS based on which the number of gateways to be placed, and the locations for placements of the gateways can be identified. This is needed to enable constant communication with the gateway and the radian devices, and help to enable wristband roaming (where a wristband with low range from the line of communication network can connect to the next available gateway)
- An area within the facility to set up the charging stations for the wristbands, based on the number of charging stations required.
- POS machine connected to the gateway, which also acts as the issuing POS.
- Bins for storage of charged wristbands.
- A wristband collection center connected to a POS, where the collection bins for the wristbands can be placed and the return of the wristband device can be completed. (The customer will return the wristband at the collection POS and the POS user must tap the band on the card reader and complete the return using a refund card process).

Module Pre-Requisites

- **Parafait Suite Knowledge:** The document assumes that the user is familiar with **Web Management Studio (WMS)**, **Parafait POS**, **Parafait Web**, its navigation and usage.
- **Pre-programmed Radian Wristbands**

OVERVIEW

Hardware Components

1. Card Reader
2. Radian Wristband and Magnetic Tag Detacher

The Radian Wristband is a wearable device that is designed to notify communication using the glow and vibrate features. Radian Wristbands are RFID-enabled devices.



Radian Wristbands facilitate:

- Real-time status monitoring of individual wristbands, for all bands.
- Viewing the battery status and wristband usage details.
- Sending and receiving notifications for the configured wristbands
- Custom notification settings – glow, vibrate, light patterns, light color.

First use: Charge the wristband to 100% level before first use. Ideally it will take about 2 hours for the wristband to be charged completely.

Subsequent use: It is recommended to charge the wristband after every use. On average, a fully charged wristband will provide a life of 24 hours. The usage timer for the wristband can be activated or deactivated by tapping the wristband into the entry/exit point for the facility/Check-in, as defined in the POS.

3. Charging Station

Pre-requisites:

- Power supply required for the charging station 12V 5Amps adapter
- Charging Station

Charging Station:

The charging station is a series of charging points laid as a compact rack with each row supporting charging for 10 tags with 5 such rows.



These charging stations are mounted on the wall to provide a stable platform.

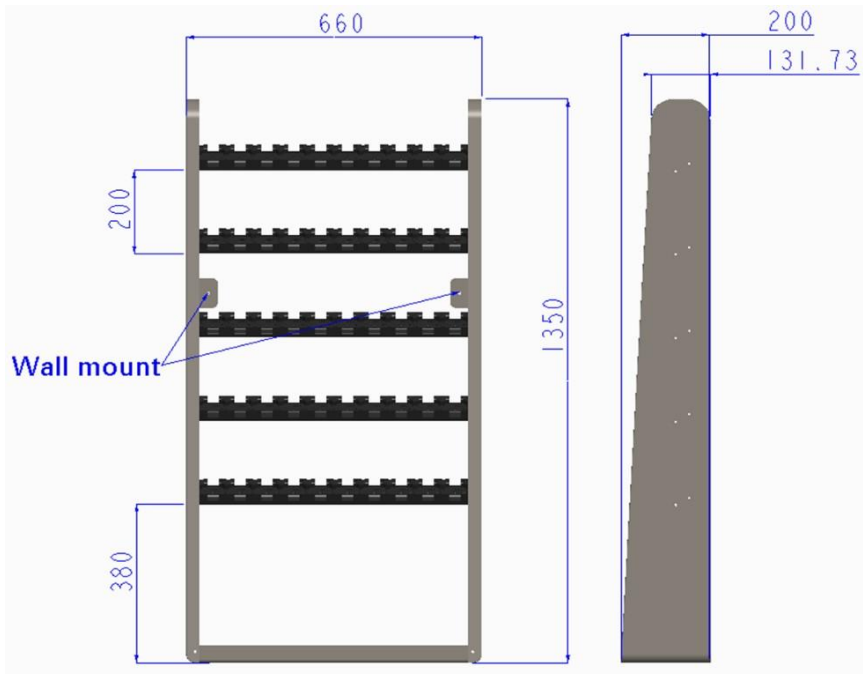

Charging the Radian Wristbands

To charge the Radian wristbands, the band needs to be placed on the charging port of the charging station ensuring that the charging pins at the rear of the radian wristband device are placed accurately on the pins on the charging port.

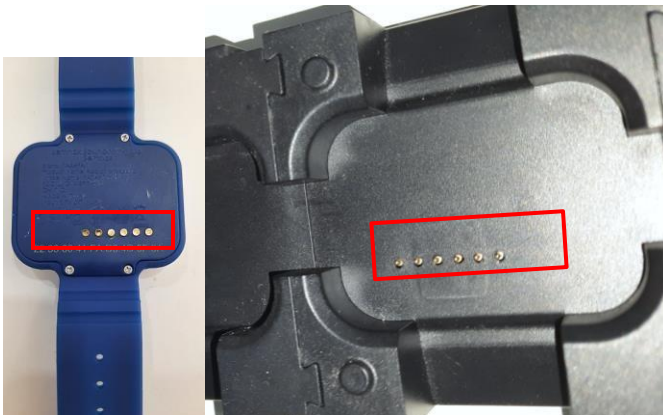

After placing the wristbands, plug in the charging port to the power supply and switch on the power supply. At a time, 50 wristbands can be charged using one Charging station which is connected to a single source of power supply.



The Radian Wristband ideally needs to be charged after every use.

Wristband colors and battery indicators:

Color	Indicator
Red	Indicates that the wristbands are not placed on the charging points correctly. In this case remove the wristband and place the band back on the charging station.
Orange	Charging
Green	Full charged
Chase Green	Remove from Storage (When a wristband in storage needs to be reactivated, it needs to be placed on the charging station, and the wristband will display chasing green glow on the device and the device will be removed from storage.)

The amount of charge in the Radian Wristband can be viewed on Parafait POS. Based on the settings for the wristband, if the battery life is below a set percentage (as defined in WMS), POS will disallow the issue of the wristband to a guest.

Viewing the Battery Status of Radian Wristbands

Step 1: To view all the notification devices issued, from the **POS Home** screen, go to **Tasks > Notification Devices**.

Note: The access to the Notification Device panel in tasks is based on the access controls provided to the user/ user role.



Step 2: POS will display the **Notification Tag Device Summary** screen. On this screen a summary of all the notification devices can be viewed.

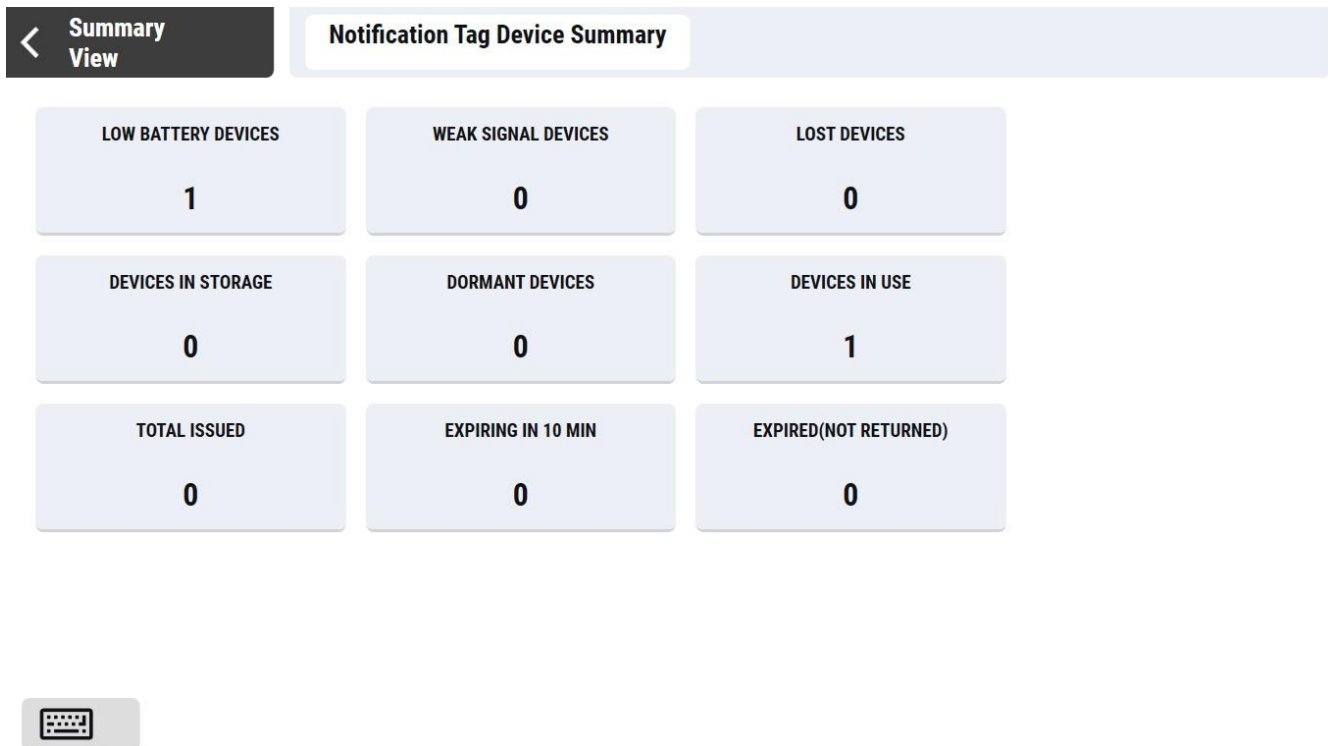

Step 3: To view the devices which are low on battery, click on the **Low Battery Devices** button.

From the **Low Battery Devices** screen it is easy to locate the devices which have low battery. By default, POS will display devices which have battery below 30%. Change the battery percentage to view devices which have battery below a certain percentage.

In this, the user can search for devices below a specific battery percentage as well, and if needed put them to storage, and charge them completely before reissuing the same to another POS user.

Notification Tags View

Notification Devices

Notification Tags

Status: Select

Search By: Battery Percentag

Enter Value: 30

SEARCH CLEAR

Storage	Tag Number	Last Communicated On	Device Status	Ping Status	Battery Status	Signal Strength	Expiry Date
<input type="checkbox"/>	160CDCAB			<input checked="" type="checkbox"/>	0%		
<input type="checkbox"/>	968CD9AB			<input checked="" type="checkbox"/>	0%		

SAVE REFRESH CLOSE MANUAL EVENTS

Windows taskbar: Type here to search, 17:45, 17-06-2021

4. Radian Gateway

Gateway acts as a single point of communication for all the Radian Wristbands within an attraction/ facility. To enable receiving and sending of data to the wristbands, configure and connect the Gateway to your network. The configurations for each of the wristbands can be made using Parafait WMS.

- To enable receiving and sending of data to the wristbands, configure and connect the Gateway to your network.
- The configurations for each of the wristbands can be made using Parafait WMS.



Sanitization Needs

We strongly believe that the pandemic has taught us not to take chances with safety and health. Keeping this in mind, we highly recommend that proper sanitization guidelines are followed in the stores.

As a part of this, we recommend sanitization of all the wristbands collected at the collection points. Sanitizer sprays are recommended. Take care to ensure that all the wristbands are carefully sanitized before putting them back on the charging stations or storage bins.

SETUP INSTRUCTIONS

Gateway Configuration: Wiznet Tool/ Interface Board – Configuration

The Radian Wristband uses a Gateway to communicate between the wristband and the game server. This access point needs to be configured to the LAN. The access point is configured using the Wiz107SR configuration tool. This tool is usually provided and installed by Semnox. It can also be downloaded from the link:

https://www.wiznet.io/wp-content/uploads/wiznethome/S2E%20Module/WIZ107_108SR/Utility/WIZ107_108_config_tool.zip

Follow the instructions and install the **WIZ107/108 Config Tool**. Launch the Wiznet tool after the installation is successful.

Step 1: Launch the Wiznet tool. Click **Search** at the top of the screen.

The **Search** function is used to search all devices existing in the same LAN or WAN. By using **UDP broadcast**, all connected devices in the same subnet will be found. If the **TCP unicast** method is selected, the specified IP address must be given. The identification code must be input if the device has been configured with one identification code.

Select the relevant option and click on **Search**.

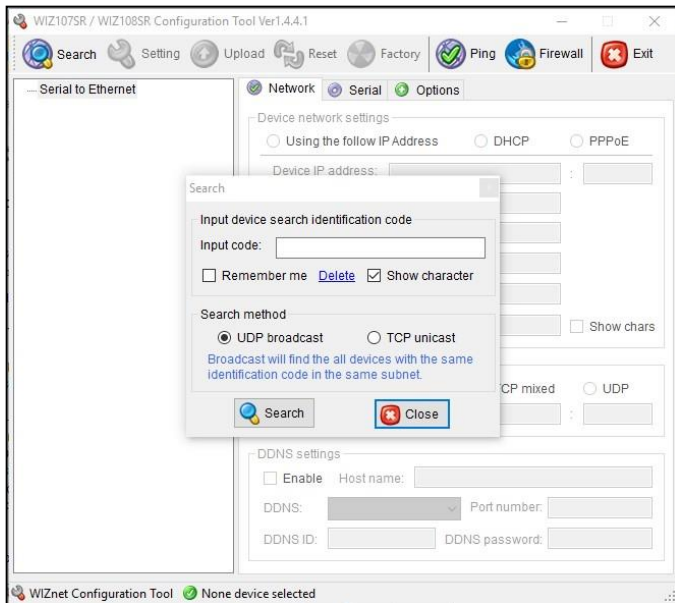

Step 2: From the list of Mac addresses which appear on the search, Select the MAC to configure. The Mac ID of the device will be printed on the Gateway device.

MAC of the LAN devices that are connected to the network is displayed. Select the MAC to configure

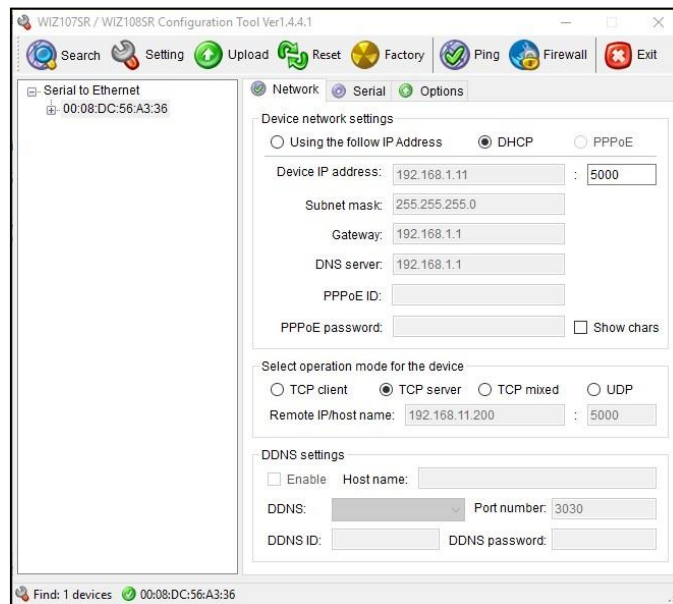

Step 3: Network Configuration

- Set the **Device network settings** configuration to 'Use the follow IP Address". It is recommended to use the module in static IP mode.
- Enter the **Device IP address**, **Subnet mask** and **Gateway**. While assigning static IP, take all necessary precautions that the same IP is not assigned to any other device in the same network.
- Click **Setting** to save the parameters.

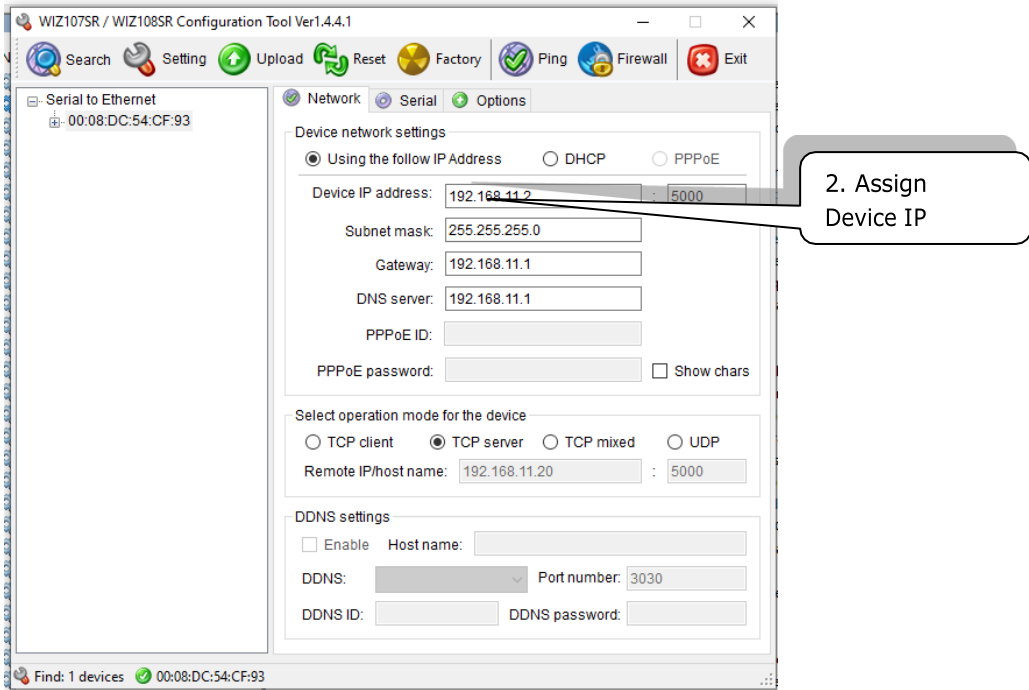
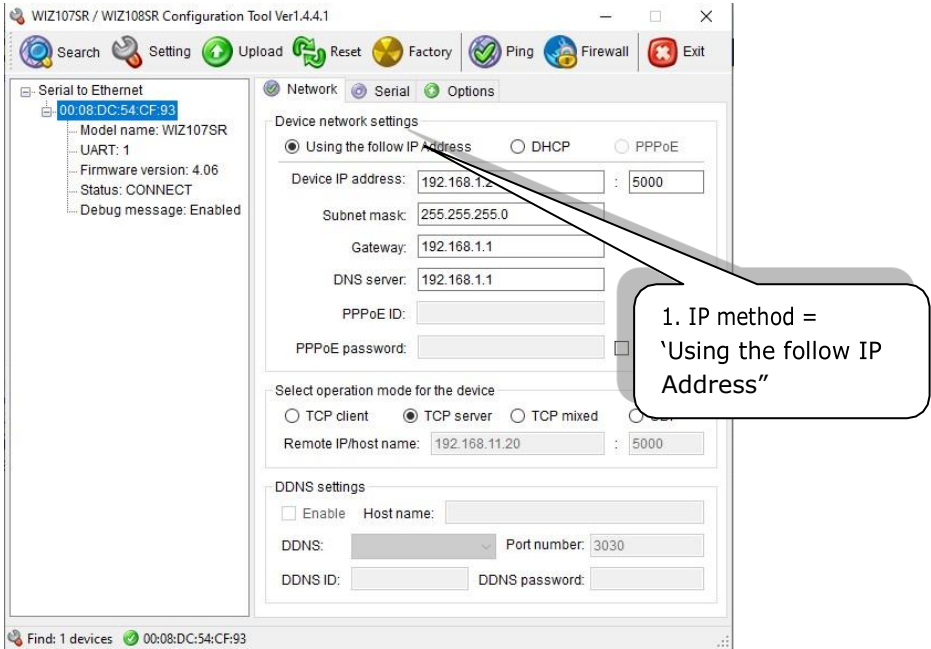

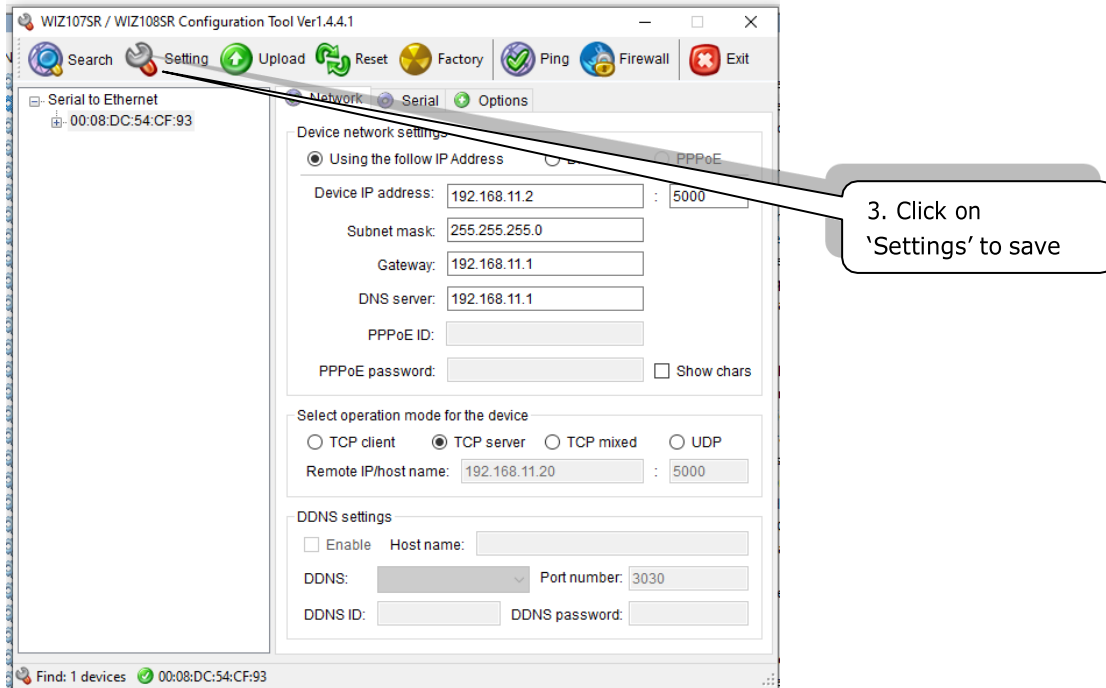

Step 4: Click on the **Serial** tab. Verify if the values are as shown in below reference image.

- BaudRate (R): 115200
- Time (T) = 7ms
- Size (Z) = 0 Bytes
- Character (C) = 00
- Click on 'Setting' to save the changes.

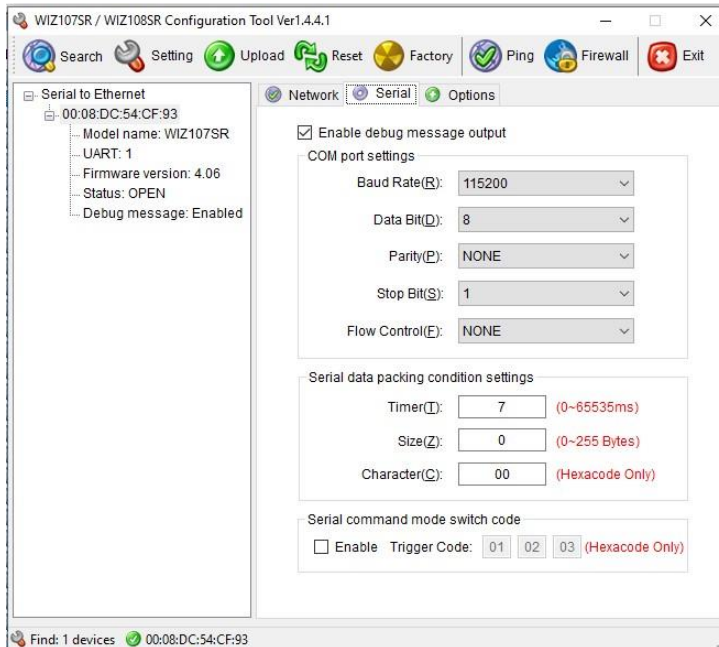

Step 5: Click on the tab, 'Option'.

- Set Inactivity Time = 0 seconds
- Click on '**Setting**' to save the changes.

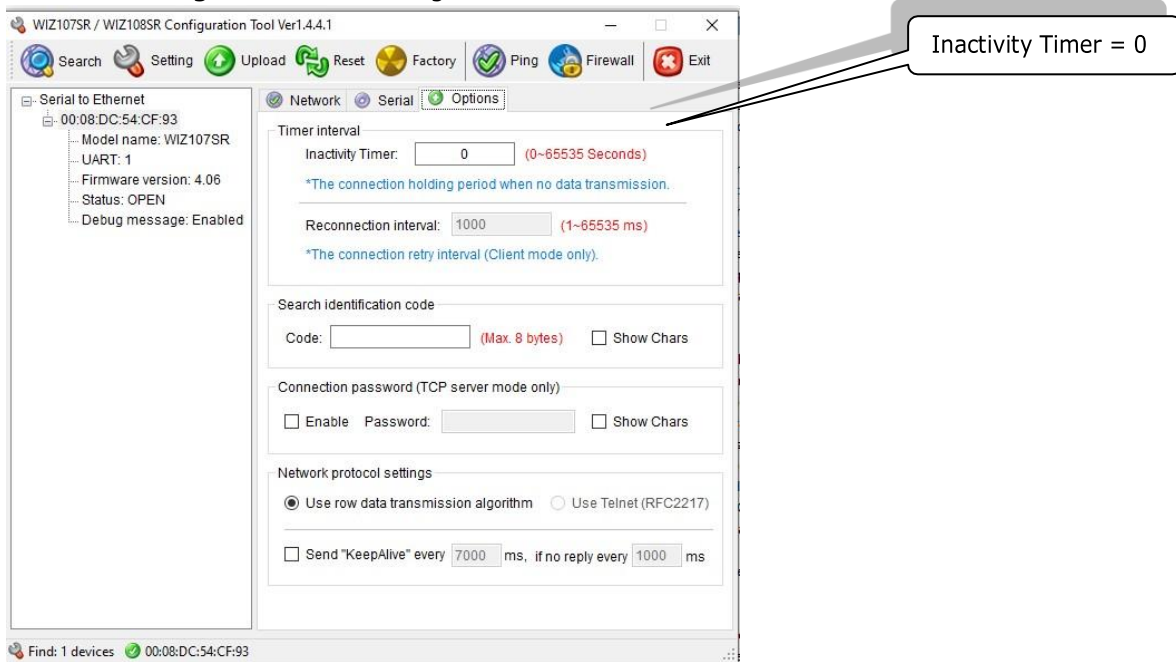

The Gateway setup is complete.

After completing the setup, click on the Reset button to refresh and reset the gateway configurations.

Note:

1. You can test the communication of the tags with the gateway using the Radian Debug tool and confirm the communication status of the bands and the gateway.
2. After completing the settings, if there are still any issues in connecting to the gateway during the initial installation process, restart the gateway, and try to reconnect.
3. Other quick debug methods:
 - a. There are two main logs created as part of Parafait Server Service. ParafaitRadianServer and Radian Gateway log (log name will be gateway name). Log file will clearly give details of connectivity and whether device is communicating with the gateway.
4. A first level analysis should be based on DEBUG tool. [Click here to download the debug tool](#). For details on the Debug tool, refer to the [Radian Debugging Document](#) and navigate to the section on Using the Radian Utility Tool.

SAFETY USAGE

Please note that both T-SCREWS and WALL ANCHOR, essential for safe installation, are included with this device. Each set comprises three units of these components, all measuring 25 mm in length and possessing a thickness of 3mm, in strict adherence to the requirements outlined in IEC 62368-1 for safe and reliable installation.

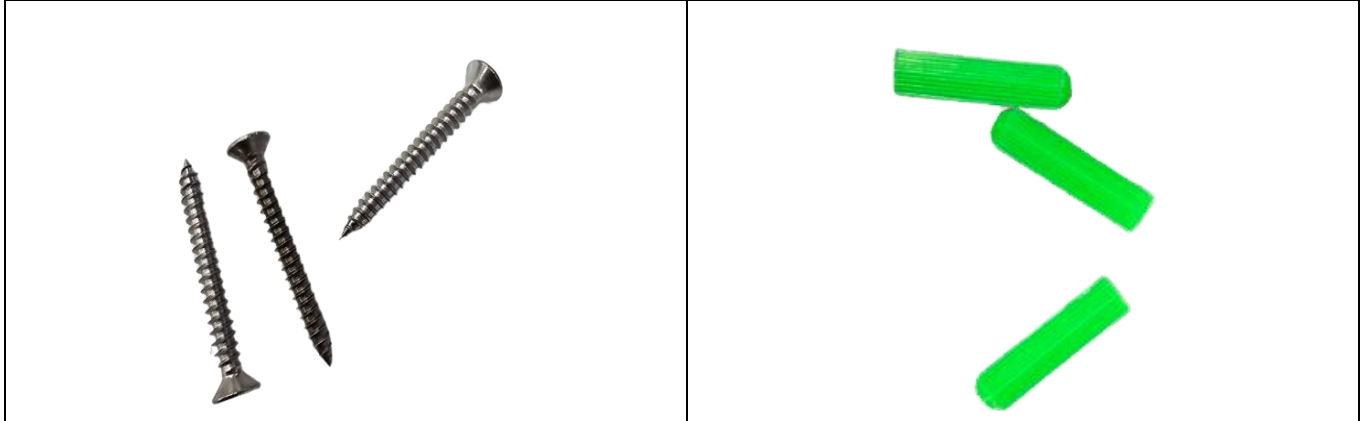

COMPLIANCE

FCC compliance and advisory statements

This hardware device complies with Part 15 of the FCC Rules. Operation is subject to the following two conditions: 1) this device may not cause harmful interference, and 2) this device must accept any interference received, including interference that may cause undesired operation. This equipment has been tested and found to comply with the limits for a Class B digital device, pursuant to Part 15 of the FCC Rules. These limits are designed to provide reasonable protection against harmful interference in a residential installation. This equipment generates, uses, and can radiate radio frequency energy and, if not installed or used in accordance with the instructions, may cause harmful interference to radio communications. However, there is no guarantee that interference will not occur in a particular installation. If this equipment does cause harmful interference to radio or television reception, which can be determined by turning the equipment of and on, the user is encouraged to try to correct the interference by one or more of the following measures: 1) reorient or relocate the receiving antenna; 2) increase the separation between the equipment and the receiver; 3) connect the equipment to an outlet on a circuit different from that to which the receiver is connected; 4) consult the dealer or an experienced radio/TV technician for help. Where shielded interface cables have been provided with the product or specified additional components or accessories elsewhere defined to be used with the installation of the product, they must be used in order to ensure compliance with FCC regulations.

Caution: Any changes or modifications not expressly approved by the party responsible for compliance to this equipment would void the user's authority to operate this device. This Device complies with FCC & IC radiation exposure (exemption) limits.

Radiation Exposure Statement

The product complies with the FCC portable RF exposure limit set forth for an uncontrolled environment and are safe for intended operation as described in this manual. Further RF exposure reduction can be achieved if the product can be kept as far as possible from the user's body or set the device to lower output power if such a function is available.

Wearable Gateway – PARAGWW01
FCC ID: G7H-SPRGW01

Radian Wristband – PARAWTCH01
FCC ID: G7H-SPRWB01

This product contains a Li-ion battery. Do not ingest battery, a Li-ion battery, the saliva triggers an electric current which causes a chemical reaction that can severely burn the esophagus in as little as two hours, creating an esophageal perforation, vocal cord paralysis, or even erosion into the airway (trachea), or major blood vessels. Can cause serious internal chemical burns and can lead to death. If the battery compartment does not close securely, stop using the product and keep it away from children. Keep new and used batteries away from children. If you think batteries might have been swallowed or placed inside any part of the body, seek immediate medical attention. The marking information is located at the back of apparatus.

Caution

To prevent electric shock, the user should avoid: Replacing the battery with an incorrect type that can defeat a safeguard; disposal of a battery in a fire or a hot oven, or mechanically crushing or cutting a battery, which can result in an explosion; leaving a battery in an extremely high temperature surrounding environment that can result in an explosion or the leakage of flammable liquid or gas; a battery subjected to the extremely low air pressure that may result in an explosion or the leakage of flammable liquid or gas.