

CAUTION-ELECTRICALLY OPERATED PRODUCT:
NOT RECOMMENDED FOR CHILDREN UNDER 8 YEARS OF AGE. AS WITH ALL ELECTRIC PRODUCTS, PRECAUTIONS SHOULD BE OBSERVED DURING HANDLING AND USE TO PREVENT ELECTRIC SHOCK.
INPUT: 120V AC 60Hz 10W. OUTPUT: 14.4V DC 500mA.

NEW BRIGHT

OWNER'S MANUAL

Please read and understand all precautions prior to use.

- Model / Modèle No. GF31HHA (Remote), GF1410A (Vehicle)

Thank you for choosing a premium New Bright product.

**USA & Canada
30-Day Limited Warranty**

New Bright Industries warrants to the original purchaser that this product will be free of defects in materials and workmanship for thirty (30) days from the date of purchase. In the event of such defect within the warranty period, New Bright will repair or replace the product at our sole discretion. This warranty does not cover damage resulting from unauthorized modifications, accident, misuse, or abuse.

Should your item have a defect covered under this warranty, first call the toll free number listed below. Most problems can be resolved in this manner. If necessary, you will be issued a Return Authorization (RA) number and instructions on how to obtain a Product Return Form. The Product Return Form is to be used when returning a product to us (postage pre-paid and insured by the consumer).

When returning a defective product, please package the product, the Product Return Form and a copy of the dated sales receipt as proof of purchase. Be sure to mark the RA number on the Product Return Form. If the product is returned without a dated sales receipt, it will be excluded from coverage under this warranty. Please allow 4 to 6 weeks for delivery of repaired or replacement vehicles (depending on your location).

New Bright Industries' liability for defects in materials and workmanship under this warranty shall be limited to repair or replacement at our sole discretion. In no event shall we be responsible for incidental, consequential or contingent damages (except in those states that do not allow this exclusion or limitation).

Valid only in the USA & Canada.

Contact New Bright Industries Customer Service Toll Free at:
1-877-NBI-TOYS
(1-877-624-8697)

Monday through Friday, 8:00 AM to 5:00 PM Eastern Time

L575112846/JN120-16

Table of Contents

- Section 1: Table of Contents**
- Section 2: Component Checklist**
- Section 3: Charging the Battery**
- Section 4: Removing the Battery Cover**
- Section 5: Battery Installation in Vehicle**
- Section 6: Vehicle Features and Functions**
- Section 7: Transmitter Battery Installation**
- Section 8: How to Drive
Using the Transmitter**
- Section 9: Proper Use
Precautions and Care**
- Section 10: Trouble Shooting and Support**
- Section 11: Cautions**

New Bright

Component Checklist

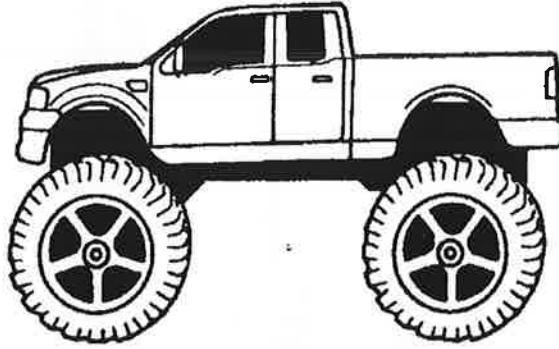

1 Radio Control Vehicle

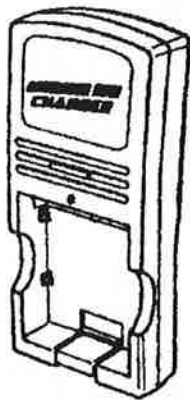

1 Battery Charging Unit



1 6.4V Lithium-Ion Battery Pack

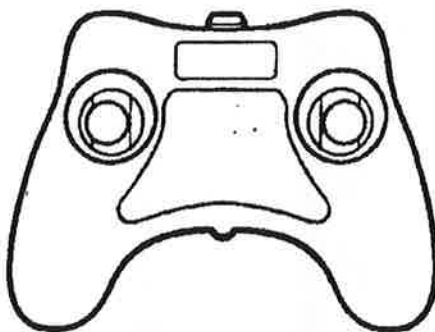

1 Radio Transmitter

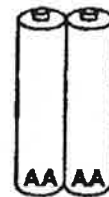

2 AA Batteries

Battery

Charging the Battery

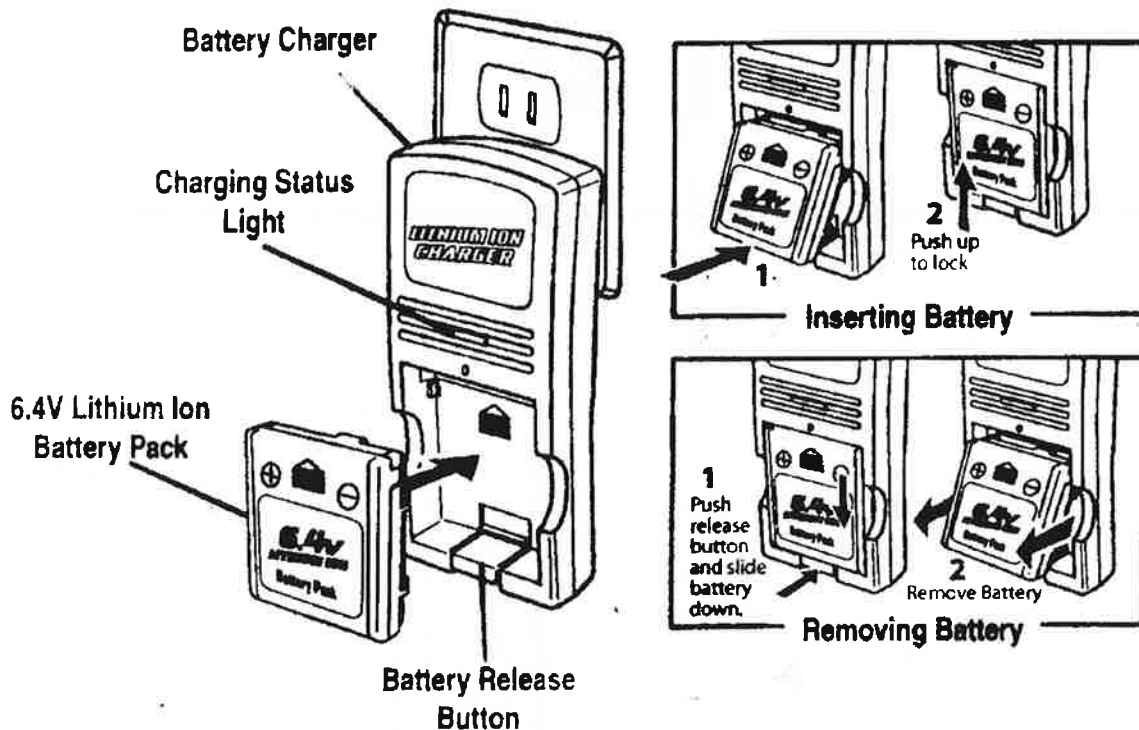

1. Insert the 6.4V Lithium Ion rechargeable battery pack securely into the charger and push up to lock. Be sure the arrows are properly matched (as shown above).
2. Plug the Charger into a standard indoor electrical outlet. This power unit is intended to be correctly orientated in a vertical or wall mount position.
3. Allow battery to charge for 1-1.5 Hours. Charging Status Light will be solid red while battery is charging. When charging is complete, light will blink green.
4. To remove the battery, press and hold the release button and slide battery down to unlock (as shown above).
5. Charge will last approximately 12 minutes depending on terrain and driving style.

IMPORTANT: It is normal for the battery pack to become warm after charging and/or use. Be sure to allow the battery pack to cool before using or recharging. Recharging a warm battery pack will greatly reduce the battery life.

ATTENTION PARENTS:

- The Battery Charger & Battery Pack need to be periodically examined for potential hazards. Any potentially hazardous parts need to be repaired or replaced.

Vehicle

Removing the Battery Cover

Firmly press TAB in the direction of the ARROW and lift to open battery compartment cover.

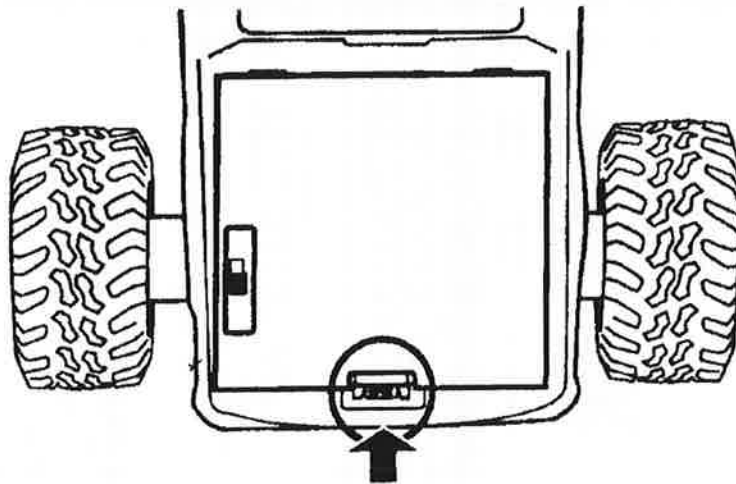

To **replace** the cover, align the **two** TABS and slide forward in the direction of the **ARROWS**.

Battery cover will click when locked into place.

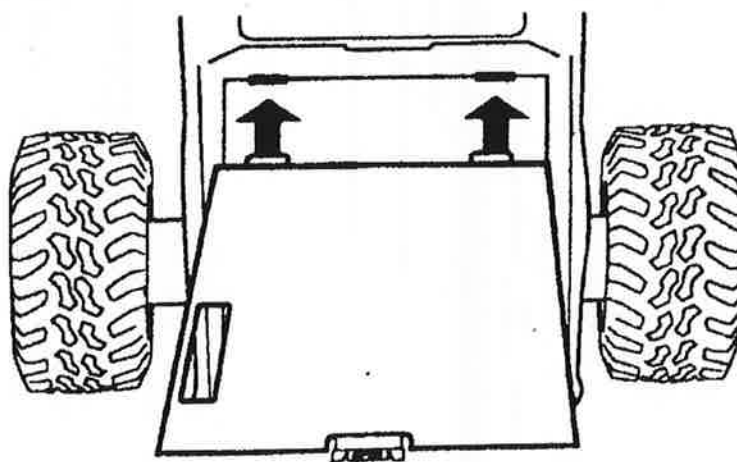

Vehicle

Features and Functions

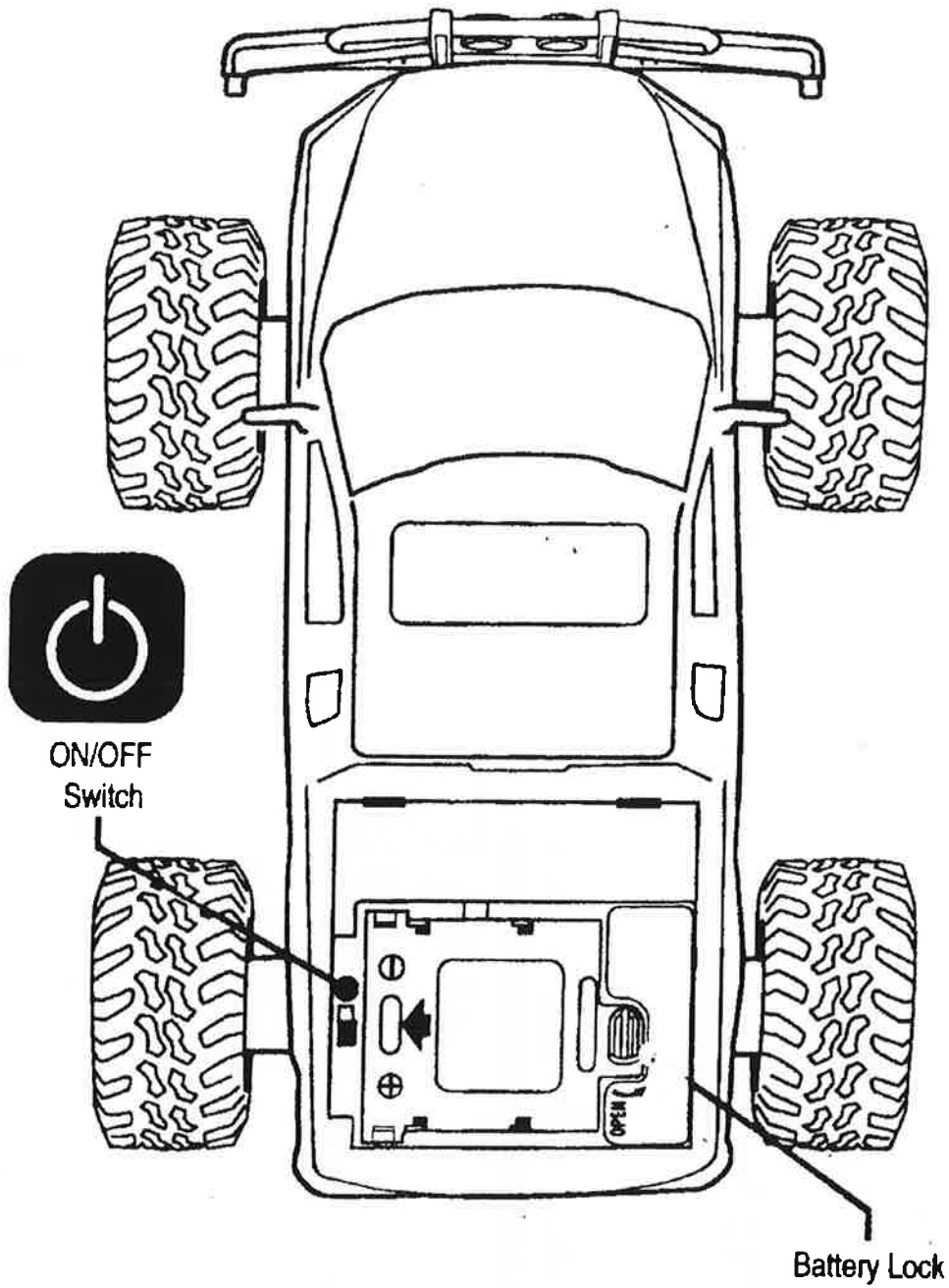

Vehicle

Battery Installation

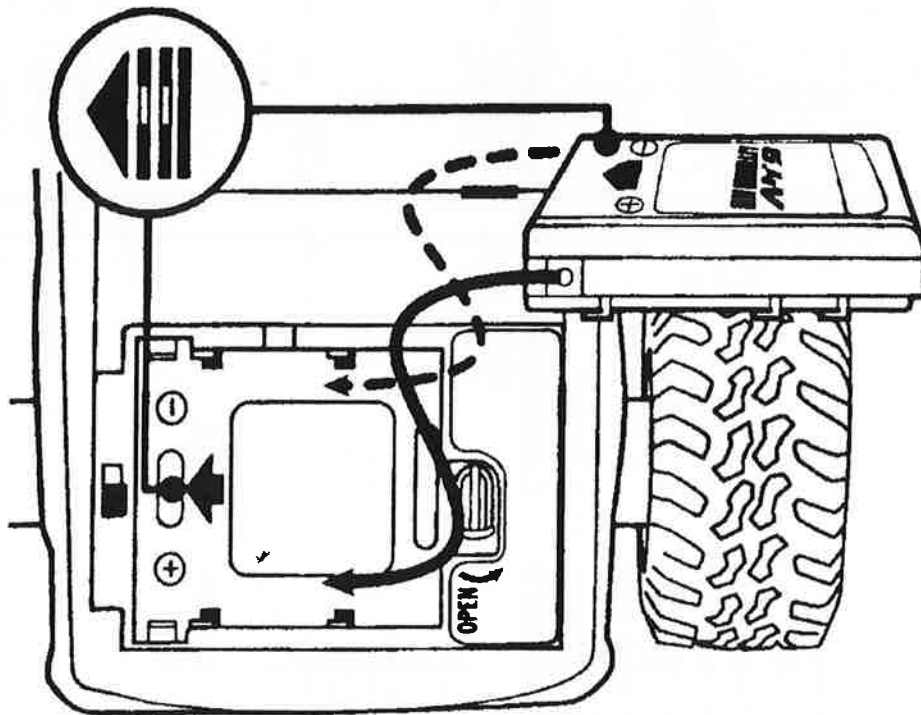

Locate and align arrow on battery pack with arrow inside battery compartment. Place battery pack in battery compartment and slide battery forward in direction of arrow. Once in place, turn locking tab to keep battery pack secure.

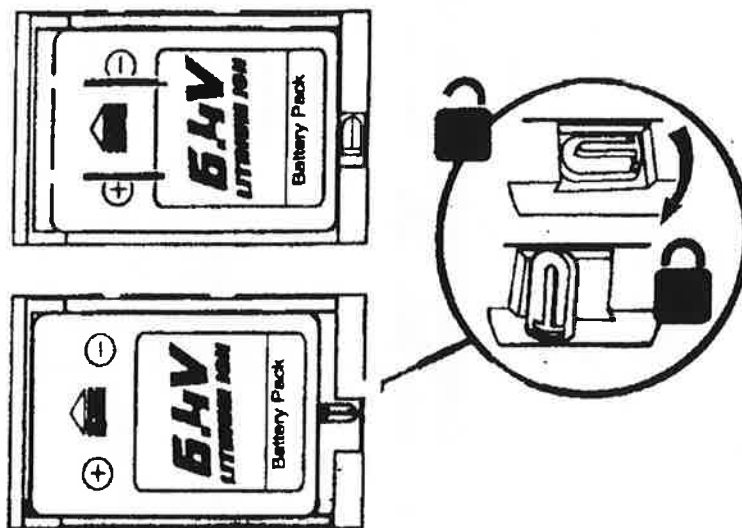

If battery pack is not completely in place locking tab will not fully turn.

Transmitter

Battery Installation

Firmly press TAB in the direction of the ARROW and pull back to open battery compartment cover.

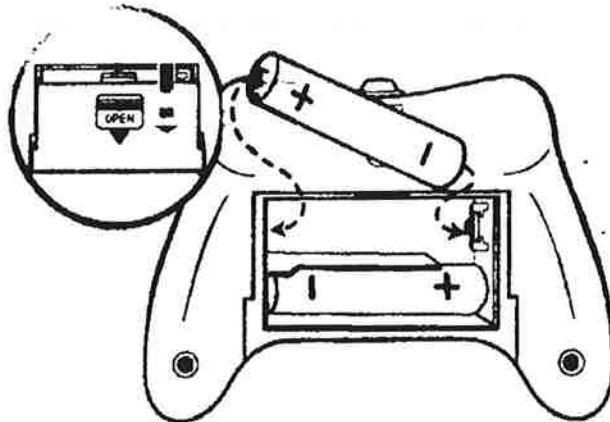

Install 2 "AA" batteries as shown, making sure (+) and (-) markings on batteries line up with the (+) and (-) markings in the battery compartment.

Close battery compartment cover.
Cover should click when locked in place.

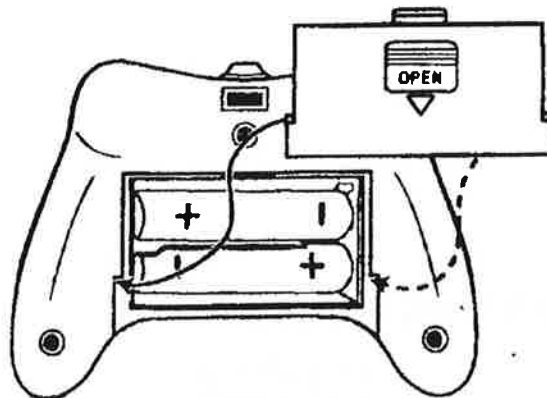

Note: When replacing Transmitter batteries:
Use alkaline batteries only.
Do not mix old and new batteries.
Do not mix alkaline, standard or rechargeable batteries.

How to Drive

Using the Transmitter

STANDARD DRIVING

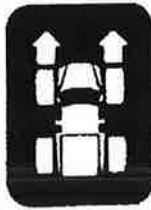

FORWARD/REVERSE DRIVING

Push BOTH joysticks forward for Forward Driving.

Pull BOTH joysticks back to drive in Reverse.

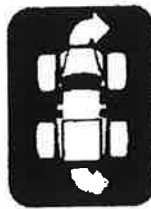
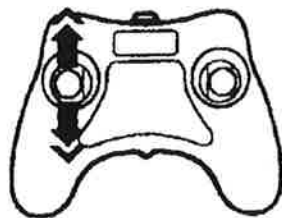

RIGHT TURNING

Push LEFT joystick forward to turn right while driving forward. Pull LEFT joystick back to turn right in reverse.

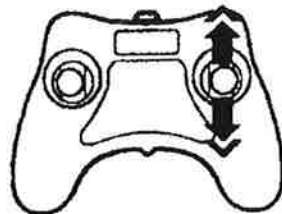

LEFT TURNING

Push RIGHT joystick forward to turn left while driving forward. Pull RIGHT joystick back to turn left in reverse.

POPPING WHEELIES

To pop wheelies, quickly toggle between Reverse Driving and Forward Driving by first pulling back on both joysticks, then pushing them both forward.



WHEELIE SPINS - Clockwise

While in wheelie position, push LEFT joystick as shown for Clockwise Spinning.

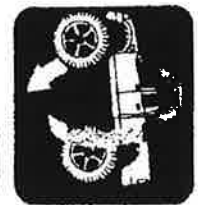
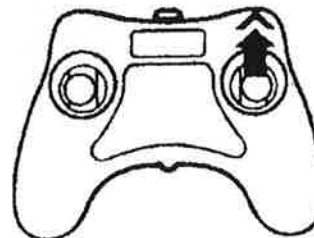

WHEELIE SPINS - Counter-Clockwise

While in wheelie position, push Right joystick as shown for Counter-Clockwise Spinning.

This transmitter is equipped with 2.4GHz technology which allows up to 6 vehicles to be raced at the same time.

The transmitter will automatically sync with the vehicle.

Proper Use

Precautions and Care

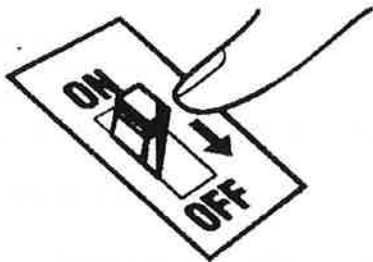

Switch vehicle OFF
when not in use.

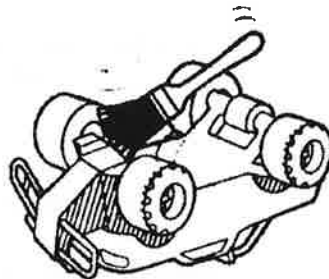

Brush areas where
dirt gets trapped.



Wipe body with a
soft rag or cloth.

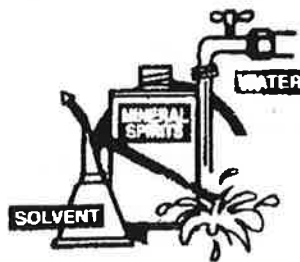

Do not use chemicals
or water to clean.

Support

Trouble shooting & Support

Problem - Vehicle does not move or moves slowly.

- Make certain there are fresh batteries in the transmitter and that they have been installed in the correct position.
- Are the (+) and (-) markings on the batteries in the same position as the (+) and (-) markings in the Transmitter Battery Compartment?
- Has the Battery Pack been installed in the vehicle?
- Has the rechargeable Battery Pack been fully charged?
- Are the (+) and (-) markings on the Battery Pack in the same position as the (+) and (-) markings in the Battery Compartment?
- Are the metal contact tabs touching, rusty or dirty in the transmitter?
- Make certain that the vehicle ON/OFF switch is in the "ON" position.

Problem - Vehicle moves by itself or exhibits reduced range from the transmitter.

- Make certain there is no outside radio interference in your area. The best way to test this is to take the vehicle as far away from radio towers, electrical lines or tall buildings as possible to ensure no further radio interference will occur.

FCC CAUTION:

Changes or modifications not expressly approved by the party responsible for compliance could void the user's authority to operate the equipment.

NOTE: This equipment has been tested and found to comply with the limits for a Class B digital device, pursuant to Part 15 of the FCC Rules. These limits are designed to provide reasonable protection against harmful interference in a residential installation. This equipment generates, uses and can radiate radio frequency energy and, if not installed and used in accordance with the instructions, may cause harmful interference to radio communications. However, there is no guarantee that interference will not occur in a particular installation. If this equipment does cause harmful interference to radio or television reception, which can be determined by turning the equipment off and on, the user is encouraged to try to correct the interference by one or more of the following measures:

- Reorient or relocate the receiving antenna.
- Increase the separation between the equipment and receiver.
- Connect the equipment into an outlet on a circuit different from that to which the receiver is connected.
- Consult the dealer or an experienced radio/TV technician for help.

New Bright

Cautions

- Do not leave the toy unattended while charging it.
- Battery charging should be done by adults.
- Charge the toy on a non-flammable surface and keep it away from flammable items
- Turn the charger off when the toy's battery is charged, and always unplug it from the toy.
- Disconnect AC wall chargers from outlets while not in use.
- If the toy has been damaged, immediately stop use, unplug, and safety move the toy away from flammable materials.
- Follow the manufacturer's instructions for charging the toy. **DO NOT** charge longer than recommended.

RSS Statement

This device complies with Industry Canada licence-exempt RSS standard(s). Operation is subject to the following two conditions: (1) this device may not cause interference, and (2) this device must accept any interference, including interference that may cause undesired operation of the device.

Le présent appareil est conforme aux CNR d'Industrie Canada applicables aux appareils radio exempts de licence. L'exploitation est autorisée aux deux conditions suivantes : (1) l'appareil ne doit pas produire de brouillage, et (2) l'utilisateur de l'appareil doit accepter tout brouillage radioélectrique subi, même si le brouillage est susceptible d'en compromettre le fonctionnement.