



OWNER'S MANUAL

Please read and understand all precautions prior to use.

Thank you for choosing a premium New Bright product.

Model No. / Modèle : GF31HA

USA & Canada
30-Day Limited Warranty

New Bright Industries warrants to the original purchaser that this product will be free of defects in materials and workmanship for thirty (30) days from the date of purchase. In the event of such defect within the warranty period, New Bright will repair or replace the product at our sole discretion. This warranty does not cover damage resulting from unauthorized modifications, accident, misuse or abuse.

Should your item have a defect covered under this warranty, first call the toll free number listed below. Most problems can be resolved in this manner. If necessary, you will be issued a Return Authorization number (RA) and instructions on how to obtain a Product Return Form. The Product Return Form is to be used when returning a product to us (postage pre-paid and insured by the consumer).

When returning a defective product, please package the product, the Product Return Form and a copy of the dated sales receipt as proof of purchase. Be sure to mark the RA number on the Product Return Form. If the product is returned without a dated sales receipt, it will be excluded from coverage under this warranty. Please allow 4 to 6 weeks for delivery of repaired or replacement vehicles (depending on your location).

New Bright Industries' liability for defects in materials and workmanship under this warranty shall be limited to repair or replacement at our sole discretion. In no event shall we be responsible for incidental, consequential or contingent damages (except in those states that do not allow this exclusion or limitation).

Valid only in the USA & Canada.

Contact New Bright Industries Customer Service Toll Free at:

1-877-NBI-TOYS
(1-877-624-8697)

Monday through Friday, 8:00 AM to 5:00 PM Eastern Time

LJN117-15

Table of Contents

- Section 1: Table of Contents**
- Section 2: Component Checklist**
- Section 3: Vehicle Features and Functions**
- Section 4: Charging the Battery**
- Section 5: Transmitter Battery Installation
Transmitter Features and Functions**
- Section 6: Proper Use
Precautions and Care**
- Section 7: Trouble Shooting & Support**

This device complies with Industry Canada licence-exempt RSS standard(s). Operation is subject to the following two conditions: (1) this device may not cause interference, and (2) this device must accept any interference, including interference that may cause undesired operation of the device.

Le présent appareil est conforme aux CNR d'Industrie Canada applicables aux appareils radio exempts de licence. L'exploitation est autorisée aux deux conditions suivantes : (1) l'appareil ne doit pas produire de brouillage, et (2) l'utilisateur de l'appareil doit accepter tout brouillage radioélectrique subi, même si le brouillage est susceptible d'en compromettre le fonctionnement.

New Bright

Component Checklist

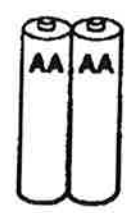
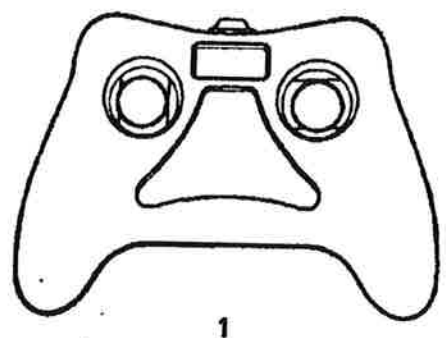
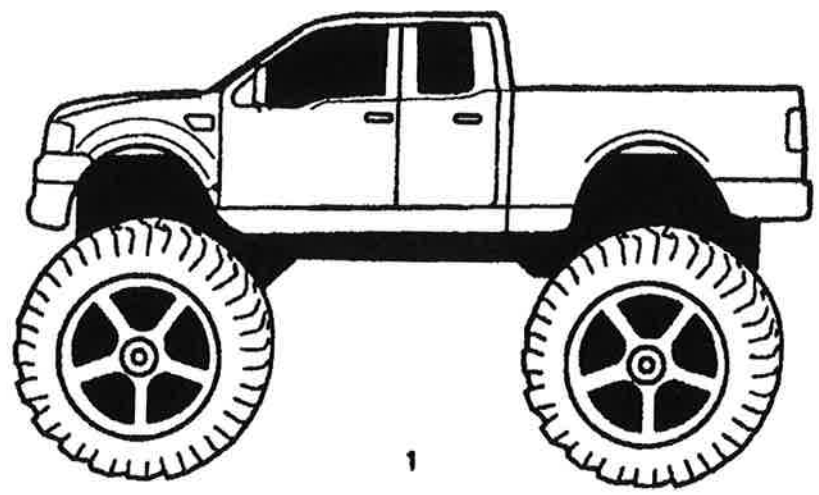

Vehicle

Features and Functions



ON/OFF Switch

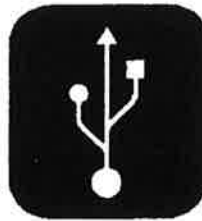

USB Cord Winder

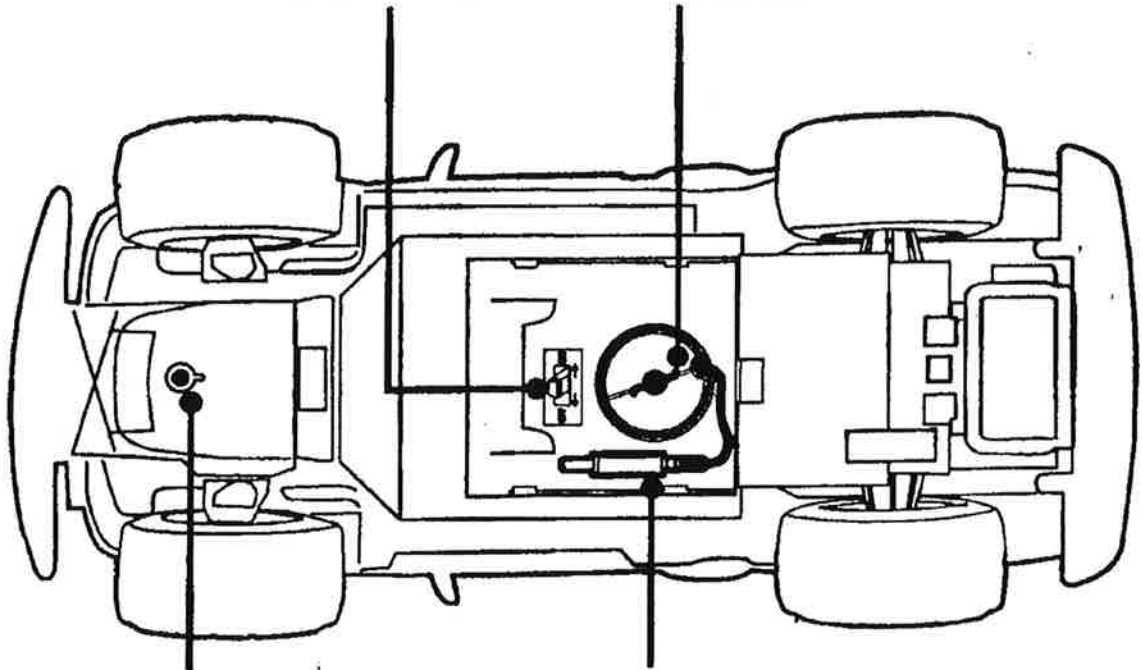

Wheel Alignment

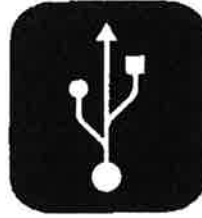

USB Connector
Holder

* If vehicle pulls to the left or right during forward driving the Wheel Alignment may need to be adjusted. The Wheel Alignment Dial is located on bottom of chassis between the front wheels.

Vehicle

Charging the Battery

This vehicle is equipped with an internal Lithium-Ion battery that is recharged via USB. ON/OFF Switch must be in the OFF position prior to charging.

ON/OFF Switch

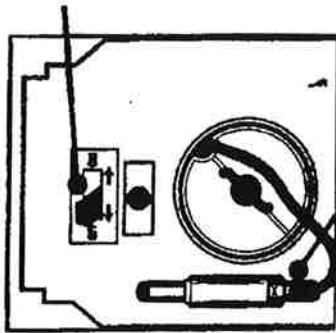

USB Connector Holder

1. Locate the USB Connector in the holder on the under-side of the vehicle and gently pry to dislodge it.
2. Locate the USB Cord Winder knob, turn knob to wind or unwind the cable.

USB Cord Winder

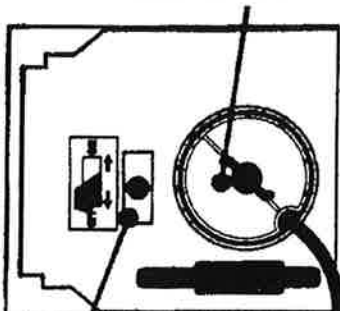

Charging Status Light

3. Insert the USB Connector into a computer or other USB power source.
4. While charging, the Charging Status Light under the vehicle will be on. Once fully charged the light will turn off. Charging is completed in approximately 45-50 minutes (when charging from a computer).
5. After charging is completed, store the USB cord by feeding the cord into the cord winder while turning the knob. Replace the USB Connector in the holder by pressing it into place. Do not operate vehicle while the USB Connector is not in the holder.

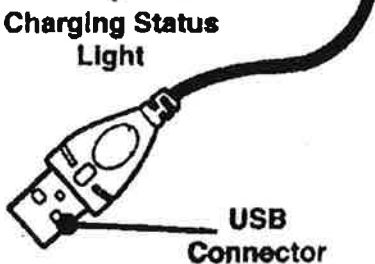

USB Connector

Transmitter

Battery Installation

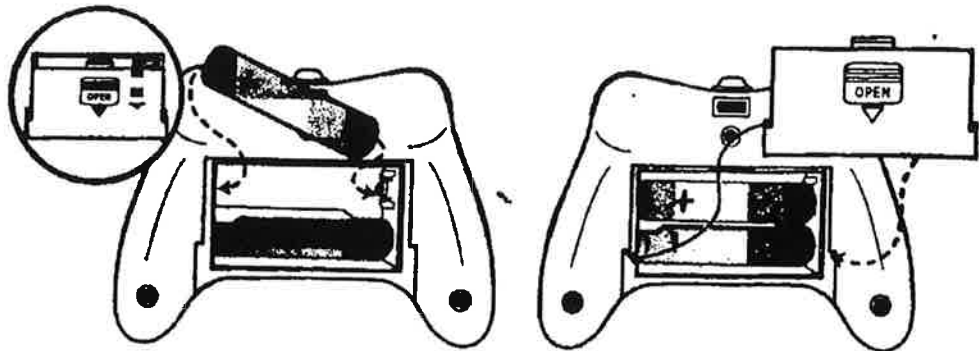

Note: When replacing Transmitter batteries:
Use alkaline batteries only.
Do not mix old and new batteries.
Do not mix alkaline, standard or rechargeable batteries.

Features and Functions



Forward/Reverse
Drive

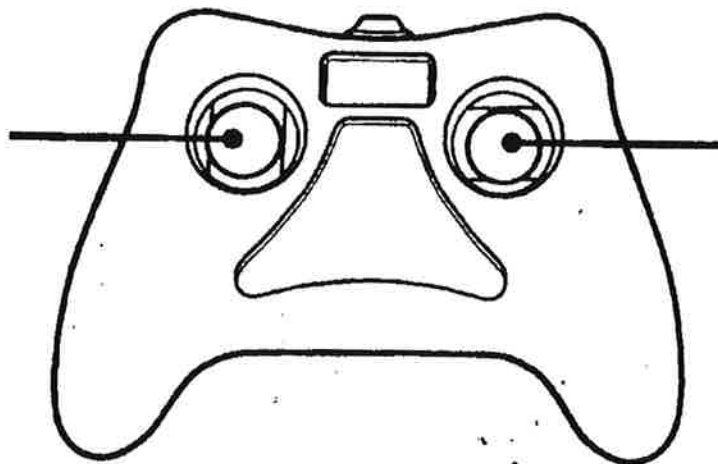

Left/Right
Steering

This transmitter is equipped with 2.4GHz technology which allows up to 6 vehicles to be raced at the same time.

The transmitter will automatically sync with the vehicle.

Proper Use

Precautions and Care



Switch vehicle OFF
when not in use.

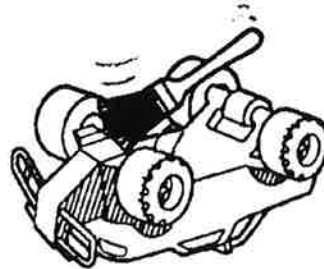

Brush areas where
dirt gets trapped.



Wipe body with a
soft rag or tact cloth.

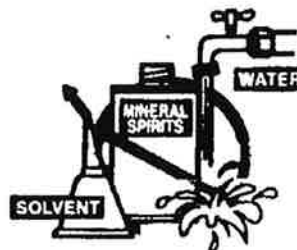

Do not use chemicals
or water to clean.

Support

Trouble Shooting & Support

Problem - Vehicle does not move or moves slowly.

- Make certain there are fresh alkaline batteries in the transmitter and that they have been installed in the correct position.
- Are the (+) and (-) markings on the alkaline batteries in the same position as the (+) and (-) markings in the Transmitter Battery Compartment?
- Are the metal contact tabs touching, rusty or dirty in the transmitter?
- Has the vehicle been fully charged?
- Make certain that the vehicle ON/OFF switch is in the "ON" position.

Problem - Vehicle moves by itself or exhibits reduced range from the transmitter.

- Make certain there are no outside radio interference in your area. The best way to test this is to take the vehicle as far away from radio towers, electrical lines or tall buildings as possible to ensure no further radio interference will occur.

Always remove Batteries from transmitter when not in use.

Do not dispose batteries in fire. Leakage, explosion and personal injury may occur.

Do not attempt jumps or tricks with this vehicle.

Do not attempt to remove internal battery.

Do not use included USB cord for anything other than its intended purpose.

Always keep USB cord stored when not in use.

Adult supervision recommended.

FCC CAUTION:

Changes or modifications not expressly approved by the party responsible for compliance could void the user's authority to operate the equipment.

NOTE: This equipment has been tested and found to comply with the limits for a Class B digital device, pursuant to Part 15 of the FCC Rules. These limits are designed to provide reasonable protection against harmful interference in a residential installation. This equipment generates, uses and can radiate radio frequency energy and, if not installed and used in accordance with the instructions, may cause harmful interference to radio communications. However, there is no guarantee that interference will not occur in a particular installation. If this equipment does cause harmful interference to radio or television reception, which can be determined by turning the equipment off and on, the user is encouraged to try to correct the interference by one or more of the following measures:

- Reorient or relocate the receiving antenna.
- Increase the separation between the equipment and receiver.
- Connect the equipment into an outlet on a circuit different from that to which the receiver is connected.
- Consult the dealer or an experienced radio/TV technician for help.