

## Vehicle

### Body Shell Removal

Locate the body pins on top of vehicle body.  
Pull pins as shown and set aside.

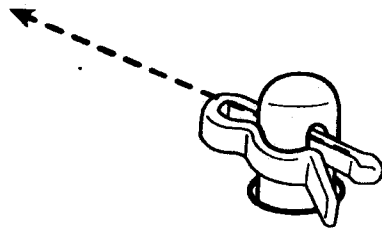

Lift and remove body shell.

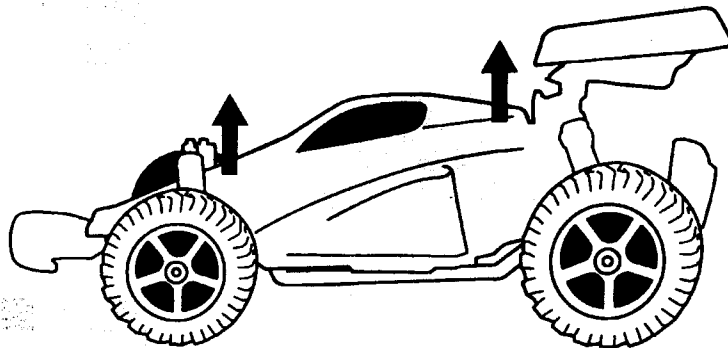

**CAUTION-ELECTRICALLY OPERATED PRODUCT:**  
NOT RECOMMENDED FOR CHILDREN UNDER 8 YEARS OF AGE.  
AS WITH ALL ELECTRIC PRODUCTS, PRECAUTIONS SHOULD BE  
OBSERVED DURING HANDLING AND USE TO PREVENT ELECTRIC  
SHOCK. INPUT: 120V AC 60Hz 300mA. OUTPUT: 14.4V DC 800mA.

# NEW BRIGHT

## OWNER'S MANUAL

*Please read and understand all precautions prior to use.*

**Thank you for choosing a premium New Bright product.**

USA & Canada  
30-Day Limited Warranty

New Bright Industries warrants to the original purchaser that this product will be free of defects in materials and workmanship for thirty (30) days from the date of purchase. In the event of such defect within the warranty period, New Bright will repair or replace the product at our sole discretion. This warranty does not cover damage resulting from unauthorized modifications, accident, misuse or abuse.

Should your item have a defect covered under this warranty, first call the toll free number listed below. Most problems can be resolved in this manner. If necessary, you will be issued a Return Authorization (RA) number and instructions on how to obtain a Product Return Form. The Product Return Form is to be used when returning a product to us (postage pre-paid and insured by the consumer).

When returning a defective product, please package the product, the Product Return Form and a copy of the dated sales receipt as proof of purchase. Be sure to mark the RA number on the Product Return Form. If the product is returned without a dated sales receipt, it will be excluded from coverage under this warranty. Please allow 4 to 6 weeks for delivery of repaired or replacement vehicles (depending on your location).

New Bright Industries' liability for defects in materials and workmanship under this warranty shall be limited to repair or replacement at our sole discretion. In no event shall we be responsible for incidental, consequential or contingent damages (except in those states that do not allow this exclusion or limitation).

Valid only in the USA & Canada.

Contact New Bright Industries Customer Service Toll Free-at:  
1-877-NBI-TOYS  
(1-877-624-8697)

Monday through Friday, 8:00 AM to 5:00 PM Eastern Time

# New Bright

## Table of Contents

- Section 1: Table of Contents
- Section 2: Component Checklist
- Section 3: Charging the Battery
- Section 4: Battery Installation in Vehicle
- Section 5: Vehicle Features and Functions
- Section 6: Battery Installation in Transmitter
- Section 7: Transmitter Features and Functions
- Section 8: Removing the Vehicle Body Shell
- Section 9: Proper Use  
Precautions and Care
- Section 10: Trouble Shooting and Support
- Section 11: Cautions

REF-038082102

# New Bright

## Component Checklist

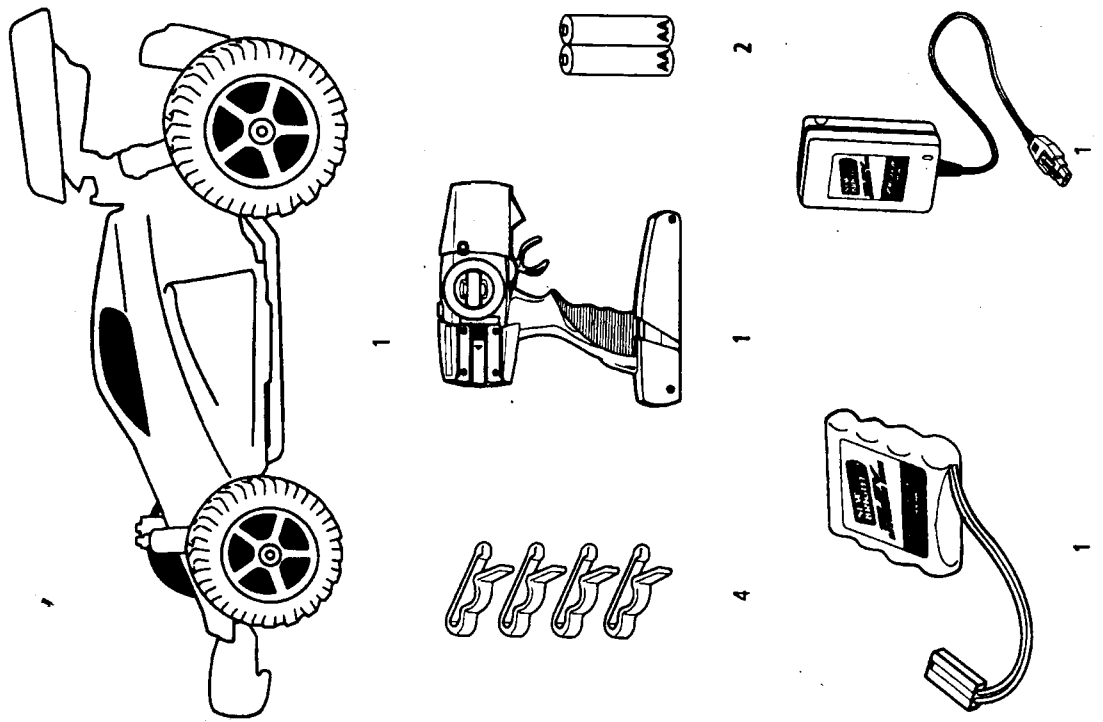

## Battery Pack

### Charging the Battery

#### IMPORTANT!

The included 12.8V Lithium Ion battery pack is only PARTIALLY CHARGED prior to shipment and it is recommended the battery be fully charged before first use.

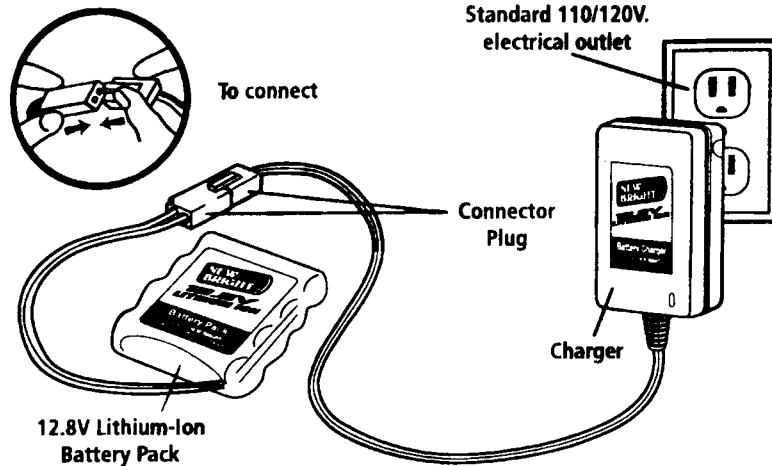

1. Plug the Charger into a standard indoor electrical outlet.
2. Connect the battery pack to the charger by pushing the connector plugs together. When battery pack is properly connected and charging unit is plugged into the outlet, the charging status light will turn on, indicating the battery is charging.
3. After approximately one hour of charging the light will turn off, indicating that the battery is fully charged.
4. Charge will last approximately 15-20 minutes depending on terrain and driving style.
5. Disconnect battery from charger as shown above.  
When disconnecting: DO NOT PULL ON WIRES.

**IMPORTANT:** It is normal for the battery pack to become warm after charging and/or use. Be sure to allow the battery pack to cool before using or recharging. Recharging a warm battery pack will greatly reduce the battery life.

#### ATTENTION PARENTS:

- The Battery Charger & Soft Pack Battery need to be periodically examined for potential hazards. Any potentially hazardous parts need to be repaired or replaced.

## Transmitter

### Features and Functions

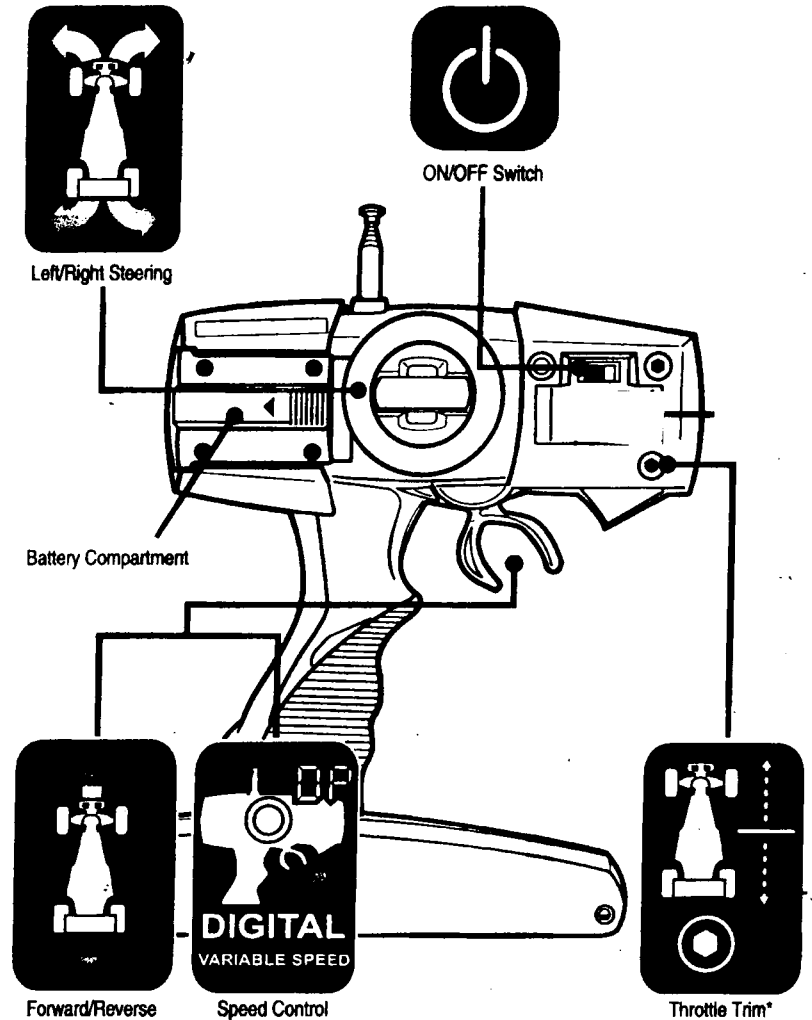

- Locate the vehicle's ON/OFF switch on the underside of vehicle near the battery compartment. Move the ON/OFF switch to the "ON" position. If the vehicle's wheels move, the Throttle Trim may need to be adjusted. Turn the Throttle Trim dial on the transmitter until the wheels come to a stop.

# Vehicle

## Battery Installation



1. Open battery compartment by turning lock and lift cover off.

2. Join the pack connector plug into compartment plug receptacle and secure tightly.

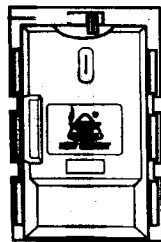
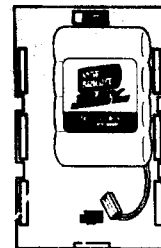
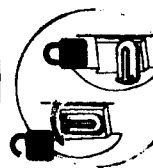
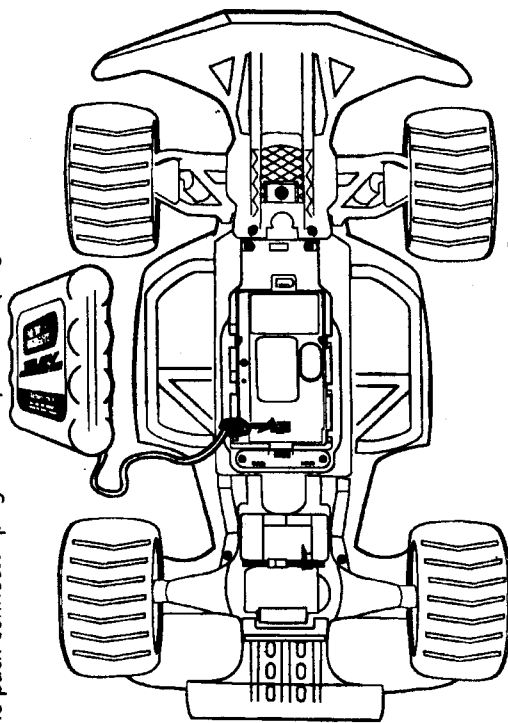

3. Drop pack into position, close and lock cover. When disconnecting pack **DO NOT PULL ON WIRES.**

# Vehicle

## Features and Functions

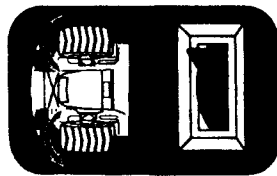

Connector Plug Receptacle

Power Button  
(See Section 7)

Wheel Alignment\*  
(Steering Trim)

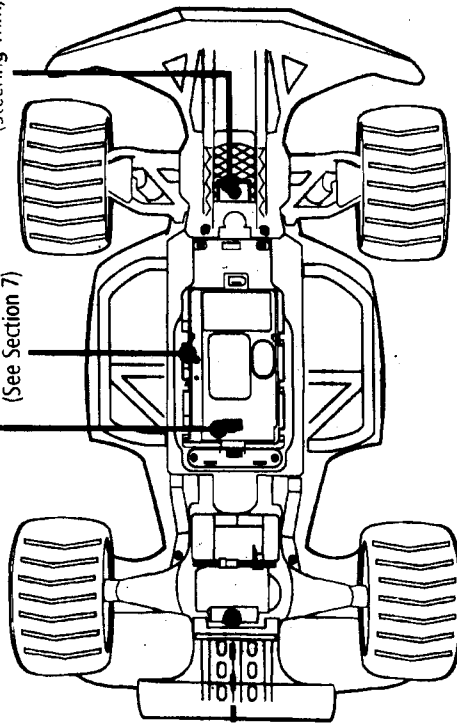

\* If vehicle pulls to the left or right during forward driving the Steering Trim may need to be adjusted. The Steering Trim is located on bottom of chassis between the front wheels.

\* Vehicle will Automatically shut down after 30 minutes of inactivity to save battery life.

# Transmitter

## Battery Installation

1. Locate and remove the Battery Compartment Cover which is located on the front face of the Transmitter.

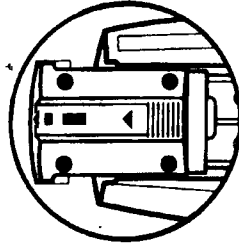

2. Insert 2 "AA" size batteries. Make certain the positive (+) and negative (-) markings on the batteries are in the same position as the positive (+) negative (-) markings inside the Battery Compartment.

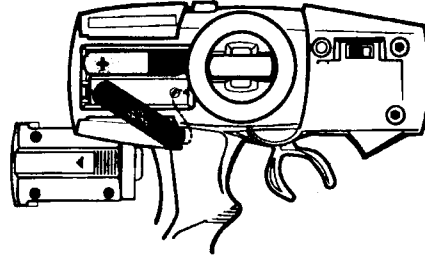

3. Replace Battery Compartment Cover making certain that the Battery Compartment tab has "snapped" into the locked position.

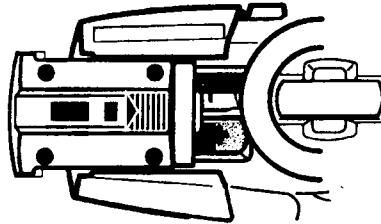

Note: When replacing Transmitter batteries:  
Use alkaline batteries only.  
Do not mix old and new batteries.  
Do not mix alkaline, standard or rechargeable batteries.

## Antenna Placement

Screw in the supplied antenna, as shown.

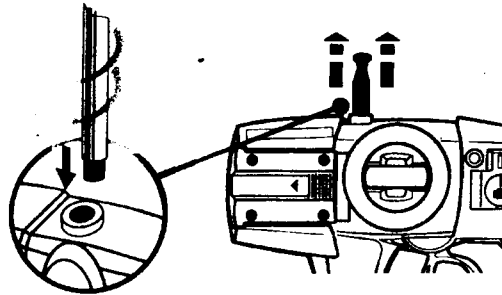

# Proper Use

## Precautions and Care

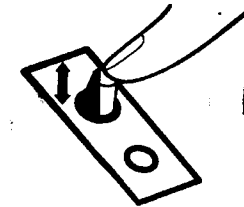
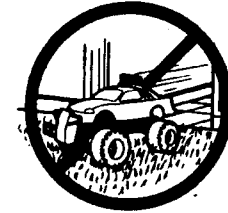
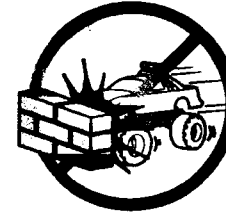
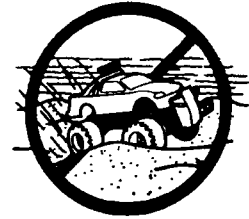
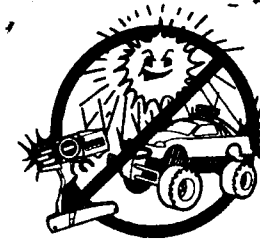

Switch vehicle OFF when not in use.

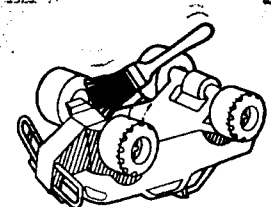

Brush areas where dirt gets trapped.

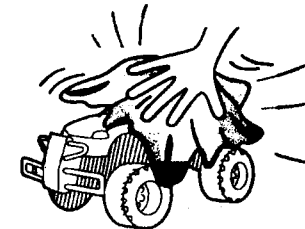

Wipe body with a soft rag or cloth.

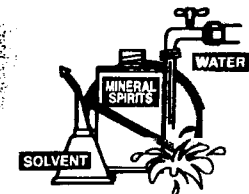

Do not use chemicals or water to clean

## Support

### Trouble Shooting & Support

**Problem - Vehicle does not move or moves slowly.**

- Has the Battery Pack been properly installed in the vehicle?
- Has the rechargeable Battery Pack been fully charged?
- Are the metal contact tabs touching, rusty or dirty in the battery compartment?
- Make certain there are fresh alkaline batteries in the transmitter and that they have been installed in the correct position.
- Are the (+) and (-) markings on the alkaline batteries in the same position as the (+) and (-) markings in the Transmitter Battery Compartment?
- Are the (+) and (-) markings on the Battery Pack in the same position as the (+) and (-) markings in the Battery Compartment?
- Make certain that the vehicle ON/OFF switch is in the "ON" position.

**Problem - Vehicle moves by itself or exhibits reduced range from the transmitter.**

- Make certain there is no outside radio interference in your area. The best way to test this is to take the vehicle as far away from radio towers, electrical lines or tall buildings as possible to ensure no further radio interference will occur.

**FCC CAUTION:**

Changes or modifications not expressly approved by the party responsible for compliance could void the user's authority to operate the equipment.

**NOTE:** This equipment has been tested and found to comply with the limits for a Class B digital device, pursuant to Part 15 of the FCC Rules. These limits are designed to provide reasonable protection against harmful interference in a residential installation. This equipment generates, uses and can radiate radio frequency energy and, if not installed and used in accordance with the instructions, may cause harmful interference to radio communications. However, there is no guarantee that interference will not occur in a particular installation. If this equipment does cause harmful interference to radio or television reception, which can be determined by turning the equipment off and on, the user is encouraged to try to correct the interference by one or more of the following measures:

- Relocate or reorient the receiving antenna.
- Increase the separation between the equipment and receiver.
- Connect the equipment into an outlet on a circuit different from that to which the receiver is connected.
- Consult the dealer or an experienced radio/TV technician for help.

## New Bright

### Cautions

Do not recharge Battery Pack if it is hot or warm to the touch. Allow Battery Pack to cool before recharging. Recharging a hot or warm Battery Pack will shorten the life of the Pack.

Do not recharge a Battery Pack if it appears to be damaged or leaking.

Always unplug Charger when not in use.

Always remove Battery Pack from Battery Compartment when not in use.

Do not dispose batteries in fire. Leakage, explosion and personal injury may occur.

Dispose of Battery Pack properly.

Do not attempt to disassemble Battery Pack or Charger.

Do not use Battery Charger for any use other than instructed in this booklet.

Only an adult should charge Batteries.

Do not attempt jumps or tricks with this vehicle.