

**USA & Canada  
30-Day Limited Warranty**

New Bright Industries warrants to the original purchaser that this product will be free of defects in materials and workmanship for thirty (30) days from the date of purchase. In the event of such defect within the warranty period, New Bright will repair or replace the product at our sole discretion. This warranty does not cover damage resulting from unauthorized modifications, accident, misuse or abuse.

Should your item have a defect covered under this warranty, first call the toll free number listed below. Most problems can be resolved in this manner. If necessary, you will be issued a Return Authorization number (RA) and instructions on how to obtain a Product Return Form. The Product Return Form is to be used when returning a product to us (postage pre-paid and insured by the consumer).

When returning a defective product, please package the product, the Product Return Form and a copy of the dated sales receipt as proof of purchase. Be sure to mark the RA number on the Product Return Form. If the product is returned without a dated sales receipt, it will be excluded from coverage under this warranty. Please allow 4 to 6 weeks for delivery of repaired or replacement vehicles (depending on your location).

New Bright Industries' liability for defects in materials and workmanship under this warranty shall be limited to repair or replacement at our sole discretion. In no event shall we be responsible for incidental, consequential or contingent damages (except in those states that do not allow this exclusion or limitation).

**Valid only in the USA & Canada.**

Contact New Bright Industries Customer Service Toll Free at:  
**1-877-NBI-TOYS**  
(1-877-624-8697)  
Monday through Friday, 8:00 AM to 5:00 PM Eastern Time

U.S. Toy Sales and Marketing Co. Inc.  
30260 Oak Creek Drive – 2nd Floor  
Wixom MI 48393  
1-877-624-8697  
<http://www.newbright.com/>



# OWNER'S MANUAL

*Please read and understand all precautions prior to use.*

**Thank you for choosing a premium New Bright product.**

# WHAT'S INCLUDED

## Component Checklist

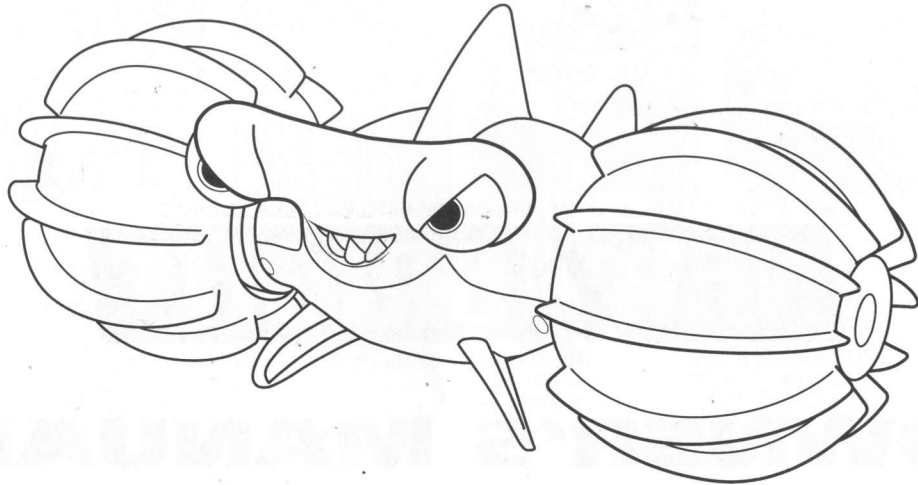

(1) R/C Sharko Polo



(1) Transmitter



(2) "AA" Batteries

# TRANSMITTER

## Battery Installation

1. To open battery compartment cover on transmitter, remove the 4 small screws and set aside.

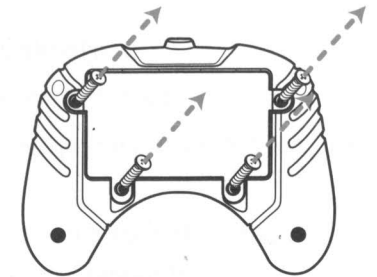

2. Insert 2 "AA" size batteries. Make sure the positive (+) and negative (-) markings on the batteries match up to the ones inside the Battery Compartment.

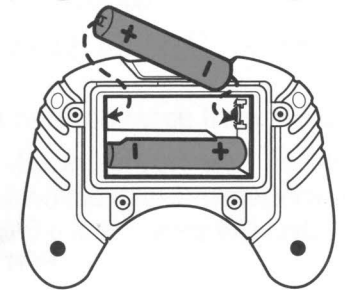

3. Replace and tighten the 4 small screws to secure the battery compartment cover.

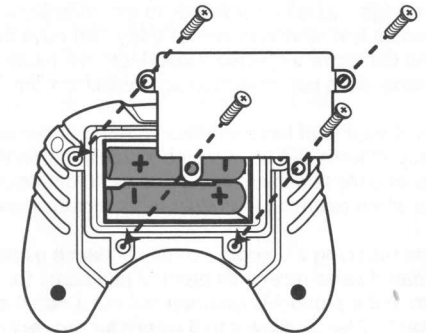

**Note:** When replacing Transmitter batteries:

Do not mix old and new batteries.

Do not mix alkaline, standard or rechargeable batteries.

Use alkaline batteries only.

## Syncing

This transmitter is equipped with 2.4GHz technology which allows up to 6 vehicles to be used at the same time.

To sync transmitter and vehicle, follow these steps:

1. Install batteries in Transmitter.
2. Turn on Vehicle.

Once the batteries are installed and the vehicle is turned on, the Transmitter will sync automatically with the vehicle.

# TRANSMITTER

## Functions

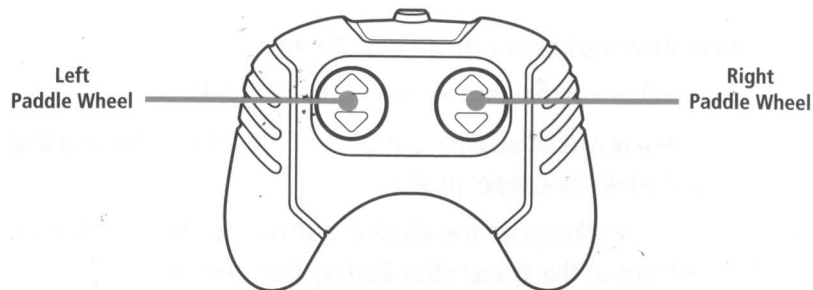

## How to Drive

### FORWARD AND REVERSE DRIVING



**FORWARD DRIVING**  
Push and hold BOTH upward arrows for Forward Driving.

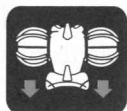

**REVERSE DRIVING**  
Push and hold BOTH downward arrows for Reverse Driving.

### TURNING



**RIGHT TURNING**  
Push LEFT upward arrow to turn right while driving forward. Push LEFT downward arrow to turn right in reverse.



**LEFT TURNING**  
Push RIGHT upward arrow to turn left while driving forward. Push RIGHT downward arrow to turn left in reverse.

### SPINS



**360° SPINS - Clockwise**  
Push Arrows as shown for Clockwise Spinning.



**360° SPINS - Counter-Clockwise**  
Push arrows as shown for Counter-Clockwise Spinning.

# VEHICLE

## Functions

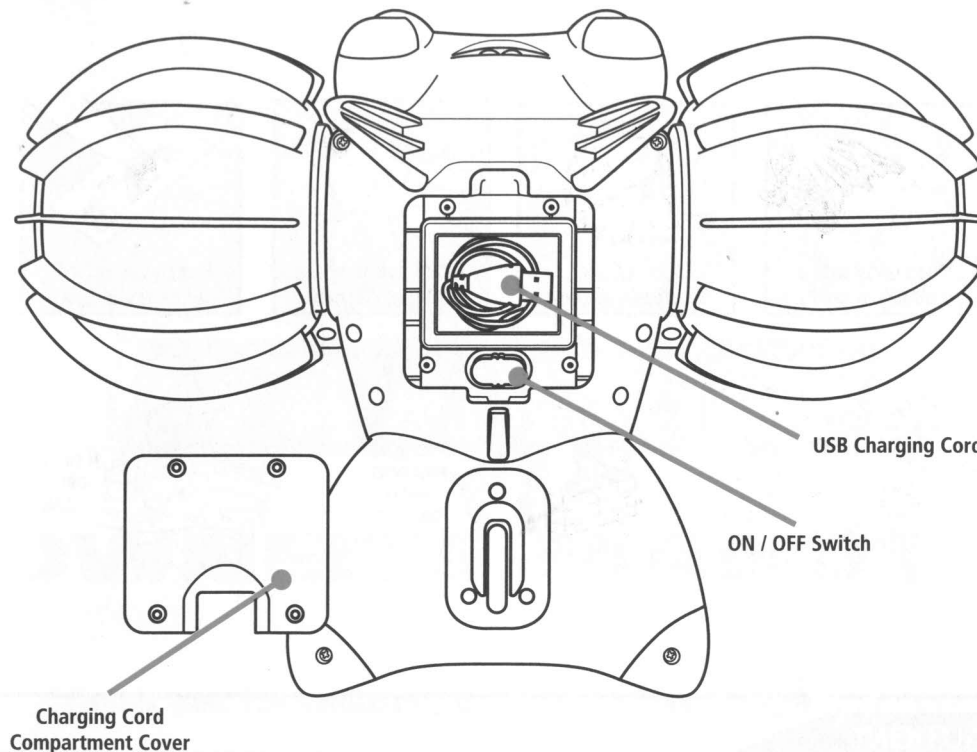

## Charging

This vehicle is equipped with an internal Lithium-Ion battery that is recharged via USB. ON/OFF Switch must be in the OFF position prior to charging.

1. Locate the Charging Cord Compartment Cover on the underside of vehicle.
2. Use a screwdriver to remove the small screws keeping the cover in place.
3. Remove USB cable from the Storage Compartment. (Use care when extending cord as it is attached to inside internal battery). Cord can be plugged into any computer with powered USB port or USB outlet brick (not included).
4. Insert the USB connector into a computer or other USB power source.
5. While charging, the Charging Status Light under the vehicle will be on. Once fully charged the light will turn off. Charging is completed in approximately 2 hours (when charging from a computer).
6. After charging is complete, store the USB cord in the Charging Cord Compartment. Replace the Compartment cover and screws securely back into place.

# PROPER USE

## Precautions and Care

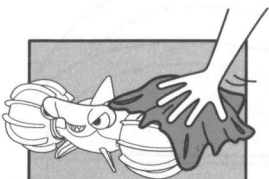

Wipe body with a soft rag or cloth.



Do not use chemicals to clean

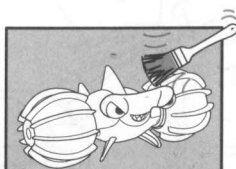

Brush areas where dirt gets trapped.

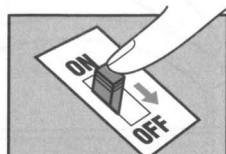

Switch vehicle OFF when not in use.



DO NOT LEAVE OUT IN THE SUN



DO NOT RUN INTO HARD OBJECTS



DO NOT DRIVE ON SAND

## CAUTION!

Do not recharge Internal Battery if vehicle is hot or warm to the touch. Allow Battery to cool before recharging. Recharging a hot or warm Battery will shorten the life of the unit.

Do not recharge the Internal Battery if it appears to be damaged or leaking.

Always store charging cord in storage compartment when not in use.

Do not dispose batteries in fire. Leakage, explosion and personal injury may occur.

Do not attempt to disassemble or remove Internal Battery or charging cord.

Only an adult should charge Batteries.

Do not attempt jumps or tricks with this vehicle.

# SUPPORT

## Trouble Shooting

### Problem - Vehicle does not move or moves slowly.

- Has the rechargeable Internal Battery been fully charged?
- Make certain there are fresh alkaline batteries in the transmitter and that they have been installed in the correct position.
- Are the (+) and (-) markings on the alkaline batteries in the same position as the (+) and (-) markings in the Transmitter Battery Compartment?
- Make certain that the vehicle ON/OFF switch is in the "ON" position.

### Problem - Vehicle moves by itself or exhibits reduced range from the transmitter.

- Make certain there is no outside radio interference in your area. The best way to test this is to take the vehicle as far away from radio towers, electrical lines or tall buildings as possible to ensure no further radio interference will occur.

This device complies contains licence-exempt transmitter(s)/receiver(s) that comply with Innovation, Science and Economic Development Canada's licence-exempt RSS(s). Operation is subject to the following two conditions: (1) This device may not cause interference; and (2) This device must accept any interference, including interference that may cause undesired operation of the device. L'émetteur/récepteur exempt de licence contenu dans le présent appareil est conforme aux CNR d'Innovation, Sciences et Développement économique Canada applicables aux appareils radio exempts de licence. L'exploitation est autorisée aux deux conditions suivantes : (1) L'appareil ne doit pas produire de brouillage; (2) L'appareil doit accepter tout brouillage radioélectrique subi, même si le brouillage est susceptible d'en compromettre le fonctionnement.

### FCC CAUTION:

Changes or modifications not expressly approved by the party responsible for compliance could void the user's authority to operate the equipment.

**NOTE:** This equipment has been tested and found to comply with the limits for a Class B digital device, pursuant to Part 15 of the FCC Rules. These limits are designed to provide reasonable protection against harmful interference in a residential installation. This equipment generates, uses and can radiate radio frequency energy and, if not installed and used in accordance with the instructions, may cause harmful interference to radio communications. However, there is no guarantee that interference will not occur in a particular installation. If this equipment does cause harmful interference to radio or television reception, which can be determined by turning the equipment off and on, the user is encouraged to try to correct the interference by one or more of the following measures:

- Reorient or relocate the receiving antenna.
- Increase the separation between the equipment and receiver.
- Connect the equipment into an outlet on a circuit different from that to which the receiver is connected.
- Consult the dealer or an experienced radio/TV technician for help.