

14+
yrs.

CAUTION-ELECTRICALLY OPERATED PRODUCT:
NOT RECOMMENDED FOR CHILDREN UNDER 14 YEARS OF AGE. AS WITH ALL ELECTRIC PRODUCTS, PRECAUTIONS SHOULD BE OBSERVED DURING HANDLING AND USE TO PREVENT ELECTRIC SHOCK. INPUT: 120V AC 60Hz 10W. OUTPUT: 9.6V DC 500mA.



OWNER'S MANUAL

Please read and understand all precautions prior to use.

Thank you for choosing a premium New Bright product.

USA & Canada 30-Day Limited Warranty

New Bright Industries warrants to the original purchaser that this product will be free of defects in materials and workmanship for thirty (30) days from the date of purchase. In the event of such defect within the warranty period, New Bright will repair or replace the product at our sole discretion. This warranty does not cover damage resulting from unauthorized modifications, accident, misuse or abuse.

Should your item have a defect covered under this warranty, first call the toll free number listed below. Most problems can be resolved in this manner. If necessary, you will be issued a Return Authorization (RA) number and instructions on how to obtain a Product Return Form. The Product Return Form is to be used when returning a product to us (postage pre-paid and insured by the consumer).

When returning a defective product, please package the product, the Product Return Form and a copy of the dated sales receipt as proof of purchase. Be sure to mark the RA number on the Product Return Form. If the product is returned without a dated sales receipt, it will be excluded from coverage under this warranty. Please allow 4 to 6 weeks for delivery of repaired or replacement vehicles (depending on your location).

New Bright Industries' liability for defects in materials and workmanship under this warranty shall be limited to repair or replacement at our sole discretion. In no event shall we be responsible for incidental, consequential or contingent damages (except in those states that do not allow this exclusion or limitation).

Valid only in the USA & Canada.

Contact New Bright Industries Customer Service Toll Free at:
1-877-NBI-TOYS
(1-877-624-8697)
Monday through Friday, 8:00 AM to 5:00 PM Eastern Time

This device complies with industry Canada licence-exempt RSS standard(s). Operation is subject to the following two conditions: (1) this device may not cause interference, and (2) this device must accept any interference, including interference that may cause undesired operation of the device.

Le présent appareil est conforme aux CNR d'industrie Canada applicables aux appareils radio exempts de licence. L'exploitation est autorisée aux deux conditions suivantes: (1) l'appareil ne doit pas produire de brouillage, et (2) l'utilisateur de l'appareil doit accepter tout brouillage radioélectrique subi, même si le brouillage est susceptible d'en compromettre le fonctionnement.

⚠ WARNING:

THIS PRODUCT IS NOT A TOY. THIS PRODUCT IS INTENDED FOR USE BY THOSE 14 YEARS OF AGE OR OLDER. MISUSE MAY CAUSE SERIOUS INJURY, ESPECIALLY TO THE EYE. EYE PROTECTION MUST BE WORN AT ALL TIMES BY THE USER AND ANY PERSON WITHIN RANGE. READ ALL INSTRUCTIONS AND OWNERS MANUAL BEFORE USING.

READ ALL INSTRUCTIONS AND WARNINGS IN THIS MANUAL BEFORE USING THIS MECH VEHICLE BUYER AND USER HAVE THE DUTY TO OBEY ALL LAWS ABOUT THE USE AND OWNERSHIP OF THIS MECH VEHICLE

THIS PRODUCT IS INTENDED FOR USE BY THOSE 14 YEARS OF AGE OR OLDER.

TRANSMITTER

Battery Installation

1. To open battery compartment cover on transmitter, slide in the direction indicated by the arrow.
2. Insert 2 "AA" size batteries.
Make sure the positive (+) and negative (-) markings on the batteries match up to the ones inside the Battery Compartment.

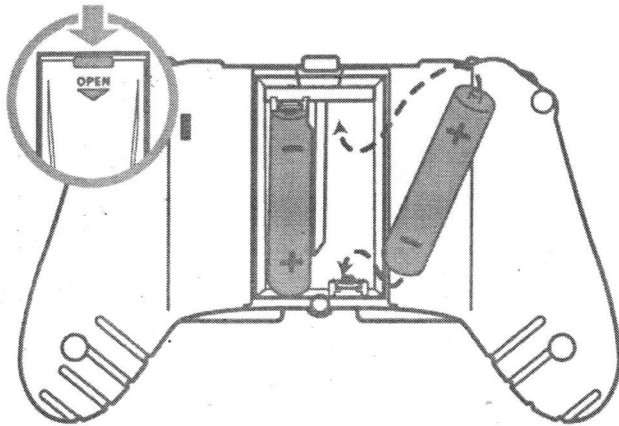

3. Replace the Battery Compartment Cover making certain that the Compartment tab has "snapped" into the locked position.

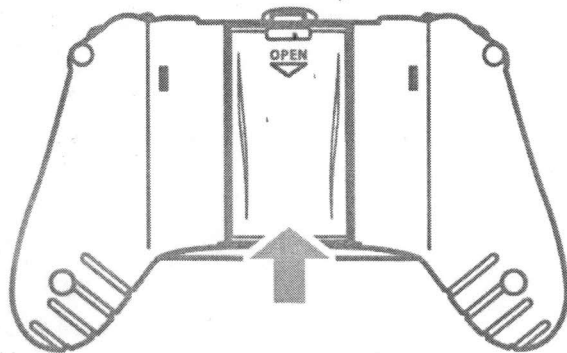

Note: When replacing Transmitter batteries:
Do not mix old and new batteries.
Do not mix alkaline, standard or rechargeable batteries.
Use alkaline batteries only.

TRANSMITTER

Functions

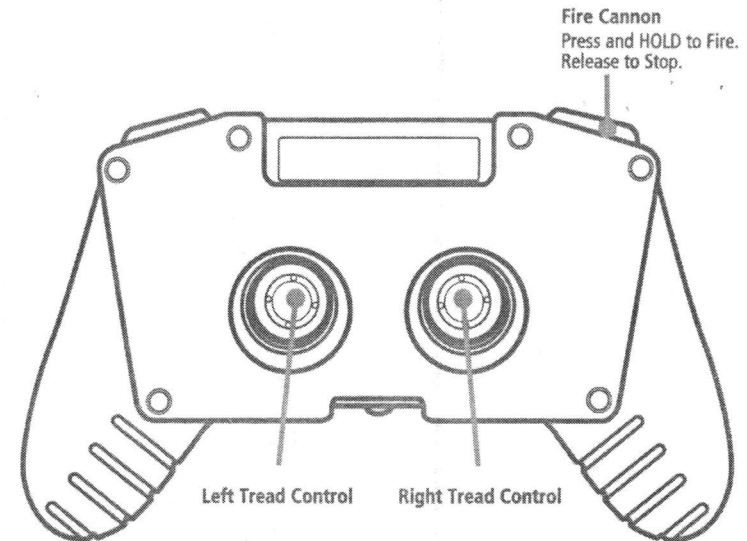

Syncing

This transmitter is equipped with 2.4GHz technology which allows up to 6 MECH vehicles to be used at the same time.

To sync transmitter and MECH vehicle, follow these steps:

1. Install batteries in Transmitter.
2. Install battery in MECH Vehicle.
3. Turn on MECH Vehicle.

Once the batteries are installed and the vehicle is turned on, the Transmitter will sync automatically with the vehicle.

BATTERY

Charging

IMPORTANT!

The included 9.6V Lithium Ion battery pack is only PARTIALLY CHARGED prior to shipment and it is recommended the battery be fully charged before first use.

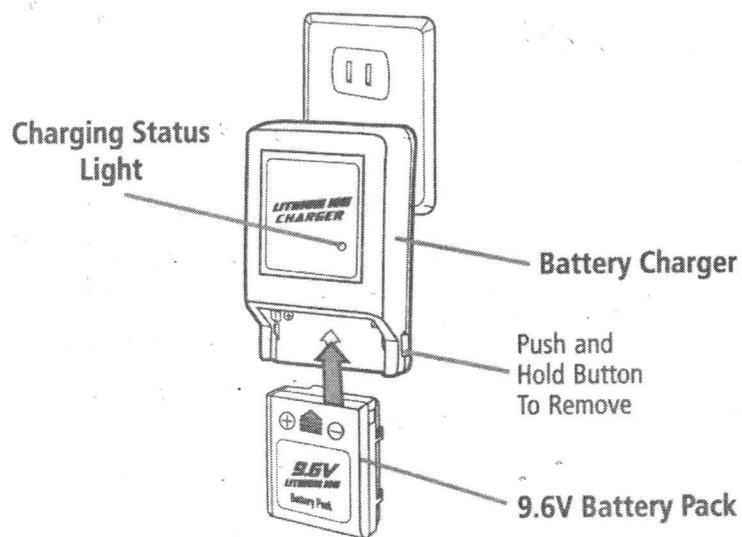

1. Insert the 9.6V Lithium Ion rechargeable battery pack securely into the charger and push up to lock. Be sure the arrows are properly matched (as shown above).
2. Plug the Charger into a standard indoor electrical outlet. This power unit is intended to be correctly orientated in a vertical or wall mount position.
3. Allow battery to charge for 1-1.5 Hours. Charging Status Light be solid red while battery is charging. When charging is complete, light will blink green.
4. To remove the battery, press and hold the release button and slide battery down to unlock
5. Charge will last approximately 12 minutes depending on terrain and driving style.

IMPORTANT: It is normal for the battery pack to become warm after charging and/or use. Be sure to allow the battery pack to cool before using or recharging. Recharging a warm battery pack will greatly reduce the battery life.

ATTENTION PARENTS:

- The Battery Charger & Battery Pack need to be periodically examined for potential hazards. Any potentially hazardous parts need to be repaired or replaced.

HOW TO DRIVE

Using the Transmitter

FORWARD AND REVERSE DRIVING

NOTE: Driving with the barrel fully raised increases the potential to tip over. Always drive with the barrel level with the ground.

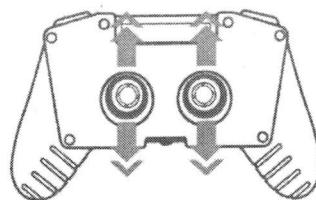

FORWARD DRIVING

Push BOTH joysticks forward for Forward Driving.



REVERSE DRIVING

Pull BOTH joysticks backward for Reverse Driving.

TURNING

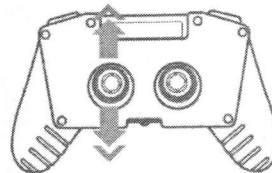

RIGHT TURNING

Push LEFT joystick forward to turn right while driving forward. Pull LEFT joystick back to turn right in reverse.

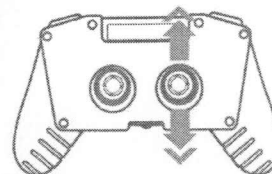

LEFT TURNING

Push RIGHT joystick forward to turn left while driving forward. Pull RIGHT joystick back to turn left in reverse.

SPINS

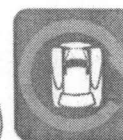
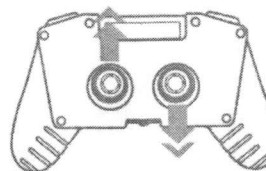

360° SPINS - Clockwise
Push joysticks as shown for Clockwise Spinning.

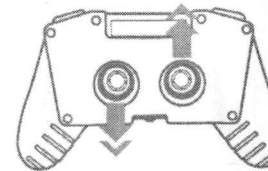

360° SPINS - Counter-Clockwise
Push joysticks as shown for Counter-Clockwise Spinning.

WHAT'S INCLUDED

Component Checklist

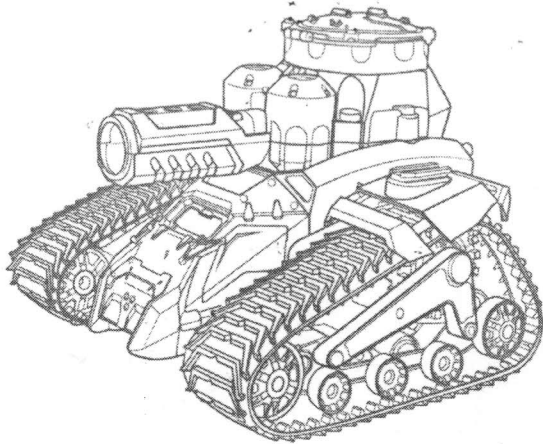

R/C M.E.C.H. Blaster

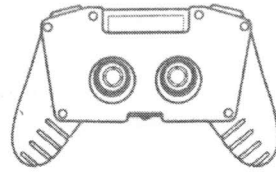

Transmitter

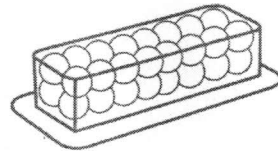

32 Foam Balls



9.6V Battery Pack

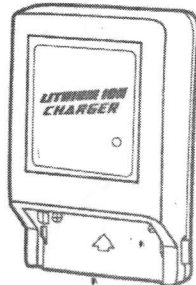

Battery Charger

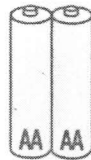

"AA" Batteries

Before you Begin

THINK SAFETY FIRST!

- This product is recommended for ages 14 and up.
- Always point your MECH Blaster in a safe direction.
- Keep foam balls away from small children.
- Always keep radio control transmitter away from anyone under 14 years old.
- Always wear proper eye protection when playing with MECH Blaster as foam balls can bounce back at a high rate of speed.
- When using MECH Blaster, make sure everyone within 100 feet is aware of what you are operating.

VEHICLE

Battery Installation

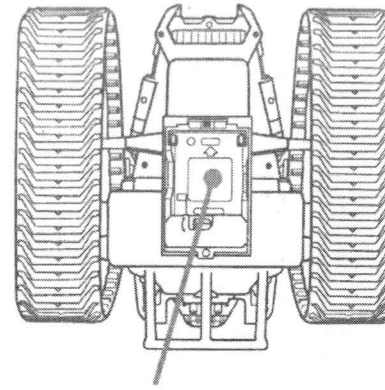

Battery Compartment
(Located on underside of MECH Vehicle)

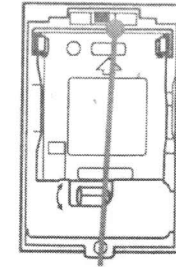

ON/OFF Switch

1. Locate the battery compartment on the underside of MECH vehicle.
2. Align arrow on battery pack with arrow inside battery compartment. Place battery pack in battery compartment and slide battery upward in direction of arrow. Once in place, turn locking tab to keep battery pack secure.

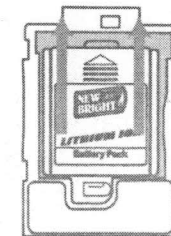
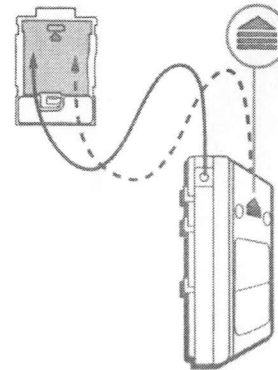

Locking Tab

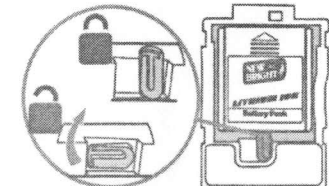

*If battery pack is not completely in place locking tab will not fully turn.

3. Move the ON/OFF switch to the ON position for operation.

VEHICLE

Fixing Ball Jams

It is possible that a ball can become lodged in the firing mechanism. Follow the instructions below to dislodge a jammed ball.

1. Make certain the power switch is in the OFF Position.
2. Open the magazine lid and remove the magazine. (Refer to items 1, 2 and 3 in reloading the magazine section) power will be cut off when magazine is removed.

NOTE: For safety, removing the magazine will disable the firing mechanism.

3. Use a pen or small tool to push the ball out through the barrel.
4. Replace ball magazine, close the lid. You can now resume play.

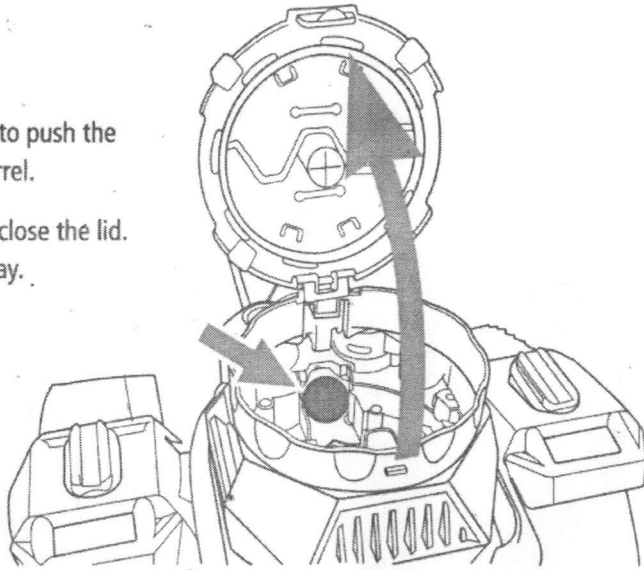

Adjusting the Barrel Angle

The MECH barrel is manually adjustable with 4 positions:

1. Straight
2. Low Angle
3. Mid Angle
4. High Angle

Using gentle pressure, tilt the barrel upward or downward to the desired position. The barrel will 'click' into place.

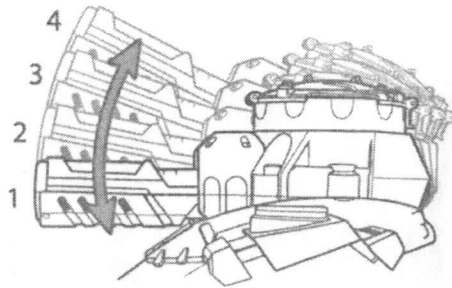

VEHICLE

Reloading the Magazine

1. Make sure MECH vehicle power switch is in the OFF position.
2. Locate the magazine on the top of the MECH vehicle: Open lid as shown.

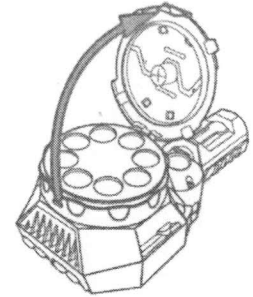
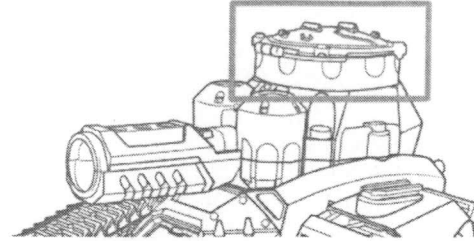

3. Pull the magazine out of its housing.

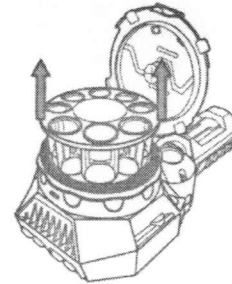

4. To reload, place 2 foam balls into each slot in the magazine. A total of 16 balls can be loaded into the magazine.

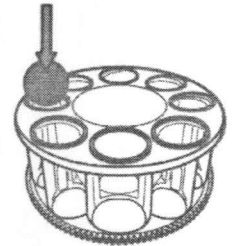

5. Replace magazine in the housing. You may need to rotate the magazine slightly before it seats properly into place.

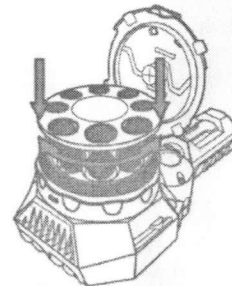

6. Close magazine lid. Magazine must be properly installed to resume firing.

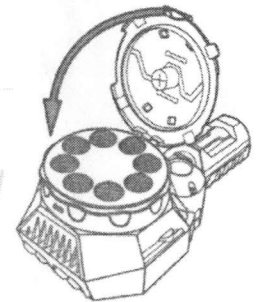

Foam Balls

Do not attempt to load objects into the magazine other than the supplied NEW BRIGHT foam balls.

Keep foam balls away from small children to avoid the possibility of choking.

PROPER USE

Precautions and Care

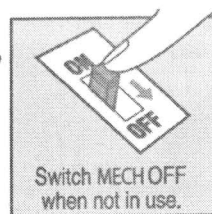
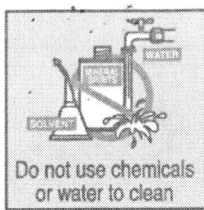

DO NOT LEAVE OUT IN THE SUN

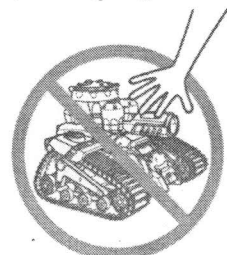

DO NOT USE BARREL TO LIFT OR CARRY

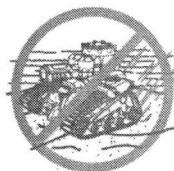

DO NOT DRIVE ON SAND

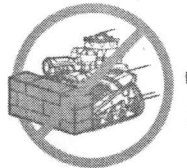

DO NOT RUN INTO HARD OBJECTS

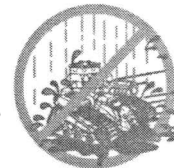

DO NOT GET WET

CAUTION!

Do not recharge Battery Pack if it is hot or warm to the touch. Allow Battery Pack to cool before recharging. Recharging a hot or warm Battery Pack will shorten the life of the Pack.

Do not recharge a Battery Pack if it appears to be damaged or leaking.

Always unplug Charger when not in use.

Always remove Battery Pack from Battery Compartment when not in use.

Do not dispose batteries in fire. Leakage, explosion and personal injury may occur.

Dispose of Lithium Ion Battery Pack properly.

Do not attempt to disassemble Battery Pack or Charger.

Do not use Battery Charger for any use other than instructed in this booklet.

Only an adult should charge Batteries.

Do not attempt jumps or tricks with this MECH.

SUPPORT

Trouble Shooting

Problem - Vehicle does not move or moves slowly.

- Has the Battery Pack been installed in the vehicle?
- Has the rechargeable Battery Pack been fully charged?
- Are the metal contact tabs touching, rusty or dirty in the battery compartment?
- Make certain there are fresh alkaline batteries in the transmitter and that they have been installed in the correct position.
- Are the (+) and (-) markings on the alkaline batteries in the same position as the (+) and (-) markings in the Transmitter Battery Compartment?
- Are the (+) and (-) markings on the Battery Pack in the same position as the (+) and (-) markings in the Battery Compartment?
- Make certain that the vehicle ON/OFF switch is in the "ON" position.

Problem - Vehicle does not shoot.

- Is the magazine properly installed in the vehicle?
- Is a ball jammed in the firing mechanism?

Problem - Vehicle moves by itself or exhibits reduced range from the transmitter.

- Make certain there is no outside radio interference in your area. The best way to test this is to take the vehicle as far away from radio towers, electrical lines or tall buildings as possible to ensure no further radio interference will occur.

FCC CAUTION:

Changes or modifications not expressly approved by the party responsible for compliance could void the user's authority to operate the equipment.

NOTE: This equipment has been tested and found to comply with the limits for a Class B digital device, pursuant to Part 15 of the FCC Rules. These limits are designed to provide reasonable protection against harmful interference in a residential installation. This equipment generates, uses and can radiate radio frequency energy and, if not installed and used in accordance with the instructions, may cause harmful interference to radio communications. However, there is no guarantee that interference will not occur in a particular installation. If this equipment does cause harmful interference to radio or television reception, which can be determined by turning the equipment off and on, the user is encouraged to try to correct the interference by one or more of the following measures:

- Reorient or relocate the receiving antenna.
- Increase the separation between the equipment and receiver.
- Connect the equipment into an outlet on a circuit different from that to which the receiver is connected.
- Consult the dealer or an experienced radio/TV technician for help.