



**NEW BRIGHT**

**CAUTION-ELECTRICALLY OPERATED PRODUCT. NOT RECOMMENDED FOR CHILDREN UNDER 8 YEAR OF AGE. AS WITH ALL ELECTRIC PRODUCTS, PRECAUTIONS SHOULD BE OBSERVED DURING HANDLING AND USE TO PREVENT ELECTRIC SHOCK**

**9.6V**  
**OPERATOR'S MANUAL**

**FULL FUNCTION**  
**RADIO CONTROL**

**FCC ID:G6D3200H**

**Caution: User is not permitted to change or modify this product**



**Controller and Vehicle**  
**ANTENNAS are packed**  
**in shipping foam in box.**

**Battery Requirements:**  
**One 9V Alkaline Battery**  
**One 9.6V Rechargeable Power Pack/Charger**

L 37010044G / JN376-98

# TROUBLE SHOOTING AND CARE FOR R/C VEHICLES

## **PROBLEM! VEHICLE DOES NOT MOVE**

- Are the + and -'s contacts correctly matched in transmitter?
- Are the metal contact tabs touching, rusty or dirty in transmitter?
- Are there batteries in vehicle and transmitter?
- Is the power switch on vehicle turned on?
- Is the battery/power pack weak or out of power?

## **PROBLEM! VEHICLE MOVES BY ITSELF**

- There is radio interference in the area.
- Another R/C vehicle with the same frequency is close by.
- The antenna of transmitter is not screwed in tight.
- The antenna is not fully extended.

## **PROBLEM! VEHICLE RUNS SLOWLY**

- The battery is weak or fading.
- The power pack is worn out and needs to be replaced.
- Batteries are not Alkaline, are miss matched or are old.

**IF VEHICLE HAS A NOTICEABLE DROP IN PERFORMANCE, INCONSISTENT MOVEMENT OR JUST FAILS TO RUN, RECHARGE POWER PACK AND/OR REPLACE A FRESH '9V' ALKALINE BATTERY.**

## **ATTENTION PARENTS!**

The Battery charger & battery pack need to be periodically examined for potential hazards and that any potentially hazardous parts be repaired or replaced.

# CHARGING THE POWER PACK

NEW BRIGHT 9.6 Volt Rechargeable NiCd Battery Pack and Charger.  
(Sold Separately)

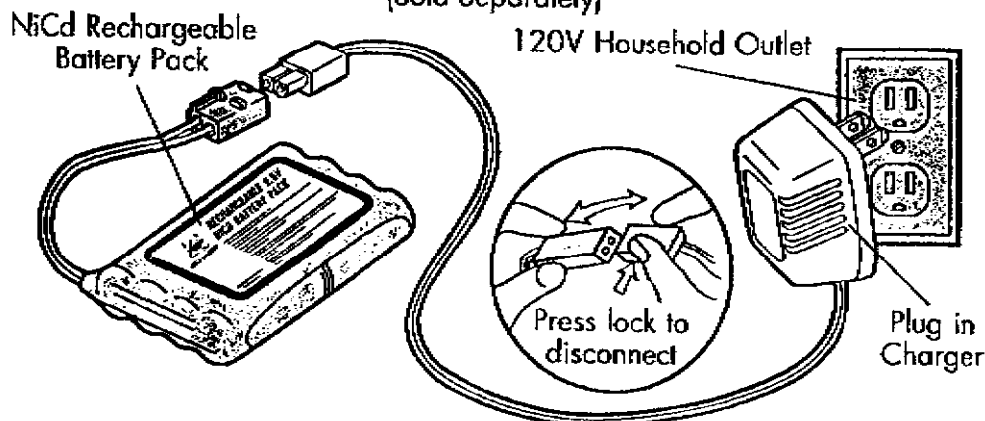

1. Plug charger into a 120V household outlet.
2. Connect the battery pack to the charger clip.
3. Charge the battery pack for 4HRS

NOTE: Pack is not charged when new. Pack is fully charged after 4hrs of charging, extended charging does not improve running time.

4. After charging for 4hrs, unplug charger and disconnect pack by pressing down on lever lock.

## Running Time

Battery pack can be charged up to 1,000 times!

Approximate running time is 20 to 30 min. Running time can vary from 10 to 20 min. according to size & weight of vehicle or speed & terrain. Battery pack will lose power or quit suddenly. Let pack cool, then recharge after removing pack from vehicle.

## CAUTION:

- Always disconnect units by pulling on plugs, do not pull on wires.
- Force on wire connections can cause shorting.
- Do not recharge warm or hot battery packs. Wait 20 min. until pack has cooled. Recharging too early will shorten pack life.
- Recharging near fire or high temperature is dangerous.
- Do not recharge packs that show wear or leakage.
- Always unplug battery pack when not in use.
- Do not dispose pack in fire, explosion or personal injury may occur.
- Dispose of NiCd battery packs properly, do not disassemble.
- Always remove battery pack from vehicle before charging.
- Do not use charger for any use other than instructed in directions.
- Periodical inspection of wires by parents is suggested.

## INSULATION OF VEHICLE ANTENNA

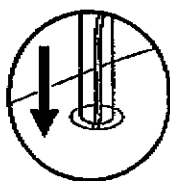
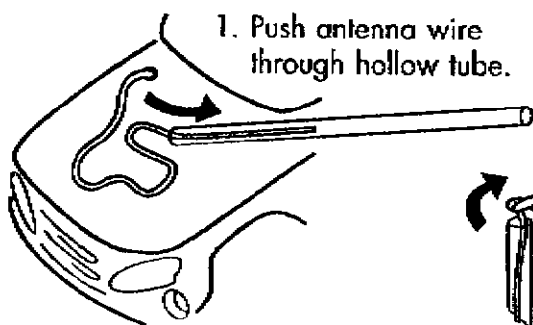

3. A knot may be tied at the top.  
(Do not pull wire tight)

## BATTERY INSTALLATION IN TRANSMITTER

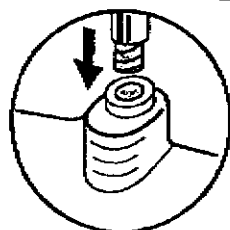

NOTE: FOR BEST PERFORMANCE ALWAYS USE ALKALINE BATTERIES.

Be sure the + and - are properly matched.

## BATTERY PACK INSTALLATION IN VEHICLE

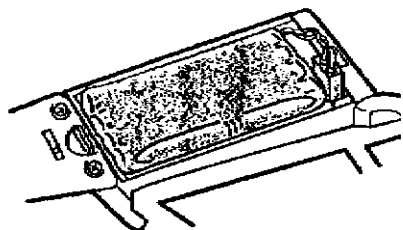
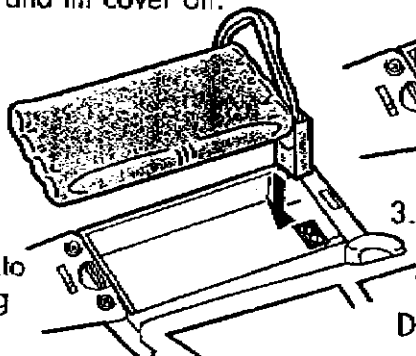
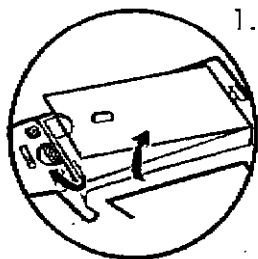

2. Join the pack connector plug into compartment plug receptacle and secure tightly.

3. Drop pack into position, close and lock cover.  
When disconnecting pack DO NOT PULL ON WIRES

## DRIVING THE VEHICLE

Turn ON/OFF switch on vehicle to the ON position for power.

Extend the antenna to full length. Indicator light works when in use.

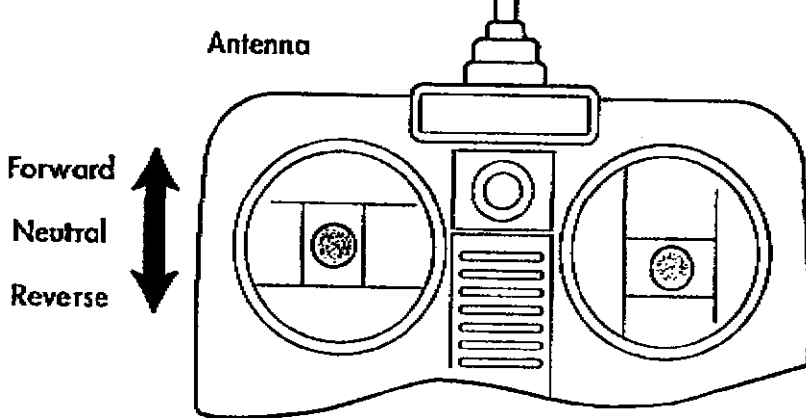

After play, always turn vehicle off. Remove '9V' battery and rechargeable pack when not in use or when stored. Leakage may occur and cause damage if left for a period of time.

# COMMON PROBLEMS OF R/C VEHICLES

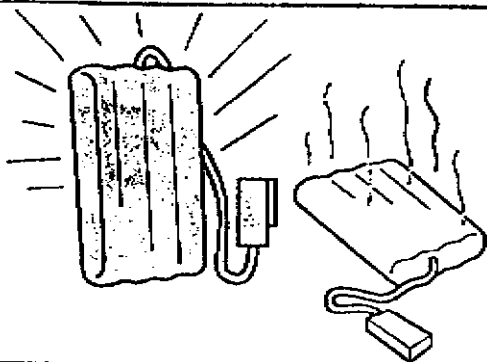

## Weak or Dead Power Pack

For best running performance, always start with pack fully charged. Partially charged packs will perform poorly.

## Installation of Power Pack

Be sure connector plugs are securely locked together. Do not pull on wires when disconnecting pack, this may short out system.

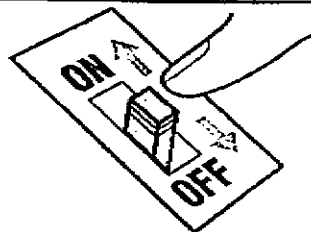
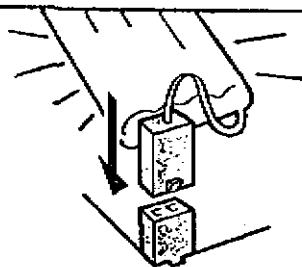

## Save Battery Life

Be sure vehicle is turned off when not in play.

## Range

Vehicle may go beyond radio signal contact. Loss of control or slowness will be evident when out of range. Hold transmitter antenna up high and keep screwed in tight for best reception.

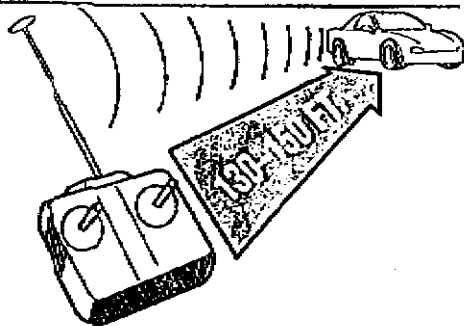

## Interference

Eraic behavior, loss of contact or jeking motion may occur in areas of high tension wires, phone poles or CB radios.

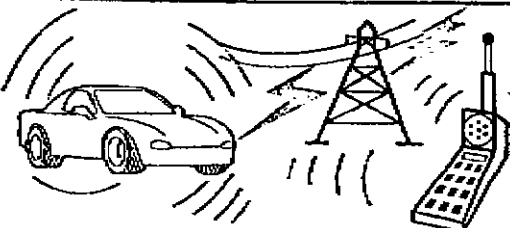

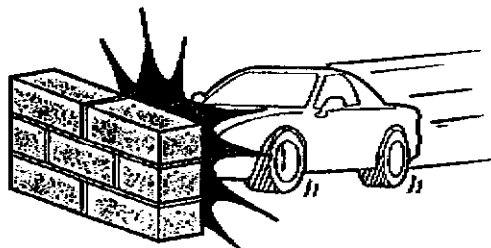

Avoid collisions with hard surfaces.

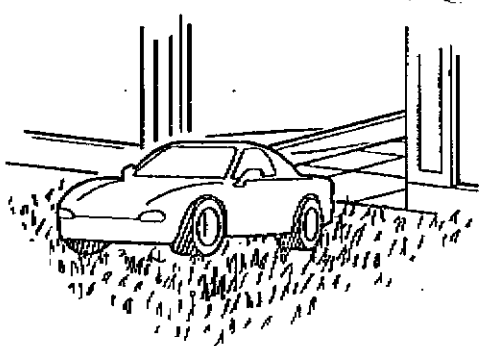

Avoid running on thick pile carpeting or dusty floors.

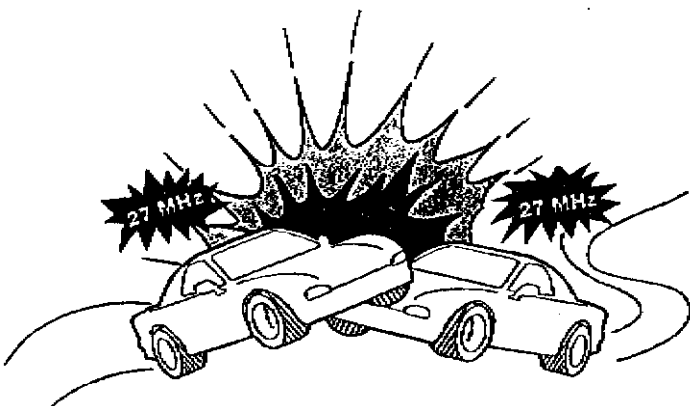

Avoid running 2 vehicles with the same frequency. Always run one at a time unless you purchase vehicles with different frequencies.

## CLEANING AND MAINTAINING HINTS

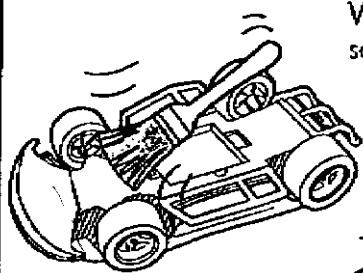

Brush areas where dirt and dust get trapped.

Wipe body off with a soft rag or tact cloth.

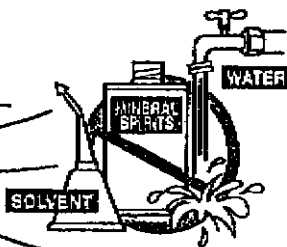
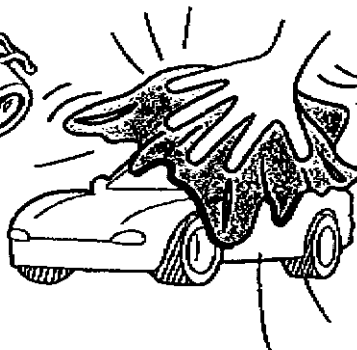

Do not clean vehicle with chemicals or water.

# OPERATING AND CARING FOR YOUR VEHICLE

Radio waves control and drive the vehicle. Any of the following conditions may interfere with the behavior and function.

The transmitter signals can easily be interrupted, caring for your transmitter and vehicle is illustrated on these pages.

## Do not abuse your vehicle!

Remember to avoid water, heat, sand and high impact crashes!

Off road vehicles may run on grassy areas.



Keep vehicle away from wet surfaces or rain.

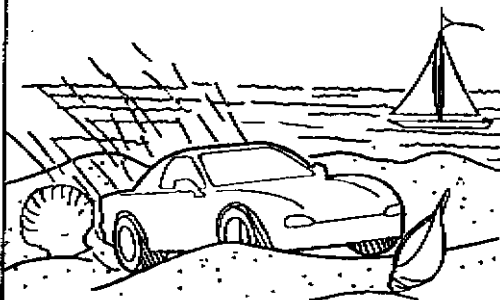

Keep vehicle away from sandy, dusty areas.

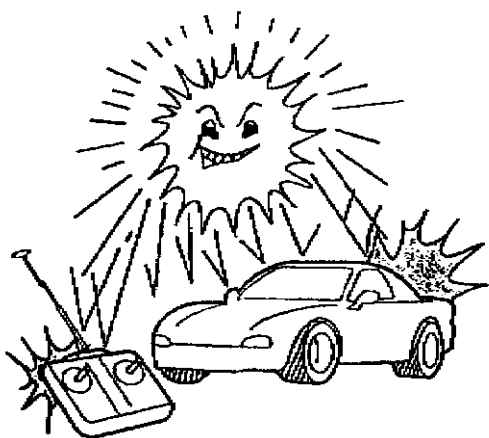

Electronic instruments are very sensitive to direct sunlight or heat. Avoid long periods of play under direct sunlight.

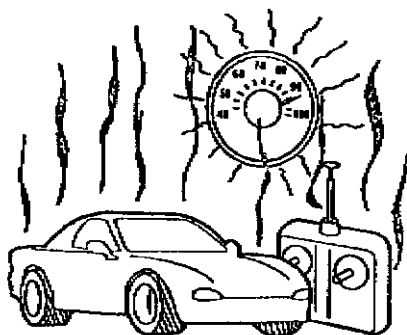

Always store vehicle and transmitter in a dry cool place away from heaters or hot air registers.