

QUALITY TOY
New BRIGHT



**Radio Control
Vehicle**

OWNERS MANUAL

Please read and understand all precautions prior to use.

Do not return this toy to the store!
*We stand behind our product. If you experience difficulty assembling,
charging or operating this toy, please call us and let us help.*

Call us toll-free at: **1-866-697-2869**
8:00am - 5:00pm E.S.T. Mon-Fri

Or visit us online at: www.newbright.com

L850100985/JN313-06

- Page 1: Table of Contents
- Page 2: Component Checklist
- Page 3: Battery Clip Installation in Vehicle
- Page 4: Vehicle Features
Vehicle Antenna
- Page 5: Transmitter Battery Installation
Transmitter Features
- Page 6: Proper Use and Precautions
Care
- Page 7: Trouble Shooting
Cautions

To protect components from damage, they may be packed in the styrofoam tray out of plain sight. Please search styrofoam tray and remove all of the components listed below. Styrofoam should be saved for storing your vehicle.

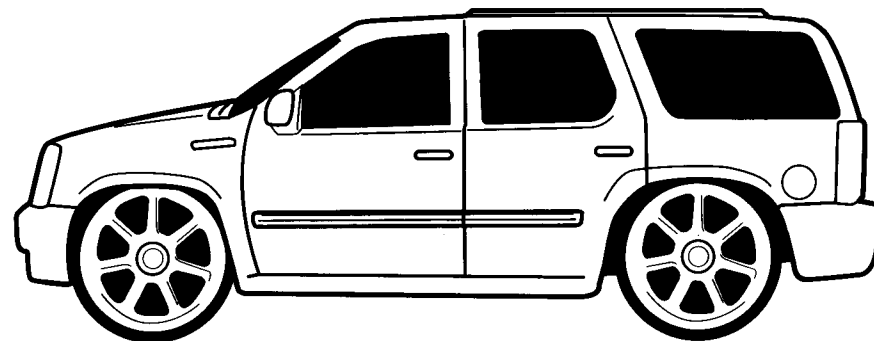

1

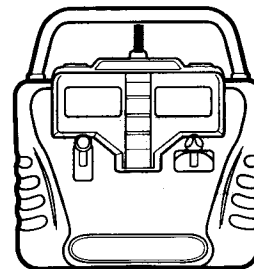

1

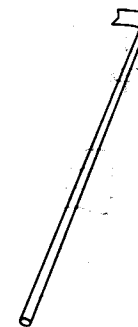

1

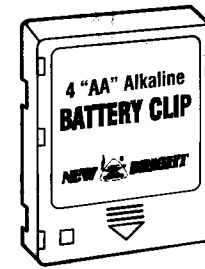

1

Vehicle

Battery Clip Installation

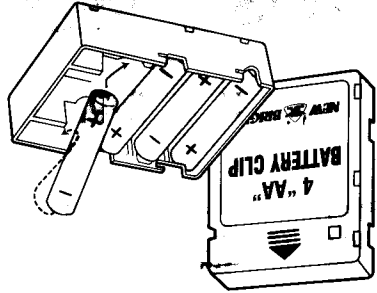

Note: When replacing Battery Clip batteries:

Use alkaline batteries only.

Do not mix old and new batteries.

Do not mix alkaline, standard or rechargeable batteries.

Power Option 2

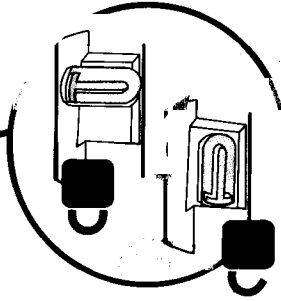
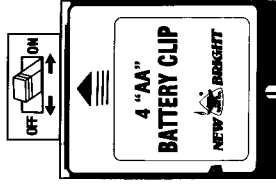
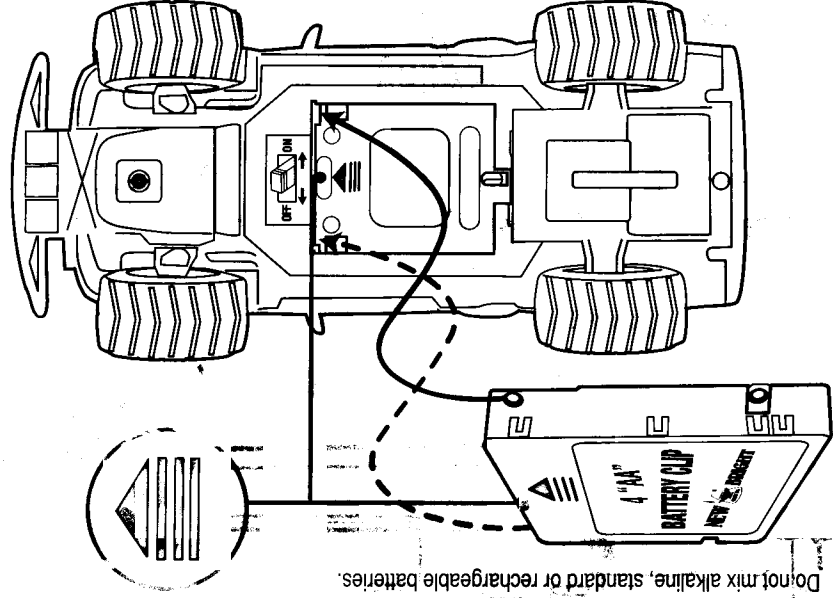
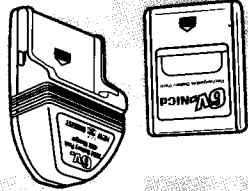

Vehicle

Features and Functions



Steering Trim*



ON/OFF Switch

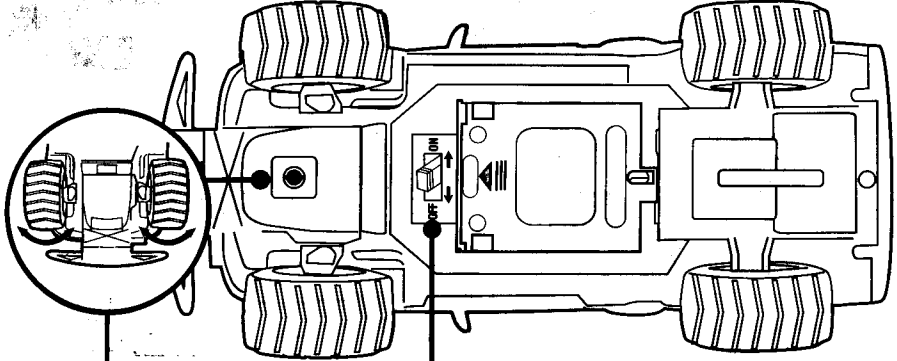

* If vehicle pulls to the right or left during forward driving the Steering Trim may need to be adjusted. Steering Trim Dial is located on bottom of chassis between the front wheels.

Vehicle

Antenna Placement

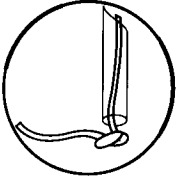
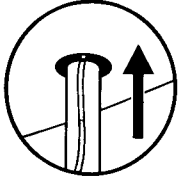
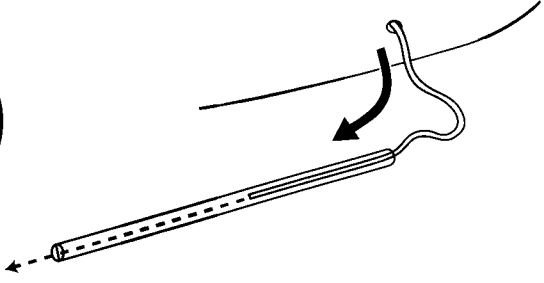

Transmitter

Battery Installation

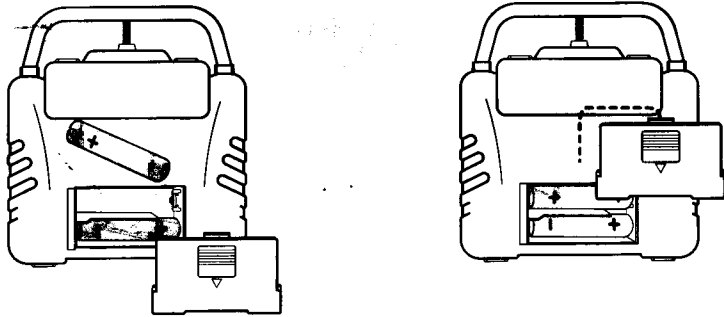

Transmitter

Features and Functions

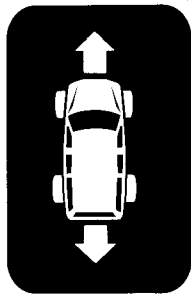

Forward/Reverse

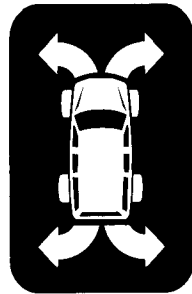

Left/Right Steering

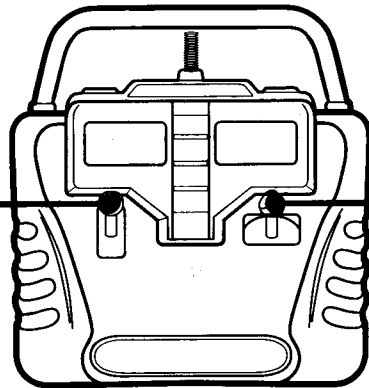

Note: When replacing Transmitter batteries:
Use only Alkaline batteries.
Do not mix old and new batteries.
Do not mix alkaline, standard or rechargeable batteries.

Proper Use

Precautions and Care

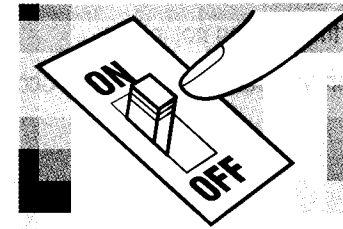
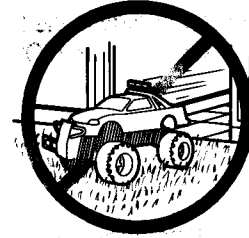
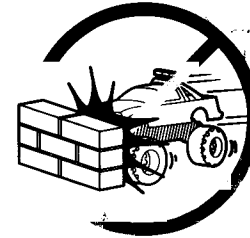
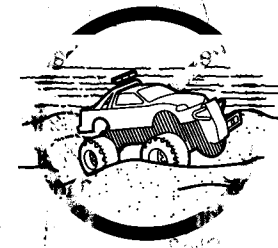
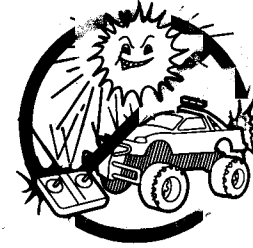

Switch vehicle OFF when not in use.

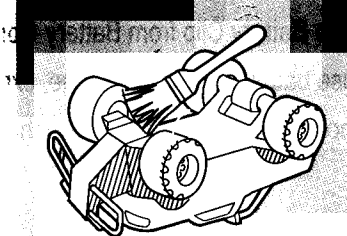

Brush areas where dirt gets trapped.

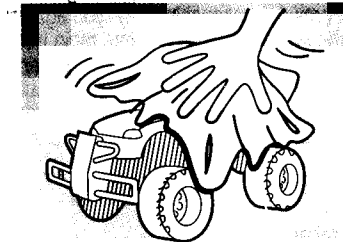

Wipe body with a soft rag or tact cloth.

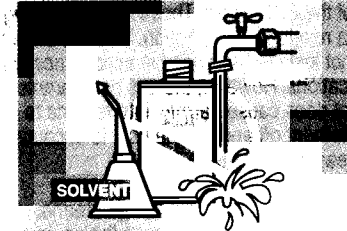

Do not use chemicals or water to clean

Support

Trouble Shooting

Problem - Vehicle does not move or moves slowly.

- Make certain there are fresh alkaline batteries in the transmitter and that they have been installed in the correct position.
- Are the (+) and (-) markings on the alkaline batteries in the same position as the (+) and (-) markings in the Transmitter Battery Compartment?
- Has the Battery Clip been installed in the vehicle?
- Are the (+) and (-) markings on the Batteries in the same position as the (+) and (-) markings in the Battery Clip?
- Are the metal contact tabs touching, rusty or dirty in the transmitter?
- Make certain that the vehicle ON/OFF switch is in the "ON" position.

Problem - Vehicle moves by itself or exhibits reduced range from the transmitter.

- Make certain there is no outside radio interference in your area. The best way to test this is to take the vehicle as far away from radio towers, electrical lines or tall buildings as possible to ensure no further radio interference will occur.

Always remove Battery Clip from Battery Compartment when not in use.

Do not dispose batteries in fire. Leakage, explosion and personal injury may occur.

Do not attempt jumps or tricks with this vehicle.

FCC CAUTION:

The manufacturer is not responsible for radio interference caused by unauthorized frequency modification to this equipment. Such modifications could void the user's authority to operate the equipment.

NOTE: This equipment has been tested and found to comply with the limits for a Class B digital device, pursuant to Part 15 of the FCC Rules. These limits are designed to provide reasonable protection against harmful interference in a residential installation. This equipment generates, uses and can radiate radio frequency energy and, if not installed and used in accordance with the instructions, may cause harmful interference to radio communications. However, there is no guarantee that interference will not occur in a particular installation. If this equipment does cause harmful interference to radio or television reception, which can be determined by turning the equipment off and on, the user is encouraged to try to correct the interference by one or more of the following measures:

- Reorient or relocate the receiving antenna.
- Increase the separation between the equipment and receiver.
- Connect the equipment into an outlet on a circuit different from that to which the receiver is connected.
- Consult the dealer or an experienced radio/TV technician for help.