



OWNER'S MANUAL

Please read and understand all precautions prior to use.

Thank you for choosing a premium New Bright product.

USA & Canada
30-Day Limited Warranty

New Bright Industries warrants to the original purchaser that this product will be free of defects in materials and workmanship for thirty (30) days from the date of purchase. In the event of such defect within the warranty period, New Bright will repair or replace the product at our sole discretion. This warranty does not cover damage resulting from unauthorized modifications, accident, misuse or abuse.

Should your item have a defect covered under this warranty, first call the toll free number listed below. Most problems can be resolved in this manner. If necessary, you will be issued a Return Authorization number (RA) and instructions on how to obtain a Product Return Form. The Product Return Form is to be used when returning a product to us (postage pre-paid and insured by the consumer).

When returning a defective product, please package the product, the Product Return Form and a copy of the dated sales receipt as proof of purchase. Be sure to mark the RA number on the Product Return Form. If the product is returned without a dated sales receipt, it will be excluded from coverage under this warranty. Please allow 4 to 6 weeks for delivery of repaired or replacement vehicles (depending on your location).

New Bright Industries' liability for defects in materials and workmanship under this warranty shall be limited to repair or replacement at our sole discretion. In no event shall we be responsible for incidental, consequential or contingent damages (except in those states that do not allow this exclusion or limitation).

Valid only in the USA & Canada.

Contact New Bright Industries Customer Service Toll Free at:

1-877-NBTOYS

(1-877-624-8697)

Monday through Friday, 8:00 AM to 5:00 PM Eastern Time

REF-US2416

JN195-20

CONTENTS

Component Checklist

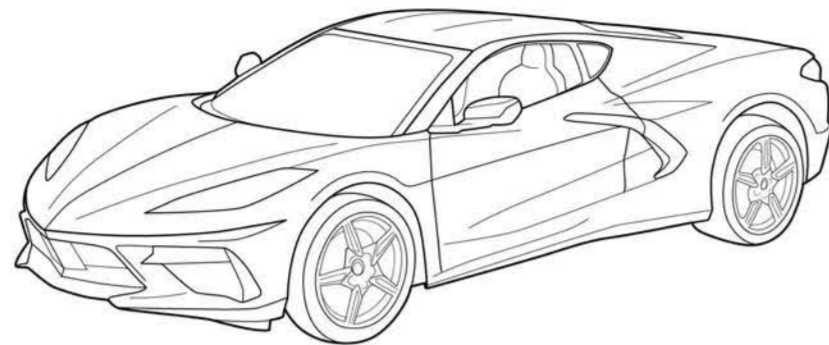

(1) R/C Vehicle With USB Cord

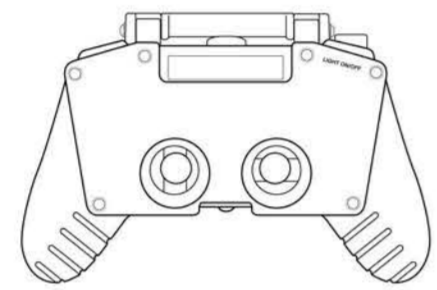

(1) Transmitter

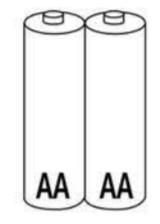

(2) "AA" Batteries

APP

App Download

Additional features and functions are available and require the user to download and install the 'App Driver' app onto a smart device to access. No charge to download. Data rates may apply.



Apple Users:
Search "New Bright App Driver" in the App Store; Install.



Android™ Users:
Search "New Bright App Driver" in Android Market or Google Play; Install.

App Set Up

1. Install app to device.
2. Make certain the vehicle is fully charged (See charging instructions in 'Recharging the Vehicle').
3. Move ON/OFF switch to the 'ON' position (See 'Vehicle Features' for Switch location). Vehicle lights will turn on.
4. Launch the App Driver app on your smart device.
5. When launching, the app will ask to enable a connection with your device. Select yes to continue to use the app. This allows the app and your device to communicate with the vehicle. (If a proper connection has not been made, you will be prompted to repeat steps 2-4).
6. The vehicle and app are now communicating.
7. After a connection is established, you will be notified that the control range when using the app is limited. Use the included joystick controller when longer range is needed.

The App features 4 ways to control your vehicle:

1. Select 'Drive Mode' and choose 'Touch' to control your vehicle using the touch screen or select 'Tilt' to control your vehicle using the gyroscope sensor in your device. Music, sound and light controls are also available. See instructions in 'Using the App'.
2. Selecting 'Draw Mode' allows you to draw a path and have the vehicle travel along that path. Music, sound and light controls are also available. See instructions in 'Using the App'.
3. Selecting 'Code Mode' allows you to program each segment of the vehicle's path adding sounds, music, and controlling the lights along the way. See instructions in 'Using the App'.

*Tilt Mode Setup:

1. After selecting Tilt Mode you will be prompted to set the desired Neutral or Stop position. When your device is held at this position, the car will not move. Placing the device on a flat surface is NOT recommended for this mode. Exit Tilt Mode and start again to recalibrate.
2. Remember to exit Tilt Mode or close the app when finished or the vehicle may continue to be controlled by the movement of your device.

USING the APP

Home Screen

Below is the App Home Screen. Start by Selecting the Vehicle you have. When the image of your vehicle is displayed you can then select a mode from the 3 mode options on the left.

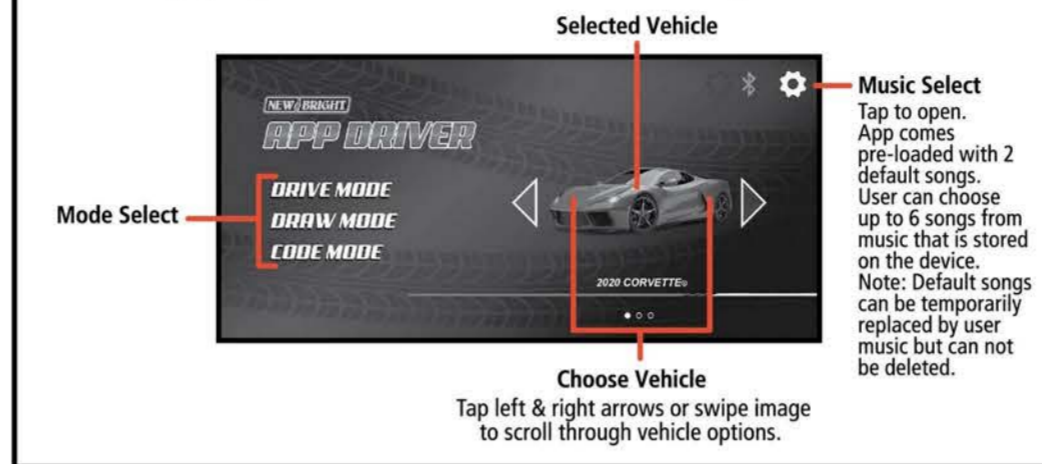

Drive Mode

Drive Mode allows you to use your device to control the vehicle by Touch or by Tilt. Mode, Sound, Light and Music options are available. Refer to the 'More Info' section for details on these options.

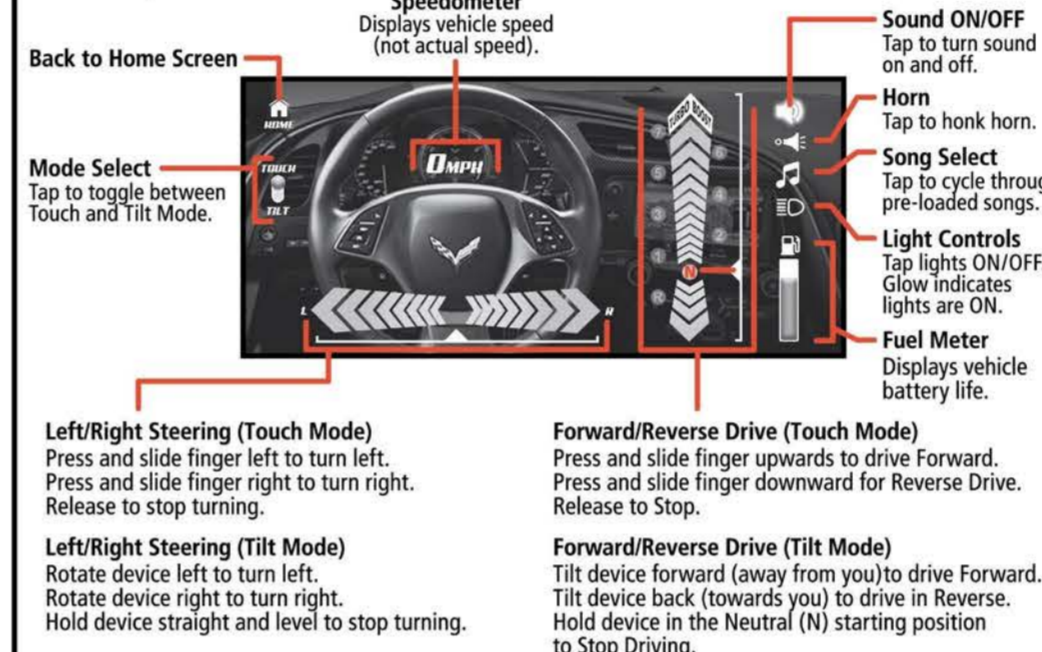

USING the APP

Draw Mode

Draw Path Mode allows you to use your finger to draw any path on the screen and the vehicle will drive that path. Speed, Lights, Music, Save and Load options are also available. Refer to the 'More Info' section for details on these options.

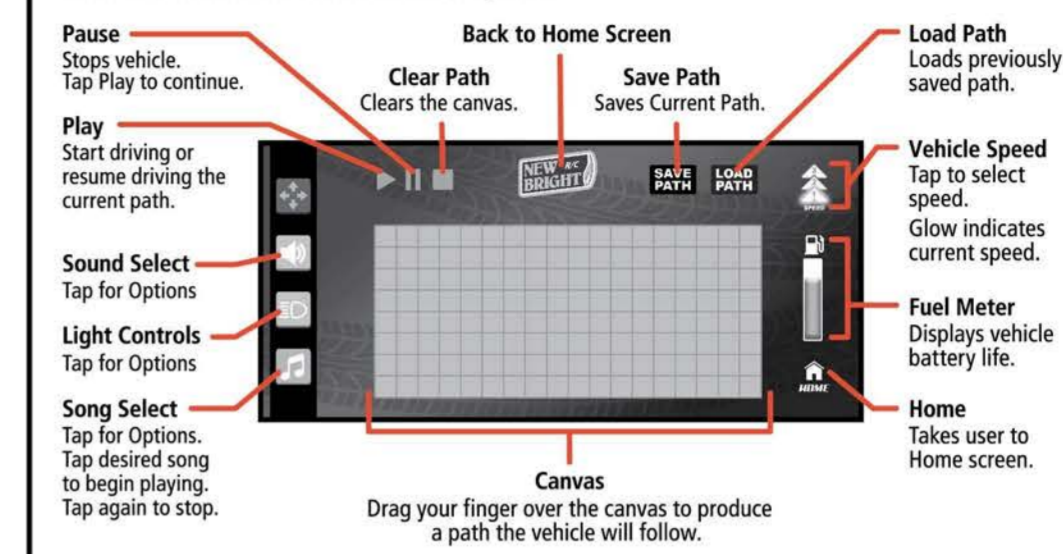

More Info

Individual menu options are explained below in-depth.

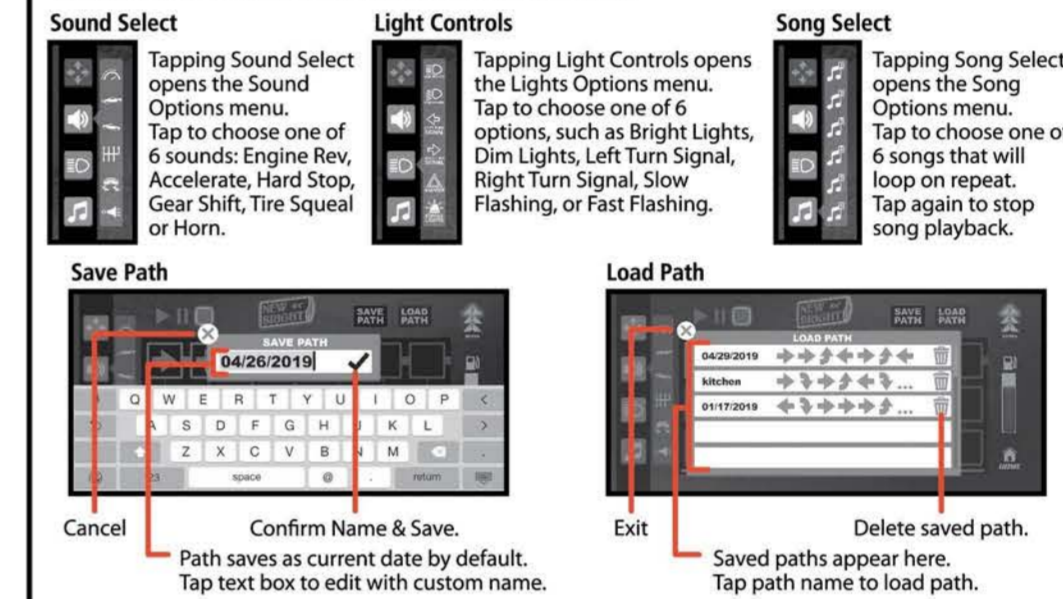

USING the APP

Code Mode

Code Path Mode allows you to select a sequence of directions that the vehicle will follow. Mode, Speed, Lights, Music, Save and Load options are available. Refer to the 'More Info' section for details on these options.

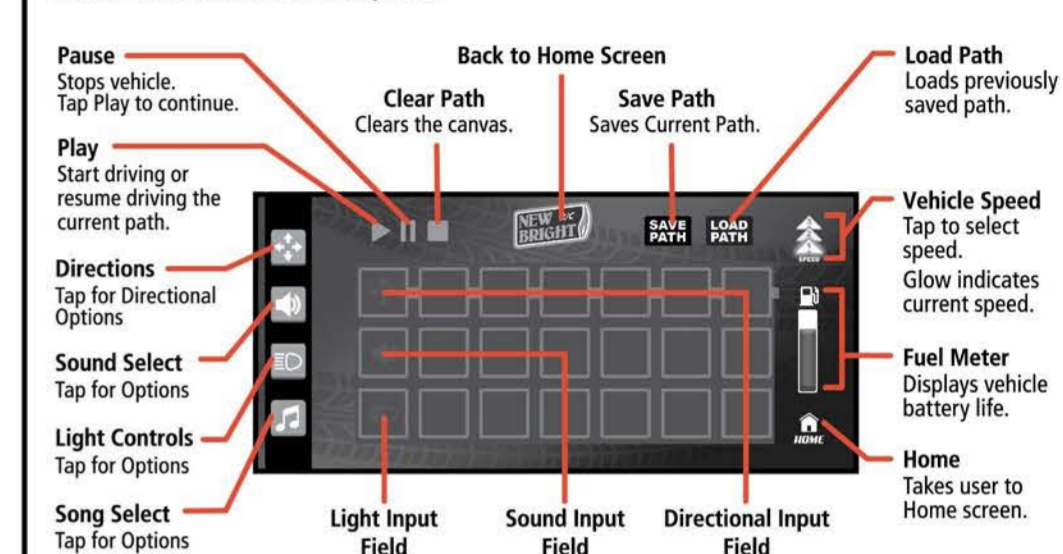

Below is an example of a coded path.

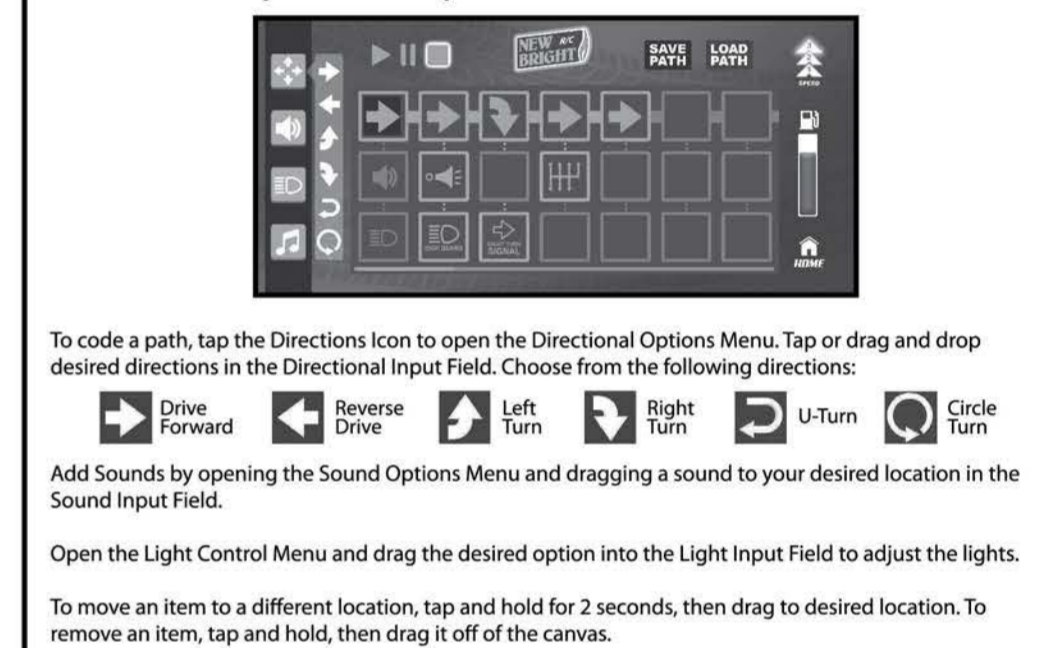

TRANSMITTER

TRANSMITTER

Battery Installation

1. Flip smart phone holder up to reveal battery compartment.
2. Press and slide in the direction of the arrow open battery compartment cover.

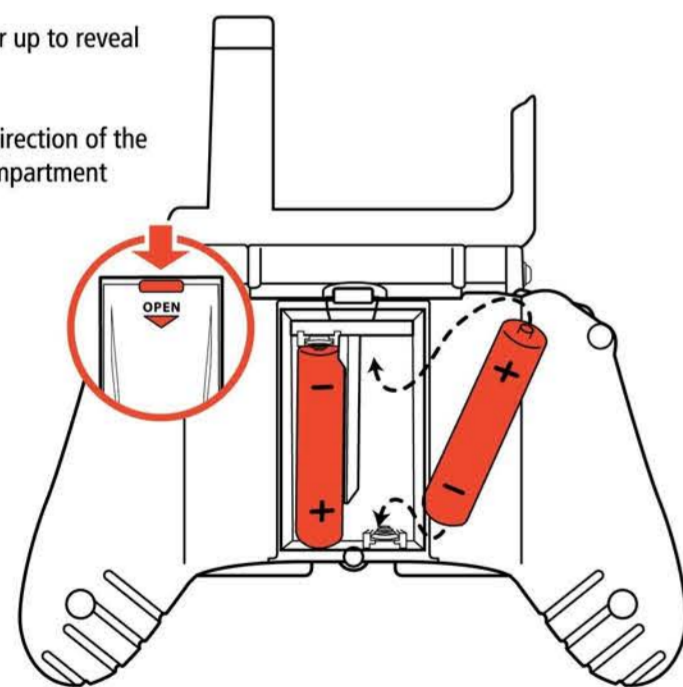

3. Insert 2 "AA" size batteries. Make sure the positive (+) and negative (-) markings on the batteries match the markings inside the Battery Compartment.

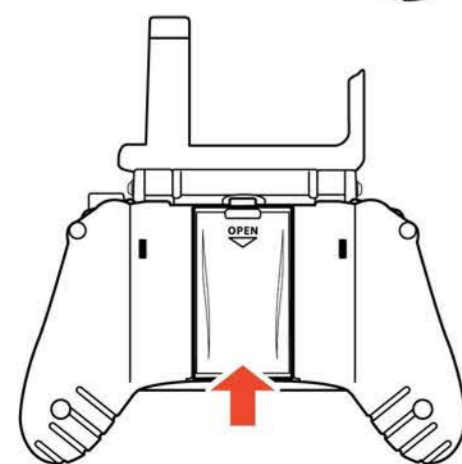

Note: When replacing Transmitter batteries:
Do not mix old and new batteries.
Do not mix alkaline, standard or rechargeable batteries.
Use alkaline batteries only.

Features and Functions

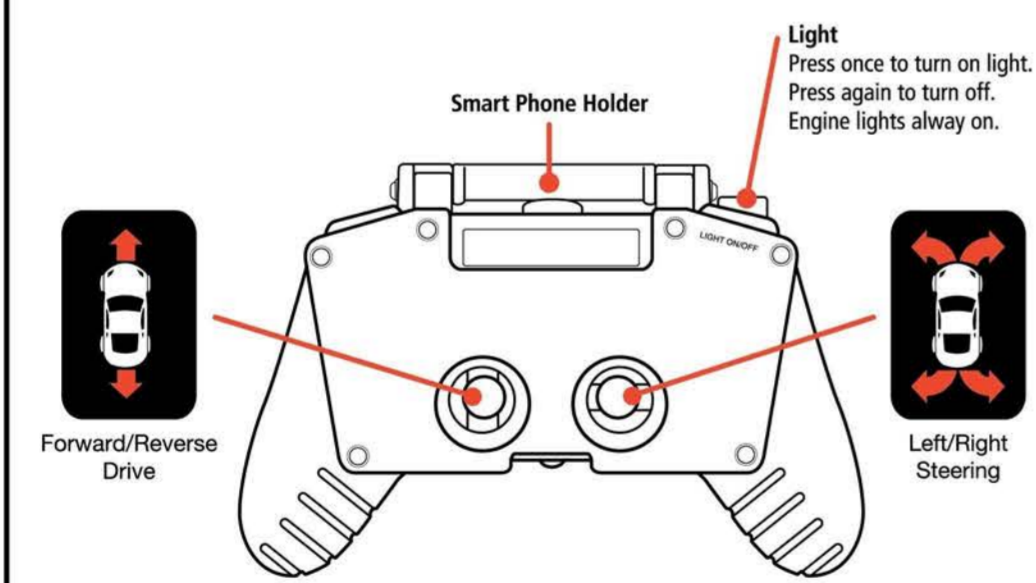

This transmitter is equipped with 2.4GHz technology which allows up to 6 vehicles to be raced at the same time.

Once vehicle and transmitter batteries have been correctly installed and vehicle ON/OFF Switch is in the ON position, the transmitter will automatically sync with the vehicle.

Smart Phone Holder

Locate the Smart Phone Holder at the back of the transmitter. Flip forward into the upright position. Next, gently pull up on the clamp while sliding phone in. Release clamp when phone is in place.

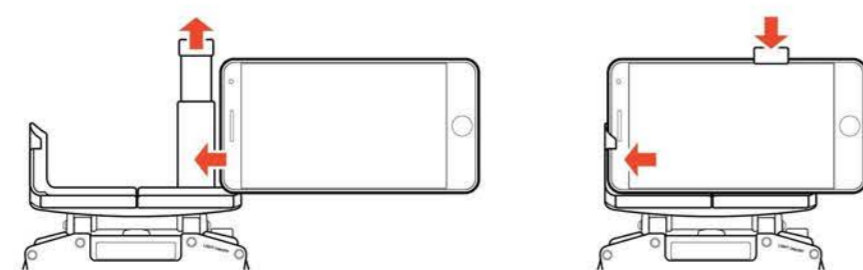

VEHICLE

Features and Functions

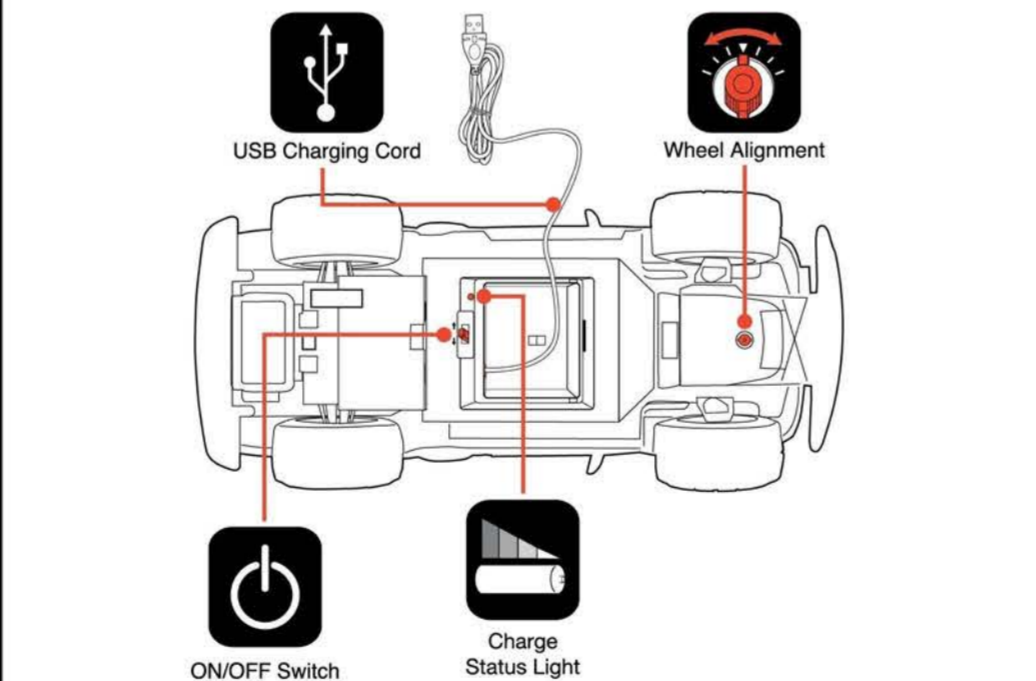

* If vehicle pulls to the left or right during forward driving the Wheel Alignment may need to be adjusted. The Wheel Alignment Dial is located on bottom of chassis between the front wheels.

This device complies with the licence-exempt transmitter(s)/receiver(s) that comply with Innovation, Science and Economic Development Canada's licence-exempt RSS(s). Operation is subject to the following two conditions: (1) This device may not cause interference; and (2) This device must accept any interference, including interference that may cause undesired operation of the device.

L'émetteur/récepteur exempt de licence contenu dans le présent appareil est conforme aux CNR d'Innovation, Sciences et Développement économique Canada applicables aux appareils radio exempts de licence. L'exploitation est autorisée aux deux conditions suivantes: (1) L'appareil ne doit pas produire de brouillage; (2) L'appareil doit accepter tout brouillage radioélectrique subi, même si le brouillage est susceptible d'en compromettre le fonctionnement.

VEHICLE

Charging the Battery

This vehicle is equipped with an internal Lithium-Ion battery that is recharged via USB. ON/OFF Switch must be in the OFF position prior to charging.

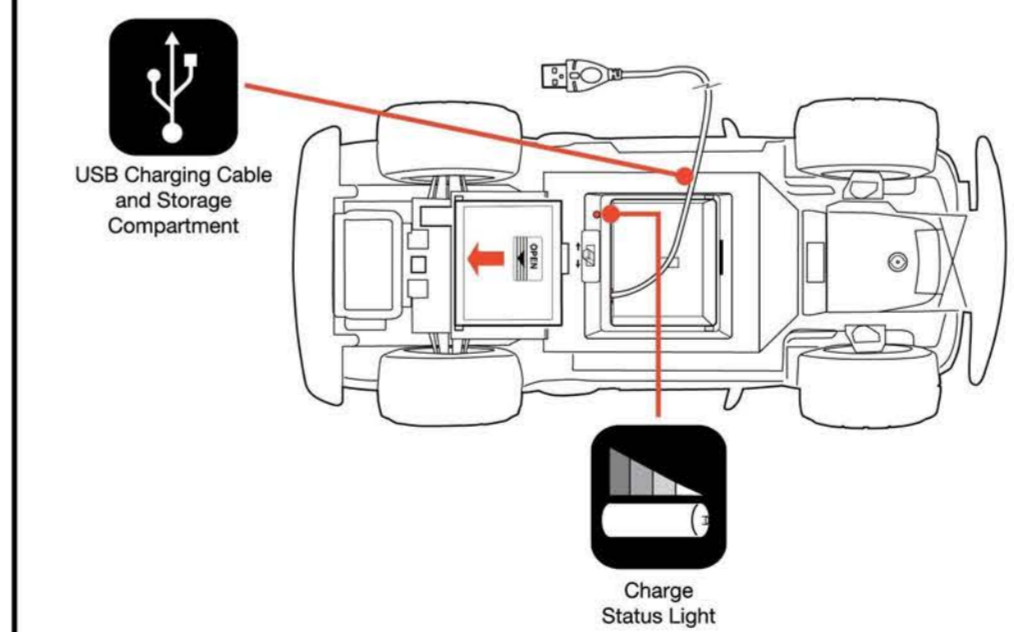

1. Locate the ON/OFF switch and USB cord on the under-side of the vehicle.
2. Turn the ON/OFF switch to the "OFF" position.
3. Open Storage Compartment cover.
4. Remove USB cable from the Storage Compartment. (Use care when extending cord as it is attached to inside internal battery). Cord can be plugged into any computer or USB outlet brick (not included).

5. While charging, the LED under the vehicle will be on. Once fully charged the LED will turn off. Charging is completed in approximately 2 - 2.5 hour. Return cord and secure storage lid before operating the vehicle.

PROPER USE

Precautions & Care

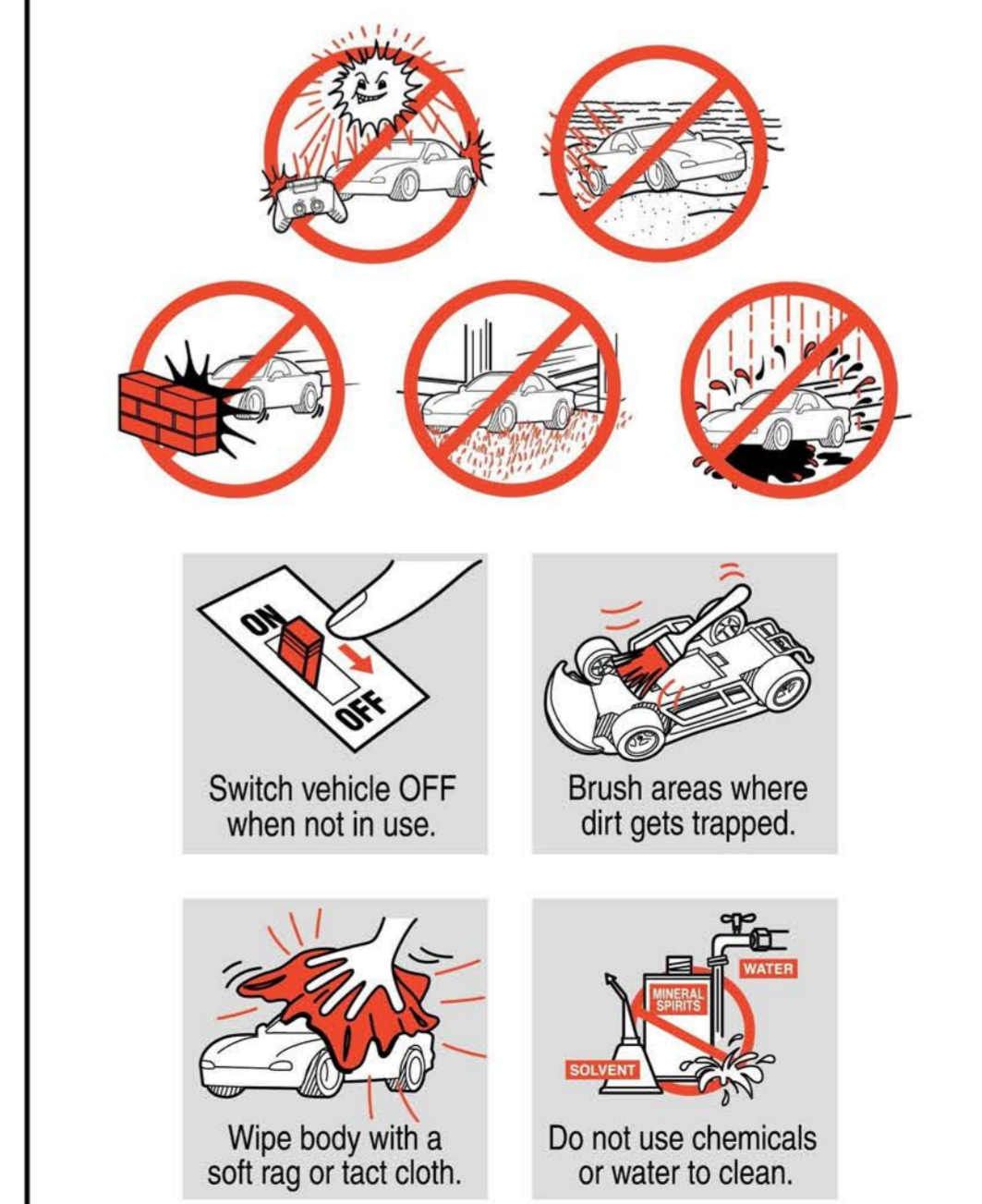

SUPPORT

Trouble Shooting & Support

Problem - Vehicle does not move or moves slowly.
- Make certain there are fresh alkaline batteries in the transmitter and that they have been installed in the correct position.
- Are the (+) and (-) markings on the alkaline batteries in the same position as the (+) and (-) markings in the Transmitter Battery Compartment?
- Are the metal contact tabs touching, rusty or dirty in the transmitter?
- Has the vehicle been fully charged?
- Make certain that the vehicle ON/OFF switch is in the "ON" position.

Problem - Vehicle moves by itself or exhibits reduced range from the transmitter.
- Make certain there are no outside radio interference in your area. The best way to test this is to take the vehicle as far away from radio towers, electrical lines or tall buildings as possible to ensure no further radio interference will occur.

Always remove Batteries from transmitter when not in use. Do not dispose batteries in fire. Leakage, explosion and personal injury may occur. Do not attempt jumps or tricks with this vehicle. Do not attempt to remove internal battery. Do not use included USB cord for anything other than its intended purpose. Always keep USB cord stored when not in use. Adult supervision recommended.

FCC CAUTION:
Changes or modifications not expressly approved by the party responsible for compliance could void the user's authority to operate the equipment.

NOTE: This equipment has been tested and found to comply with the limits for a Class B digital device, pursuant to Part 15 of the FCC Rules. These limits are designed to provide reasonable protection against harmful interference in a residential installation. This equipment generates, uses and can radiate radio frequency energy and, if not installed and used in accordance with the instructions, may cause harmful interference to radio communications. However, there is no guarantee that interference will not occur in a particular installation. If this equipment does cause harmful interference to radio or television reception, which can be determined by turning the equipment off and on, the user is encouraged to try to correct the interference by one or more of the following measures:
- Reorient or relocate the receiving antenna.
- Increase the separation between the equipment and receiver.
- Connect the equipment into an outlet on a circuit different from that to which the receiver is connected.
- Consult the dealer or an experienced radio/TV technician for help.