



FCC 47 CFR PART 15 SUBPART C

TEST REPORT

For

Micro Bluetooth® Stereo with CD Player and FM Radio

Model: MC-3941, BWA16AA002

Brand: OHAYO, BLACKWEB

Test Report Number:

C160202Z02-RP1

Issued for

ACE INTERNATIONAL ELECTRONICS LTD.

**Unit 2308,23th FLOOR RILEY HOUSE 88 LEI MUK ROAD, KWAI CHUNG,
N.T HONG KONG**

Issued by:

COMPLIANCE CERTIFICATION SERVICES (SHENZHEN) INC.

**No.10-1, Mingkeda Logistics Park, No.18, Huanguan South Rd.,
Guan Lan Town, Baoan District, Shenzhen China**

TEL: 86-755-28055000

FAX: 86-755-28055221

E-Mail: service@ccssz.com

Issued Date: March 29, 2016



TESTING CERT #2861.01

Note: This report shall not be reproduced except in full, without the written approval of Compliance Certification Services (Shenzhen) Inc. This document may be altered or revised by Compliance Certification Services (Shenzhen) Inc. personnel only, and shall be noted in the revision section of the document. The client should not use it to claim product endorsement by TAF, A2LA, NVLAP, NIST, CNAS or any government agencies. The test result of this report relate only to the tested sample identified in this report.



Revision History

| Rev. | Issue Date | Revisions | Effect Page | Revised By |
|------|----------------|---------------|-------------|------------|
| 00 | March 29, 2016 | Initial Issue | ALL | Nancy Fu |
| | | | | |
| | | | | |
| | | | | |



TABLE OF CONTENTS

1. TEST RESULT CERTIFICATION..... 4

2. EUT DESCRIPTION 5

3. TEST METHODOLOGY 6

 3.1 DESCRIPTION OF TEST MODES 6

4. FACILITIES AND ACCREDITATIONS..... 7

 4.1 FACILITIES 7

 4.2 ACCREDITATIONS 7

 4.3 MEASUREMENT UNCERTAINTY 7

5. SETUP OF EQUIPMENT UNDER TEST 8

 5.1 SETUP CONFIGURATION OF EUT 8

 5.2 SUPPORT EQUIPMENT 8

6. FCC PART 15.247 REQUIREMENTS 9

 6.1 20DB BANDWIDTH 9

 6.2 ANTENNA GAIN..... 14

 6.3 PEAK POWER..... 15

 6.4 PEAK POWER SPECTRAL DENSITY 17

 6.5 BAND EDGES MEASUREMENT 18

 6.6 FREQUENCY SEPARATION 28

 6.7 NUMBER OF HOPPING FREQUENCY 31

 6.8 TIME OF OCCUPANCY (DWELL TIME) 33

 6.9 SPURIOUS EMISSIONS 40

 6.10 POWERLINE CONDUCTED EMISSIONS 59



1. TEST RESULT CERTIFICATION

| | |
|---------------------|--|
| Product | Micro Bluetooth® Stereo with CD Player and FM Radio |
| Model | MC-3941, BWA16AA002 |
| Brand | OHAYO, BLACKWEB |
| Tested | February 2~ March 29, 2016 |
| Applicant | ACE INTERNATIONAL ELECTRONICS LTD. Unit 2308,23th FLOOR RILEY HOUSE 88 LEI MUK ROAD, KWAI CHUNG, N.T HONG KONG |
| Manufacturer | ACE INTERNATIONAL ELECTRONICS LTD. Unit 2308,23th FLOOR RILEY HOUSE 88 LEI MUK ROAD, KWAI CHUNG, N.T HONG KONG |

| APPLICABLE STANDARDS | |
|------------------------------|-------------------------|
| STANDARD | TEST RESULT |
| FCC 47 CFR Part 15 Subpart C | No non-compliance noted |

We hereby certify that:

The above equipment was tested by Compliance Certification Services (Shenzhen) Inc. The test data, data evaluation, test procedures, and equipment configurations shown in this report were made in accordance with the procedures given in ANSI C63.10:2013 and the energy emitted by the sample EUT tested as described in this report is in compliance with conducted and radiated emission limits of FCC Rules Part 15.207, 15.209 and 15.247.

The test results of this report relate only to the tested sample EUT identified in this report.

Approved by:

Sunday Hu
Supervisor of EMC Dept.
Compliance Certification Services (Shenzhen) Inc.

Reviewed by:

Ruby Zhang
Supervisor of Report Dept.
Compliance Certification Services (Shenzhen) Inc.



2. EUT DESCRIPTION

| | |
|------------------------------|--|
| Product | Micro Bluetooth® Stereo with CD Player and FM Radio |
| Model Number | MC-3941, BWA16AA002 |
| Brand | OHAYO, BLACKWEB |
| Model Discrepancy | They are identical to each other except for product model name and brand name; MC-3941's brand is OHAYO, BWA16AA002's brand is BLACKWEB. |
| Identify Number | C160202Z02-RP1 |
| Received Date | February 2, 2016 |
| Power Supply | AC120V~50Hz |
| Frequency Range | 2402 ~ 2480 MHz |
| Transmit Power | GFSK : -4.29dBm $\pi/4$ -DQPSK: -5.83dBm 8DPSK : -5.64dBm |
| Modulation Technique | FHSS (GFSK for 1Mbps, $\pi/4$ -DQPSK for 2Mbps, 8DPSK for 3Mbps) |
| Number of Channels | 79 Channels |
| Antenna Specification | PCB Antenna with 0dBi gain (Max) |
| Temperature Range | 0°C ~ +40°C |
| Hardware Version | 2230-03941-ED000 |
| Software Version | 150 |

Note: This submittal(s) (test report) is intended for FCC ID: G3OBWA16AA002 filing to comply with Section 15.207, 15.209 and 15.247 of the FCC Part 15, Subpart C Rules.



3. TEST METHODOLOGY

3.1 DESCRIPTION OF TEST MODES

The EUT has been tested under operating condition.
Test program used to control the EUT for staying in continuous transmitting and receiving mode is programmed.

| Test Item | Test mode | Worse mode |
|--------------------|-------------------|-------------------------------------|
| Conducted Emission | Mode 1: TX | <input checked="" type="checkbox"/> |
| Radiated Emission | Mode 1: TX | <input checked="" type="checkbox"/> |

Channel Low (2402MHz), Mid (2441MHz) and High (2480MHz) were chosen for pre-testing for GFSK, $\pi/4$ -DQPSK and 8DPSK, GFSK and 8DPSK were the worse case and print in the report.



4. FACILITIES AND ACCREDITATIONS

4.1 FACILITIES

All measurement facilities used to collect the measurement data are located at

**No.10-1, Mingkeda Logistics Park, No.18, Huanguan South Rd.,
Guan Lan Town, Baoan District, Shenzhen, China**

The sites are constructed in conformance with the requirements of ANSI C63.10:2013, ANSI C63.7 and CISPR Publication 22. All receiving equipment conforms to CISPR Publication 16-1, "Radio Interference Measuring Apparatus and Measurement Methods."

4.2 ACCREDITATIONS

Our laboratories are accredited and approved by the following accreditation body according to ISO/IEC 17025.

| | |
|--------------|------|
| USA | A2LA |
| China | CNAS |

The measuring facility of laboratories has been authorized or registered by the following approval agencies.

| | |
|---------------|---------------------------------------|
| USA | FCC |
| Japan | VCCI(C-4815, R-4320, T-2317, G-10624) |
| Canada | INDUSTRY CANADA |

Copies of granted accreditation certificates are available for downloading from our web site, <http://www.ccssz.com>

4.3 MEASUREMENT UNCERTAINTY

Where relevant, the following measurement uncertainty levels have been estimated for tests performed on the EUT as specified in CISPR 16-4-2:

| Parameter | Uncertainty |
|--|-------------|
| Radiated Emission, 30 to 200 MHz Test Site : 966(2) | +/-3.6880dB |
| Radiated Emission, 200 to 1000 MHz Test Site : 966(2) | +/-3.6695dB |
| Radiated Emission, 1 to 8 GHz | +/-5.1782dB |
| Radiated Emission, 8 to 18 GHz | +/-5.2173dB |
| Conducted Emissions | +/-3.6836dB |
| Band Width | 178kHz |
| Peak Output Power MU | +/-1.906dB |
| Band Edge MU | +/-0.182dB |
| Channel Separation MU | 416.178Hz |
| Duty Cycle MU | 0.054ms |
| Frequency Stability MU | 226Hz |

This uncertainty represents an expanded uncertainty expressed at approximately the 95% confidence level using a coverage factor of k=2.

The measured result is above (below) the specification limit by a margin less than the measurement uncertainty; it is therefore not possible to state compliance based on the 95% level of confidence. However, the result indicates that compliance (non-compliance) is more probable than non-compliance) with the specification limit.



5. SETUP OF EQUIPMENT UNDER TEST

5.1 SETUP CONFIGURATION OF EUT

See test photographs attached in Appendix 1 for the actual connections between EUT and support equipment.

5.2 SUPPORT EQUIPMENT

| No. | Equipment | Model No. | Serial No. | FCC ID | Brand | Data Cable | Power Cord |
|-----|-----------|-----------|-------------|--------|--------|---------------------|--|
| 1 | Notebook | B475 | WE04591721 | DoC | LENOVO | N/A | Unshielded 1.45m (AC Cable) Unshielded 1.75m (DC Cable) |
| 2 | IPOD | A1285 | YM91545C3QY | N/A | APPLE | Unshielded 0.70m | N/A |
| 3 | CD | N/A | N/A | N/A | N/A | N/A | N/A |

Notes: Grounding was established in accordance with the manufacturer's requirements and conditions for the intended use.



6. FCC PART 15.247 REQUIREMENTS

6.1 20DB BANDWIDTH

None; for reporting purpose only.

MEASUREMENT EQUIPMENT USED

| Name of Equipment | Manufacturer | Model | Serial Number | Last Calibration | Due Calibration |
|-------------------|--------------|--------|---------------|------------------|-----------------|
| Spectrum Analyzer | Agilent | E4446A | US44300399 | 02/21/2016 | 02/20/2017 |

Remark: Each piece of equipment is scheduled for calibration once a year.

TEST CONFIGURATION

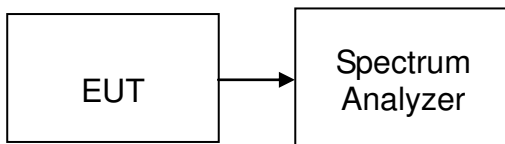

TEST PROCEDURE

1. Place the EUT on the table and set it in the transmitting mode.
2. Remove the antenna from the EUT, then connect a low loss RF cable from antenna port to the spectrum analyzer.
3. Set the spectrum analyzer as RBW=30 kHz, VBW=100 kHz, Span=3MHz, Sweep = auto.
4. Mark the peak frequency and 20dB (upper and lower) frequency.
5. Repeat until all the test channels are investigated.

TEST RESULTS

No non-compliance noted



Test plot

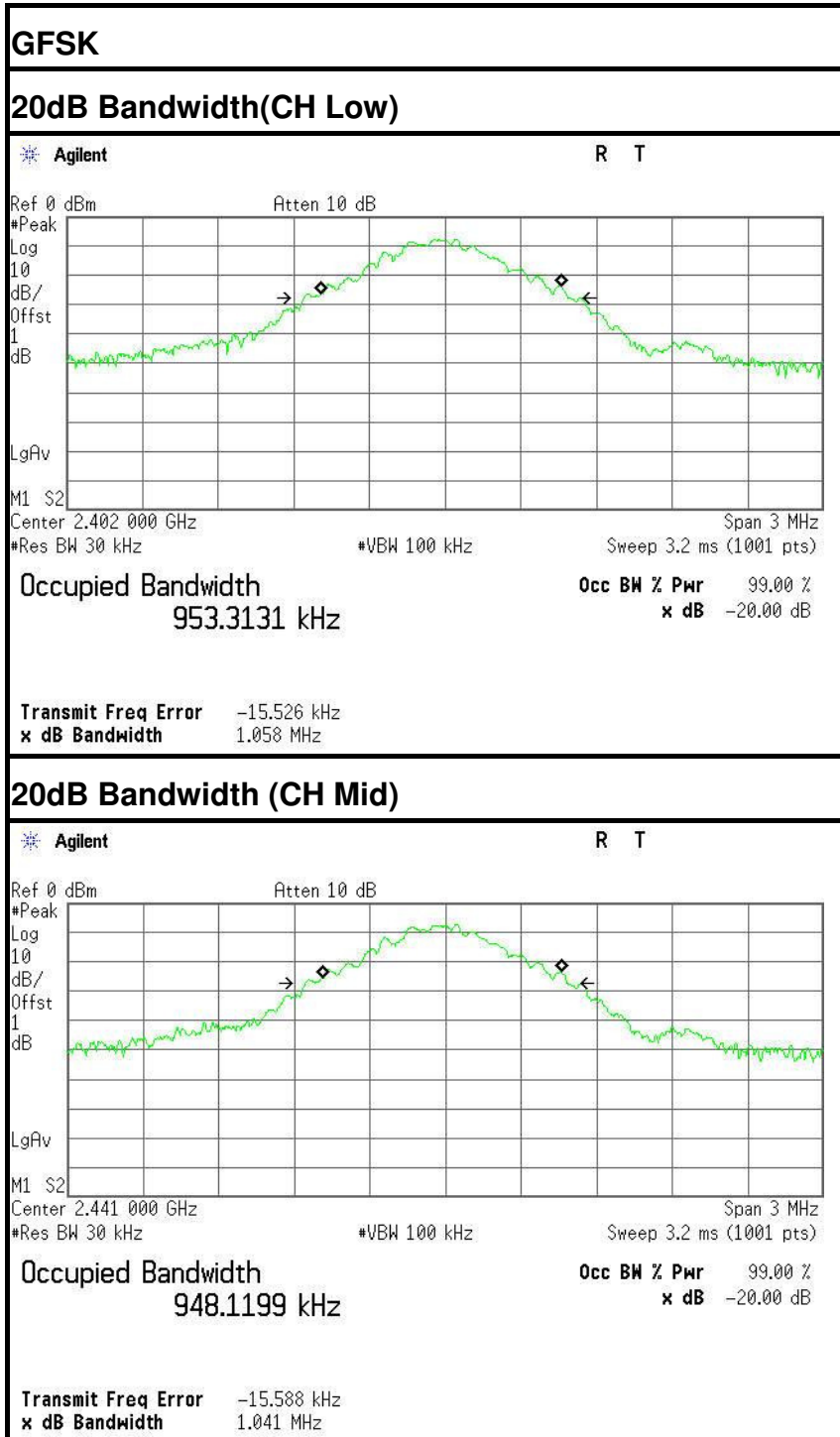

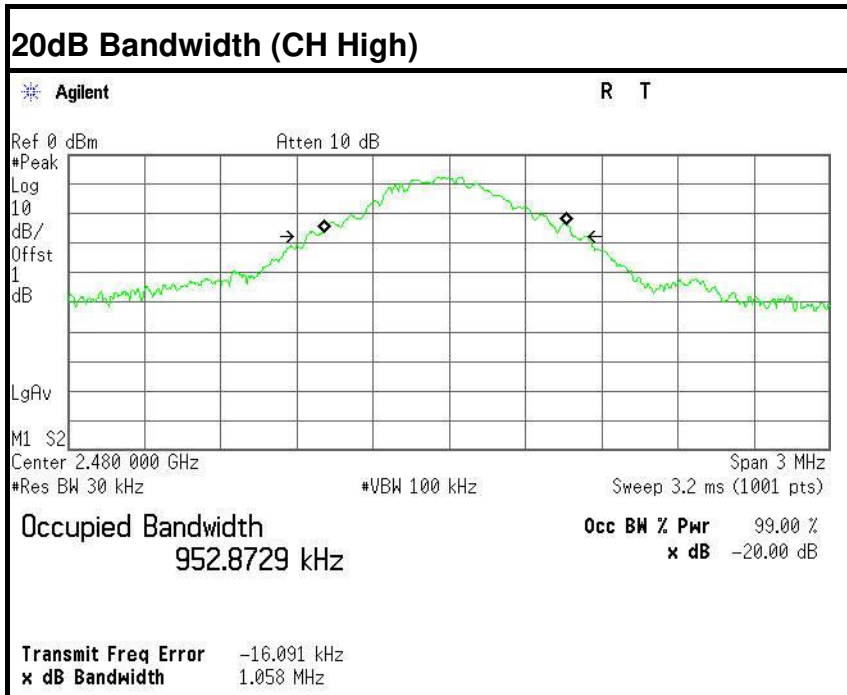



Test plot

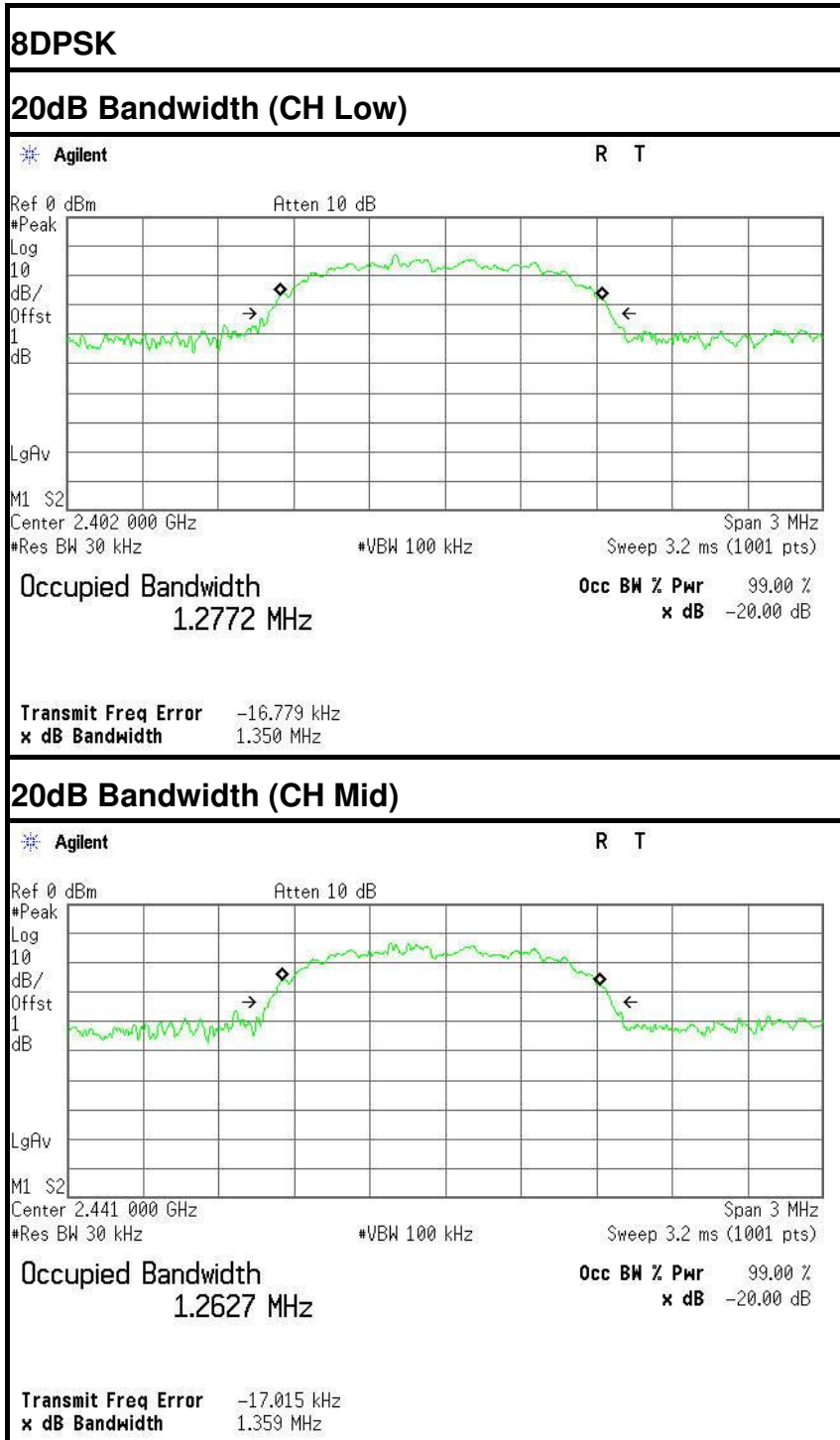

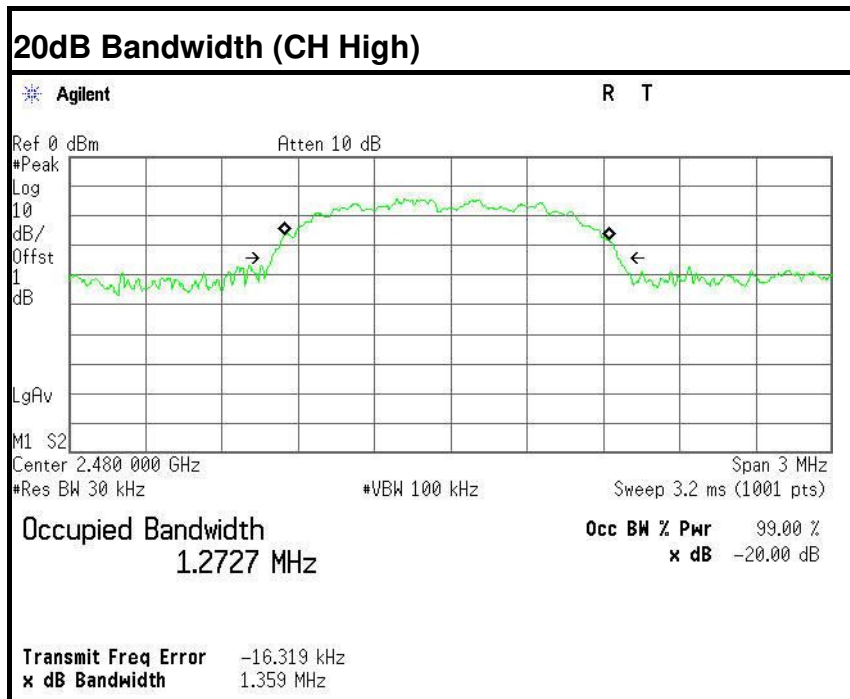



6.2 ANTENNA GAIN

MEASUREMENT

The antenna gain of the complete system is calculated by the difference of radiated power in EIRP and the conducted power of the module. For normal BT devices, the GFSK mode is used.

MEASUREMENT PARAMETERS

| Measurement parameter | |
|-----------------------|----------|
| Detector | Peak |
| Sweep time | Auto |
| Resolution bandwidth | 3 MHz |
| Video bandwidth | 3 MHz |
| Trace-Mode | Max hold |

LIMITS

| FCC | IC |
|--------------|----|
| Antenna Gain | |
| 6 dBi | |

TEST RESULTS

GFSK

| T _{nom} | V _{nom} | Lowest channel 2402MHz | Middle channel 2441MHz | Highest channel 2480MHz |
|---|------------------|----------------------------------|---------------------------|----------------------------|
| Conducted power [dBm] Measured with GFSK modulation | | -4.49 | -4.29 | -4.38 |
| Radiated power [dBm] Measured with GFSK modulation | | -19.63 | -19.68 | -19.75 |
| Gain [dBi] Calculated | | -15.14 | -15.39 | -15.37 |
| Measurement uncertainty | | ± 1.5 dB (cond.) / ± 3 dB (rad.) | | |

8DPSK

| T _{nom} | V _{nom} | Lowest channel 2402MHz | Middle channel 2441MHz | Highest channel 2480MHz |
|--|------------------|----------------------------------|---------------------------|----------------------------|
| Conducted power [dBm] Measured with 8DPSK modulation | | -5.78 | -5.94 | -5.64 |
| Radiated power [dBm] Measured with 8DPSK modulation | | -19.62 | -19.84 | -19.97 |
| Gain [dBi] Calculated | | -13.84 | -13.90 | -14.33 |
| Measurement uncertainty | | ± 1.5 dB (cond.) / ± 3 dB (rad.) | | |



6.3 PEAK POWER

LIMIT

The maximum peak output power of the intentional radiator shall not exceed the following:

1. For frequency hopping systems operating in the 2400-2483.5 MHz band employing at least 75 non-overlapping hopping channels: 1 watt. For all other frequency hopping systems in the 2400-2483.5 MHz band: 0.125 watts.
2. Except as shown in paragraphs (b)(3) (i), (ii) and (iii) of this section, if transmitting antennas of directional gain greater than 6dBi are used the peak output power from the intentional radiator shall be reduced below the stated values in paragraphs (b)(1) or (b)(2) of this section, as appropriate, by the amount in dB that the directional gain of the antenna exceeds 6dBi.
3. The conducted output power limit specified in paragraph (b) of this section is based on the use of antennas with directional gains that do not exceed 6 dBi. Except as shown in paragraph (c) of this section, if transmitting antennas of directional gain greater than 6 dBi are used, the conducted output power from the intentional radiator shall be reduced below the stated values in paragraphs (b)(1), (b)(2), and (b)(3) of this section, as appropriate, by the amount in dB that the directional gain of the antenna exceeds 6 dBi.

MEASUREMENT EQUIPMENT USED

| Name of Equipment | Manufacturer | Model | Serial Number | Last Calibration | Due Calibration |
|-------------------|--------------|---------|---------------|------------------|-----------------|
| Power Meter | Anritsu | ML2495A | 1204003 | 02/21/2016 | 02/20/2017 |
| Power Sensor | Anritsu | MA2411B | 1126150 | 02/21/2016 | 02/20/2017 |

Remark: Each piece of equipment is scheduled for calibration once a year.

Test Configuration

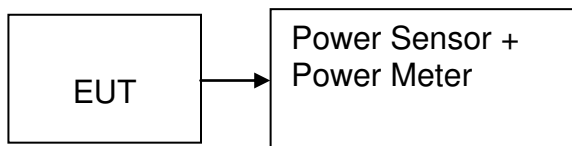

TEST PROCEDURE

The transmitter output is connected to the RF Power Meter. The RF Power Meter is set to the peak power detection.



TEST RESULTS

No non-compliance noted

Test Data

GFSK

| Channel | Frequency (MHz) | Reading Power (dBm) | Cable loss (dB) | Output Power (dBm) | Output Power (W) | Limit (W) | Peak /AVG | Result |
|---------|-----------------|---------------------|-----------------|--------------------|------------------|-----------|-----------|--------|
| Low | 2402 | -7.99 | 3.50 | -4.49 | 0.00036 | 1 | peak | PASS |
| Mid | 2441 | -7.79 | 3.50 | -4.29 | 0.00037 | | | PASS |
| High | 2480 | -7.88 | 3.50 | -4.38 | 0.00036 | | | PASS |
| Low | 2402 | -8.39 | 3.50 | -4.89 | 0.00032 | 1 | AVG | PASS |
| Mid | 2441 | -8.28 | 3.50 | -4.78 | 0.00033 | | | PASS |
| High | 2480 | -8.30 | 3.50 | -4.80 | 0.00033 | | | PASS |

$\pi/4$ -DQPSK

| Channel | Frequency (MHz) | Reading Power (dBm) | Cable loss (dB) | Output Power (dBm) | Output Power (W) | Limit (W) | Peak /AVG | Result |
|---------|-----------------|---------------------|-----------------|--------------------|------------------|-----------|-----------|--------|
| Low | 2402 | -9.37 | 3.50 | -5.87 | 0.00026 | 1 | peak | PASS |
| Mid | 2441 | -9.52 | 3.50 | -6.02 | 0.00025 | | | PASS |
| High | 2480 | -9.33 | 3.50 | -5.83 | 0.00026 | | | PASS |
| Low | 2402 | -12.12 | 3.50 | -8.62 | 0.00014 | 1 | AVG | PASS |
| Mid | 2441 | -11.97 | 3.50 | -8.47 | 0.00014 | | | PASS |
| High | 2480 | -12.12 | 3.50 | -8.62 | 0.00014 | | | PASS |

8DPSK

| Channel | Frequency (MHz) | Reading Power (dBm) | Cable loss (dB) | Output Power (dBm) | Output Power (W) | Limit (W) | Peak /AVG | Result |
|---------|-----------------|---------------------|-----------------|--------------------|------------------|-----------|-----------|--------|
| Low | 2402 | -9.28 | 3.50 | -5.78 | 0.00026 | 1 | peak | PASS |
| Mid | 2441 | -9.44 | 3.50 | -5.94 | 0.00025 | | | PASS |
| High | 2480 | -9.14 | 3.50 | -5.64 | 0.00027 | | | PASS |
| Low | 2402 | -12.05 | 3.50 | -8.55 | 0.00014 | 1 | AVG | PASS |
| Mid | 2441 | -11.95 | 3.50 | -8.45 | 0.00014 | | | PASS |
| High | 2480 | -12.05 | 3.50 | -8.55 | 0.00014 | | | PASS |



6.4 PEAK POWER SPECTRAL DENSITY

LIMIT

1. For direct sequence systems, the peak power spectral density conducted from the intentional radiator to the antenna shall not be greater than 8dBm in any 3kHz band during any time interval of continuous transmission.
2. The direct sequence operating of the hybrid system, with the frequency hopping operation turned off, shall comply with the power density requirements of paragraph (d) of this section.

MEASUREMENT EQUIPMENT USED

| Name of Equipment | Manufacturer | Model | Serial Number | Last Calibration | Due Calibration |
|-------------------|--------------|--------|---------------|------------------|-----------------|
| Spectrum Analyzer | Agilent | E4446A | US44300399 | 02/21/2016 | 02/20/2017 |

Remark: Each piece of equipment is scheduled for calibration once a year.

Test Configuration

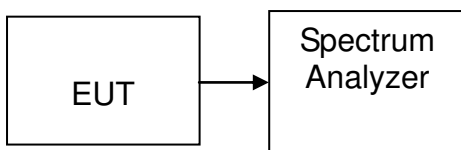

TEST PROCEDURE

1. Set analyzer center frequency to DTS channel center frequency.
2. Set the span to 1.5 times the DTS bandwidth.
3. Set the RBW to: $3\text{ kHz} \leq \text{RBW} \leq 100\text{ kHz}$.
4. Set the VBW $\geq 3 \times \text{RBW}$.
5. Detector = peak.
6. Sweep time = auto couple.
7. Trace mode = max hold.
8. Allow trace to fully stabilize.
9. Use the peak marker function to determine the maximum amplitude level within the RBW.
10. If measured value exceeds limit, reduce RBW (no less than 3 kHz) and repeat.

TEST RESULTS

Not applicable. Since EUT is the Bluetooth device.



6.5 BAND EDGES MEASUREMENT

LIMIT

According to §15.247(c), in any 100 kHz bandwidth outside the frequency bands in which the spread spectrum intentional radiator is operating, the radio frequency power that is produced by the intentional radiator shall be at least 20dB below that in the 100kHz bandwidth within the band that contains the highest level of the desired power. In addition, radiated emissions which fall in the restricted bands, as defined in §15.205(a), must also comply with the radiated emission limits specified in 15.209(a).

MEASUREMENT EQUIPMENT USED

| Radiated Emission Test Site 966(2) | | | | | |
|------------------------------------|----------------|--------------------|---------------|------------------|-----------------|
| Name of Equipment | Manufacturer | Model Number | Serial Number | Last Calibration | Due Calibration |
| EMI TEST RECEIVER | Agilent | N9038A | US44300399 | 02/21/2016 | 02/20/2017 |
| EMI TEST RECEIVER | ROHDE&SCHWARZ | ESCI | 100783 | 02/21/2016 | 02/20/2017 |
| Amplifier | MITEQ | AM-1604-3000 | 1123808 | 02/21/2016 | 02/20/2017 |
| High Noise Amplifier | Agilent | 8449B | 3008A01838 | 02/21/2016 | 02/20/2017 |
| Board-Band Horn Antenna | Schwarzbeck | BBHA 9170 | 9170-497 | 02/21/2016 | 02/20/2017 |
| Bilog Antenna | SCHAFFNER | CBL6143 | 5082 | 02/21/2016 | 02/20/2017 |
| Horn Antenna | SCHWARZBECK | BBHA9120 | D286 | 02/21/2016 | 02/20/2017 |
| Loop Antenna | A. R. A | PLA-1030/B | 1029 | 02/21/2016 | 02/20/2017 |
| Turn Table | N/A | N/A | N/A | N.C.R | N.C.R |
| Controller | Sunol Sciences | SC104V | 022310-1 | N.C.R | N.C.R |
| Controller | CT | N/A | N/A | N.C.R | N.C.R |
| Temp. / Humidity Meter | Anymetre | JR913 | N/A | 02/21/2016 | 02/20/2017 |
| Antenna Tower | SUNOL | TLT2 | N/A | N.C.R | N.C.R |
| Test S/W | FARAD | LZ-RF / CCS-SZ-3A2 | | | |

Test Configuration

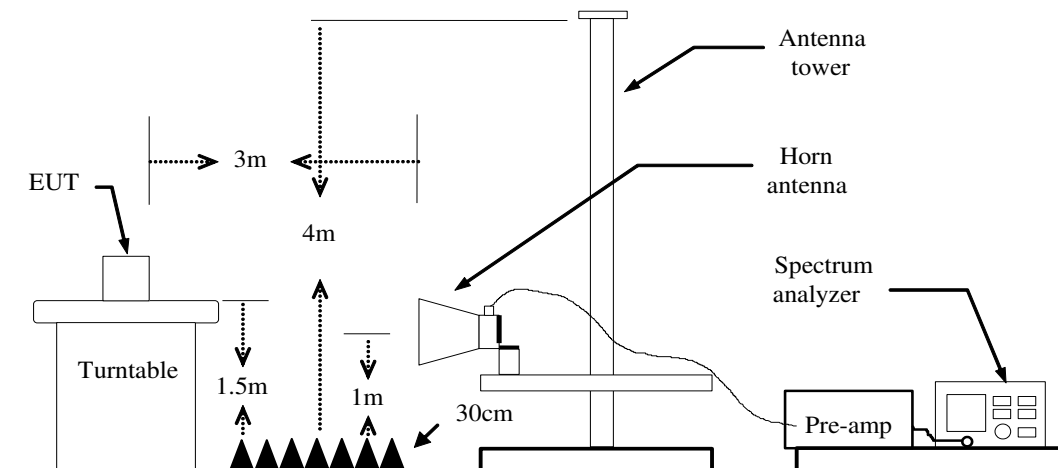



TEST PROCEDURE

1. The EUT is placed on a turntable, which is 1.5m above the ground plane.
2. The turntable shall be rotated for 360 degrees to determine the position of maximum emission level.
3. EUT is set 3m away from the receiving antenna, which is varied from 1m to 4m to find out the highest emission.
4. Set the spectrum analyzer in the following setting in order to capture the lower and upper band-edges of the emission:
 - (a) PEAK: RBW=VBW=1MHz / Sweep=AUTO
 - (b) AVERAGE: RBW=1MHz / VBW=330Hz / Sweep=AUTO
5. Repeat the procedures until all the PEAK and AVERAGE versus POLARIZATION are measured.

TEST RESULTS

Refer to attach spectrum analyzer data chart.



Test Data (GFSK)

Band Edges (CH-Low)

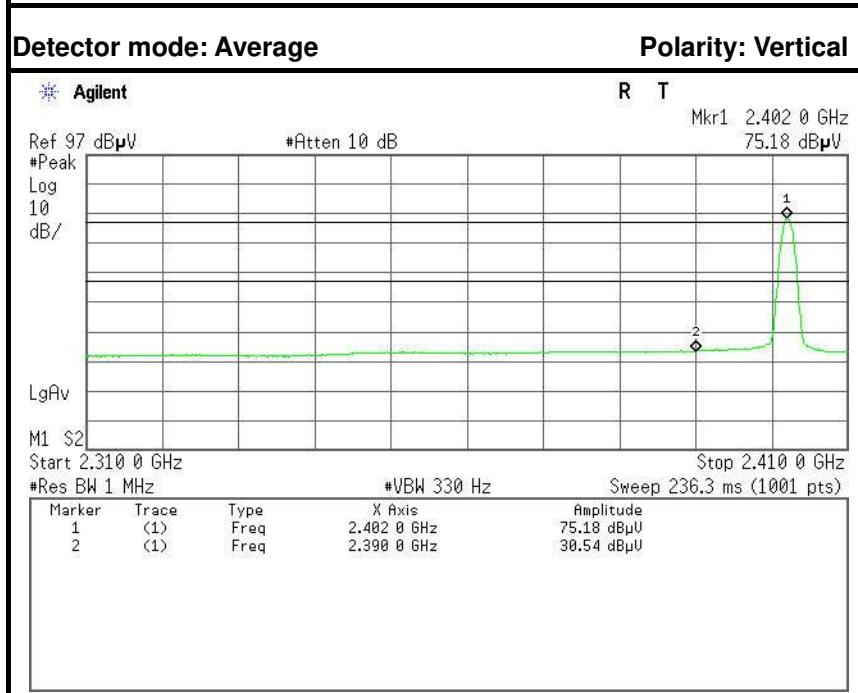
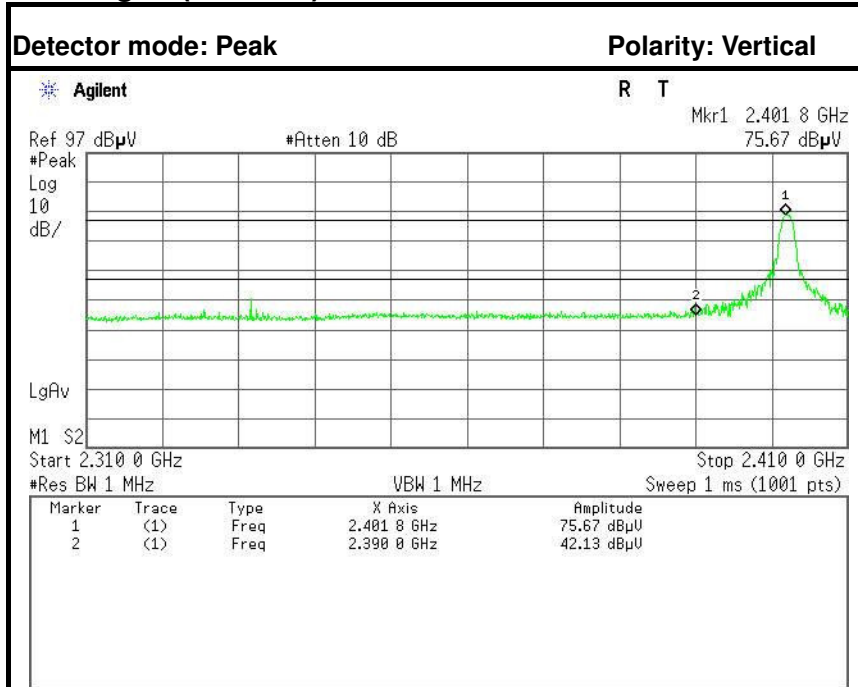

| No. | Frequency (MHz) | Reading (dBuV) | Corrected (dB) | Result (dBuV) | Limit (dBuV) | Margin (dB) | Detector | Antenna Pole |
|-----|-----------------|----------------|----------------|---------------|--------------|-------------|----------|--------------|
| 1 | 2390.0000 | 35.53 | -6.60 | 42.13 | 74.00 | -31.87 | Peak | Vertical |
| 2 | 2390.0000 | 23.94 | -6.60 | 30.54 | 54.00 | -23.46 | Average | Vertical |

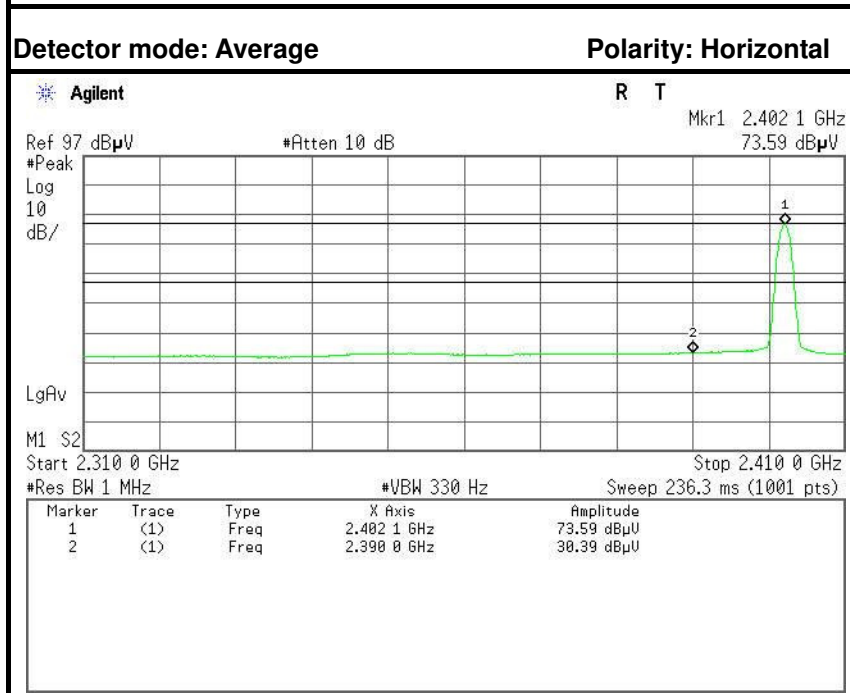
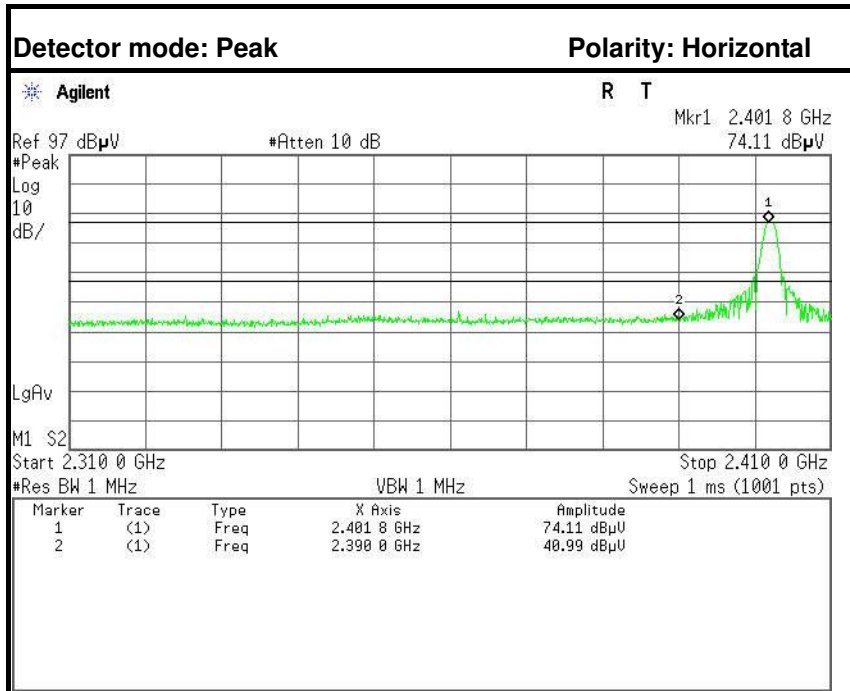

| No. | Frequency (MHz) | Reading (dBuV) | Corrected (dB) | Result (dBuV) | Limit (dBuV) | Margin (dB) | Detector | Antenna Pole |
|-----|-----------------|----------------|----------------|---------------|--------------|-------------|----------|--------------|
| 1 | 2390.0000 | 34.39 | -6.60 | 40.99 | 74.00 | -33.01 | Peak | Horizontal |
| 2 | 2390.0000 | 23.79 | -6.60 | 30.39 | 54.00 | -23.61 | Average | Horizontal |



Band Edges (CH-High)

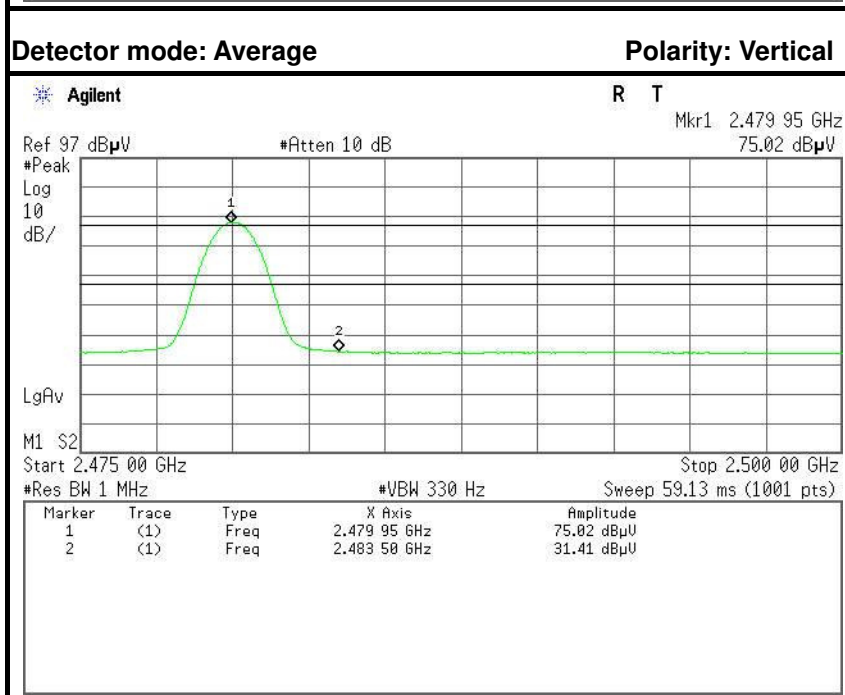
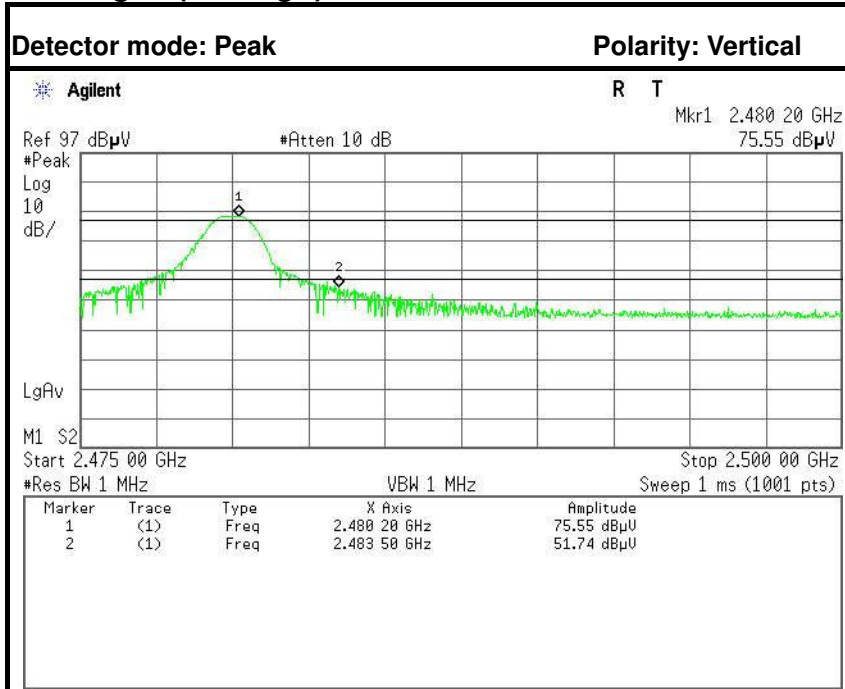

| No. | Frequency (MHz) | Reading (dBµV) | Corrected (dB) | Result (dBµV) | Limit (dBµV) | Margin (dB) | Detector | Antenna Pole |
|-----|-----------------|----------------|----------------|---------------|--------------|-------------|----------|--------------|
| 1 | 2483.5000 | 45.50 | -6.24 | 51.74 | 74.00 | -22.26 | Peak | Vertical |
| 2 | 2483.5000 | 25.17 | -6.24 | 31.41 | 54.00 | -22.59 | Average | Vertical |

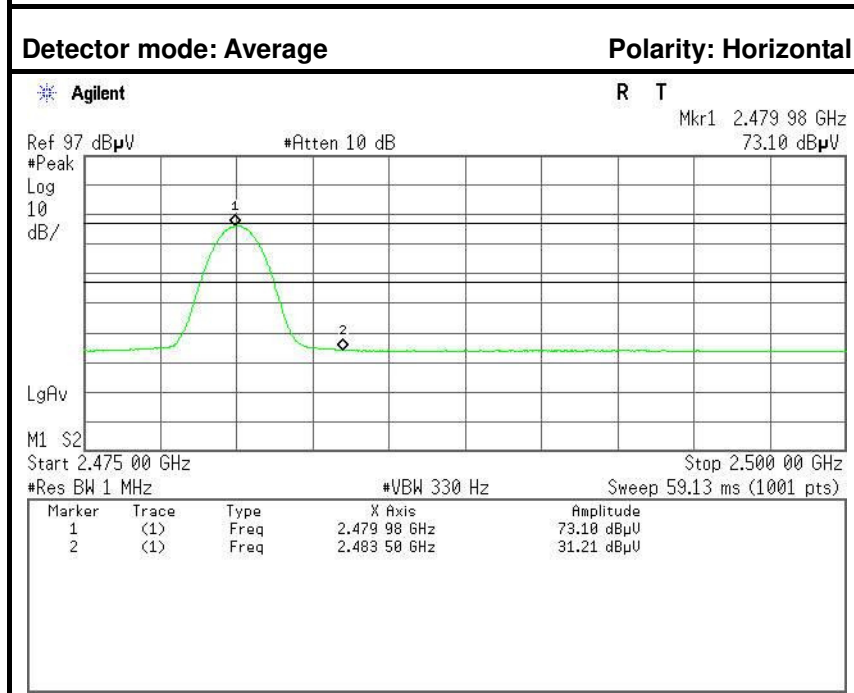
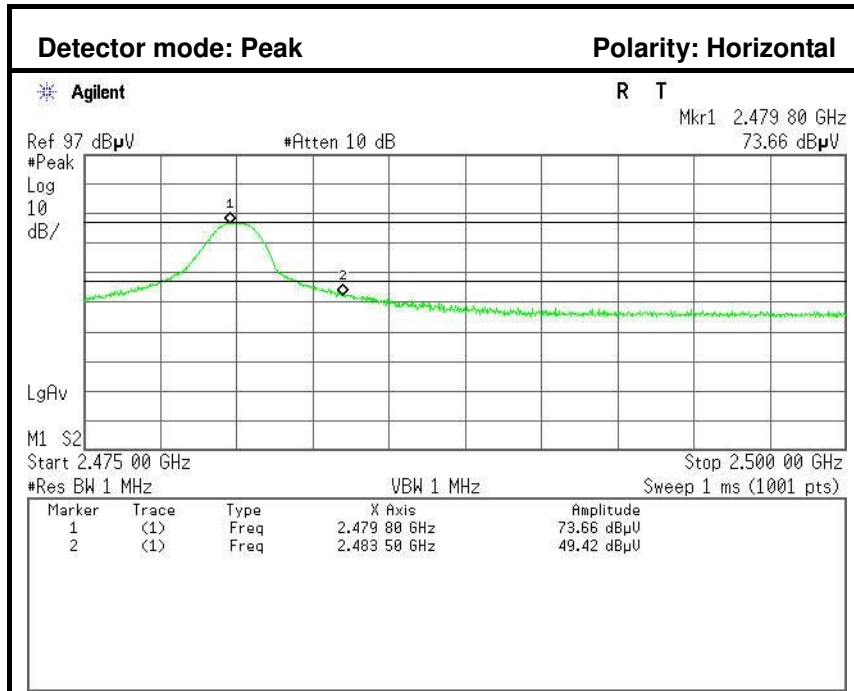

| No. | Frequency (MHz) | Reading (dBuV) | Corrected (dB) | Result (dBuV) | Limit (dBuV) | Margin (dB) | Detector | Antenna Pole |
|-----|-----------------|----------------|----------------|---------------|--------------|-------------|----------|--------------|
| 1 | 2483.5000 | 43.18 | -6.24 | 49.42 | 74.00 | -24.58 | Peak | Horizontal |
| 2 | 2483.5000 | 24.97 | -6.24 | 31.21 | 54.00 | -22.79 | Average | Horizontal |



8DPSK

Band Edges (CH-Low)

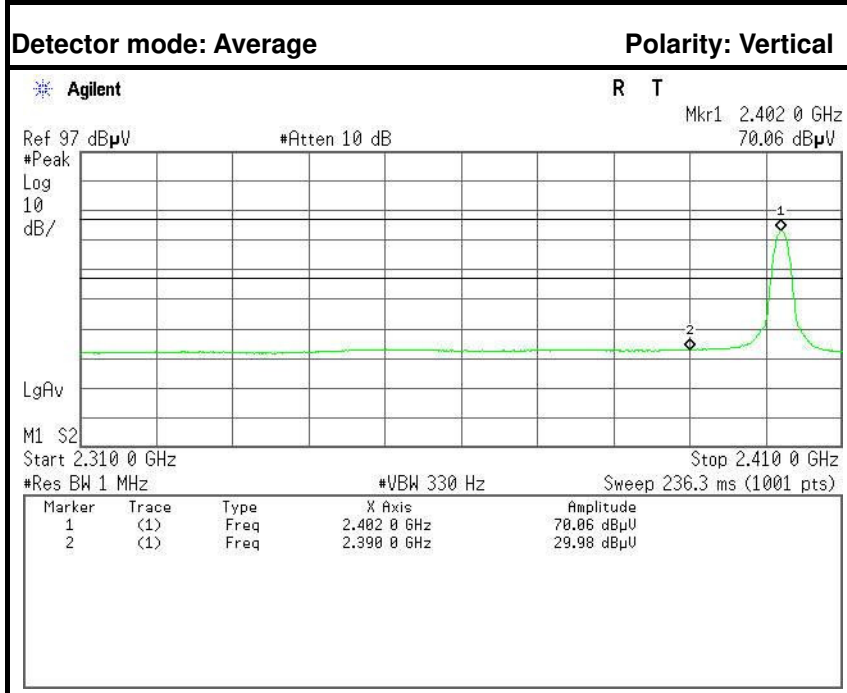
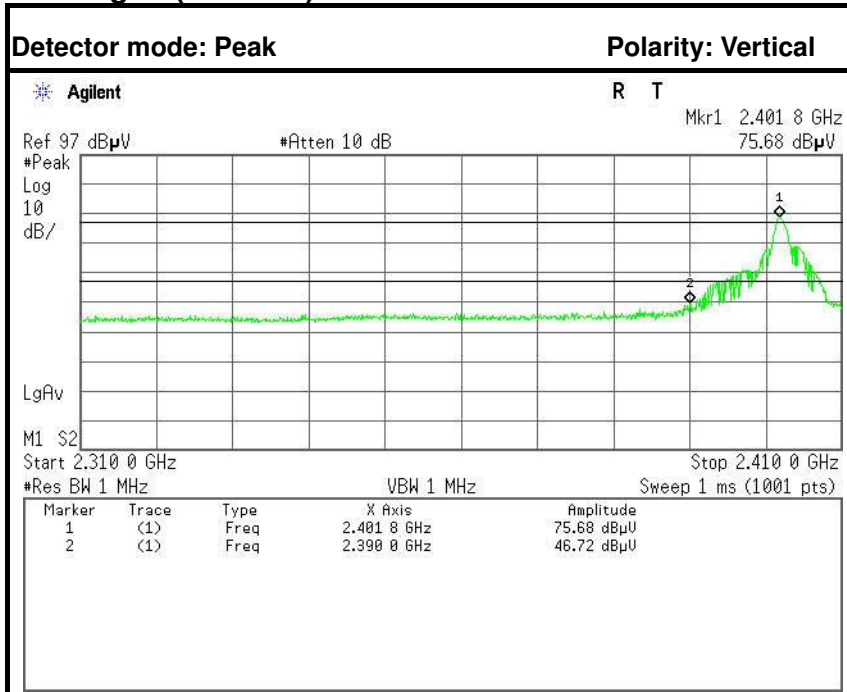

| No. | Frequency (MHz) | Reading (dBuV) | Corrected (dB) | Result (dBuV) | Limit (dBuV) | Margin (dB) | Detector | Antenna Pole |
|-----|-----------------|----------------|----------------|---------------|--------------|-------------|----------|--------------|
| 1 | 2390.0000 | 40.12 | -6.60 | 46.72 | 74.00 | -27.28 | Peak | Vertical |
| 2 | 2390.0000 | 23.38 | -6.60 | 29.98 | 54.00 | -24.02 | Average | Vertical |



Band Edges (CH-Low)

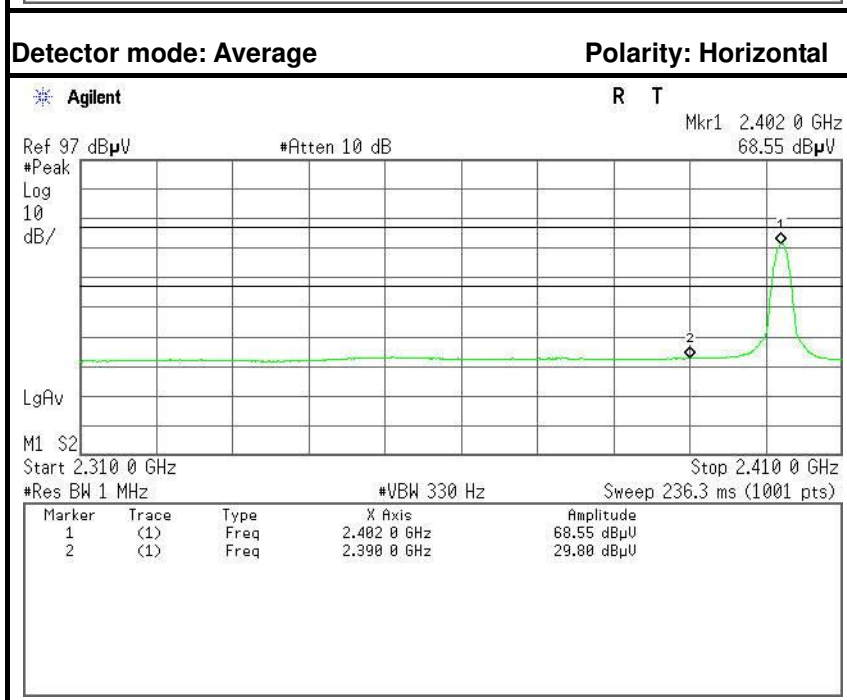
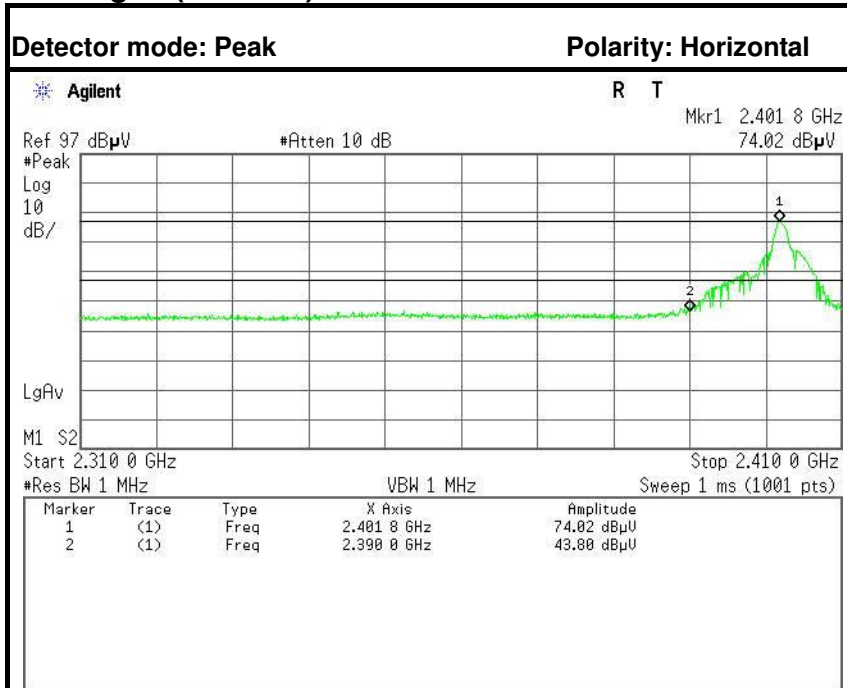

| No. | Frequency (MHz) | Reading (dBuV) | Corrected (dB) | Result (dBuV) | Limit (dBuV) | Margin (dB) | Detector | Antenna Pole |
|-----|-----------------|----------------|----------------|---------------|--------------|-------------|----------|--------------|
| 1 | 2390.0000 | 37.20 | -6.60 | 43.80 | 74.00 | -30.20 | Peak | Horizontal |
| 2 | 2390.0000 | 23.20 | -6.60 | 29.80 | 54.00 | -24.20 | Average | Horizontal |



Band Edges (CH-High)

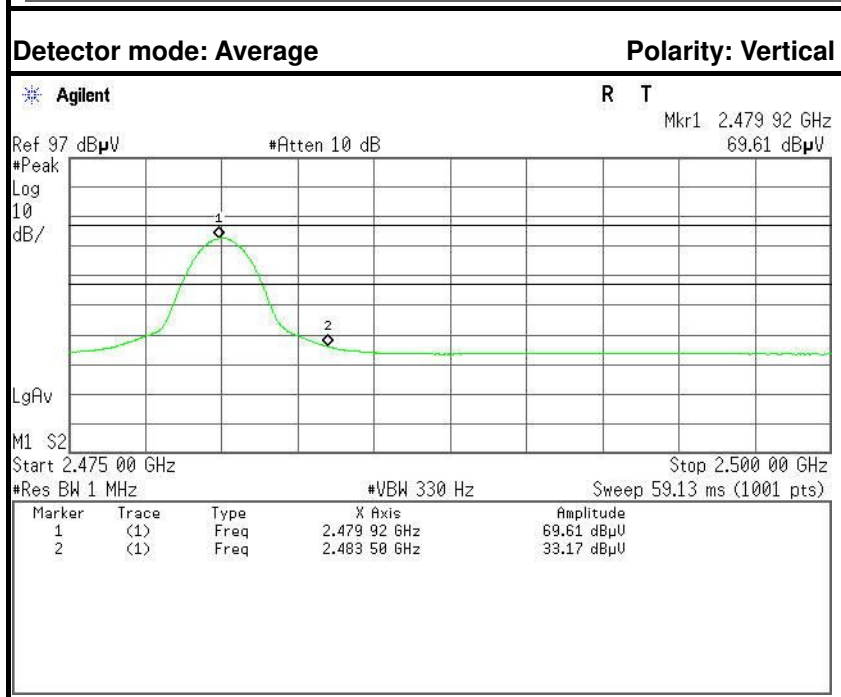
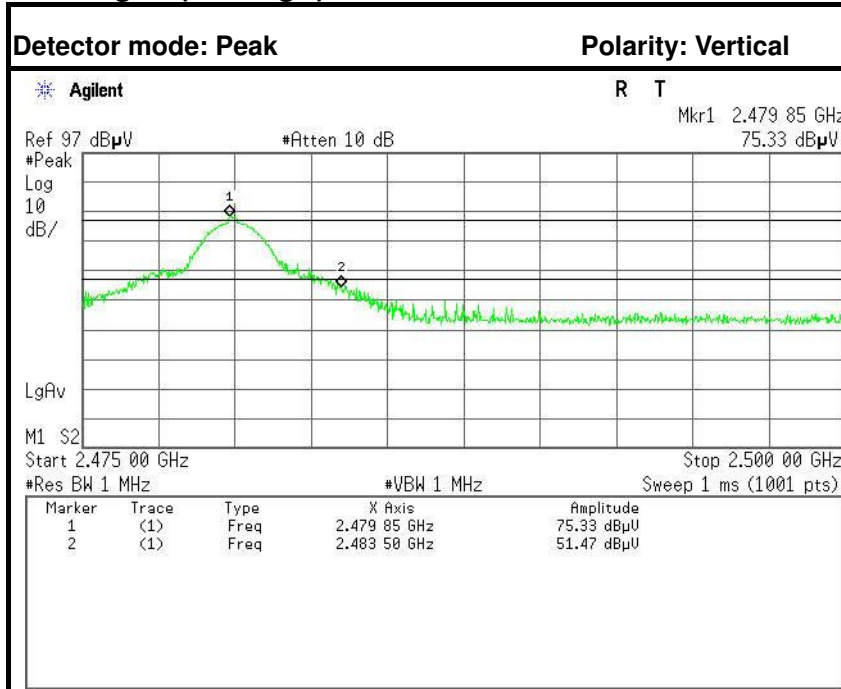

| No. | Frequency (MHz) | Reading (dBuV) | Corrected (dB) | Result (dBuV) | Limit (dBuV) | Margin (dB) | Detector | Antenna Pole |
|-----|-----------------|----------------|----------------|---------------|--------------|-------------|----------|--------------|
| 1 | 2483.5000 | 45.23 | -6.24 | 51.47 | 74.00 | -22.53 | Peak | Vertical |
| 2 | 2483.5000 | 26.93 | -6.24 | 33.17 | 54.00 | -20.83 | Average | Vertical |

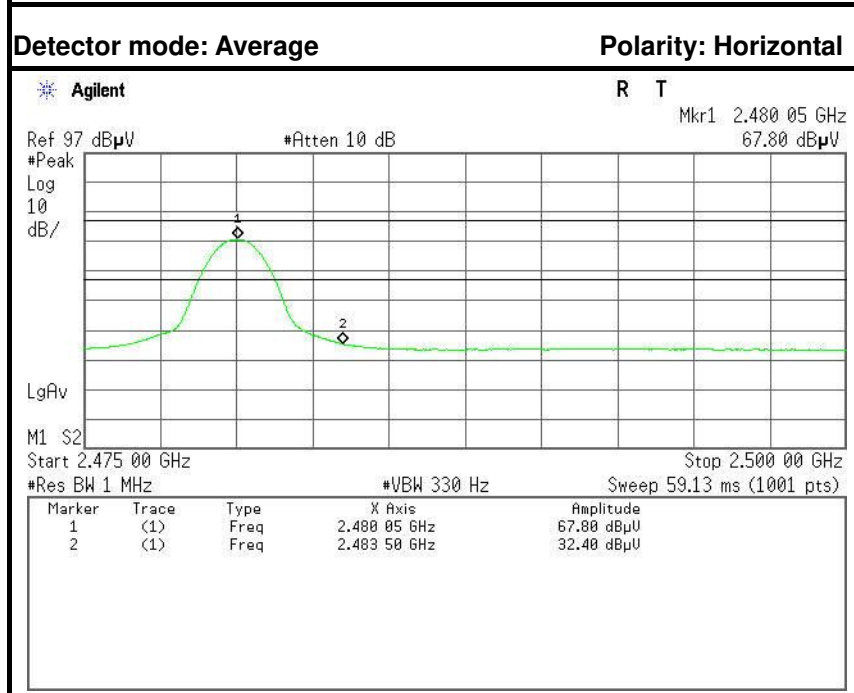
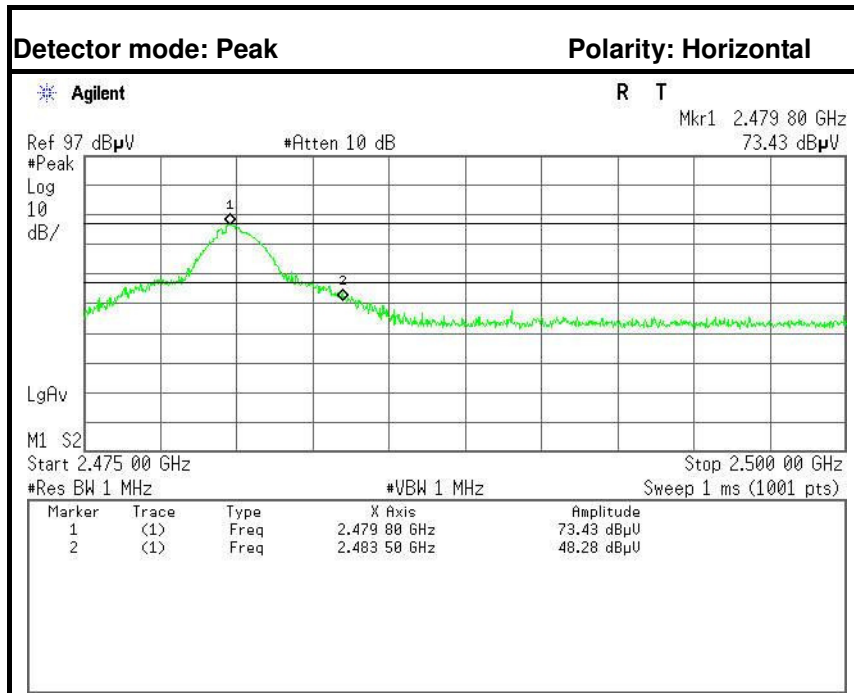

| No. | Frequency (MHz) | Reading (dBuV) | Corrected (dB) | Result (dBuV) | Limit (dBuV) | Margin (dB) | Detector | Antenna Pole |
|-----|-----------------|----------------|----------------|---------------|--------------|-------------|----------|--------------|
| 1 | 2483.5000 | 42.04 | -6.24 | 48.28 | 74.00 | -25.72 | Peak | Horizontal |
| 2 | 2483.5000 | 26.16 | -6.24 | 32.40 | 54.00 | -21.60 | Average | Horizontal |



6.6 FREQUENCY SEPARATION

LIMIT

According to §15.247(a)(1), Frequency hopping systems shall have hopping channel carrier frequencies separated by a minimum of 25 kHz or the 20 dB bandwidth of the hopping channel, whichever is greater. Alternatively, frequency hopping systems operating in the 2400-2483.5 MHz band may have hopping channel carrier frequencies that are separated by 25 kHz or two-thirds of the 20 dB bandwidth of the hopping channel, whichever is greater, provided the systems operate with an output power no greater than 125 mW.

MEASUREMENT EQUIPMENT USED

| Name of Equipment | Manufacturer | Model | Serial Number | Last Calibration | Due Calibration |
|-------------------|--------------|--------|---------------|------------------|-----------------|
| Spectrum Analyzer | Agilent | E4446A | US44300399 | 02/21/2016 | 02/20/2017 |

Remark: Each piece of equipment is scheduled for calibration once a year.

Test Configuration

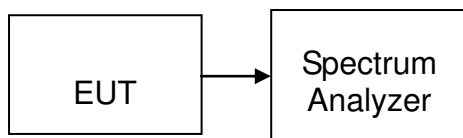

TEST PROCEDURE

1. Place the EUT on the table and set it in transmitting mode.
2. Remove the antenna from the EUT and then connect a low loss RF cable from the antenna port to the spectrum analyzer.
3. Set center frequency of spectrum analyzer = middle of hopping channel.
4. Set the spectrum analyzer as RBW=30kHz, VBW=30kHz, Adjust Span to 4 MHz, Sweep = auto.
5. Max hold. Mark 3 Peaks of hopping channel and record the 3 peaks frequency.

TEST RESULTS

No non-compliance noted

Test Data

GFSK

| Channel Separation (MHz) | Two-thirds of the 20 dB Bandwidth (kHz) | Channel Separation Limit | Result |
|--------------------------|---|-------------------------------------|--------|
| 1.000 | 705.333 | > Two-thirds of the 20 dB Bandwidth | Pass |

8DPSK

| Channel Separation (MHz) | Two-thirds of the 20 dB Bandwidth (kHz) | Channel Separation Limit | Result |
|--------------------------|---|-------------------------------------|--------|
| 1.000 | 906.000 | > Two-thirds of the 20 dB Bandwidth | Pass |



GFSK

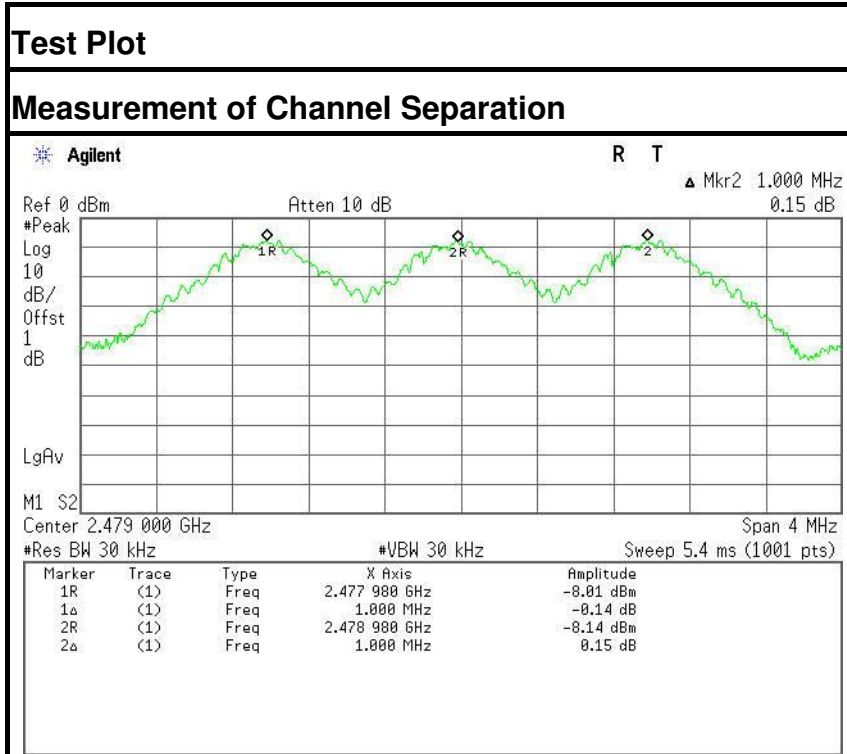

20 dB bandwidth(CH High)

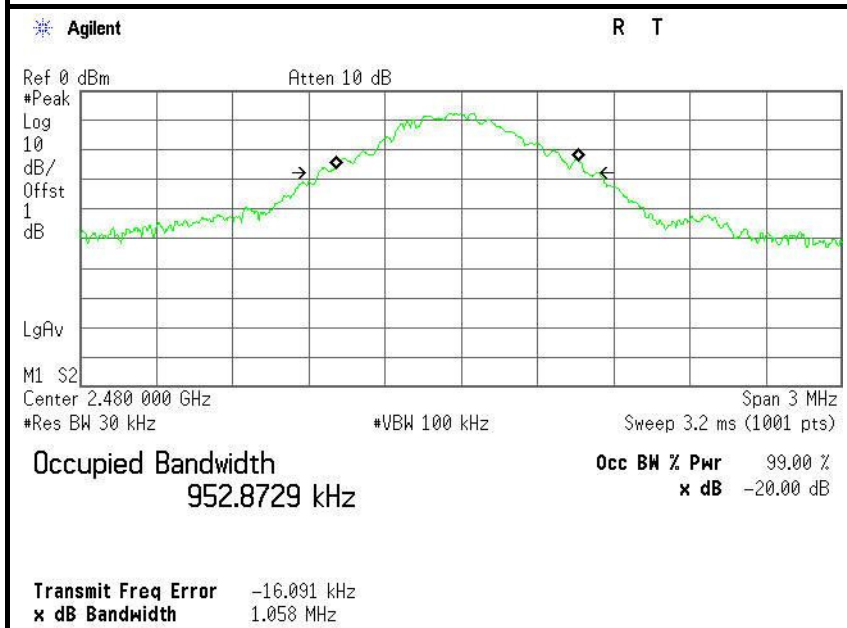



8DPSK

Test Plot

Measurement of Channel Separation

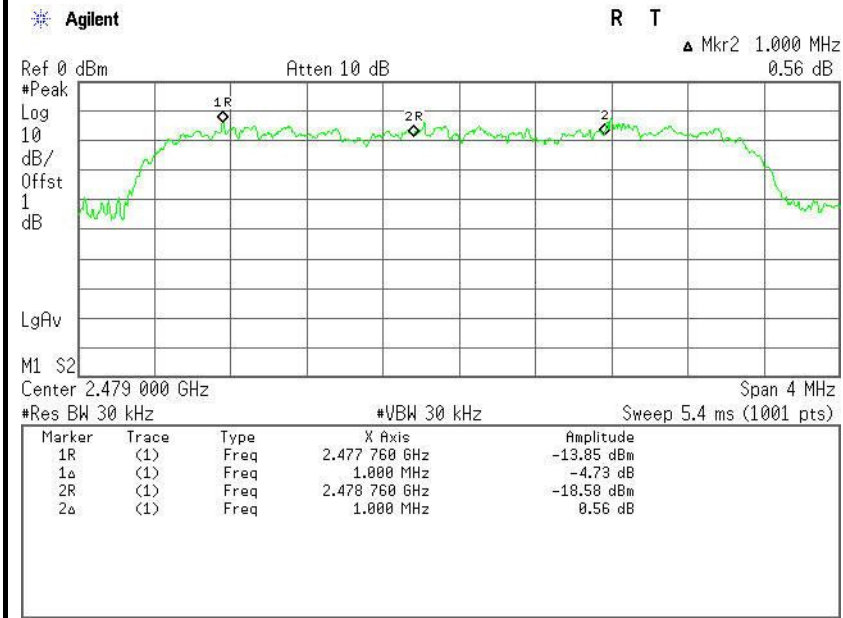

20 dB bandwidth(CH High)

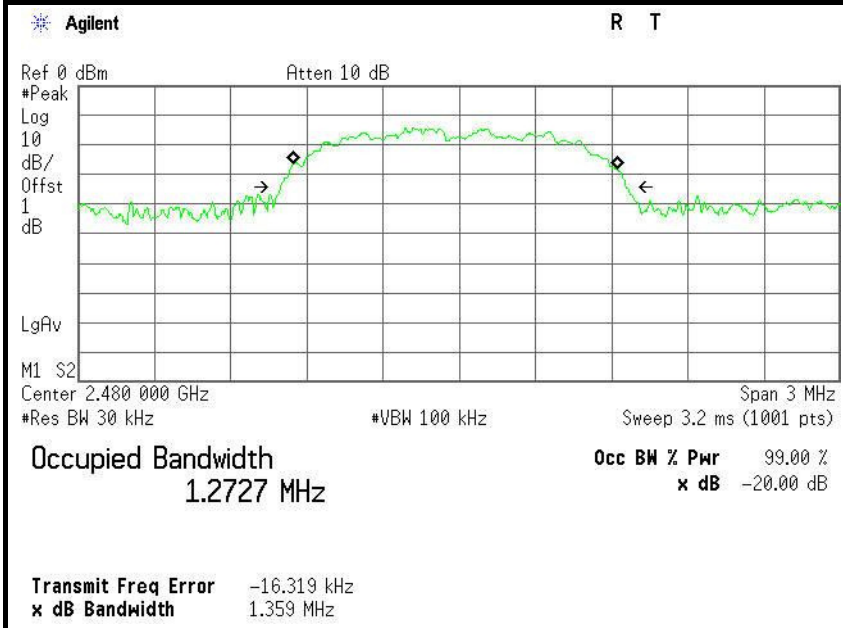



6.7 NUMBER OF HOPPING FREQUENCY

LIMIT

According to §15.247(a)(1)(ii), Frequency hopping systems operating in the 2400MHz-2483.5 MHz bands shall use at least 15 hopping frequencies.

MEASUREMENT EQUIPMENT USED

| Name of Equipment | Manufacturer | Model | Serial Number | Last Calibration | Due Calibration |
|-------------------|--------------|--------|---------------|------------------|-----------------|
| Spectrum Analyzer | Agilent | E4446A | US44300399 | 02/21/2016 | 02/20/2017 |

Remark: Each piece of equipment is scheduled for calibration once a year.

Test Configuration

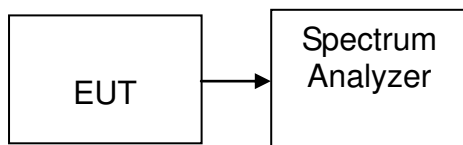

TEST PROCEDURE

1. Place the EUT on the table and set it in transmitting mode.
2. Remove the antenna from the EUT and then connect a low loss RF cable from the antenna port to the spectrum analyzer.
3. Set spectrum analyzer Start=2400MHz, Stop = 2483.5MHz, Sweep = 1ms.
4. Set the spectrum analyzer as RBW, VBW=300kHz,
5. Max hold, view and count how many channel in the band.

TEST RESULTS

No non-compliance noted

Test Data

| Result (No. of CH) | Limit (No. of CH) | Result |
|--------------------|-------------------|--------|
| 79 | >15 | PASS |



Test Plot

Channel Number

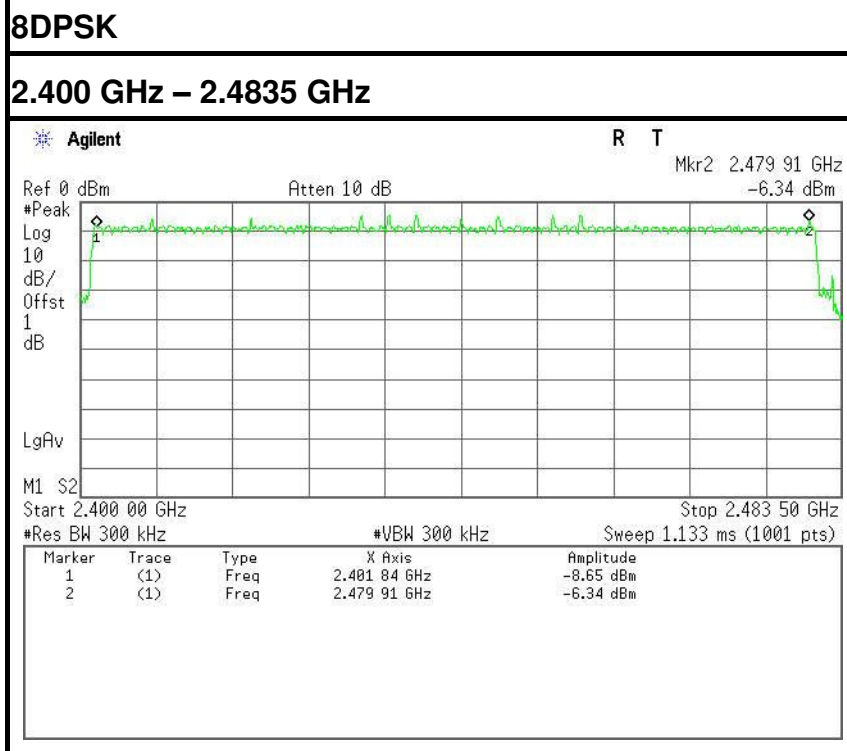
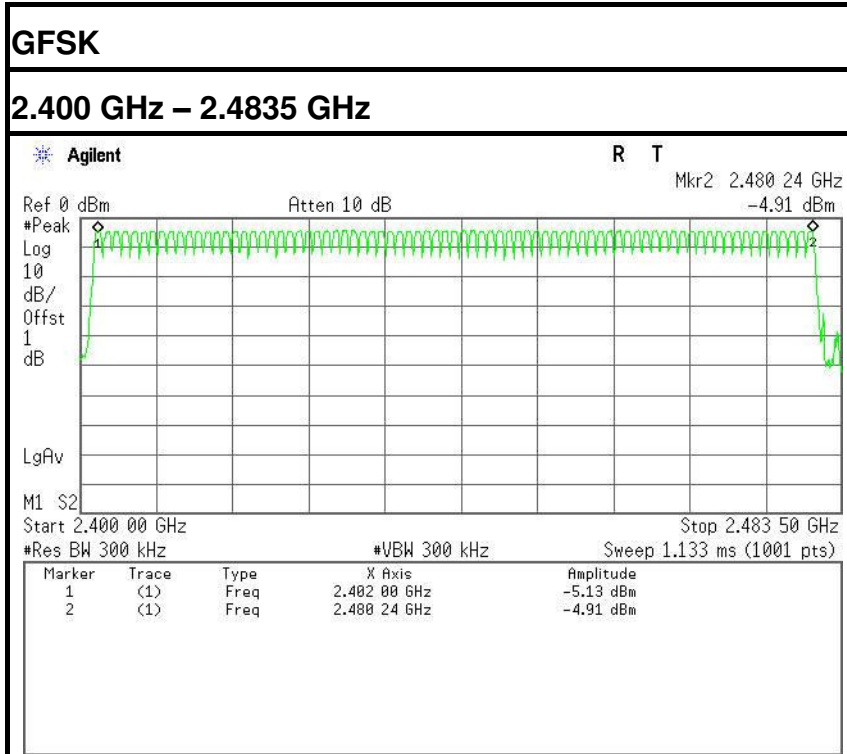



6.8 TIME OF OCCUPANCY (DWELL TIME)

LIMIT

According to §15.247(a)(1)(iii), Frequency hopping systems operating in the 2400MHz-2483.5 MHz bands. The average time of occupancy on any channels shall not greater than 0.4 s within a period 0.4s multiplied by the number of hopping channels employed.

MEASUREMENT EQUIPMENT USED

| Name of Equipment | Manufacturer | Model | Serial Number | Last Calibration | Due Calibration |
|-------------------|--------------|--------|---------------|------------------|-----------------|
| Spectrum Analyzer | Agilent | E4446A | US44300399 | 02/21/2016 | 02/20/2017 |

Remark: Each piece of equipment is scheduled for calibration once a year.

Test Configuration

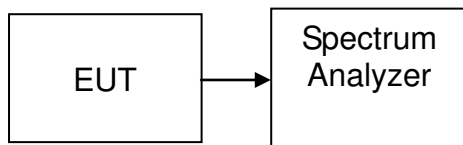

TEST PROCEDURE

1. Place the EUT on the table and set it in transmitting mode.
2. Remove the antenna from the EUT and then connect a low loss RF cable from the antenna port to the spectrum analyzer.
3. Set center frequency of spectrum analyzer = operating frequency.
4. Set the spectrum analyzer as RBW, VBW=1MHz, Span = 0Hz, Sweep = auto.
5. Repeat above procedures until all frequency measured were complete.



TEST RESULTS

No non-compliance noted

Test Data

GFSK

DH 1

CH Mid: $0.398 * (1600/2)/79 * 31.6 = 127.360(\text{ms})$

| CH | Pulse Time (ms) | Total of Dwell (ms) | Period Time (s) | Limit (ms) | Result |
|-----|-----------------|---------------------|-----------------|------------|--------|
| Mid | 0.398 | 127.360 | 31.60 | 400.00 | PASS |

DH 3

CH Mid: $1.647 * (1600/4)/79 * 31.6 = 263.520 (\text{ms})$

| CH | Pulse Time (ms) | Total of Dwell (ms) | Period Time (s) | Limit (ms) | Result |
|-----|-----------------|---------------------|-----------------|------------|--------|
| Mid | 1.647 | 263.520 | 31.60 | 400.00 | PASS |

DH 5

CH Mid: $2.964 * (1600/6)/79 * 31.6 = 316.160(\text{ms})$

| CH | Pulse Time (ms) | Total of Dwell (ms) | Period Time (s) | Limit (ms) | Result |
|-----|-----------------|---------------------|-----------------|------------|--------|
| Mid | 2.964 | 316.160 | 31.60 | 400.00 | PASS |



8DPSK

DH 1

CH Mid: $0.529 * (1600/2)/79 * 31.6 = 169.280$ (ms)

| CH | Pulse Time (ms) | Total of Dwell (ms) | Period Time (s) | Limit (ms) | Result |
|-----|-----------------|---------------------|-----------------|------------|--------|
| Mid | 0.529 | 169.280 | 31.60 | 400.00 | PASS |

DH 3

CH Mid: $1.695 * (1600/4)/79 * 31.6 = 271.200$ (ms)

| CH | Pulse Time (ms) | Total of Dwell (ms) | Period Time (s) | Limit (ms) | Result |
|-----|-----------------|---------------------|-----------------|------------|--------|
| Mid | 1.695 | 271.200 | 31.60 | 400.00 | PASS |

DH 5

CH Mid: $2.996 * (1600/6)/79 * 31.6 = 319.573$ (ms)

| CH | Pulse Time (ms) | Total of Dwell (ms) | Period Time (s) | Limit (ms) | Result |
|-----|-----------------|---------------------|-----------------|------------|--------|
| Mid | 2.996 | 319.573 | 31.60 | 400.00 | PASS |



Test Plot

GFSK

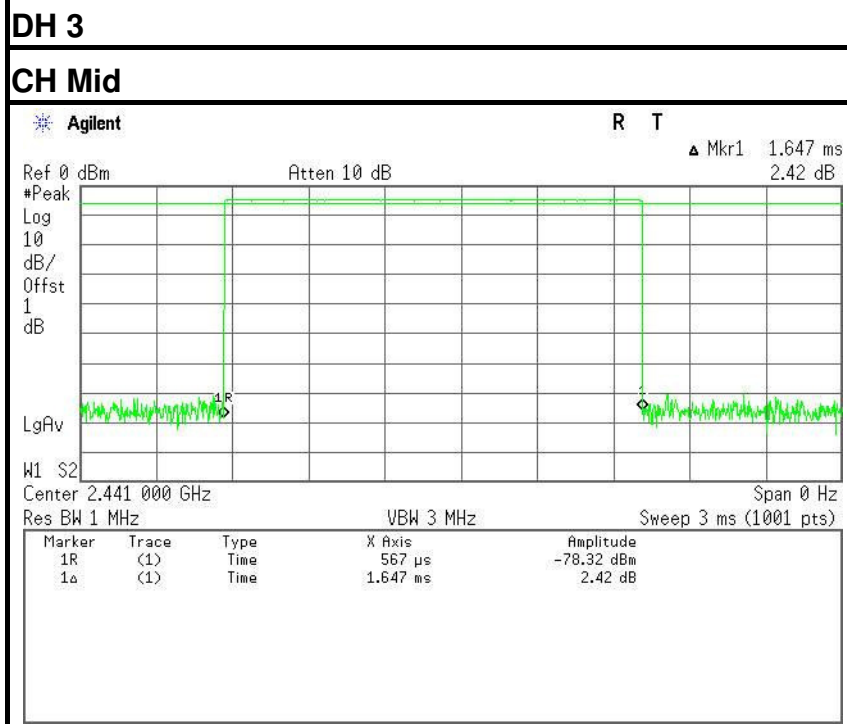
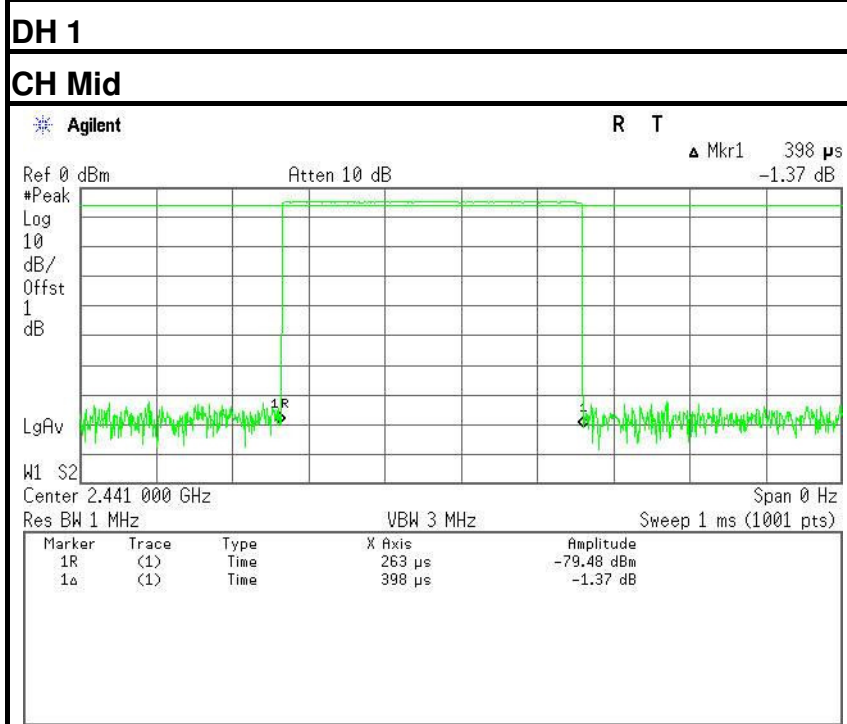

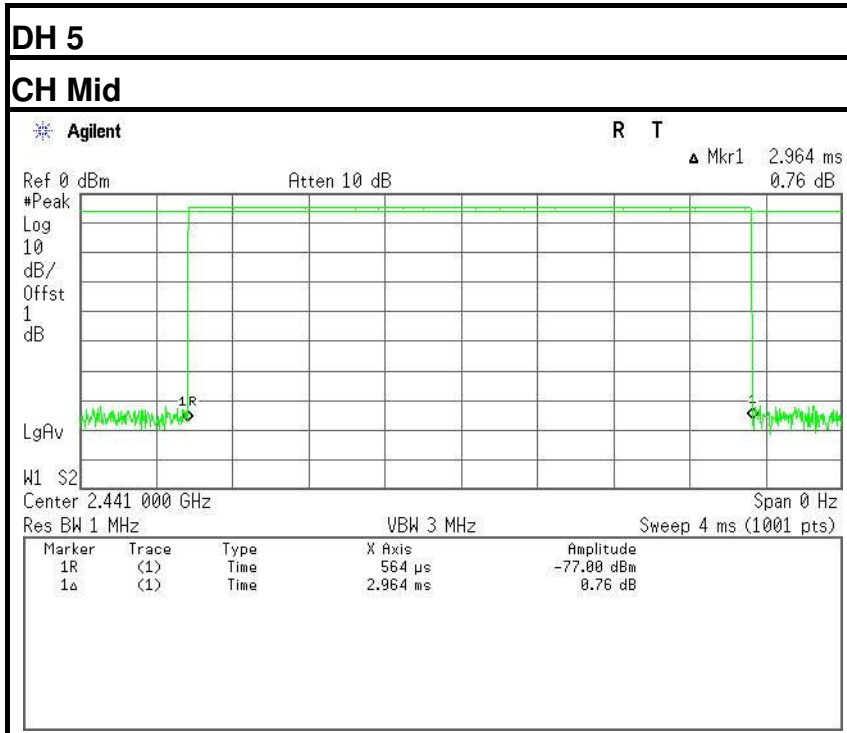



Test Plot

8DPSK

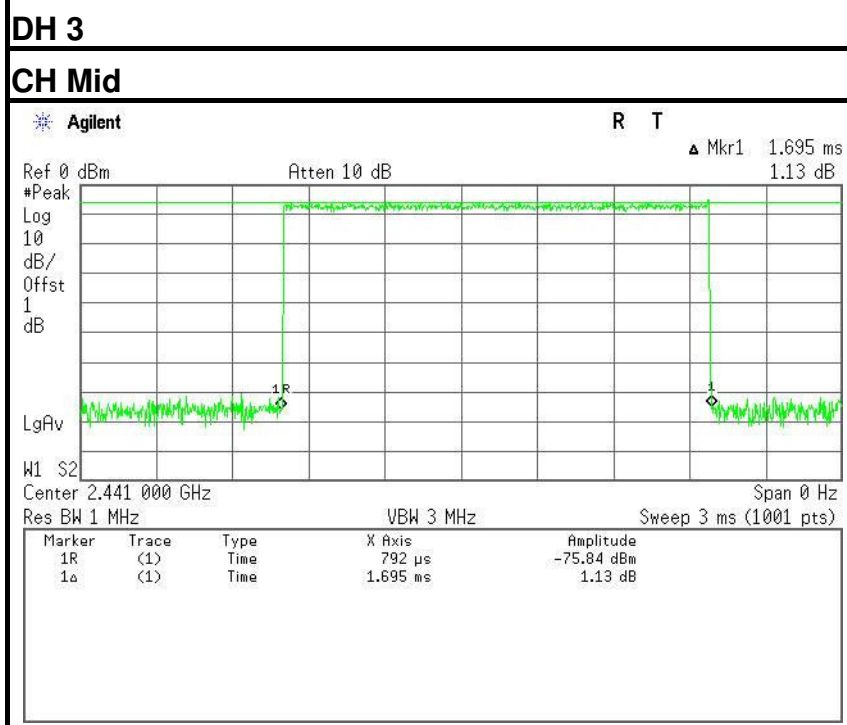
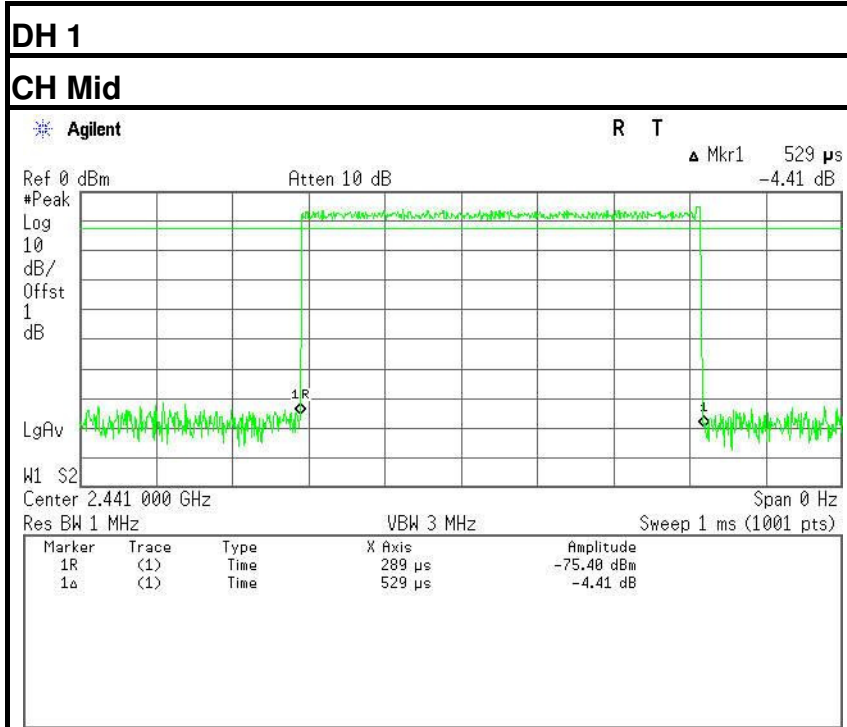

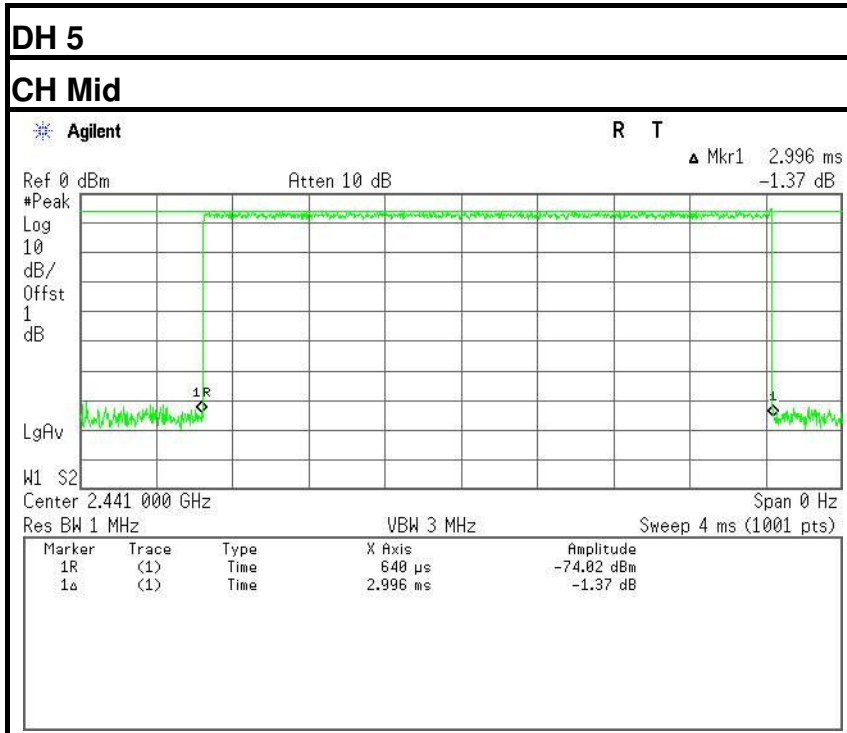



6.9 SPURIOUS EMISSIONS

6.9.1. CONDUCTED MEASUREMENT

LIMIT

In any 100 kHz bandwidth outside the frequency band in which the spread spectrum or digitally modulated intentional radiator is operating, the radio frequency power that is produced by the intentional radiator shall be at least 20 dB below that in the 100 kHz bandwidth within the band that contains the highest level of the desired power, based on either an RF conducted or a radiated measurement. Attenuation below the general limits specified in Section 15.209(a) is not required. In addition, radiated emissions which fall in the restricted bands, as defined in Section 15.205(a), must also comply with the radiated emission limits specified in Section 15.209(a) (see Section 15.205(c)).

MEASUREMENT EQUIPMENT USED

| Name of Equipment | Manufacturer | Model | Serial Number | Last Calibration | Due Calibration |
|-------------------|--------------|--------|---------------|------------------|-----------------|
| Spectrum Analyzer | Agilent | E4446A | US44300399 | 02/21/2016 | 02/20/2017 |

Remark: Each piece of equipment is scheduled for calibration once a year.

Test Configuration

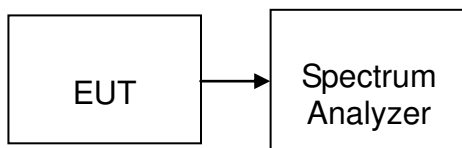

TEST PROCEDURE

Conducted RF measurements of the transmitter output were made to confirm that the EUT antenna port conducted emissions meet the specified limit and to identify any spurious signals that require further investigation or measurements on the radiated emissions site.

The transmitter output is connected to the spectrum analyzer. The resolution bandwidth is set to 100 kHz. The video bandwidth is set to 100 kHz.

Measurements are made over the 10MHz to 26GHz range with the transmitter set to the lowest, middle, and highest channels, and highest channels. No emission found between lowest internal used/generated frequency to 10MHz , it is only recorded 10MHz to 26GHz.

TEST RESULTS

No non-compliance noted

Remark: The hopping on mode and hopping off mode were chosen for pre-test and the hopping off mode was the worse case and print in the report.



Hopping Off

Test Plot (GFSK)

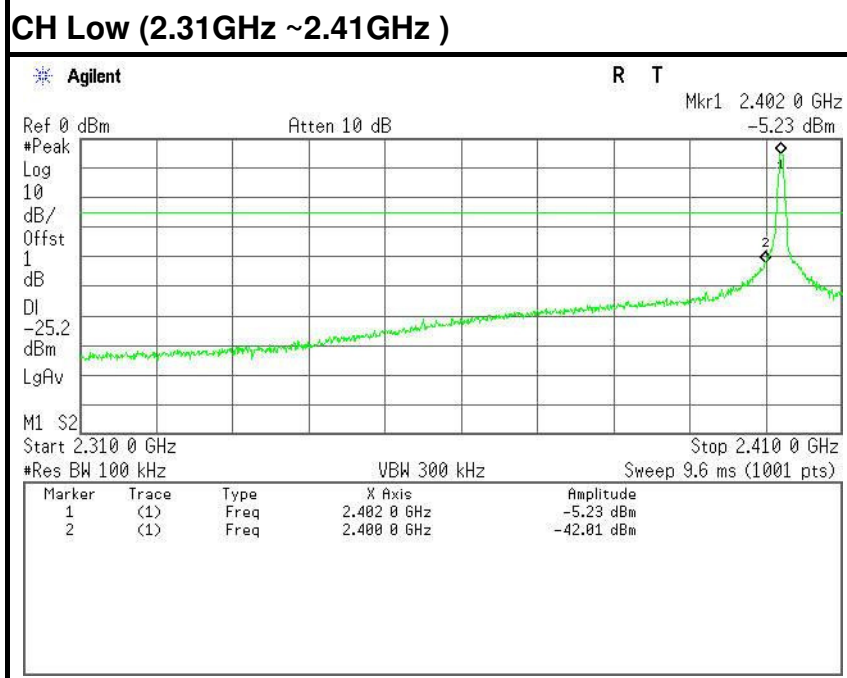
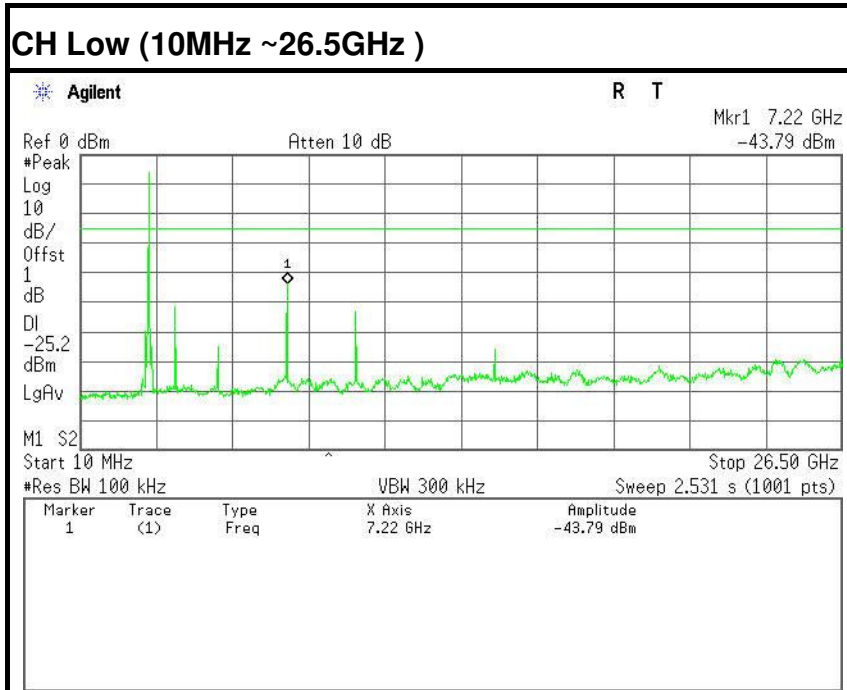

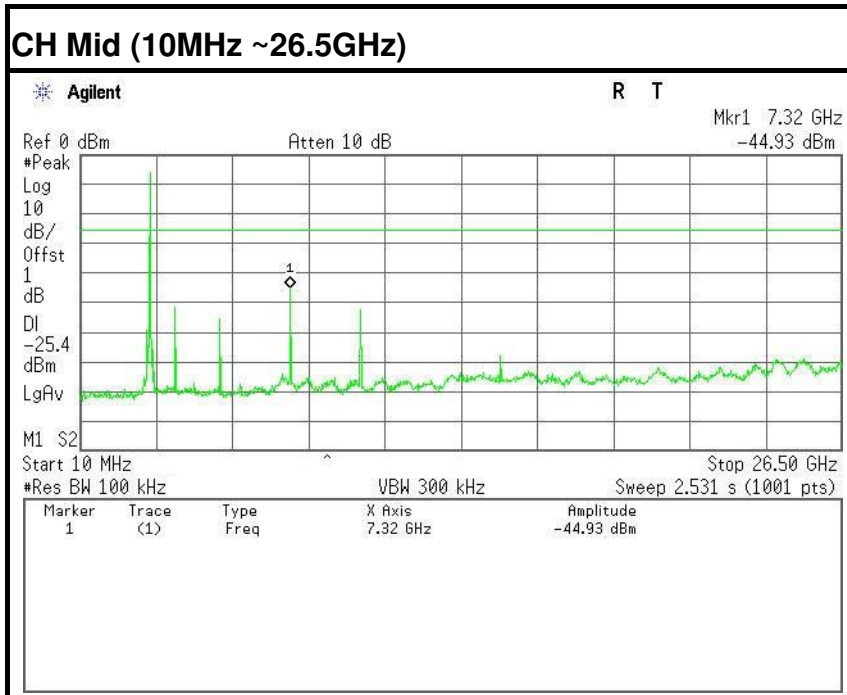



CH High (10MHz ~26.5GHz)

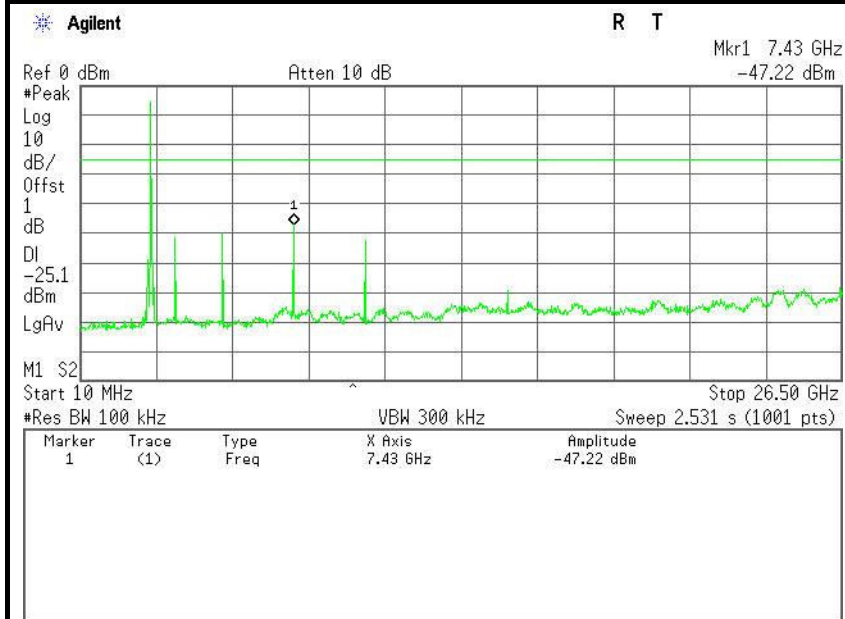

CH High (2.475GHz ~ 2.5GHz)

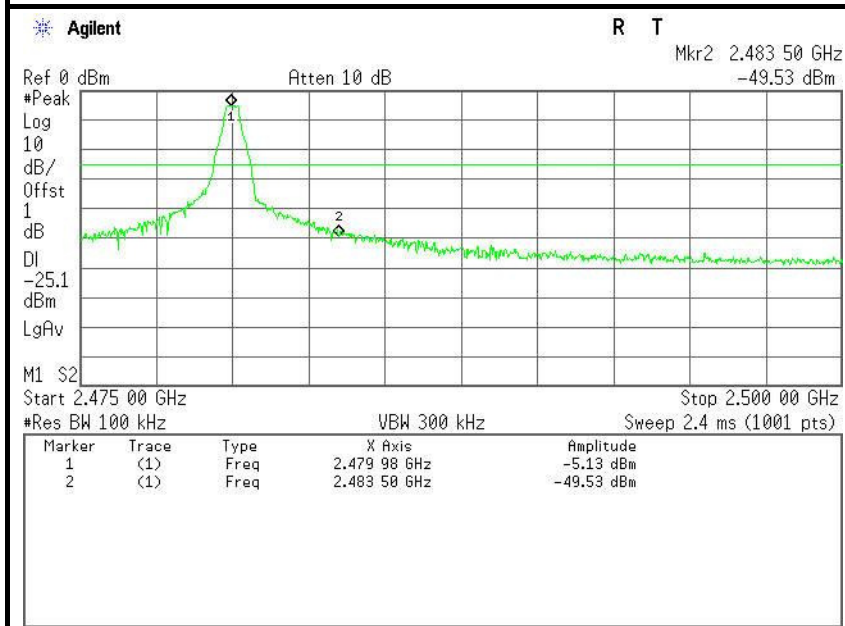



Test Plot (8DPSK)

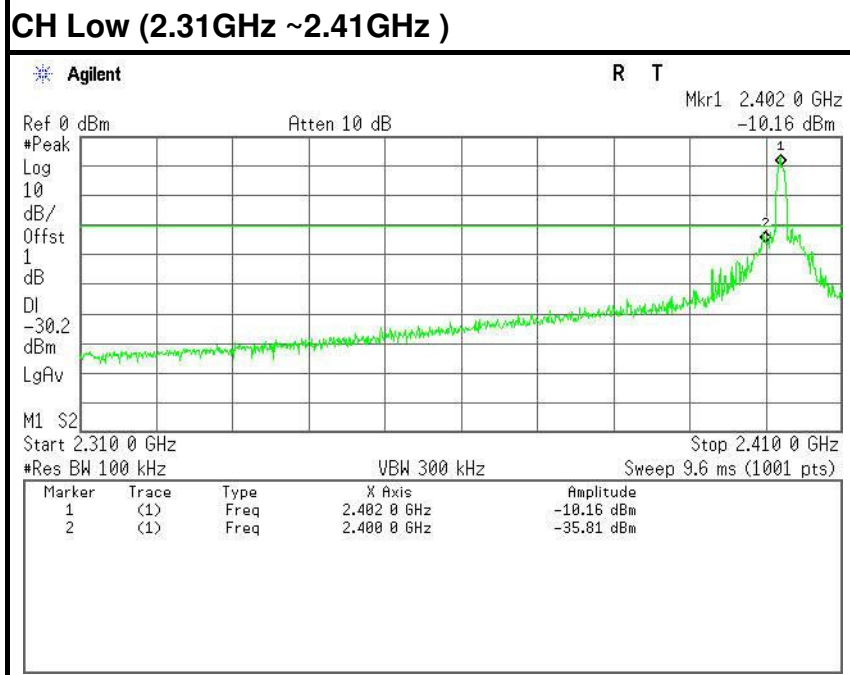
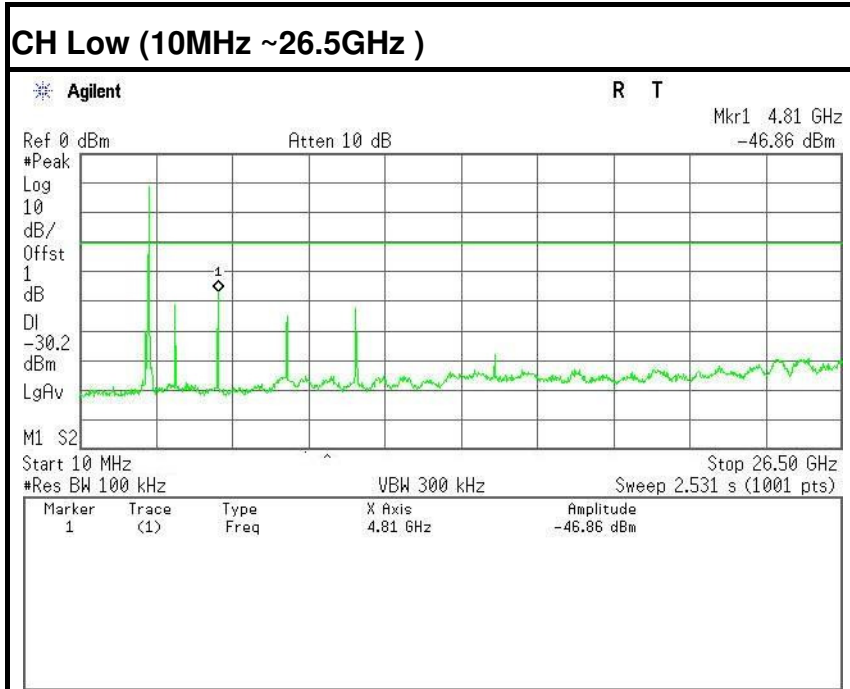

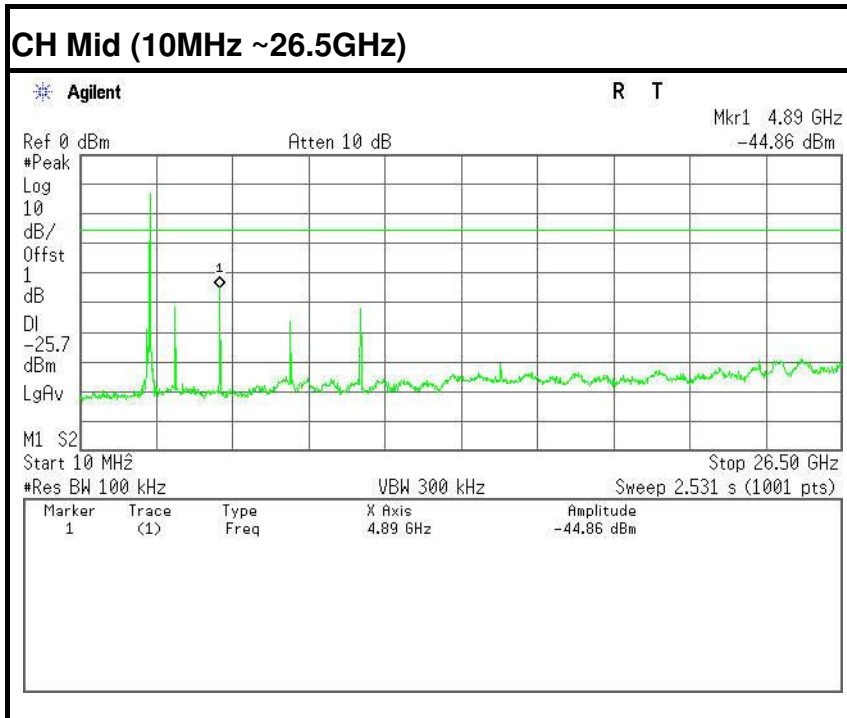



CH High (10MHz ~26.5GHz)

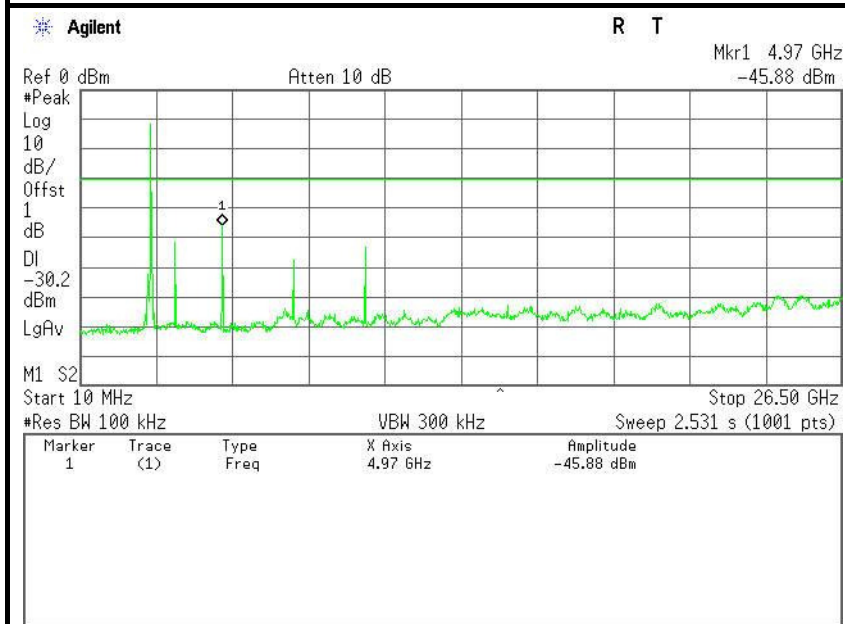

CH High (2.475GHz ~ 2.5GHz)

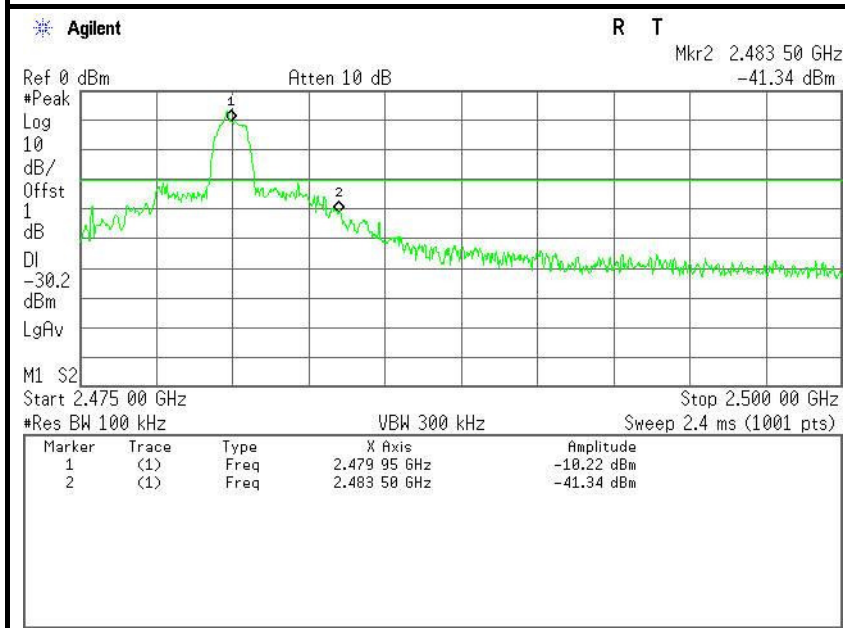



Hopping On

Test Data (GFSK)

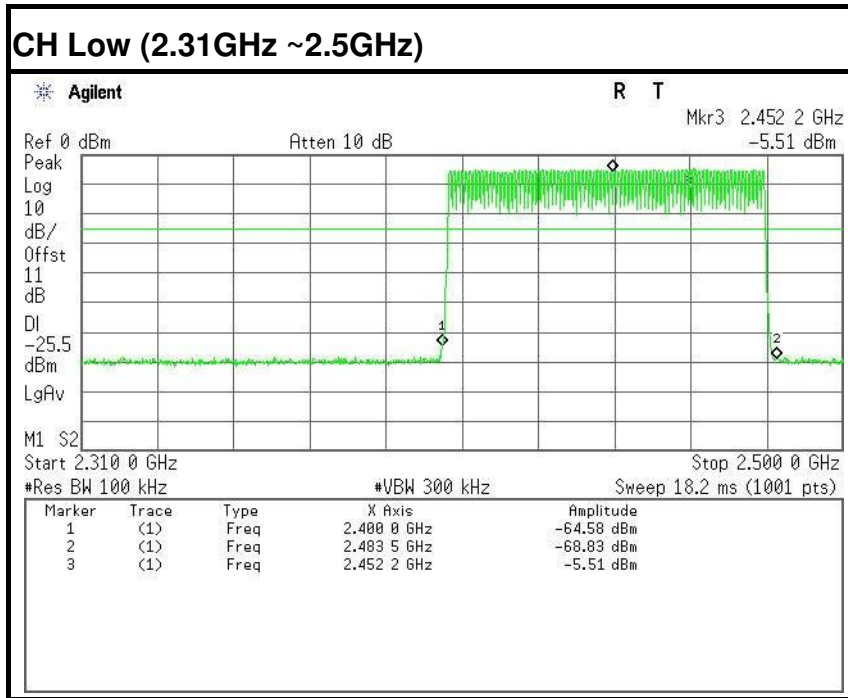

Test Data (8DPSK)

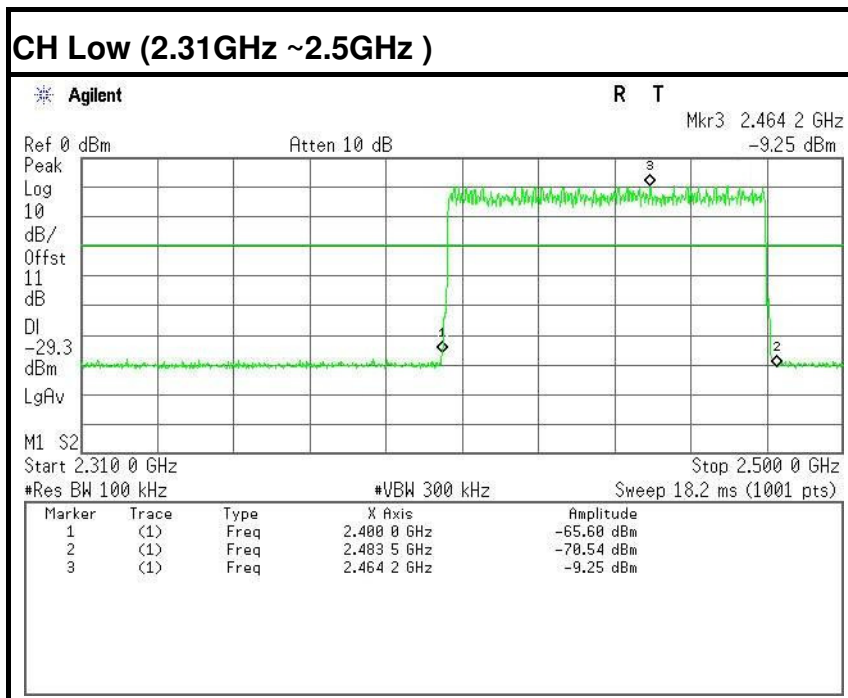



6.9.2. Radiated Emissions

LIMIT

1. Except as provided elsewhere in this Subpart, the emissions from an intentional radiator shall not exceed the field strength levels specified in the following table:

| Frequency (MHz) | Field Strength (mV/m) | Measurement Distance (m) |
|-----------------|-----------------------|--------------------------|
| 0.009-0.490 | 2400/F(kHz) | 300 |
| 0.490-1.705 | 24000/F(kHz) | 30 |
| 1.705-30.0 | 30 | 30 |
| 30-88 | 100* | 3 |
| 88-216 | 150* | 3 |
| 216-960 | 200* | 3 |
| Above 960 | 500 | 3 |

Note: Except as provided in paragraph (g), fundamental emissions from intentional radiators operating under this Section shall not be located in the frequency bands 54-72 MHz, 76-88 MHz, 174-216 MHz or 470-806 MHz. However, operation within these frequency bands is permitted under other sections of this Part, e.g., Sections 15.231 and 15.241.

2. In the above emission table, the tighter limit applies at the band edges.

| Frequency (Hz) | Field Strength ($\mu\text{V}/\text{m}$ at 3-meter) | Field Strength ($\text{dB}\mu\text{V}/\text{m}$ at 3-meter) |
|----------------|---|--|
| 30-88 | 100 | 40 |
| 88-216 | 150 | 43.5 |
| 216-960 | 200 | 46 |
| Above 960 | 500 | 54 |



MEASUREMENT EQUIPMENT USED

| Radiated Emission Test Site 966(2) | | | | | | |
|------------------------------------|----------------|--------------------|---------------|------------------|-----------------|--|
| Name of Equipment | Manufacturer | Model Number | Serial Number | Last Calibration | Due Calibration | |
| PSA Series Spectrum Analyzer | Agilent | E4446A | US44300399 | 02/21/2016 | 02/20/2017 | |
| EMI TEST RECEIVER | ROHDE&SCHWARZ | ESCI | 100783 | 02/21/2016 | 02/20/2017 | |
| Amplifier | MITEQ | AM-1604-3000 | 1123808 | 02/21/2016 | 02/20/2017 | |
| High Noise Amplifier | Agilent | 8449B | 3008A01838 | 02/21/2016 | 02/20/2017 | |
| Board-Band Horn Antenna | Schwarzbeck | BBHA 9170 | 9170-497 | 02/21/2016 | 02/20/2017 | |
| Bilog Antenna | SCHAFFNER | CBL6143 | 5082 | 02/21/2016 | 02/20/2017 | |
| Horn Antenna | SCHWARZBECK | BBHA9120 | D286 | 02/21/2016 | 02/20/2017 | |
| Loop Antenna | A、R、A | PLA-1030/B | 1029 | 02/21/2016 | 02/20/2017 | |
| Turn Table | N/A | N/A | N/A | N.C.R | N.C.R | |
| Controller | Sunol Sciences | SC104V | 022310-1 | N.C.R | N.C.R | |
| Controller | CT | N/A | N/A | N.C.R | N.C.R | |
| Temp. / Humidity Meter | Anymetre | JR913 | N/A | 02/21/2016 | 02/20/2017 | |
| Antenna Tower | SUNOL | TLT2 | N/A | N.C.R | N.C.R | |
| Test S/W | FARAD | LZ-RF / CCS-SZ-3A2 | | | | |

Remark: Each piece of equipment is scheduled for calibration once a year.

Test Configuration

Below 30MHz

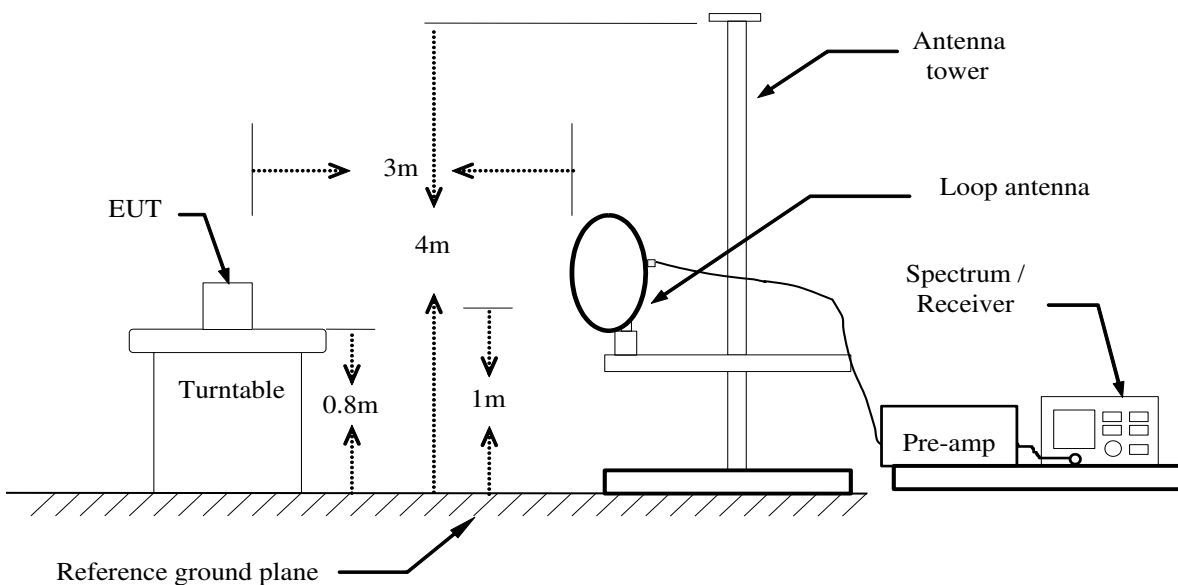



Below 1 GHz

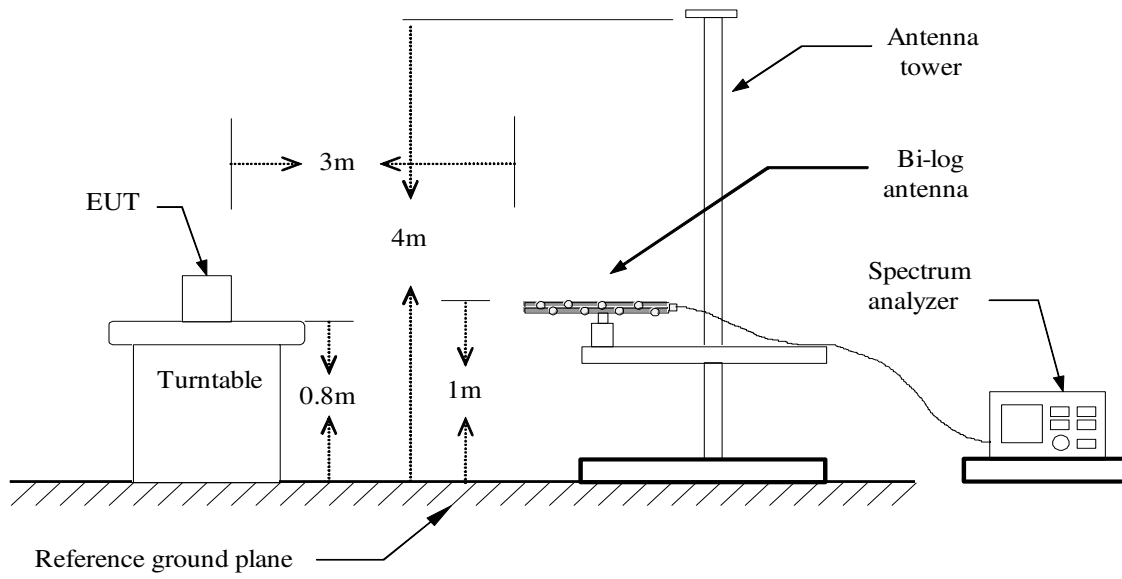

Above 1 GHz

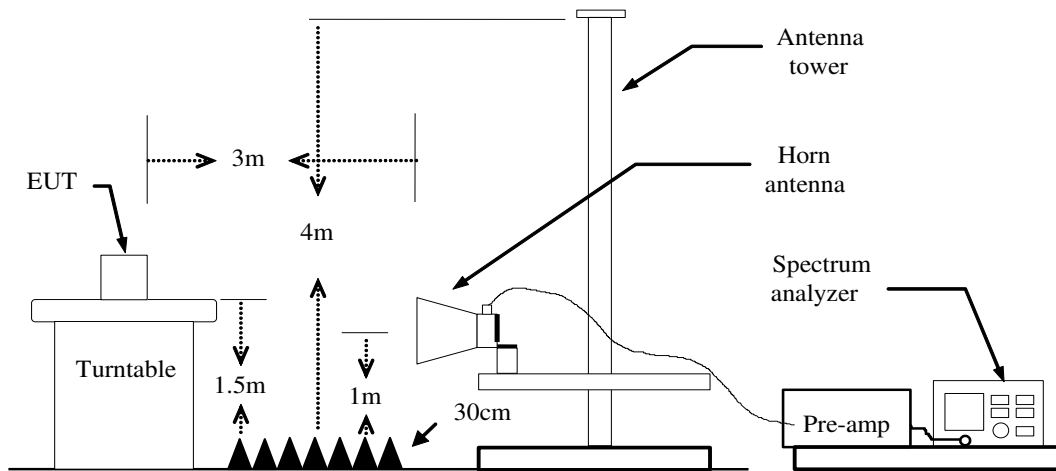



TEST PROCEDURE

1. The EUT is placed on a turntable, which is 0.8m or 1.5m above ground plane.
2. The turntable shall be rotated for 360 degrees to determine the position of maximum emission level.
3. EUT is set 3m away from the receiving antenna, which is varied from 1m to 4m to find out the highest emissions.
4. Maximum procedure was performed on the six highest emissions to ensure EUT compliance.
5. And also, each emission was to be maximized by changing the polarization of receiving antenna both horizontal and vertical.
6. Repeat above procedures until the measurements for all frequencies are complete.



TEST RESULTS

Below 1 GHz

Test Mode: TX

Tested by: Jack Chen

Ambient temperature: 24°C Relative humidity: 52% RH

Date: March 22, 2016

| Frequency (MHz) | Reading (dBuV) | Correction Factor (dB/m) | Result (dBuV/m) | Limit (dBuV/m) | Margin (dB) | Antenna Pole (V/H) | Remark |
|-----------------|----------------|--------------------------|-----------------|----------------|-------------|--------------------|--------|
| 75.2667 | 57.79 | -26.22 | 31.57 | 40.00 | -8.43 | V | QP |
| 99.5167 | 52.95 | -23.73 | 29.22 | 43.50 | -14.28 | V | QP |
| 256.3333 | 48.32 | -20.34 | 27.98 | 46.00 | -18.02 | V | QP |
| 400.2167 | 44.21 | -16.08 | 28.13 | 46.00 | -17.87 | V | QP |
| 600.6833 | 41.89 | -12.85 | 29.04 | 46.00 | -16.96 | V | QP |
| 663.7332 | 48.64 | -12.28 | 36.36 | 46.00 | -9.64 | V | QP |
| 75.2667 | 51.03 | -26.22 | 24.81 | 40.00 | -15.19 | H | QP |
| 96.2832 | 57.11 | -24.07 | 33.04 | 43.50 | -10.46 | H | QP |
| 120.5332 | 58.41 | -21.12 | 37.29 | 43.50 | -6.21 | H | QP |
| 144.7832 | 60.66 | -21.49 | 39.17 | 43.50 | -4.33 | H | QP |
| 175.5000 | 58.15 | -22.94 | 35.21 | 43.50 | -8.29 | H | QP |
| 666.9665 | 40.36 | -12.20 | 28.16 | 46.00 | -17.84 | H | QP |

****Remark:** No emission found between lowest internal used/generated frequency to 30MHz.

Notes:

1. Measuring frequencies from 9kHz to the 1GHz.
2. Radiated emissions measured in frequency range from 30MHz to 1GHz were made with an instrument using Peak/Quasi-peak detector mode.
3. Data of measurement within this frequency range shown " --- " in the table above means the reading of emissions are attenuated more than 20dB below the permissible limits or the field strength is too small to be measured.
4. The IF bandwidth of SPA between 30MHz to 1GHz was 120kHz.
5. Frequency (MHz). = Emission frequency in MHz
 Reading (dBuV) = Receiver reading
 Correction Factor(dB/m) = Antenna factor + Cable loss – Amplifier gain
 Actual FS (dBuV/m) = Reading (dBuV) + Corr. Factor (dB/m)
 Limit (dBuV/m) = Limit stated in standard
 Margin(dB) = Measured (dBuV/m) – Limits (dBuV/m)
 Antenna Pole(V/H) = Current carrying line of reading



Above 1 GHz

GFSK

Test Mode: TX(CH Low)

Tested by: Jack Chen

Ambient temperature: 24°C

Relative humidity: 52% RH

Date: February 21, 2016

| Frequency (MHz) | Reading (dBuV) | Correction Factor (dB/m) | Result (dBuV/m) | Limit (dBuV/m) | Margin (dB) | Antenna Pole (V/H) | Remark |
|-----------------|----------------|--------------------------|-----------------|----------------|-------------|--------------------|--------|
| 1018.000 | 50.29 | -8.49 | 41.80 | 74.00 | -32.20 | V | peak |
| 3331.000 | 46.67 | -0.80 | 45.87 | 74.00 | -28.13 | V | peak |
| 4123.000 | 42.10 | 2.02 | 44.12 | 74.00 | -29.88 | V | peak |
| 4807.000 | 43.71 | 4.35 | 48.06 | 74.00 | -25.94 | V | peak |
| 5455.000 | 41.02 | 5.79 | 46.81 | 74.00 | -27.19 | V | peak |
| 6895.000 | 41.05 | 7.53 | 48.58 | 74.00 | -25.42 | V | peak |
| | | | | | | | |
| 1162.000 | 49.78 | -7.94 | 41.84 | 74.00 | -32.16 | H | Peak |
| 1999.000 | 51.41 | -5.01 | 46.40 | 74.00 | -27.60 | H | Peak |
| 3331.000 | 45.98 | -0.80 | 45.18 | 74.00 | -28.82 | H | Peak |
| 4807.000 | 43.56 | 4.35 | 47.91 | 74.00 | -26.09 | H | peak |
| 5923.000 | 41.66 | 6.05 | 47.71 | 74.00 | -26.29 | H | peak |
| 6796.000 | 40.90 | 7.37 | 48.27 | 74.00 | -25.73 | H | peak |

Notes:

1. Measuring frequencies from 1 GHz to the 10th harmonic of highest fundamental frequency.
2. Measurements above show only up to 6 maximum emissions noted, or would be lesser if no specific emissions from the EUT are recorded (ie: margin>20dB from the applicable limit) and considered that's already beyond the background noise floor.
3. Radiated emissions measured in frequency above 1000MHz were made with an instrument using Peak detector mode and average detector mode of the emission shown in Actual FS column.
4. Spectrum setting:
 - a. Peak Setting 1GHz - 26GHz, RBW = 1MHz, VBW = 1MHz, Sweep time = auto.
 - b. AV Setting 1GHz - 26GHz, RBW = 1MHz, VBW = 330Hz, Sweep time = auto.
5. Frequency (MHz) = Emission frequency in MHz
 Reading (dBuV/m) = Uncorrected Analyzer / Receiver Reading
 Correction Factor (dB) = Antenna factor + Cable loss – Amplifier gain
 Limit (dBuV/m) = Limit stated in standard
 Margin (dB) = Result (dBuV/m)- Limit (dBuV/m)
 Pk = Peak Reading
 AV. = Average Reading
 Remark = Mark Peak Reading or Average Reading



Test Mode: TX(CH Mid)

Tested by: Jack Chen

Ambient temperature: 24°C

Relative humidity: 52% RH

Date: February 21, 2016

| Frequency (MHz) | Reading (dBuV) | Correction Factor (dB/m) | Result (dBuV/m) | Limit (dBuV/m) | Margin (dB) | Antenna Pole (V/H) | Remark |
|-----------------|----------------|--------------------------|-----------------|----------------|-------------|--------------------|--------|
| 1162.000 | 48.82 | -7.94 | 40.88 | 74.00 | -33.12 | V | peak |
| 1999.000 | 49.60 | -5.01 | 44.59 | 74.00 | -29.41 | V | peak |
| 3331.000 | 46.57 | -0.80 | 45.77 | 74.00 | -28.23 | V | peak |
| 4879.000 | 44.42 | 4.59 | 49.01 | 74.00 | -24.99 | V | peak |
| 5725.000 | 40.67 | 5.96 | 46.63 | 74.00 | -27.37 | V | peak |
| 6985.000 | 40.95 | 7.68 | 48.63 | 74.00 | -25.37 | V | peak |
| | | | | | | | |
| 1495.000 | 48.62 | -6.89 | 41.73 | 74.00 | -32.27 | H | Peak |
| 1999.000 | 52.17 | -5.01 | 47.16 | 74.00 | -26.84 | H | Peak |
| 3331.000 | 45.92 | -0.80 | 45.12 | 74.00 | -28.88 | H | Peak |
| 4879.000 | 43.98 | 4.59 | 48.57 | 74.00 | -25.43 | H | peak |
| 5761.000 | 41.15 | 5.98 | 47.13 | 74.00 | -26.87 | H | peak |
| 6958.000 | 41.24 | 7.63 | 48.87 | 74.00 | -25.13 | H | peak |

Notes:

1. Measuring frequencies from 1 GHz to the 10th harmonic of highest fundamental frequency.
2. Measurements above show only up to 6 maximum emissions noted, or would be lesser if no specific emissions from the EUT are recorded (ie: margin>20dB from the applicable limit) and considered that's already beyond the background noise floor.
3. Radiated emissions measured in frequency above 1000MHz were made with an instrument using Peak detector mode and average detector mode of the emission shown in Actual FS column.
4. Spectrum setting:
 - a. Peak Setting 1GHz - 26GHz, RBW = 1MHz, VBW = 1MHz, Sweep time = auto.
 - b. AV Setting 1GHz - 26GHz, RBW = 1MHz, VBW = 330Hz, Sweep time = auto.
5. Frequency (MHz) = Emission frequency in MHz
 Reading (dBuV/m) =Uncorrected Analyzer / Receiver Reading
 Correction Factor (dB) = Antenna factor + Cable loss – Amplifier gain
 Limit (dBuV/m) = Limit stated in standard
 Margin (dB) = Result (dBuV/m)- Limit (dBuV/m)
 Pk = Peak Reading
 AV. = Average Reading
 Remark = Mark Peak Reading or Average Reading



Test Mode: TX(CH High)

Tested by: Jack Chen

Ambient temperature: 24°C

Relative humidity: 52% RH

Date: February 21, 2016

| Frequency (MHz) | Reading (dBuV) | Correction Factor (dB/m) | Result (dBuV/m) | Limit (dBuV/m) | Margin (dB) | Antenna Pole (V/H) | Remark |
|-----------------|----------------|--------------------------|-----------------|----------------|-------------|--------------------|--------|
| 1000.0000 | 55.85 | -9.36 | 46.49 | 74.00 | -27.51 | V | peak |
| 1999.000 | 48.67 | -5.01 | 43.66 | 74.00 | -30.34 | V | peak |
| 3331.000 | 46.60 | -0.80 | 45.80 | 74.00 | -28.20 | V | peak |
| 4330.000 | 42.93 | 2.75 | 45.68 | 74.00 | -28.32 | V | peak |
| 4960.000 | 43.27 | 4.85 | 48.12 | 74.00 | -25.88 | V | peak |
| 6481.000 | 41.41 | 6.86 | 48.27 | 74.00 | -25.73 | V | peak |
| | | | | | | | |
| 1999.000 | 51.86 | -5.01 | 46.85 | 74.00 | -27.15 | H | Peak |
| 3331.000 | 45.20 | -0.80 | 44.40 | 74.00 | -29.60 | H | Peak |
| 4420.000 | 42.59 | 3.07 | 45.66 | 74.00 | -28.34 | H | Peak |
| 5104.000 | 41.49 | 5.17 | 46.66 | 74.00 | -27.34 | H | peak |
| 5995.000 | 41.37 | 6.08 | 47.45 | 74.00 | -26.55 | H | peak |
| 6535.000 | 41.18 | 6.95 | 48.13 | 74.00 | -25.87 | H | peak |

Notes:

1. Measuring frequencies from 1 GHz to the 10th harmonic of highest fundamental frequency.
2. Measurements above show only up to 6 maximum emissions noted, or would be lesser if no specific emissions from the EUT are recorded (ie: margin>20dB from the applicable limit) and considered that's already beyond the background noise floor.
3. Radiated emissions measured in frequency above 1000MHz were made with an instrument using Peak detector mode and average detector mode of the emission shown in Actual FS column.
4. Spectrum setting:
 - a. Peak Setting 1GHz - 26GHz, RBW = 1MHz, VBW = 1MHz, Sweep time = auto.
 - b. AV Setting 1GHz - 26GHz, RBW = 1MHz, VBW = 330Hz, Sweep time = auto.
5. Frequency (MHz) = Emission frequency in MHz
 Reading (dBuV/m) =Uncorrected Analyzer / Receiver Reading
 Correction Factor (dB) = Antenna factor + Cable loss – Amplifier gain
 Limit (dBuV/m) = Limit stated in standard
 Margin (dB) = Result (dBuV/m)- Limit (dBuV/m)
 Pk = Peak Reading
 AV. = Average Reading
 Remark = Mark Peak Reading or Average Reading



8DPSK

Test Mode: TX(CH Low)

Tested by: Jack Chen

Ambient temperature: 24°C

Relative humidity: 52% RH

Date: February 21, 2016

| Frequency (MHz) | Reading (dBuV) | Correction Factor (dB/m) | Result (dBuV/m) | Limit (dBuV/m) | Margin (dB) | Antenna Pole (V/H) | Remark |
|-----------------|----------------|--------------------------|-----------------|----------------|-------------|--------------------|--------|
| 1018.000 | 50.23 | -8.49 | 41.74 | 74.00 | -32.26 | V | peak |
| 1999.000 | 48.35 | -5.01 | 43.34 | 74.00 | -30.66 | V | peak |
| 3331.000 | 47.39 | -0.80 | 46.59 | 74.00 | -27.41 | V | peak |
| 4600.000 | 41.88 | 3.68 | 45.56 | 74.00 | -28.44 | V | peak |
| 4807.000 | 46.43 | 4.35 | 50.78 | 74.00 | -23.22 | V | peak |
| 5365.000 | 41.39 | 5.63 | 47.02 | 74.00 | -26.98 | V | peak |
| | | | | | | | |
| 1999.000 | 52.01 | -5.01 | 47.00 | 74.00 | -27.00 | H | Peak |
| 2404.000 | 51.29 | -2.79 | 48.50 | 74.00 | -25.50 | H | Peak |
| 4807.000 | 43.94 | 4.35 | 48.29 | 74.00 | -25.71 | H | Peak |
| 5644.000 | 41.59 | 5.93 | 47.52 | 74.00 | -26.48 | H | peak |
| 7777.000 | 40.68 | 9.22 | 49.90 | 74.00 | -24.10 | H | peak |
| 8353.000 | 40.43 | 9.46 | 49.89 | 74.00 | -24.11 | H | peak |

Notes:

1. Measuring frequencies from 1 GHz to the 10th harmonic of highest fundamental frequency.
2. Measurements above show only up to 6 maximum emissions noted, or would be lesser if no specific emissions from the EUT are recorded (ie: margin>20dB from the applicable limit) and considered that's already beyond the background noise floor.
3. Radiated emissions measured in frequency above 1000MHz were made with an instrument using Peak detector mode and average detector mode of the emission shown in Actual FS column.
4. Spectrum setting:
 - a. Peak Setting 1GHz - 26GHz, RBW = 1MHz, VBW = 1MHz, Sweep time = auto.
 - b. AV Setting 1GHz - 26GHz, RBW = 1MHz, VBW = 330Hz, Sweep time = auto.
5. Frequency (MHz) = Emission frequency in MHz
 Reading (dBuV/m) =Uncorrected Analyzer / Receiver Reading
 Correction Factor (dB) = Antenna factor + Cable loss – Amplifier gain
 Limit (dBuV/m) = Limit stated in standard
 Margin (dB) = Result (dBuV/m)- Limit (dBuV/m)
 Pk = Peak Reading
 AV. = Average Reading
 Remark = Mark Peak Reading or Average Reading



Test Mode: TX(CH Mid)

Tested by: Jack Chen

Ambient temperature: 24°C

Relative humidity: 52% RH

Date: February 21, 2016

| Frequency (MHz) | Reading (dBuV) | Correction Factor (dB/m) | Result (dBuV/m) | Limit (dBuV/m) | Margin (dB) | Antenna Pole (V/H) | Remark |
|-----------------|----------------|--------------------------|-----------------|----------------|-------------|--------------------|--------|
| 1018.000 | 51.43 | -8.49 | 42.94 | 74.00 | -31.06 | V | peak |
| 1990.000 | 49.67 | -5.06 | 44.61 | 74.00 | -29.39 | V | peak |
| 3331.000 | 47.31 | -0.80 | 46.51 | 74.00 | -27.49 | V | peak |
| 4879.000 | 46.25 | 4.59 | 50.84 | 74.00 | -23.16 | V | peak |
| 5896.000 | 40.79 | 6.04 | 46.83 | 74.00 | -27.17 | V | peak |
| 7219.000 | 40.41 | 8.13 | 48.54 | 74.00 | -25.46 | V | peak |
| | | | | | | | |
| 1504.000 | 47.95 | -6.87 | 41.08 | 74.00 | -32.92 | H | Peak |
| 1990.000 | 51.57 | -5.06 | 46.51 | 74.00 | -27.49 | H | Peak |
| 4879.000 | 44.37 | 4.59 | 48.96 | 74.00 | -25.04 | H | Peak |
| 5275.000 | 41.72 | 5.47 | 47.19 | 74.00 | -26.81 | H | peak |
| 6589.000 | 40.25 | 7.03 | 47.28 | 74.00 | -26.72 | H | peak |
| 7219.000 | 40.64 | 8.13 | 48.77 | 74.00 | -25.23 | H | peak |

Notes:

1. Measuring frequencies from 1 GHz to the 10th harmonic of highest fundamental frequency.
2. Measurements above show only up to 6 maximum emissions noted, or would be lesser if no specific emissions from the EUT are recorded (ie: margin>20dB from the applicable limit) and considered that's already beyond the background noise floor.
3. Radiated emissions measured in frequency above 1000MHz were made with an instrument using Peak detector mode and average detector mode of the emission shown in Actual FS column.
4. Spectrum setting:
 - a. Peak Setting 1GHz - 26GHz, RBW = 1MHz, VBW = 1MHz, Sweep time = auto.
 - b. AV Setting 1GHz - 26GHz, RBW = 1MHz, VBW = 330Hz, Sweep time = auto.
5. Frequency (MHz) = Emission frequency in MHz
 Reading (dBuV/m) =Uncorrected Analyzer / Receiver Reading
 Correction Factor (dB) = Antenna factor + Cable loss – Amplifier gain
 Limit (dBuV/m) = Limit stated in standard
 Margin (dB) = Result (dBuV/m)- Limit (dBuV/m)
 Pk = Peak Reading
 AV. = Average Reading
 Remark = Mark Peak Reading or Average Reading



Test Mode: TX(CH High)

Tested by: Jack Chen

Ambient temperature: 24°C

Relative humidity: 52% RH

Date: February 21, 2016

| Frequency (MHz) | Reading (dBuV) | Correction Factor (dB/m) | Result (dBuV/m) | Limit (dBuV/m) | Margin (dB) | Antenna Pole (V/H) | Remark |
|-----------------|----------------|--------------------------|-----------------|----------------|-------------|--------------------|--------|
| 1018.000 | 50.11 | -8.49 | 41.62 | 74.00 | -32.38 | V | peak |
| 1999.000 | 48.63 | -5.01 | 43.62 | 74.00 | -30.38 | V | peak |
| 3331.000 | 47.34 | -0.80 | 46.54 | 74.00 | -27.46 | V | peak |
| 4069.000 | 44.11 | 1.83 | 45.94 | 74.00 | -28.06 | V | peak |
| 4960.000 | 42.68 | 4.85 | 47.53 | 74.00 | -26.47 | V | peak |
| 5878.000 | 41.30 | 6.03 | 47.33 | 74.00 | -26.67 | V | peak |
| | | | | | | | |
| 1162.000 | 49.48 | -7.94 | 41.54 | 74.00 | -32.46 | H | Peak |
| 1999.000 | 52.52 | -5.01 | 47.51 | 74.00 | -26.49 | H | Peak |
| 3880.000 | 43.17 | 1.08 | 44.25 | 74.00 | -29.75 | H | Peak |
| 4960.000 | 42.63 | 4.85 | 47.48 | 74.00 | -26.52 | H | peak |
| 5995.000 | 41.66 | 6.08 | 47.74 | 74.00 | -26.26 | H | peak |
| 6931.000 | 40.84 | 7.59 | 48.43 | 74.00 | -25.57 | H | peak |

Notes:

1. Measuring frequencies from 1 GHz to the 10th harmonic of highest fundamental frequency.
2. Measurements above show only up to 6 maximum emissions noted, or would be lesser if no specific emissions from the EUT are recorded (ie: margin>20dB from the applicable limit) and considered that's already beyond the background noise floor.
3. Radiated emissions measured in frequency above 1000MHz were made with an instrument using Peak detector mode and average detector mode of the emission shown in Actual FS column.
4. Spectrum setting:
 - a. Peak Setting 1GHz - 26GHz, RBW = 1MHz, VBW = 1MHz, Sweep time = auto.
 - b. AV Setting 1GHz - 26GHz, RBW = 1MHz, VBW = 330Hz, Sweep time = auto.
5. Frequency (MHz) = Emission frequency in MHz
 Reading (dBuV/m) =Uncorrected Analyzer / Receiver Reading
 Correction Factor (dB) = Antenna factor + Cable loss – Amplifier gain
 Limit (dBuV/m) = Limit stated in standard
 Margin (dB) = Result (dBuV/m)- Limit (dBuV/m)
 Pk = Peak Reading
 AV = Average Reading
 Remark = Mark Peak Reading or Average Reading



6.10 POWERLINE CONDUCTED EMISSIONS

LIMIT

For an intentional radiator which is designed to be connected to the public utility (AC) power line, the radio frequency voltage that is conducted back onto the AC power line on any frequency or frequencies within the band 150 kHz to 30 MHz shall not exceed 250 microvolts (The limit decreases linearly with the logarithm of the frequency in the range 0.15 MHz to 0.50 MHz). The limits at specific frequency range is listed as follows:

| Frequency Range (MHz) | Limits (dB μ V) | |
|-----------------------|---------------------|----------|
| | Quasi-peak | Average |
| 0.15 to 0.50 | 66 to 56 | 56 to 46 |
| 0.50 to 5 | 56 | 46 |
| 5 to 30 | 60 | 50 |

Compliance with this provision shall be based on the measurement of the radio frequency voltage between each power line (LINE and NEUTRAL) and ground at the power terminals.

MEASUREMENT EQUIPMENT USED

| Conducted Emission Test Site | | | | | |
|------------------------------|---------------|--------------------|---------------|------------------|-----------------|
| Name of Equipment | Manufacturer | Model Number | Serial Number | Last Calibration | Due Calibration |
| EMI TEST RECEIVER | ROHDE&SCHWARZ | ESCI | 100783 | 02/21/2016 | 02/20/2017 |
| LISN(EUT) | ROHDE&SCHWARZ | ENV216 | 101543-WX | 02/21/2016 | 02/20/2017 |
| LISN | EMCO | 3825/2 | 8901-1459 | 02/21/2016 | 02/20/2017 |
| Temp. / Humidity Meter | VICTOR | HTC-1 | N/A | 02/21/2016 | 02/20/2017 |
| Test S/W | FARAD | EZ-EMC/ CCS-3A1-CE | | | |

Remark: Each piece of equipment is scheduled for calibration once a year.



Test Configuration

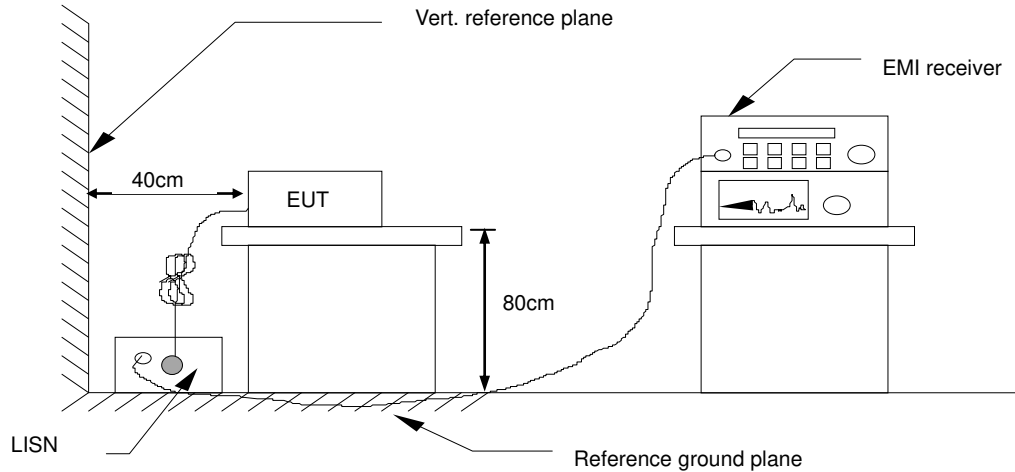

See test photographs attached in Appendix 1 for the actual connections between EUT and support equipment.

TEST PROCEDURE

1. The EUT was placed on a table, which is 0.8m above ground plane.
2. Maximum procedure was performed on the six highest emissions to ensure EUT compliance.
3. Repeat above procedures until all frequency measured were complete.

TEST RESULTS

The initial step in collecting conducted data is a spectrum analyzer peak scan of the measurement range. Significant peaks are then marked as shown on the following data page, and these signals are then quasi-peaked.



Test Data

| | | | |
|---------------------------------|-------------------|------------------|--------|
| Model No. | MC-3941 | RBW,VBW | 9 kHz |
| Environmental Conditions | 22°C, 45% RH | Test Mode | Mode 1 |
| Tested by | Jack Chen | Line | L1 |
| Test Date | February 22, 2016 | | |

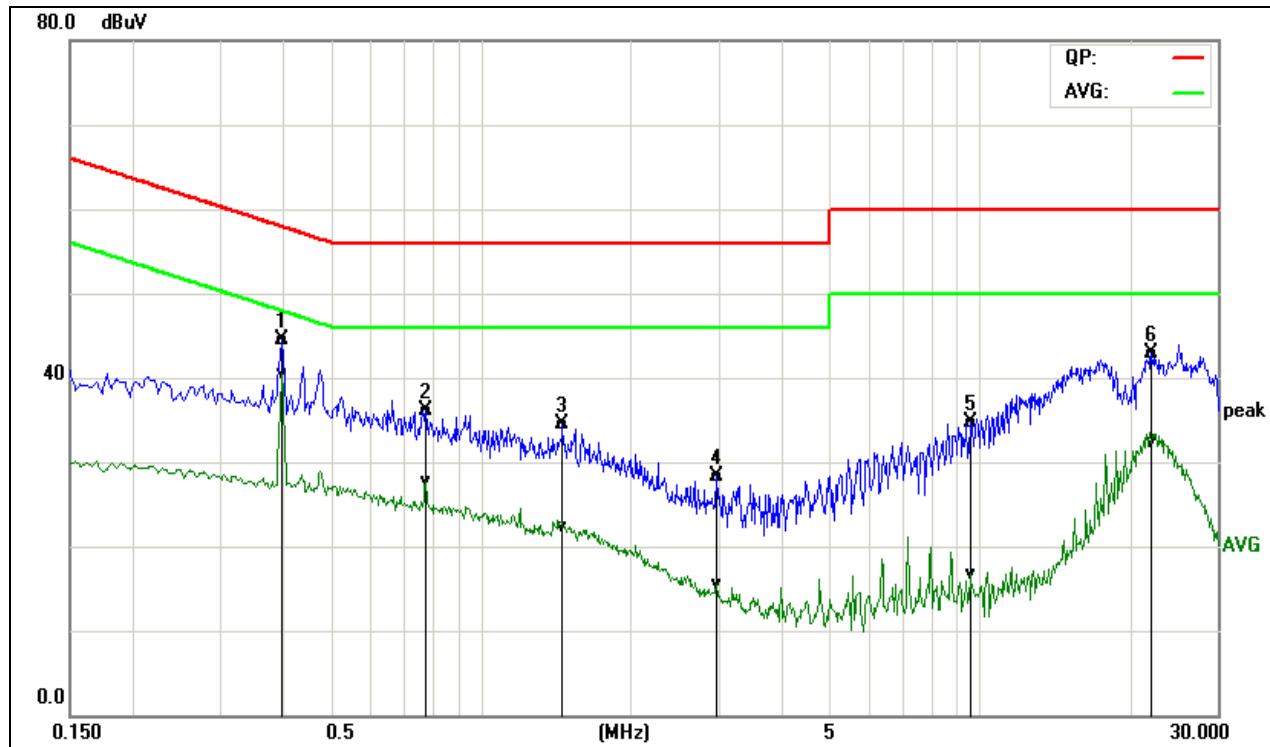

| Frequency (MHz) | QuasiPeak Reading (dBuV) | Average Reading (dBuV) | Correction Factor (dB) | QuasiPeak Result (dBuV) | Average Result (dBuV) | QuasiPeak Limit (dBuV) | Average Limit (dBuV) | QuasiPeak Margin (dB) | Average Margin (dB) | Remark (Pass/Fail) |
|-----------------|--------------------------|------------------------|------------------------|-------------------------|-----------------------|------------------------|----------------------|-----------------------|---------------------|--------------------|
| 0.3980 | 34.82 | 30.76 | 9.68 | 44.50 | 40.44 | 57.89 | 47.90 | -13.39 | -7.46 | Pass |
| 0.7780 | 26.36 | 17.84 | 9.77 | 36.13 | 27.61 | 56.00 | 46.00 | -19.87 | -18.39 | Pass |
| 1.4620 | 24.71 | 12.68 | 9.72 | 34.43 | 22.40 | 56.00 | 46.00 | -21.57 | -23.60 | Pass |
| 2.9660 | 18.50 | 5.84 | 9.72 | 28.22 | 15.56 | 56.00 | 46.00 | -27.78 | -30.44 | Pass |
| 9.5740 | 24.80 | 6.92 | 9.86 | 34.66 | 16.78 | 60.00 | 50.00 | -25.34 | -33.22 | Pass |
| 22.1780 | 33.02 | 22.39 | 9.86 | 42.88 | 32.25 | 60.00 | 50.00 | -17.12 | -17.75 | Pass |

REMARKS: L1 = Line One (Live Line)



| | | | |
|---------------------------------|-------------------|------------------|--------|
| Model No. | MC-3941 | RBW,VBW | 9 kHz |
| Environmental Conditions | 22°C, 45% RH | Test Mode | Mode 1 |
| Tested by | Jack Chen | Line | L2 |
| Test Date | February 22, 2016 | | |

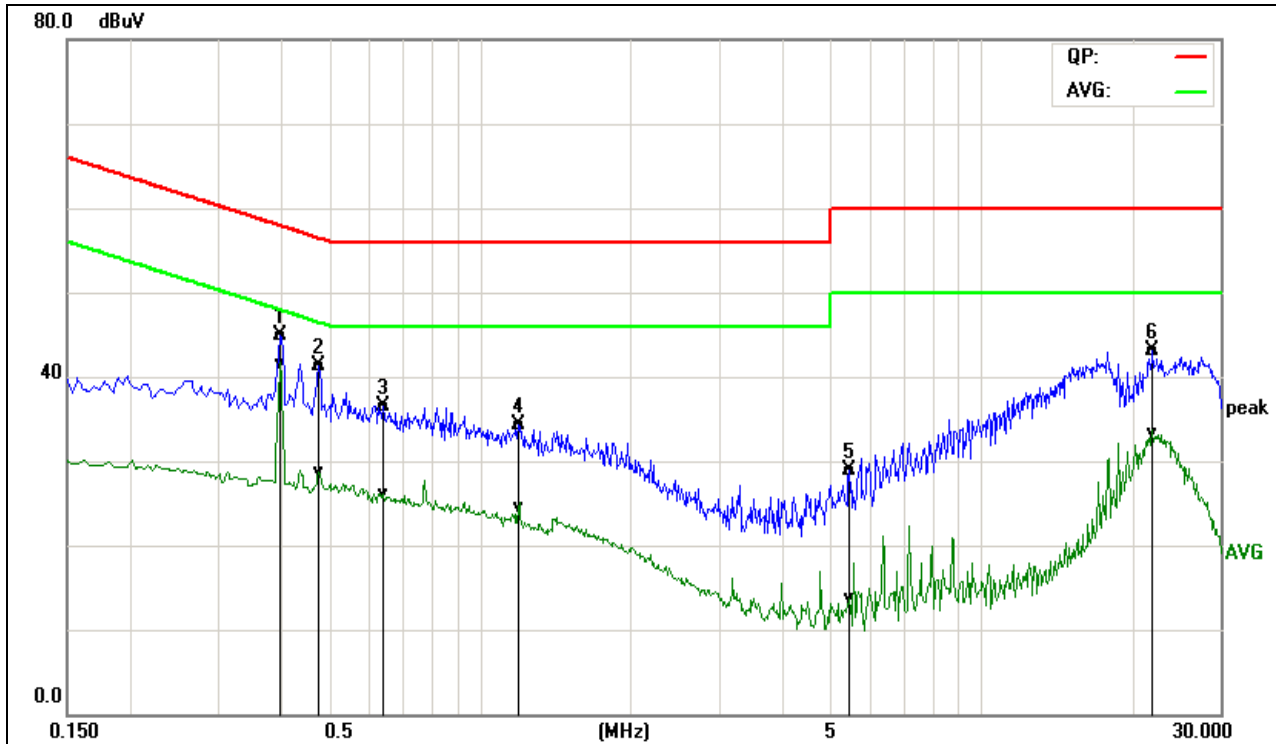

| Frequency (MHz) | QuasiPeak Reading (dBuV) | Average Reading (dBuV) | Correction Factor (dB) | QuasiPeak Result (dBuV) | Average Result (dBuV) | QuasiPeak Limit (dBuV) | Average Limit (dBuV) | QuasiPeak Margin (dB) | Average Margin (dB) | Remark (Pass/Fail) |
|-----------------|--------------------------|------------------------|------------------------|-------------------------|-----------------------|------------------------|----------------------|-----------------------|---------------------|--------------------|
| 0.3980 | 35.13 | 31.89 | 9.71 | 44.84 | 41.60 | 57.89 | 47.90 | -13.05 | -6.30 | Pass |
| 0.4780 | 31.61 | 19.09 | 9.69 | 41.30 | 28.78 | 56.37 | 46.37 | -15.07 | -17.59 | Pass |
| 0.6419 | 26.89 | 16.37 | 9.69 | 36.58 | 26.06 | 56.00 | 46.00 | -19.42 | -19.94 | Pass |
| 1.1940 | 24.55 | 14.72 | 9.79 | 34.34 | 24.51 | 56.00 | 46.00 | -21.66 | -21.49 | Pass |
| 5.4540 | 19.05 | 3.86 | 9.78 | 28.83 | 13.64 | 60.00 | 50.00 | -31.17 | -36.36 | Pass |
| 21.9500 | 33.41 | 23.59 | 9.75 | 43.16 | 33.34 | 60.00 | 50.00 | -16.84 | -16.66 | Pass |

REMARKS: L2 = Line Two (Neutral Line)