

vtech[®]

Instruction Manual

Kidi Superstar Jr. Karaoke™



INTRODUCTION

Thank you for purchasing the **Kidi Superstar Jr. Karaoke™**! Sing along to ten built-in songs and 20 popular melodies in four different music genres! You can also sing along to your favorite songs by connecting your own external music player via Bluetooth® wireless technology. The multicolored lights add to the atmosphere, and you can adjust tempo and volume and create cute voice-changing effects. Let's start the show!

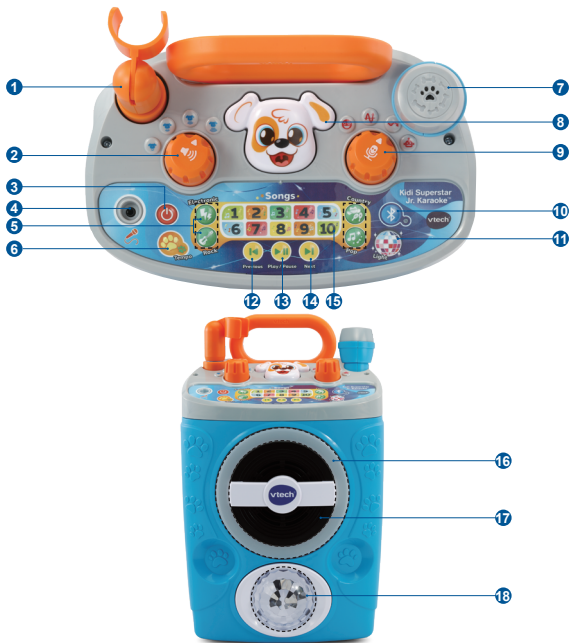

- | | |
|--|-----------------------------|
| ❶ Extendable Microphone Stand | ❿ Bluetooth® Button |
| ❷ Volume Dial | ⓫ Disco Light On/Off Button |
| ❸ Power Button | ⓬ Previous Button |
| ❹ Microphone Jack | ⓭ Play & Pause Button |
| ❺ Music Style Buttons
(Electronic/Country/Rock/Pop) | ⓮ Next Button |
| ❻ Tempo Button | ⓯ Song Buttons |
| ❼ Microphone | ⓰ Color Change Light Ring |
| ❽ Puppy Button | ⓱ Speaker |
| ❾ Voice Changer
(Normal/High/Low/Robot) | ⓲ Disco Light |

INCLUDED IN THE PACKAGE

- Kidi Superstar Jr. Karaoke™
- Left Wheel Bracket
- Right Wheel Bracket
- Microphone
- Quick Start Guide

WARNING

All packing materials such as tape, plastic sheets, packaging locks, removable tags, cable ties, cords and packaging screws are not part of this toy, and should be discarded for your child's safety.

NOTE

Please save this Instruction Manual as it contains important information.

ATTENTION

Pour la sécurité de votre enfant, débarrassez-vous de tous les produits d'emballage tels que rubans adhésifs, feuilles de plastique, attaches, étiquettes, cordons et vis d'emballage. Ils ne font pas partie du jouet.

NOTE

Il est conseillé de sauvegarder ce manuel d'instructions car il comporte des informations importantes.

GETTING STARTED

Battery Removal and Installation

1. Make sure the unit is turned **Off**.
2. Find the battery cover located on the back of the unit, use a screwdriver to loosen the screw, and then open the battery cover.
3. Remove old batteries by pulling up on one end of each battery.
4. Install 4 new AA (AM-3/LR6) batteries following the diagram inside the battery box. (For best performance, alkaline batteries or fully charged Ni-MH rechargeable batteries are recommended.)
5. Replace the battery cover and tighten the screw to secure.

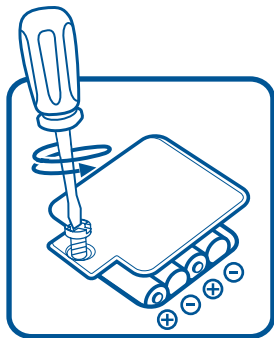

WARNING:

Adult assembly required for battery installation.
Keep batteries out of reach of children.



ATTENTION :

Les piles ou accumulateurs doivent être installés par un adulte.
Tenir les piles ou accumulateurs hors de portée des enfants.

IMPORTANT: BATTERY INFORMATION

- Insert batteries with the correct polarity (+ and -).
- Do not mix old and new batteries.
- Do not mix alkaline, standard (carbon-zinc) or rechargeable batteries.
- Only batteries of the same or equivalent type as recommended are to be used.
- Do not short-circuit the supply terminals.
- Remove batteries during long periods of non-use.
- Remove exhausted batteries from the toy.
- Dispose of batteries safely. Do not dispose of batteries in fire.

RECHARGEABLE BATTERIES:

- Remove rechargeable batteries (if removable) from toy before charging.
- Rechargeable batteries are only to be charged under adult supervision.
- Do not charge non-rechargeable batteries.

IMPORTANT : INFORMATIONS CONCERNANT LES PILES

- Mettre en place les piles ou les accumulateurs en respectant les polarités + et –.
- Ne pas mélanger des piles ou des accumulateurs neufs avec des usagés.
- Ne pas mélanger différents types de piles : alcalines, zinc-carbone et rechargeables.
- Seules des piles du type recommandé doivent être utilisées.
- Ne pas mettre les bornes d'une pile ou d'un accumulateur en court-circuit (en reliant directement le + et le –).
- Retirer les piles ou les accumulateurs en cas de non-utilisation prolongée.
- Enlever les piles ou les accumulateurs usagés du jouet.
- Ne les jeter ni au feu ni dans la nature.

PILES RECHARGEABLES

- Enlever, lorsque c'est possible, les accumulateurs du jouet pour les recharger.
- Les accumulateurs ne doivent être chargés que sous la surveillance d'un adulte.
- Ne pas tenter de recharger des piles non rechargeables.

ASSEMBLY INSTRUCTIONS

With the **Kidi Superstar Jr. Karaoke™**, safety comes first. Adult assembly required. For your child's safety, do not let them play with this toy until it is fully assembled.

1. Insert the **Left Wheel Bracket** into the left slot.
2. Insert the **Right Wheel Bracket** into the right slot.

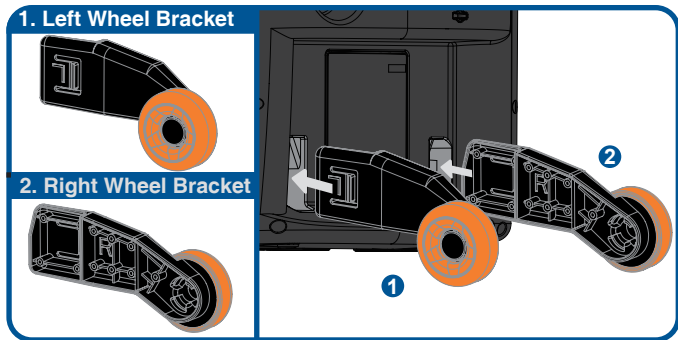

PRODUCT FEATURES

1. Power Button

Press the **Power Button**  to turn the unit **On**. Press it again to turn the unit **Off**.



2. Microphone

Plug the **Microphone** into the **Microphone Jack**, then speak or sing into the **Microphone**. The built-in speaker will amplify your voice.



3. Song Buttons

Press a **Song Button**  to play the built-in sing-along songs.

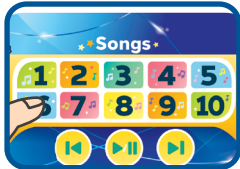

4. Music Style Buttons

Press a **Music Style Button** to choose four types of melodies: Electronic , Country , Rock  or Pop .



5. Previous Button

Press the **Previous Button**  to play the previous song or melody.



6. Play & Pause Button

Press the **Play & Pause Button**  to play or pause the music.

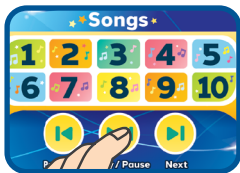

7. Next Button

Press the **Next Button**  to play the next song or melody.

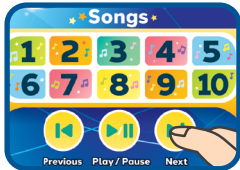

8. Tempo Button

Press the **Tempo Button**  to change the melody tempo.



9. Disco Light On/Off Button

Press the **Disco Light On/Off Button**  to turn the light off or on.



10. Puppy Button

Press the **Puppy Button** during a sing-along song to remove the vocals or add them back!



11. Volume Dial

Turn the **Volume Dial** clockwise to increase the volume or counter-clockwise to decrease it.



12. Voice Changer

Turn the **Voice Changer**, then sing or speak into the **Microphone** to make your voice sound high-pitched, low-pitched, or robotic!



13. Bluetooth® Button

Press the **Bluetooth Button**  to connect with other devices with Bluetooth® wireless technology.

NOTE

See the Bluetooth® Pairing section below for instructions.



14. AUTOMATIC SHUT-OFF

To preserve battery life, the **Kidi Superstar Jr. Karaoke™** will automatically shut off after several minutes without any button or voice input. The unit can be turned on again by pressing the **Power Button**.

NOTE

If the unit powers down or if the **Color Change Light Ring** flashes red three times during play, please install a new set of batteries.

Bluetooth® Pairing

1. Press the **Bluetooth Button**  to go into Bluetooth mode. Then the unit will search for your personal device and request to be paired.
2. The indicator light will flash blue on the **Kidi Superstar Jr. Karaoke™** when waiting for a connection.
3. Choose “VTech Kidi Superstar Jr” from your personal device to send a connection request to the **Kidi Superstar Jr. Karaoke™**. If a pairing request screen appears on your device, click “Pair” to continue. On the **Kidi Superstar Jr. Karaoke™**, press and hold the **Play Button** for several seconds to confirm. The wireless connection will be disconnected after approximately one minute if the connection is not confirmed.
4. When the connection is confirmed, the indicator light will turn solid blue on the **Kidi Superstar Jr. Karaoke™**.
5. After the paired device is connected successfully, press the **Bluetooth Button** once to disconnect the wireless connection and leave Bluetooth mode, then press again to connect to the previous device automatically.
6. To pair a new device without automatically pairing with the previous device, hold the **Bluetooth Button** for several seconds. The previous connection will be forgotten, and the unit will search for a new device. Respond to the request to pair with the “VTech Kidi Superstar Jr” on the new device. This operation needs to be performed in Bluetooth mode.
7. For best results, maintain a distance of 10 feet or less between the Bluetooth® device and the **Kidi Superstar Jr. Karaoke™**. The **Kidi Superstar Jr. Karaoke™** may disconnect when the distance to the paired Bluetooth® device exceeds 10 feet.

NOTE

No passcode needs to be inputted on any device.

ACTIVITIES

1. Music Time

Sing along to the 10 built-in sing-along songs with or without the vocals, or play 20 popular melodies in four different music genres!

2. Sing Your Favorite Song

Connect your external music device with the karaoke machine via *Bluetooth*[®] and sing along to your favorite song! In Bluetooth mode, pressing any button will play silly sound effects.

3. Party Time

Have fun speaking or singing with different voice effects! Adjust the melody tempo with the **Tempo Button** or the volume with the **Volume Dial**. Colorful light effects create an exciting atmosphere for you to dance and sing with your friends and family.



NOTE

For optimal performance, stand to the left or right of the **Speaker** and not directly in front of it.

CARE & MAINTENANCE

1. Keep the unit clean by wiping it with a slightly damp cloth.
2. Keep the unit out of direct sunlight and away from any direct heat sources.
3. Remove the batteries if the unit will not be in use for an extended period of time.
4. Do not drop the unit on hard surfaces and do not expose the unit to moisture or water.

TROUBLESHOOTING

If for some reason the unit stops working or malfunctions, please follow these steps:

1. Turn the unit **Off**.
2. Interrupt the power supply by removing the batteries.
3. Let the unit stand for a few minutes, then replace the batteries.
4. Turn the unit **On**. The unit should now be ready to use again.
5. If the unit still does not work, replace with a new set of batteries.

If there is a Bluetooth® connection problem, please follow these steps:

1. On your Bluetooth® device, please go to Bluetooth® settings. If the “VTech Kidi Superstar Jr” is found in your list of connected, paired or saved devices, please “forget” or “unpair” it.
2. Then disable and re-enable Bluetooth® on your device or restart it.
3. Turn the unit off and on and repeat the Bluetooth® wireless technology pairing process.

IMPORTANT NOTE

If the problem persists, please call our **Consumer Services Department** at **1-800-521-2010** in the U.S., **1-877-352-8697** in Canada, **1-800-862-155** in Australia, or **0800-400-785** in New Zealand. Or visit our website **vtechkids.com** for the U.S. and Canada, or **support.vtech.com.au** for Australia and New Zealand, and fill out our **Contact Us** form located under the **Customer Support** link. Creating and developing VTech products is accompanied by a responsibility that we take very seriously. We make every effort to ensure the accuracy of the information, which forms the value of our products. However, errors sometimes can occur. It is important for you to know that we stand behind our products and encourage you to contact us with any problems and/or suggestions you might have. A service representative will be happy to help you.

This device contains license-exempt transmitter(s)/receiver(s) that comply with Innovation, Science and Economic Development Canada's license-exempt RSS(s). Operation is subject to the following two conditions:

(1) This device may not cause interference; and (2) This device must accept any interference, including interference that may cause undesired operation of the device.

L'émetteur/récepteur exempt de licence contenu dans le présent appareil est conforme aux CNR d'Innovation, Sciences et Développement économique Canada applicables aux appareils radio exempts de licence. L'exploitation est autorisée aux deux conditions suivantes :

(1) l'appareil ne doit pas produire de brouillage, et (2) l'utilisateur de l'appareil doit accepter tout brouillage radio électrique subi, même si le brouillage est susceptible d'en compromettre le fonctionnement.”

Bluetooth® Statement

The Bluetooth® word mark and logos are registered trademarks owned by the Bluetooth SIG, Inc. and any use of such marks by VTech® is under license.

Radiation Exposure Statement

This equipment complies with FCC radiation exposure limits set forth for an uncontrolled environment. This equipment should be installed and operated with minimum distance 20cm (7.87inch) between the radiator and your body.

NOTE

This equipment has been tested and found to comply with the limits for a Class B digital device, pursuant to Part 15 of the FCC Rules. These limits are designed to provide reasonable protection against harmful interference in a residential installation. This equipment generates, uses and can radiate radio frequency energy and, if not installed and used in accordance with the instructions, may cause harmful interference to radio communications. However, there is no guarantee that interference will not occur in a particular installation. If this equipment does cause harmful interference to radio or television reception, which can be determined by turning the equipment off and on, the user is encouraged to try to correct the interference by one or more of the following measures:

- Reorient or relocate the receiving antenna.
- Increase the separation between the equipment and receiver.
- Connect the equipment into an outlet on a circuit different from that to which the receiver is connected.
- Consult the dealer or an experienced radio/TV technician for help.

CAUTION

Changes or modifications not expressly approved by the party responsible for compliance could void the user's authority to operate the equipment.