

vtech®

Instruction Manual

SUPER SOUND KARAOKE



INTRODUCTION

Bring the party wherever you go! This portable **Bluetooth®** speaker is a must for parties, with its included microphone (2 metre cable) you can get the karaoke party going! The multicoloured party light adds to the atmosphere, as well as controls to adjust volume, echo, and even your voice with voice changing effects! Warm up your singing voice with the built-in vocal warm up activity! Reduce/remove the vocal track of your songs at the push of a button!

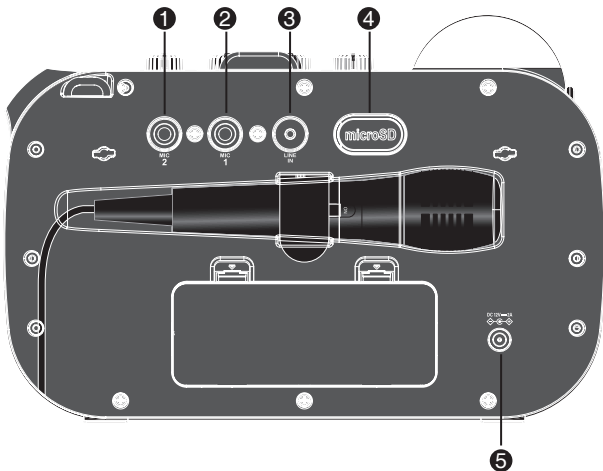

- 1 microSD Card Slot
- 3 Mic 2 Jack
- 5 AC Adaptor Jack





- 2 Mic 1 Jack
- 4 Line-in Jack

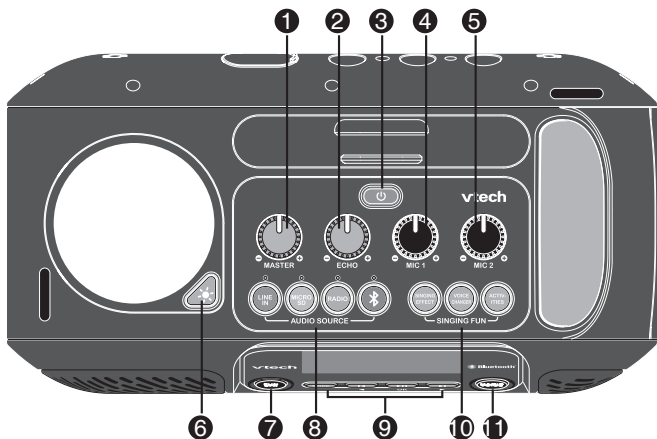

- 1 Master Volume Dial
- 3 Power Button 
- 5 Mic 2 Volume Dial

- 2 Echo Dial
- 4 Mic 1 Volume Dial





- 6 Party Light On/Off Button 

- 8 Line-in Button 
- microSD Button 
- Radio Button 
- Bluetooth® Button 

- 10 Singing Effect Button 
- Voice Changer Button 
- Activities Button 

- 7 SFX Button 

- 9 Mode Button 
- Back Button 
- Play/Pause/OK Button 
- Next Button 

- 11 Voice Magic Button 

INCLUDED IN THE PACKAGE

- One VTech® Super Sound Karaoke
- Quick Start Guide

WARNING:

All packing materials such as tape, plastic sheets, packaging locks, removable tags, cable ties, cords and packaging screws are not part of this toy, and should be discarded for your child's safety.

NOTE:

Please save this Instruction Manual as it contains important information.

ATTENTION :

Pour la sécurité de votre enfant, débarrassez-vous de tous les produits d'emballage tels que rubans adhésifs, feuilles de plastique, attaches, étiquettes, cordons et vis d'emballage. Ils ne font pas partie du jouet.

NOTE :

Il est conseillé de sauvegarder ce manuel d'utilisation car il comporte des informations importantes.

Unlock the Packaging Locks

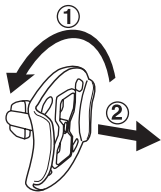

- ① Rotate the packaging locks 90 degrees counterclockwise.
- ② Pull out the packaging locks.

GETTING STARTED

Note:

This product is in Try-me mode in the packaging. Plug the Microphone into any Mic Jack to exit Try-me mode.

BATTERY REMOVAL AND INSTALLATION

1. Make sure the unit is turned **OFF**.
2. Locate the battery cover on the back of the unit.
3. Remove old batteries by pulling up on one end of each battery.
4. Install 6 new AA (LR6/AM-3) batteries following the diagram inside the battery box. (The use of new alkaline batteries is recommended for maximum performance).
5. Replace the battery cover.

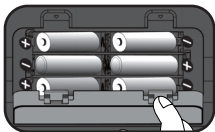

WARNING:

Adult assembly required for battery installation.
Keep batteries out of reach of children.



ATTENTION :

Les piles ou accumulateurs doivent être installés par un adulte.
Tenir les piles ou accumulateurs hors de portée des enfants.

IMPORTANT: BATTERY INFORMATION

- Insert batteries with the correct polarity (+ and -).
- Do not mix old and new batteries.
- Do not mix alkaline, standard (carbon-zinc) or rechargeable batteries.
- Only batteries of the same or equivalent type as recommended are to be used.
- Do not short-circuit the supply terminals.
- Remove batteries during long periods of non-use.
- Remove exhausted batteries from the toy.
- Dispose of batteries safely. Do not dispose of batteries in fire.

RECHARGEABLE BATTERIES:

- Remove rechargeable batteries from the toy before charging.
- Rechargeable batteries are only to be charged under adult supervision.
- Do not charge non-rechargeable batteries.

POWER ADAPTOR CONNECTION

- Make sure your Super Sound Karaoke is turned off.
- Locate the AC Adaptor Jack on the back of the unit.
- Connect an AC Adaptor (not included) to the AC Adaptor Jack.
- Plug the adaptor into a power outlet.
- Press the Power Button to turn the system on.

Note: When the unit is not going to be used for an extended period of time, unplug the adaptor.

Safety information:

We recommend using a power supply (AC/DC adaptor) of the below specification: Power rating: 12V/2A DC output with 3.5mm plug (positive centre).

- Never clean a plugged in product with liquid.

- Please examine the power supply periodically for conditions that may result in the risk of fire, electric shock, or injury to persons (such as damage to the supply cord, output cord, plug, blades, housing, or other parts) and that, in the event of such conditions, the power supply should be scrapped.

PRODUCT FEATURES

1. Power Button

Press the **Power Button** to turn the unit **ON**. Press it again to turn the unit **OFF**.

2. Line-in Jack

Connect an external music player here using a 3.5mm jack audio cable (cable and music player not included).

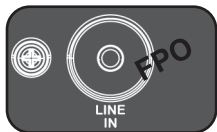

3. microSD Card Slot

Insert a microSD card in this slot and push gently until you hear a click sound (microSD card not included).



4. AC Adaptor

Connect the Super Sound Karaoke to AC power (adaptor not included).



5. Mic 1 and Mic 2 Jack

Plug a Microphone into the jack to connect (only one Microphone included).

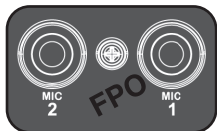

6. Party Light On/Off Button

Press this button to switch the **Party Light ON/OFF**.

BUTTONS AND FEATURES

1. Volume Control

Master Volume Dial, Mic 1/Mic 2 Dial, Echo Dial:

Turn clockwise to increase the volume, anticlockwise to decrease.

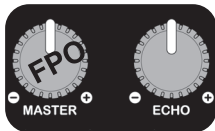

2. Line-in Button

Press this button to listen to the Music from your connected external music player.

Note: All playback controls (including play/pause, back, next) can only be controlled by the external music player.

The “Voice Magic” feature is unavailable for Line-in.

3. microSD Button

Press this button to listen to music from the microSD card in (MP3 file format).

Press the Mode Button to “shuffle” or “repeat” the music.

4. Radio Button

Press this button to listen to FM radio.

Change the station by pressing the Back or Next Buttons.

If the signal is weak, please try another station or move Super Sound Karaoke to a different area.

5. Bluetooth® Button

Press this button to hear Music from the **Bluetooth®** connected device.

Select “VTech Super Sound Karaoke” from your



Bluetooth® device, then input the PIN displayed on your Super Sound Karaoke. Press the Mode, Back or Next Buttons if you would like to turn the PIN off.



If there are any connection problems, please reset the **Bluetooth®** settings on your device.

6. Singing Effect Button



Press to apply special effects to your voice.



7. Voice Changer Button



Press this button to apply 1 of 4 voice changing effects to your voice.

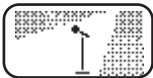

8. Activities Button



Press the Activities Button to enter the Activities menu.

Use the Left/Right Buttons to select an activity, press the OK Button to confirm.

Activity 1: Singing Warm Up

First, listen to the built-in instructor's guide voice, and then repeat. You can press the Back/Next Button to select a different scale. Press the Mode Button if you would like to quit the activity.

Activity 2: Sing As You Like

Select the Background Music you would like, and then sing along to it.

Activity 3: Singing Concert

Sing and hear an audience cheer you on!

9. SFX Button



Press this button to play a random fun sound effect.

10. Mode Button

When playing music from a microSD card, press this button to toggle shuffle and repeat functions.

Press this button during other activities to quit the activity.

11. Back Button, Play/Pause/OK Button and Next Button



Press these buttons to select and control songs and activities.

12. Voice Magic Button

Press this button to reduce or remove the main vocal track of the song you're listening to.

Note: This feature is not available during Line-in mode.

This feature may not work with every song, but works best for studio recorded songs.

CARE & MAINTENANCE

1. Keep the unit clean by wiping it with a slightly damp cloth.
2. Keep the unit out of direct sunlight and away from any direct heat sources.
3. Remove the batteries if the unit will not be in use for an extended period of time.
4. Do not drop the unit on hard surfaces and do not expose the unit to moisture or water.

TROUBLESHOOTING

If for some reason the unit stops working or malfunctions, please follow these steps:

1. Turn the unit **Off**.
2. Interrupt the power supply by removing the batteries.
3. Let the unit stand for a few minutes, then replace the batteries.
4. Turn the unit back **On**. The unit should now be ready to use again.
5. If the unit still does not work, insert a new set of batteries

IMPORTANT NOTE

If the problem persists, please call our **Consumer Services Department** at **1-800-521-2010** in the U.S., **1-877-352-8697** in Canada, or visit our website **vtechkids.com** and fill out our **Contact Us** form located under the **Customer Support** link. Creating and developing VTech products is accompanied by a responsibility that we take very seriously. We make every effort to ensure the accuracy of the information, which forms the value of our products. However, errors sometimes can occur. It is important for you to know that we stand behind our products and encourage you to contact us with any problems and/or suggestions you might have. A service representative will be happy to help you.

NOTE

This equipment has been tested and found to comply with the limits for a Class B digital device, pursuant to Part 15 of the FCC Rules. These limits are designed to provide reasonable protection against harmful interference in a residential installation. This equipment generates, uses and can radiate radio frequency energy and, if not installed and used in accordance with the instructions, may cause harmful interference to radio communications. However, there is no guarantee that interference will not occur in a particular installation. If this equipment does cause harmful interference to radio or television reception, which can be determined by turning the equipment off and on, the user is encouraged to try to correct the interference by one or more of the following measures:

- Reorient or relocate the receiving antenna.
- Increase the separation between the equipment and receiver.
- Connect the equipment into an outlet on a circuit different from that to which the receiver is connected.
- Consult the dealer or an experienced radio/TV technician for help.

CAUTION

Changes or modifications not expressly approved by the party responsible for compliance could void the user's authority to operate the equipment.

Supplier's Declaration of Conformity 47 CFR § 2.1077 Compliance Information

Trade Name: VTech®
Model: 5474
Product Name: Super Sound Karaoke
Responsible Party: VTech Electronics North America, L.L.C.
Address: 1156 W. Shure Drive, Suite 200
Arlington Heights, IL 60004
Website: vtechkids.com

THIS DEVICE COMPLIES WITH PART 15 OF THE FCC RULES. OPERATION IS SUBJECT TO THE FOLLOWING TWO CONDITIONS: (1) THIS DEVICE MAY NOT CAUSE HARMFUL INTERFERENCE, AND (2) THIS DEVICE MUST ACCEPT ANY INTERFERENCE RECEIVED, INCLUDING INTERFERENCE THAT MAY CAUSE UNDESIRE OPERATION.

FCC STATEMENT

This device contains licence-exempt transmitter(s)/receiver(s) that comply with Innovation, Science and Economic Development Canada's licence-exempt RSS(s). Operation is subject to the following two conditions:

- (1) This device may not cause interference.
- (2) This device must accept any interference, including interference that may cause undesired operation of the device.

L'émetteur/récepteur exempt de licence contenu dans le présent appareil est conforme aux CNR d'Innovation, Sciences et Développement économique Canada applicables aux appareils radio exempts de licence. L'exploitation est autorisée aux deux conditions suivantes :

- (1) L'appareil ne doit pas produire de brouillage;
- (2) L'appareil doit accepter tout brouillage radioélectrique subi, même si le brouillage est susceptible d'en compromettre le fonctionnement.

Radiation Exposure Statement

This equipment complies with FCC/IC radiation exposure limits set forth for an uncontrolled environment. This equipment should be installed and operated with minimum distance 20cm between the radiator & your body.

Bluetooth Statement

The Bluetooth® word mark and logos are registered trademarks owned by the Bluetooth SIG, Inc. and any use of such marks by VTech is under license. Other trademarks and trade names are those of their respective owners.

**Visit our website for more
information about our products,
downloads, resources and more.**

www.vtech.co.uk
www.vtech.com.au

