

H302W

10-Zone Wirefree Alarm System

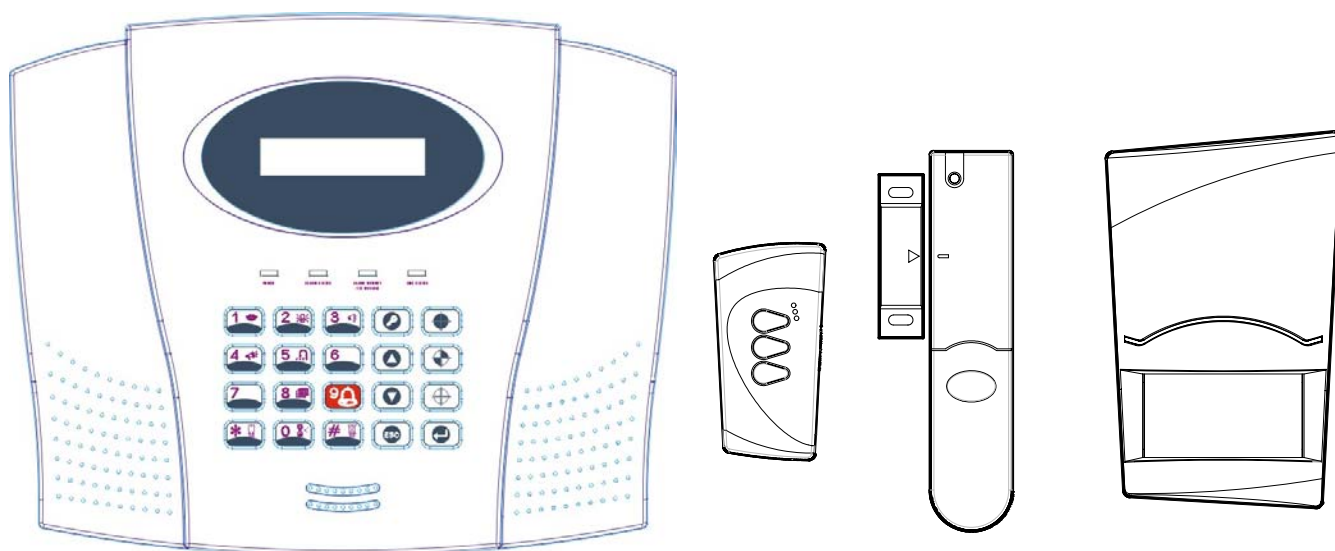

Installation & Operating Manual



CONTENTS

KIT CONTENTS	1	EXTERNAL CONNECTIONS	14
INTRODUCTION AND OVERVIEW	2	TESTING THE SYSTEM	15
Multiple Users	2	Initial Testing	15
System Arming	2	Testing an Installed System	15
Zones	2	DEFAULT SETTINGS	16
Entry/Exit Delay	2	Reset Factory Default	17
Quick Set	2	PROGRAMMING	18
Final Exit Set Zone	2	User Setup	18
Walk Through Zone	2	System Setup	20
Omit Zone	3	Zone Setup	23
Zone Lockout	3	Voice Dialer Setup	25
Event Log	3	Arm Status Setup	28
Chime	3	Part-Arm 1 Setup	29
Voice Dialer	3	Part-Arm 2 Setup	29
Digital Dialer	3	Latch Key Setup	30
Latch-Key	3	Home Control Setup	31
Answer-Phone	3	Answer Phone Setup	33
Voice Memo	3	Digital Dialer Setup	33
Remote System Control	3	OPERATION INSTRUCTIONS	36
Tamper Protection	4	Operating Instructions	36
Jamming Detection	4	Arm	36
Battery Monitoring	4	Part-Arm 1	36
System House Code	4	Part-Arm 2	36
PLANNING AND EXTENDING YOUR		Disarm	36
WIREFREE ALARM SYSTEM	5	Quick Set	37
REMOTE CONTROL UNIT	6	Omit Zone	37
General Information	6	Panic Alarm	37
Setting the Remote Control	6	Tamper	37
CONTROL PANEL	6	Chime	37
Locating the Control Panel	6	Event-Log	37
Mounting the Control Panel	7	Voice Memo	38
Setting the Control Panel	8	Replay Messages	38
Testing the Control Panel & Remote Control	8	Remote System Control	38
PASSIVE INFRA-RED DETECTORS	9	Connection to Home Automation Modules	39
Choosing a Mounting Location	9	Battery Monitoring	39
Installing the PIR Detectors	10	MAINTENANCE	40
Setting the PIR Detectors	10	ALARM RECORD	41
Testing the PIR Detectors	11	TROUBLESHOOTING	42
MAGNETIC CONTACT DETECTORS	11	DIGITAL DIALER TRANSMISSION	43
Choosing a Mounting Location	12	PROTOCOL	
Installing the Magnetic Contact Detectors	12		
Setting the Magnetic Contact Detectors	13		
Testing the Magnetic Contact Detectors	13		

KIT CONTENTS

The Alarm System should contain the following components.

1 x LCD Control Panel

1 x PIR Detector

1 x Magnetic Contact Detector

1 x Remote Control

Also included:

Power Supply Adaptor

Telephone Connection Lead

Installation & Operating Manual

Fixing pack

Batteries

2 x 6V/1.2Ahr Sealed lead acid battery

1 x 9V PP3 Alkaline battery

3 x 3V CR2032 Lithium

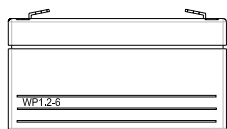

6V/1.2Ahr
Sealed lead acid battery
(for Control Panel)



9V PP3 Alkaline
battery
(for PIR Detector)



3V CR2032
Lithium Cell
(for Remote Control
and Magnetic Contact
Sets)

IMPORTANT

Please check all items as mentioned above are included in the package.

COMMON ACCESSORIES FOR CONTROL PANELS

The following accessories are compatible with a series of Everspring's alarm systems as below:

Control Unit	Compatible Accessories
H302W, H302Y, HA65U	H302P PIR Detector H302R Remote Control H202M Magnetic Contact Detector

H302Q LCD Control Panel

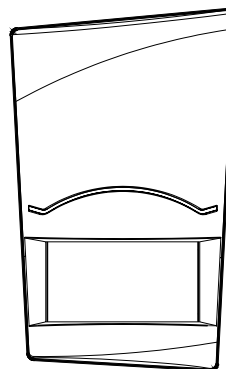

H302P PIR Detector

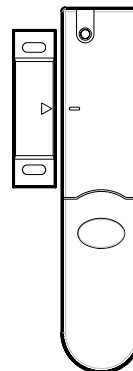

H202M Magnetic Contact Detector

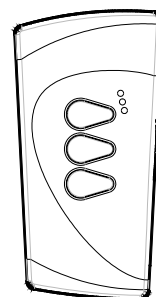

H302R Remote Control

INTRODUCTION AND OVERVIEW



MULTIPLE USERS

The system allows for up to 6 Users and a Master User to be configured. This allows the system Event Log to maintain a record of which users have armed and disarmed the system. Each user will have a different Password. In addition a 4 second voice recorder facility enables the users name to be recorded for use with the Latch-Key facility.

Only the Master User has access to the programming functions and is able to configure the system.

Note: Any Remote Control Units on the system will be recorded as User 6.

SYSTEM ARMING

The system has a full 'Arm' and two 'Part-Arm' modes. ARM will 'Arm' all zones while the 'Part-Arm' modes will only arm the zones that are enabled for the particular part-arm mode.

For example:

The system could be configured such that during night time, 'Part-Arm 1' would arm only zones protecting the lower floor and outbuildings leaving the upper floor free for movement without triggering the alarm.

During the day while the property is occupied 'Part-Arm 2' would arm only the zones protecting the outbuildings. However, when the property is left un-occupied, the full 'Arm' mode will arm all zones to protect the entire property, (i.e. upper and lower floors and outbuildings).

ZONES

The system incorporates 6 wireless Alarm Zones for the connection of the system detectors that are used to independently monitor different areas of the property. In addition to standard intruder protection, each zone may also be configured to operate in one of four other modes:

- 'PANIC/PA' mode provides 24 hour monitoring of any Personal Attack (PA) switches incorporated into the system.
- '24-hour Intruder' mode provides 24 hour intruder protection for areas/zones where continuous monitoring is required, (e.g. gun lockers).
- 'Fire' mode provides 24 hour monitoring of any Fire/Smoke detectors incorporated into the system.
- 'Test' mode allows a zone to be monitored while the system is armed. If a detector on a test zone is

triggered an entry will be recorded in the Event Log but an alarm will not occur.

In addition there is the facility to connect 4 hard wired zones to the Control Panel, each of which is fully configurable with the same features as the wirefree zones (1-6).

ENTRY/EXIT DELAY

When the system is armed with the Exit-Delay enabled, no alarm signal from any detector on an active zone will be able to initiate an alarm until the Exit-Delay has expired. This enables the system to be armed from within the property and allows time for the user to exit the property without triggering an alarm. If the Exit-Delay is disabled then detectors on active zones will immediately be able to initiate an alarm as soon as the system begins to arm.

The system Exit-Delay may be configured for between 10 to 250 seconds or disabled completely.

If a detector on a zone with its Entry-Delay enabled is triggered, then an alarm condition will not occur until the Entry-Delay period has expired. This allows time for the user to re-enter the property and disarm the system before an alarm condition occurs. Generally only the zones on the main entry route to the property will be configured with an Entry-Delay. The remaining zones would be configured with their Entry-Delay disabled allowing them to immediately initiate an alarm a detector on the zone is triggered.

The Entry-Delay for each zone may be configured for between 10 to 250 seconds or disabled completely.

QUICK SET

The system may be fully armed in 5 seconds using the quick set facility, overriding the programmed exit-delay. This is useful for setting the system at night when the exit-delay warning beep will be silenced after just a few seconds.

FINAL EXIT SET ZONE

Triggering a detector on a Final Exit zone during the exit-delay will cause the delay to reset to 5 seconds with the system arming 5 seconds later.

WALK THROUGH ZONE

This feature may be used for detectors located on the main entry route to the Control Panel. When the system is armed and a zone configured as a 'Master Walk Through' zone is triggered, the zones Entry-Delay will start. Any zones configured as 'Slave Walk

Through' will be disabled to allow free access to the

Control Panel to disarm the system before the entry-delay expires an alarm occurs.

If access is gained via a zone that is not configured as 'Master Walk Through', the 'Slave Walk Through' zones will operate as normal according to their programmed Entry-Delay setting.

Note: A zone set as a 'Master Walk Through' zone must be configured with an Entry-Delay.

OMIT ZONE

A zone may be temporarily omitted when the system is armed using the Omit feature. When the system is next disarmed any zones set to Omit will be cancelled.

ZONE LOCKOUT

If a detector on an active zone is triggered while the system is armed an alarm condition will occur. After the programmed alarm duration has expired the alarm will stop and the system will automatically reset. Subsequent detectors triggered will again initiate an alarm condition. If a single zone initiates an alarm condition more than three times then that zone will be 'Locked Out' and any further alarm signals from that zone will be ignored until the system is disarmed.

Note: The 'Zone Lockout' feature can be disabled if required.

EVENT LOG

The Control Panel incorporates a memory capable of storing the last 50 system events. This enables the user to see which user has Armed/Disarmed the system and if and when any alarms occurred. The time, date and details of the event type will be recorded for each system event.

CHIME

Chime is a low security facility for use when the system is Standby mode. If the Chime feature is ON, and a detector on a zone that has its Chime function enabled is triggered, the internal sounder will produce a low volume warning tone. A typical use of the Chime function would be to warn that a door or particular area has been accessed.

VOICE DIALER

If the Voice Dialer is enabled and an alarm condition occurs, the system will call for help using your recorded alarm messages and up to four telephone numbers.

When an alarm condition occurs, the telephone voice dialer (if enabled) will call the first enabled number in

the calling sequence and replay the recorded alarm

messages for the configured 'Play Time'. The recipient must acknowledge the message by pressing the  button on their telephone keypad. If the call is unanswered or an acknowledgment is not received then the next active number in the dialing sequence will be called. The dialer will continue calling each number in turn until either all numbers in the sequence have been dialed the set number of times or the sequence is cancelled/acknowledged by the recipient.

DIGITAL DIALER

As an alternative to the Voice dialer the system may be configured to interface with a central monitoring station.

LATCH KEY

When the system is disarmed the Latch-Key facility, if enabled, will call the first latchkey phone number and replay the user message (recorded under user setup) for the set 'Play Time'. The recipient must acknowledge the message by pressing the  button on the telephone keypad. If the call is unanswered or an acknowledgment is not received then the second latchkey phone number will be called. The voice dialer will continue calling each number in turn until each number has been dialed the set number of times or the sequence is cancelled/acknowledged by the recipient.

For example, the latchkey facility is useful to inform parents that a child has returned from school and disarmed the system.

ANSWER PHONE

The Control Panel includes an answer-phone facility. The answer phone will record and store a maximum of 6 messages with each message being limited to a 30s duration.

Messages may be retrieved either direct from the Control Panel or by dialing into the system from a phone.

VOICE MEMO

In addition it is also possible to record messages at the Control Panel using the 'Voice-Memo' facility. Each voice-memo message is limited to a maximum duration of 30s and counts as an answer phone message.

REMOTE SYSTEM CONTROL

It is possible to dial into the system via the connected telephone line to interrogate the system status and to have basic control over the system, (e.g. to Arm and Disarm the system). You may also activate the microphone on the control panel to Listen-In to what is happening in the protected property.

Answer phone and Voice-memo messages may also be accessed remotely.

TAMPER PROTECTION

All system devices (except the Remote Control Units) incorporate Tamper protection features to protect against unauthorized attempts to interfere with the device. Any attempt to remove the battery covers from any device (except the Remote Control) or to remove the Solar Siren or Control Panel from the wall will initiate an alarm condition (unless the system is in Test or Programming modes), even if the system is Disarmed.

JAMMING DETECTION

In order to detect any attempts to illegally jam the radio channel used by your alarm system, a special jamming detection function is incorporated into the Control Panel and Solar Siren. If this feature is enabled, and the radio channel is jammed continuously for 30 seconds, when the system is armed, the Solar Siren will emit a pre-alarm series of rapid bleeps for 5 seconds. If the jamming continues for a further 10 seconds or more a full alarm condition will occur. In addition if the system is jammed for more than three periods of 10 seconds in a 5 minute interval, this will also generate a Full Alarm condition.

The jamming detection features in the Control Panel and Solar Siren operate independently.

The Jamming Detection circuit is designed to permanently scan for jamming signals. However, it is possible that it may detect other local radio interference operating legally or illegally on the same frequency. If it is planned to operate the jamming detection feature we recommend that the system is monitored for false jamming alarms for at least 2 weeks prior to leaving the Jamming Detection function permanently enabled.

BATTERY MONITORING

In addition to the battery monitor and low-battery indicators in each device, the Control Panel will also indicate a low battery status within any Passive Infra-Red or Magnetic Contact Detector on the system using the Event log.

SYSTEM HOUSE CODE

In order to prevent any unauthorized attempt to operate or disarm your system, you must configure your system to accept radio signals only from your own system devices. This is done by setting a series of eight

Control Panel) to the same ON/OFF combination (the House Code) selected by the user/installer. The Control Panel is then programmed to operate only with devices set to this House Code. All detectors and Remote Control Unit(s) must be configured with the same House Code in order for the system to operate

In
a



e.g.  Switch 1 set to the ON position

The House Code is set up by moving each of the 8 switches in each device to the same randomly selected ON/OFF sequence. When setting the DIP switches, ensure that each switch 'clicks' fully into position. Use the tip of a ballpoint pen or a small screwdriver to move each switch in turn.

Note: it is recommended that the system House Code is always reset to a code other than the factory default.

WIREFREE ALARM SYSTEM

The following example below shows a typical property incorporating the suggested positions for the Control

Panel, PIR and Magnetic Detectors for optimum security. Use this as a guide for your installation in conjunction with the recommendations contained in this manual for planning your intruder alarm system.

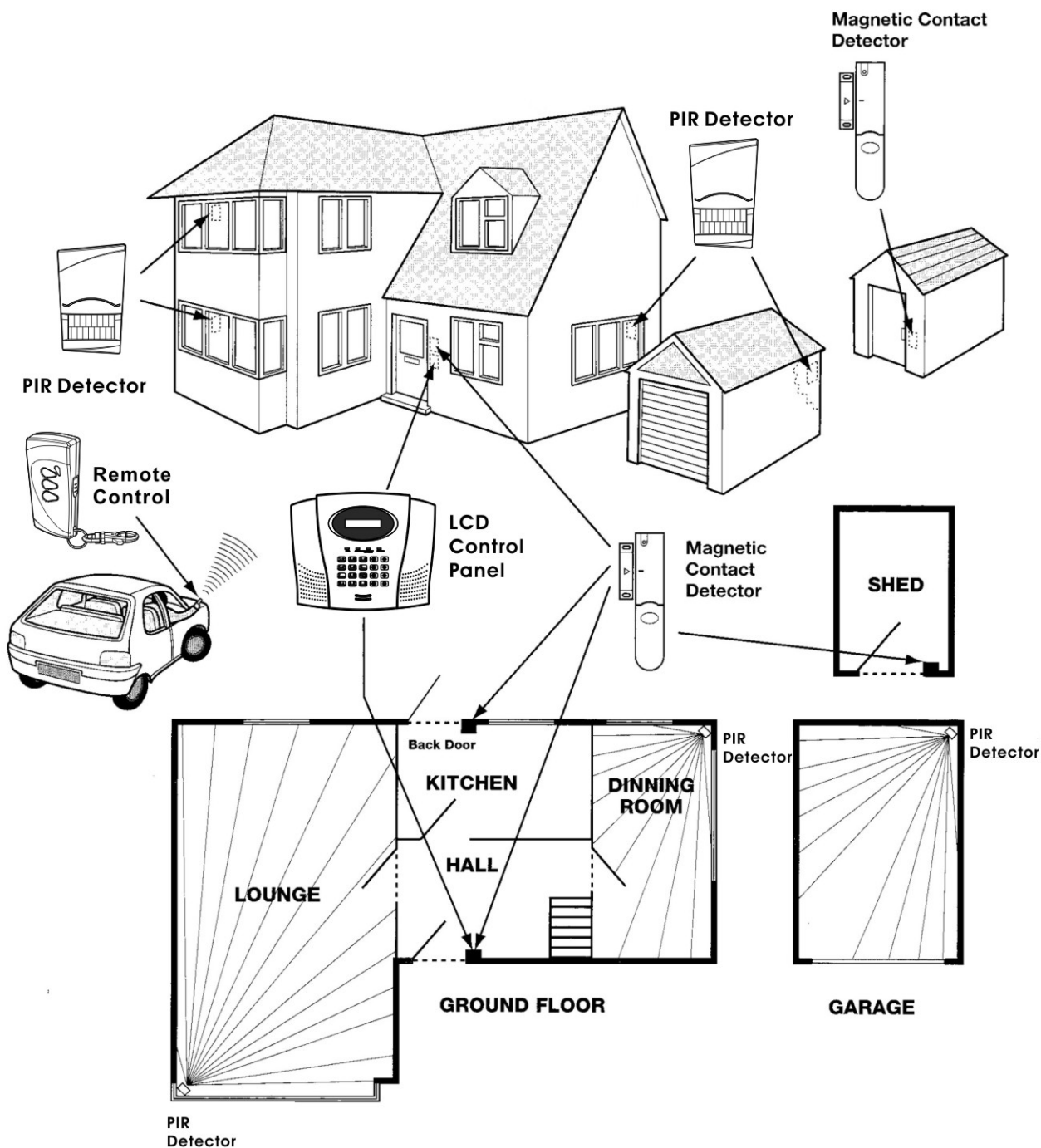

Before attempting to install your Alarm System it is important to study your security requirements and plan your installation.

The alarm system may be extended to provide even greater protection by fitting additional PIR Detectors and Magnetic Contact Detectors as required.

REMOTE CONTROL UNIT

The Remote Control Unit is used to Arm, Part-Arm and Disarm the system.

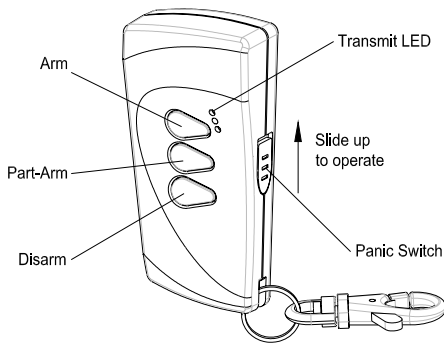

The Remote Control Unit also incorporates a Panic switch. Activating the Panic switch on the side of the Remote Control will immediately initiate a Full Alarm condition whether the system is Armed or Disarmed. The alarm can be cancelled by pressing the 'DISARM' button on the Remote Control or via the Control Panel.

Any number of Remote Control Units can be used with your system, providing they are all coded with the same system House Code.

The Remote Control adopts a CR2032 type Lithium cell which under normal conditions will have typical life in excess of 1 year. Under normal battery conditions the LED on the Remote control will only illuminate when a button is pressed. However, under low-battery conditions this LED will flash every time the button is pressed. When this occurs the batteries should be replaced as soon as possible.

SETTING THE REMOTE CONTROL

1. Remove the rear cover by undoing the small screw on the rear of the Remote Control.
2. Located above the battery cover is a row of 8 DIP switches. Select and record a random combination of 'ON' and 'OFF' positions for the DIP switches. This will be the system House Code that enables all elements of your transmitters to communicate with the Control Panel.

IMPORTANT: The House Code for your system should be changed from the factory default setting.

3. Ensure that the jumper link located immediately below the House Code DIP switches is fitted in position for use with this alarm system.

4. Insert the battery under the clip ensuring that the +v terminal faces upwards away from the PCB.
5. Replace the rear cover and fixing screw.

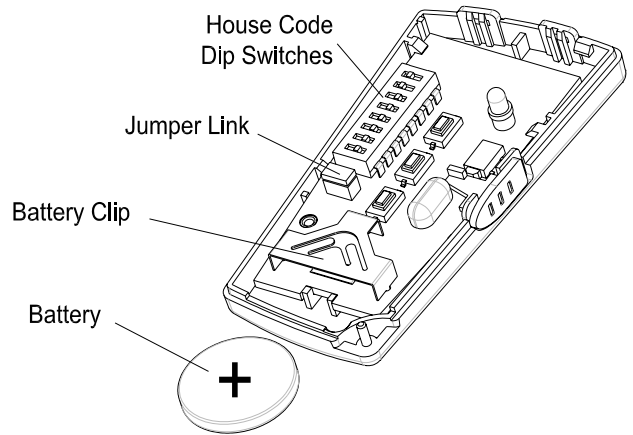

CONTROL PANEL

LOCATING THE CONTROL PANEL

When choosing a suitable location for the Control Panel, the following points should be considered.

1. The Control Panel should be located in a position out of sight of potential intruders and in a safe location, but easily accessible for system operation.
2. The Control Panel should be mounted on a sound flat surface to ensure that the rear tamper switch on the Control Panel is closed when the Panel is mounted. The Control Panel should be mounted at a convenient height of between 1.5 and 2m and in a position where it will be seen each day.

Note: If small children are in the household, a further consideration should be given to keeping the units out of their reach.

3. It is recommended that the Control Panel should be positioned such that the Exit/Entry tone (emitted by the Control Panel) can be heard from outside the property.
4. The Control Panel should be mounted within a protected area so that any intruder cannot reach the Control Panel without opening a protected door or passing through an area protected by a PIR detector when the system is armed.
5. The Control Panel must be located within reach of a mains socket.

- If the telephone based functionality is to be used then the Control Panel will need connecting to a convenient telephone point.

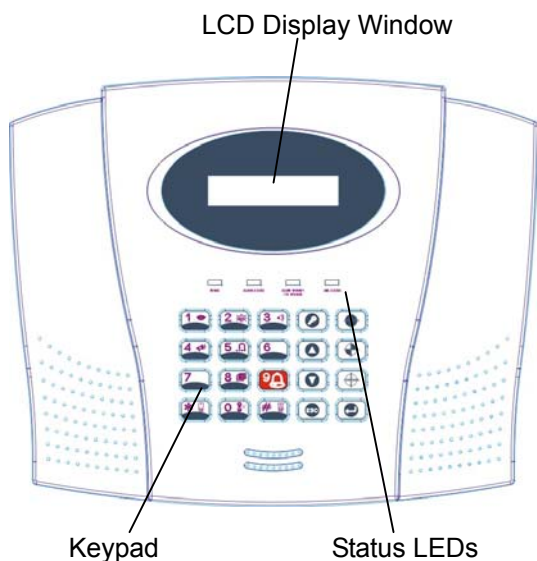

LCD Control Panel – Keypad and LED Layout

Note: It is recommended that the telephone connection lead is not extended beyond 5m before connecting to a telephone master or secondary outlet.

- Do not locate the Control Unit closer than 1m to any large metallic object, (e.g. mirrors, radiators, etc) as this may affect the radio range of the Control Panel.

MOUNTING THE CONTROL PANEL

- Undo the two captive fixing screws on top of the panel and open the cover. The cover is hinged along the bottom edge.
- Unclip and remove the two back-up batteries on either side of the panel.
- Hold the Control Panel in position on the wall and mark the positions of the four fixing holes. Remove the Panel and drill four 5mm holes and fit the 25mm Wall Plugs.

IMPORTANT: Do not drill the fixing holes with the Control Panel in position; as the resulting dust and vibration may damage the Control Panel's internal components and invalidate the guarantee.

- Fit two 18mm No.4 screws into the top holes until almost fully home and hang the Control Panel over these screws using the two keyhole slots in the top corners of the panel casing.

- Route the cable from the Power Supply Unit up behind and on the right hand side of the Control Panel and connect the plug to the DC power socket in the panel. Ensuring that the cable is not trapped between the panel and the wall.

- Fix the Panel to the wall using two 18mm No. 4 screws in the lower two fixing holes in the panel and tighten the upper fixing screws until they just grip the casing. Do not over tighten the fixing screws as this could damage or distort the casing.

- Ensure that the 'Reset' and the 'Hard-Wired Siren tamper detect' jumper links are set in the OFF position.

- Connect battery leads to both back-up batteries and refit batteries.

Battery 1 (left): Red lead to +ve battery terminal

Blue lead to –ve battery terminal

Battery 2 (right): Blue lead to +ve battery terminal

Black lead to –ve battery terminal

IMPORTANT: Take care when connecting battery leads to the batteries as connecting incorrectly could damage the batteries or the Control Panel.

Note: The Power LED may flash to indicate that the unit is being operated from the back-up batteries and that mains supply is not present.

- If fitted, remove the plastic film covering the LCD display and on the display window on the cover.

- Close the lid of the Control Panel and tighten the captive fixing screws.

- Plug in and switch ON the Power Supply Unit, (the Power LED should illuminate).

- If required, connect the Control Panel to the telephone line using the cable supplied by inserting small RJ11 plug into socket marked LINE located on the bottom edge of the Control Panel.

If the cable supplied is not long enough to reach a suitable phone point then it will need extending using a coupler and extension lead (not supplied).

Note: If the Panel Tamper alarm sounds during the installation reset the alarm by pressing:



on the Control Panel Keypad.

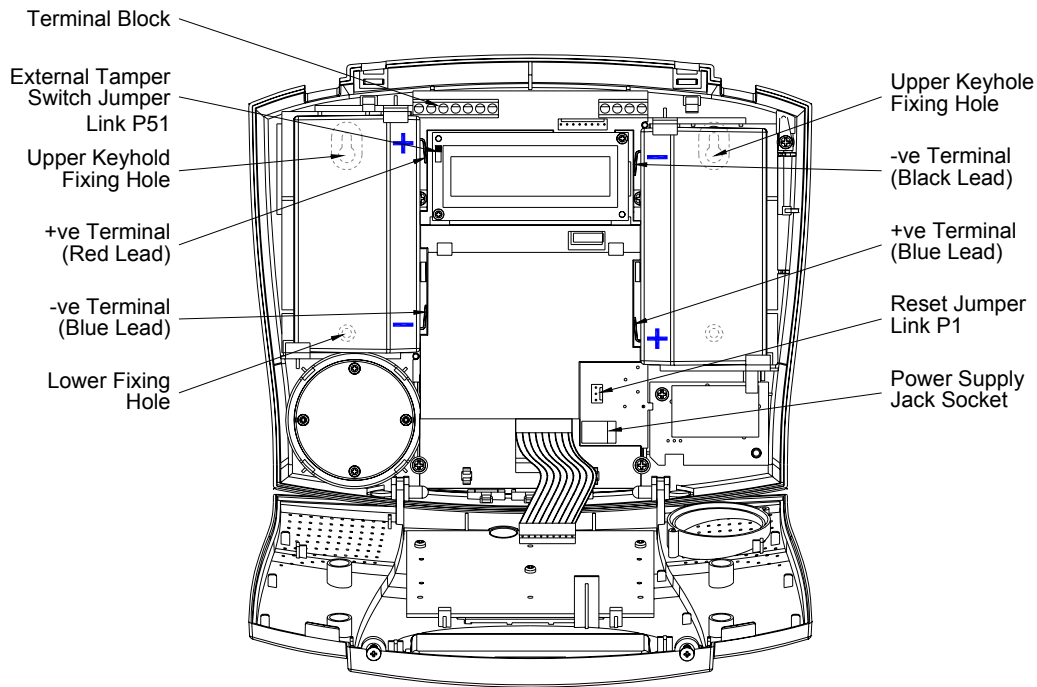

Inside View of Control Panel



SETTING THE CONTROL PANEL HOUSE CODE

With unit in Standby mode (power LED only illuminated).

1. Press



to put the system into Programming mode. '1. USER SETUP' will be displayed.

2. Use the  and  buttons to scroll through the menu until '2. SYSTEM SETUP' is displayed.

Press  and '2-1 Learn House Code' will be displayed.

Press  again to set the Control Panel to receive the House code. 'DIP SW 12345678 & H Code: xxxxxxxx' will be displayed.

3. With the required House Code already configured on the Remote Control, press the  button on the Remote Control.

When the Control Panel receives the signal from the Remote Control the Display will change to show the received house code on lower line of the

display beneath the corresponding DIP switch numbers (1-8).

4. Press , ,  to return to Standby mode.

TESTING THE CONTROL PANEL & REMOTE CONTROL

1. Press



to put the system into Test mode. 'TEST MODE – WALK TEST' will be displayed.

2. Press  to activate Walk Test. 'Walk Test Waiting...' will be displayed.

3. Press the 'ARM' button on the Remote Control. As the key is pressed the Control Panel will beep and the type of the device and button will be shown on the display.

Press the other buttons on the Remote Control in turn, as each button is pressed the Control Panel will beep and show the button being pressed on the display.

4. Test the range of the Remote Control by pressing the 'DISARM' button on the Remote Control from in and around the property and from all locations

where you plan to install detectors. Check that the Control Panel acknowledges the signal from the Remote Control each time the 'DISARM' button is pressed.

- Press  to return to the top level menu of TEST MODE.

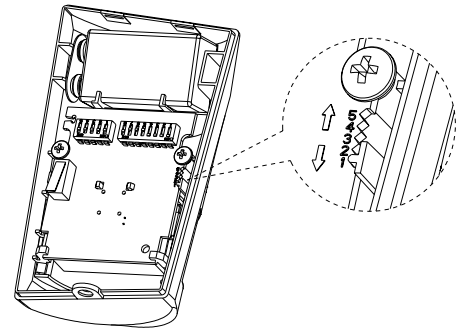

PASSIVE INFRARED DETECTORS

PIR detectors are designed to detect movement in a protected area by detecting changes in infra-red radiation levels caused, for example, when a person moves within or across the devices field of vision. If movement is detected an alarm signal will be emitted, (if the system and alarm zone is armed).

Note: PIR detectors will also detect animals, so ensure that pets are not permitted access to areas fitted with Passive Infra-Red Detectors when the system is armed.

Any number of PIR Detectors can be used with your system, providing they are all coded with the system house code and are mounted within effective radio range of the Control Panel.

The PIR Detector adopts a PP3 Alkaline battery which under normal conditions will have typical life in excess of 2 years. When the battery level drops, with the PIR in normal mode and the battery cover fitted, the LED behind the detection window will flash. When this occurs the batteries should be replaced as soon as possible.

CHOOSING A MOUNTING LOCATION

The recommended position for a PIR Detector is in the corner of a room mounted at a height between 2 and 2.5m. At this height, the detector will have a maximum range of up to 12m with a field of view of 110°. The position of the PCB inside the PIR can be set to 5 different positions to adjust the range of the detector. Setting the PCB in position 3 will reduce the range to 9m approximately, with position 1 providing a range of 6m approximately. The recommended position setting for the PCB is in position 5.

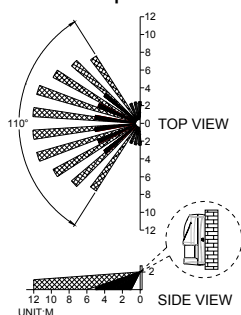

PCB Position	Range
1	6m
3	9m
5	12m

Note: The range as indicated above refers to the linear distance in front of the PIR sensor.

When considering and deciding upon the mounting position for the detector the following points should be considered to ensure trouble free operation:

- Do not locate the detector facing a window or where it is exposed to or facing direct sunlight. PIR Detectors are not suitable for use in conservatories.
- Do not locate the detector where it is exposed to ventilators.
- Do not locate the detector directly above a heat source, (e.g. fire, radiator, boiler, etc).
- Where possible, mount the detector in the corner of the room so that the logical path of an intruder would cut across the fan detection pattern. PIR detectors respond more effectively to movement across the device than to movement directly towards it

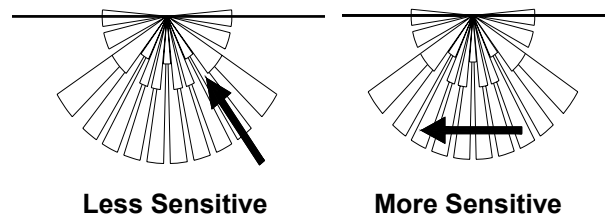

- Do not locate the detector in a position where it is subject to excessive vibration.
- Ensure that the position selected for the PIR detector is within effective range of the Control Panel, (refer to 'Testing the Control Panel & Remote Control').

Note: When the system is armed, household pets should not be allowed into an area protected by a PIR detector as their movement would trigger the PIR and generate an alarm.

Note: DO NOT fix the detector to metalwork or locate the unit within 1m of metalwork (i.e. radiators, water pipes, etc) as this could affect the radio range of the device.

INSTALLING THE PIR DETECTORS

Ensure that the system is in Test Mode.

1. Undo and remove the fixing screw from the bottom edge of the PIR. Carefully pull the bottom edge of the detector away from the rear cover and then slide down to release the top clips.

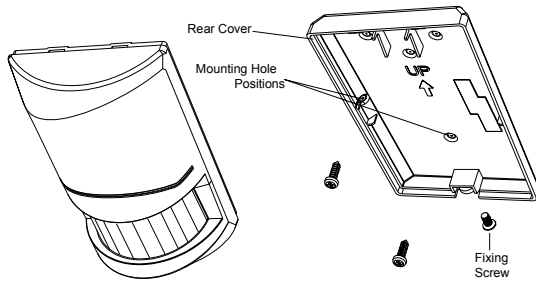

2. Carefully drill out the required mounting holes in the rear cover using a 3mm drill according to whether the unit is being mounted in a corner or against a flat wall.
3. Using the rear cover as a template, mark the positions of the fixing holes on the wall.
4. Fix the rear cover to the wall using the two 18mm No.4 screws and 25mm wall plugs, (a 5mm hole will be required for the wall plugs). Do not over-tighten the fixing screws as this may distort or damage the cover.
5. Configure the PIR detector as described below. Remember that on initial installation that the device needs to be tested and should therefore be set in Walk Test Mode.
6. Check that the detector PCB is located and set in the correct position to give the detection zone pattern required.

To adjust the PCB position, simply slide it up or down ensuring that the location legs are aligned with the required position number marked on the board.

7. To refit the PIR detector to the rear cover, offer the detector up to the rear cover and locate the clips in the top edge into the rear cover. Push the lower edge of the detector into place and refit the fixing screw in the bottom edge of the PIR to secure in position. Do not over-tighten the fixing screws as this may damage the casing.

SETTING THE PIR DETECTORS

Located on the PCB of the PIR Detector are two blocks of DIP switches (SW2 and SW3).

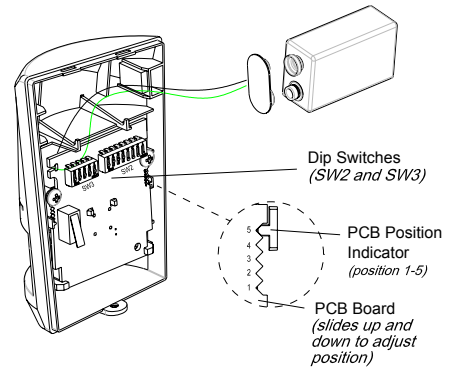

1. DIP switches SW2 (numbered 1-8) are used to set the House Code for the PIR Detector and must be set to the same ON/OFF combination as the House Code DIP switches in all other system devices.
2. Set the alarm zone which the detector will operate on with DIP switches 1-3 of SW3 as follows:

	DIP 1	DIP 2	DIP 3
Zone 1	OFF	OFF	OFF
Zone 2	OFF	OFF	ON
Zone 3	OFF	ON	OFF
Zone 4	OFF	ON	ON
Zone 5	ON	OFF	OFF
Zone 6	ON	OFF	ON

3. DIP 4 of SW3 is used to configure the PIR Detector for walk test mode, which allows the operation of the detector to be checked during installation without triggering a Full Alarm.

ON Walk Test mode
OFF Normal mode

Note: On initial installation the detector should be set into Walk-Test mode ready for testing.

4. The PIR Detector incorporates an anti-false alarm feature designed to compensate for situations

where the detector may be affected by environmental changes, (e.g. insects, air temperature, etc). This feature is called “sensitivity detection” and may be selected for high or low detection.

The recommended setting is for high sensitivity detection. However, in cases of extreme environmental problems or if unattributable false alarms are experienced, it may be necessary to select low sensitivity detection.

Set the required sensitivity detection using DIP 5 of SW3 as follows:

- ON high sensitivity detection
- OFF low sensitivity detection

Note: The higher the sensitivity detection the less movement will be necessary before the PIR detector will trigger the alarm.

5. The setting of the DIP4 & DIP5 of SW3 can be distinguished from the LED indication as follows:

Position of DIP4 & 5 of SW3	DIP4 of SW3	DIP5 of SW3	Trigger reaction of LED
ON	Walk Test mode	High Sensitivity	LED will be on shortly. It implies high sensitivity.
		Low Sensitivity	LED will flash three times and illuminate once. It implies low sensitivity.
OFF	Normal mode	Low Sensitivity	LED does not light up

6. Connect the PP3 Alkaline battery to the battery clip.

Note: When the 9V Alkaline battery is connected, the LED behind the lens will flash for 2-3 minutes until the PIR has warmed-up and stabilized. The LED will then stop flashing and turn OFF.

TESTING THE PIR DETECTORS

Ensure that the system is in Test Mode.

With the PIR detector set in Test mode and mounted in position on the wall, allow 2-3 minutes for the detector to stabilize before commencing the Walk Test.

1. Use the  and  buttons to scroll through the menu until ‘WALK TEST’ is displayed.

Press  to activate Walk Test. ‘Walk Test Waiting...’ will be displayed.

2. Walk into and move slowly around the protected area, each time the detector senses movement the LED behind the lens will flash. In addition, the Control Panel will beep to indicate that the alarm signal has been received and the identity of the zone that the detector is configured for will be displayed.

If necessary adjust the detection range by changing the mounting position of the PCB within the PIR housing.

Note: In normal operation, the LED behind the PIR lens will not flash on movement detection, (unless the battery is low).

If necessary re-adjust the detection pattern by changing the mounting position of the PCB within the PIR housing.

3. Remove the back cover of the PIR detector. The Control Panel should beep and display ‘Accessory Tamper’ to show that the detector’s tamper switch has been activated.

4. Press  to return to the top level menu of TEST MODE.

5. Reconfigure the PIR Detector for normal mode by setting DIP4 of SW3 to OFF and refit in position.

Note: When the detector is fully installed i.e. battery cover is refitted; the unit will not detect movement for approximately 45 seconds after each activation. (This feature is present to conserve battery power and maximize the battery life).

MAGNETIC CONTACT DETECTOR(S)

The Magnetic Contact consists of two parts; a Detector and a Magnet. They are designed to be fitted to either doors or windows with the Magnet mounted on the moving/opening part and the Detector mounted on the fixed door or window frame.

The Magnetic Contact Detector is powered by two CR2032 type Lithium cells which under normal conditions will have typical life in excess of 1 year. Under normal battery conditions the LED on the

Detector will not illuminate when the Detector is triggered, (unless in test mode). However, under low battery conditions this LED will be illuminated for approx. 1 second when the detector is triggered. When this occurs the batteries should be replaced as soon as possible.

The Magnetic Contact Detector has the facility to connect an additional wired Magnetic Contact. This additional contact must be of a normally closed contact type with the contacts being opened in order to generate an alarm condition.

Any number of Magnetic Contact Detectors can be used with the system, providing they are all coded with the system house code and are mounted within effective radio range of the Control Panel.

CHOOSING A MOUNTING LOCATION

The Magnetic Contact Detector is suitable for mounting in dry interior locations only.

Decide which doors/windows are to be protected by fitting Magnetic Contact Detectors, (usually the front and back doors as a minimum will have Magnetic Contact Detectors fitted). Additional detectors may also be fitted where required to other vulnerable doors or windows, (e.g. garage, patio/conservatory doors etc).

Ensure that the position selected for the Magnetic Contact detector is within effective range of the Control Panel, (refer to 'Testing the Control Panel & Remote Control').

Note: Take care when fixing the Detector to a metal frame, or mounting within 1m of metalwork (i.e. radiators, water pipes, etc) as this could affect the radio range of the device. If required, it may be necessary to space the magnet and detector away from the metal surface using a plastic or wooden spacer to achieve the necessary radio range.

INSTALLING THE MAGNETIC CONTACT DETECTORS

Ensure that the system is in Test Mode.

1. Remove the battery cover by sliding and lifting it off. (DO NOT use a screwdriver to lever the cover off)
2. Remove the battery holder by carefully tilting up the end and pulling the connector off of the printed circuit board.

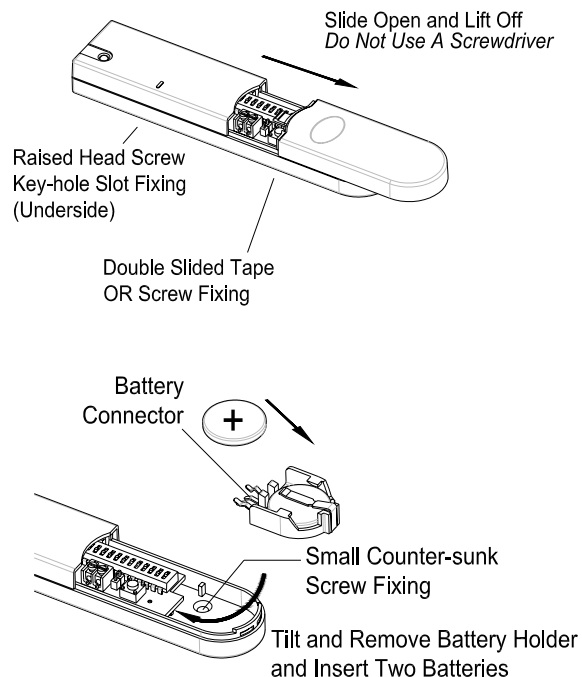

3. Mount the Detector to the fixed part of the frame along the opening edge opposite the hinges using either the double sided adhesive tape or screws provided.

If fixing the Detector with screws; fit the Keyhole slot in the top of the Detector over the head of the smaller pan-head screw. Secure the bottom of the Detector using the 12mm countersunk head screw fitted within the battery compartment. You will need to drill out the centre of the fixing screw hole using a 3mm drill. Do not over-tighten the fixing screws as this may distort or damage the casing.

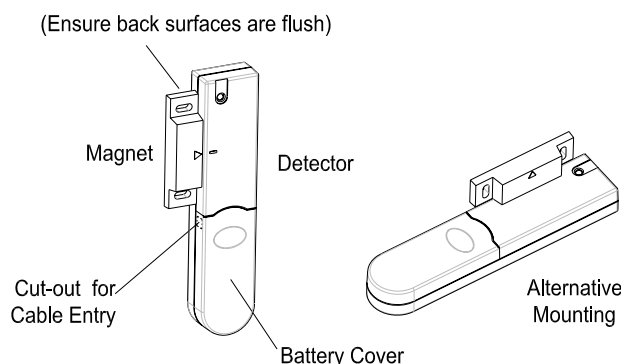

4. Fit the Magnet to the moving part of the door/window opposite the Detector using the adhesive tape or 15mm fixing screws. Ensure that the parallel gap between the Magnet and Detector is less than 10mm and that the arrow on the Magnet is pointing towards and aligned with the mark on the Detector.

- If an additional wired Magnetic Contact is required, this should be wired to the terminal block provided in the battery compartment. The wired contact should be connected using two core (24AWG) wire of maximum length 1.5m.

A cable entry cut-out is provided beside the terminal block in the battery cover.

- Slide the batteries supplied into the battery holder, ensuring that the positive (+) side is uppermost on each battery as it is installed.
- Carefully refit the battery holder onto the Detector ensuring that the spring connectors slide onto either side of the circuit board.
- Refit the battery cover.

SETTING THE MAGNETIC CONTACT DETECTORS

- Located in the battery compartment is a row of 11 DIP switches.
- DIP switches 1-8 are used to set the House Code for the Magnetic Contact Detector and must be set to the same ON/OFF combination as the House Code DIP switches in all other system devices.

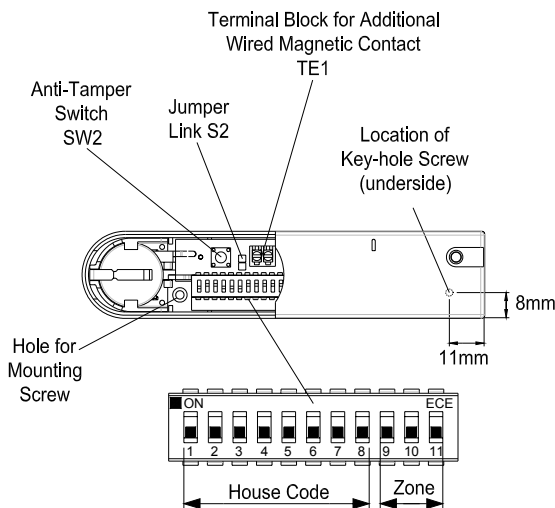

- Configure the alarm zone which the detector will operate on with DIP switches 9-11 as follows:

	DIP 9	DIP 10	DIP 11
Zone 1	OFF	OFF	OFF
Zone 2	OFF	OFF	ON
Zone 3	OFF	ON	OFF
Zone 4	OFF	ON	ON
Zone 5	ON	OFF	OFF
Zone 6	ON	OFF	ON

Note: If the setting of DIP switches 9-11 does not

conform to any of the above mentioned six criteria, the Control Panel cannot receive triggering signal from the magnetic contact detector.

- If additional external contacts are wired to the Detector, remove the jumper link S2 on the PCB.

IMPORTANT: If external contacts are not connected, then jumper link S2 must be fitted for the detector to operate correctly.

TESTING THE MAGNETIC CONTACT DETECTORS

Ensure that the system is in Test Mode

- Use the and buttons to scroll through the menu until 'WALK TEST' is displayed.

Press to activate Walk Test. 'Walk Test Waiting...' will be displayed.

- Remove the battery cover by sliding off.

As the battery cover is removed the LED on the Detector will illuminate for approx. 1 second to indicate that the tamper switch has been activated. In addition, the Control Panel will beep to indicate that an alarm signal has been received and 'Accessory Tamper' will be displayed.

Open the door/window to detach the magnet from the Detector. As the magnet is parted from the detector the LED will illuminate for approx. 1 second to indicate that the Detector has been triggered. In addition, the Control panel will beep to indicate that an alarm signal has been received and the identity of the zone that the detector is set for will be displayed.

Note: In normal mode with the battery cover fitted, the LED on the detector will not illuminate when the detector is triggered, (unless the battery is low).

- If connected, operate the wired Magnetic Contact. As the contact is opened the LED on the Detector should illuminate for 1 second to indicate that it has been triggered and the Control Panel will acknowledge the alarm signal.
- Refit the battery cover on the Detector.
- Press to return to the top level menu of TEST MODE.

EXTERNAL CONNECTIONS

The Control Unit incorporates a terminal block for connection of hard-wired Zones (7-10), Siren or Telephone Dialer unit. The connection terminal block is located inside the Control Panel behind the front cover.

To access the terminal block



this puts the system into Test Mode and prevents an alarm occurring. Undo the two fixing screws on the top edge of the Control Panel and open the front cover.

Before making any connections, ensure that the memory jumper link P1 is in the 'OFF' position and then remove the DC power jack and disconnect one of the back-up batteries.

Control Panel cover and tighten the fixing screws on the top edge of the Control Panel.

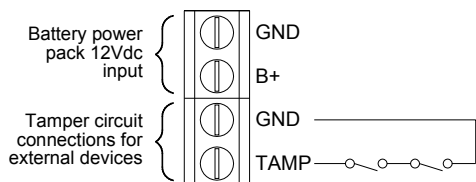
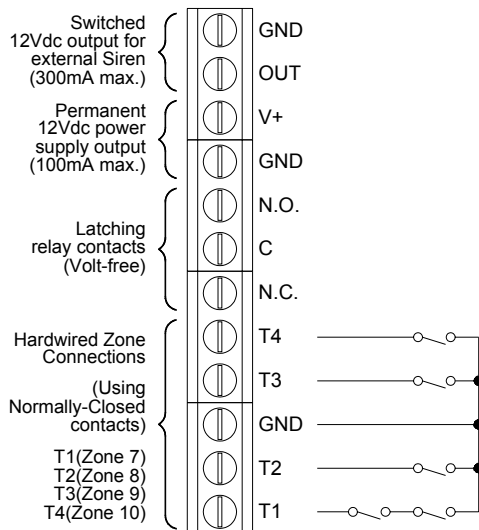

Terminal Block Detail

Hardwired zone and tamper switches should be volt free and Normally Closed, with the contacts opening in order to initiate an alarm.

Note: Jumper link P51 should be fitted into the ON position only if the external hardwired tamper circuit is used, otherwise it must be in the OFF position.

After making your external connections reconnect the power supply and Back-up Battery. Then close the

TESTING THE SYSTEM

INITIAL TESTING

As the system is initially installed it is recommended that each device is tested in turn as it is installed, (refer to testing instructions for particular device).

TESTING AN INSTALLED SYSTEM

The Control Panel has a programmed test routine. You may test the system at any time, however it is recommended that the system is tested at regular intervals not exceeding 3 months.



With the system in Standby Mode

Press , , , , , 
User Password

This puts the system into Test Mode.

The Arm and Part-Arm LEDs will flash.

The system is now in the Test Mode. If the battery siren (HA301) is connected, the Control Panel will emit disarm signal for 1.2 seconds. This offers the battery siren to learn house code from the Control Panel.

Use the  and  buttons to scroll through the menu and press  to select the displayed test function or sub-menu.

Note: After completing all required test functions, press  to leave Test mode and return to Standby.

WALK TEST

Before commencing testing, please ensure that there is no movement in any PIR protected area, all doors/windows protected by Magnetic Contact Detectors are closed and that all battery covers and housings are correctly fitted.

Scroll through the top level Test Mode menu until **'WALK TEST'** is displayed and press .

'Walk Test Waiting...' will be displayed.

1. Trigger each detector on the system by either walking into a PIR protected area or by opening a

door/window protected by a Magnetic Contact detector. As each detector is triggered the Control Panel will chime to indicate that an alarm signal has been received and the identity of the zone that the detector is configured for will be displayed.

- Operate detector anti-tamper switches by opening the case of the device. As the switches are operated the Control Panel will chime and **'Accessory Tamper'** will be displayed.
- Activate each button on the Remote Control in turn. As each button is pressed the Control Panel will chime and the button name will be displayed. (e.g. **'REMOTE CONTROL DISARM'**).

Press  to exit Walk Test and return to the top level Test Mode menu.

ALARM TEST

Scroll through the top level Test Mode menu until **'ALARM TEST'** is displayed and press .

Scroll through the menu until the required alarm displayed and press  to operate the selected alarm for 5s.

Select **'Wirefree Siren Test'** to operate the External Solar Siren.

Select **'Hardwired Siren Test'** to operate the Control Panel Siren and external hardwired Siren (if connected).

Select **'Relay Test'** to operate the External hardwired (N.O./N.C.) relay contacts.

Press  to exit Alarm Test and return to the top level Test Mode menu.

WIREFREE SIREN SERVICE ON/OFF

Scroll through the top level Test Mode menu until **'Wirefree Siren Service ON/OFF'** is displayed and press .

This offers the flexibility of removing or changing siren's battery. Wait for 10 seconds until ON/OFF duration has elapsed, then go ahead with fixing the siren as desired.

VOICE DIALER TEST

Scroll through the top level Test Mode menu until 'VOICE DIALER TEST' is displayed and press



In order to test the voice dialer properly, the prerequisite is to set the telephone number, record the message and enable the call routing in the programming mode.

When testing is in progress, simply press  to stop testing.

If 'LINE STATUS' LED is flashing, it implies bad telephone line connection or telephone network being out of order. Check the telephone line and re-test it.

DIGITAL DIALER TEST

Scroll through the top level Test Mode menu until 'DIGITAL DIALER TEST' is displayed and press



In order to test the digital dialer properly, the prerequisite is to set the telephone number and unit ID number in the programming mode.

When testing is in progress, simply press  to stop testing.

If 'LINE STATUS' LED is flashing, it implies two causes of failure. One is bad telephone line connection or telephone network being out of order. The other cause of failure is derived from the central monitoring station. Consult with the central monitoring station for help.

DEFAULT SETTINGS

User Setup

Users 1-6:	Not programmed
Master Password	1234

System Setup

House Code	10101010
Alarm Time	ON, 180s
Wirefree Siren	ON
RF Jamming Detection	OFF
Back Light	10s
Alarm Relay	On Until Disarm
Zone Lockout	ON
Remote Phone Control	ON
Rings to Answer Phone	6
Call Abort	OFF
Dial method	Tone/DTMF
Dialer Mode	Voice Dialer
Time	12:00:00
Date	01/01/03

Zone Setup (Z1-10)

Name	No Name
Type	Intruder
Final Exit	OFF
Chime	OFF
Entry Delay Zone 1	ON, 30s
Zone 2-10	OFF
Part-Arm 1	OFF
Part-Arm 2	OFF
Walk Through	OFF

Voice Dialer Setup

Phone Numbers	Not programmed
Message Play Time	70s
Alarm Messages	Not programmed
Call Routing	All numbers disabled
Call Confirms	1
Call Attempts	3

Full Arm Setup

Exit Delay	ON, 30s
Entry Delay Beep	ON
Exit Delay Beep	ON

Part-Arm 1 Setup

Exit Delay	ON, 30s
Entry Delay Beep	ON
Exit Delay Beep	ON

Part-Arm 2 Setup

Exit Delay	ON, 30s
Entry Delay Beep	ON
Exit Delay Beep	ON

Latchkey Setup

Status	OFF
Selected User Setup	OFF (all users)
Phone Numbers	Not programmed

Home Control Setup

House Code	A
Unit 1-8 Setup(Unit Code)	01-08
Alarm Trigger	OFF

Answer Phone Setup

Status	OFF
Greeting Message	Not programmed

Digital Dialer Setup

Phone No.	Not programmed
Unit ID No.	Not programmed
Call Attempts	3
Open/Close by user	OFF

Reconnect the PSU Adaptor plug to the DC power socket in the Control Panel and switch On the supply to the PSU Adaptor.

7. As the Control Panel powers-up, 'EEPROM RESET' will be displayed while the factory default conditions are restored to memory. Once the memory reset has been completed 'DISARM READY' will be displayed. The Control Panel will now be reconfigured with all factory default settings.

8. Reset jumper link P1 into the OFF position.

9. Close the Control Panel cover and refit the fixing screws.

RESET FACTORY DEFAULT

1. Press



User Password

to place the system in Test Mode.

2. Undo the Control Panel cover fixing screws and open the cover.

3. Switch OFF the mains supply to the plug-in PSU Adaptor and remove the plug from the DC power socket in the Control Panel.

4. Remove either back-up battery and disconnect the battery leads.

5. Set jumper link P1 to the ON position.

6. Reconnect the battery leads and replace the back-up battery in position.

PROGRAMMING INSTRUCTIONS

With the system in Standby Mode.



Press , , , , ,  **Master Password**

The system is now in the Programming Mode

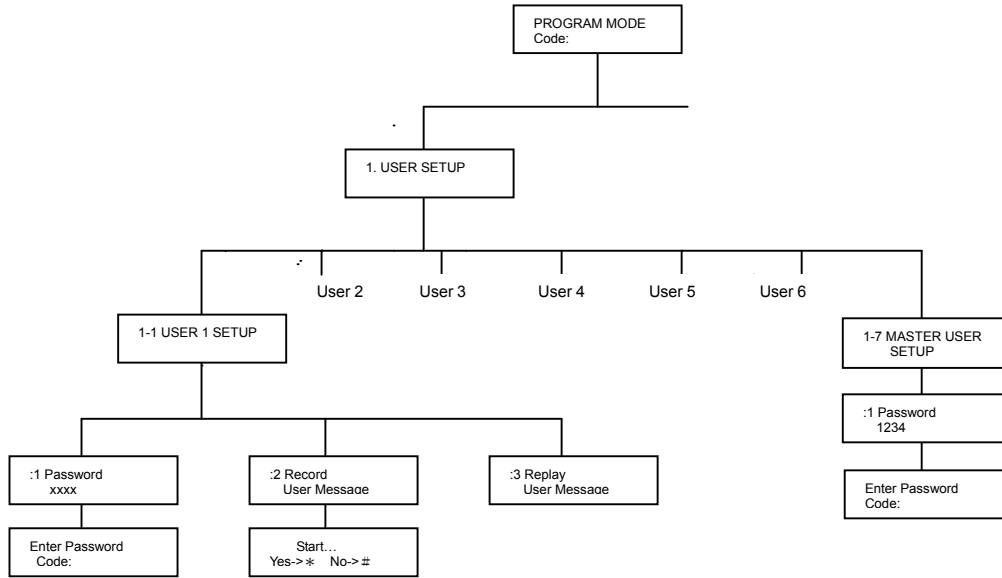
USER SETUP



Scroll through the top level programming menu until '1. USER SETUP' is displayed and press .

Use the  and  buttons to scroll through the menu until the required user to be configured is displayed and press .

Note: After configuring all required users press  to return to the top level programming menu.

USERS 1-6

Default setting: not programmed

Scroll through the menu until the required User to be configured is displayed and press .



User Password

Scroll through the menu until ':1 Password' is displayed. The current setting will also be displayed.

To change the setting press .

Use the  and  buttons to scroll through the programming menu. Press  to select the displayed programming function or sub-menu.

Note: After programming all required functions press  to leave Programming mode and return to Standby.

Enter the new 4 digit Password and then Press  to save and exit, or Press  to exit without saving.

Record User Message

This enables each User to record a short 4s message for use with the latchkey facility. e.g. "system disarmed by User-1".

Scroll through the menu until ':2 Record User Message' is displayed.

To record a new message press .

Press  to start the voice recorder, (max. duration: 4s) Once completed the recording will automatically be played back, or

Press  to exit without changing.

Note: After recording the message, press  to stop the recorder and cancel any remaining message time.

Replay User Message

Scroll through the menu until **‘:3 Replay User Message’** is displayed.

Press  to replay the user message.

Press  to return to the top level User-Setup menu.

MASTER USER

Default Password: 1234

Scroll through menu until **‘1-7 MASTER USER SETUP’** is displayed and press .

‘:1 Password’ and the current setting will be displayed.

To change the setting press .

Type in a new 4 digit Password, and then

Press  to save and exit, or

Press  to exit without saving.

Press  to return to the top level User-Setup menu.

SYSTEM SETUP

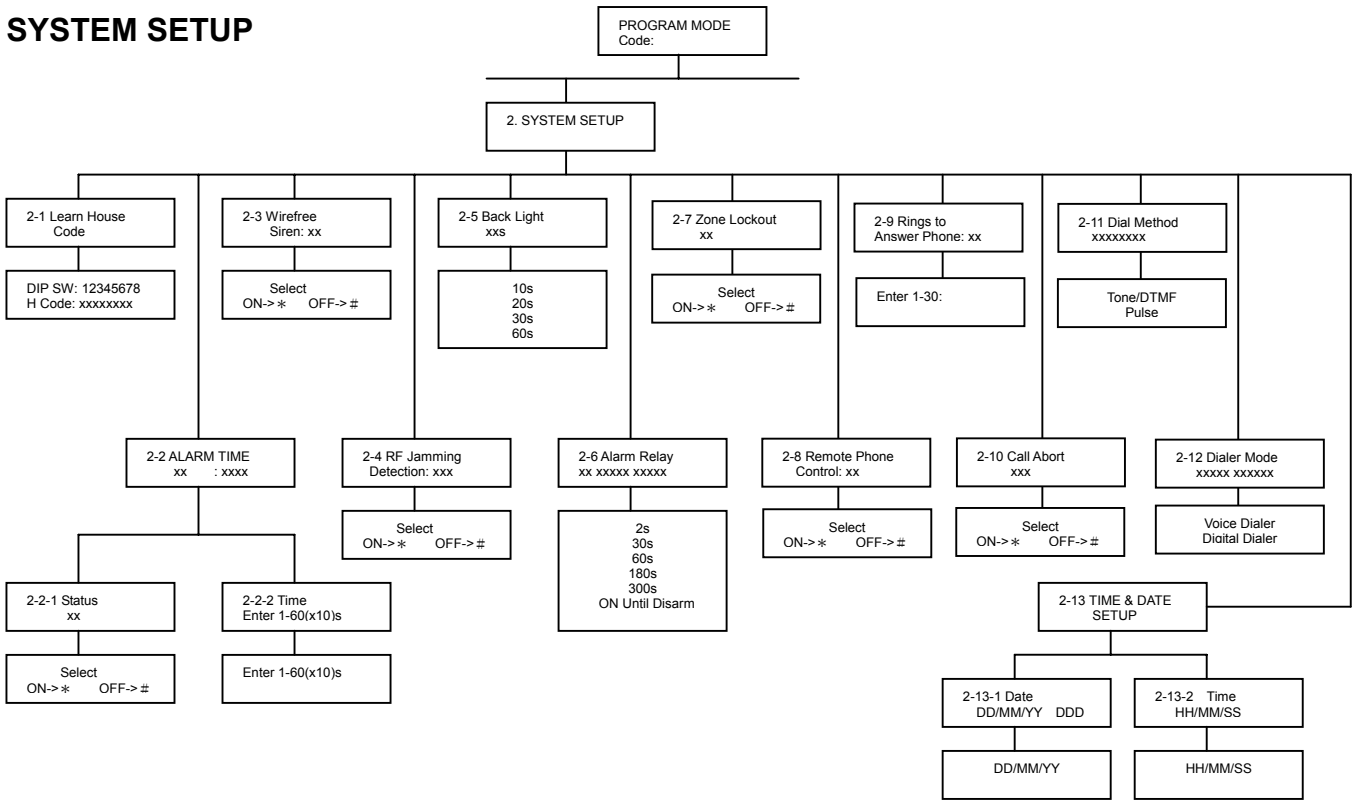

Scroll through the top level programming menu until **'2 SYSTEM SETUP'** is displayed and press .

Note: After completing the system setup press  to return to the top level programming menu.

LEARN SYSTEM HOUSE CODE



There are two methods to learn the House Code. One is to have the Control Panel learn the system house code through the remote control. The other is to press the Control Panel's keypad 1-8 by selecting 0 or 1 respectively in turn (0 means the dip switch is set in ON position, 1 is set in OFF position).

1. Scroll through the menu until **'2-1 Learn House Code'** is displayed.

To program the Control Panel with the system House Code press .

Press  on the Remote Control



The new programmed system house code will be recorded into memory and displayed on the bottom line of the LCD, with the corresponding DIP switch number shown on the top line.

Press  to save and exit, or
Press  to exit without saving.

2. Scroll through the menu until **'2-1 Learn House Code'** is displayed.

To program the Control Panel with the system House Code press .

Press the Control Panel's keypad 1-8 by selecting 0 or 1 respectively in turn.

Press  to save and exit, or
Press  to exit without saving.

Make a note of the system house code now in the space provided on page 41.

ALARM DURATION

Scroll through the menu until **'2-2 ALARM TIME'** is displayed. The current settings will also be displayed.



To change the settings press .

On/Off Status

Default setting: ON

Scroll through the menu until **'2-2-1 Status'** is displayed. The current settings will also be displayed.

To change the setting press .

Press  to enable the Siren, or
Press  to disable the Siren

Alarm Duration

Default setting: 180s

Scroll through the menu until **'2-2-2 Time'** is displayed.

To change the setting press .

Enter the required alarm duration in units of 10s.e.g. enter 6 for a 60s alarm duration (max setting 60, i.e. 600s/10mins).

Press  to save and exit, or

Press  to exit without saving.

Press  to return to top level System Setup menu.

Note: Following initiation of a Full Alarm condition the External Siren will continue to sound until either the system is disarmed; or the Control Panel Alarm Duration Time expires; or if activated until the 3 minute alarm time limit of the external Siren expires; whichever occurs first.

WIREFREE SOLAR SIREN

Default setting: ON

Scroll through the menu until **'2-3 Wirefree Siren'** is displayed. The current setting will also be displayed.

To change the setting press .

Press  to enable the Solar Siren, or

Press  to disable the Solar Siren.

JAMMING DETECTION

This feature controls the Control Panels RF jamming detection circuitry, which if enabled, will continuously scan for radio jamming signals on the system operating frequency.

Default setting: OFF

Scroll through the menu until **'2-4 RF Jamming Detection'** is displayed. The current setting will also be displayed.

To change the setting press .

Press  to enable Jamming Detection, or

Press  to disable Jamming Detection.

CONTROL PANEL BACK LIGHT

This controls the time period that the backlight for the Control Panel display will stay illuminated for after the last key is pressed.

Default setting: 10s

Scroll through the menu until **'2-5 Back Light'** is displayed. The current setting will also be displayed.

To change the setting press .

Scroll through available options, (10, 20, 30 and 60s) until the required setting is displayed.

Press  to save and exit, or

Press  to exit without saving.

ALARM RELAY

This setting controls the operation period for the NO/NC hardwired output relay contacts following an alarm condition being initiated.

If this is set to **'ON until Disarm'** then the relay will latch and remain On until the system is next disarmed.

Default setting: ON Until Disarm

Scroll through the menu until **'2-6 Alarm Relay'** is displayed. The current setting will also be displayed.

To change the setting press .

Scroll through available options, (**2s, 30s, 60s, 180s, 300s and 'ON Until Disarm'**) until the required setting is displayed and then

Press  to save and exit, or

Press  to exit without saving.

ZONE LOCKOUT

This feature, if enabled, prevents a single zone from triggering an alarm condition more than three times before the system is disarmed. However, if disabled, there is no limit on the number of times a zone can trigger an alarm condition.

Default setting: ON

Scroll through the menu until **'2-7 Zone Lockout'** is displayed. The current setting will also be displayed.

To change the setting press .

Press  to enable Zone Lockout, or

Press  to disable Zone Lockout.

REMOTE SYSTEM CONTROL

This feature, if enabled, allows the system to be remotely controlled via the telephone.

Default setting: ON

Scroll through the menu until **'2-8 Remote Phone Control'** is displayed. The current setting will also be displayed.

To change the setting press .

Press  to enable Remote Phone Control, or

Press  to disable Remote Phone Control.

RINGS TO ANSWER PHONE

This controls the number of times a connected phone will be allowed to ring before the line is picked up for either Answer-Phone and/or Remote Phone Access use.

Default setting: 6

To change the setting press .

Enter the required number of rings (1-30) before the Control panel will pick up the call

Press  to save and exit, or

Press  to exit without saving.

CALL ABORT

This feature, if enabled, will delay the activation of the telephone dialer following an alarm for a period of approx. 30s to allow the system to be disarmed.

Default setting: OFF

Scroll through the menu until **'2-10 Call Abort'** is displayed. The current setting will also be displayed.

To change the setting press .

Press  to enable Call Abort, or

Press  to disable Call Abort.

DIAL METHOD

This feature enables the telephone dialer to be configured for type of exchange it is connected to.

Default setting: Tone/DTMF

Scroll through the menu until **'2-11 Dial Method'** is displayed. The current setting will also be displayed.

To change the setting press .

Scroll through available options, (Tone/DTMF and Pulse), until the required setting is displayed and then

Press  to save and exit, or

Press  to exit without saving.

DIAL MODE



This facility controls whether the internal telephone dialer operates with the voice or digital dialer facility. The digital dialer is designed to be connected to an external remote Central Monitoring station service.



Default setting: Voice Dialer

Scroll through the menu until **'2-12 Dialer mode'** is displayed. The current setting will also be displayed.

To change the setting press .

Scroll through available options, (Voice dialer and Digital dialer) until the required setting is displayed.

Press  to save and exit, or
 Press  to exit without saving.

Press  to save and exit, or
 Press  to exit without saving.

TIME & DATE SETUP

Scroll through the menu until **'2-13 TIME & DATE SETUP'** is displayed and press .

Note: After configuring the Time and Date press  to return to the top level programming menu.

DATE

Scroll through the menu until **'2-13-1 Date'** is displayed. The current setting will also be displayed.

To change the setting press .

Enter the date in the format 'dd/mm/yy'.

ZONE SETUP

TIME

Scroll through the menu until **'2-13-2 Time'** is displayed. The current setting will also be displayed.

To change the setting press .

Enter the time in the format 'hh:mm:ss'.

Press  to save and exit, or

Press  to exit without saving.

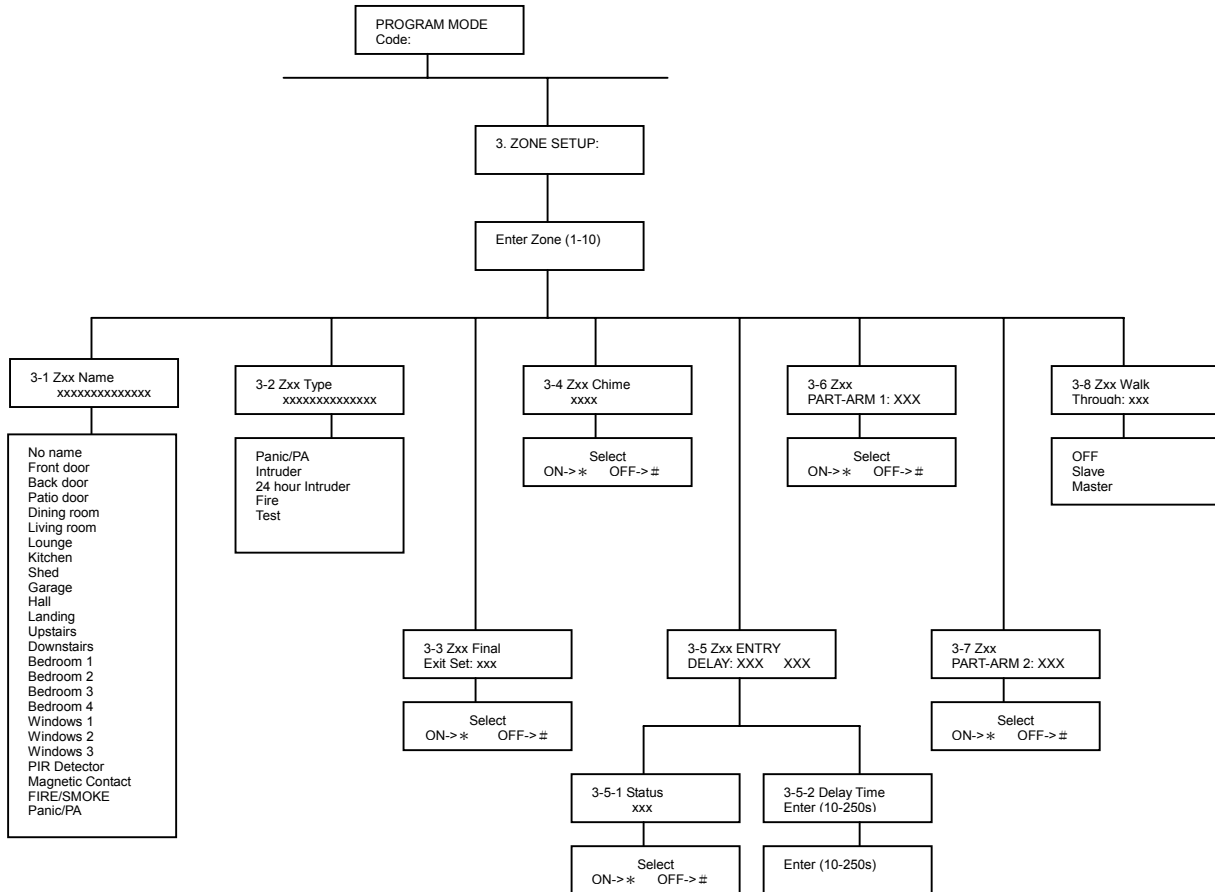

Scroll through the programming menu until **'3. ZONE SETUP'** is displayed and press .

Enter the zone number to be configured and press .

The following configuration options are based upon configuring zone 1. Options for all other zones (2-10)

are identical except the zone number reference will change according to the zone being configured.

Note: After completing the Zone Setup press  to return to the top level programming menu.

NAME

Default setting: 'No name'

Scroll through the menu until '**3-1 Z01 Name**' is displayed. The current setting will also be displayed.

To change the setting press .

Scroll through available options until the required setting is displayed.

Press  to save and exit, or

Press  to exit without saving.

TYPE

Each alarm zone may be programmed to operate in one of 5 different modes depending on the type of alarm function it is required to perform. The following alarm types are available:

Panic

- used to provide 24 hour monitoring of any emergency being occurred. Activation of any Panic switch will immediately initiate a Full Alarm condition.

Intruder

- provides standard intruder monitoring with normal ARM and PART-ARM functions.

24 Hour Intruder

- used to provide 24 hour monitoring of areas requiring continuous security protection even while the system is Disarmed, (e.g. gun lockers). Activation of any detector on a security zone will immediately initiate a Full Alarm condition.

Fire

- use to provide 24 hour monitoring of any Fire/Smoke detectors fitted to the system. Activation of any detector will immediately initiate a Full Alarm condition.

Test

- when the system is armed, any detector on the zone will generate an entry in the Event-Log without initiating an alarm condition.

Note: Panic, 24-hour Intruder and Fire modes all operate on a 24 hour basis, (i.e. they are able to initiate Full Alarm condition at any time irrespective of whether the system is Armed or Disarmed).

Default setting: 'Intruder'

Scroll through the menu until '**3-2 Z01 Type**' is displayed. The current setting will also be displayed.

To change the setting press .

Scroll through available options until the required setting is displayed.

Press  to save and exit, or

Press  to exit without saving.

FINAL EXIT SET

If enabled, triggering of any detector on the zone during the exit-delay will cancel any remaining exit-delay and cause the system to arm 5 seconds later.

Default setting: OFF

Scroll through the menu until '**3-3 Z01 Final Exit Set**' is displayed. The current setting will also be displayed.

To change the setting press .

Press  to enable the zone's Final Exit Set facility, or

Press  to disable the zone's Final Exit Set facility.

CHIME

This controls whether the Chime facility is available on the zone.

Default setting: OFF

Scroll through the menu until '**3-4 Z01 Chime**' is displayed. The current setting will also be displayed.

To change the setting press .

Press  to enable the zone's Chime facility, or

Press  to disable the zone's Chime facility.

ENTRY DELAY

Scroll through the menu until **'3-5 ENTRY DELAY'** is displayed. The current settings will also be displayed.

To change the settings press .

On/Off Status

Default setting: Zone 1: ON
ZONES 2-10: OFF

Scroll through the menu until **'3-5-1 Status'** is displayed. The current setting will also be displayed.

To change the settings press .

Press  to enable the zone's entry-delay, or

Press  to disable the zone's entry-delay.

Delay Period

Default setting: 30s

Scroll through the menu until **'3-5-2 Delay Time'** is displayed.

To change the settings press .

Enter the required delay period (10 to 250s)

Press  to save and exit, or

Press  to exit without saving.

Press  to return to top level Zone Setup.

PART-ARM 1

This controls whether the zone is active when Part-Arm 1 is armed.

Default setting: OFF

Scroll through the menu until **'3-6 Z01 Part-Arm 1'** is displayed. The current setting will also be displayed.

To change the setting press .

Press  to enable the Zone in Part-Arm 1, or

Press  to disable the Zone in Part-Arm 1.

PART-ARM 2

This controls whether the zone is active when Part-Arm 2 is armed.

Default setting: OFF

Scroll through the menu until **'3-7 Z01 Part-Arm 2'** is displayed. The current setting will also be displayed.

To change the setting press .

Press  to enable the Zone in Part-Arm 2, or

Press  to disable the Zone in Part-Arm 2.

WALK THROUGH

Default setting: OFF

Scroll through the menu until **'3-8 Z01 Walk Through'** is displayed. The current setting will also be displayed.

To change the setting press .

Scroll through available options, (Off, Master and Slave), until the required setting is displayed.

Press  to save and exit, or

Press  to exit without saving.

VOICE DIALER SETUP

See diagram on next page.

Scroll through the programming menu until **'4. VOICE DIALER SETUP'** is displayed and press .

Note: After completing the Voice Dialer Setup press  to return to the top level programming menu.

TELEPHONE NUMBERS

Scroll through the menu until **'4-1 PHONE NUMBERS'** is displayed and press .

Scroll through the menu until the required Telephone number (1-4) is displayed. The current setting of each telephone number will also be displayed.

To change the number press .

Enter the new telephone number (32 digits max.)

Press  to save and exit, or

Press  to exit without saving.

Notes:

Press  to insert a 3.6s pause in the dialing sequence.

Press  to move the cursor left.

Press  to move the cursor right.

Press  to delete the character under the cursor.

Press and hold  to erase the entire phone number.

After programming all required phone numbers press  to return to the top level Voice Dialer menu.

ALARM MESSAGE PLAY TIME

This is the total time for which the alarm messages will be played & repeated when a call made by the voice dialer is answered.

Default setting: 70s

Scroll through the menu until '4-2 Message Play Time' is displayed. The current setting will also be displayed.

To change the settings press .

Scroll through the available options, (50, 70, 90 and 110s) until the required setting is displayed.

Press  to save and exit, or

Press  to exit without saving.

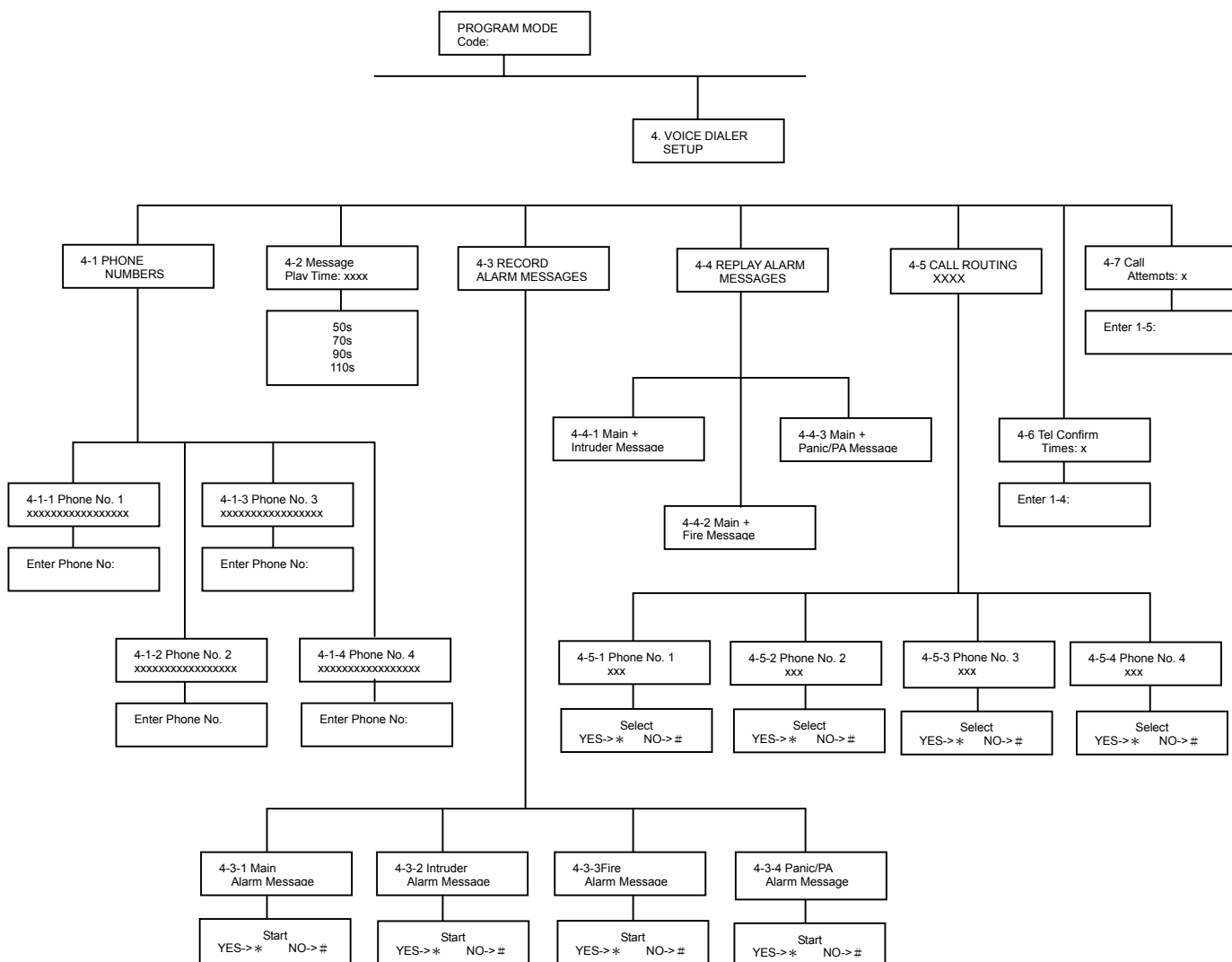



RECORD ALARM MESSAGES

Scroll through the menu until **'4-3 RECORD VOICE'** is displayed and press .

Scroll through the available menu options until the required message type to be recorded is displayed.

- a) Main Alarm message, (12 seconds max).
- b) Intruder Alarm message, (4 seconds max).
- c) Fire Alarm message, (4 seconds max).
- d) Panic Alarm message, (4 seconds max).

To record a new message press .

Press  to start the voice recorder. Once completed the recording will automatically be replayed, or

Press  to exit without changing.

Note: After recording the message, press  to stop the recorder and cancel any remaining message time.

Press  to return to the top level Voice Dialer setup menu.

REPLAY ALARM MESSAGES

Scroll through the menu until **'4-4 REPLAY ALARM MESSAGES'** is displayed and press .

Scroll through the available menu options until the required message type is displayed.

- a) Main + Intruder Messages
- b) Main + Fire Messages
- c) Main + Panic Messages

To replay the message press .

Press  to return to the top level Voice Dialer setup menu.

CALL ROUTING

This feature controls which telephone numbers are enabled in the dialing sequence and are dialed when the voice dialer is activated.

The current routing sequence is displayed on screen in the order of phone numbers 1-4. An 'X' indicates the

number is disabled and a 'O' indicates the number is enabled in the routing sequence. e.g. A display = "000x" indicates a call sequence of phone nos.1,2 and 3, phone number 4 is disabled and not called.

Default setting: all numbers disabled.

Scroll through the menu until **'4-5 CALL ROUTING'** is displayed. The current settings will also be displayed. Scroll through the available menu options until the required telephone number (1-4) to be configured is displayed. The current status will also be displayed.

To change the setting press .

Press  to enable the number in the routing sequence, or

Press  to disable the number in the routing sequence.

Press  to return to the top level Voice Dialer Setup menu.

TEL CONFIRM TIMES

This sets the number of acknowledged phone numbers required to stop the voice dialer. For example if set to "2" then the dialing sequence will continue until an acknowledgment is received from two different numbers, (e.g. Phone No. 1 and Phone No. 3).

Default setting: 1

Scroll through the menu until **'4-6 Tel Confirm Times'** is displayed. The current settings will also be displayed.

To change the setting press .

Enter the required number (1-4).

Press  to save and exit, or

Press  to exit without saving.

CALL ATTEMPTS

This sets the maximum number of times that the dialer will attempt to contact each enabled telephone number in the call routing sequence.

Default setting: 3

Scroll through the menu until '4-7 Call Attempts' is displayed. The current settings will also be displayed.

To change the setting press .

Enter the required number (1-5).

Press  to save and exit, or

Press  to exit without saving.

ARM STATUS SETUP

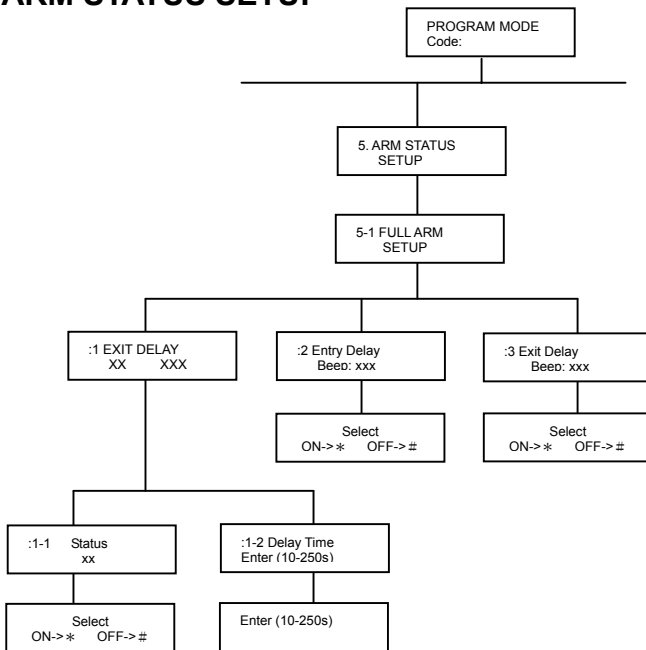

Scroll through the programming menu until '5. ARM STATUS SETUP' is displayed and press .

Note: After configuring Arm Status press  to return to the top level programming menu.

FULL ARM SETUP

Scroll through the menu until '5-1 FULL ARM SETUP' is displayed and press .

EXIT DELAY

Scroll through the menu until ':1 EXIT DELAY' is displayed. The current settings will also be displayed.

To change the settings press .

On/Off Status

Default setting: ON

Scroll through the menu until ':1-1 Status' is displayed. The current setting will also be displayed.

To change the settings press .

Press  to enable the Exit delay, or

Press  to disable the Exit delay.

Delay Period

Default setting: 30s

Scroll through the menu until ':1-2 Delay Time' is displayed. The current settings will also be displayed.

To change the settings press .

Enter the required delay period (10 to 250s).

Press  to save and exit, or

Press  to exit without saving.

Press  to return to top level Arm Status Setup menu.

ENTRY DELAY BEEP

This controls the warning beep which operates during the Entry Delay period when Full Arm is active.

Default setting: ON

Scroll through the menu until ':2 Entry Delay Beep' is displayed. The current setting will also be displayed.

To change the setting press .

Press  to enable the entry-delay beep, or

Press  to disable the entry-delay beep.

EXIT DELAY BEEP

This controls the warning beep which operates during the Exit Delay period when Full Arm is initiated.

Default setting: ON

Scroll through the menu until ':3 Exit Delay Beep' is displayed. The current setting will also be displayed.

To change the setting press .

Press  to enable the exit-delay beep, or

Press  to disable the exit-delay beep.

PART-ARM 1 SETUP

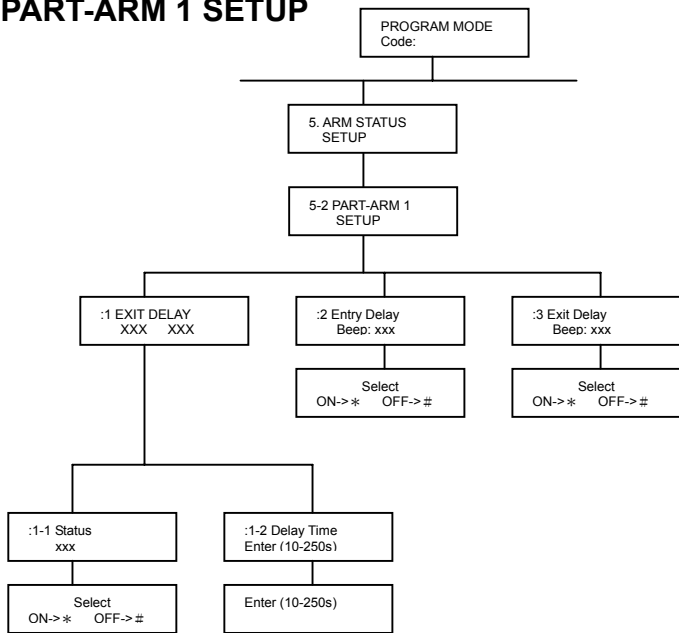

Scroll through the programming menu until '**5-2 PART-ARM 1 SETUP**' is displayed and press .

Note: After configuring Part-Arm 1 press  to return to the top level programming menu.

EXIT DELAY

Scroll through the menu until '**:1 EXIT-DELAY**' is displayed. The current settings will also be displayed.

To change the settings press .

On/Off Status

Default setting: ON

Scroll through the menu until '**:1-1 Status**' is displayed. The current setting will also be displayed.

To change the settings press .

Press  to enable the Exit delay, or

Press  to disable the Exit delay.

Delay Period

Default setting: 30s

Scroll through the menu until '**:1-2 Delay Time**' is displayed. The current settings will also be displayed.

To change the settings press .

Enter the required delay period (10 to 250s).

Press  to save and exit, or

Press  to exit without saving.

Press  to return to top level Part-Arm 1 Setup menu.

ENTRY DELAY BEEP

This controls the warning beep which operates during the Entry Delay period when Part-Arm 1 is active.

Default setting: ON

Scroll through the menu until '**:2 Entry Delay Beep**' is displayed. The current setting will also be displayed.

To change the setting press .

Press  to enable the entry-delay beep, or

Press  to disable the entry-delay beep.

EXIT DELAY BEEP

This controls the warning beep which operates during the Exit Delay period when Part-Arm 1 is initiated.

Default setting: ON

Scroll through the menu until '**:3 Exit Delay Beep**' is displayed. The current setting will also be displayed.

To change the setting press .

Press  to enable the exit-delay beep, or

Press  to disable the exit-delay beep.

PART-ARM 2 SETUP

See diagram on next page.

Scroll through the programming menu until '**5-3 PART-ARM 2 SETUP**' is displayed and press .

Note: After configuring Part-Arm 2 press  to return to the top level programming menu.

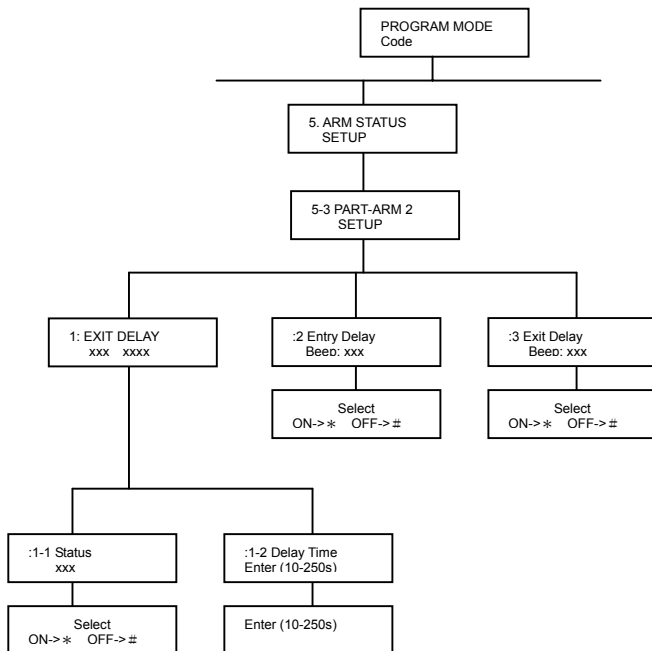

EXIT DELAY

Scroll through the menu until ‘:1 EXIT-DELAY’ is displayed. The current settings will also be displayed.

To change the settings press

On/Off Status

Default setting: ON

Scroll through the menu until ‘:1-1 Status’ is displayed. The current setting will also be displayed.

To change the settings press

Press to enable the Exit delay, or

Press to disable the Exit delay.

Delay Period

Default setting: 30s

Scroll through the menu until ‘:1-2 Delay Time’ is displayed. The current settings will also be displayed.

To change the settings press

Enter the required delay period (10 to 250s).

Press to save and exit, or

Press to exit without saving.

Press to return to top level Part-Arm 2 Setup menu.

ENTRY DELAY BEEP

This controls the warning beep which operates during the Entry Delay period when Part-Arm 2 is active.

Default setting: ON

Scroll through the menu until ‘:2 Entry Delay Beep’ is displayed. The current setting will also be displayed.

To change the setting press

Press to enable the entry-delay beep, or

Press to disable the entry-delay beep.

EXIT DELAY BEEP

This controls the warning beep which operates during the Exit Delay period when Part-Arm 2 is initiated.

Default setting: ON

Scroll through the menu until ‘:3 Exit Delay Beep’ is displayed. The current setting will also be displayed.

To change the setting press

Press to enable the exit-delay beep, or

Press to disable the exit-delay beep.

LATCH KEY SETUP

See diagram on next page.

Scroll through the top level programming menu until ‘6. LATCH KEY SETUP’ is displayed and press .

Note: After completing the Latch Key Setup press to return to the top level programming menu.

STATUS

This sets the users that the Latch Key facility will operate with. If set to ‘Selected-Users’ the Latch Key will only operate with those users enabled in section ‘6-2 Selected User Setup’.

Default setting: OFF

Scroll through the menu until **'6-1 Status'** is displayed. The current setting will also be displayed.

To change the setting press .

Scroll through the available options, (Off, Selected-Users and All-Users), until the required setting is displayed.

Press  to save and exit, or

Press  to exit without saving.

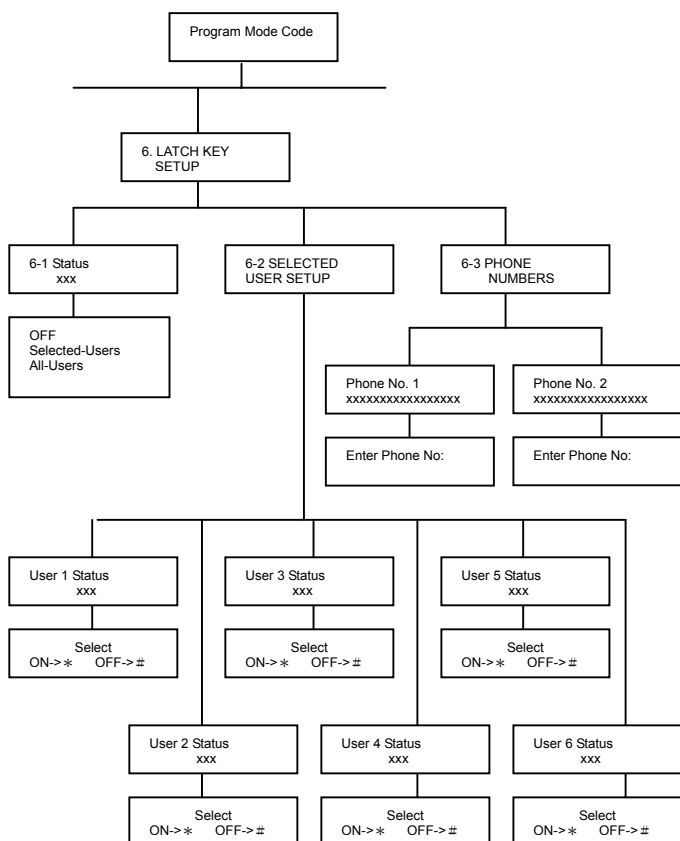

SELECTED-USERS SETUP

This allows controls over which users the Latch Key facility operates with when set to 'Selected-Users'.

Default setting: OFF

Scroll through the menu until **'6-2 SELECTED USER SETUP'** is displayed and press .

Scroll through the menu until the required user number (1-6) to be configured is displayed. The current status will also be displayed.

To change the setting press .

Press  to enable the Latch-Key for the user, or

Press  to disable the Latch-Key for the user.

After configuring all Users as required press  to return to the top level Latch Key Setup menu.

TELEPHONE NUMBERS

Scroll through the menu until **'6-3 PHONE NUMBERS'** is displayed and press .

Scroll through the menu until the required telephone number (1-2) is displayed. The current setting will also be displayed.

To change the number press .

Enter the new telephone number (32 digits max).

Press  to save and exit, or

Press  to exit without saving.

Notes:

Press  to insert a 3.6s pause in the dialing sequence.

Press  to move the cursor left.

Press  to move the cursor right.

Press  to delete the character under the cursor.

Press and hold  to erase the entire phone number.

After programming all required phone numbers press  to return to the top level Latch Key Setup menu.

HOME CONTROL SETUP

This controls the Everspring Home Automation Receiver (e.g. BH002, BH003, BH004 & BH006) for a maximum of 8 pcs.

Scroll through the top level programming menu until **'7. HOME CONTROL SETUP'** is displayed and press



Note: After completing the Home Control Setup press  to return to the top level programming menu.

HOME AUTOMATION CONTROLLER HOUSE CODE

Default setting: A

Scroll through the menu until '7-1 Set House Code' is

displayed. The current settings will also be displayed.

To change the settings press .

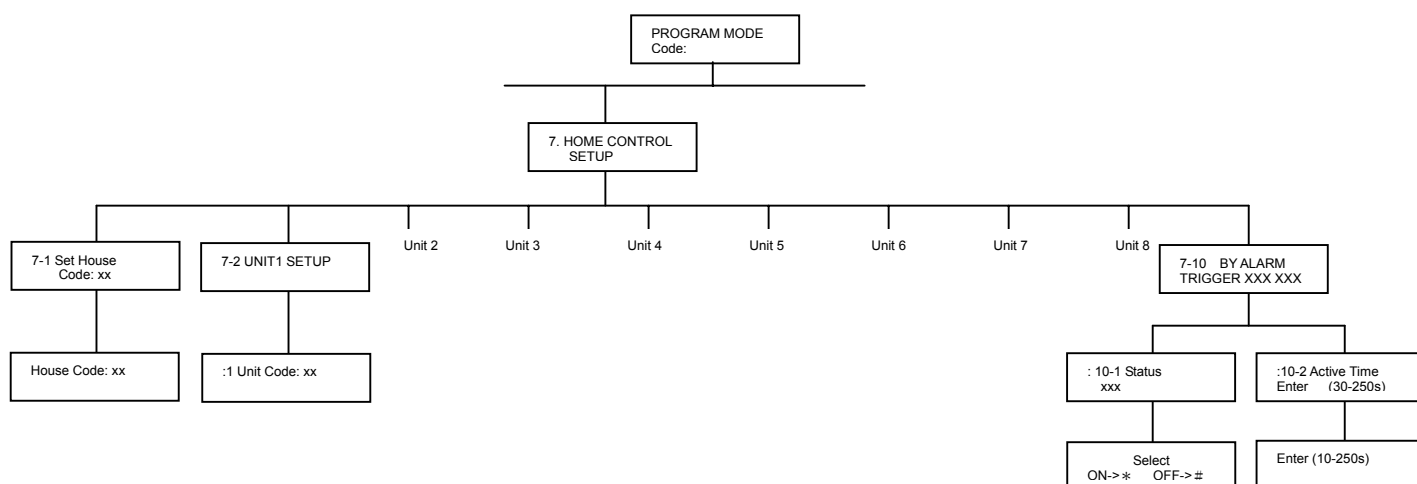

Scroll through the available options, (A~P), until the required setting is displayed.

Press  to save and exit, or

Press  to exit without saving.

UNIT 1 SETUP

Scroll through the menu until '7-2 UNIT1 SETUP' is displayed and press .

Unit Code

Default setting: 01

Scroll through the menu until ':1 Unit Code' is displayed and press .

Enter the unit code (1-16) that your home automation receiver has.

Press  to save and exit, or

Press  to exit without saving.

UNIT 2 SETUP

Scroll through the menu until '7-3 UNIT2 SETUP' is displayed and press .

Unit Code

Default setting: 02

Scroll through the menu until ':1 Unit Code' is displayed and press .

Enter the unit code (1-16) that your home automation receiver has.

UNIT 3 SETUP

Scroll through the menu until '7-4 UNIT3 SETUP' is displayed and press .

Unit code

Default setting: 03

Scroll through the menu until ':1 Unit Code' is displayed and press .

Enter the unit code (1-16) that your home automation receiver has.

Press  to save and exit, or

Press  to exit without saving.

Note: Use the same method as mentioned above for setting the unit 4-8 of home automation receiver.

ALARM TRIGGER

Default setting: OFF

Scroll through the menu until '7-10 BY ALARM TRIGGER' is displayed. The current setting will also be displayed.

To change the setting press .

On/Off Status

Default setting: OFF

Scroll through the menu until **'10-1 Status'** is displayed. The current setting will also be displayed.

To change the setting press .

Press  to enable the home automation receiver, or

Press  to disable the home automation receiver.

Active Time

This controls the illuminating duration of all the lighting units connected to BH004/006 when the on/off status is set for "ON". After the elapse of pre-set illuminating duration (30-250s variable), the lighting units will be off automatically.

Default setting: 30 seconds

Scroll through the menu until **'10-2 Active Time'** is displayed and press .

Enter the required active duration (30 to 250s).

Press  to save and exit, or

Press  to exit without saving.

Press  to return to top level programming mode.

ANSWER PHONE SETUP

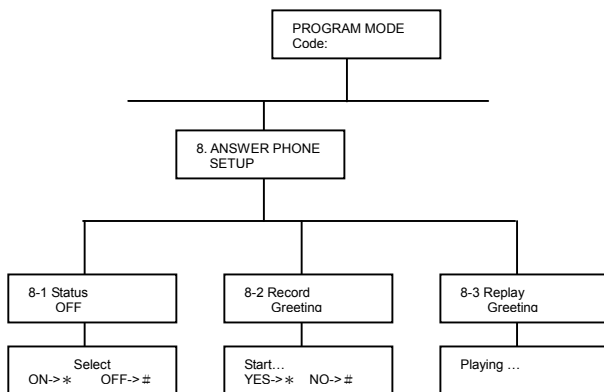

Scroll through the programming menu until **'8. ANSWER PHONE SETUP'** is displayed and press .

Note: After completing the Answer Phone Setup press  to return to the top level programming menu.

ON/OFF STATUS

Default setting: OFF

Scroll through the menu until **'8-1 Status'** is displayed. The current setting will also be displayed.

To change the setting press .



Press  to enable the Answer-Phone, or

Press  to disable the Answer-Phone.

RECORD GREETING

Scroll through the menu until **'8-2 Record Greeting'** is displayed.

To record a new greeting message press .

Press  to start the voice recorder, (max. duration: 12s). Once completed the recording will automatically be played back, or Press  to exit without changing

Note: After recording the greeting message, press  to stop the recorder and cancel any remaining message time.

REPLAY GREETING

Scroll through the menu until **'8-3 Replay Greeting'** is displayed.

To replay the recorded greeting message press .

DIGITAL DIALER SETUP

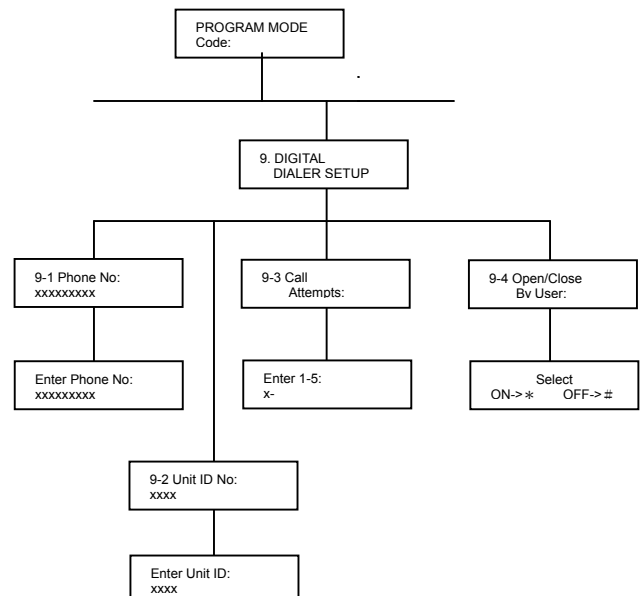

Scroll through the programming menu until **'9. DIGITAL DIALER SETUP'** is displayed and press .

Note: After completing the Digital Dialer Setup press  to return to the top level programming menu.

PHONE NUMBER

Scroll through the menu until **'9-1 Phone No:'** is displayed. The current setting will also be display.

To change the setting press .

Enter the phone number (32 digits max. ranging from 0~9, *, #, ) that Central Monitoring station has.

Press  to save and exit, or

Press  to exit without saving.

Notes:

Press  to insert a 3.6s pause in the dialing sequence.

Press  to move the cursor left.

Press  to move the cursor right.

Press  to delete the character under the cursor.

Press and hold  to erase the entire phone number.

UNIT ID NUMBER

This helps central monitoring station set an ID number for the user whose system is connected to their center.

Scroll through the menu until **'9-2 Unit ID No:'** is displayed. The current setting will also be displayed.

To change the setting press .

Enter the ID number (4 digits max. ranging from 0-9, B,C,D,E, F)

Press  to save and exit, or

Press  to exit without saving.

Notes:

Press  and then 1, a 'B' will be presented.

Press  and then 2, a 'C' will be presented.

Press  and then 3, a 'D' will be presented.

Press  and then 4, an 'E' will be presented.

Press  and then 5, a 'F' will be presented.

When pressing  for 3 seconds, no further input is made, it will be regarded as void input.

CALL ATTEMPTS

This sets the maximum number of times that the dialer will attempt to contact the central monitoring station. If the dialer contacts to the central monitoring station once successfully, it will stop dialing.

Default setting: 3

Scroll through the menu until **'9-3 Call Attempts'** is displayed. The current setting will also be displayed.

To change the setting press .

Enter the required number (1-5).

Press  to save and exit, or

Press  to exit without saving.

OPEN/CLOSE BY USER

This determines when user makes a selection for disarming (Open) or arming (Close) the system, an event code 401 is needed to be sent to the central monitoring station. When setting to 'On', an event code 401 will be emitted, setting to 'Off', an event code 401 won't be emitted.

Default setting: Off

Scroll through the menu until **'9-4 Open/Close By User'** is displayed. The current setting will also be displayed.

To change the setting press .

Press  to commence sending the event code.

Press  to commence not sending the event code.

Press  to return to top level Digital Dialer Setup menu.

OPERATING INSTRUCTIONS

When leaving the premises, the system must be Armed. However, before doing so, check that all windows are closed and locked, all protected doors are closed and PIR Detectors are not obstructed. Ensure that pets are restricted to areas not protected by PIR Detectors.

The system has three arming modes, ARM, Part-Arm 1 and Part-Arm 2. The Part-Arm modes allow for selected zones to be left in a Disarmed state while the remainder of the system is Armed.

When the system is Armed (in any mode) the Control Panel will display the arming mode and the status of the Latch Key for a few seconds. If enabled, the system Exit-Delay will start and be counted down on the display. As the Exit-Delay expires the Control Panel will beep, with the beep rate increasing in steps as the delay expires. At the end of the Exit-Delay all active zones be Armed. By this time the user must have left the property and closed the final exit door.

If while the system is armed a detector on an active zone is triggered, if enabled, the programmed Entry-delay for that zone will start and be counted down on the display. As the Entry-Delay expires the Control Panel will beep, with the beep rate increasing in steps as the delay expires. If the system has not been disarmed when the Entry-Delay expires an alarm will occur. If however, the Entry-Delay for the triggered zone has been disabled an alarm will occur immediately.

At the end of the programmed alarm duration the Siren and Control Panel alarms will stop and the system will automatically re-Arm.

ARM

The system can be set in ARM mode using either the Remote Control or the Control Panel as follows:

Remote Control:

Press the 'ARM' button, .

Control Panel:

Press the Arm button followed by the User Password and then the Enter button:



User Password

By pressing , the programmed exit delay will be overridden to 5 seconds.

PART-ARM 1

The system can be set in PART-Arm 1 mode using either the Remote Control or the Control Panel as follows:

Remote Control:

Press the 'PART-ARM' button, .

Control Panel:



User Password

By pressing , the programmed exit delay will be overridden to 5 seconds.

PART-ARM 2

The system can be set in Part-Arm 2 mode using either the Remote Control or the Control Panel as follows:

Remote Control:

Press the 'PART-ARM' button twice, , .

Control Panel:



User Password

By pressing , the programmed exit delay will be overridden to 5 seconds.

DISARM

The system can be Disarmed using either the Remote Control or the Control Panel as follows:

Remote Control:

Press the 'DISARM' button, .

Control Panel:



User Password

If the system is disarmed and the 'ALARM MEM' LED is flashing with the panel beeping every few seconds, this indicates that an alarm condition has occurred. Use the Event Log to find out and make a note of where the alarm occurred to assist in tracing the cause of the alarm.

QUICK SET

To operate the quick set function and fully arm the system in 5s, overriding the programmed exit delay.

Press      

User Password

OMIT ZONE



To omit a zone from the next armed session:

Press      

User Password

Scroll through the menu until the required zone is displayed. The current setting will also be displayed.

To change the setting press .

Press  to omit the zone, (i.e. zone omit ON).
 Press  to re-enable the zone, (i.e. zone omit OFF).

After configuring zones to be omitted as required

Press  to return to Standby mode.

Note: Omitting a zone will only affect the next armed session. When the system is disarmed the omitted zones will be re-enabled ready for the next armed session.

PANIC ALARM

A full Alarm condition can be immediately initiated at any time (whether the system is Armed or Disarmed) in the event of threat or danger by activating a Panic switch on either the Remote Control or the Control Panel.

Remote Control:

Slide the Panic switch upwards.

Control Panel:

Press and hold the  button for approximately 3 seconds.

The alarm will continue either for the alarm duration when the system will automatically reset or until the system is disarmed.

TAMPER

If the battery cover of any device is removed or if the Siren or Control Panel are removed from the wall then a Full Alarm condition will be initiated even if the system is Disarmed. The alarm condition will continue either for the alarm duration when the system will automatically reset or until the system is Disarmed. The 'ALARM MEM' LED on the Control Panel will flash and the panel will beep every few seconds to indicate an alarm has occurred.

Note: The Tamper protection facility on the Siren operates independently. If the Tamper on the Siren is activated this will not be indicated at the Control Panel.

CHIME

The Chime facility can only be operated with the system in Standby mode.

Press  to toggle the Chime facility between ON and OFF.

Note: If the Chime is ON and the system is then armed the Chime will remain ON after the system is disarmed.

EVENT-LOG

The Event Log will store the last 50 system Arm, disarm, alarm and detector Low Battery events. The Event Log will record the time, date and details for each event. If when the system is disarmed the "ALARM MEM" LED is flashing and the panel beeps every 10s, this indicates that an alarm has occurred. To cancel the LED and stop the beeping you must access the event log or press  to eliminate flashing 'ALARM MEM' LED and the beeping as well.

To access the Event Log, (with the system in Standby):

Press .

The Event-Log will automatically start scrolling through and displaying the event data starting with the most recent event. The data for each event is shown on two screens, each screen will be displayed for 5

seconds before moving on to the next screen and then the next event.

Use the  and  buttons to manually scroll through the event log to the required position as necessary.

Press  to return to standby.

VOICE MEMO

To record a message, (max. duration 30s), at the Control Panel using the Voice Memo facility, proceed as follows:

Press 
Press  to start recording

While recording, press  to stop the recorder and skip the remaining message time.

If there are already 6 messages recorded it will not be possible to record a voice-memo message until a message has been deleted.

The Voice Memo message may be accessed either at the Control Panel (see Replay Messages) or via the Remote System Control facility.



REPLAY MESSAGES

If the 'MESSAGE' LED is illuminated, this indicates that either a new Answer-Phone or Voice-Memo message has been recorded and has not been read. The recorded messages may be accessed at the Control Panel as follows:

Press , , , , , 
User Password

Messages are replayed in order starting with the most recent. Press  to skip to the end of the message.

At the end of each message there will be the option of deleting the message just heard.

To delete the message
Press  to delete the message
Press  to re-confirm and actually delete the message

Note: Press  at either stage to cancel delete and move on to the next message.

After all messages have been replayed the system will automatically return to Standby Mode.

REMOTE SYSTEM CONTROL

If the Remote System Control facility is enabled, the Control Panel will answer the call after the set number of rings and emit three beeps on the phone line to prompt for a User Password to be entered using the telephone keypad.

A valid User Password will be acknowledged with one long beep. An incorrect code will be acknowledged by two short beeps.

If the User Password is not entered within 30s or is entered incorrectly three times then the Control Panel will automatically hang-up the line.

Note: If the internal Answer-Phone is also enabled and there is space for a new message then the call will be answered with the Answer-Phone greeting message. The User Password should be entered during the greeting message, otherwise the answer phone message recorder will be activated.

By pressing the  button on the telephone keypad within 30 seconds, the Control Panel will automatically hang-up the line.

Use with an External Answer-Phone:

If the Remote System Control is to be used in conjunction with an external Answer-Phone then

1. The internal Answer-Phone must be disabled.
2. The number of 'ring to answer' for the Control Panel must be greater than that of the External Answer-Phone, otherwise the Control Panel will always pickup the call before the Answer-Phone.

To access the Remote System Control facility the Control Panel has a 'double dial-in' feature to enable the Control Panel to pick-up the phone call before the external Answer-Phone cuts in. The 'double dial-in' procedure is as follows:

1. Dial up the system and hang up after two rings.
2. Redial up the system within 20s as maximum (5s as minimum), the system will pickup the phone after 1 ring.
3. Enter the User Password as normal.

The following functions may be access via the remote. The system will acknowledge each signal with a single long beep.

Press **1** to initiate ARM.

Press **2** to initiate Part-Arm 1.

Press **3** to initiate Part-Arm 2.

Press **4** to Disarm the system.

Press **5** to turn the Siren OFF

Press **6** to turn the Siren ON.

Press **7** to Listen-In via the Control Panel Microphone.

Press **#** to stop Listen-In

Note: Listen-in will be automatically cancelled after 5 minutes if not cancelled manually.

Press **8** to interrogate the system status. The status tone will be repeated at 2s intervals for 15s.

- | | |
|---------------|-------------------|
| One beep | ARM |
| Two beeps | Part-Arm (1 or 2) |
| Three beeps | Alarm triggered |
| Four beeps | Fire triggered |
| One long beep | Disarmed |

Press **9** to replay Answer-Phone messages.

While replaying a message, press **#** for 2 seconds to skip to the end of the message and hear the next message.

Press **0** to delete all Answer Phone messages.

Press **#** to end the session and hang up the Control Panel line.

CONNECTION TO HOME AUTOMATION MODULES

Under the disarm mode, the on/off power of a series of home automation receiver modules can be controlled by the Control Panel as follows:

1. **BH002/003:** Press  on the Control Panel's keypad and then key in the unit code (numbered 1-8) of home automation receiver modules to turn on the power manually.

Press  on the Control Panel's keypad and then key in the unit code (numbered 1-8) of home automation receiver modules to turn off the power manually.

2. **BH004/006:** Press  on the Control Panel's keypad and then key in the unit code (numbered 1-8) of home automation receiver modules to turn on and turn off the power manually.

Note: To turn on and turn off the lighting fixture connected to BH004/006, simply using  as a toggle switch.

Note: Prior to adjusting the dimmer brightness, the prerequisite is to turn on the lighting fixture.

Press  on the Control Panel's keypad and then key in the unit code (numbered 1-8) of home automation receiver modules to start dimmer cycle.

Press  on the Control Panel's keypad and then key in the unit code (numbered 1-8) of home automation receiver modules to select the dimmer brightness you desire.

BATTERY MONITORING

All system devices continuously monitor their battery condition. The Control Panel also monitors the battery condition of all PIR and Magnetic detectors. If the battery level of any device drops below acceptable levels then its low battery indication will be activated. In addition if any PIR or Magnetic Contact detector has a low battery status it will be recorded by the Control Panel and a message stored in the event log.

In the event of AC adaptor being disconnected from the Control Panel, the Control Panel by consuming the DC rechargeable battery can sustain 2 days of normal operation (under standby mode) . However, the battery for that device should be replaced as soon as possible.

Note: Before removing the battery cover on any device to replace the battery ensure that the system is put into Test mode to avoid initiating a Full Alarm condition.

The low battery indication for each system component is as follows:

Control Panel

During a period of mains supply interruption the Control Panel will be powered by the rechargeable backup batteries. Under normal battery conditions the Power LED on the panel will flash at 1s intervals. However, under low battery conditions the Power LED will flash at 3s intervals.

Remote Control

When the Remote Control is operated under low battery conditions the transmit LED will continue to flash after the button has been released.

Under normal battery conditions the LED will extinguish when the button is released.

PIR Detectors

Under low battery conditions the LED behind the detector lens will flash when movement is detected to indicate that the battery needs to be replaced.

Under normal battery conditions the LED does not illuminate unless the PIR detector is in Walk Test mode.

Magnetic Contact Detectors

Under low battery conditions, when the Detector is activated the transmit LED will be illuminated for approximately 1s as the door/window is opened.

Under normal battery conditions the LED will not illuminate as the Detector is operated, (unless the Detector is in Test Mode with the battery cover removed).

MAINTENANCE

Your Alarm System requires very little maintenance. However, a few simple tasks will ensure its continued reliability and operation.

CONTROL PANEL

The rechargeable batteries have a typical life of 3-4 years and need no maintenance during this period, provided they are kept charged. The batteries will be damaged if they are stored in a discharged state for long periods.

DETECTORS AND REMOTE CONTROL

The Detectors require very little maintenance. The batteries should be replaced once a year or when a low battery status is indicated.

IMPORTANT: Should you, for any reason, have to completely power-down the system (e.g. to move the system to a new premises) first put the system into Test mode before removing the Control Panel cover and disconnecting the power supply and backup batteries.

BATTERIES

Before removing the battery cover on any device to replace the battery, ensure that the system is put into Test mode to avoid initiating an Alarm.

The specifications for replacement batteries are as follows:

Remote Controls	1 x 3V CR2032 Lithium Cells (or equivalent)
Magnetic Contact Detectors	2 x 3V CR2032 Lithium Cells (or equivalent)
PIR Detectors	1 x 9V PP3 Alkaline

Note: Where applicable only fit PP3 Alkaline type batteries. Rechargeable batteries should NOT be fitted.

At the end of their useful life the batteries should be disposed of via a suitable Recycling Centre. Do not dispose of with your normal household waste. DO NOT BURN.

The Rechargeable batteries contain Sulphuric Acid – DO NOT ATTEMPT TO OPEN THE CASING.

ALARM RECORD

Complete the following information during installation for future reference when adding to your system and to assist Trouble Shooting.

Zone	Detector Type(s)	Location	Zone Settings						
			Type	Final Exit	Entry Delay	Chime	Arm	Part-Arm 1	Part-Arm 2
1									
2									
3									
4									
5									
6									
7									
8									
9									
10									

You may make a note of your User Password and Installer Password below.

System Password

User 1: _____ User 2: _____
 User 4: _____ User 5: _____
 Master User: _____

System House Code

Use the diagram to record your House Code

e.g.

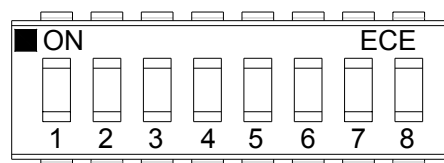
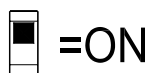

Voice Dialer Phone Numbers

Phone No. 1: _____
 Phone No. 3: _____

Latch-Key Phone Numbers

Phone No. 1: _____ Phone No. 2: _____

Digital Dialer Phone Numbers

Phone No. _____ System ID No. _____

This information is confidential and should be kept in a safe location.

TROUBLE SHOOTING

Control Unit not working – Power LED OFF or flashing

1. Mains power failure – check if other electrical circuits are operable.
2. Check that mains adaptor is plugged in and socket is switched ON.
3. Check mains fuse in Plug has not blown.
4. Check that DC jack plug from mains adaptor is connected in Control Panel.
5. Check fuse/MCB in Consumer Unit on the circuit serving the Control Panel.

Note: Before replacing any fuses or resetting the MCB, the cause of the failure should be investigated and rectified.

Control Unit not accepting User Password

1. Pause between key depressions too long. Do not pause for more than 5 seconds between pressing keys.
2. Incorrect code entered.
3. Reset to factory defaults and reprogram system.

Control Unit not responding to detectors

1. Ensure that the 'House Code' is correctly set.
2. Ensure detector is within effective radio range of Control Panel and equipment is not mounted close to metal objects.
3. Detector battery low – replace battery.

Voice-Dialer not responding to Alarm

1. Telephone line not connected or faulty – check phone line with another phone
2. Dial Method incorrectly programmed
3. Incorrect phone numbers programmed
4. Phone numbers disabled in dialing sequence
5. Alarm messages not recorded

Answer-Phone not responding or recording messages

1. Telephone line not connected or faulty – check phone line with another phone
2. Dial Method incorrectly programmed
3. Answer-Phone disabled
4. No space in message store, 6 messages already recorded.

Cannot record Voice-Memo message at Control Panel

1. No space in message store, 6 messages already recorded.

Control Unit not contacting central monitoring station service on alarm

1. Telephone line not connected or faulty – check phone line with another phone.
2. Dial Method incorrectly programmed.
3. Incorrect phone number for central monitoring station service programmed
4. Incorrect system ID number for central monitoring station service programmed.
5. Central monitoring station service not commissioned or signed up.

Control Unit not responding to Remote Phone Access

1. Telephone line not connected or faulty – check phone line with another phone
2. Remote Access disabled
3. Incorrect User Password entered

Latch Key not responding when system disarmed

1. Telephone line not connected or faulty – check phone line with another phone
2. Dial Method incorrectly programmed
3. Latch-Key disabled
4. Latch Key set to Selected-Users and not enabled for User that is Disarming the system
5. No Latch-Key phone numbers programmed

Full alarm condition occurs when system has not been triggered by an intruder or is disarmed

1. Tamper switch activation
 - check all detector battery covers to ensure correctly fitted
 - check Control Panel and Siren are securely mounted to the wall and tamper switch is closed
2. Panic alarm operated from a Remote Control or Keypad
3. Jamming detection circuit operated

LED on remote control not illuminating, or is dim when unit is operated

1. Ensure battery is connected with correct polarity
2. Ensure battery connections are good
3. Replace battery

PIR Detector false alarming

1. Ensure that the detector is not pointing at a source of heat or a moving object
2. Ensure that the detector is not mounted above a radiator or heater
3. Ensure that the detector is not facing a window or in direct sunlight
4. Ensure that the detector is not in a draughty area
5. Sensitivity detection set too high –reset to low sensitivity detection

PIR Detector not detecting a person's movement

1. Check battery connections are good.
2. Sensitivity detection set too low– reset to high sensitivity detection.
3. Check that the detector is correctly set up.
4. Ensure DIP switches 1-4 of SW3 are correctly set.
5. Ensure that detector is mounted the correct way up.
(i.e. with detection window at the bottom)
6. Ensure that the detector is mounted at the correct height, (i.e. 2-2.5m).
7. Allow up to three minutes for detector to stabilize.

PIR Detector LED flashes on detection of movement, (device in normal operation mode)

1. Low battery – replace battery.

Magnetic Contact Detector not working

1. Ensure batteries are connected with correct polarity.
2. Ensure battery connections are good.
3. Ensure 'House Code' is correctly set.
4. Ensure DIP switches 9, 10 and 11 are set correctly.
5. If no external contacts are connected ensure jumper link fitted.
6. If external contacts are connected
 - a. Ensure jumper link removed
 - b. Check that all contacts are closed.
 - c. Check all contacts are wired in series.

Magnetic Contact Detector false alarming

1. Ensure that gap between magnet and detector is less than 10mm.
2. Tamper switch below battery cover not depressed – check battery cover is fitted correctly and that fixing lugs are not broken.

LED on Magnetic Contact Detector illuminating when door or window is opened.

1. Low battery – replace batteries.

DIGITAL DIALER TRANSMISSION PROTOCOL

Contact ID Event Codes

Definition	Code
Fire/Smoke Alarm	110
Panic Alarm	120
Intruder Alarm	130
24hr Intruder	133
System Tamper	137
AC Failure	301
System Low Battery	302
Sensor Tamper	383
Sensor Low Battery	384
Cancel/Abort Alarm	406
System Test	601
Open/Close by User	401

FEDERAL COMMUNICATION COMMISSION INTERFERENCE STATEMENT

This equipment has been tested and found to comply with the limits for a Class B digital device, pursuant to Part 15 of the FCC Rules. These limits are designed to provide reasonable protection against harmful interference in a residential installation. This equipment generates, uses and can radiate radio frequency energy and, if not installed and used in accordance with the instructions, may cause harmful interference to radio communications. However, there is no guarantee that interference will not occur in a particular installation. If this equipment does cause harmful interference to radio or television reception, which can be determined by turning the equipment off and on, the user is encouraged to try to correct the interference by one of the following measures:

- Reorient or relocate the receiving antenna.
- Increase the separation between the equipment and receiver.
- Connect the equipment into an outlet on a circuit different from that to which the receiver is connected.
- Consult the dealer or an experienced radio/TV technician for help.

FCC Caution: Any changes or modifications not expressly approved by the party responsible for compliance could void the user's authority to operate this equipment.

This device complies with Part 15 of the FCC Rules. Operation is subject to the following two conditions: (1) This device may not cause harmful interference, and (2) this device must accept any interference received, including interference that may cause undesired operation.