



**FCC 47 CFR PART 15 SUBPART C & INDUSTRY CANADA RSS-310**

**TEST REPORT**

**For**

**Optical Mouse**

**Model: RF-WTRMS**

**Trade Name: KYE, rocketfish**

*Issued to*

**KYE SYSTEMS CORP.  
No.492,Sec.5,Chung Hsin Rd.,San Chung,  
Taipei Hsien,241,Taiwan,R.O.C.**

*Issued by*

**Compliance Certification Services Inc.  
No. 81-1, Lane 210, Bade Rd. 2, Luchu Hsiang,  
Taoyuan Hsien, (338) Taiwan, R.O.C.  
<http://www.ccsemc.com.tw>  
[service@tw.ccsemc.com](mailto:service@tw.ccsemc.com)**



---

*Note: This report shall not be reproduced except in full, without the written approval of Compliance Certification Services Inc. This document may be altered or revised by Compliance Certification Services Inc. personnel only, and shall be noted in the revision section of the document.*



## TABLE OF CONTENTS

<b>1. TEST RESULT CERTIFICATION.....</b>	<b>3</b>
<b>2. EUT DESCRIPTION .....</b>	<b>4</b>
<b>3. TEST METHODOLOGY .....</b>	<b>5</b>
3.1 EUT CONFIGURATION .....	5
3.2 EUT EXERCISE .....	5
3.3 GENERAL TEST PROCEDURES .....	5
3.4 FCC PART 15.205 RESTRICTED BANDS OF OPERATIONS .....	6
3.5 DESCRIPTION OF TEST MODES .....	6
<b>4. INSTRUMENT CALIBRATION.....</b>	<b>7</b>
4.1 MEASURING INSTRUMENT CALIBRATION .....	7
4.2 MEASUREMENT EQUIPMENT USED .....	7
<b>5. FACILITIES AND ACCREDITATIONS .....</b>	<b>8</b>
5.1 FACILITIES .....	8
5.2 EQUIPMENT .....	8
5.3 TABLE OF ACCREDITATIONS AND LISTINGS .....	9
<b>6. SETUP OF EQUIPMENT UNDER TEST .....</b>	<b>10</b>
6.1 SETUP CONFIGURATION OF EUT .....	10
6.2 SUPPORT EQUIPMENT .....	10
<b>7. FCC PART 15.227 REQUIREMENTS.....</b>	<b>11</b>
7.1 20 DB BANDWIDTH .....	11
7.2 99% BANDWIDTH .....	13
7.3 RADIATED EMISSIONS .....	15
7.4 POWERLINE CONDUCTED EMISSIONS .....	19
<b>APPENDIX I PHOTOGRAPHS OF TEST SETUP .....</b>	<b>22</b>



# 1. TEST RESULT CERTIFICATION

**Applicant:** KYE SYSTEMS CORP.  
 No.492,Sec.5,Chung Hsin Rd.,San Chung,  
 Taipei Hsien,241,Taiwan,R.O.C.

**Equipment Under Test:** Optical Mouse

**Trade Name:** KYE, rocketfish

**Model:** RF-WTRMS

**Date of Test:** July 7 ~ 13, 2006

APPLICABLE STANDARDS	
STANDARD	TEST RESULT
FCC 47 CFR Part 15 Subpart C, Industry Canada RSS-310 Issue 1 September, 2005	No non-compliance noted

### We hereby certify that:

The above equipment was tested by Compliance Certification Services Inc. The test data, data evaluation, test procedures, and equipment configurations shown in this report were made in accordance with the procedures given in ANSI C63.4: 2003 and the energy emitted by the sample tested as described in this report is in compliance with the requirements of FCC Rules Part 15.227 and Industry Canada RSS-310.

The test results of this report relate only to the tested sample identified in this report.

*Approved by:*

*Reviewed by:*

\_\_\_\_\_  
 Gavin Lim  
 Section Manager  
 Compliance Certification Services Inc.

\_\_\_\_\_  
 Amanda Wu  
 Section Manager  
 Compliance Certification Services Inc.



## 2. EUT DESCRIPTION

<b>Product</b>	Optical Mouse
<b>Trade Name</b>	KYE, rocketfish
<b>Model Number</b>	RF-WTRMS
<b>Model Difference</b>	N/A
<b>Power Supply</b>	Powered by AAA batteries × 2 (Rating: 2 × 1.5Vdc)
<b>Frequency Range</b>	27.045 MHz
<b>Modulation Technique</b>	FSK

**Remark:**

1. *The sample selected for test was production product and was provided by manufacturer.*
2. *This submittal(s) (test report) is intended for FCC ID: **FSUKM001** filing to comply with Section 15.227 of the FCC Part 15, Subpart C Rules.*



### **3. TEST METHODOLOGY**

The tests documented in this report were performed in accordance with ANSI C63.4, FCC 47 CFR 2.1046, 2.1047, 2.1049, 2.1051, 2.1053, 2.1055, 2.1057, 15.227, IC RSS-310, IC RSS-Gen and IC RSS-212.

#### **3.1 EUT CONFIGURATION**

The EUT configuration for testing is installed on RF field strength measurement to meet the Commissions requirement and operating in a manner that intends to maximize its emission characteristics in a continuous normal application.

#### **3.2 EUT EXERCISE**

The EUT was operated in the engineering mode to fix the TX frequency that was for the purpose of the measurements.

#### **3.3 GENERAL TEST PROCEDURES**

##### **Conducted Emissions**

The EUT is placed on the turntable, which is 0.8 m above ground plane according to the requirements in Section 13.1.4.1 of ANSI C63.4. Conducted emissions from the EUT measured in the frequency range between 0.15 MHz and 30MHz using CISPR Quasi-peak and average detector modes.

##### **Radiated Emissions**

The EUT is placed on a turn table, which is 0.8 m above ground plane. The turntable shall rotate 360 degrees to determine the position of maximum emission level. EUT is set 3m away from the receiving antenna, which varied from 1m to 4m to find out the highest emission. And also, each emission was to be maximized by changing the polarization of receiving antenna both horizontal and vertical. In order to find out the maximum emissions, exploratory radiated emission measurements were made according to the requirements in Section 13.1.4.1 of ANSI C63.4.



### 3.4 FCC PART 15.205 RESTRICTED BANDS OF OPERATIONS

(a) Except as shown in paragraph (d) of this section, only spurious emissions are permitted in any of the frequency bands listed below:

MHz	MHz	MHz	GHz
0.090 - 0.110	16.42 - 16.423	399.9 - 410	4.5 - 5.15
<sup>1</sup> 0.495 - 0.505	16.69475 - 16.69525	608 - 614	5.35 - 5.46
2.1735 - 2.1905	16.80425 - 16.80475	960 - 1240	7.25 - 7.75
4.125 - 4.128	25.5 - 25.67	1300 - 1427	8.025 - 8.5
4.17725 - 4.17775	37.5 - 38.25	1435 - 1626.5	9.0 - 9.2
4.20725 - 4.20775	73 - 74.6	1645.5 - 1646.5	9.3 - 9.5
6.215 - 6.218	74.8 - 75.2	1660 - 1710	10.6 - 12.7
6.26775 - 6.26825	108 - 121.94	1718.8 - 1722.2	13.25 - 13.4
6.31175 - 6.31225	123 - 138	2200 - 2300	14.47 - 14.5
8.291 - 8.294	149.9 - 150.05	2310 - 2390	15.35 - 16.2
8.362 - 8.366	156.52475 -	2483.5 - 2500	17.7 - 21.4
8.37625 - 8.38675	156.52525	2655 - 2900	22.01 - 23.12
8.41425 - 8.41475	156.7 - 156.9	3260 - 3267	23.6 - 24.0
12.29 - 12.293	162.0125 - 167.17	3332 - 3339	31.2 - 31.8
12.51975 - 12.52025	167.72 - 173.2	3345.8 - 3358	36.43 - 36.5
12.57675 - 12.57725	240 - 285	3600 - 4400	( <sup>2</sup> )
13.36 - 13.41	322 - 335.4		

<sup>1</sup> Until February 1, 1999, this restricted band shall be 0.490-0.510 MHz.

<sup>2</sup> Above 38.6

(b) Except as provided in paragraphs (d) and (e), the field strength of emissions appearing within these frequency bands shall not exceed the limits shown in Section 15.209. At frequencies equal to or less than 1000 MHz, compliance with the limits in Section 15.209 shall be demonstrated using measurement instrumentation employing a CISPR quasi-peak detector. Above 1000 MHz, compliance with the emission limits in Section 15.209 shall be demonstrated based on the average value of the measured emissions. The provisions in Section 15.35 apply to these measurements.

### 3.5 DESCRIPTION OF TEST MODES

The EUT (model: RF-WTRMS) had been tested under engineering test mode condition and the EUT staying in continuous transmitting mode.



## 4. INSTRUMENT CALIBRATION

### 4.1 MEASURING INSTRUMENT CALIBRATION

The measuring equipment, which was utilized in performing the tests documented herein, has been calibrated in accordance with the manufacturer's recommendations for utilizing calibration equipment, which is traceable to recognized national standards.

### 4.2 MEASUREMENT EQUIPMENT USED

#### Equipment Used for Emissions Measurement

*Remark: Each piece of equipment is scheduled for calibration once a year.*

3M Semi Anechoic Chamber				
Name of Equipment	Manufacturer	Model	Serial Number	Calibration Due
Spectrum Analyzer	Agilent	E4446A	US42510252	07/25/2006
Spectrum Analyzer	Rohde&Schwarz	FSEK30	100264	03/22/2007
Test Receiver	Rohde&Schwarz	ESCI	100064	11/05/2006
Switch Controller	TRC	Switch Controller	SC94050010	05/05/2007
4 Port Switch	TRC	4 Port Switch	SC94050020	05/05/2007
Horn-Antenna	TRC	HA-0502	06	07/09/2007
Horn-Antenna	TRC	HA-0801	04	05/05/2007
Horn-Antenna	TRC	HA-1201A	01	07/04/2007
Horn-Antenna	TRC	HA-1301A	01	07/04/2007
Loop Antenna	EMCO	6502	8905/2356	06/03/2007
Bilog- Antenna	Sunol Sciences	JB3	A030205	03/09/2007
Turn Table	Max-Full	MFT-120S	T120S940302	N.C.R.
Antenna Tower	Max-Full	MFA-430	A440940302	N.C.R.
Controller	Max-Full	MF-CM886	CC-C-1F-13	N.C.R.
Site NSA	CCS	N/A	FCC: 965860 IC: IC 6106	09/26/2008
Test S/W	LABVIEW (V 6.1)			

*Remark: The measurement uncertainty is less than +/-2.0065dB (30MHz ~ 1GHz), +/-3.0958dB (Above 1GHz) which is evaluated as per the NAMAS NIS 81 and CISPR/A/291/CDV.*

Powerline Conducted Emissions Test Site				
Name of Equipment	Manufacturer	Model	Serial Number	Calibration Due
EMI TEST RECEIVER 9kHz-30MHz	ROHDE & SCHWARZ	ESHS30	828144/003	09/27/2006
TWO-LINE V-NETWORK 9kHz-30MHz	SCHAFFNER	NNB41	03/10013	06/12/2007
LISN 10kHz-100MHz	EMCO	3825/2	9106-1809	03/20/2007
Test S/W	LABVIEW (V 6.1)			

*Remark: The measurement uncertainty is less than +/- 2.81dB, which is evaluated as per the NAMAS NIS 81 and CISPR/A/291/CDV.*



## 5. FACILITIES AND ACCREDITATIONS

### 5.1 FACILITIES

All measurement facilities used to collect the measurement data are located at

No.199, Chunghsen Road, Hsintien City, Taipei Hsien, Taiwan, R.O.C.

Tel: 886-2-2217-0894 / Fax: 886-2-2217-1029

No.11, Wugong 6th Rd., Wugu Industrial Park, Taipei Hsien 248, Taiwan

Tel: 886-2-2299-9720 / Fax: 886-2-2298-4045

No.81-1, Lane 210, Bade 2nd Rd., Luchu Hsiang, Taoyuan Hsien 338, Taiwan

Tel: 886-3-324-0332 / Fax: 886-3-324-5235

The sites are constructed in conformance with the requirements of ANSI C63.7, ANSI C63.4 and CISPR Publication 22.

### 5.2 EQUIPMENT

Radiated emissions are measured with one or more of the following types of linearly polarized antennas: tuned dipole, biconical, log periodic, bi-log, and/or ridged waveguide, horn. Spectrum analyzers with pre-selectors and quasi-peak detectors are used to perform radiated measurements.







Conducted emissions are measured with Line Impedance Stabilization Networks and EMI Test Receivers.

Calibrated wideband preamplifiers, coaxial cables, and coaxial attenuators are also used for making measurements.

All receiving equipment conforms to CISPR Publication 16-1, "Radio Interference Measuring Apparatus and Measurement Methods."



### 5.3 TABLE OF ACCREDITATIONS AND LISTINGS

Country	Agency	Scope of Accreditation	Logo
USA	A2LA	EN 55011, EN 55014-1/2, CISPR 11, CISPR 14-1/2, EN 55022, EN 55015, CISPR 22, CISPR 15, AS/NZS 3548, VCCI V3 (2001), CFR 47, FCC Part 15/18, CNS 13783-1, CNS 13439, CNS 13438, CNS 13803, CNS 14115, EN 55024, IEC 801-2, IEC 801-3, IEC 801-4, IEC/EN 61000-3-2, EIC/EN 61000-3-3, IEC/EN 61000-4-2/3/4/5/6/8/11, EN 50081-1/ EN 61000-6-3, EN 50081-2/EN 61000-6-4, EN 50081-2/EN 61000-6-1: 2001	 0824-01
USA	FCC	3/10 meter Open Area Test Sites (93105, 90471) / 3M Semi Anechoic Chamber (965860) to perform FCC Part 15/18 measurements	 93105, 90471 965860
Japan	VCCI	3/10 meter Open Area Test Sites to perform conducted/radiated measurements	 R-393/1066/725/879 C-402/747/912
Norway	NEMKO	EN 50081-1/2, EN 50082-1/2, IEC 61000-6-1/2, EN 50091-2, EN 50130-4, EN 55011, EN 55013, EN 55014-1/2, EN 55015, EN 55022, EN 55024, EN 61000-3-2/3, EN 61326-1, IEC 61000-4-2/3/4/5/6/8/11, EN 60601-1-2, EN 300 328, EN 300 422-2, EN 301 419-1, EN 301 489-01/03/07/08/09/17, EN 301 419-2/3, EN 300 454-2, EN 301 357-2	 ELA 124a ELA 124b ELA 124c
Taiwan	TAF	EN 300 328, EN 300 220-1, EN 300 220-2, EN 300 220-3, 47 CFR FCC Part 15 Subpart C, EN 61000-3-2, EN 61000-3-3, CNS 13439, CNS 13783-1, CNS 14115, CNS 13438, AS/NZS CISPR 22, CNS 13022-1, IEC 61000-4-2/3/4/5/6/8/11, CNS 13022-2/3	
Taiwan	BSMI	CNS 13438, CNS 13783-1, CNS 13439, CNS 14115	 SL2-IS-E-0014 SL2-IN-E-0014 SL2-A1-E-0014 SL2-R1-E-0014 SL2-R2-E-0014 SL2-L1-E-0014
Canada	Industry Canada	3/10 meter Open Area Test Sites (IC 3991-3, IC 3991-4) / 3M Semi Anechoic Chamber (IC 6106) to perform RSS 212 Issue 1	 IC 3991-3 IC 3991-4 IC 6106

\* No part of this report may be used to claim or imply product endorsement by A2LA or any agency of the US Government.



## 6. SETUP OF EQUIPMENT UNDER TEST

### 6.1 SETUP CONFIGURATION OF EUT

See test photographs attached in Appendix I for the actual connections between EUT and support equipment.

### 6.2 SUPPORT EQUIPMENT

No.	Device Type	Brand	Model	Series No.	FCC ID	Data Cable	Power Cord
1.	Notebook PC	IBM	2672 (X31)	99PBTKB	WLAN: ANO20030400LEG Bluetooth: ANO20020100MTN	N/A	AC I/P: Unshielded, 1.8m DC O/P: Unshielded, 1.8m with a core

**Remark:**

1. All the equipment/cables were placed in the worst-case configuration to maximize the emission during the test.
2. Grounding was established in accordance with the manufacturer's requirements and conditions for the intended use.

## 7. FCC PART 15.227 REQUIREMENTS

### 7.1 20 DB BANDWIDTH

#### LIMIT

None; for reporting purposes only.

#### Test Configuration

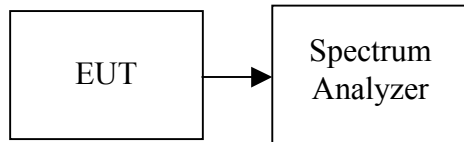

#### TEST PROCEDURE

1. Place the EUT on the table and set it in the transmitting mode.
2. Remove the antenna from the EUT and then connect a low loss RF cable from the antenna port to the spectrum analyzer.
3. Set the spectrum analyzer as RBW=1kHz, VBW = RBW, Span = 200kHz, Sweep = auto.
4. Mark the peak frequency and 20dB (upper and lower) frequency.
5. Repeat until all the rest channels are investigated.

#### TEST RESULTS

*No non-compliance noted*



**Test Plot**

Agilent 17:13:47 Jul 13, 2006

T

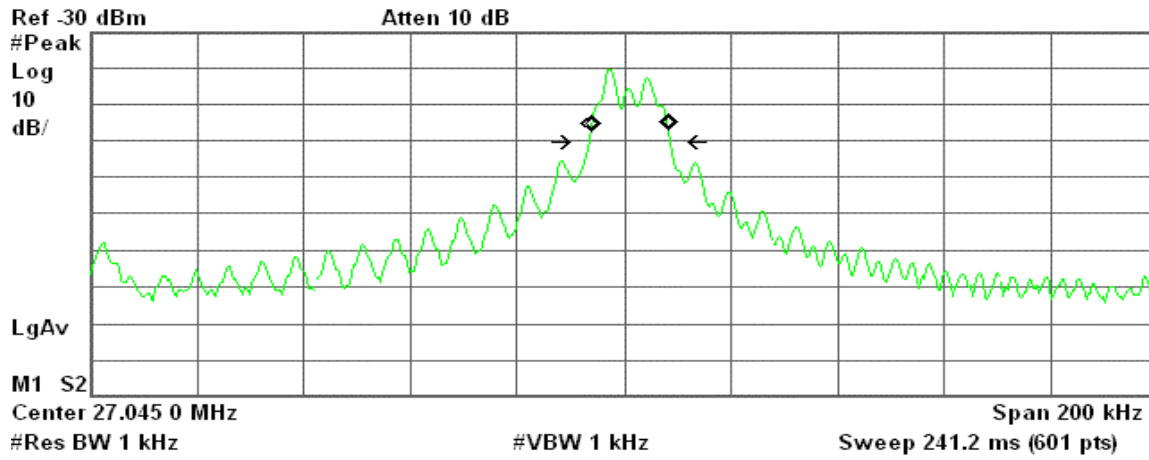

**Occupied Bandwidth**  
14.8107 kHz

Occ BW % Pwr	99.00 %
x dB	-20.00 dB

Transmit Freq Error	946.381 Hz
x dB Bandwidth	15.454 kHz



## 7.2 99% BANDWIDTH

### LIMIT

None; for reporting purposes only.

### Test Configuration

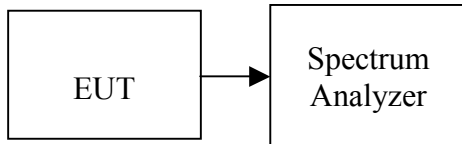

### TEST PROCEDURE

1. Place the EUT on the table and set it in the transmitting mode.
2. Remove the antenna from the EUT and then connect a low loss RF cable from the antenna port to the spectrum analyzer.
3. Set the spectrum analyzer as RBW=1kHz, VBW = RBW, Sweep = auto.
4. Record the max. reading.

### TEST RESULTS

Frequency (MHz)	B (kHz)
27.042	16.70



Test Plot

99% Bandwidth

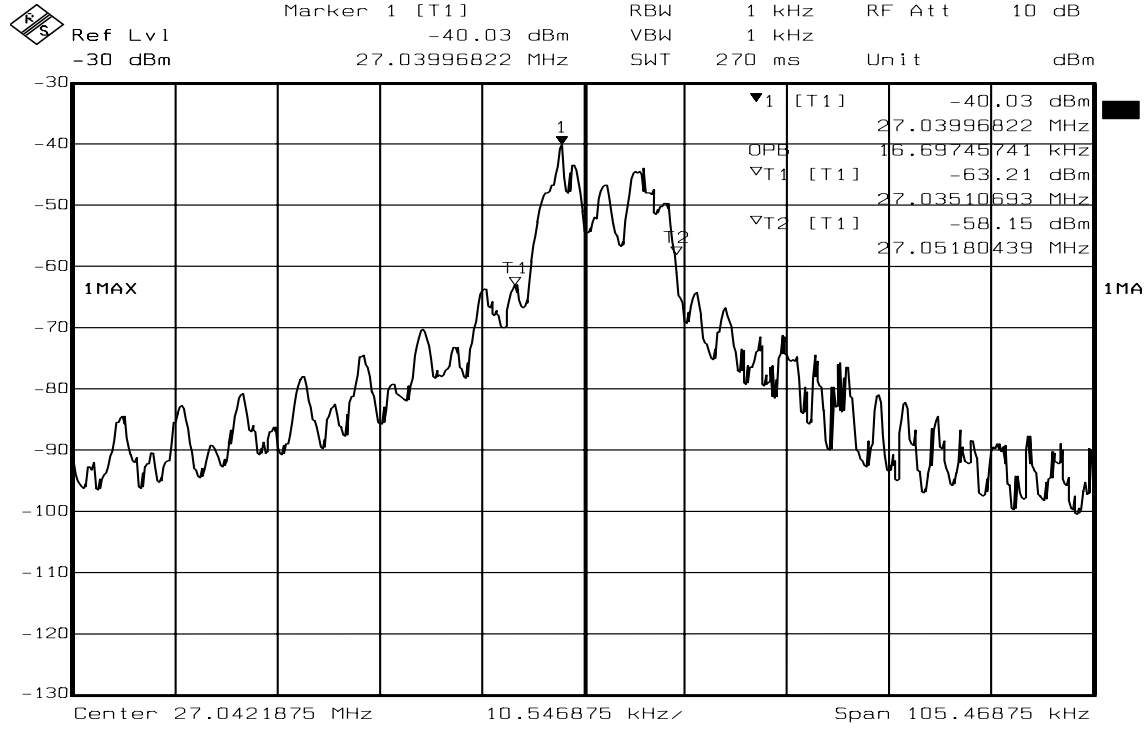

Date: 12.JUL.2006 11:25:16



## 7.3 RADIATED EMISSIONS

### LIMIT

The field strength of any emission within this band shall not exceed 10,000 microvolts/meter at 3 meters. The emission limit in this paragraph is based on measurement instrumentation employing an average detector. The provisions in Section 15.35 for limiting peak emissions apply.

The field strength of any emissions which appear outside of this band shall not exceed the general radiated emission limits in Section 15.209.

1. Except as provided elsewhere in this Subpart, the emissions from an intentional radiator shall not exceed the field strength levels specified in the following table:

Frequency (MHz)	Field Strength (mV/m)	Measurement Distance (m)
30-88	100*	3
88-216	150*	3
216-960	200*	3
Above 960	500	3

**Remark:** Except as provided in paragraph (g), fundamental emissions from intentional radiators operating under this Section shall not be located in the frequency bands 54-72 MHz, 76-88 MHz, 174-216 MHz or 470-806 MHz. However, operation within these frequency bands is permitted under other sections of this Part, e.g., Sections 15.231 and 15.241.

2. In the above emission table, the tighter limit applies at the band edges.

Frequency (MHz)	Field Strength ( $\mu$ V/m at 3-meter)	Field Strength (dB $\mu$ V/m at 3-meter)
30-88	100	40
88-216	150	43.5
216-960	200	46
Above 960	500	54

3. Except as provided elsewhere in this Subpart, the emissions from an intentional radiator shall not exceed the field strength levels specified in the following table:

Frequency (MHz)	Field Strength ( $\mu$ V/m at meter)	Measurement Distance (meter)
0.009 – 0.490	2400 / F (kHz)	300
0.490 – 1.705	24000 / F (kHz)	30
1.705 – 30.0	30	30
30 - 88	100**	3
88-216	150**	3
216-960	200**	3
Above 960	500	3

\*\* Except as provided in paragraph (g), fundamental emissions from intentional radiators operating under this Section shall not be located in the frequency bands 54-72 MHz, 76-88 MHz, 174-216 MHz or 470-806 MHz. However, operation within these frequency bands is permitted under other sections of this Part, e.g., Sections 15.231 and 15.241.

### Test Configuration

#### 9kHz ~ 30MHz

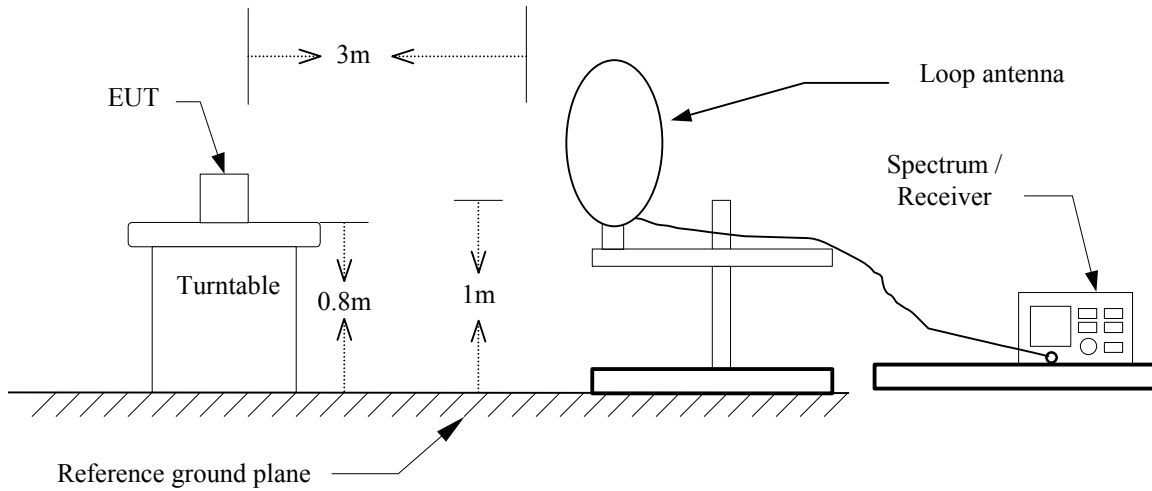

#### 30MHz ~ 1 GHz

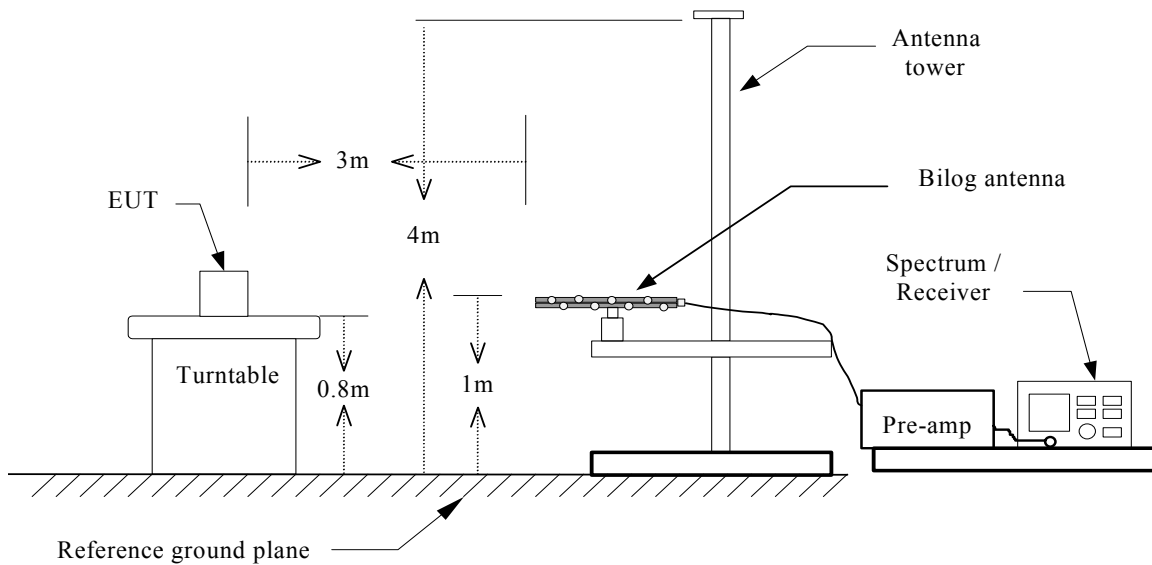





## **TEST PROCEDURE**

1. The EUT is placed on a turntable, which is 0.8m above ground plane.
2. The turntable shall be rotated for 360 degrees to determine the position of maximum emission level.
3. EUT is set 3m away from the receiving antenna, which is varied from 1m to 4m to find out the highest emissions.
4. Maximum procedure was performed on the six highest emissions to ensure EUT compliance.
5. And also, each emission was to be maximized by changing the polarization of receiving antenna both horizontal and vertical.
6. Set the spectrum analyzer in the following setting as:  
RBW=100kHz / VBW=300kHz / Sweep=AUTO
7. Repeat above procedures until the measurements for all frequencies are complete.

**TEST RESULTS**

**Operation Mode:** TX Mode                      **Test Date:** July 11, 2006  
**Temperature:** 25°C                              **Tested by:** Bruce Chen  
**Humidity:** 55 % RH                              **Polarity:** Ver. / Hor.

Frequency (MHz)	Ant.Pol. (H/V)	Detector Mode (PK/QP/AVG)	Reading (dBuV)	Correction Factor (dB/m)	Result (dBuV/m)	Limit 3m (dBuV/m)	Margin (dB)
27.04	V	Peak	54.79	-17.06	37.73	80.00	-42.27
54.25	V	Peak	39.11	-18.53	20.58	40.00	-19.42
135.08	V	Peak	29.00	-12.79	16.21	43.50	-27.29
275.73	V	Peak	29.59	-11.89	17.70	46.00	-28.30
324.23	V	Peak	31.54	-11.03	20.51	46.00	-25.49
448.72	V	Peak	30.67	-8.43	22.24	46.00	-23.76
458.42	V	Peak	30.45	-8.19	22.26	46.00	-23.74
27.05	H	Peak	55.73	-17.06	38.67	80.00	-41.33
54.25	H	Peak	36.18	-18.53	17.65	40.00	-22.35
172.27	H	Peak	31.70	-14.46	17.25	43.50	-26.25
243.40	H	Peak	30.90	-13.79	17.11	46.00	-28.89
275.73	H	Peak	29.03	-11.89	17.14	46.00	-28.86
296.75	H	Peak	28.88	-11.72	17.16	46.00	-28.84
324.23	H	Peak	30.68	-11.03	19.65	46.00	-26.35

**Remark:**

1. Measuring frequencies from 30 MHz to the 1GHz.
2. Radiated emissions measured in frequency range from 30 MHz to 1000MHz were made with an instrument using peak/quasi-peak detector mode.
3. Measurements above show only up to 6 maximum emissions noted, or would be lesser; with " N/A " remark, if no specific emissions from the EUT are recorded (ie: margin>20dB from the applicable limit) and considered that's already beyond the background noise floor.
4. Margin (dB) = Result (dBuV/m) – Limit (dBuV/m).



## 7.4 POWERLINE CONDUCTED EMISSIONS (FOR RSS-310 REPORT PURPOSE ONLY)

### LIMIT

According to §15.207(a), except as shown in paragraphs (b) and (c) of this section, for an intentional radiator that is designed to be connected to the public utility (AC) power line, the radio frequency voltage that is conducted back onto the AC power line on any frequency or frequencies within the band 150 kHz to 30 MHz shall not exceed the limits in the following table, as measured using a 50  $\mu$ H/50 ohms line impedance stabilization network (LISN). Compliance with the provisions of this paragraph shall be based on the measurement of the radio frequency voltage between each power line and ground at the power terminal. The lower limit applies at the boundary between the frequency ranges.

Frequency Range (MHz)	Limits (dB $\mu$ V)	
	Quasi-peak	Average
0.15 to 0.50	66 to 56*	56 to 46*
0.50 to 5	56	46
5 to 30	60	50

\* Decreases with the logarithm of the frequency.

### TEST PROCEDURE

1. The EUT was placed on a table, which is 0.8m above ground plane.
2. Maximum procedure was performed on the six highest emissions to ensure EUT compliance.
3. Repeat above procedures until all frequency measured were complete.

**TEST RESULTS**

Since the TX unit of this EUT is battery powered, the above test item is not applicable.  
The RX test result below is for IC RSS-310 reporting purposes only.

The initial step in collecting conducted data is a spectrum analyzer peak scan of the measurement range. Significant peaks are then marked as shown on the following data page, and these signals are then quasi-peaked.

**Test Data**

**Operation Mode:** Normal Link                      **Test Date:** July 7, 2006  
**Temperature:** 25°C                                      **Tested by:** Eric Cheng  
**Humidity:** 55% RH

Frequency (MHz)	QP Reading (dBuV)	AV Reading (dBuV)	Corr. factor (dB)	QP Result (dBuV)	AV Result (dBuV)	QP Limit (dBuV)	AV Limit (dBuV)	QP Margin (dB)	AV Margin (dB)	Note
0.246	45.480	42.020	0.100	45.580	42.120	61.891	51.891	-16.311	-9.771	L1
0.363	46.580	39.990	0.100	46.680	40.090	58.660	48.660	-11.980	-8.570	L1
0.610	46.440	39.940	0.100	46.540	40.040	56.000	46.000	-9.460	-5.960	L1
0.968	46.140	35.970	0.100	46.240	36.070	56.000	46.000	-9.760	-9.930	L1
1.704	48.380	41.720	0.100	48.480	41.820	56.000	46.000	-7.520	-4.180	L1
12.006	37.920	32.850	0.740	38.660	33.590	60.000	50.000	-21.340	-16.410	L1
0.246	44.500	41.060	0.100	44.600	41.160	61.891	51.891	-17.291	-10.731	L2
0.366	46.200	40.980	0.100	46.300	41.080	58.591	48.591	-12.291	-7.511	L2
0.610	46.360	39.740	0.100	46.460	39.840	56.000	46.000	-9.540	-6.160	L2
0.852	47.630	38.580	0.100	47.730	38.680	56.000	46.000	-8.270	-7.320	L2
1.704	48.320	41.560	0.100	48.420	41.660	56.000	46.000	-7.580	-4.340	L2
15.248	39.010	34.630	0.820	39.830	35.450	60.000	50.000	-20.170	-14.550	L2

***Remark:***

- 1. Measuring frequencies from 0.15 MHz to 30MHz.*
- 2. The emissions measured in frequency range from 0.15 MHz to 30MHz were made with an instrument using Quasi-peak detector and average detector.*
- 3. The IF bandwidth of SPA between 0.15MHz to 30MHz was 10kHz; the IF bandwidth of Test Receiver between 0.15MHz to 30MHz was 9kHz;*
- 4. L1 = Line One (Live Line) / L2 = Line Two (Neutral Line)*



### Test Plots

#### Conducted emissions (Line 1)

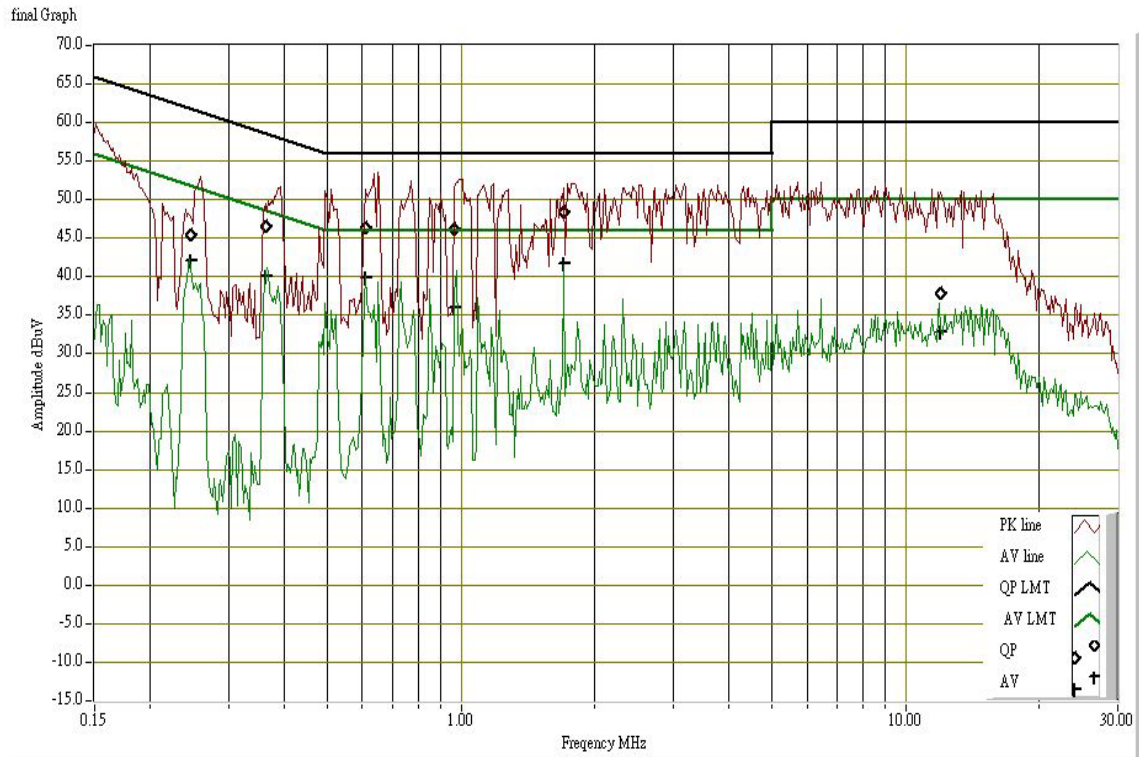

#### Conducted emissions (Line 2)

