

FCC TEST REPORT

for

CISPR PUB. 22 Class B

Equipment : TABLET
Model No. : Easy Pen PRO USB
FCC ID : FSUGTU504
Filing Type : Original Grant
Applicant : **KYE SYSTEMS CORP.**
No. 492, Sec. 5, Chung Hsin Rd., San Chung,
Taipei Hsien, 241, Taiwan, R.O.C.

- The test result refers exclusively to the test presented test model / sample.
- Without the written authorization of the test lab., the Test Report may not be copied.
- **Certificate or Test Report must not be used by the applicant to claim the product in this test report endorsement by NVLAP or any agency of U.S. government.**

SPORTON International Inc.

6F, No.106, Sec. 1, Hsin Tai Wu Rd., Hsi Chih, Taipei Hsien, Taiwan, R.O.C.

Table of Contents

CERTIFICATE OF COMPLIANCE	3
1. General Description of Equipment under Test	4
1.1. Applicant	4
1.2. Manufacturer	4
1.3. Basic Description of Equipment under Test	4
1.4. Feature of Equipment under Test	4
2. Test Configuration of Equipment under Test	5
2.1. Test Manner	5
2.2. Description of Test System	5
2.3. Connection Diagram of Test System	7
3. Test Software	8
4. General Information of Test	9
4.1. Test Facility	9
4.2. Standard for Methods of Measurement	9
4.3. Test in Compliance with	9
4.4. Frequency Range Investigated	9
4.5. Test Distance	9
5. Test of Conducted Powerline	10
5.1. Major Measuring Instruments	10
5.2. Test Procedures	11
5.3. Typical Test Setup Layout of Conducted Powerline	12
5.4. Test Result of AC Powerline Conducted Emission	13
5.5. Photographs of Counducted Powerline Test Configuration	14
6. Test of Radiated Emission	16
6.1. Major Measuring Instruments	16
6.2. Test Procedures	17
6.3. Typical Test Setup Layout of Radiated Emission	18
6.4. Test Result of Radiated Emission	19
6.5. Photographs of Radiated Emission Test Configuration	20
7. Antenna Factor & Cable Loss	21
8. List of Measuring Equipments Used	21



CERTIFICATE OF COMPLIANCE

for

CISPR PUB. 22 Class B

Equipment : TABLET
Model No. : Easy Pen PRO USB
FCC ID : FSUGTU504
Applicant : **KYE SYSTEMS CORP.**
No. 492, Sec. 5, Chung Hsin Rd., San Chung,
Taipei Hsien, 241, Taiwan, R.O.C.

I **HEREBY** CERTIFY THAT :

The measurements shown in this test report were made in accordance with the procedures given in **ANSI C63.4 - 1992** and the energy emitted by this equipment was *passed* **CISPR PUB. 22** both radiated and conducted emission class B limits. Testing was carried out on May. 26, 1999 at **SPORTON International Inc.** LAB. in Lin Kou.

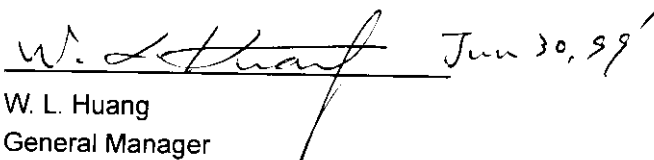
W. L. Huang
General Manager

SPORTON International Inc.

6F, No.106, Sec. 1, Hsin Tai Wu Rd., Hsi Chih, Taipei Hsien, Taiwan, R.O.C.

2. Test Configuration of Equipment under Test

2.1. Test Manner

- a. The EUT has been associated with personal computer and peripherals pursuant to ANSI C63.4-1992 and configuration operated in a manner which tended to maximize its emission characteristics in a typical application.
- b. The HITACHI Monitor, DELL PS/2 Keyboard, PRIMAX PS/2 Mouse, HP Printer, ACEEX Modem and EUT were connected to the FIC PC for EMI test.
- c. Frequency range investigated: conduction 150 KHz to 30 MHz, radiation 30 MHz to 1000MHz.

2.2. Description of Test System

Support Unit 1. -- Personal Computer (FIC)

FCC ID : N/A
Model No. : P2L97
Power Supply Type : Switching
Power Cord : Non-Shielded
Serial No. : SP0037
Data Cable : Shielded, 360 degree via metal backshells
Remark : This support device was tested to comply with FCC standards and authorized under a declaration of conformity.

Support Unit 2. -- Monitor (HITACHI)

FCC ID : N/A
Model No. : CM753ET
Power Supply Type : Switching
Power Cord : Non-Shielded
Serial No. : SP0176
Data Cable : Shielded, 360 degree via metal backshells, 1.15m
Remark : This support device was tested to comply with FCC standards and authorized under a declaration of conformity.

Support Unit 3. -- PS/2 Keyboard (DELL)

FCC ID : GYUM92SK
Model No. : AT101(DE8M)
Serial No. : SP0054
Data Cable : Shielded, 360 degree via metal backshells, 1.9m

Support Unit 4. -- PS/2 Mouse (PRIMAX)

FCC ID : EMJMUSJQ
Model No. : MUS9J
Serial No. : SP0045
Data Cable : Shielded, 360 degree via metal backshells, 1.7m

Support Unit 5. -- Printer (HP)

FCC ID : B94C2642X
Model No. : DeskJet 400
Power Supply Type : Linear
Power Cord : Non-Shielded
Serial No. : SP0048
Data Cable : Braided-Shielded, 360 degree via metal backshells, 1.35m

Support Unit 6. -- Modem (ACEEX)

FCC ID : IFAXDM1414
Model No. : DM1414
Power Supply Type : Linear
Power Cord : N/A
Serial No. : SP0076
Data Cable : Braided-Shielded, 360 degree via metal backshells

2.3. Connection Diagram of Test System

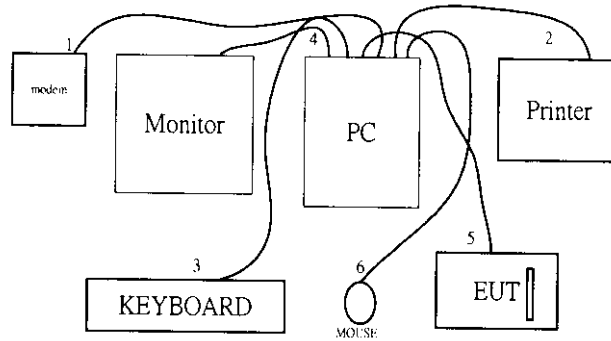

1. The I/O cable is connected from PC to the support unit 6.
2. The I/O cable is connected from PC to the support unit 5.
3. The I/O cable is connected from PC to the support unit 3.
4. The I/O cable is connected from PC to the support unit 2.
5. The I/O cable is connected from PC to the EUT .
6. The I/O cable is connected from PC to the support unit 4.

3. Test Software

An executive program, EMITEST.EXE under WIN 98, which generates a complete line of continuously repeating " H " pattern was used as the test software.

The program was executed as follows :

- a. Turn on the power of all equipment.
- b. The PC reads the test program from the floppy disk drive and runs it.
- c. The PC sends " H" messages to the monitor, and the monitor displays " H " patterns on the screen.
- d. The PC sends " H " messages to the printer, then the printer prints them on the paper.
- e. The PC sends " H " messages to the modem.
- f. The PC sends " H " messages to the internal Hard Disk, and the Hard Disk reads and writes the message.
- g. Repeat the steps from b to f.

An executive program, Paint under WIN98, was used as the test software.

4. General Information of Test

4.1. Test Facility

This test was carried out by SPORTON International Inc. in an openarea test site.
Openarea Test Site Location: No. 30-2, Lin 6, Diing-Fwu Tsuen, Lin-Kou-Hsiang,
Taipei Hsien, Taiwan, R.O.C.
TEL : 886-2-2601-1640
FAX : 886-2-2601-1695

4.2. Standard for Methods of Measurement

ANSI C63.4-1992

4.3. Test in Compliance with

CISPR PUB. 22 Class B

4.4. Frequency Range Investigated

- a. Conduction: from 150 kHz to 30 MHz
- b. Radiation : from 30 MHz to 1,000 MHz

4.5. Test Distance

The test distance of radiated emission from antenna to EUT is 10 M.

5. Test of Conducted Powerline

Conducted Emissions were measured from 150 kHz to 30 MHz with a bandwidth of 9 KHz on the 115 VAC power and return leads of the EUT according to the methods defined in ANSI C63.4-1992 Section 3.1. The EUT was placed on a nonmetallic stand in a shielded room 0.8 meters above the ground plane as shown in section 5.3. The interface cables and equipment positioning were varied within limits of reasonable applications to determine the position produced maximum conducted emissions.

5.1. Major Measuring Instruments

Test Receiver	HP 8591EM
Attenuation	0 dB
Start Frequency	0.15 MHz
Stop Frequency	30 MHz
Step MHz	0.007 MHz
IF Bandwidth	9 kHz

5.2. Test Procedures

- a. The EUT was placed 0.4 meter from the conducting wall of the shielding room was kept at least 80 centimeters from any other grounded conducting surface.
- b. Connect EUT to the power mains through a line impedance stabilization network (LISN).
- c. All the support units are connect to the other LISN.
- d. The LISN provides 50 ohm coupling impedance for the measuring instrument.
- e. The FCC states that a 50 ohm, 50 microhenry LISN should be used.
- f. Both sides of AC line were checked for maximum conducted interference.
- g. The frequency range from 150 kHz to 30 MHz was searched.
- h. Set the test-receiver system to Peak Detect Function and Specified Bandwidth with Maximum Hold Mode.
- i. If the emission level of the EUT in peak mode was 6 dB lower than the limit specified, then testing will be stopped and peak values of EUT will be reported, otherwise, the emissions which do not have 6 dB margin will be retested one by one using the quasi-peak method and reported.

5.3. Typical Test Setup Layout of Conducted Powerline

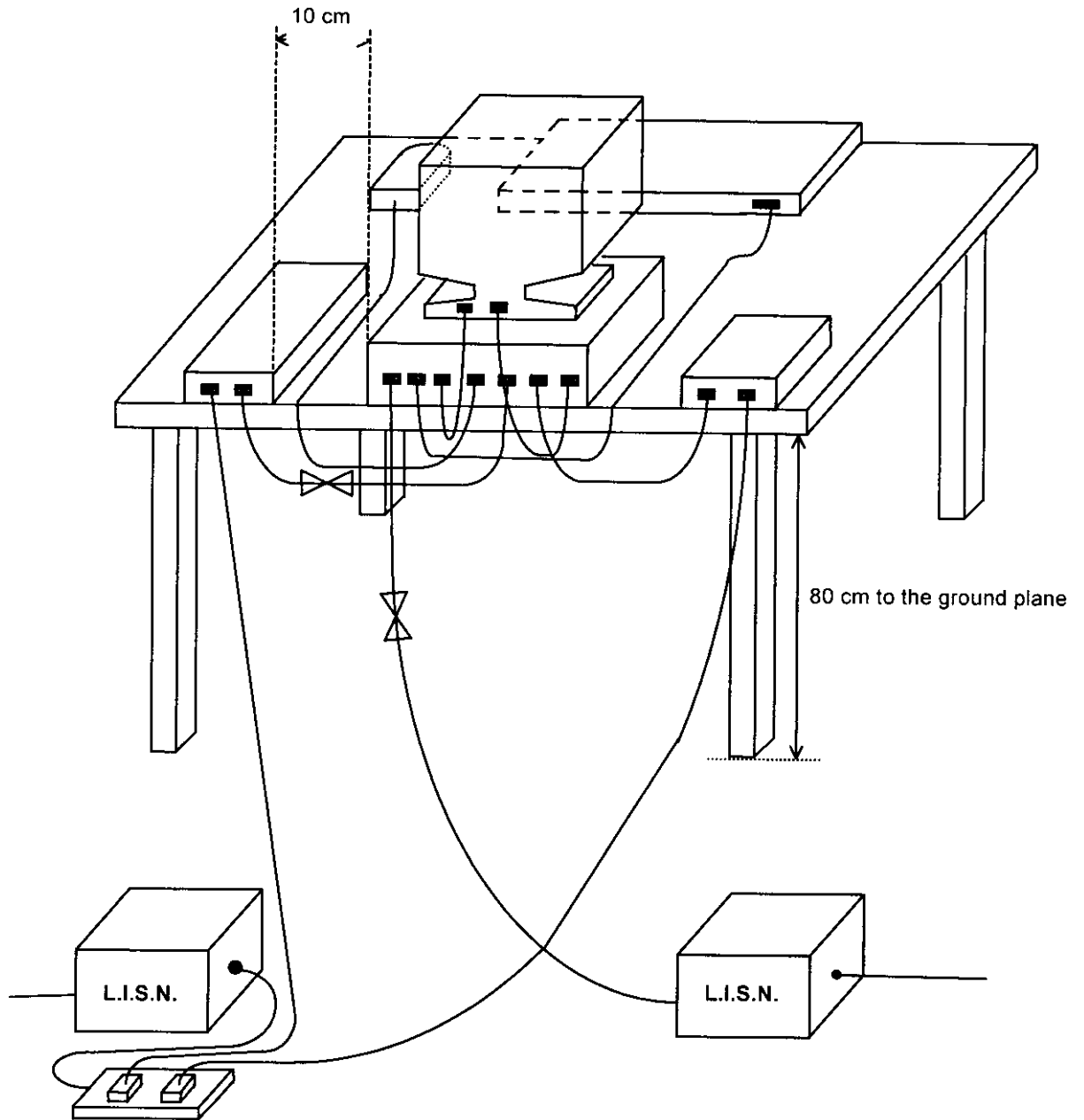

FCC TEST REPORT**5.4. Test Result of AC Powerline Conducted Emission**

- Frequency Range of Test : from 0.15 MHz to 30 MHz
- Temperature : 24°C
- Relative Humidity : 64 %
- Test Date : May. 26, 1999

The Conducted Emission test was passed at minimum margin

NEUTRAL 0.242 MHz / 44.60 dBuV.

Freq. (MHz)	Line or Neutral	Meter Reading				Limits				Margin	
		Q.P. (dBuV)	A.V. (dBuV)	Q.P. (uV)	A.V. (uV)	Q.P. (dBuV)	A.V. (dBuV)	Q.P. (uV)	A.V. (uV)	Q.P. (dB)	A.V. (dB)
0.241	L	44.00	43.50	158.49	149.62	62.07	52.07	1268.56	401.15	-18.07	-8.57
0.467	L	32.30	30.50	41.21	33.50	56.57	46.57	674.08	213.16	-24.27	-16.07
14.419	L	32.00	23.60	39.81	15.14	60.00	50.00	1000.00	316.23	-28.00	-26.40
0.242	N	44.60	44.10	169.82	160.32	62.03	52.03	1262.89	399.36	-17.43	-7.93
0.468	N	32.50	30.60	42.17	33.88	56.55	46.55	672.04	212.52	-24.05	-15.95
19.118	N	29.80	19.20	30.90	9.12	60.00	50.00	1000.00	316.23	-30.20	-30.80

Test Engineer :

Kenny Chuang
KENNY CHUANG

5.5. Photographs of Counducted Powerline Test Configuration

- The photographs show the configuration that generates the maximum emission.

FRONT VIEW



REAR VIEW

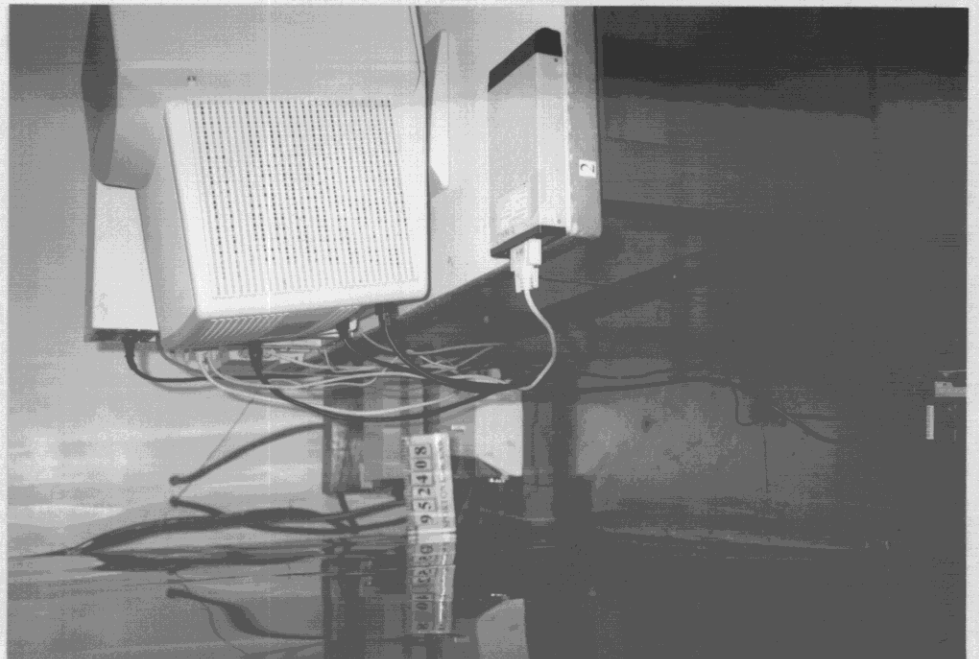

SIDE VIEW

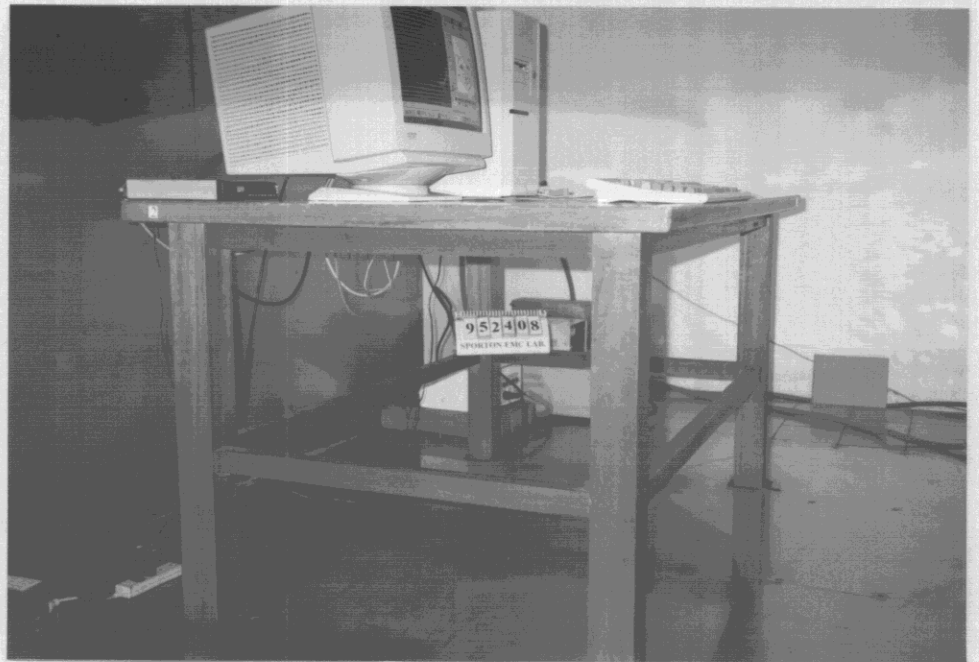

6. Test of Radiated Emission

Radiated emissions from 30 MHz to 1,000 MHz were measured with a bandwidth of 120 kHz according to the methods defines in ANSI C63.4-1992. The EUT was placed on a nonmetallic stand in the open-field site, 0.8 meter above the ground plane, as shown in section 6.3. The interface cables and equipment positions were varied within limits of reasonable applications to determine the positions producing maximum radiated emissions.

6.1. Major Measuring Instruments

- Amplifier (HP 8447D)
 - Attenuation 0 dB
 - RF Gain 25 dB
 - Signal Input 0.1 MHz to 1.3 GHz

- Spectrum Analyzer (ADVANTEST R3261A)
 - Attenuation 0 dB
 - Start Frequency 30 MHz
 - Stop Frequency 1000 MHz
 - Resolution Bandwidth 1 MHz
 - Video Bandwidth 1 MHz
 - Signal Input 9 KHz to 2.6 GHz

6.2. Test Procedures

- a. The EUT was placed on a rotatable table top 0.8 meter above ground.
- b. The EUT was set 10 meters from the interference receiving antenna which was mounted on the top of a variable height antenna tower.
- c. The table was rotated 360 degrees to determine the position of the highest radiation.
- d. The antenna is a half wave dipole and its height is varied between one meter and four meters above ground to find the maximum value of the field strength both horizontal polarization and vertical polarization of the antenna are set to make the measurement.
- e. For each suspected emission the EUT was arranged to its worst case and then tune the antenna tower (from 1 M to 4 M) and turn table (from 0 degree to 360 degrees) to find the maximum reading.
- f. Set the test-receiver system to Peak Detect Function and specified bandwidth with Maximum Hold Mode.
- g. If the emission level of the EUT in peak mode was 6 dB lower than the limit specified, then testing will be stopped and peak values of EUT will be reported, otherwise, the emissions which do not have 6 dB margin will be repeated one by one using the quasi-peak method and reported.

6.3. Typical Test Setup Layout of Radiated Emission

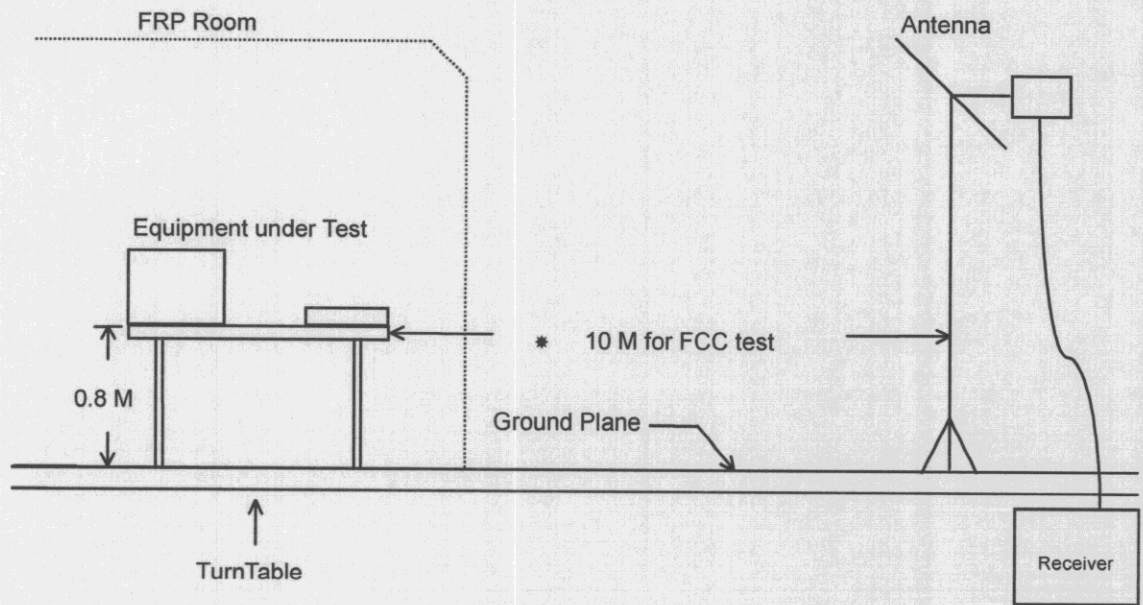

6.4. Test Result of Radiated Emission

- Frequency Range of Test : from 30 MHz to 1,000 MHz
- Test Distance : 10 M
- Temperature : 27°C
- Relative Humidity : 79 %
- Test Date : May. 21, 1999
- Emission level (dBuV/m) = 20 log Emission level (uV/m)
- Corrected Reading : Antenna Factor + Cable Loss + Reading = Emission

The Radiated Emission test was passed at minimum margin

185.700 MHz / 25.50 dBuV (HORIZONTAL) Antenna Height 4 Meter, Turntable Degree 110 °.

Frequency (MHz)	Polarity	Antenna Factor (dB/m)	Cable Loss (dB)	Reading (dBuV)	Limits		Emission (dBuV/m)	Level (uV/m)	Margin (dB)
					(dBuV/m)	(uV/m)			
157.300	H	10.64	1.57	10.33	30.00	31.62	22.54	13.40	-7.46
185.700	H	9.19	1.67	14.64	30.00	31.62	25.50	18.84	-4.50
200.000	H	8.70	1.70	14.50	30.00	31.62	24.90	17.58	-5.10
204.000	H	8.97	1.72	13.31	30.00	31.62	24.00	15.85	-6.00
212.800	H	9.57	1.77	13.13	30.00	31.62	24.47	16.73	-5.53
227.200	H	10.58	1.84	10.85	30.00	31.62	23.27	14.57	-6.73

Test Engineer : Jones Jan
 JONES JAN

6.5. Photographs of Radiated Emission Test Configuration

- The photographs show the configuration that generates the maximum emission.

FRONT VIEW



REAR VIEW

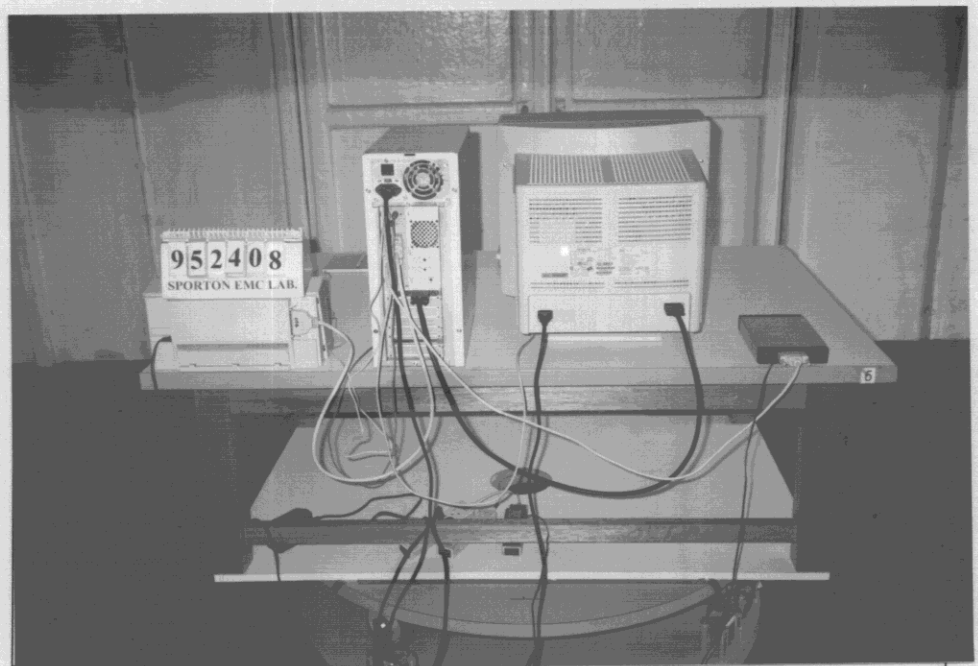

7. Antenna Factor & Cable Loss

Frequency (Mhz)	Antenna Factor (dB)	Cable Loss (dB)
30	16.1	0.8
35	15.6	0.9
40	12.6	0.9
45	10.5	0.8
50	7.0	0.8
55	6.3	0.8
60	5.5	1.0
65	5.4	1.0
70	5.3	1.1
75	6.1	1.1
80	7.1	1.1
85	8.1	1.3
90	9.0	1.3
95	9.9	1.4
100	10.8	1.1
110	11.1	1.1
120	11.4	1.4
130	11.8	1.5
140	11.1	1.5
150	10.5	1.6
160	10.7	1.5
170	9.6	1.5
180	9.4	1.7
190	9.1	1.7
200	8.7	1.7
220	10.1	1.8
240	11.5	1.9
260	12.5	1.9
280	13.1	1.8
300	13.6	2.0
320	14.2	2.1
340	14.7	2.3
360	15.2	2.4
380	15.5	2.3
400	15.9	2.3
450	16.6	2.6
500	17.2	2.6
550	18.2	2.9
600	18.3	3.0
650	19.1	3.1
700	19.1	3.2
750	19.5	3.2
800	18.6	3.5
850	19.5	3.8
900	20.2	3.8
950	19.8	3.8
1000	20.1	3.7

8. List of Measuring Equipments Used

Instrument	Manufacturer	Model No.	Serial No.	Characteristics	Calibration Date	Remark
EMC Receiver (site 2)	HP	8591EM	3710A01187	9 KHz - 18 GHz	Sep. 18, 1998	Conduction
LISN (EUT) (site 2)	Telemeter	NNB-2/16Z	98009	50 ohm / 50 uH	Jan. 22, 1999	Conduction
LISN (Support Unit) (site 2)	EMCO	3810/2NM	9703-1839	50 ohm / 50 uH	Jul. 06, 1998	Conduction
Spectrum Analyzer (Site 6)	ADVANTEST	R3261A	71720760	9 KHz - 2.6GHz	Mar. 05, 1999	Radiation
Amplifier (Site 6)	HP	8447D	2944A08290	0.1MHz -1.3GHz	Nov. 13, 1998	Radiation
Bilog Antenna (Site 6)	CHASE	CBL6112A	2322	30MHz -2GHz	Jan. 18, 1999	Radiation
Half-wave dipole antenna (Site 6)	EMCO	3121C	9705-1285	28 M - 1GHz	May 18, 1999	Radiation
Turn Table (site 6)	EMCO	2080	9711-2021	0 ~ 360 degree	N/A	Radiation
Antenna Mast (site 6)	EMCO	2075	9711-2115	1 m- 4 m	N/A	Radiation