



FCC TEST REPORT

FCC ID:FSUGMZMH

Report Number..... : ZKT-2306164542E

Date of Test..... Jun. 01, 2023 to Jul. 10, 2023

Date of issue..... : Jul. 10, 2023

Total number of pages..... 39

Test Result : PASS

Testing Laboratory..... : **Shenzhen ZKT Technology Co., Ltd.**

Address : 1/F, No. 101, Building B, No. 6, Tangwei Community Industrial Avenue, Fuhai Street, Bao'an District, Shenzhen, China

Applicant's name : **KYE SYSTEMS CORP.**

Address : No.492,Sec.5, Chongxin Rd.,Sanchong Dist., New Taipei City 24160,Taiwan.

Manufacturer's name : **Dongguan Kunying Computer Products Co., Ltd**

Address : Baodun Village, Houjie Town, Dongguan City, Guangdong Provinc, 523961 China

Test specification:

Standard..... : FCC CFR Title 47 Part 15 Subpart C Section 15.249
ANSI C63.10:2013

Test procedure..... : /

Non-standard test method : N/A

Test Report Form No..... : TRF-EL-111_V0**Test Report Form(s) Originator.....** : ZKT Testing**Master TRF** : Dated: 2022-02-21

This device described above has been tested by ZKT, and the test results show that the equipment under test (EUT) is in compliance with the FCC requirements. And it is applicable only to the tested sample identified in the report.

This report shall not be reproduced except in full, without the written approval of ZKT, this document may be altered or revised by ZKT, personal only, and shall be noted in the revision of the document.

Product name..... : Wireless Receiver

Trademark : Genius

Model/Type reference..... : GM-230004

GM-XXXXXX,USB-A XXXXXX XX;USB-A Receiver;USB-A
XXXXXXX;XXXXXXXXXXXXXXXXXXXXXXXXXXXX; (X can be 0-9
& A-Z & Blank & " - "& "/")

Ratings..... : Input: DC 5V



Testing procedure and testing location:

Testing Laboratory.....: Shenzhen ZKT Technology Co., Ltd.

Address.....: 1/F, No. 101, Building B, No. 6, Tangwei Community Industrial Avenue, Fuhai Street, Bao'an District, Shenzhen, China

Tested by (name + signature).....: Alen He

Reviewer (name + signature).....: Joe Liu

Approved (name + signature).....: Lake Xie





Table of Contents

Page

1. VERSION	5
2. SUMMARY OF TEST RESULTS	6
2.1 TEST FACILITY	7
2.2 MEASUREMENT UNCERTAINTY	7
3. GENERAL INFORMATION	8
3.1 GENERAL DESCRIPTION OF EUT	8
3.2 DESCRIPTION OF TEST MODES	9
3.3 BLOCK DIGRAM SHOWING THE CONFIGURATION OF SYSTEM TESTED	9
3.4 DESCRIPTION OF SUPPORT UNITS(CONDUCTED MODE)	10
3.5 EQUIPMENTS LIST FOR ALL TEST ITEMS	11
4. EMC EMISSION TEST	12
4.1 CONDUCTED EMISSION MEASUREMENT	12
4.1.1 POWER LINE CONDUCTED EMISSION Limits	12
4.1.2 TEST PROCEDURE	12
4.1.3 DEVIATION FROM TEST STANDARD	12
4.1.4 TEST SETUP	13
4.1.5 EUT OPERATING CONDITIONS	13
4.2 RADIATED EMISSION MEASUREMENT	14
4.2.1 RADIATED EMISSION LIMITS	14
4.2.2 TEST PROCEDURE	15
4.2.3 DEVIATION FROM TEST STANDARD	15
4.2.4 TEST SETUP	15
4.2.5 EUT OPERATING CONDITIONS	16
5. BANDWIDTH OF FREQUENCY BAND EDGE	21
6. BANDWIDTH OF FREQUENCY BAND EDGE	29
6.1 TEST REQUIREMENT:	29
6.2 TEST PROCEDURE	29
6.3 DEVIATION FROM TEST STANDARD	29
6.4 TEST SETUP	29
6.5 EUT OPERATING CONDITIONS	30
6.6 TEST RESULT	31
7. CHANNEL BANDWIDTH	35
7.1 APPLIED PROCEDURES / LIMIT	35
7.2 TEST PROCEDURE	35
7.3 DEVIATION FROM STANDARD	35



Table of Contents	Page
7.4 TEST SETUP	35
7.5 EUT OPERATION CONDITIONS	35
7.6 TEST RESULT	36
8.ANTENNA REQUIREMENT	38
9. TEST SETUP PHOTO	39
10. EUT CONSTRUCTIONAL DETAILS	39



1.VERSION

Report No.	Version	Description	Approved
ZKT-2306164542E	Rev.01	Initial issue of report	Jul. 10, 2023



2. SUMMARY OF TEST RESULTS

Test procedures according to the technical standards:

FCC Part15 (15.249) , Subpart C			
Standard Section	Test Item	Judgment	Remark
FCC part 15.203	Antenna requirement	PASS	
FCC part 15.207	AC Power Line Conducted Emission	N/A	
FCC part15.249(a)	Field Strength of Fundamental	PASS	
FCC part 15.249	Fundamental &Radiated Spurious Emission Measurement	PASS	
FCC part 15.215 (c)	20dB Channel Bandwidth	PASS	
FCC part 15.205	Band Edge	PASS	

NOTE:

(1) " N/A" denotes test is not applicable in this Test Report



2.1 TEST FACILITY

Shenzhen ZKT Technology Co., Ltd.
Add. : 1/F, No. 101, Building B, No. 6, Tangwei Community Industrial Avenue, Fuhai Street, Bao'an District, Shenzhen, China

FCC Test Firm Registration Number: 692225
Designation Number: CN1299
IC Registered No.: 27033

2.2 MEASUREMENT UNCERTAINTY

The reported uncertainty of measurement $y \pm U$ · where expanded uncertainty U is based on a standard uncertainty multiplied by a coverage factor of $k=2$ · providing a level of confidence of approximately 95 % ·

No.	Item	Uncertainty
1	Conducted Emission Test	$\pm 1.38\text{dB}$
2	RF power conducted	$\pm 0.16\text{dB}$
3	Spurious emissions conducted	$\pm 0.21\text{dB}$
4	All emissions radiated(<1G)	$\pm 4.68\text{dB}$
5	All emissions radiated(>1G)	$\pm 4.89\text{dB}$
6	Temperature	$\pm 0.5^\circ\text{C}$
7	Humidity	$\pm 2\%$



3. GENERAL INFORMATION

3.1 GENERAL DESCRIPTION OF EUT

Product Name:	Wireless Receiver
Model No.:	GM-230004 GM-XXXXXX,USB-A XXXXXX XX;USB-A Receiver;USB-A XXXXXXX;XXXXXXXXXXXXXXXXXXXXXXXXXXXX; (X can be 0-9 & A-Z & Blank & " - "& "/")
Model Different.:	All the model are the same circuit and RF module, except for model name.
Serial No.:	N/A
Hardware Version:	H1.0
Software Version:	S1.0
Sample(s) Status:	Engineer sample
Operation Frequency:	2405MHz-2470MHz
Channel Numbers:	18
Modulation Type:	GFSK
Antenna Type:	PCB Antenna
Antenna gain:	-1.66dBi
Power supply:	Input: DC 5V

Channel	Frequency	Channel	Frequency
	MHz		MHz
CH1	2405	CH6	2463
CH2	2411	CH7	2469
CH3	2417	CH8	2475
CH4	2451	CH9	N/A
CH5	2457	CH10	N/A

Channel	Frequency
The lowest channel	2405MHz
The middle channel	2451MHz
The Highest channel	2475MHz



3.2 DESCRIPTION OF TEST MODES

Transmitting mode	Keep the EUT in continuously transmitting mode
Remark: During the test, the test voltage was tuned from 85% to 115% of the nominal rated supply voltage, and found that the worst case was under the nominal rated supply condition. So the report just shows that condition's data.	

Test Software	RF Test Tool
Power level setup	<0dBm

3.3 BLOCK DIGRAM SHOWING THE CONFIGURATION OF SYSTEM TESTED

Radiated Emission

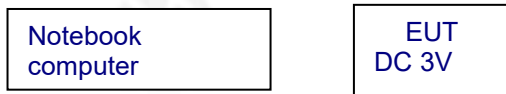

Conducted Spurious

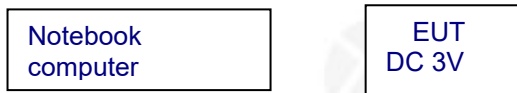



3.4 DESCRIPTION OF SUPPORT UNITS(CONDUCTED MODE)

The EUT has been tested as an independent unit together with other necessary accessories or support units. The following support units or accessories were used to form a representative test configuration during the tests.

Item	Equipment	Mfr/Brand	Model/Type No.	Series No.	Note
E-1	Wireless Receiver	Genius	GM-230004	/	EUT
A-9	Notebook computer	SAMSUNG	RC510	/	/

Item	Shielded Type	Ferrite Core	Length	Note
C-1	/	/	/	/

Note:

- (1) The support equipment was authorized by Declaration of Confirmation.
- (2) For detachable type I/O cable should be specified the length in cm in 『Length』 column.



3.5 EQUIPMENTS LIST FOR ALL TEST ITEMS

Equipment List:

Item	Equipment	Manufacturer	Type No.	Serial No.	Last calibration	Calibrated until
1	Spectrum Analyzer (9kHz-26.5GHz)	KEYSIGHT	9020A	MY55370835	Oct. 28, 2022	Oct. 27, 2023
2	Spectrum Analyzer (10kHz-39.9GHz)	R&S	FSQ	100363	Oct. 28, 2022	Oct. 27, 2023
3	EMI Test Receiver (9kHz-7GHz)	R&S	ESCI7	101169	Oct. 28, 2022	Oct. 27, 2023
4	Bilog Antenna (30MHz-1500MHz)	Schwarzbeck	VULB9168	N/A	Nov. 02, 2022	Nov. 01, 2023
5	Horn Antenna (1GHz-18GHz)	Agilent	AH-118	071145	Nov. 01, 2022	Oct. 31, 2023
6	Horn Antenna (15GHz-40GHz)	A.H.System	SAS-574	588	Oct. 28, 2022	Oct. 27, 2023
7	Loop Antenna	TESEQ	HLA6121	58357	Nov. 01, 2022	Oct. 31, 2023
8	Amplifier (30-1000MHz)	EM Electronics	EM330 Amplifier	060747	Nov. 15, 2022	Nov. 14, 2023
9	Amplifier (1GHz-26.5GHz)	Agilent	8449B	3008A00315	Oct. 28, 2022	Oct. 27, 2023
10	Amplifier (500MHz-40GHz)	Quanjuda	DLE-161	097	Oct. 28, 2022	Oct. 27, 2023
11	Test Cable	N/A	R-01	N/A	Oct. 28, 2022	Oct. 27, 2023
12	Test Cable	N/A	R-02	N/A	Oct. 28, 2022	Oct. 27, 2023
13	Test Cable	N/A	R-03	N/A	Oct. 28, 2022	Oct. 27, 2023
14	Test Cable	N/A	RF-01	N/A	Oct. 28, 2022	Oct. 27, 2023
15	Test Cable	N/A	RF-02	N/A	Oct. 28, 2022	Oct. 27, 2023
16	Test Cable	N/A	RF-03	N/A	Oct. 28, 2022	Oct. 27, 2023
17	ESG Signal Generator	Agilent	E4421B	N/A	Oct. 21, 2022	Oct. 20, 2023
18	Signal Generator	Agilent	N5182A	N/A	Oct. 21, 2022	Oct. 20, 2023
19	Magnetic Field Probe Tester	Narda	ELT-400	0-0344	Nov. 15, 2022	Nov. 14, 2023
20	Wideband Radio Communication Test	R&S	CMW500	106504	Oct. 28, 2022	Oct. 27, 2023
21	MWRF Power Meter Test system	MW	MW100-RPCB	N/A	Oct. 21, 2022	Oct. 20, 2023
22	D.C. Power Supply	LongWei	TPR-6405D	N/A	\	\
23	EMC Software	Frad	EZ-EMC	Ver.EMC-CON 3A1.1	\	\
24	RF Software	MW	MTS8310	V2.0.0.0	\	\
25	Turntable	MF	MF-7802BS	N/A	\	\
26	Antenna tower	MF	MF-7802BS	N/A	\	\



4. EMC EMISSION TEST

4.1 CONDUCTED EMISSION MEASUREMENT

Test Requirement:	FCC Part15 C Section 15.207
Test Method:	ANSI C63.10:2013
Test Frequency Range:	150KHz to 30MHz
Receiver setup:	RBW=9KHz, VBW=30KHz, Sweep time=auto

4.1.1 POWER LINE CONDUCTED EMISSION Limits

FREQUENCY (MHz)	Limit (dBuV)		Standard
	Quas-peak	Average	
0.15 -0.5	66 - 56 *	56 - 46 *	FCC
0.50 -5.0	56.00	46.00	FCC
5.0 -30.0	60.00	50.00	FCC

Note:

(1) *Decreases with the logarithm of the frequency.

4.1.2 TEST PROCEDURE

- The EUT was placed 0.8 meters from the horizontal ground plane with EUT being connected to the power mains through a line impedance stabilization network (LISN). All other support equipments powered from additional LISN(s). The LISN provide 50 Ohm/ 50uH of coupling impedance for the measuring instrument.
- Interconnecting cables that hang closer than 40 cm to the ground plane shall be folded back and forth in the center forming a bundle 30 to 40 cm long.
- I/O cables that are not connected to a peripheral shall be bundled in the center. The end of the cable may be terminated, if required, using the correct terminating impedance. The overall length shall not exceed 1 m.
- LISN at least 80 cm from nearest part of EUT chassis.
- For the actual test configuration, please refer to the related Item –EUT Test Photos.

4.1.3 DEVIATION FROM TEST STANDARD

No deviation



4.1.4 TEST SETUP

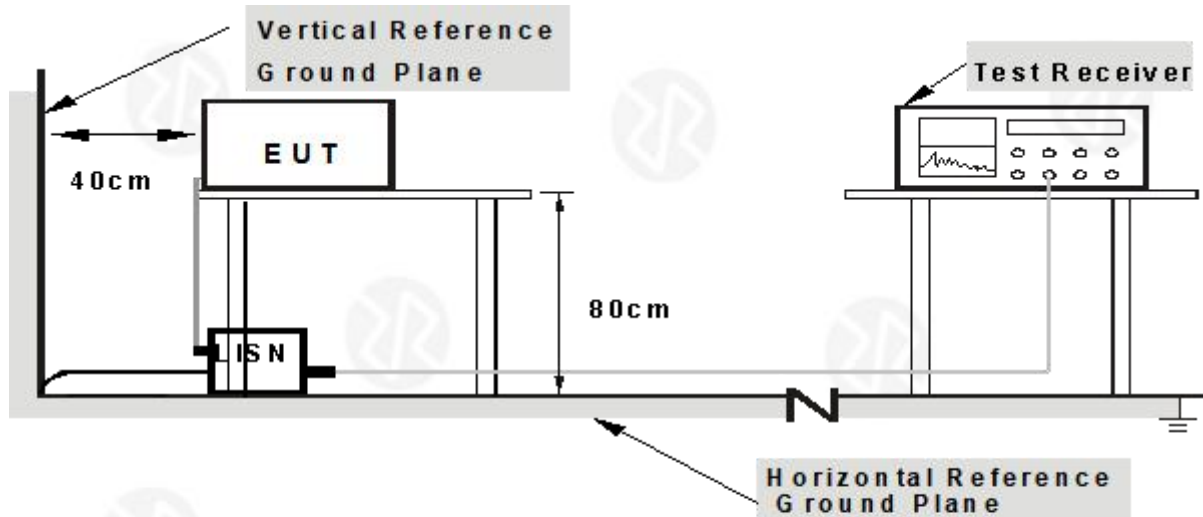

- Note: 1.Support units were connected to second LISN.**
2.Both of LISNs (AMN) are 80 cm from EUT and at least 80 cm from other units and other metal planes

4.1.5 EUT OPERATING CONDITIONS

The EUT was configured for testing in a typical fashion (as a customer would normally use it). The EUT has been programmed to continuously transmit during test. This operating condition was tested and used to collect the included data.

4.1.6 Test Result

The EUT is powered by DC only. The test items is not applicable.



4.2 RADIATED EMISSION MEASUREMENT

Test Requirement:	FCC Part15 C Section 15.209				
Test Method:	ANSI C63.10:2013				
Test Frequency Range:	9kHz to 25GHz				
Test site:	Measurement Distance: 3m				
Receiver setup:	Frequency	Detector	RBW	VBW	Value
	9KHz-150KHz	Quasi-peak	200Hz	600Hz	Quasi-peak
	150KHz-30MHz	Quasi-peak	9KHz	30KHz	Quasi-peak
	30MHz-1GHz	Quasi-peak	100KHz	300KHz	Quasi-peak
	Above 1GHz	Peak	1MHz	3MHz	Peak
Peak		1MHz	10Hz	Average	

4.2.1 RADIATED EMISSION LIMITS

Frequencies (MHz)	Field Strength (microvolts/meter)	Measurement Distance (meters)
0.009~0.490	2400/F(KHz)	300
0.490~1.705	24000/F(KHz)	30
1.705~30.0	30	30
30~88	100	3
88~216	150	3
216~960	200	3
Above 960	500	3

LIMITS OF RADIATED EMISSION MEASUREMENT

FREQUENCY (MHz)	Limit (dBuV/m) (at 3M)	
	PEAK	AVERAGE
Above 1000	74	54

Notes:

- (1) The limit for radiated test was performed according to FCC PART 15C.
- (2) The tighter limit applies at the band edges.
- (3) Emission level (dBuV/m)=20log Emission level (uV/m).



4.2.2 TEST PROCEDURE

- a. The measuring distance of at 3 m shall be used for measurements at frequency up to 25GHz. For frequencies above 1GHz, any suitable measuring distance may be used.
- b. The EUT was placed on the top of a rotating table 0.8 meters above the ground at a 3 meter semi-chamber test. The table was rotated 360 degrees to determine the position of the highest radiation.
- c. The height of the equipment or of the substitution antenna shall be 0.8m; above 1GHz, the height was 1.5m, the height of the test antenna shall vary between 1 m to 4 m. Both horizontal and vertical polarizations of the antenna are set to make the measurement.
- d. The initial step in collecting conducted emission data is a spectrum analyzer peak detector mode pre-scanning the measurement frequency range. Significant peaks are then marked and then Quasi Peak detector mode re-measured.
- e. If the Peak Mode measured value compliance with and lower than Quasi Peak Mode Limit, the EUT shall be deemed to meet QP Limits and then no additional QP Mode measurement performed.
- f. For the actual test configuration, please refer to the related Item –EUT Test Photos.

g. For the radiated emission test above 1GHz:

Place the measurement antenna away from each area of the EUT determined to be a source of emissions at the specified measurement distance, while keeping the measurement antenna aimed at the source of emissions at each frequency of significant emissions, with polarization oriented for maximum response.

The measurement antenna may have to be higher or lower than the EUT, depending on the radiation pattern of the emission and staying aimed at the emission source for receiving the maximum signal. The final measurement antenna elevation shall be that which maximizes the emissions. The measurement antenna elevation for maximum emissions shall be restricted to a range of heights of from 1 m to 4 m above the ground or reference ground plane.

Note:

Both horizontal and vertical antenna polarities were tested and performed pretest to three orthogonal axis. The worst case emissions were reported

4.2.3 DEVIATION FROM TEST STANDARD

No deviation

4.2.4 TEST SETUP

(A) Radiated Emission Test-Up Frequency Below 30MHz

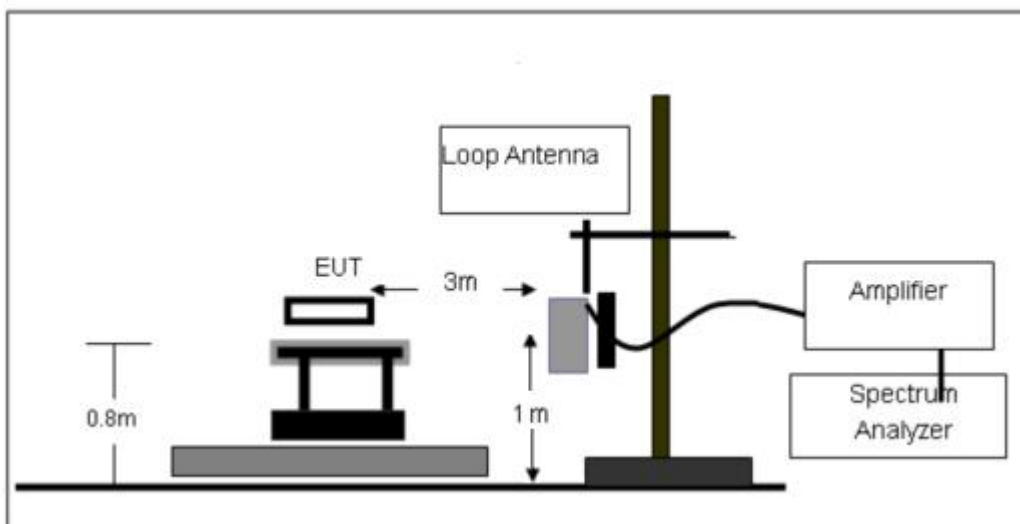



(B) Radiated Emission Test-Up Frequency 30MHz~1GHz

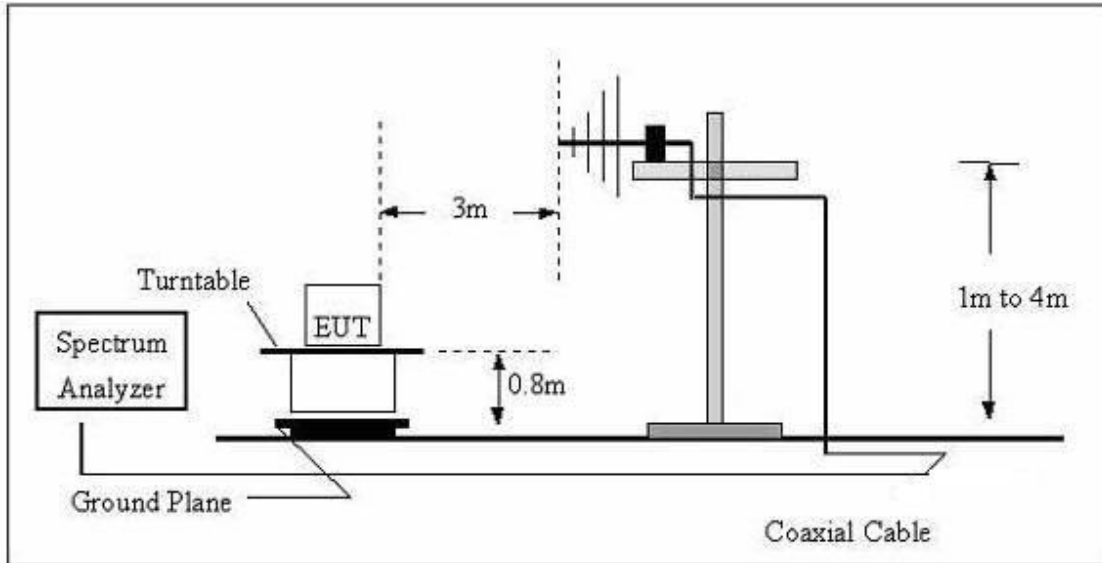

(C) Radiated Emission Test-Up Frequency Above 1GHz

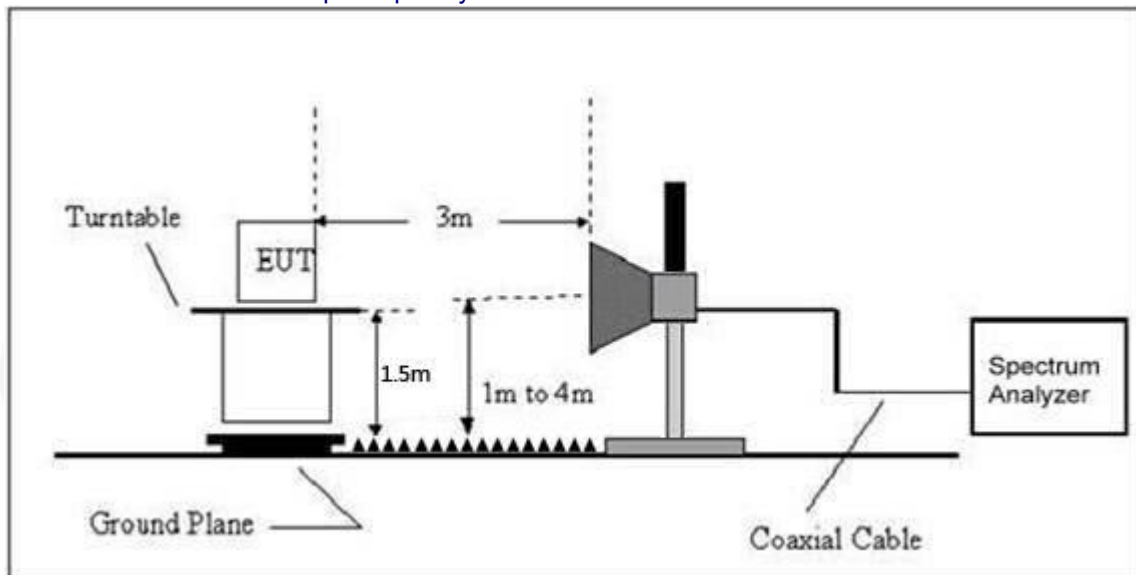

4.2.5 EUT OPERATING CONDITIONS

The EUT tested system was configured as the statements of 2.4 Unless otherwise a special operating condition is specified in the follows during the testing.

4.2.6 TEST RESULTS (Between 9KHz – 30 MHz)

The emission from 9 kHz to 30MHz was pre-tested and found the result was 20dB lower than the limit, and according to 15.31(o) & RSS-Gen 6.13, the test result no need to reported.



Between 30MHz – 1GHz

Temperature:	26°C	Relative Humidity:	54%
Pressure:	101 kPa	Polarization:	Horizontal
Test Voltage:	DC 3V		

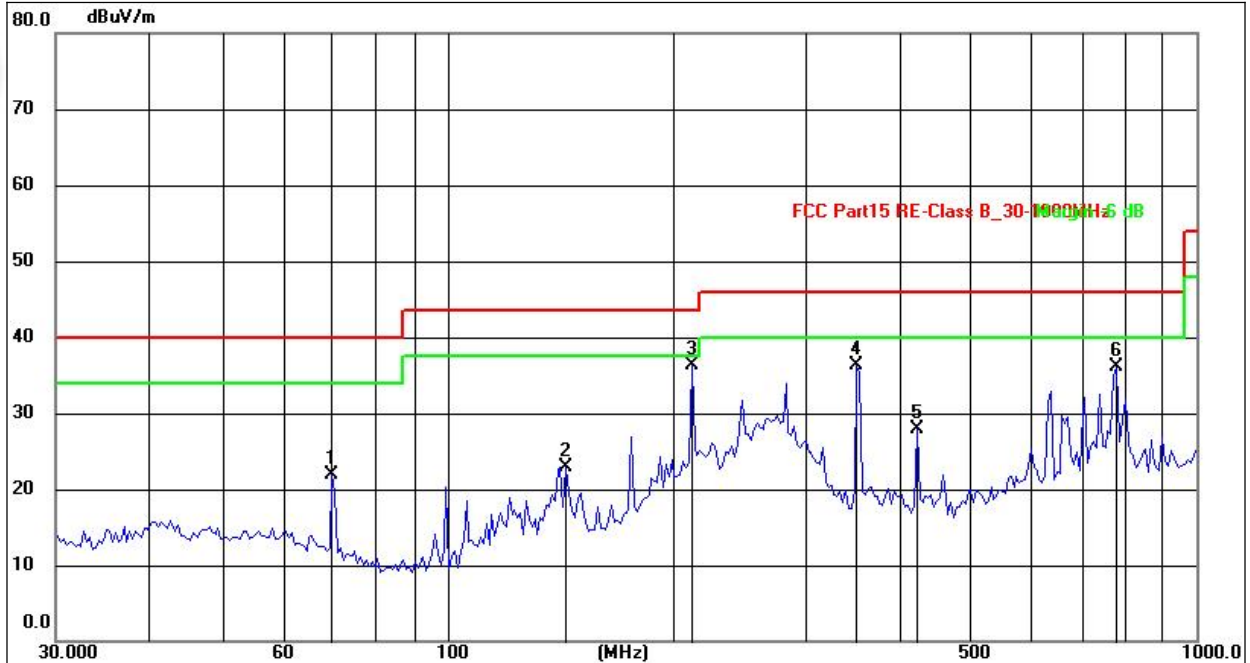

No.	Frequency (MHz)	Reading (dBuV)	Factor (dB/m)	Level (dBuV/m)	Limit (dBuV/m)	Margin (dB)	Detector
1	70.2132	38.76	-16.95	21.81	40.00	-18.19	QP
2	144.0817	39.68	-16.78	22.90	43.50	-20.60	QP
3	211.8976	54.57	-18.19	36.38	43.50	-7.12	QP
4	352.3249	52.98	-16.76	36.22	46.00	-9.78	QP
5	423.5402	43.31	-15.41	27.90	46.00	-18.10	QP
6	782.3451	42.97	-6.90	36.07	46.00	-9.93	QP



Temperature:	26°C	Relative Humidity:	54%
Pressure:	101kPa	Polarization:	Vertical
Test Voltage:	DC 3V		

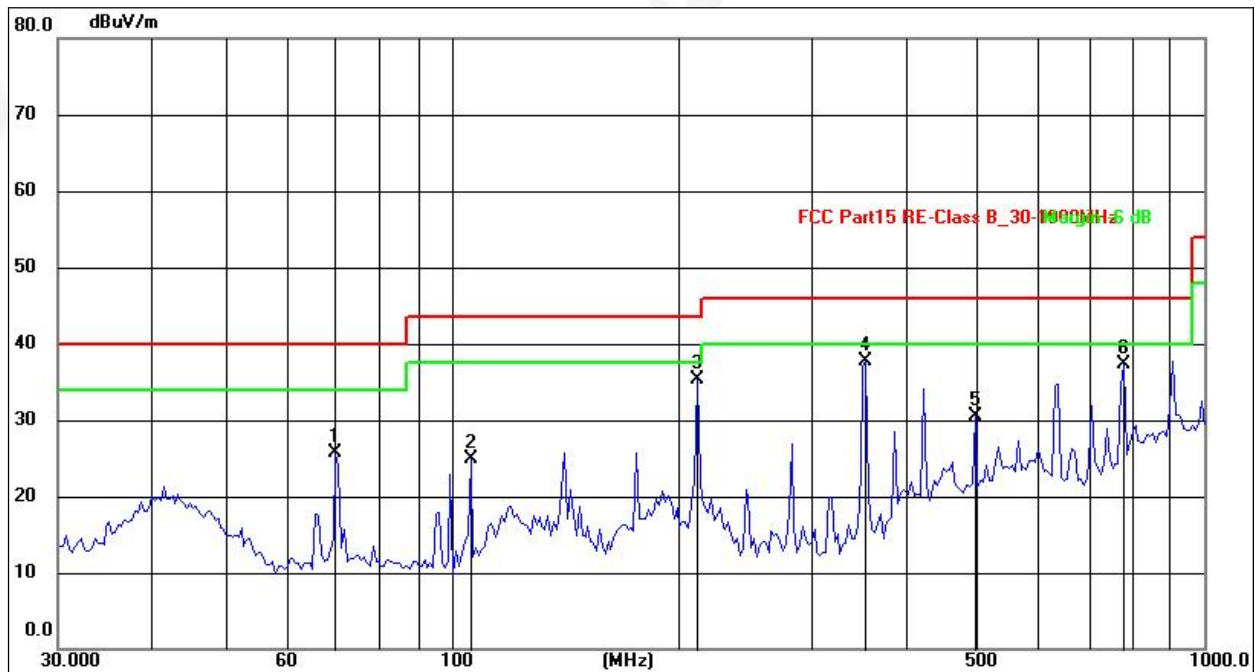

No.	Frequency (MHz)	Reading (dBuV)	Factor (dB/m)	Level (dBuV/m)	Limit (dBuV/m)	Margin (dB)	Detector
1	70.2132	45.04	-19.40	25.64	40.00	-14.36	QP
2	106.0126	46.09	-21.26	24.83	43.50	-18.67	QP
3	211.8976	55.72	-20.51	35.21	43.50	-8.29	QP
4	355.4272	54.17	-16.50	37.67	46.00	-8.33	QP
5	495.9343	42.31	-11.72	30.59	46.00	-15.41	QP
6	782.3452	41.55	-4.29	37.26	46.00	-8.74	QP

Remarks:

- 1.Final Level =Receiver Read level + Antenna Factor + Cable Loss – Preamplifier Factor
- 2.The emission levels of other frequencies are very lower than the limit and not show in test report.



GFSK 1GHz~25GHz

Polar (H/V)	Frequency	Meter Reading	Pre-ampli fier	Cable Loss	Antenna Factor	Emission Level	Limits	Margin	Detector Type
	(MHz)	(dBuV)	(dB)	(dB)	(dB)	(dBuV/m)	(dBuV/m)	(dB)	
Low Channel:2405MHz									
V	4810.00	54.98	30.55	5.77	24.66	54.86	74.00	-19.14	Pk
V	4810.00	43.21	30.55	5.77	24.66	43.09	54.00	-10.91	AV
V	7215.00	54.10	30.33	6.32	24.55	54.64	74.00	-19.36	Pk
V	7215.00	43.71	30.33	6.32	24.55	44.25	54.00	-9.75	AV
V	9620.00	52.70	30.85	7.45	24.69	53.99	74.00	-20.01	Pk
V	9620.00	43.42	30.85	7.45	24.69	44.71	54.00	-9.29	AV
V	12025.00	52.60	31.02	8.99	25.57	56.14	74.00	-17.86	Pk
V	12025.00	43.28	31.02	8.99	25.57	46.82	54.00	-7.18	AV
H	4810.00	51.37	30.55	5.77	24.66	51.25	74.00	-22.75	Pk
H	4810.00	43.03	30.55	5.77	24.66	42.91	54.00	-11.09	AV
H	7215.00	54.51	30.33	6.32	24.55	55.05	74.00	-18.95	Pk
H	7215.00	43.14	30.33	6.32	24.55	43.68	54.00	-10.32	AV
H	9620.00	52.84	30.85	7.45	24.69	54.13	74.00	-19.87	Pk
H	9620.00	43.98	30.85	7.45	24.69	45.27	54.00	-8.73	AV
H	12025.00	54.90	31.02	8.99	25.57	58.44	74.00	-15.56	Pk
H	12025.00	43.85	31.02	8.99	25.57	47.39	54.00	-6.61	AV

Polar (H/V)	Frequency	Meter Reading	Pre-ampli fier	Cable Loss	Antenna Factor	Emission Level	Limits	Margin	Detector Type
	(MHz)	(dBuV)	(dB)	(dB)	(dB)	(dBuV/m)	(dBuV/m)	(dB)	
Middle Channel:2451MHz									
V	4902.00	50.09	30.55	5.77	24.66	49.97	74.00	-24.03	Pk
V	4902.00	43.34	30.55	5.77	24.66	43.22	54.00	-10.78	AV
V	7353.00	50.70	30.33	6.32	24.55	51.24	74.00	-22.76	Pk
V	7353.00	43.57	30.33	6.32	24.55	44.11	54.00	-9.89	AV
V	9804.00	54.23	30.85	7.45	24.69	55.52	74.00	-18.48	Pk
V	9804.00	43.82	30.85	7.45	24.69	45.11	54.00	-8.89	AV
V	12255.00	54.42	31.02	8.99	25.57	57.96	74.00	-16.04	Pk
V	12255.00	43.12	31.02	8.99	25.57	46.66	54.00	-7.34	AV
H	4902.00	51.53	30.55	5.77	24.66	51.41	74.00	-22.59	Pk
H	4902.00	43.99	30.55	5.77	24.66	43.87	54.00	-10.13	AV
H	7353.00	50.35	30.33	6.32	24.55	50.89	74.00	-23.11	Pk
H	7353.00	43.97	30.33	6.32	24.55	44.51	54.00	-9.49	AV
H	9804.00	53.07	30.85	7.45	24.69	54.36	74.00	-19.64	Pk
H	9804.00	43.16	30.85	7.45	24.69	44.45	54.00	-9.55	AV
H	12255.00	53.38	31.02	8.99	25.57	56.92	74.00	-17.08	Pk
H	12255.00	43.78	31.02	8.99	25.57	47.32	54.00	-6.68	AV



Polar (H/V)	Frequency	Meter Reading	Pre-amplifier	Cable Loss	Antenna Factor	Emission Level	Limits	Margin	Detector Type
	(MHz)	(dBuV)	(dB)	(dB)	(dB)	(dBuV/m)	(dBuV/m)	(dB)	
High Channel:2475MHz									
V	4950.00	50.97	30.55	5.77	24.66	50.85	74.00	-23.15	Pk
V	4950.00	43.45	30.55	5.77	24.66	43.33	54.00	-10.67	AV
V	7425.00	54.81	30.33	6.32	24.55	55.35	74.00	-18.65	Pk
V	7425.00	43.51	30.33	6.32	24.55	44.05	54.00	-9.95	AV
V	9900.00	51.46	30.85	7.45	24.69	52.75	74.00	-21.25	Pk
V	9900.00	43.29	30.85	7.45	24.69	44.58	54.00	-9.42	AV
V	12375.00	53.08	31.02	8.99	25.57	56.62	74.00	-17.38	Pk
V	12375.00	43.63	31.02	8.99	25.57	47.17	54.00	-6.83	AV
H	4950.00	54.19	30.55	5.77	24.66	54.07	74.00	-19.93	Pk
H	4950.00	43.37	30.55	5.77	24.66	43.25	54.00	-10.75	AV
H	7425.00	51.33	30.33	6.32	24.55	51.87	74.00	-22.13	Pk
H	7425.00	43.56	30.33	6.32	24.55	44.10	54.00	-9.90	AV
H	9900.00	50.50	30.85	7.45	24.69	51.79	74.00	-22.21	Pk
H	9900.00	43.81	30.85	7.45	24.69	45.10	54.00	-8.90	AV
H	12375.00	52.98	31.02	8.99	25.57	56.52	74.00	-17.48	Pk
H	12375.00	43.71	31.02	8.99	25.57	47.25	54.00	-6.75	AV

Remark:

1. Emission Level = Meter Reading + Antenna Factor + Cable Loss – Pre-amplifier, Margin= Emission Level - Limit
2. If peak below the average limit, the average emission was no test.
3. The amplitude of spurious emissions which are attenuated by more than 20dB below the permissible value has no need to be reported.



5. BANDWIDTH OF FREQUENCY BAND EDGE

5.1 Limit

Fundamental frequency	Field strength of fundamental@3m (millivolts/meter)	Average Limit@3m dB μ V/m	Peak Limit@3m dB μ V/m
902-928MHz	50	94	114
2407-2477MHz	50	94	114
5725-5875MHz	50	94	114
24.0-24.25	250	108	128

Note:

1. Average Limit (dB μ V/m)=20 \times log[1000 \times Field Strength (mV/m)].
2. Peak Limit (dB μ V/m)= Average Limit (dB μ V/m)+20dB

5.2 Test Setup

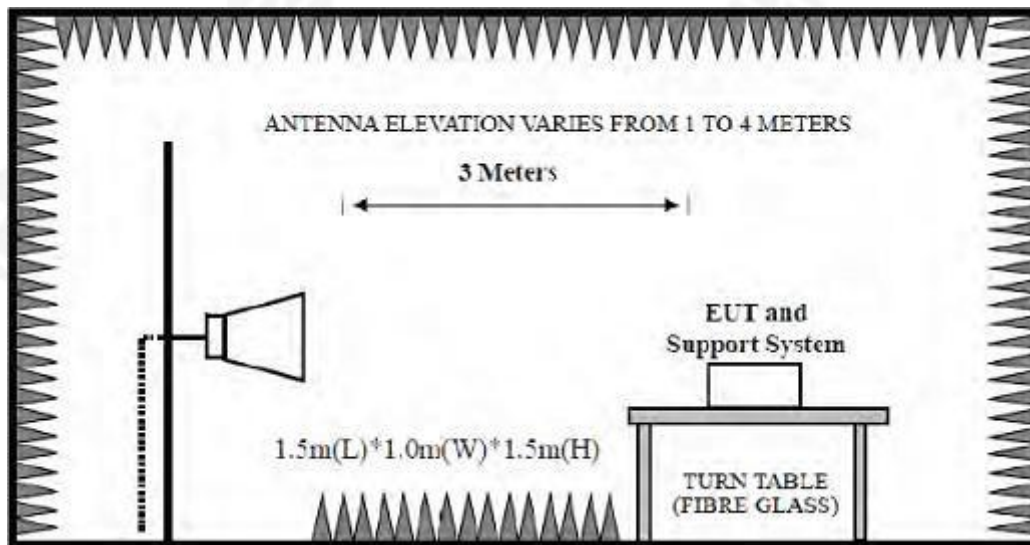

5.2 Spectrum Analyzer Setting

Spectrum Parameters	Setting
RBW	\geq OBW
VBW	3 \times RBW
Start frequency	2407MHz
Stop frequency	2477MHz
Sweep Time	Auto
Detector	PEAK/AVG
Trace Mode	Max Hold



5.4 Test Procedure

- a. EUT was placed on a turn table, which is 1.5 meter high above the ground.
- b. EUT is set 3 meters away from the receiving antenna, which is mounted on a antenna tower.
- c. Spectrum analyzer setting parameters in accordance with section 3.3.
- d. Set the EUT transmit continuously with maximum output power.
- e. The turn table can rotate 360 degrees to determine the position of the maximum emission level.
- f. The antenna can be moved up and down between 1 meter and 4 meters to find out the maximum emission level. Both horizontal and vertical polarization of the antenna are set on test, record the average and peak value.
- g. Repeat above procedures until all channels were measured.
- h. Record the results in the test report.

5.5 Test Result

Test frequency (MHz)	Fundamental Frequency (MHz)	Field strength of fundamental level (dB μ V/m)		Limit (dBuV)		Result	Antenna Pole (H/V)
		AVG	Peak	AVG	Peak		
2405	2404.930	89.86	91.35	94	114	Pass	H
	2405.930	89.36	90.35	94	114	Pass	V
2451	2429.731	91.77	92.26	94	114	Pass	H
	2429.524	92.23	92.75	94	114	Pass	V
2475	2469.736	91.88	93.24	94	114	Pass	H
	2470.159	92.15	93.52	94	114	Pass	V



Low Channel(2405MHz)

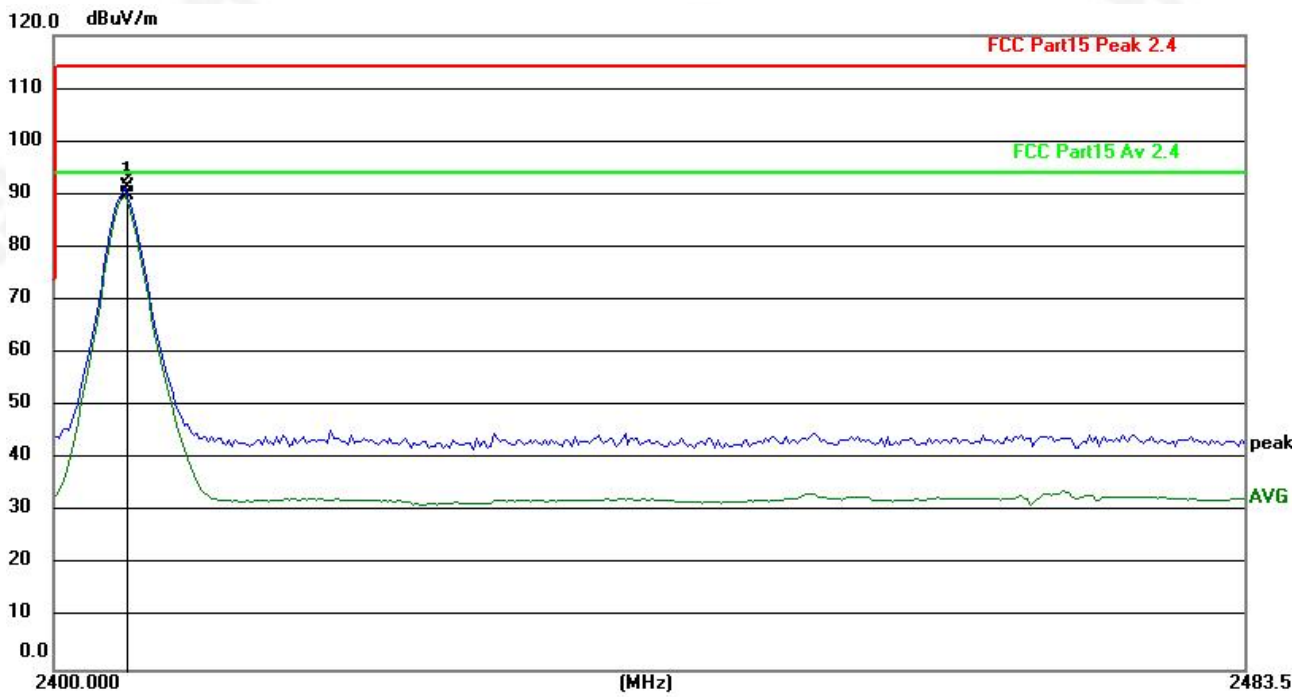

No.	Frequency (MHz)	Reading (dBuV)	Factor (dB/m)	Level (dBuV/m)	Limit (dBuV/m)	Margin (dB)	Detector
1	2404.930	92.37	-1.02	91.35	114.00	-22.65	peak
2	2404.930	90.88	-1.02	89.86	94.00	-4.14	AVG

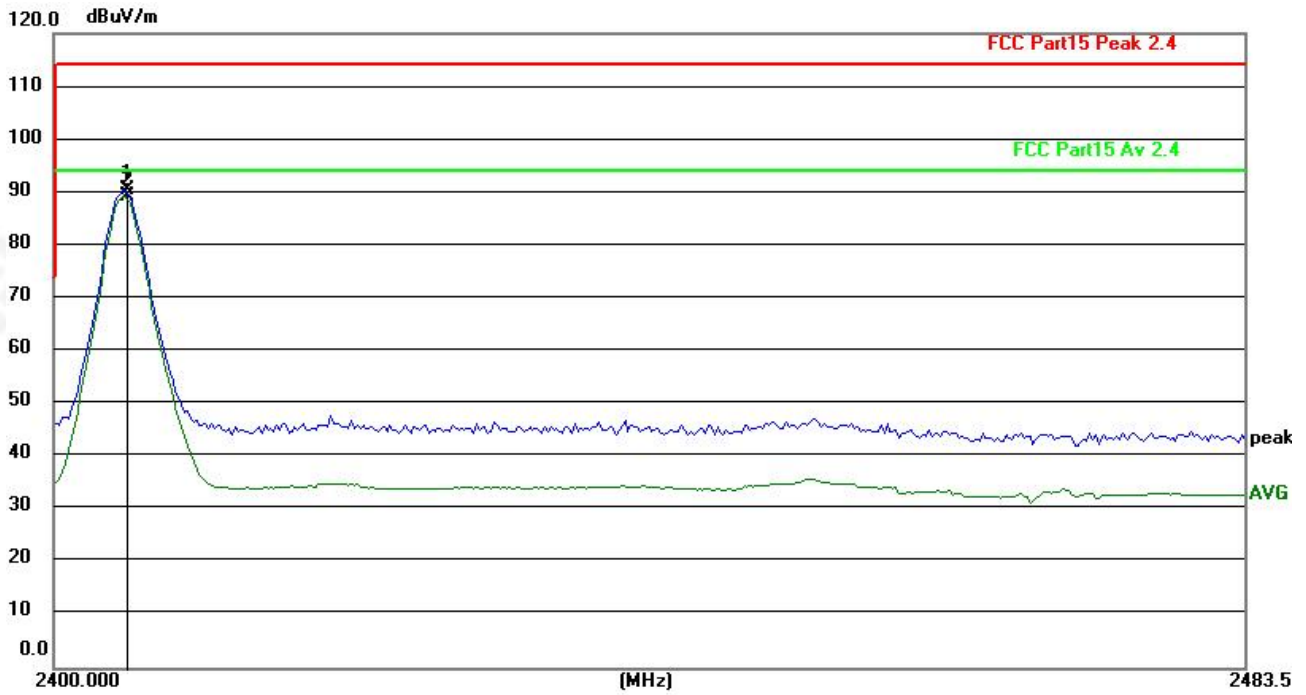

No.	Frequency (MHz)	Reading (dBuV)	Factor (dB/m)	Level (dBuV/m)	Limit (dBuV/m)	Margin (dB)	Detector
1	2404.930	91.37	-1.02	90.35	114.00	-23.65	peak
2	2404.930	90.38	-1.02	89.36	94.00	-4.64	AVG



Middle Channel(2451MHz)

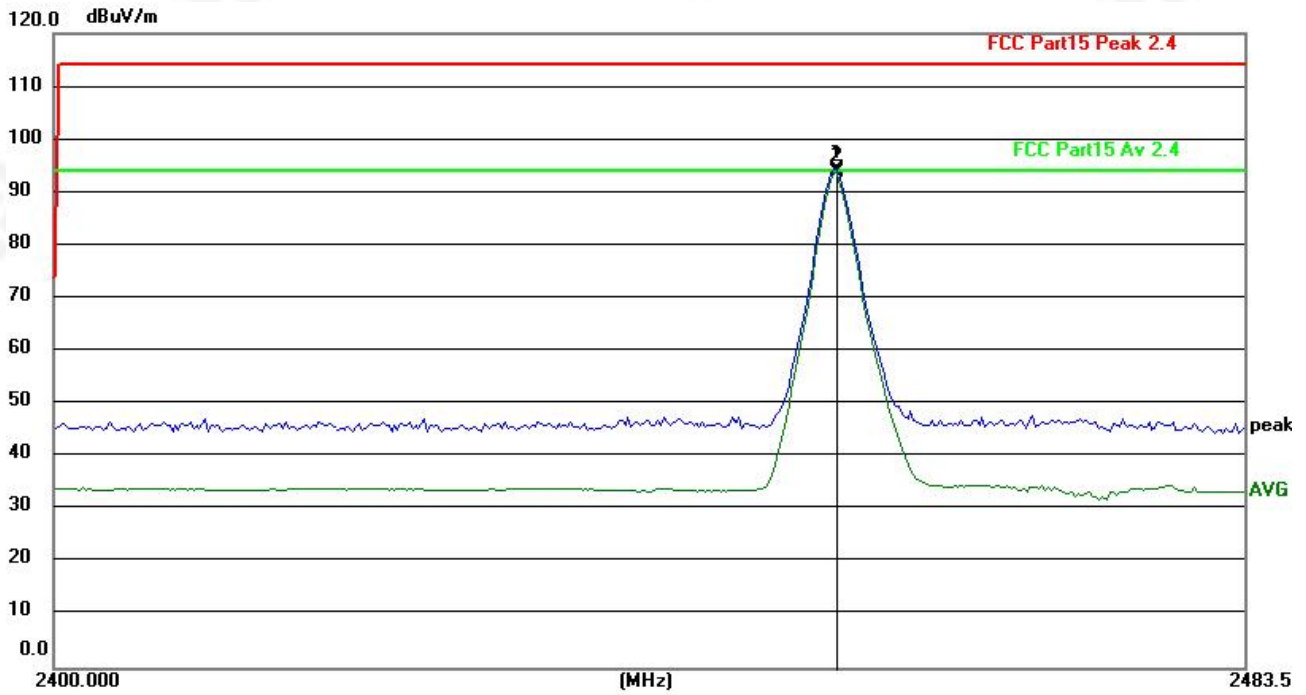

No.	Frequency (MHz)	Reading (dBuV)	Factor (dB/m)	Level (dBuV/m)	Limit (dBuV/m)	Margin (dB)	Detector
1	2451.731	95.26	-1.00	94.26	114.00	-19.74	peak
2	2451.731	94.77	-1.00	93.77	94.00	-0.23	AVG

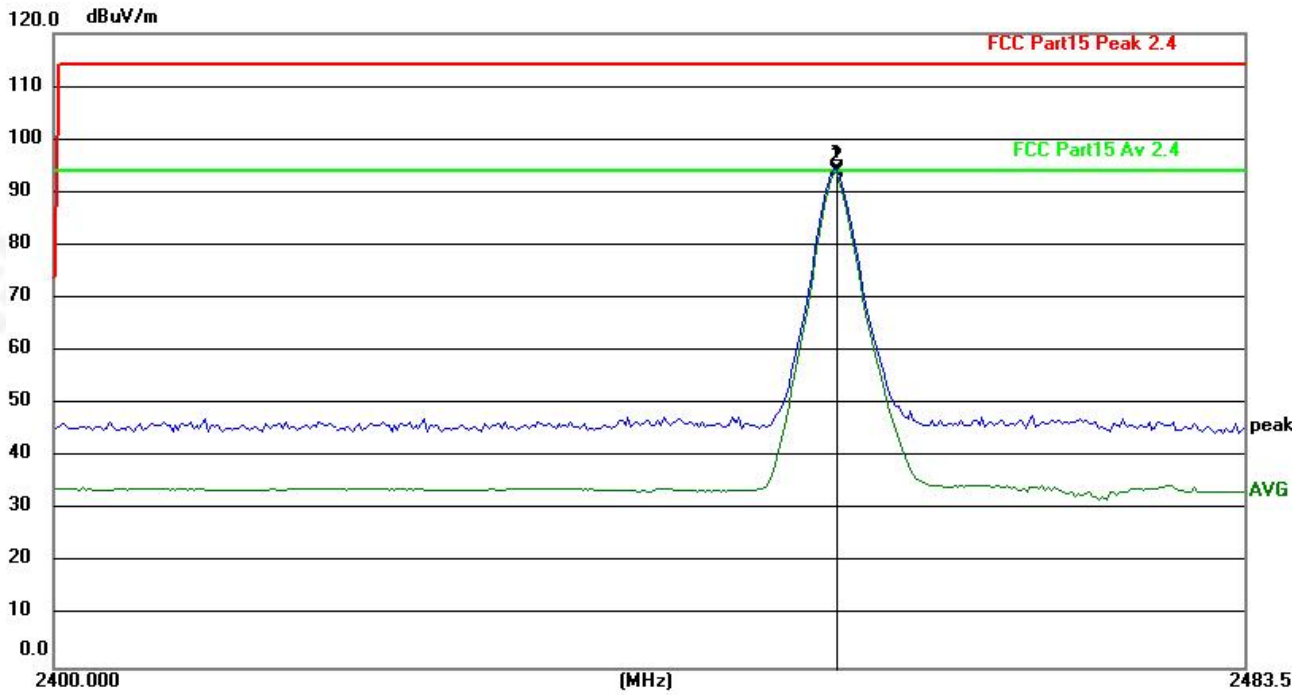

No.	Frequency (MHz)	Reading (dBuV)	Factor (dB/m)	Level (dBuV/m)	Limit (dBuV/m)	Margin (dB)	Detector
1	2451.524	93.75	-1.00	92.75	114.00	-21.25	peak
2	2451.524	93.23	-1.00	92.23	94.00	-1.77	AVG



High Channel(2475MHz)

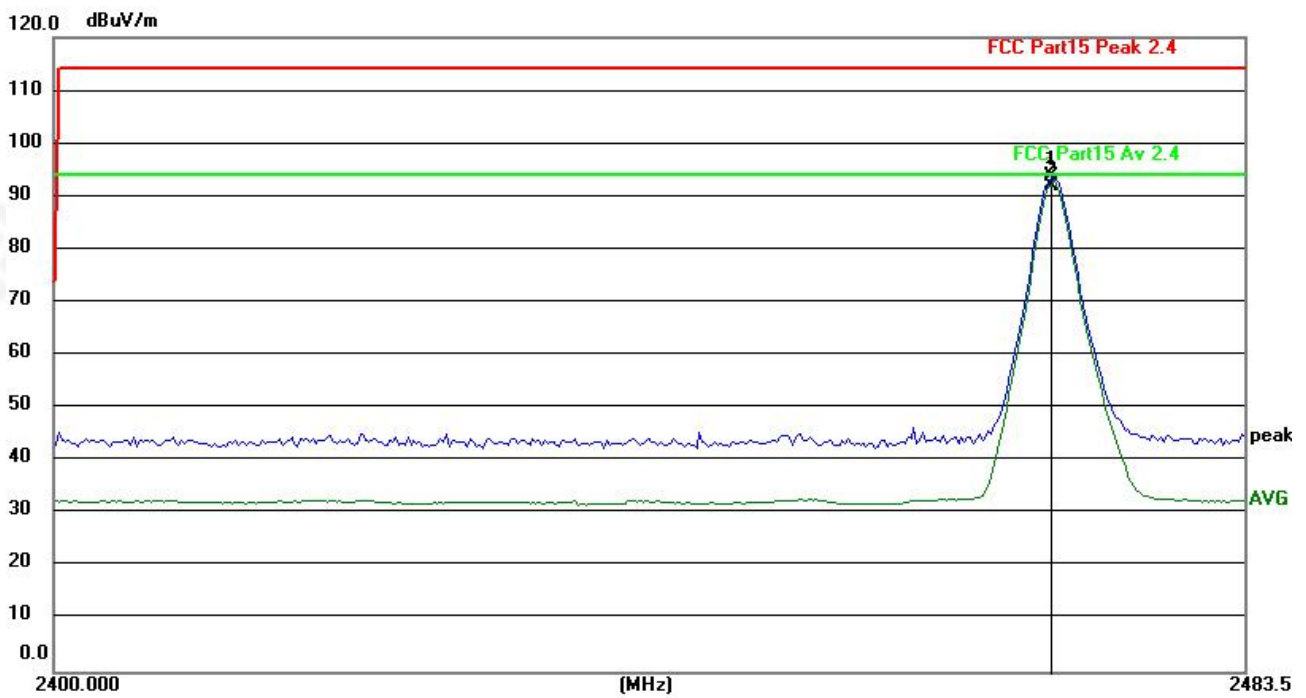

No.	Frequency (MHz)	Reading (dBuV)	Factor (dB/m)	Level (dBuV/m)	Limit (dBuV/m)	Margin (dB)	Detector
1	2475.736	94.70	-0.96	93.74	114.00	-20.26	peak
2	2475.736	92.84	-0.96	91.88	94.00	-2.12	AVG

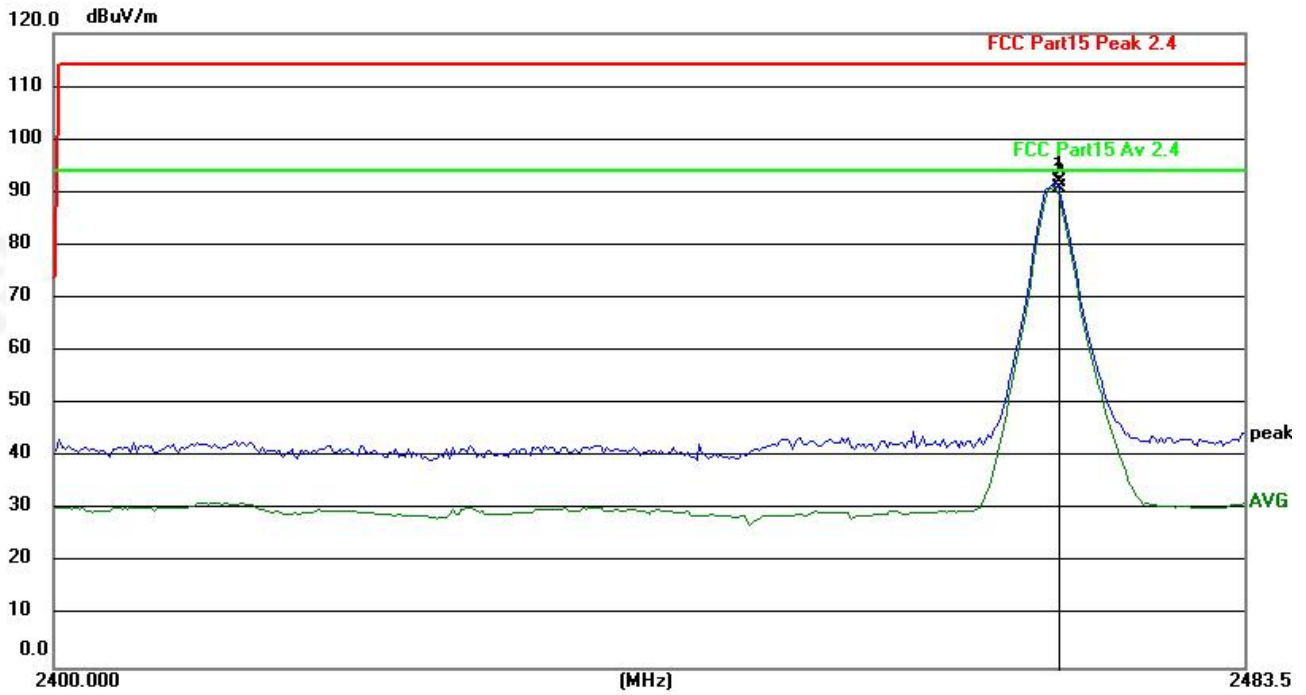

No.	Frequency (MHz)	Reading (dBuV)	Factor (dB/m)	Level (dBuV/m)	Limit (dBuV/m)	Margin (dB)	Detector
1	2475.159	92.98	-0.96	92.02	114.00	-21.98	peak
2	2475.159	91.61	-0.96	90.65	94.00	-3.35	AVG



6. BANDWIDTH OF FREQUENCY BAND EDGE

6.1 TEST REQUIREMENT:

Test Requirement:	FCC Part15 C Section 15.209 and 15.205				
Test Method:	ANSI C63.10: 2013				
Test Frequency Range:	All of the restrict bands were tested, only the worst band's (2310MHz to 2500MHz) data was showed.				
Test site:	Measurement Distance: 3m				
Receiver setup:	Frequency	Detector	RBW	VBW	Value
	Above 1GHz	Peak	1MHz	3MHz	Peak
		Average	1MHz	3MHz	Average

Emissions radiated outside of the specified frequency bands, except for harmonics, shall be attenuated by at least 50 dB below the level of the fundamental or to the general radiated emission limits in § 15.209, whichever is the lesser attenuation

6.2 TEST PROCEDURE

Above 1GHz test procedure as below:

- a. 1. The EUT was placed on the top of a rotating table 1.5 meters above the ground at a 3 meter camber. The table was rotated 360 degrees to determine the position of the highest radiation.
- b. The EUT was set 3 meters away from the interference-receiving antenna, which was mounted on the top of a variable-height antenna tower.
- c. The antenna height is varied from one meter to four meters above the ground to determine the maximum value of the field strength. Both horizontal and vertical polarizations of the antenna are set to make the measurement.
- d. For each suspected emission, the EUT was arranged to its worst case and then the antenna was tuned to heights from 1 meter to 4 meters and the rota table was turned from 0 degrees to 360 degrees to find the maximum reading.
- e. The test-receiver system was set to Peak Detect Function and Specified Bandwidth with Maximum Hold Mode.
- f. If the emission level of the EUT in peak mode was 10dB lower than the limit specified, then testing could be stopped and the peak values of the EUT would be reported. Otherwise the emissions that did not have 10dB margin would be re-tested one by one using peak, quasi-peak or average method as specified and then reported in a data sheet.
- g. Test the EUT in the lowest channel, the Highest channel

Note:

Both horizontal and vertical antenna polarities were tested and performed pretest to three orthogonal axis. The worst case emissions were reported

6.3 DEVIATION FROM TEST STANDARD

No deviation

6.4 TEST SETUP



Radiated Emission Test-Up Frequency Above 1GHz

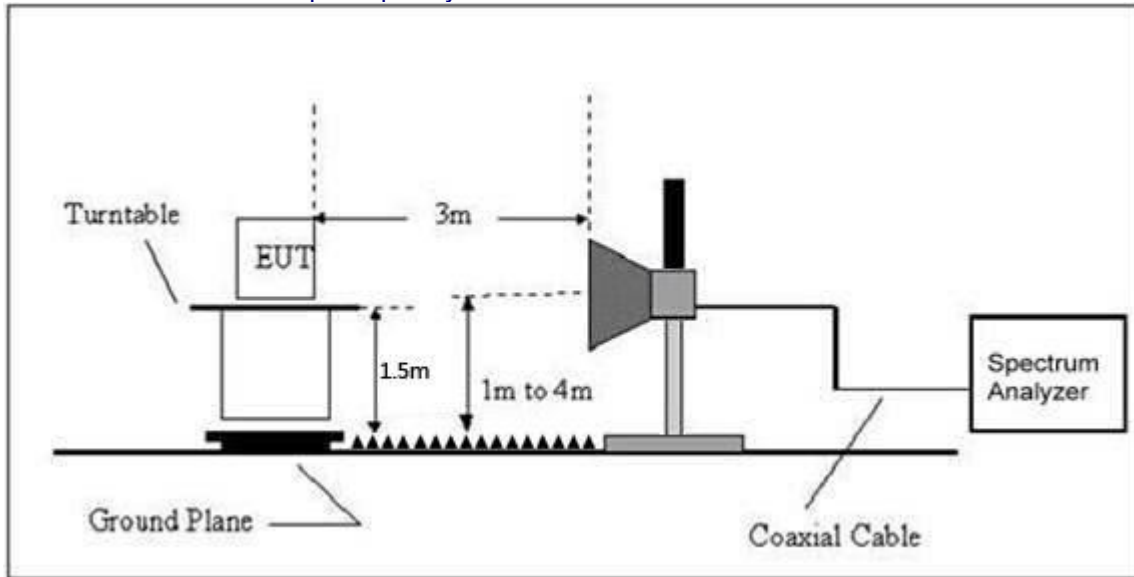

6.5 EUT OPERATING CONDITIONS

The EUT tested system was configured as the statements of 2.3 Unless otherwise a special operating condition is specified in the follows during the testing.



6.6 TEST RESULT

Temperature :	26 °C	Relative Humidity :	54%
Pressure :	101 kPa	Test Voltage :	DC 3V
Test Mode :	TX Mode		

Horizontal

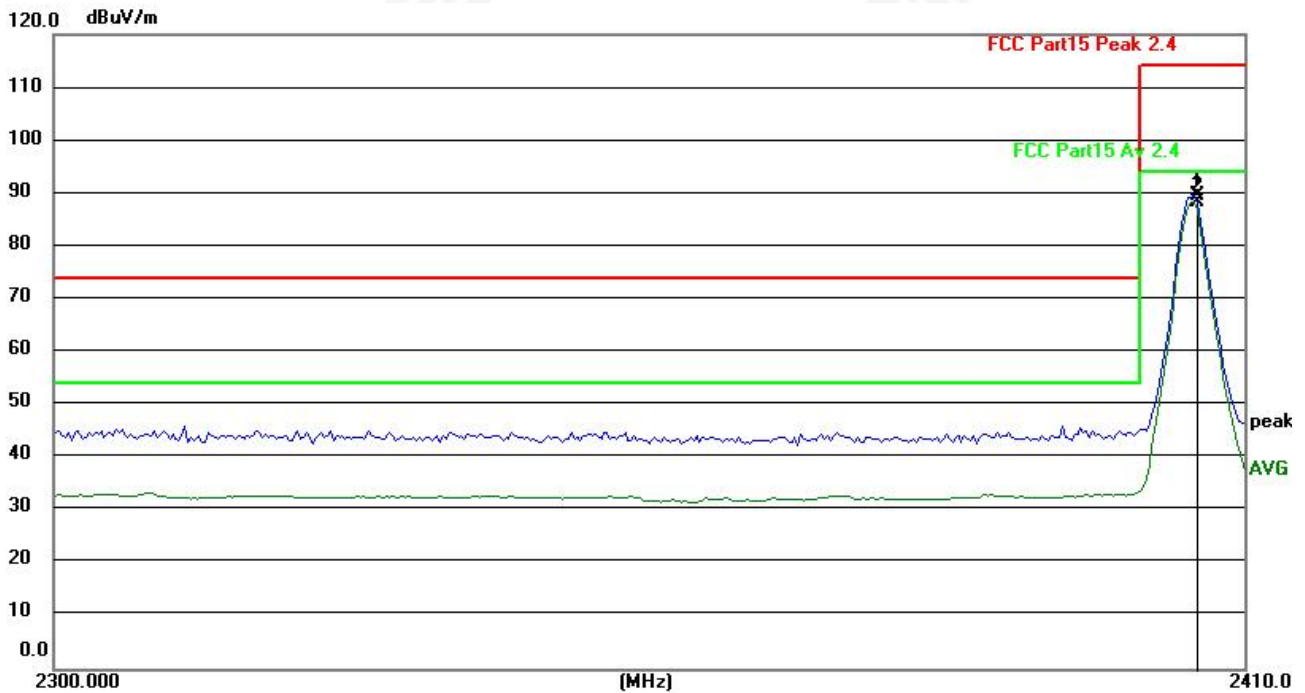

No.	Frequency (MHz)	Reading (dBuV)	Factor (dB/m)	Level (dBuV/m)	Limit (dBuV/m)	Margin (dB)	Detector
1	2405.220	90.70	-1.02	89.68	114.00	-24.32	peak
2	2405.220	89.51	-1.02	88.49	94.00	-5.51	AVG



Horizontal

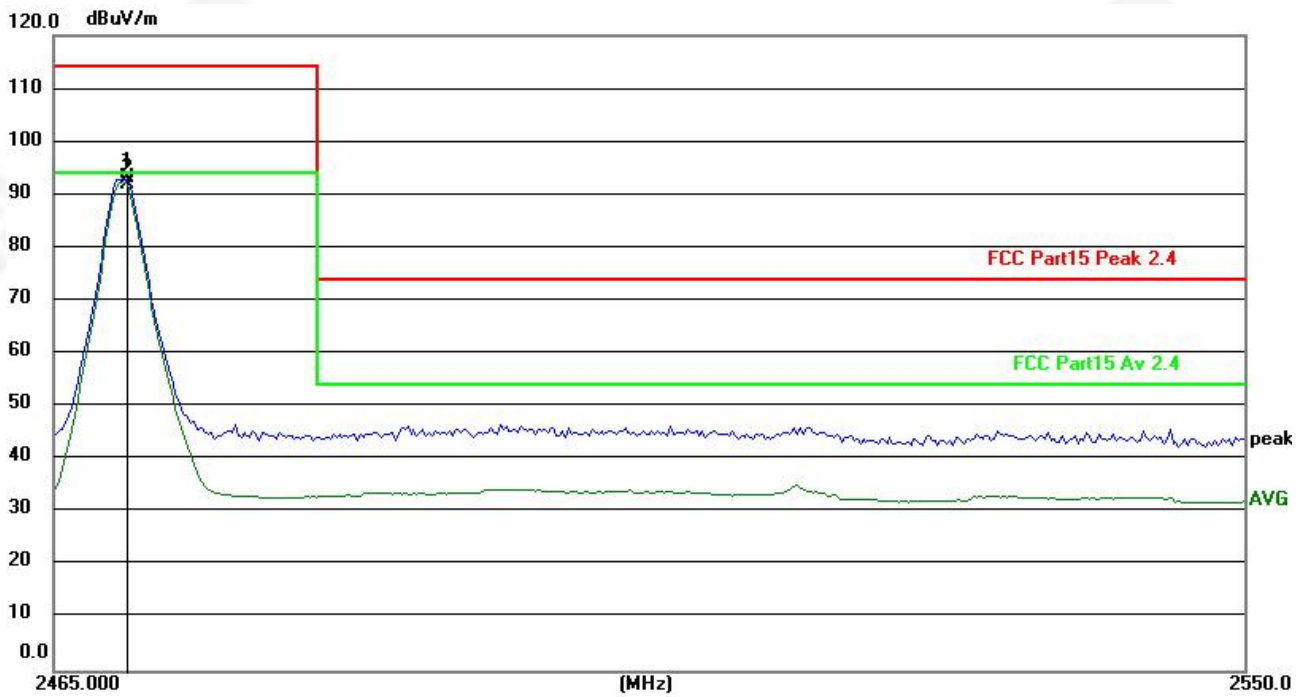

No.	Frequency (MHz)	Reading (dBuV)	Factor (dB/m)	Level (dBuV/m)	Limit (dBuV/m)	Margin (dB)	Detector
1	2476.228	94.00	-0.96	93.04	114.00	-20.96	peak
2	2476.228	92.83	-0.96	91.87	94.00	-2.13	AVG



Temperature :	26 °C	Relative Humidity :	54%
Pressure :	101 kPa	Test Voltage :	DC 3V
Test Mode :	TX Mode		

Vertical

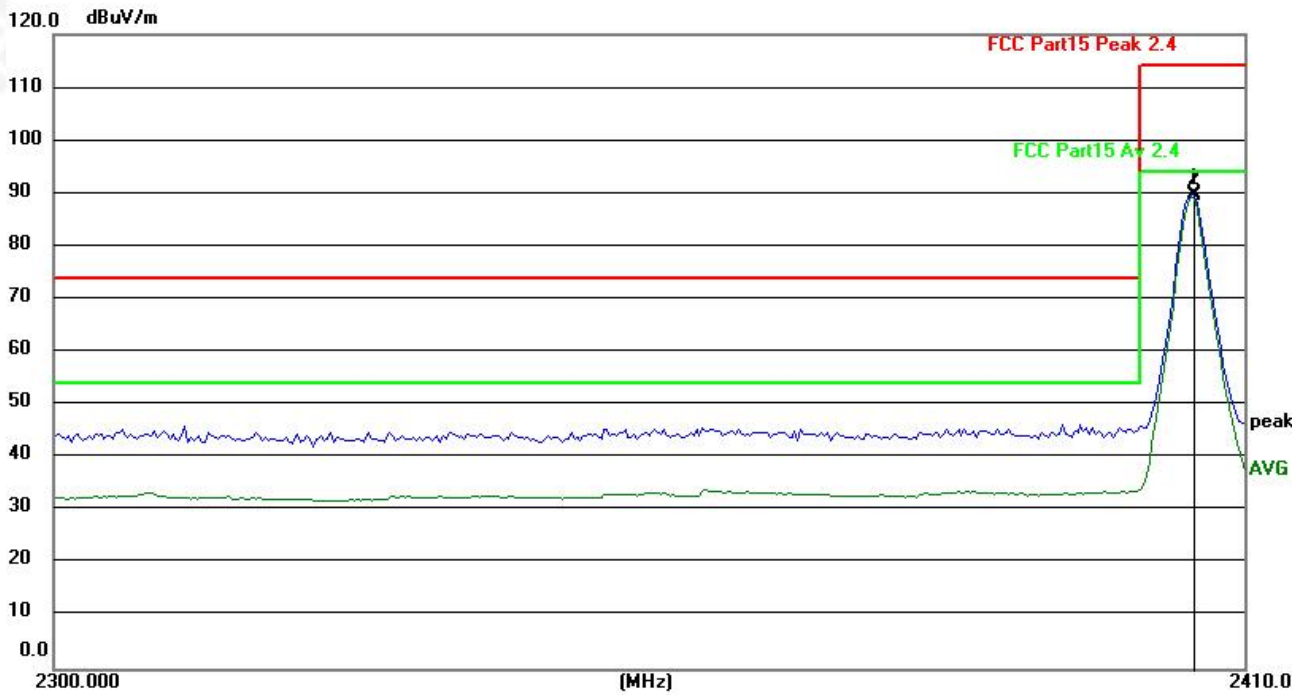

No.	Frequency (MHz)	Reading (dBuV)	Factor (dB/m)	Level (dBuV/m)	Limit (dBuV/m)	Margin (dB)	Detector
1	2404.939	90.85	-1.02	89.83	114.00	-24.17	peak
2	2404.939	90.43	-1.02	89.41	94.00	-4.59	AVG



Vertical

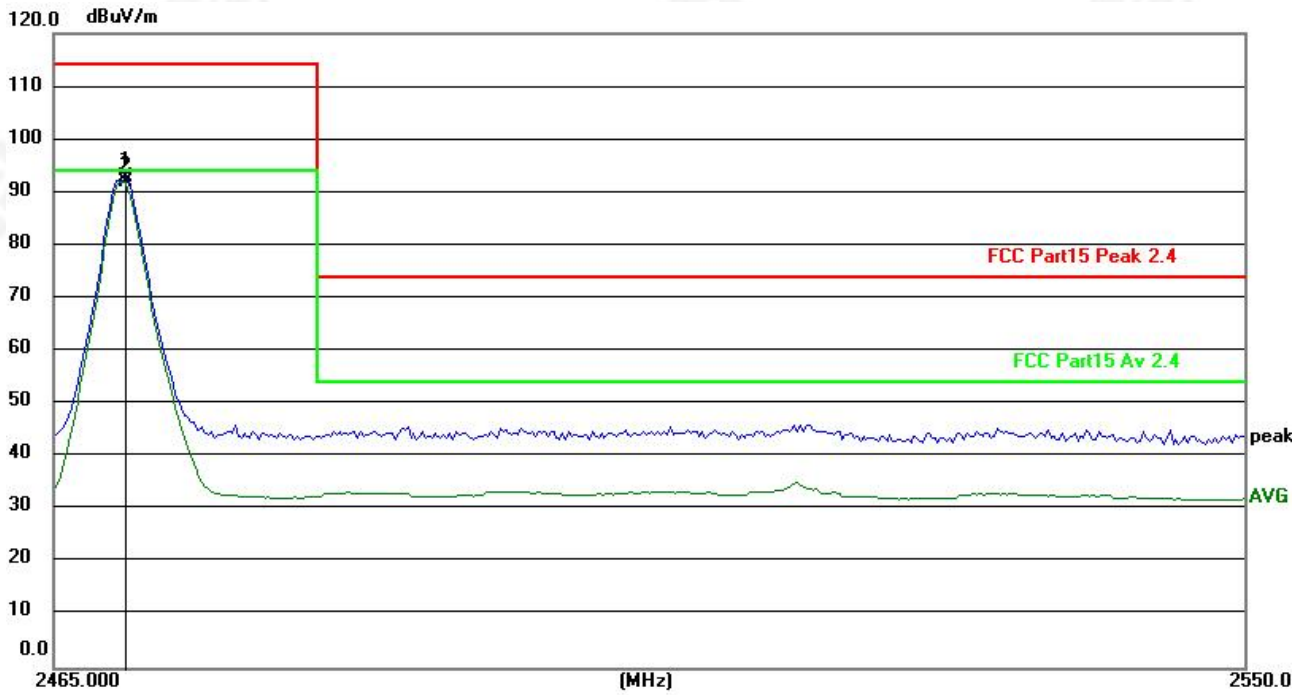

No.	Frequency (MHz)	Reading (dBuV)	Factor (dB/m)	Level (dBuV/m)	Limit (dBuV/m)	Margin (dB)	Detector
1	2476.019	93.94	-0.96	92.98	114.00	-21.02	peak
2	2476.019	93.06	-0.96	92.10	94.00	-1.90	AVG



7. CHANNEL BANDWIDTH

Test Requirement:	FCC Part15 C Section 15.249/15.215
Test Method:	ANSI C63.10: 2013

7.1 APPLIED PROCEDURES / LIMIT

FCC Part15 (15.249) , Subpart C			
Section	Test Item	Frequency Range (MHz)	Result
15.249(c)	Bandwidth	2400-2483.5	PASS

7.2 TEST PROCEDURE

1. Set resolution bandwidth (RBW) = 1-5% or DTS BW, not to exceed 100 kHz.
2. Set the video bandwidth (VBW) $\geq 3 \times$ RBW.
3. Detector = Peak.
4. Trace mode = max hold.
5. Sweep = auto couple.
6. Allow the trace to stabilize.
7. Measure the maximum width of the emission that is constrained by the frequencies associated with the two outermost amplitude points (upper and lower) that are attenuated by 6 dB relative to the maximum level measured in the fundamental emission.

7.3 DEVIATION FROM STANDARD

No deviation.

7.4 TEST SETUP



7.5 EUT OPERATION CONDITIONS

The EUT tested system was configured as the statements of 2.4 Unless otherwise a special operating condition is specified in the follows during the testing.



7.6 TEST RESULT

Temperature :	26°C	Relative Humidity :	54%
Test Mode :	GFSK	Test Voltage :	DC 3V

Mode	Test channel	20dB Emission Bandwidth (KHz)	Result
GFSK	2405MHz	249.9	Pass
GFSK	2451MHz	257.7	Pass
GFSK	2475MHz	257.9	Pass

2405MHz

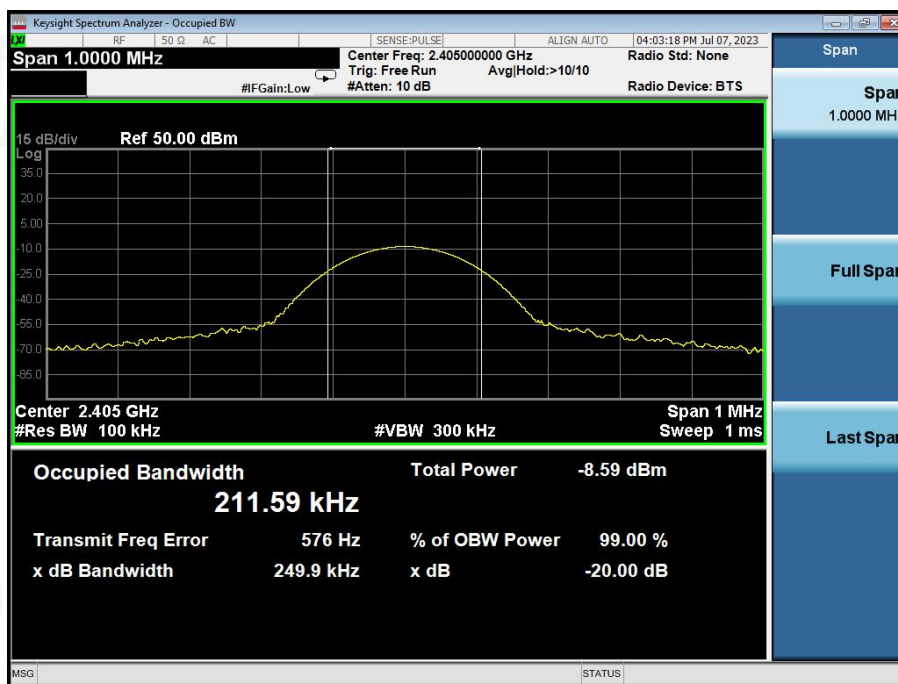



2451MHz

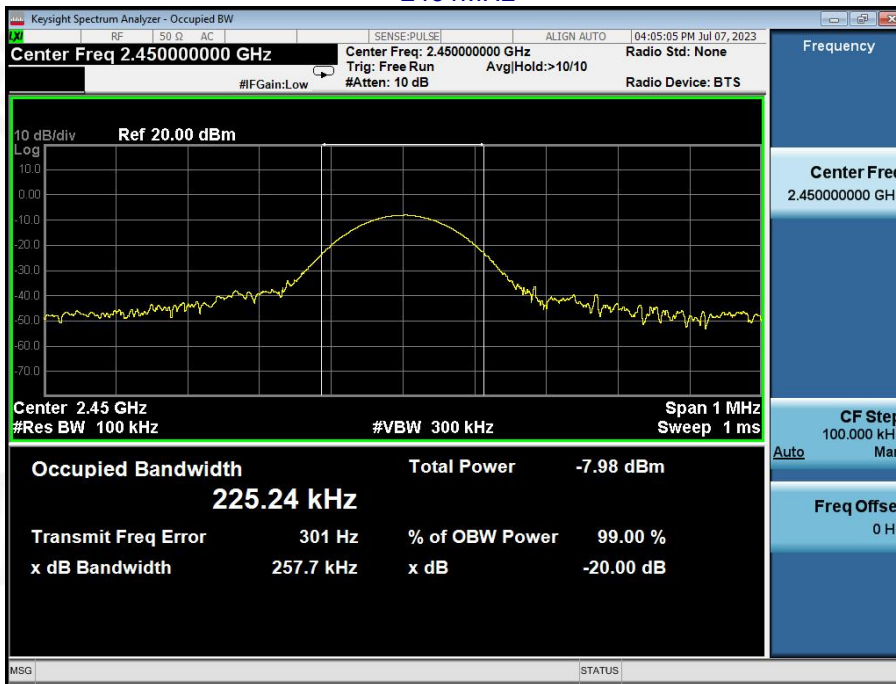

2475MHz

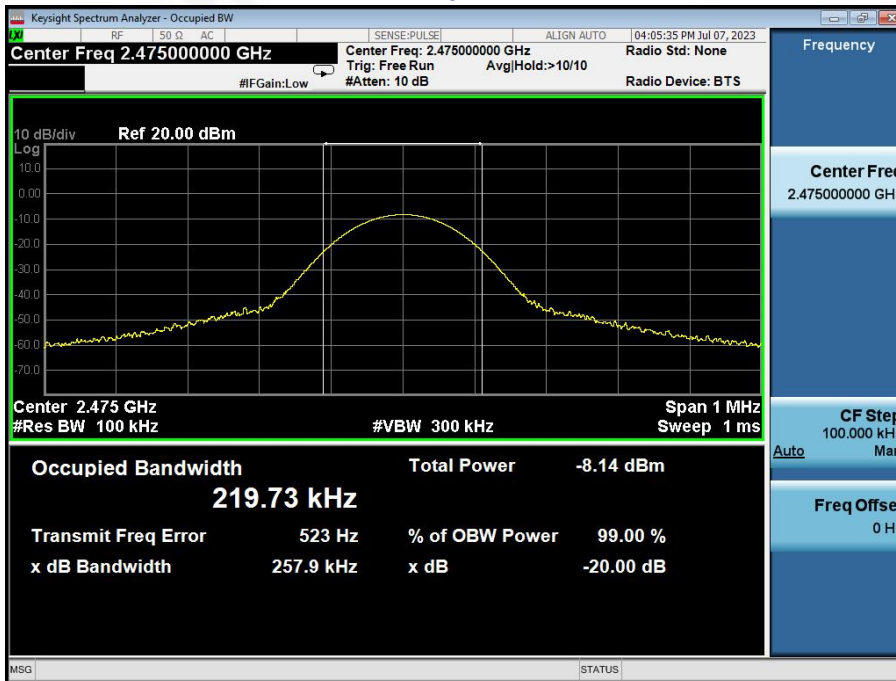



8.ANTENNA REQUIREMENT

Standard requirement:	FCC Part15 C Section 15.203
15.203 requirement: An intentional radiator shall be designed to ensure that no antenna other than that furnished by the responsible party shall be used with the device. The use of a permanently attached antenna or of an antenna that uses a unique coupling to the intentional radiator, the manufacturer may design the unit so that a broken antenna can be replaced by the user, but the use of a standard antenna jack or electrical connector is prohibited.	
EUT Antenna:	
The antennas are PCB antenna, the best case gain of the antennas are -1.66dBi, reference to the appendix II for details.	



9. TEST SETUP PHOTO

Reference to the appendix I for details.

10. EUT CONSTRUCTIONAL DETAILS

Reference to the appendix II for details.

***** END OF REPORT *****