



FCC 47 CFR PART 15 SUBPART C

TEST REPORT

FOR

Product Name: Navigator T835 Laser

Model : GM-100006/R

Trade Name: Genius

Issued to

KYE SYSTEMS CORP.

No.492,Sec.5, Chung Hsin Rd., San Chung, Taipei Hsien, 24160, Taiwan, R.O.C.

Issued by

Global Certification Corp.

EMI Test Site	Sansia Lab	NO.34-3,Zihhe Rd.,Sansia Township,Taipei County 237, Taiwan ,R.O.C.
EMC Test Site	Sijhih office and Lab	No. 146. Sec.2. Siangjhang Rd. Sijhih City. Taipei County 221, Taiwan(R.O.C.)

Note: This test refers exclusively to the test presented test model and sample. This report shall not be reproduced except in full, without the written approval of Global Certification Corporation. This document may be altered or revised by Global Certification Corporation. Personnel only, and shall be noted in the revision section of the document.



TABLE OF CONTENTS 2

1. GENERAL INFORMATION 3

 1.1 DESCRIPTION OF THE TESTED SAMPLES 4

2. TEST METHODOLOGY 5

 2.1 GENERAL TEST PROCEDURES 5

 2.2 FCC PART 15.205 RESTRICTED BANDS OF OPERATIONS 5

 2.3 DESCRIPTION OF TEST MODES 6

 2.4 DESCRIPTION OF THE SUPPORT EQUIPMENTS 7

3. TEST AND MEASUREMENT EQUIPMENT 9

 3.1 CALIBRATION 9

 3.2 EQUIPMENT 9

4. SECTION 15.249 REQUIREMENTS (FUNDAMENTAL/ HARMONICS) 10

 4.1 TEST SETUP 10

 4.2 LIMIT 10

 4.3 RESULT: PASSED 10

 4.4 TEST DATA: 11

5. SECTION 15.205 REQUIREMENTS (BAND EDGE) 19

 5.1 TEST SETUP 19

 5.2 LIMIT 19

 5.3 RESULT: PASSED 20

 5.4 TEST DATA: 20

6. SECTION 15.209 REQUIREMENTS (GENERAL RADIATED EMISSION) 24

 6.1 TEST SETUP 24

 6.2 LIMIT 25

 6.3 TEST PROCEDURE 26

 6.4 RESULT: PASSED 26

 6.5 TEST DATA: 27

7. SECTION 15.207 REQUIREMENTS (POWERLINE CONDUCTED EMISSIONS) 29

 7.1 TEST SET-UP (PLEASE REFER TO APPENDIX 1) 29

 7.2 LIMIT 29

 7.3 TEST PROCEDURE 29

 7.4 TEST SPECIFICATION 30

 7.5 RESULT: PASSED 30

 7.6 TEST DATA: 31

APPENDIX 1

PHOTOS OF TEST CONFIGURATION

APPENDIX 3

PHOTOS OF EUT



1. GENERAL INFORMATION

Applicant : **KYE SYSTEMS CORP.**
Address : **No.492,Sec.5, Chung Hsin Rd., San Chung, Taipei Hsien, 24160, Taiwan, R.O.C.**
Manufacturer : **KYE SYSTEMS CORP.**
Address : **No.492,Sec.5, Chung Hsin Rd., San Chung, Taipei Hsien, 24160, Taiwan, R.O.C.**
EUT : **Navigator T835 Laser**
Model Name : **GM-10006/R**
Model Differences : **N/A**

Is here with confirmed to comply with the requirements set out in the FCC Rules and Regulations Part 15 Subpart C and the measurement procedures were according to ANSI C63.4-2003. The said equipment in the configuration described in this report shows the maximum emission levels emanating from equipment are within the compliance requirements.

FCC part 15 subpart C

Receipt Date : 04/07/2010

Final Test Date : 04/28/2010

Taipei, Taiwan

Apr. 28, 2010

Alex Chou / Manager

(Place)

(Date)

(Signature)

Designation Number: TW1030



1.1 DESCRIPTION OF THE TESTED SAMPLES

EUT Name : Navigator T835 Laser
 Model Number : GM-100006/R
 FCC ID : FSUGMZJA
 Input Voltage : 5Vdc
 Power From Inside Outside
Adaptor BATTERY AC Power Source DC Power Source
Support Unit PC
 Operate Frequency : Refer to the channel list as described below
 Modulation Technique : GFSK
 Number of Channels : 79
 Channel spacing : N/A 1 MHz
 Operating Mode : Simplex Duplex
 Antenna Type : integral antenna: PCB Printing a dedicated antenna
 Antenna gain : -3dBi

Channels	Frequencies (MHz)	Channels	Frequencies (MHz)
0	2402	40	2442
1	2403	41	2443
2	2404	42	2444
3	2405	43	2445
4	2406	44	2446
5	2407	45	2447
6	2408	46	2448
7	2409	47	2449
8	2410	48	2450
9	2411	49	2451
10	2412	50	2452
11	2413	51	2453
12	2414	52	2454
13	2415	53	2455
14	2416	54	2456
15	2417	55	2457
16	2418	56	2458
17	2419	57	2459
18	2420	58	2460
19	2421	59	2461
20	2422	60	2462
21	2423	61	2463
22	2424	62	2464



23	2425	63	2465
24	2426	64	2466
25	2427	65	2467
26	2428	66	2468
27	2429	67	2469
28	2430	68	2470
29	2431	69	2471
30	2432	70	2472
31	2433	71	2473
32	2434	72	2474
33	2435	73	2475
34	2436	74	2476
35	2437	75	2477
36	2438	76	2478
37	2439	77	2479
38	2440	78	2480
39	2441		

2. TEST METHODOLOGY

All testing as described bellowed were performed in accordance with ANSI C63.4:2003 and FCC CFR 47 Part 15 Subpart C.

2.1 GENERAL TEST PROCEDURES

Conducted Emissions

The EUT is placed on a wood table, which is at 0.8 m above ground plane acceding to clause 15.207 and requirements of ANSI C63.4:2003. Conducted emissions from the EUT measured in the frequency range between 0.15 MHz and 30MHz are using CISPR Quasi-Peak / Average detectors.

Radiated Emissions

The EUT is a placed on a turn table, which is 0.8 m above ground plane. The turntable was rotated through 360 degrees to determine the position of maximum emission level. The EUT is placed at 3m away from the receiving antenna, which varied from 1m to 4m to find out the highest emission. Each emission was to be maximized by changing the polarization of receiving antenna both horizontal and vertical.

2.2 FCC PART 15.205 RESTRICTED BANDS OF OPERATIONS

- (a) Except as shown in paragraph (d) of this section, only spurious emissions are permitted in any of the frequency bands listed below:



MHz	MHz	MHz	GHz
0.090 - 0.110	16.42 - 16.423	399.9 - 410	4.5 - 5.15
10.495 - 0.505	16.69475 - 16.69525	608 - 614	5.35 - 5.46
2.1735 - 2.1905	16.80425 - 16.80475	960 - 1240	7.25 - 7.75
4.125 - 4.128	25.5 - 25.67	1300 - 1427	8.025 - 8.5
4.17725 - 4.17775	37.5 - 38.25	1435 - 1626.5	9.0 - 9.2
4.20725 - 4.20775	73 - 74.6	1645.5 - 1646.5	9.3 - 9.5
6.215 - 6.218	74.8 - 75.2	1660 - 1710	10.6 - 12.7
6.26775 - 6.26825	108 - 121.94	1718.8 - 1722.2	13.25 - 13.4
6.31175 - 6.31225	123 - 138	2200 - 2300	14.47 - 14.5
8.291 - 8.294	149.9 - 150.05	2310 - 2390	15.35 - 16.2
8.362 - 8.366	156.52475 - 156.52525	2483.5 - 2500	17.7 - 21.4
8.37625 - 8.38675	156.7 - 156.9	2655 - 2900	22.01 - 23.12
8.41425 - 8.41475	162.0125 - 167.17	3260 - 3267	23.6 - 24.0
12.29 - 12.293	167.72 - 173.2	3332 - 3339	31.2 - 31.8
12.51975 - 12.52025	240 - 285	3345.8 - 3358	36.43 - 36.5
12.57675 - 12.57725	322 - 335.4	3600 - 4400	(²)
13.36 - 13.41			

1 Until February 1, 1999, this restricted band shall be 0.490-0.510 MHz.

2 Above 38.6

(b) Except as provided in paragraphs (d) and (e), the field strength of emissions appearing within these frequency bands shall not exceed the limits shown in Section 15.209. At frequencies equal to or less than 1000 MHz, compliance with the limits in Section 15.209 shall be demonstrated using measurement instrumentation employing a CISPR quasi-peak detector. Above 1000 MHz, compliance with the emission limits in Section 15.209 shall be demonstrated based on the average value of the measured emissions. The provisions in Section 15.35 apply to these measurements.

2.3 DESCRIPTION OF TEST MODES

The EUT was tested under following modes:

Modes:

1. Continuous transmitting

Channels:

1. 2.402GHz (Lowest Channel)
2. 2.440GHz (Middle Channel)
3. 2.480GHz (Highest Channel)

2.4 DESCRIPTION OF THE SUPPORT EQUIPMENTS

Setup Diagram

See test photographs attached in appendix 1 for the actual connections between EUT and support equipment.

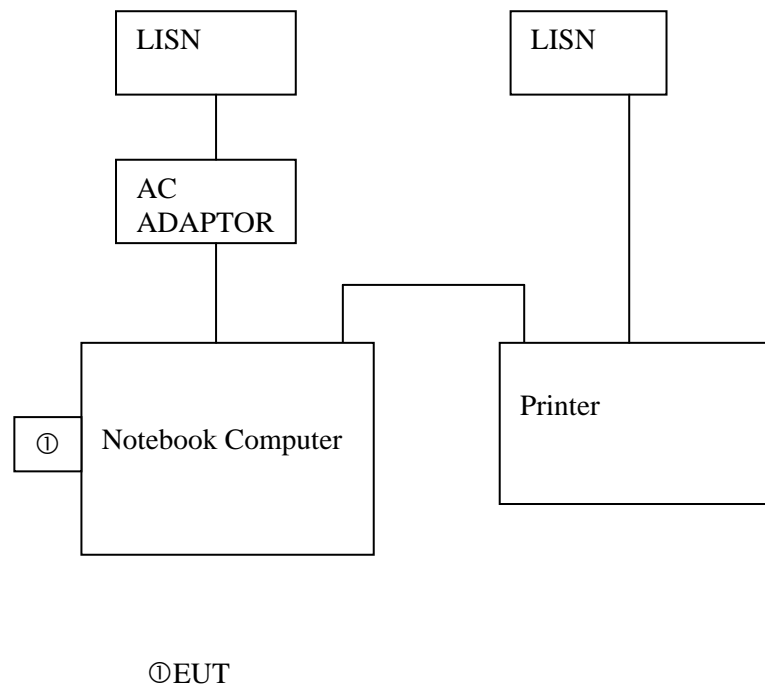



Support Equipment

Peripherals Devices:

OUTSIDE SUPPORT EQUIPMENT							
No.	Equipment	Model	Serial No.	FCC ID/ BSMI ID	Trade name	Data Cable	Power Cord
1	Notebook Computer	NOM-018	00-06-1B- DF87-D7	R33026	IBM	Unshielded 1.0M	Unshielded 1.8M
2	PRINTER	PHOTO750	BDEK017 629	3872P011	EPSON	Shielded 1.8M	Unshielded 1.8M

Note: All the above equipment /cable were placed in worse case position to maximize emission signals during emission test
Grounding: Grounding was in accordance with the manufacturer's requirement and conditions for the intended use.



3. TEST AND MEASUREMENT EQUIPMENT

3.1 CALIBRATION

The measuring equipment utilized to perform the tests documented in the report has been calibrated once a year or in accordance with the manufacturer’s recommendations, and is traceable to recognized national standards.

3.2 EQUIPMENT

The following list contains measurement equipment used for testing. The equipment conforms to the requirement of CISPR 16-1, ANSI C63.2 and. Other required standards.

Calibration of all test and measurement, including any accessories that may effect such calibration, is checked frequently to ensure the accuracy. Adjustments are made and correction factors are applied in accordance with the instructions contained in the respective.

TABLE 1 LIST OF TEST AND MEASUREMENT EQUIPMENT

Instrument	Manufacturer	Model No.	Serial No.	Calibration Due Date	Note
EMC Test Receiver	R&S	ESCI	100438	Apr 29, 2010	
Bilog Antenna	SUNOL	JB1	A052204	Nov 06, 2010	
Turn table	EMCO	2080	9508-1805	N/A	
Controller	EMCO	2090	9804-1328	N/A	
Amplifier	G.W	GAP-801	EF150001	Jul.18, 2010	
Amplifier	Schwarzbeck	BBV 9718	9718-008	Aug. 10, 2010	
Spectrum Analyzer	NEX1	Ns-265	5044006	Aug 07, 2010	
RF Cable	BELDEN	RG-8/U	28M-002	Nov 02, 2010	
RF Cable	Huber Suhner	SUCOFLEX 104	293864/4	Nov. 13, 2010	
Thermo-Hygro meter	WISEWIND	4-IN-1	050100378	Apr 08, 2010	
Loop Antenna	TESEO	HLA6120	26349	Sep.11, 2010	
Horn Antenna	Schwarzbeck	BBHA 9120D	9120D-491	Aug. 05, 2010	

✘ Calibration interval of instruments listed above is one year



4. SECTION 15.249 REQUIREMENTS (FUNDAMENTAL/ HARMONICS)

4.1 TEST SETUP

Refer to paragraph 6.1.

4.2 LIMIT

Fundamental Frequency (MHz)	Field Strength of Fundamental (dBμV/m at 3-meter)	Detector
902 - 928 2400 – 2483 5725 - 5875	114	Peak
902 - 928 2400 – 2483 5725 - 5875	94	AV

Fundamental Frequency (MHz)	Field Strength of Harmonics (dBμV/m at 3-meter)	Detector
902 - 928 2400 – 2483 5725 - 5875	74	Peak
902 - 928 2400 – 2483 5725 - 5875	54	AV

4.3 RESULT: PASSED



4.4 TEST DATA:

Fundamental

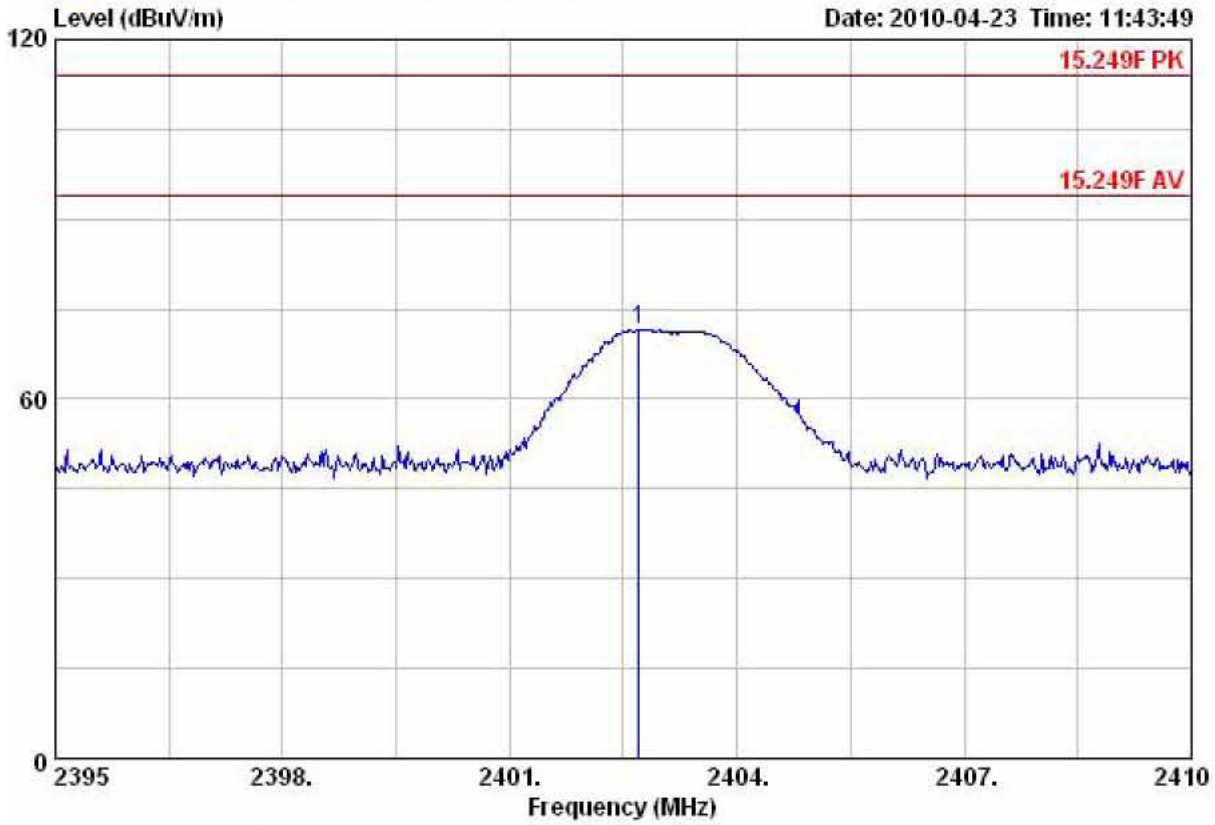

Read Freq	Read Level	Factor	Level	Limit Line	Over Limit	Pol/Phase	Remark
MHz	dBuV	dB/m	dBuV/m	dBuV/m	dB		
2402.71	78.09	-6.44	71.65	114.00	-42.35	HORIZONTAL	Peak

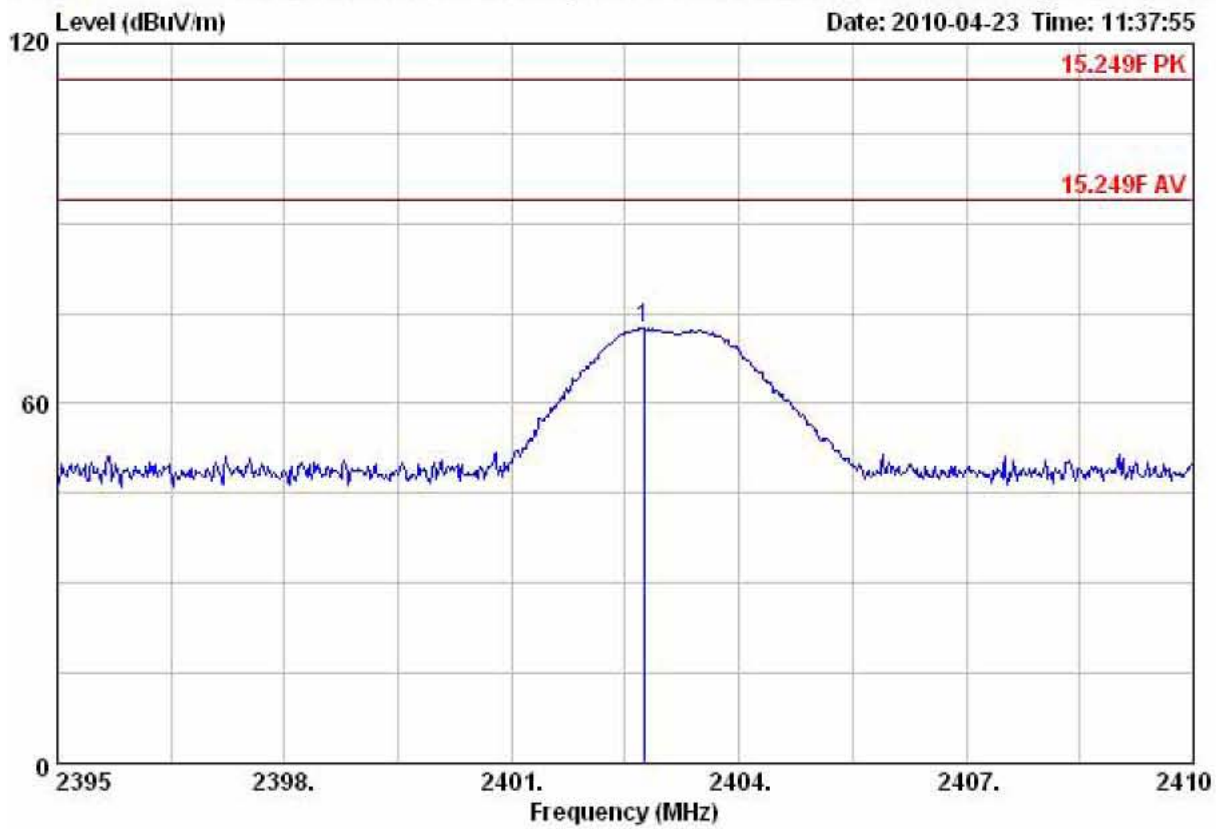

Read Freq	Level	Factor	Level	Limit Line	Over Limit	Pol/Phase	Remark
MHz	dBuV	dB/m	dBuV/m	dBuV/m	dB		
2402.74	78.98	-6.44	72.54	114.00	-41.46	VERTICAL	Peak

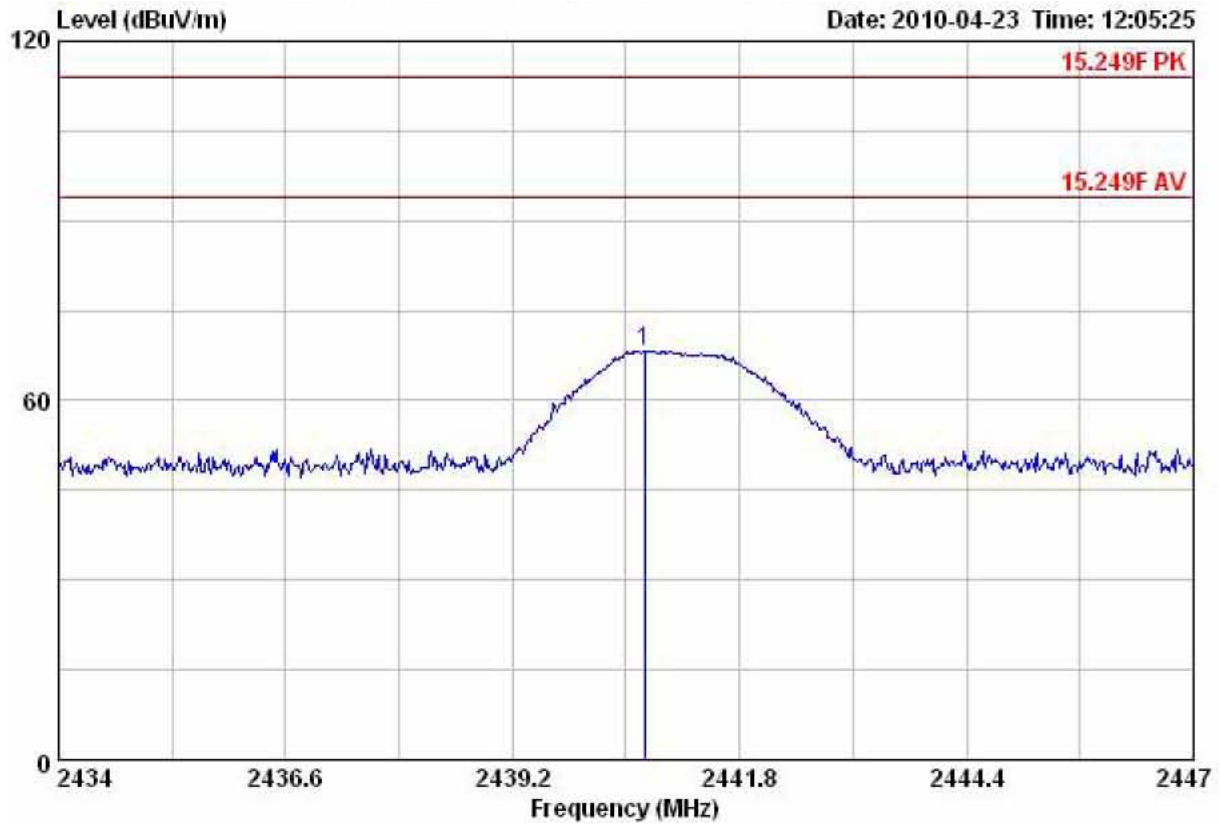

Freq	Read Level	Factor	Level	Limit Line	Over Limit	Pol/Phase	Remark
MHz	dBuV	dB/m	dBuV/m	dBuV/m	dB		
2440.71	74.44	-6.11	68.33	114.00	-45.67	HORIZONTAL	Peak

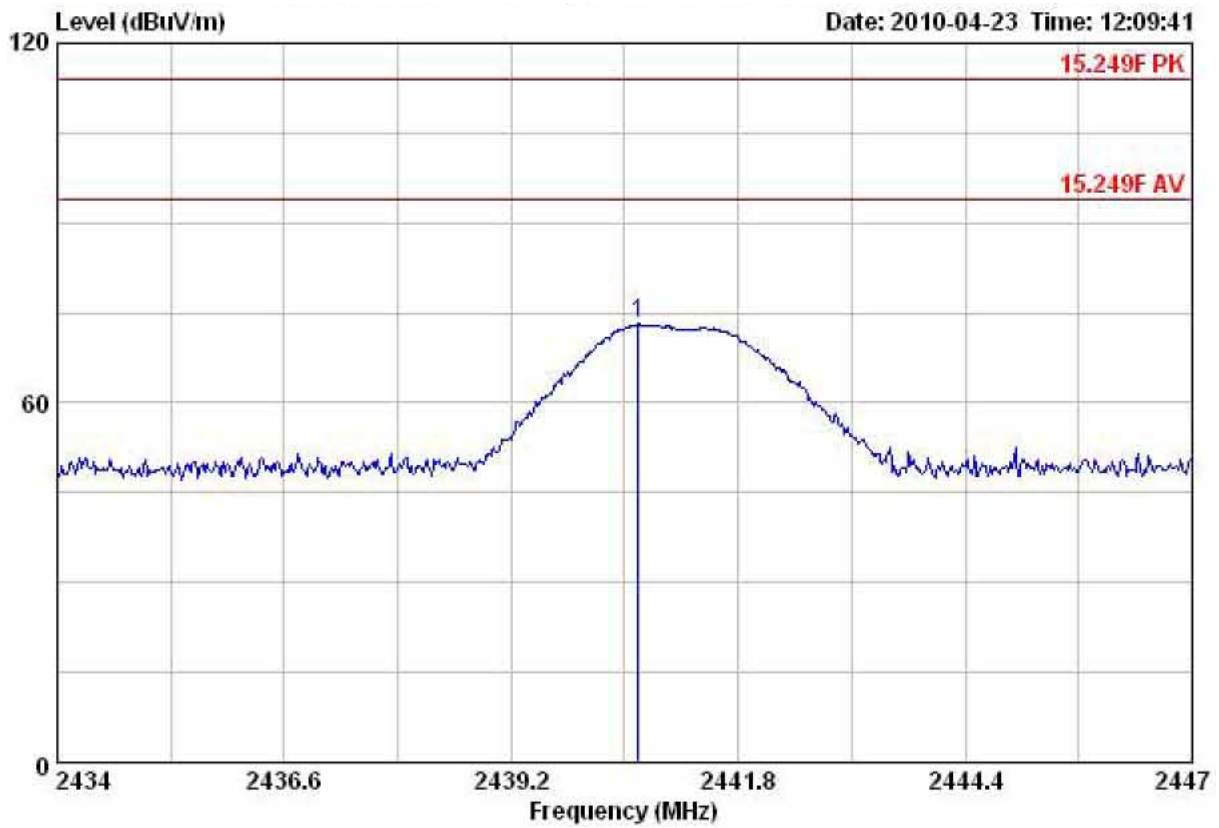

Freq	Read Level	Factor	Level	Limit Line	Over Limit	Pol/Phase	Remark
MHz	dBuV	dB/m	dBuV/m	dBuV/m	dB		
2440.66	79.22	-6.11	73.11	114.00	-40.89	VERTICAL	Peak

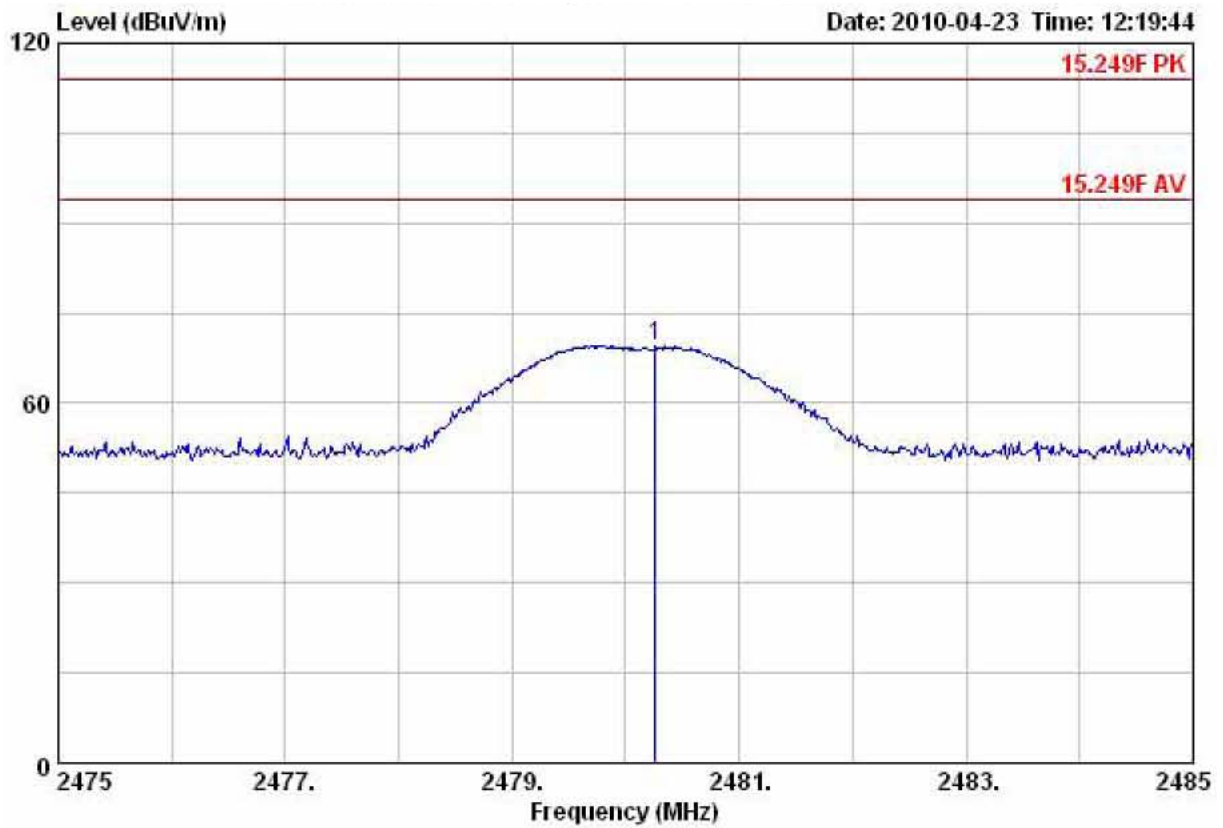

Freq	Read Level	Factor	Level	Limit Line	Over Limit	Pol/Phase	Remark
MHz	dBuV	dB/m	dBuV/m	dBuV/m	dB		
2480.26	75.30	-5.76	69.54	114.00	-44.46	HORIZONTAL	Peak

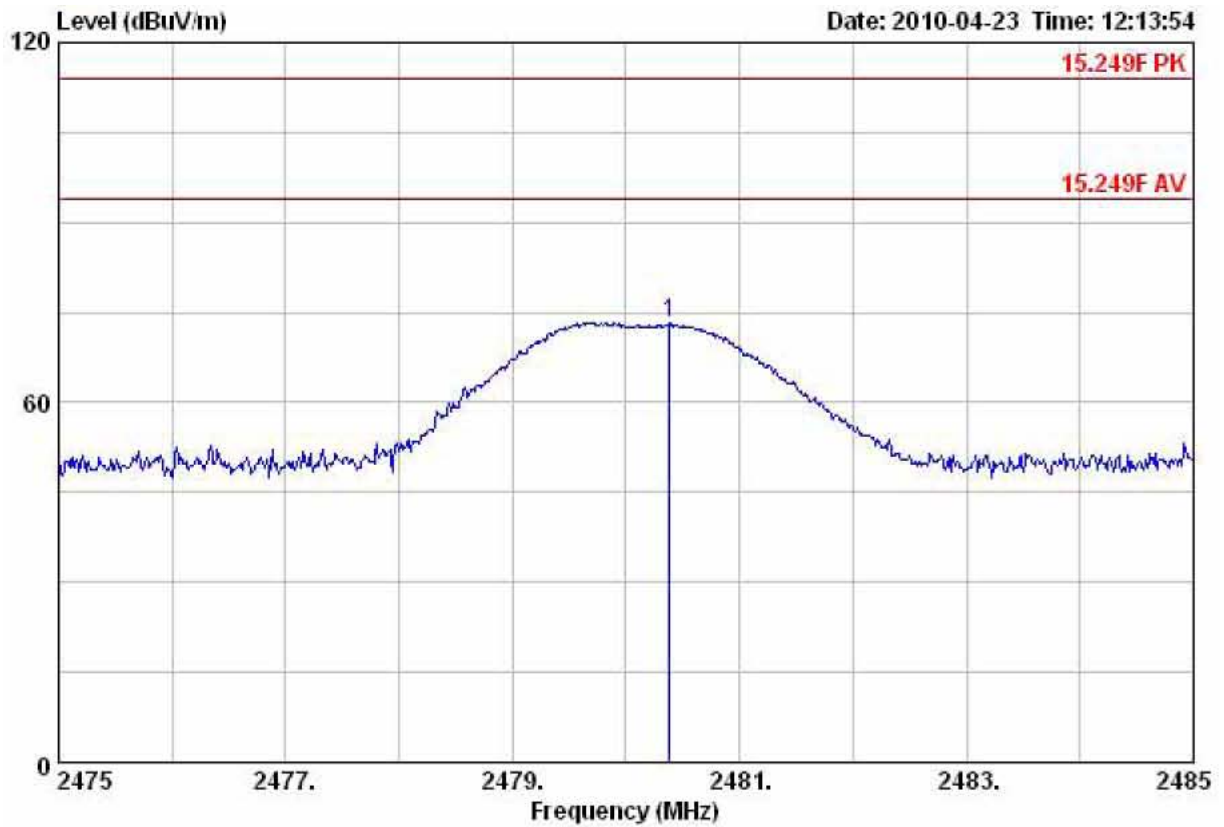

Freq	Read	Factor	Level	Limit	Over	Pol/Phase	Remark
MHz	dBuV	dB/m	dBuV/m	dBuV/m	dB		
2480.38	79.07	-5.76	73.31	114.00	-40.69	VERTICAL	Peak



Harmonics -Lowest Channel

Freq	Read Level	Factor	Level	Limit Line	Over Limit	Pol/Phase	Remark
MHz	dBuV	dB/m	dBuV/m	dBuV/m	dB		
4804.00	42.13	0.94	43.07	74.00	-30.93	HORIZONTAL	Peak
7206.00	39.94	7.28	47.22	74.00	-26.78	HORIZONTAL	Peak
9565.00	41.95	10.41	52.36	74.00	-21.64	HORIZONTAL	Peak

Freq	Read Level	Factor	Level	Limit Line	Over Limit	Pol/Phase	Remark
MHz	dBuV	dB/m	dBuV/m	dBuV/m	dB		
4804.00	42.17	0.94	43.11	74.00	-30.89	VERTICAL	Peak
7206.00	40.73	7.28	48.01	74.00	-25.99	VERTICAL	Peak
9608.00	40.34	10.49	50.83	74.00	-23.17	VERTICAL	Peak

Harmonics –Middle Channel

Freq	Read Level	Factor	Level	Limit Line	Over Limit	Pol/Phase	Remark
MHz	dBuV	dB/m	dBuV/m	dBuV/m	dB		
4880.00	41.20	1.00	42.20	74.00	-31.80	HORIZONTAL	Peak
7320.00	37.53	8.11	45.64	74.00	-28.36	HORIZONTAL	Peak
9760.00	38.11	10.77	48.88	74.00	-25.12	HORIZONTAL	Peak

Freq	Read Level	Factor	Level	Limit Line	Over Limit	Pol/Phase	Remark
MHz	dBuV	dB/m	dBuV/m	dBuV/m	dB		
4880.00	40.43	1.00	41.43	74.00	-32.57	VERTICAL	Peak
7320.00	38.87	8.11	46.98	74.00	-27.02	VERTICAL	Peak
9760.00	38.25	10.77	49.02	74.00	-24.98	VERTICAL	Peak

Harmonics -Highest Channel

Freq	Read Level	Factor	Level	Limit Line	Over Limit	Pol/Phase	Remark
MHz	dBuV	dB/m	dBuV/m	dBuV/m	dB		
4960.00	40.55	1.07	41.62	74.00	-32.38	HORIZONTAL	Peak
7440.00	38.50	8.97	47.47	74.00	-26.53	HORIZONTAL	Peak
9920.00	38.89	11.05	49.94	74.00	-24.06	HORIZONTAL	Peak



Freq	Read Level	Factor	Level	Limit Line	Over Limit	Pol/Phase	Remark
MHz	dBuV	dB/m	dBuV/m	dBuV/m	dB		
4960.00	43.53	1.07	44.60	74.00	-29.40	VERTICAL	Peak
7440.00	38.21	8.97	47.18	74.00	-26.82	VERTICAL	Peak
9920.00	40.00	11.05	51.05	74.00	-22.95	VERTICAL	Peak

Note:

1. Emission level = Reading level + Correction factor
2. Correction factor : Antenna factor, Cable loss, PreAmp, etc.
3. All emissions as described above were determining by rotating the EUT through three orthogonal axes to maximizing the emissions if the EUT belongs to hand-held or body-worn devices.
4. Measurements above 1000 MHz, Peak detector setting: use a 1 MHz RBW, a 3 MHz VBW.
5. Measurements above 1000 MHz, Average detector setting: 1 MHz RBW with 10 Hz VBW
6. Peak detector measurement data will represent the worst case results.
7. “---” denotes the data which is not available.



5. SECTION 15.205 REQUIREMENTS (BAND EDGE)

5.1 TEST SETUP

Refer to paragraph 6.1.

5.2 LIMIT

Restricted Bands:

MHz	MHz	MHz	GHz
0.090 - 0.110	16.42 - 16.423	399.9 - 410	4.5 - 5.15
¹ 0.495 - 0.505	16.69475 - 16.69525	608 - 614	5.35 - 5.46
2.1735 - 2.1905	16.80425 - 16.80475	960 - 1240	7.25 - 7.75
4.125 - 4.128	25.5 - 25.67	1300 - 1427	8.025 - 8.5
4.17725 - 4.17775	37.5 - 38.25	1435 - 1626.5	9.0 - 9.2
4.20725 - 4.20775	73 - 74.6	1645.5 - 1646.5	9.3 - 9.5
6.215 - 6.218	74.8 - 75.2	1660 - 1710	10.6 - 12.7
6.26775 - 6.26825	108 - 121.94	1718.8 - 1722.2	13.25 - 13.4
6.31175 - 6.31225	123 - 138	2200 - 2300	14.47 - 14.5
8.291 - 8.294	149.9 - 150.05	2310 - 2390	15.35 - 16.2
8.362 - 8.366	156.52475 - 156.52525	2483.5 - 2500	17.7 - 21.4
8.37625 - 8.38675	156.7 - 156.9	2690 - 2900	22.01 - 23.12
8.41425 - 8.41475	162.0125 - 167.17	3260 - 3267	23.6 - 24.0
12.29 - 12.293	167.72 - 173.2	3332 - 3339	31.2 - 31.8
12.51975 - 12.52025	240 - 285	3345.8 - 3358	36.43 - 36.5
12.57675 - 12.57725	322 - 335.4	3600 - 4400	(²)
13.36 - 13.41			

Operation within the bands:

902 - 928 MHz, 2400 - 2483.5 MHz, 5725 - 5875 MHz, and 24.0 - 24.25 GHz.

Frequency (Hz)	Field Strength (μ V/m at 3-meter)	Field Strength (dB μ V/m at 3-meter)
1.705-30	30 (at 30-meter)	49.5
30-88	100	40
88-216	150	43
216-960	200	46
Above 960	500	54



5.3 RESULT: PASSED

5.4 TEST DATA:

Lowest Channel-Horizontal

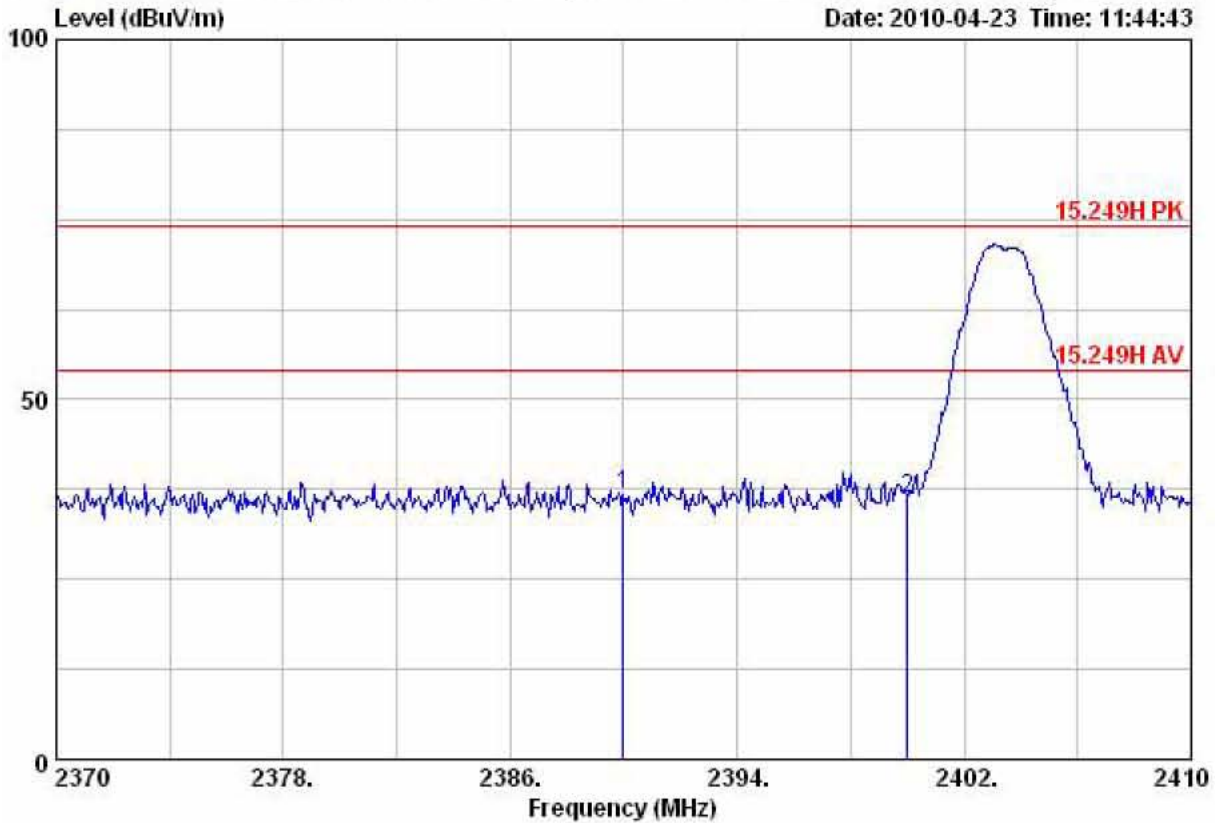

Read Freq	Read Level	Factor	Level	Limit Line	Over Limit	Pol/Phase	Remark
MHz	dBuV	dB/m	dBuV/m	dBuV/m	dB		
2390.00	43.41	-6.54	36.87	74.00	-37.13	HORIZONTAL	Peak
2400.00	42.81	-6.46	36.35	74.00	-37.65	HORIZONTAL	Peak



Lowest Channel-Vertical

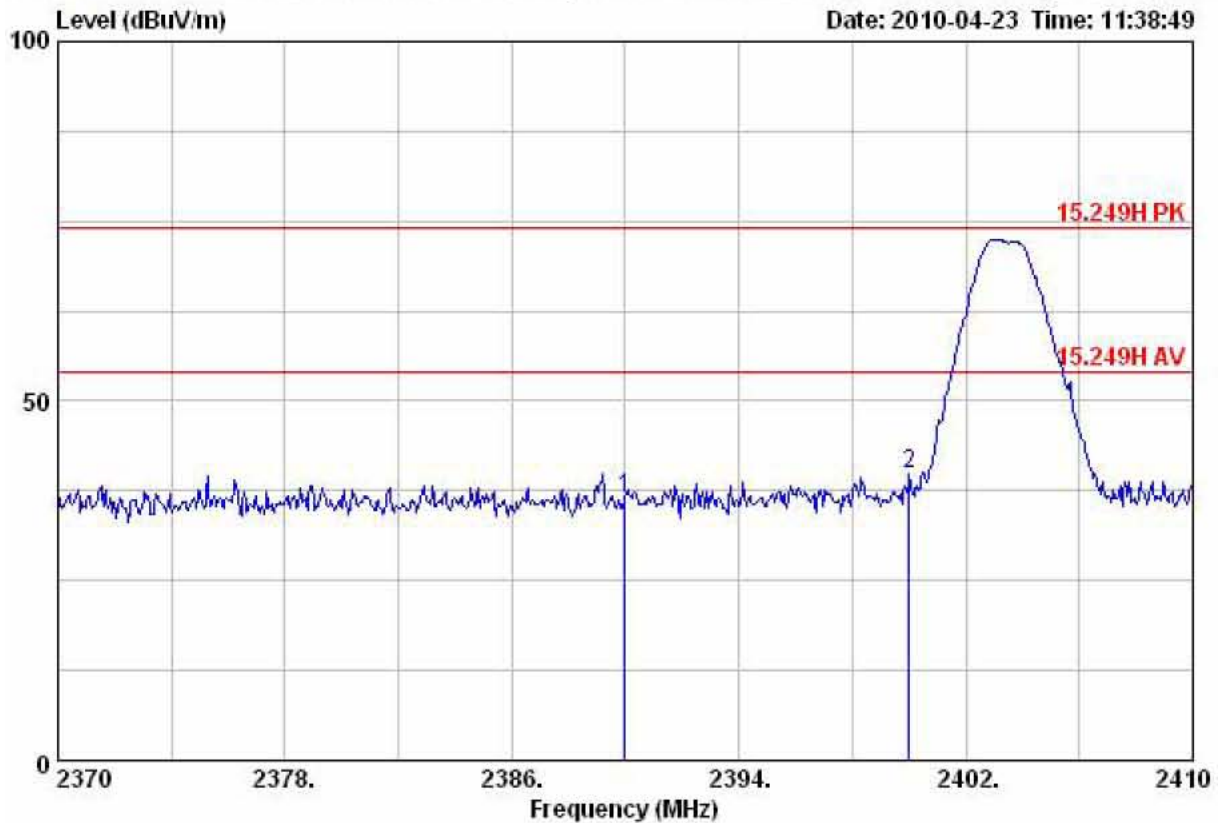

Freq	Read Level	Factor	Level	Limit Line	Over Limit	Pol/Phase	Remark
MHz	dBuV	dB/m	dBuV/m	dBuV/m	dB		
2390.00	43.11	-6.54	36.57	74.00	-37.43	VERTICAL	Peak
2400.00	46.28	-6.46	39.82	74.00	-34.18	VERTICAL	Peak



Highest Channel-Horizontal

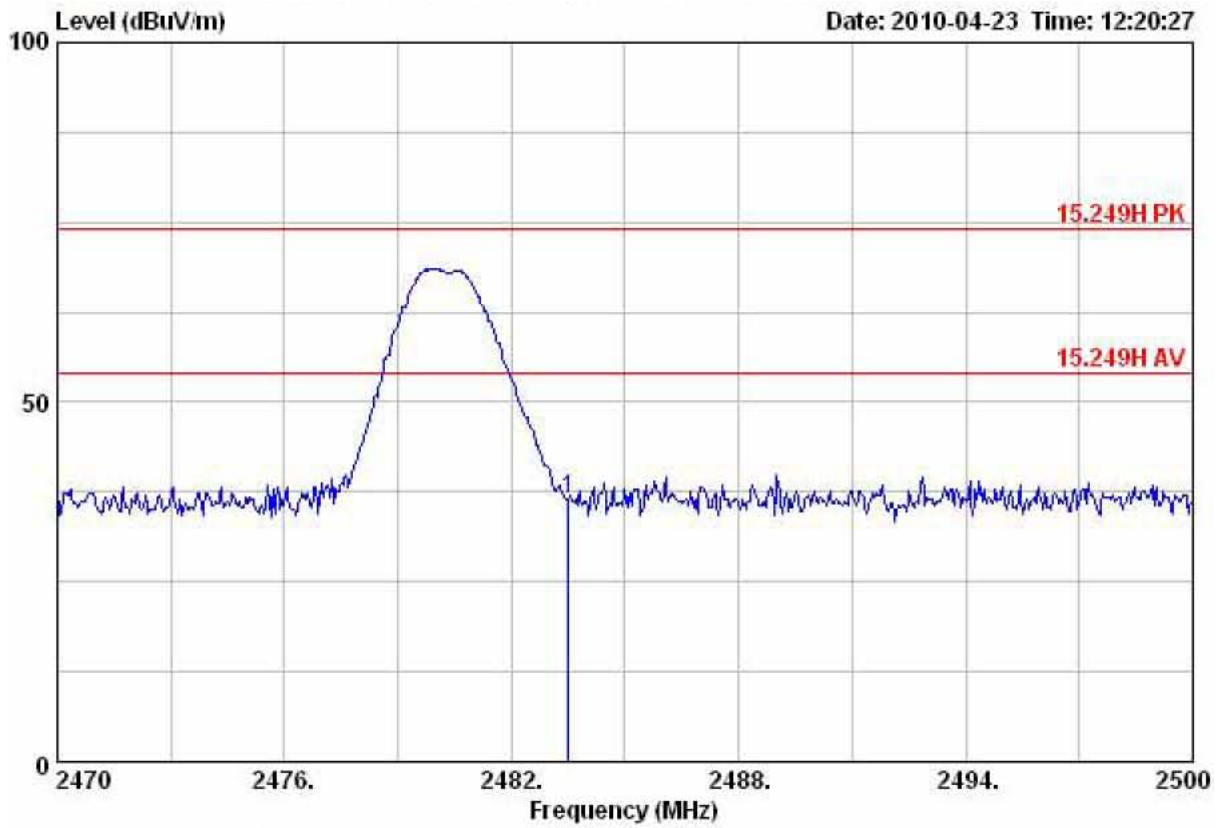

Freq	Read Level	Factor	Level	Limit Line	Over Limit	Pol/Phase	Remark
MHz	dBuV	dB/m	dBuV/m	dBuV/m	dB		
2483.50	42.25	-5.74	36.51	74.00	-37.49	HORIZONTAL	Peak



Highest Channel-Vertical

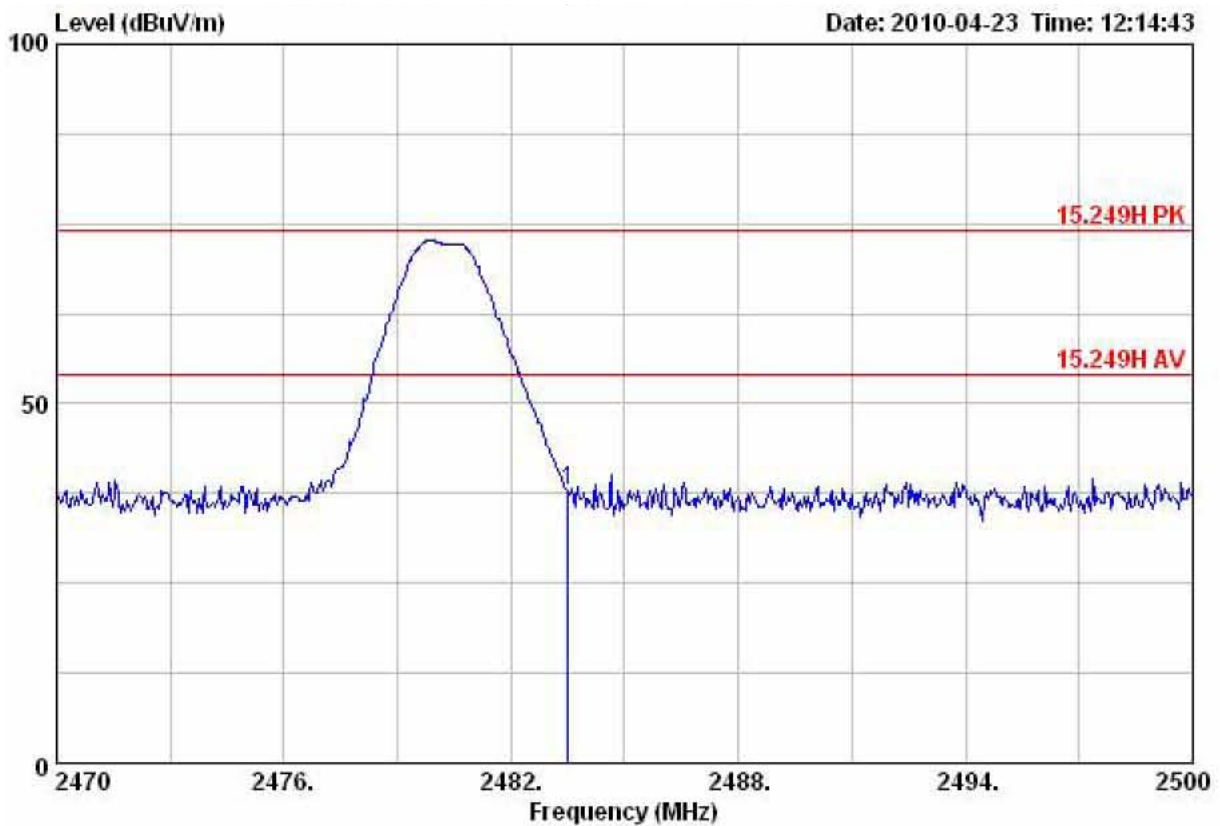

Freq	Read Level	Factor	Level	Limit Line	Over Limit	Pol/Phase	Remark
MHz	dBuV	dB/m	dBuV/m	dBuV/m	dB		
2483.50	43.53	-5.74	37.79	74.00	-36.21	VERTICAL	Peak

Note:

1. Emission level = Reading level + Correction factor
2. Correction factor : Antenna factor, Cable loss, PreAmp, etc.
3. All emissions as described above were determining by rotating the EUT through three orthogonal axes to maximizing the emissions if the EUT belongs to hand-held or body-worn devices.
4. Measurements above 1000 MHz, Peak detector setting: use a 1 MHz RBW, a 3 MHz VBW.
5. Measurements above 1000 MHz, Average detector setting: 1 MHz RBW with 10 Hz VBW.
6. Peak detector measurement data will represent the worst case results.

6. SECTION 15.209 REQUIREMENTS (GENERAL RADIATED EMISSION)

6.1 TEST SETUP

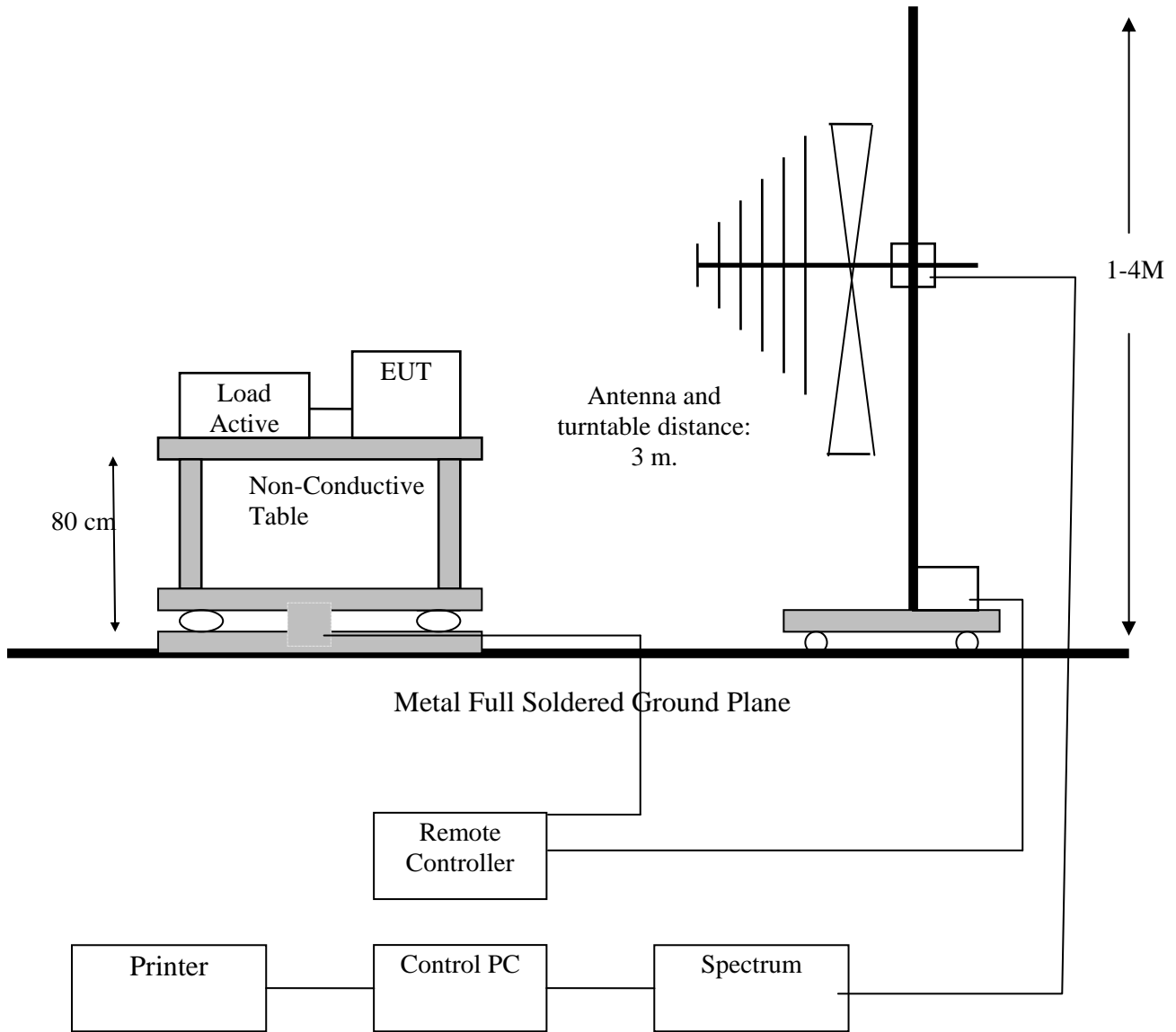



6.2 LIMIT

The field strength of any emissions which appear outside of this band shall not exceed the general radiated emission limits in section 15.209 as below.

Frequency (MHz)	Field Strength (mV/m)	Measurement Distance (m)
1.705-30	30	30
30-88	100*	3
88-216	150*	3
216-960	200*	3
Above 960	500*	3

**Except as provided in paragraph (g), fundamental emissions from intentional radiators operating under this Section shall not be located in the frequency bands 54-72 MHz, 76-88 MHz, 174-216 MHz or 470-806 MHz. However, operation within these frequency bands is permitted under other sections of this Part, e.g., Sections 15.231 and 15.241.*

In the above emission table, the tighter limit applies at the band edges.

Frequency (Hz)	Field Strength (μ V/m at 3-meter)	Field Strength (dB μ V/m at 3-meter)
1.705-30	30 (at 30-meter)	49.5
30-88	100	40
88-216	150	43
216-960	200	46
Above 960	500	54



6.3 TEST PROCEDURE

1. The EUT was placed on a turntable, which was 0.8m above ground plane.
2. The turntable was rotated for 360 degrees to determine the position of maximum emission level.
3. EUT was set at 3m away from the receiving antenna, which was varied from 1m to 4m to find out the highest emissions.
4. Maximum procedure was performed on the six highest emissions to ensure EUT compliance.
5. And also, each emission was maximized by changing the polarization of receiving antenna, both horizontal and vertical.
6. Repeated above procedures until the measurements for all frequencies are completed.

6.4 RESULT: PASSED



6.5 TEST DATA:

All frequencies not described in this test report and within the range of the general radiated emission limits are not detectable significantly. The table as below is representing worst emissions found.

Highest Channel (worst emissions found)

Freq	Read Level	Factor	Level	Limit Line	Over Limit	Pol/Phase	Remark
MHz	dBuV	dB/m	dBuV/m	dBuV/m	dB		
198.47	41.62	-2.20	39.42	43.00	-3.58	HORIZONTAL	Peak
264.57	46.45	-1.63	44.82	46.00	-1.18	HORIZONTAL	Peak
398.57	39.13	2.13	41.26	46.00	-4.74	HORIZONTAL	Peak
530.42	32.83	5.64	38.47	46.00	-7.53	HORIZONTAL	Peak
666.17	25.80	9.02	34.82	46.00	-11.18	HORIZONTAL	Peak
988.22	18.54	16.25	34.79	54.00	-19.21	HORIZONTAL	Peak

Freq	Read Level	Factor	Level	Limit Line	Over Limit	Pol/Phase	Remark
MHz	dBuV	dB/m	dBuV/m	dBuV/m	dB		
159.82	31.93	-3.50	28.43	43.00	-14.57	VERTICAL	Peak
266.82	46.10	-1.39	44.71	46.00	-1.29	VERTICAL	Peak
400.63	37.40	2.18	39.58	46.00	-6.42	VERTICAL	Peak
662.84	29.45	8.97	38.42	46.00	-7.58	VERTICAL	Peak
716.42	26.95	9.87	36.82	46.00	-9.18	VERTICAL	Peak
998.84	17.34	16.50	33.84	54.00	-20.16	VERTICAL	Peak

Note:

1. Emission level = Reading level + Correction factor
2. Correction factor : Antenna factor, Cable loss, PreAmp, etc.
3. All emissions as described above were determining by rotating the EUT through three orthogonal axes to maximizing the emissions if the EUT belongs to hand-held or body-worn devices.
4. Measurements from 9 kHz to 150 kHz, Peak detector setting: 100 Hz RBW
5. Measurements from 150 kHz to 30MHz, Peak detector setting: 10 kHz RBW
6. Measurements from 30 MHz to 1000 MHz, Peak detector setting: 100 kHz RBW
7. Measurements from 9 kHz to 150 kHz, CISPR Quasi-Peak detector: 200 Hz RBW



8. Measurements from 150 kHz to 30MHz, CISPR Quasi-Peak detector: 9 kHz RBW
9. Measurements from 30 MHz to 1000 MHz, CISPR Quasi-Peak detector: 120 kHz RBW
10. Peak detector measurement data will represent the worst case results.

7. SECTION 15.207 REQUIREMENTS (POWERLINE CONDUCTED EMISSIONS)

7.1 TEST SET-UP (PLEASE REFER TO APPENDIX 1)

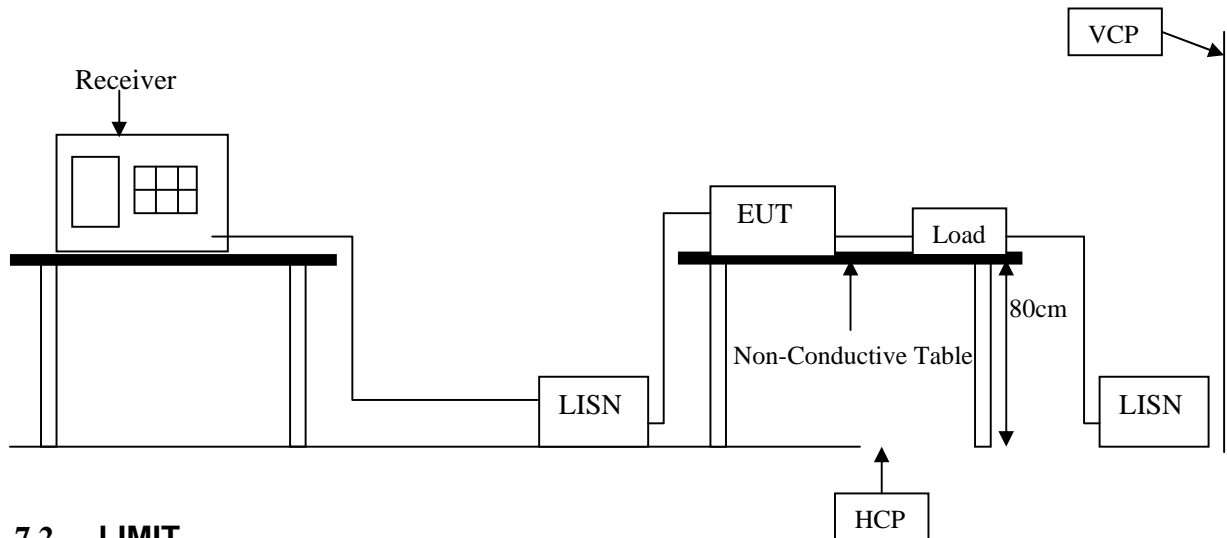

7.2 LIMIT

Frequency range (MHz)	CLASS A		CLASS B	
	QP dB(uV)	Average dB(uV)	QP dB(uV)	Average dB(uV)
0.15-0.5	79 dBuV	66 dBuV	66 - 56 dBuV	56 - 46 dBuV
0.5-5.0	73 dBuV	60 dBuV	56 dBuV	46 dBuV
5.0-30.0	73 dBuV	60 dBuV	60 dBuV	50 dBuV

Remark: In the above table, the tighter limit applies at the band edges.

7.3 TEST PROCEDURE

The EUT and simulators are connected to the main power through a line impedance stabilization network (LISN). It provides a 50 ohm / 50 μ H coupling impedance for the measuring equipment. The peripheral devices are also connected to the main power through a LISN that provides a 50 ohm / 50 μ H coupling impedance with 50 ohm termination. (Please refer to the block diagram of the test setup and photograph.)

Both sides of AC line are checked for the maximum conducted emission interference. In order to find the maximum emissions, the relating positions of equipment and all of the interference cables must be changed according to CISPR22 regulation: The measurement procedure on conducted emission interference.

The resolution bandwidth of the field strength meter is set at 9KHz



7.4 TEST SPECIFICATION

ANSI C63.4 – 2003 Section 5.2, 7.1, 7.2 & CISPR 22 – 2005 CLASS B

7.5 RESULT: PASSED

EMI Receiver/Spectrum Analyzer Configuration (for the frequencies tested)

Frequency Range:	150KHz--30MHz
Detector Function:	Quasi-Peak / Average Mode
Resolution Bandwidth:	9KHz



7.6 TEST DATA:



環球認證有限公司
Global Certification Corp.

Global Certification Corp.
No. 146, Shiang Charng Rd., Sec. 2,
Hsi Chih, Taipei Hsien 221, Taiwan, R.O.C.
TEL: 886-2-26426992 FAX: 886-2-26487450
WebSite: http://www.gcc.tw

Data: 3 File: C:\Documents and Settings\Administrator\桌面\新資料夾\測試數據\CON TEST\040702

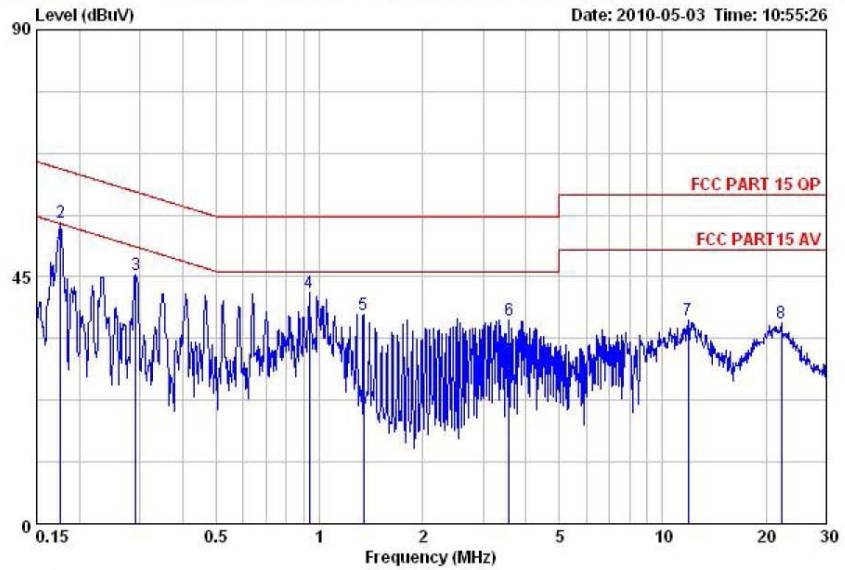

Site : Conducted
 Condition : FCC PART 15 OP NNB41-080924 0310015 LINE
 : RBW:9KHz VBW:300KHz SWT:Auto
 EUT : Please refer to page 1 of report
 MODEL : Please refer to page 1 of report
 MEMO :

	Freq	Read Level	Factor	Level	Limit Line	Over Limit	Remark
	MHz	dBuV	dB	dBuV	dBuV	dB	
1	0.18	39.47	10.15	49.62	54.68	-5.06	Average
2	0.18	44.72	10.15	54.87	64.68	-9.81	Peak
3	0.29	35.29	10.16	45.45	60.46	-15.01	Peak
4	0.93	31.78	10.23	42.01	56.00	-13.99	Peak
5	1.34	27.73	10.26	37.99	56.00	-18.01	Peak
6	3.57	26.83	10.35	37.18	56.00	-18.82	Peak
7	11.87	26.59	10.49	37.08	60.00	-22.92	Peak
8	22.18	25.99	10.53	36.52	60.00	-23.48	Peak



Data: 4 File: C:\Documents and Settings\Administrator\桌面\新資料夾\測試數據\CON TEST\04070

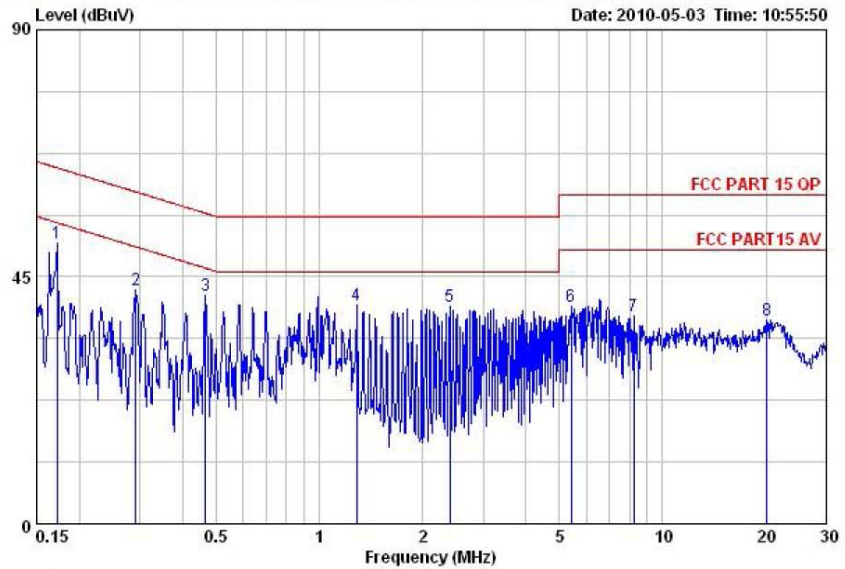

Site : Conducted
 Condition : FCC PART 15 OP NNB41-080924 0310015 NEUTRAL
 : RBW:9KHz VBW:300KHz SWT:Auto
 EUT : Please refer to page 1 of report
 MODEL : Please refer to page 1 of report
 MEMO :

	Freq	Read Level	Factor	Level	Limit Line	Over Limit	Remark
	MHz	dBuV	dB	dBuV	dBuV	dB	
1	0.17	40.93	10.15	51.08	64.86	-13.78	Peak
2	0.29	32.49	10.17	42.66	60.46	-17.80	Peak
3	0.47	31.47	10.19	41.66	56.58	-14.92	Peak
4	1.28	29.64	10.24	39.88	56.00	-16.12	Peak
5	2.40	29.43	10.30	39.73	56.00	-16.27	Peak
6	5.42	29.16	10.38	39.54	60.00	-20.46	Peak
7	8.24	27.41	10.43	37.84	60.00	-22.16	Peak
8	20.16	26.47	10.60	37.07	60.00	-22.93	Peak



Global Certification Corp.

Appendix 1

PHOTOS OF TEST CONFIGURATION

