

REVISION	0
RELEASED FOR SOURCING ONLY	
Quinn 11/23/2009	1

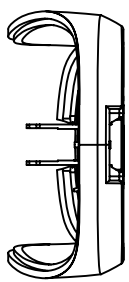

51.48

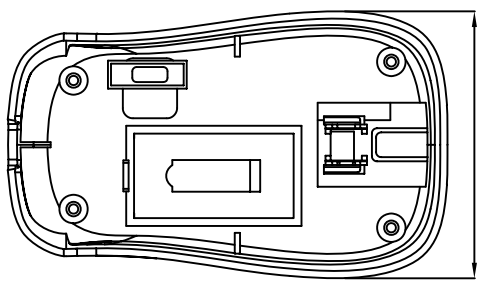

84.82

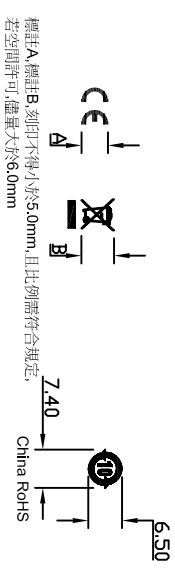
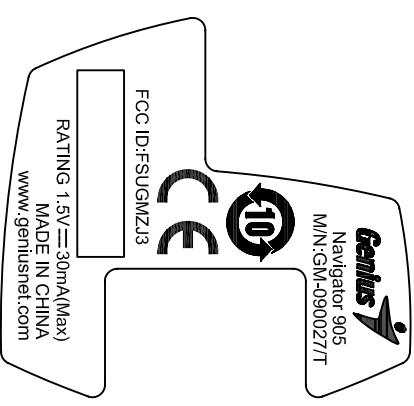
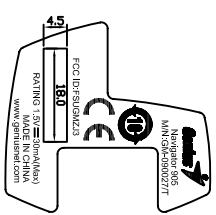
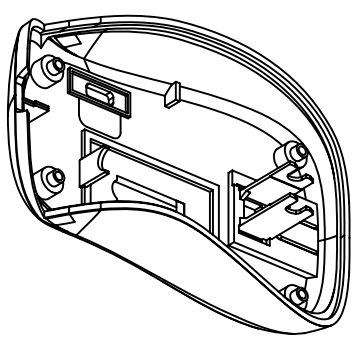
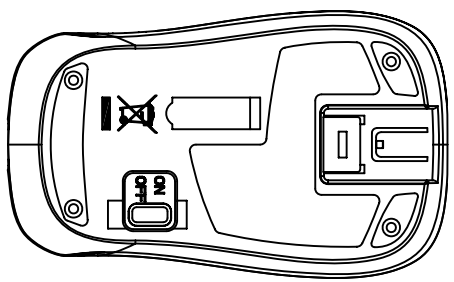
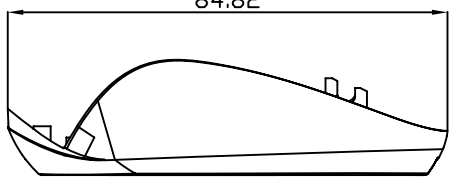

- NOTE:
- TOL: .X±0.25 .XX±0.15 UNLESS SPECIFIED
  - MATERIAL:ABS
  - DRAFT ANGLE: 1.0°/PER SIDE
  - FINISH: TEXTURE MT-11010
  - SHAPE DIMS. FINISHED AS PRD-E 3D MODEL
  - IQC CHECKED DIMENSION  CPK DIMENSION  MAJOR DIMENSION



KYE Systems Corp.

SHEET 1 OF 1 UNLESS OTHERWISE SPECIFIED

TOLERANCES		
LINEAR	INCH	MM ANGLE
XX	±	±
XXX	±	±
XXXX	±	±

PM會簽	電子會簽	EMI會簽	DESCRIPTION:	DWG NO.:
洪嘉玲	吳坤雄	李柯均	TDDLING,NAVIGATOR 905,BOTTOM	15110344101
12/2/2009	12/2/2009	12/2/2009	DRAWN BY:	REV 1
			Quinn 11/23/2009	
			CHECKED BY:	
			APPROVED BY:	

