



**Spectrum Research
& Testing Lab., Inc.**

No. 101-10, Ling 8,
Shan-Tong Li, Chung-Li
City, Taoyuan, Taiwan,
R.O.C.

TEST REPORT

Reference No.:A04060903
Report No.:FCCA04060903
Page:1 of 31
Date:June 16, 2004

Product Name: Wireless K + M
Model No.: KB-3008/T, KB-3008/KB
Applicant: KYE SYSTEMS CORP.
No. 492, Sec. 5, Chung Hsin Rd., San Chung,
Taipei Hsien, 241, Taiwan, R.O.C.
Date of Receipt: June 09, 2004
Finished date of Test: June 16, 2004
Applicable Standards: 47 CFR Part 15, Subpart C
ANSI C63.4:2003

We, **Spectrum Research & Testing Laboratory Inc.**, hereby certify that one sample of the above was tested in our laboratory with positive results according to the above-mentioned standards. The records in the report are an accurate account of the results. Details of the results are given in the subsequent pages of this report.

Checked By : Ken Su for , Date: June 16, 2004
(Sunyou Chen)

Approved By : JH , Date: 6/16/2004
(Johnson Ho, Director)



Table of Contents

1.	DOCUMENT POLICY AND TEST STATEMENT	3
1.1	DOCUMENT POLICY	3
1.2	TEST STATEMENT	3
2.	DESCRIPTION OF EUT AND TEST MODE	4
2.1	GENERAL DESCRIPTION OF EUT	4
2.2	DESCRIPTION OF EUT INTERNAL DEVICE	4
2.3	DESCRIPTION OF TEST MODE	4
2.4	DESCRIPTION OF SUPPORT UNIT	5
3.	DESCRIPTION OF APPLIED STANDARDS	5
4.	CONDUCTED EMISSION TEST	6
4.1	CONDUCTED EMISSION LIMIT	6
4.2	TEST EQUIPMENT	6
4.3	TEST SETUP	7
4.4	TEST PROCEDURE	7
4.5	EUT OPERATING CONDITION	7
4.6	TEST RESULT	8
5.	RADIATED EMISSION TEST	11
5.1	RADIATED EMISSION LIMIT	11
5.2	TEST EQUIPMENT	12
5.3	TEST SET-UP	13
5.4	TEST PROCEDURE	14
5.5	EUT OPERATING CONDITION	14
5.6	RADIATED EMISSION TEST RESULT	15
6.	BAND EDGE	20
6.1	BAND EDGE LIMIT	20
6.2	TEST EQUIPMENT	20
6.3	TEST SET-UP	20
6.4	TEST PROCEDURE	20
6.5	EUT OPERATING CONDITION	20
6.6	BAND EDGE TEST RESULT	21
7.	PHOTOS OF TESTING	23
8.	TERMS OF ABRIVATION	31



**Spectrum Research
& Testing Lab., Inc.**

No. 101-10, Ling 8,
Shan-Tong Li, Chung-Li
City, Taoyuan, Taiwan,
R.O.C.

TEST REPORT

Reference No.:A04060903
Report No.:FCCA04060903
Page:3 of 31
Date:June 16, 2004

1. DOCUMENT POLICY AND TEST STATEMENT

1.1 DOCUMENT POLICY

- The report shall not be reproduced except in full, without the written approval of SRT Lab, Inc.
- The report must not be used by the applicant to claim that the product is endorsed by NVLAP, TÜV, NEMKO and SRT.
- The NVLAP logo applies only to the applicable standards specified in this report.

1.2 TEST STATEMENT

- The test results in the report apply only to the unit tested by SRT Lab.
- There was no deviation from the requirements of test standards during the test.
- AC power source, 120 Vac/60 Hz, was used during the test.



2. DESCRIPTION OF EUT AND TEST MODE

2.1 GENERAL DESCRIPTION OF EUT

PRODUCT	Wireless K + M
MODEL NO.	KB-3008/T, KB-3008/KB
POWER SUPPLY	Keyboard: 1.5Vdc batteriesx2pcs Mouse: 1.5Vdc batteriesx2pcs
CARRIER FREQUENCY	Keyboard: 27.145MHz Mouse: 27.045 MHz
NUMBER OF CHANNEL	2
RATED RF OUTPUT POWER	Keyboard: -7dBm Mouse: -20dBm
I.F. & L.O.	Keyboard: I.F.: 455KHz, L.O.: 26.69MHz Mouse: I.F.: 455KHz, L.O.: 26.59MHz
MODULATION TYPE	FSK
ANTENNA TYPE	Monopole antenna printed on PCB

NOTE :

The product is a wireless mouse which includes transmitter part (TX) and receiver part (RX).

EUT	Model No.
Transmitter part (TX)	KB-3008/T, KB-3008/KB
Receiver part (RX)	KB-3008/R

For more detailed features, please refer to the manufacturer's specification or User's Manual.

2.2 DESCRIPTION OF EUT INTERNAL DEVICE

DEVICE	BRAND / MAKER	MODEL #	FCC ID/DOC	REMARK
N/A				

2.3 DESCRIPTION OF TEST MODE

The EUT was tested for emission measurement under the following situations:

Mode		Remark
1	TX-Keyboard	-
2	Tx-Mouse	-
3	Rx-Link	Without charger box
4	Rx-Link+Charger	There are two batteries in charger box
5	Rx-Link+Charger Only	There is no battery in charger box

**Spectrum Research
& Testing Lab., Inc.**No. 101-10, Ling 8,
Shan-Tong Li, Chung-Li
City, Taoyuan, Taiwan,
R.O.C.**TEST REPORT**Reference No.:A04060903
Report No.:FCCA04060903
Page:5 of 31
Date:June 16, 2004**2.4 DESCRIPTION OF SUPPORT UNIT**

The EUT was configured by the requirement of ANSI C63.4:2003 and CISRP22:2003. All interface ports were connected to the appropriate support units via specific cables. The support units and cables are listed below.

NO	DEVICE	BRAND	MODEL #	FCC ID/DOC	CABLE
1	NOTEBOOK	DELL	PP01L	DOC	1.8m unshielded power cord
2	MODEM	ACEEX	DM-1414	DOC	1.8m unshielded power cord 1.5m shielded data cable
3	PRINTER	EPSON	STYLUS C20SX	DOC	1.5m unshielded power cord 1.5m shielded data cable

NOTE : For the actual test configuration, please refer to the photos of testing.

3. DESCRIPTION OF APPLIED STANDARDS

The EUT is a kind of wireless product and to be connected with a PC system for normal use. According to the specifications provided by the applicant, it must comply with the requirements of the following standards:

47 CFR Part 15, Subpart C

ANSI C63.4:2003

All tests have been performed and recorded as per the above standards.



4. CONDUCTED EMISSION TEST

4.1 CONDUCTED EMISSION LIMIT

FREQUENCY (MHz)	Class A (dB μ V)		Class B (dB μ V)	
	Quasi-peak	Average	Quasi-peak	Average
0.15 - 0.5	79	66	66 - 56	56 - 46
0.5 - 5.0	73	60	56	46
5.0 - 30.0	73	60	60	50

NOTE:

1. The lower limit shall apply at the transition frequencies.
2. The limit decreases in line with the logarithm of the frequency in the range of 0.15 to 0.50 MHz.

4.2 TEST EQUIPMENT

The following test equipment was used for the test:

EQUIPMENT/ FACILITIES	SPECIFICATIONS	MANUFACTURER	MODEL#/ SERIAL#	DUE DATE OF CAL. & CAL. CENTER
EMI TEST RECEIVER	9 kHz TO 2750 MHz	ROHDE & SCHWARZ	ESCS30/ 830245/012	AUG. 2004 ETC
LISN (for EUT)	50 μ H, 50 ohm	SOLAR ELECTRONICS	FCC-LISN-50-25-2 / 01018	NOV. 2004 ETC
LISN (for Peripheral)	50 μ H, 50 ohm	SOLAR ELECTRONICS	9252-50-R-24-BNC / 951318	JUN. 2005 ETC
50 ohm TERMINATOR	50 ohm	HP	11593A/ 2	MAR. 2005 ETC
COAXIAL CABLE	3m	SUNCITY	J400/ 3M	JUL. 2005 SRT
ISOLATION TRANSFORMER	N/A	APC	AFC-11015/ F102040016	N/A
FILTER	2 LINE, 30A	FIL.COIL	FC-943/ 771	N/A
GROUND PLANE	2.3M (H) x 2.4M (W)	SRT	N/A	N/A
GROUND PLANE	2.4M (H) x 2.4M (W)	SRT	N/A	N/A

NOTE: The calibration interval of the above test equipment is one year and the calibrations are traceable to NML/ROC and NIST/USA.



4.3 TEST SETUP

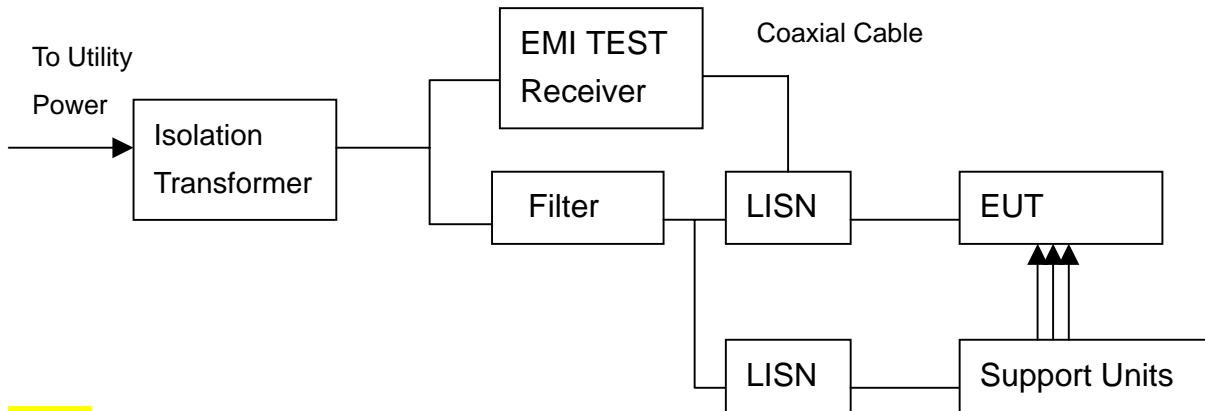

NOTE:

1. The EUT was put on a wooden table with 0.8m heights above ground plane, and 0.4m away from reference ground plane (> 2mx2m).
2. For the actual test configuration, please refer to the photos of testing.
3. The serial no. of the LISN connected to EUT is 951318.
4. The serial no. of the LISN connected to support units is 924839.

4.4 TEST PROCEDURE

The EUT was tested according to the requirement of ANSI C63.4:2003 and CISRP22:2003. The frequency spectrum from 0.15 MHz to 30 MHz was investigated. The LISN used was 50 ohm/50 μ H as specified. All readings were quasi-peak and average values with 10 kHz resolution bandwidth of the test receiver. The EUT system was operated in all typical methods by users. Both lines of the power mains of EUT were measured and the cables connected to EUT and support units were moved to find the maximum emission levels for each frequency. First, find the margin or higher points at least 6 points by software, then use manual to find the maximum data. The procedure is referred on the test procedure of SRT LAB.

4.5 EUT OPERATING CONDITION

1. Set the EUT under transmission condition continuously at specific channel frequency.
2. Under Windows XP run "EMI TEST" and "WORD" programs and PC sent "H" pattern or accessed the following peripherals directly or via EUT:
 - Color Monitor
 - RS232
 - Keyboard
 - EUT (RX)
 - Printer
 - FDD
 - HDD



4.6 TEST RESULT

Temperature:	<u>25°C</u>	Humidity:	<u>53 %RH</u>
Ferquency Range:	<u>0.15 – 30 MHz</u>	Tested Mode:	<u>3(Rx-Link)</u>
Receiver Detector:	<u>Q.P. and AV.</u>	Tested By:	<u>Kevin Liao</u>
		Tested Date:	<u>June 11, 2004</u>

Power Line Measured : Line

Freq. (MHz)	Correct. Factor (dB)	Reading Value (dBμV)		Emission Level (dBμV)		Limit (dBμV)		Margin (dB)	
		Q.P.	AV.	Q.P.	AV.	Q.P.	AV.	Q.P.	AV.
0.177	0.20	48.8	39.5	49.0	39.7	64.6	54.6	-15.6	-14.9
0.183	0.20	46.9	37.4	47.1	37.6	64.3	54.3	-17.2	-16.7
1.153	0.20	35.7	23.8	35.9	24.0	56.0	46.0	-20.1	-22.0
1.240	0.20	33.1	24.5	33.3	24.7	56.0	46.0	-22.7	-21.3
5.558	0.20	31.8	26.5	32.0	26.7	60.0	50.0	-28.0	-23.3
27.782	0.25	24.3	11.5	24.6	11.8	60.0	50.0	-35.4	-38.2

Power Line Measured : Neutral

Freq. (MHz)	Correct. Factor (dB)	Reading Value (dBμV)		Emission Level (dBμV)		Limit (dBμV)		Margin (dB)	
		Q.P.	AV.	Q.P.	AV.	Q.P.	AV.	Q.P.	AV.
0.180	0.20	47.0	38.8	47.2	39.0	64.5	54.5	-17.2	-15.5
0.538	0.20	30.4	27.1	30.6	27.3	56.0	46.0	-25.4	-18.7
3.358	0.20	28.7	25.0	28.9	25.2	56.0	46.0	-27.1	-20.8
5.102	0.20	29.3	25.8	29.5	26.0	60.0	50.0	-30.5	-24.0
5.162	0.20	28.8	26.2	29.0	26.4	60.0	50.0	-31.0	-23.6
25.404	0.21	24.4	19.1	24.6	19.3	60.0	50.0	-35.4	-30.7

NOTE :

1. Measurement uncertainty is +/-1.32dB
2. Emission level = Reading value + Correction factor
3. Correction Factor = Cable loss + Insertion loss of LISN
4. Margin value = Emission level - Limit
5. The emission of other frequencies were very low against the limit.
6. "-": The Quasi-peak reading value also meets average limit and measurement with the average detector is unnecessary.



Temperature:	<u>25°C</u>	Humidity:	<u>53 %RH</u>
Ferquency Range:	<u>0.15 – 30 MHz</u>	Tested Mode:	<u>4(Link+Charger)</u>
Receiver Detector:	<u>Q.P. and AV.</u>	Tested By:	<u>Kevin Liao</u>
		Tested Date:	<u>June 11, 2004</u>

Power Line Measured : Line

Freq. (MHz)	Correct. Factor (dB)	Reading Value (dBμV)		Emission Level (dBμV)		Limit (dBμV)		Margin (dB)	
		Q.P.	AV.	Q.P.	AV.	Q.P.	AV.	Q.P.	AV.
0.180	0.20	48.7	40.9	48.9	41.1	64.5	54.5	-15.6	-13.4
1.182	0.20	31.8	19.0	32.0	19.2	56.0	46.0	-24.0	-26.8
2.576	0.20	29.6	26.2	29.8	26.4	56.0	46.0	-26.2	-19.6
5.213	0.20	28.6	25.2	28.8	25.4	60.0	50.0	-31.2	-24.6
5.274	0.20	28.2	25.5	28.4	25.7	60.0	50.0	-31.6	-24.3
26.378	0.23	26.5	18.0	26.7	18.2	60.0	50.0	-33.3	-31.8

Power Line Measured : Neutral

Freq. (MHz)	Correct. Factor (dB)	Reading Value (dBμV)		Emission Level (dBμV)		Limit (dBμV)		Margin (dB)	
		Q.P.	AV.	Q.P.	AV.	Q.P.	AV.	Q.P.	AV.
0.177	0.20	44.6	36.6	44.8	36.8	64.6	54.6	-19.8	-17.8
0.538	0.20	28.8	24.5	29.0	24.7	56.0	46.0	-27.0	-21.3
3.665	0.20	34.6	28.1	34.8	28.3	56.0	46.0	-21.2	-17.7
5.284	0.20	27.3	22.5	27.5	22.7	60.0	50.0	-32.5	-27.3
5.345	0.20	27.7	23.6	27.9	23.8	60.0	50.0	-32.1	-26.2
27.843	0.26	19.3	18.6	19.6	18.8	60.0	50.0	-40.4	-31.2

NOTE :

1. Measurement uncertainty is +/-1.32dB
2. Emission level = Reading value + Correction factor
3. Correction Factor = Cable loss + Insertion loss of LISN
4. Margin value = Emission level - Limit
5. The emission of other frequencies were very low against the limit.
6. "-": The Quasi-peak reading value also meets average limit and measurement with the average detector is unnecessary.



Temperature:	<u>25°C</u>	Humidity:	<u>53 %RH</u>
Ferquency Range:	<u>0.15 – 30 MHz</u>	Tested Mode:	<u>5(Link+Charger Only)</u>
Receiver Detector:	<u>Q.P. and AV.</u>	Tested By:	<u>Kevin Liao</u>
		Tested Date:	<u>June 11, 2004</u>

Power Line Measured : Line

Freq. (MHz)	Correct. Factor (dB)	Reading Value (dB μ V)		Emission Level (dB μ V)		Limit (dB μ V)		Margin (dB)	
		Q.P.	AV.	Q.P.	AV.	Q.P.	AV.	Q.P.	AV.
0.177	0.20	49.6	41.0	49.8	41.2	64.6	54.6	-14.8	-13.4
0.654	0.20	27.9	25.7	28.1	25.9	56.0	46.0	-27.9	-20.1
2.794	0.20	29.1	26.3	29.3	26.5	56.0	46.0	-26.7	-19.5
3.210	0.20	28.7	25.6	28.9	25.8	56.0	46.0	-27.1	-20.3
5.650	0.20	26.6	23.1	26.8	23.3	60.0	50.0	-33.2	-26.7
26.993	0.24	27.5	19.9	27.8	20.1	60.0	50.0	-32.2	-29.9

Power Line Measured : Neutral

Freq. (MHz)	Correct. Factor (dB)	Reading Value (dB μ V)		Emission Level (dB μ V)		Limit (dB μ V)		Margin (dB)	
		Q.P.	AV.	Q.P.	AV.	Q.P.	AV.	Q.P.	AV.
0.180	0.20	48.1	40.0	48.3	40.2	64.5	54.5	-16.1	-14.3
0.538	0.20	29.6	25.6	29.8	25.8	56.0	46.0	-26.2	-20.2
3.338	0.20	32.6	27.0	32.8	27.2	56.0	46.0	-23.2	-18.8
5.244	0.20	27.0	22.7	27.2	22.9	60.0	50.0	-32.8	-27.2
5.305	0.20	27.6	23.9	27.8	24.1	60.0	50.0	-32.2	-25.9
28.202	0.26	27.8	19.1	28.0	19.3	60.0	50.0	-32.0	-30.7

NOTE :

1. Measurement uncertainty is +/-1.32dB
2. Emission level = Reading value + Correction factor
3. Correction Factor = Cable loss + Insertion loss of LISN
4. Margin value = Emission level - Limit
5. The emission of other frequencies were very low against the limit.
6. "-": The Quasi-peak reading value also meets average limit and measurement with the average detector is unnecessary.



5. RADIATED EMISSION TEST

5.1 RADIATED EMISSION LIMIT

FCC Part 15, Subpart C Section 15.227.

FREQUENCY (MHz)	DISTANCE (m)	FIELD STRENGTH (dB μ V/m)	
		PEAK	AVERAGE
26.96 - 27.28	3	100.0	80.0

FCC Part 15, Subpart B Section 15.209.

FREQUENCY (MHz)	DISTANCE (m)	FIELD STRENGTH (dB μ V/m)
30 - 88	3	40.0
88 - 216	3	43.5
216 - 960	3	46.0
Above 960	3	54.0

NOTE :

1. In the emission tables above , the tighter limit applies at the band edges.
2. Distance refers to the distance between measuring instrument, antenna, and the closest point of any part of the device or system.

CISPR 22:2003 limits of radiated emission measurement for frequency below 1000 MHz

FREQUENCY (MHz)	Class A (at 10m)	Class B (at 10m)
	dB μ V/m	dB μ V/m
30 – 230	40	30
230 - 1000	47	37

NOTE:

1. The lower limit shall apply at the transition frequencies.
2. Emission level (dB μ V/m) = 20 log Emission level (μ V/m).



5.2 TEST EQUIPMENT

The following test equipment was used during the radiated emission test:

EQUIPMENT/ FACILITIES	SPECIFICATIONS	MANUFACTURER	MODEL#/ SERIAL#	DUE DATE OF CAL. & CAL. CENTER
EMI TEST RECEIVER	20 MHz TO 1000 MHz	ROHDE & SCHWARZ	ESVS30/ 841977/003	AUG. 2004 ETC
BI-LOG ANTENNA	25 MHz TO 2 GHz	EMCO	3142/ 9701-1124	APR. 2005 SRT
DIPOLE ANTENNA	30 MHz TO 1 GHz	EMCO	3121C/ 9611-1239	MAR. 2005 ETC
SPECTRUM ANALYZER	9 KHz TO 26.5 GHz	HP	8593E/ 3710A03220	MAY 2005 ETC
PRE-AMPLIFIER	1 GHz TO 26.5 GHz	HP	8449B/ 3008A01019	DEC. 2004 ETC
HORN ANTENNA	1 GHz TO 18 GHz	EMCO	3115/ 9602-4681	NOV. 2004 ETC
OATS	3 – 10 M MEASUREMENT	SRT	SRT-1	APR. 2005 SRT
COAXIAL CABLE	25M	SUNCITY	J400/ 25M	AUG. 2004 SRT
FILTER	2 LINE, 30A	FIL.COIL	FC-943/ 869	N/A
FREQUENCY CONVERTER	N/A	APC	AFC-2KBB/ F100030031	AUG. 2004 SRT

NOTE:

1. The calibration interval of the above test equipment is one year and the calibrations are traceable to NML/ROC and NIST/USA.
2. The Open Area Test Site (SRT-1) is registered by FCC with No. 90957 and VCCI with No. R-1081.
3. The Open Area Test Site (SRT-2) is registered by FCC with No. 98458 and VCCI with No. R-1168.



5.3 TEST SET-UP

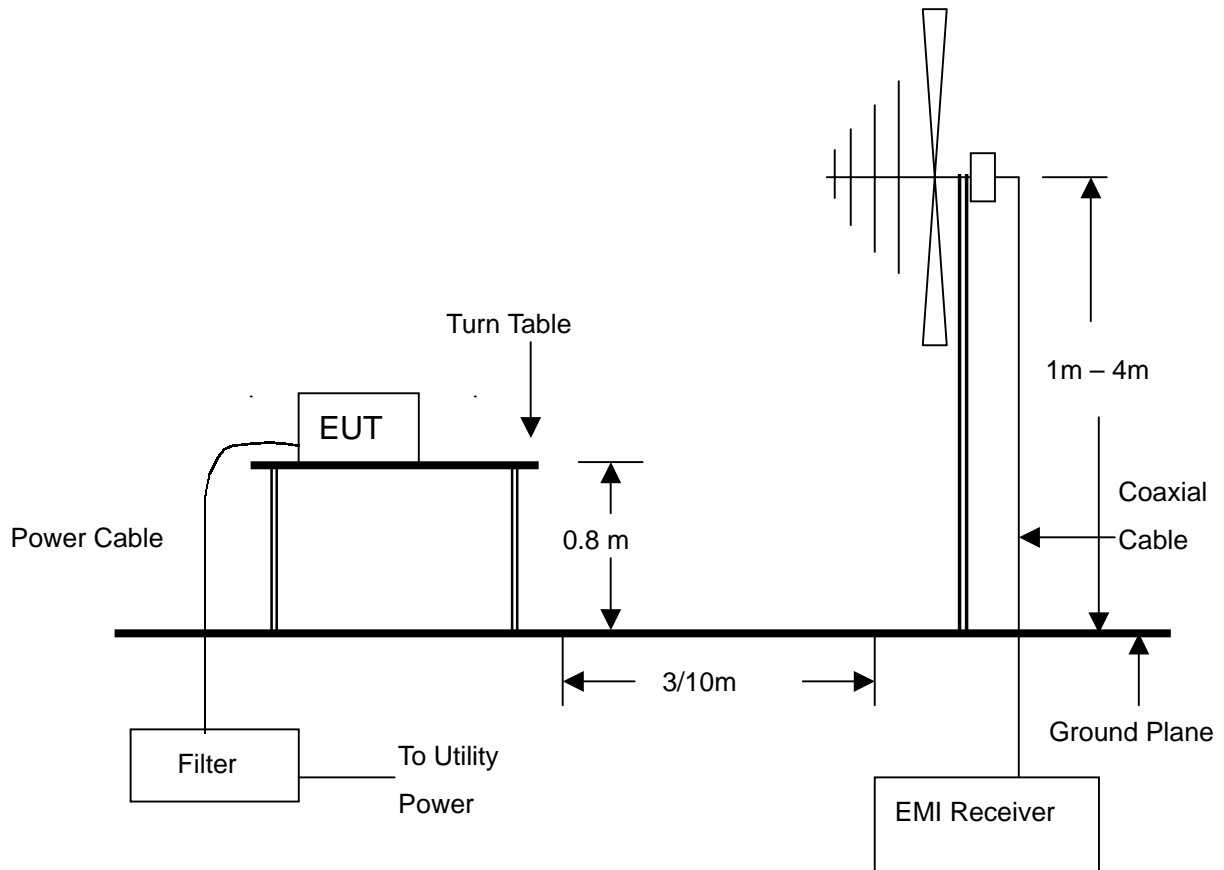

NOTE :

1. The EUT system was put on a wooden table with 0.8m heights above a ground plane.
2. For the actual test configuration, please refer to the photos of testing.



5.4 TEST PROCEDURE

The EUT was tested according to the requirement of ANSI C63.4:2003 and CISPR 22:2003. The measurements were made at an open area test site with 10 meter measurement distance under 1 GHz and with 3m distance above 1GHz. The frequency spectrum measured started from 30 MHz. Under 1 GHz, all readings were quasi-peak values with 120 kHz resolution bandwidth of the test receiver. Above 1 GHz, the measurements were made at an open area test site with 3 meter measurement distance and all readings were peak or average values with 1 MHz resolution bandwidth of the test receiver. The EUT system was operated in all typical methods by users. The cables connected to EUT and support units were moved to find the maximum emission levels for each frequency. First, find the margin or higher points at least 6 points by software, then use manual to find the maximum data. The procedure is referred on the test procedure of SRT LAB.

5.5 EUT OPERATING CONDITION

Same as section 4.5 of this report.



5.6 RADIATED EMISSION TEST RESULT

Temperature:	26°C	Humidity:	59 %RH
Ferquency Range:	30 - 1000 MHz	Measured Distance:	3m
Receiver Detector:		Tested Mode:	1(TX-Keyboard)
Fundamental frequency:	AV.	Tested By:	Kevin Liao
Harmonics:	Q.P.	Tested Date:	June 16, 2004

Fundamental frequency of transmitter

Frequency (MHz)	Antenna Polarization	Cable Loss (dB)	Antenna Factor (dB/m)	Reading Data (dBμV)	Emission Level (dBμV/m)	Limit (dBμV/m)	Margin (dB)
27.145(F)	H	0.61	17.30	40.6	58.5	40.0	18.5
27.145(F)	V	0.61	17.30	34.0	51.9	40.0	11.9

Antenna Polarization:Horizontal

Frequency (MHz)	Cable Loss (dB)	Antenna Factor (dB/m)	Reading Data (dBμV)	Emission Level (dBμV/m)	Limit (dBμV/m)	Margin (dB)	AZ(°)	EL(m)
54.283	0.79	7.80	24.6	33.2	40.0	-6.8	167.3	3.41
81.4238	1.05	6.24	19.2	26.5	40.0	-13.5	186.4	3.70
108.5652	1.12	6.68	19.8	27.6	43.5	-15.9	152.1	2.66
135.7076	1.22	7.35	12.5	21.1	43.5	-22.4	236.9	3.70
162.8488	1.38	9.00	3.6	14.0	43.5	-29.4	96.5	2.70
190.0023	1.49	10.40	19.3	31.2	43.5	-12.3	135.2	3.12

Antenna Polarization:Vertical

Frequency (MHz)	Cable Loss (dB)	Antenna Factor (dB/m)	Reading Data (dBμV)	Emission Level (dBμV/m)	Limit (dBμV/m)	Margin (dB)	AZ(°)	EL(m)
54.283	0.79	7.80	21.2	29.8	40.0	-10.2	85.1	2.06
81.4238	1.05	6.24	14.5	21.8	40.0	-18.2	221.0	1.00
108.5652	1.12	6.68	21.2	29.0	43.5	-14.5	192.4	1.00
135.7076	1.22	7.35	11.6	20.2	43.5	-23.3	132.7	1.28
162.8488	1.38	9.00	5.9	16.3	43.5	-27.2	216.3	1.06
190.0023	1.49	10.40	12.7	24.6	43.5	-18.9	332.5	1.68

NOTE :

1. Measurement uncertainty is less than +/- 2dB
2. "*": Measurement does not apply for this frequency.
3. Emission Level = Reading Value + Ant. Factor + Cable Loss
4. The field strength of other emission frequencies were very low against the limit.
5. (F) : Fundamental frequency of transmitter.



Temperature:	26°C	Humidity:	59 %RH
Frequency Range:	30 - 1000 MHz	Measured Distance:	3m
Receiver Detector:		Tested Mode:	2(TX-Mouse)
Fundamental frequency:	AV.	Tested By:	Kevin Liao
Harmonics:	Q.P.	Tested Date:	June 16, 2004

Fundamental frequency of transmitter

Frequency (MHz)	Antenna Polarization	Cable Loss (dB)	Antenna Factor (dB/m)	Reading Data (dBμV)	Emission Level (dBμV/m)	Limit (dBμV/m)	Margin (dB)
27.045(F)	H	0.61	17.30	31.2	49.1	80.0	-30.9
27.045(F)	V	0.61	17.30	30.6	48.5	80.0	-31.5

Antenna Polarization:Horizontal

Frequency (MHz)	Cable Loss (dB)	Antenna Factor (dB/m)	Reading Data (dBμV)	Emission Level (dBμV/m)	Limit (dBμV/m)	Margin (dB)	AZ(°)	EL(m)
54.183	0.79	7.80	15.5	24.1	40.0	-15.9	167.3	3.41
134.627	1.21	7.36	11.7	20.3	43.5	-23.2	186.4	3.70
161.982	1.38	9.05	7.2	17.6	43.5	-25.9	152.1	2.66
243.075	1.72	11.15	8.6	21.5	46.0	-24.5	236.9	3.70
270.422	1.81	13.50	8.2	23.5	46.0	-22.5	96.5	2.50
324.704	2.02	15.02	10.5	27.5	46.0	-18.5	97.5	1.64

Antenna Polarization:Vertical

Frequency (MHz)	Cable Loss (dB)	Antenna Factor (dB/m)	Reading Data (dBμV)	Emission Level (dBμV/m)	Limit (dBμV/m)	Margin (dB)	AZ(°)	EL(m)
54.183	0.79	7.80	23.5	32.1	40.0	-7.9	85.1	2.06
134.627	1.21	7.36	12.2	20.8	43.5	-22.7	221.0	1.65
153.043	1.33	9.52	10.5	21.3	43.5	-22.2	54.4	2.50
216.318	1.60	10.26	13.4	25.3	46.0	-20.7	67.5	2.10
379.168	2.22	15.84	8.5	26.6	46.0	-19.4	34.53	1.50
485.824	2.62	19.92	9.4	31.9	46.0	-14.1	195.4	1.62

NOTE :

1. Measurement uncertainty is less than +/- 2dB
2. "": Measurement does not apply for this frequency.
3. Emission Level = Reading Value + Ant. Factor + Cable Loss
4. The field strength of other emission frequencies were very low against the limit.
5. (F) : Fundamental frequency of transmitter.



Temperature:	26°C	Humidity:	59 %RH
Frequency Range:	30 – 1000 MHz	Measured Distance:	3m
Receiver Detector:	Q.P.	Tested Mode:	3(Rx-Link)
Tested Date:	June 16, 2004	Tested By:	Kevin Liao

Antenna Polarization:Horizontal

Frequency (MHz)	Cable Loss (dB)	Antenna Factor (dB/m)	Reading Data (dBµV)	Emission Level (dBµV/m)	Limit (dBµV/m)	Margin (dB)	AZ(°)	EL(m)
51.1370	0.76	8.40	11.9	21.1	40.0	-18.9	199.4	4.00
110.6750	1.13	6.40	24.6	32.1	43.5	-11.4	93.7	3.83
134.6260	1.21	7.36	26.1	34.7	43.5	-8.8	342.4	4.00
217.0180	1.60	10.27	21.3	33.2	46.0	-12.8	181.6	3.26
533.4475	2.79	19.98	16.9	39.7	46.0	-6.3	98.3	2.67
664.2720	3.11	21.24	15.9	40.2	46.0	-5.8	245.9	2.94

Antenna Polarization:Vertical

Frequency (MHz)	Cable Loss (dB)	Antenna Factor (dB/m)	Reading Data (dBµV)	Emission Level (dBµV/m)	Limit (dBµV/m)	Margin (dB)	AZ(°)	EL(m)
51.1370	0.76	8.40	24.6	33.8	40.0	-6.2	81.7	1.00
110.6750	1.13	6.40	26.0	33.5	43.5	-10.0	128.9	1.29
134.6270	1.21	7.36	24.1	32.7	43.5	-10.8	254.3	1.00
217.0180	1.60	10.27	20.8	32.7	46.0	-13.3	318.4	1.46
400.3480	2.29	15.80	21.4	39.5	46.0	-6.5	193.1	1.83
533.4475	2.79	19.98	14.7	37.5	46.0	-8.5	62.3	1.94

NOTE :

1. Measurement uncertainty is +/-2dB.
2. "**": Measurement does not apply for this frequency.
3. Emission Level = Reading Value + Ant. Factor + Cable Loss.
4. The field strength of other emission frequencies were very low against the limit.



Temperature:	26°C	Humidity:	59 %RH
Frequency Range:	30 – 1000 MHz	Measured Distance:	3m
Receiver Detector:	Q.P.	Tested Mode:	4(Rx-Link+Charger)
Tested Date:	June 16, 2004	Tested By:	Kevin Liao

Antenna Polarization:Horizontal

Frequency (MHz)	Cable Loss (dB)	Antenna Factor (dB/m)	Reading Data (dBμV)	Emission Level (dBμV/m)	Limit (dBμV/m)	Margin (dB)	AZ(°)	EL(m)
51.1370	0.76	8.40	12.6	21.8	40.0	-18.2	173.4	3.69
110.6750	1.13	6.40	27.9	35.4	43.5	-8.1	128.7	3.92
217.0180	1.60	10.27	24.2	36.1	46.0	-9.9	305.4	3.44
533.4475	2.79	19.98	17.4	40.2	46.0	-5.8	211.7	2.93
625.4370	3.00	20.90	15.6	39.5	46.0	-6.5	68.8	2.84
664.2720	3.11	21.24	14.3	38.6	46.0	-7.4	312.8	2.96

Antenna Polarization:Vertical

Frequency (MHz)	Cable Loss (dB)	Antenna Factor (dB/m)	Reading Data (dBμV)	Emission Level (dBμV/m)	Limit (dBμV/m)	Margin (dB)	AZ(°)	EL(m)
110.6750	1.13	6.40	26.0	33.5	43.5	-10.0	93.7	1.16
134.6270	1.21	7.36	25.1	33.7	43.5	-9.8	148.9	1.00
217.0180	1.60	10.27	23.7	35.6	46.0	-10.4	288.4	1.63
397.5490	2.28	15.81	19.4	37.5	46.0	-8.5	273.6	1.00
533.4475	2.79	19.98	13.5	36.3	46.0	-9.7	103.5	1.78
664.2710	3.11	21.24	10.6	34.9	46.0	-11.1	88.3	1.54

NOTE :

1. Measurement uncertainty is +/-2dB.
2. "": Measurement does not apply for this frequency.
3. Emission Level = Reading Value + Ant. Factor + Cable Loss.
4. The field strength of other emission frequencies were very low against the limit.



Temperature:	<u>26°C</u>	Humidity:	<u>59 %RH</u>
Frequency Range:	<u>30 – 1000 MHz</u>	Measured Distance:	<u>3m</u>
Receiver Detector:	<u>Q.P.</u>	Tested Mode:	<u>5(Rx-Link+Charger Only)</u>
Tested Date:	<u>June 16, 2004</u>	Tested By:	<u>Kevin Liao</u>

Antenna Polarization:Horizontal

Frequency (MHz)	Cable Loss (dB)	Antenna Factor (dB/m)	Reading Data (dBμV)	Emission Level (dBμV/m)	Limit (dBμV/m)	Margin (dB)	AZ(°)	EL(m)
51.1370	0.76	8.40	12.6	21.8	40.0	-18.2	172.9	3.61
110.6750	1.13	6.40	21.4	28.9	43.5	-14.6	137.6	4.00
217.0180	1.60	10.27	22.3	34.2	46.0	-11.8	205.4	3.42
453.7630	2.52	16.98	16.7	36.2	46.0	-9.8	311.7	3.71
533.4475	2.79	19.98	17.1	39.9	46.0	-6.1	93.4	2.94
664.2720	3.11	21.24	15.4	39.7	46.0	-6.3	342.8	2.88

Antenna Polarization:Vertical

Frequency (MHz)	Cable Loss (dB)	Antenna Factor (dB/m)	Reading Data (dBμV)	Emission Level (dBμV/m)	Limit (dBμV/m)	Margin (dB)	AZ(°)	EL(m)
110.6750	1.13	6.40	25.9	33.4	43.5	-10.1	69.1	1.16
134.6270	1.21	7.36	26.7	35.3	43.5	-8.2	118.7	1.42
217.0180	1.60	10.27	21.1	33.0	46.0	-13.0	328.9	1.29
400.3480	2.29	15.80	16.8	34.9	46.0	-11.1	283.6	1.57
533.4475	2.79	19.98	17.1	39.9	46.0	-6.1	88.4	1.33
664.2710	3.11	21.24	11.6	35.9	46.0	-10.1	59.7	1.72

NOTE :

1. Measurement uncertainty is +/-2dB.
2. "": Measurement does not apply for this frequency.
3. Emission Level = Reading Value + Ant. Factor + Cable Loss.
4. The field strength of other emission frequencies were very low against the limit.



6. BAND EDGE

6.1 BAND EDGE LIMIT

The limit is less than 26dB with respect to the amplitude of fundamental frequency.

6.2 TEST EQUIPMENT

The following test equipment was used during the radiated emission test:

EQUIPMENT/ FACILITIES	SPECIFICATIONS	MANUFACTURER	MODEL#/ SERIAL#	DUE DATE OF CAL. & CAL. CENTER
SPECTRUM	9 kHz TO 7GHz	ROHDE & SCHWARZ	FSP7/ 839511/010	MAR. 2005 R&S

NOTE:

The calibration interval of the above test equipment is one year and the calibrations are traceable to NML/ROC and NIST/USA.

6.3 TEST SET-UP

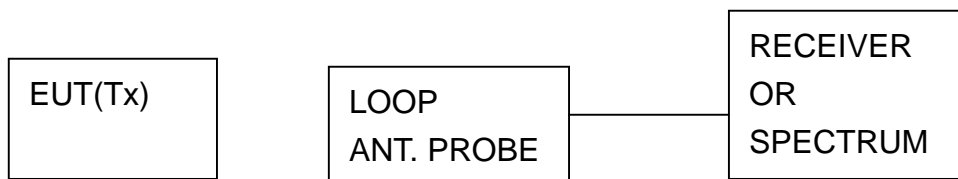

6.4 TEST PROCEDURE

A specific loop antenna was connected to receiver to detect the EUT's power level. The Receiver displayed the EUT's power level and printed out the plot of measurement.

6.5 EUT OPERATING CONDITION

Set the EUT under transmission condition continuously at specific channel frequency.



6.6 BAND EDGE TEST RESULT

Temperature:	<u>26 °C</u>	Humidity:	<u>63 %RH</u>
Receiver Detector:	<u>Peak</u>	Tested Mode:	<u>TX(Keyboard)</u>
Tested Result:	<u>Pass</u>	Tested By:	<u>Kevin Liao</u>

FREQUENCY (MHZ)	RF LEVEL 10kHz BW (dBm)	LIMIT (dBm)	MARGIN (dB)
26.91	-57.99	-33.37	-24.62
27.31	-54.51	-33.37	-21.14

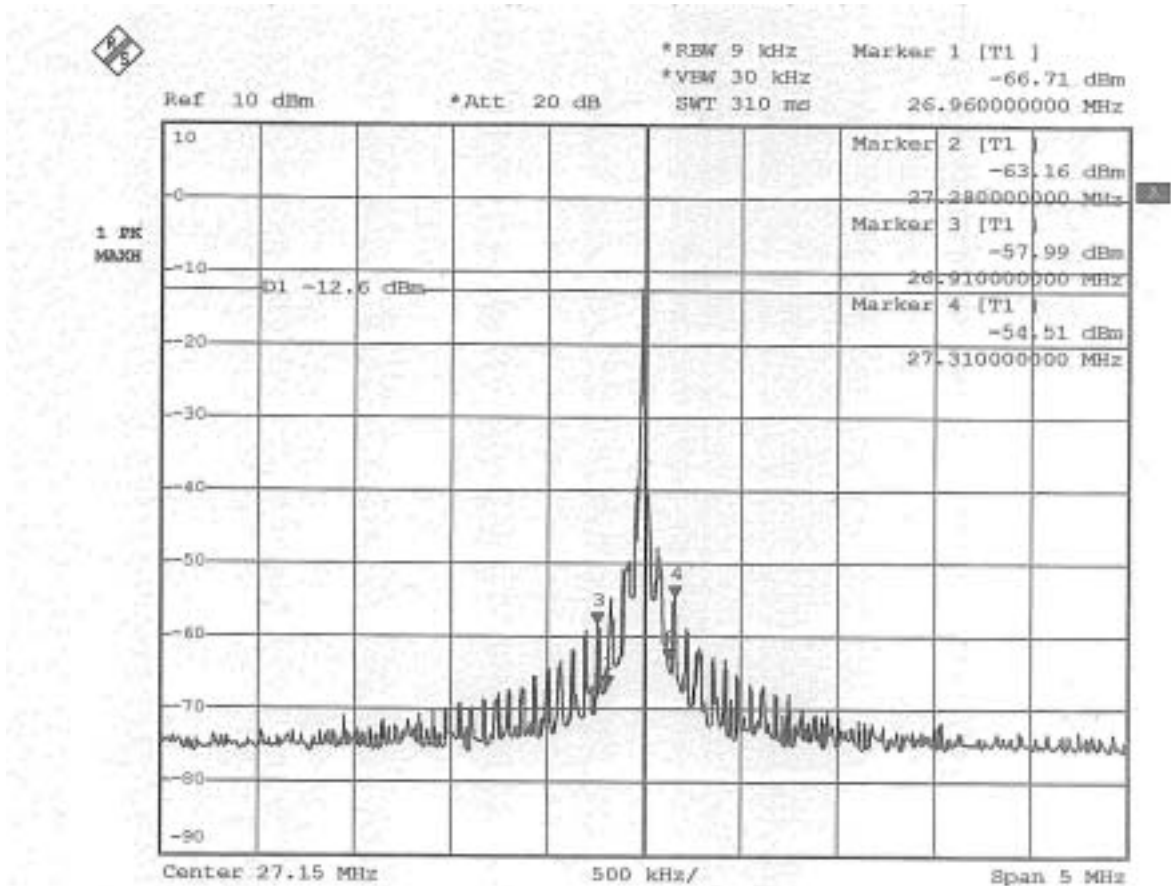

Date: 27.JUL.2004 10:15:12

Bandedge KB-3008 KIB

Kevin



Spectrum Research & Testing Lab., Inc.
 No. 101-10, Ling 8,
 Shan-Tong Li, Chung-Li
 City, Taoyuan, Taiwan,
 R.O.C.

TEST REPORT

Reference No.:A04060903
 Report No.:FCCA04060903
 Page:22 of 31
 Date:June 16, 2004

Temperature:	<u>25 °C</u>	Humidity:	<u>53 %RH</u>
Receiver Detector:	<u>Peak</u>	Tested Mode:	<u>TX(Mouse)</u>
Tested Result:	<u>Pass</u>	Tested By:	<u>Kevin Liao</u>

FREQUENCY (MHZ)	RF LEVEL 10kHz BW (dBm)	LIMIT (dBm)	MARGIN (dB)
27.28	-50.28	-33.37	-16.91
28.49	-53.68	-33.37	-20.31

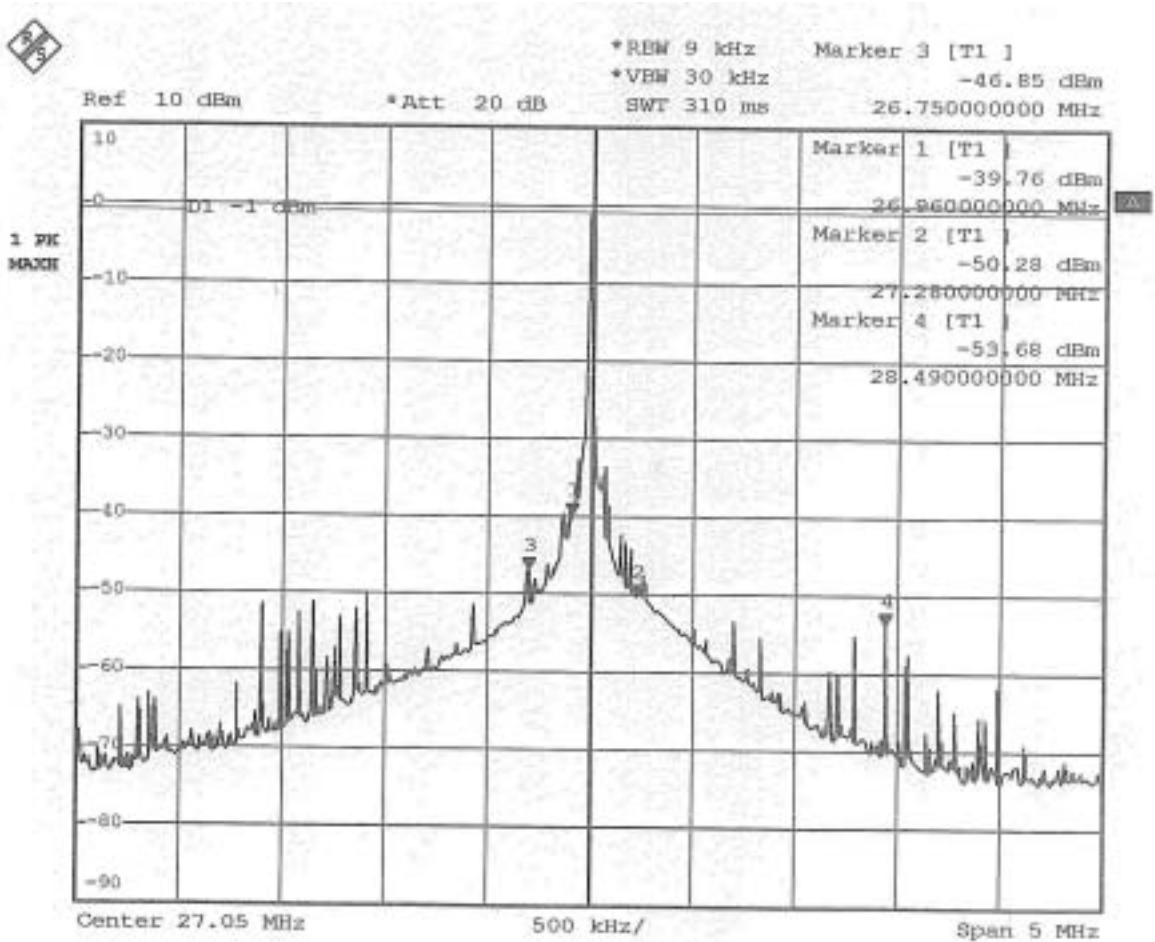

Date: 27.JUL.2004 10:04:00

Bandedge
 KB-3008 M/S

Kevin.



7. PHOTOS OF TESTING
- Conducted test (Mode 3: Rx-Link)





**Spectrum Research
& Testing Lab., Inc.**

No. 101-10, Ling 8,
Shan-Tong Li, Chung-Li
City, Taoyuan, Taiwan,
R.O.C.

TEST REPORT

Reference No.:A04060903
Report No.:FCCA04060903
Page:24 of 31
Date:June 16, 2004

- Conducted test (Mode 4: Rx-Link+Charger)



FCC ID: FSUGMZGX (Mouse)
FSUGKZGM(Keyboard)



**Spectrum Research
& Testing Lab., Inc.**

No. 101-10, Ling 8,
Shan-Tong Li, Chung-Li
City, Taoyuan, Taiwan,
R.O.C.

TEST REPORT

Reference No.:A04060903
Report No.:FCCA04060903
Page:25 of 31
Date:June 16, 2004

- Conducted test (Mode 5: Rx-Link+Charger Only)



FCC ID: FSUGMZGX (Mouse)
FSUGKZGM(Keyboard)



**Spectrum Research
& Testing Lab., Inc.**

No. 101-10, Ling 8,
Shan-Tong Li, Chung-Li
City, Taoyuan, Taiwan,
R.O.C.

TEST REPORT

Reference No.:A04060903

Report No.:FCCA04060903

Page:26 of 31

Date:June 16, 2004

- Radiated test (Mode 1: TX-Keyboard)

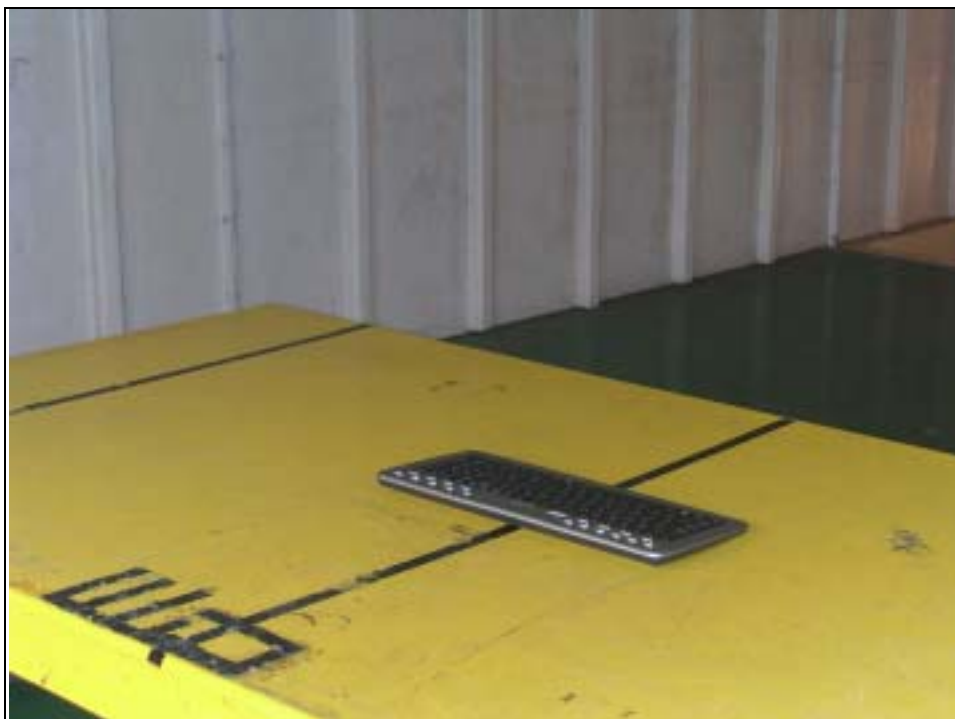

FCC ID: FSUGMZGX (Mouse)
FSUGKZGM(Keyboard)



**Spectrum Research
& Testing Lab., Inc.**

No. 101-10, Ling 8,
Shan-Tong Li, Chung-Li
City, Taoyuan, Taiwan,
R.O.C.

TEST REPORT

Reference No.:A04060903

Report No.:FCCA04060903

Page:27 of 31

Date:June 16, 2004

- Radiated test (Mode 2: TX-Mouse)

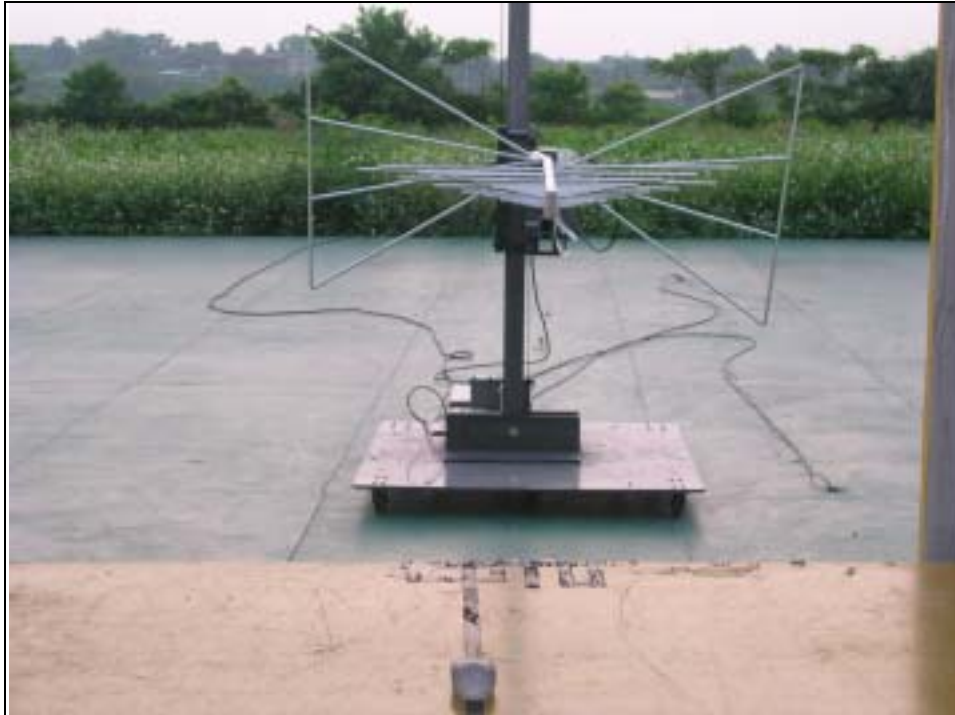

FCC ID: FSUGMZGX (Mouse)
FSUGKZGM(Keyboard)



- Radiated test (Mode 3: Rx-Link)





**Spectrum Research
& Testing Lab., Inc.**

No. 101-10, Ling 8,
Shan-Tong Li, Chung-Li
City, Taoyuan, Taiwan,
R.O.C.

TEST REPORT

Reference No.:A04060903

Report No.:FCCA04060903

Page:29 of 31

Date:June 16, 2004

- Radiated test (Mode 4: Rx-Link+Charger)

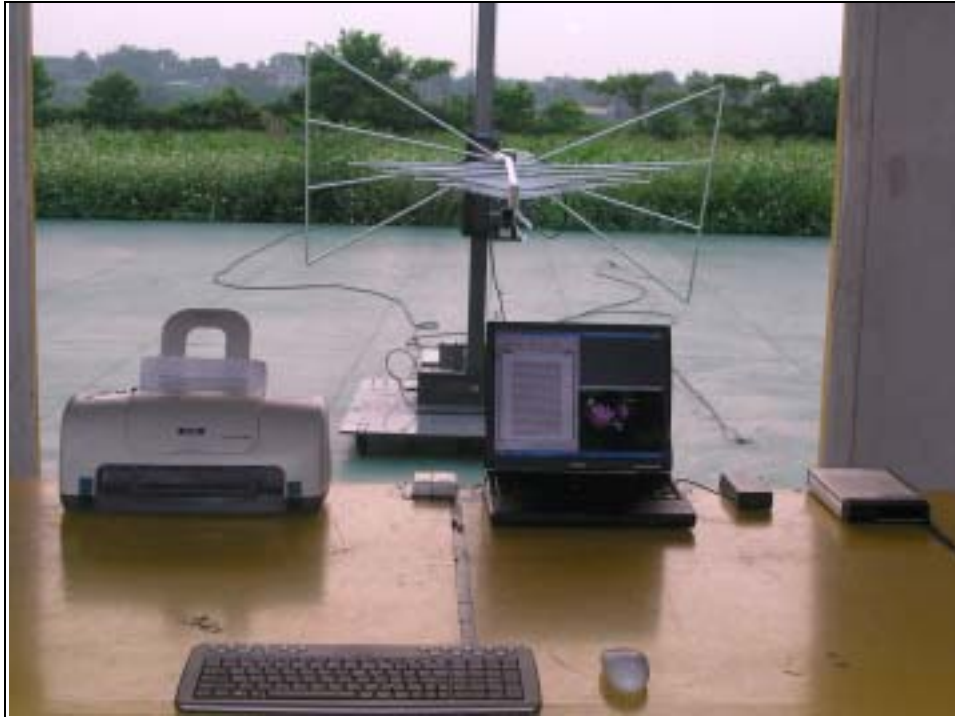

FCC ID: FSUGMZGX (Mouse)
FSUGKZGM(Keyboard)



**Spectrum Research
& Testing Lab., Inc.**

No. 101-10, Ling 8,
Shan-Tong Li, Chung-Li
City, Taoyuan, Taiwan,
R.O.C.

TEST REPORT

Reference No.:A04060903

Report No.:FCCA04060903

Page:30 of 31

Date:June 16, 2004

- Radiated test (Mode 5: Rx-Link+Charger Only)

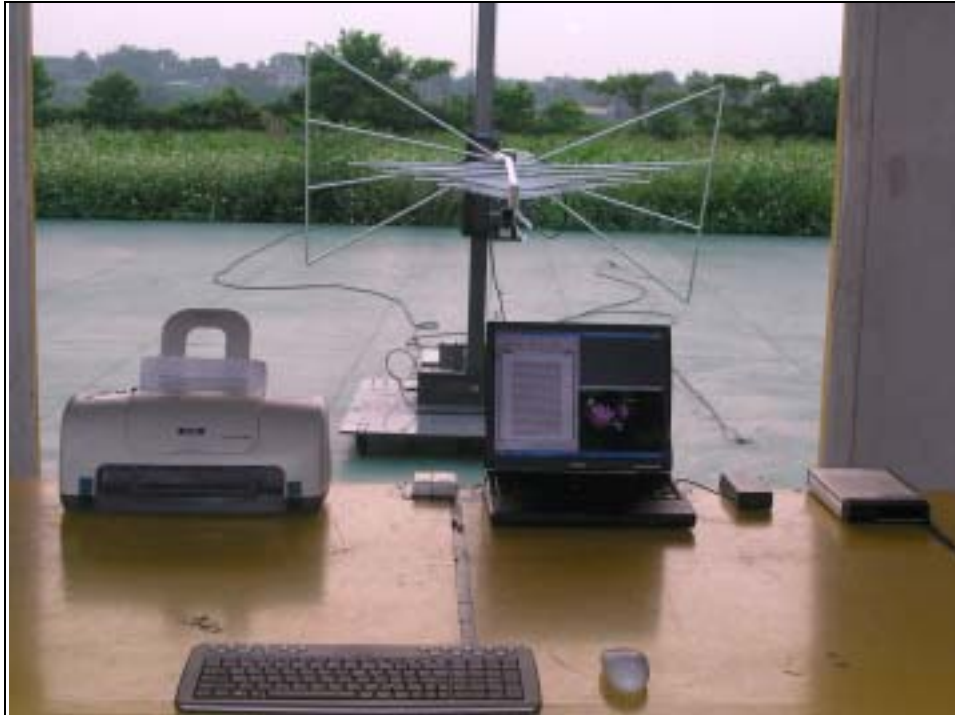

FCC ID: FSUGMZGX (Mouse)
FSUGKZGM(Keyboard)

**Spectrum Research & Testing Lab., Inc.**

No. 101-10, Ling 8,
Shan-Tong Li, Chung-Li
City, Taoyuan, Taiwan,
R.O.C.

TEST REPORT

Reference No.:A04060903
Report No.:FCCA04060903
Page:31 of 31
Date:June 16, 2004

8. TERMS OF ABRIVATION

AV.	Average detection
AZ(°)	Turn table azimuth
Correct.	Correction
EL(m)	Antenna height (meter)
EUT	Equipment Under Test
Horiz.	Horizontal direction
LISN	Line Impedance Stabilization Network
NSA	Normalized Site Attenuation
Q.P.	Quasi-peak detection
SRT Lab	Spectrum Research & Testing Laboratory, Inc.
Vert.	Vertical direction