

POWER SOLUTION

- RECEIVER DOWNBOARD
- FUNCTION INCLUDE
1. USB Power IN and D+D-
  2. MCU
  3. Keyboard Receiver

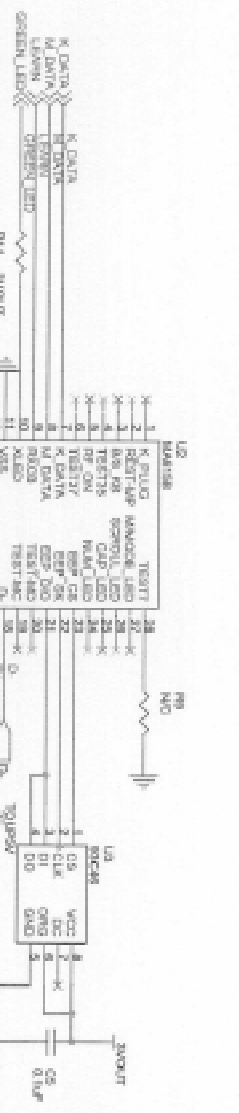

KEYBOARD RECEIVER

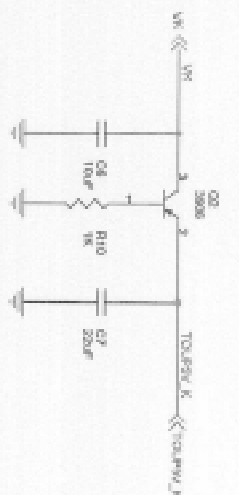
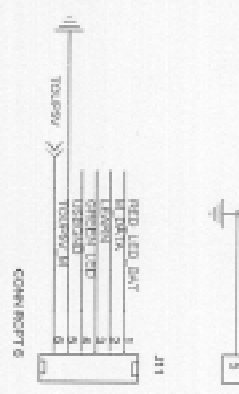
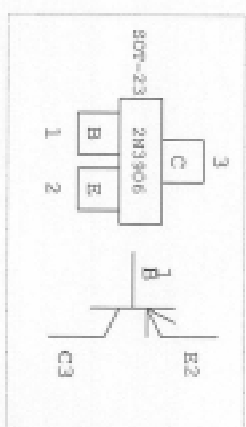
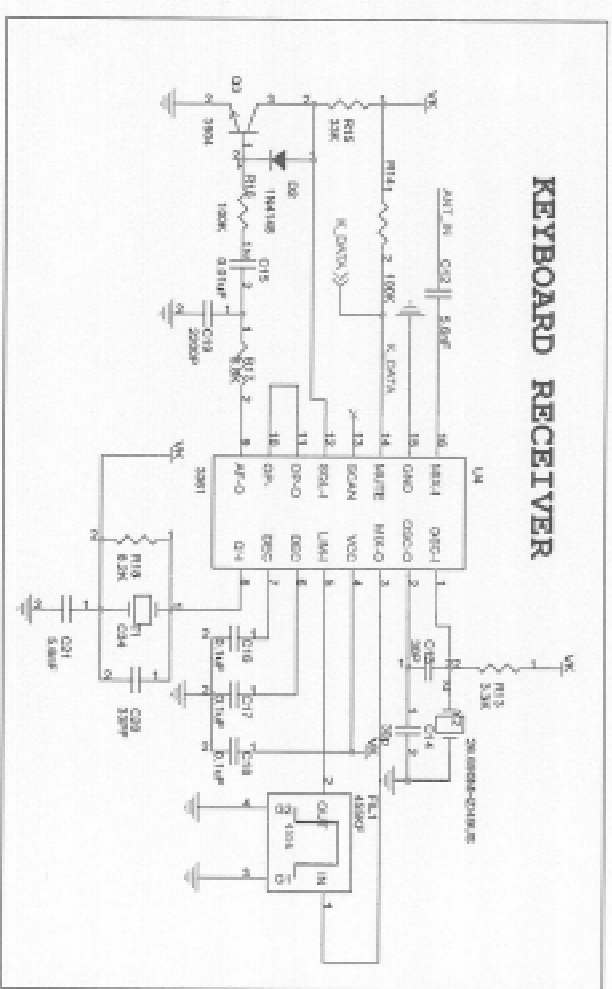

REV	DATE	BY
1	2007-23	2N3906
2	2008-06	2N3906
3	2008-06	2N3906
4	2008-06	2N3906
5	2008-06	2N3906
6	2008-06	2N3906
7	2008-06	2N3906
8	2008-06	2N3906
9	2008-06	2N3906
10	2008-06	2N3906
11	2008-06	2N3906
12	2008-06	2N3906
13	2008-06	2N3906
14	2008-06	2N3906
15	2008-06	2N3906
16	2008-06	2N3906
17	2008-06	2N3906
18	2008-06	2N3906
19	2008-06	2N3906
20	2008-06	2N3906
21	2008-06	2N3906
22	2008-06	2N3906
23	2008-06	2N3906
24	2008-06	2N3906
25	2008-06	2N3906
26	2008-06	2N3906
27	2008-06	2N3906
28	2008-06	2N3906
29	2008-06	2N3906
30	2008-06	2N3906
31	2008-06	2N3906
32	2008-06	2N3906
33	2008-06	2N3906
34	2008-06	2N3906
35	2008-06	2N3906
36	2008-06	2N3906
37	2008-06	2N3906
38	2008-06	2N3906
39	2008-06	2N3906
40	2008-06	2N3906
41	2008-06	2N3906
42	2008-06	2N3906
43	2008-06	2N3906
44	2008-06	2N3906
45	2008-06	2N3906
46	2008-06	2N3906
47	2008-06	2N3906
48	2008-06	2N3906
49	2008-06	2N3906
50	2008-06	2N3906
51	2008-06	2N3906
52	2008-06	2N3906
53	2008-06	2N3906
54	2008-06	2N3906
55	2008-06	2N3906
56	2008-06	2N3906
57	2008-06	2N3906
58	2008-06	2N3906
59	2008-06	2N3906
60	2008-06	2N3906
61	2008-06	2N3906
62	2008-06	2N3906
63	2008-06	2N3906
64	2008-06	2N3906
65	2008-06	2N3906
66	2008-06	2N3906
67	2008-06	2N3906
68	2008-06	2N3906
69	2008-06	2N3906
70	2008-06	2N3906
71	2008-06	2N3906
72	2008-06	2N3906
73	2008-06	2N3906
74	2008-06	2N3906
75	2008-06	2N3906
76	2008-06	2N3906
77	2008-06	2N3906
78	2008-06	2N3906
79	2008-06	2N3906
80	2008-06	2N3906
81	2008-06	2N3906
82	2008-06	2N3906
83	2008-06	2N3906
84	2008-06	2N3906
85	2008-06	2N3906
86	2008-06	2N3906
87	2008-06	2N3906
88	2008-06	2N3906
89	2008-06	2N3906
90	2008-06	2N3906
91	2008-06	2N3906
92	2008-06	2N3906
93	2008-06	2N3906
94	2008-06	2N3906
95	2008-06	2N3906
96	2008-06	2N3906
97	2008-06	2N3906
98	2008-06	2N3906
99	2008-06	2N3906
100	2008-06	2N3906

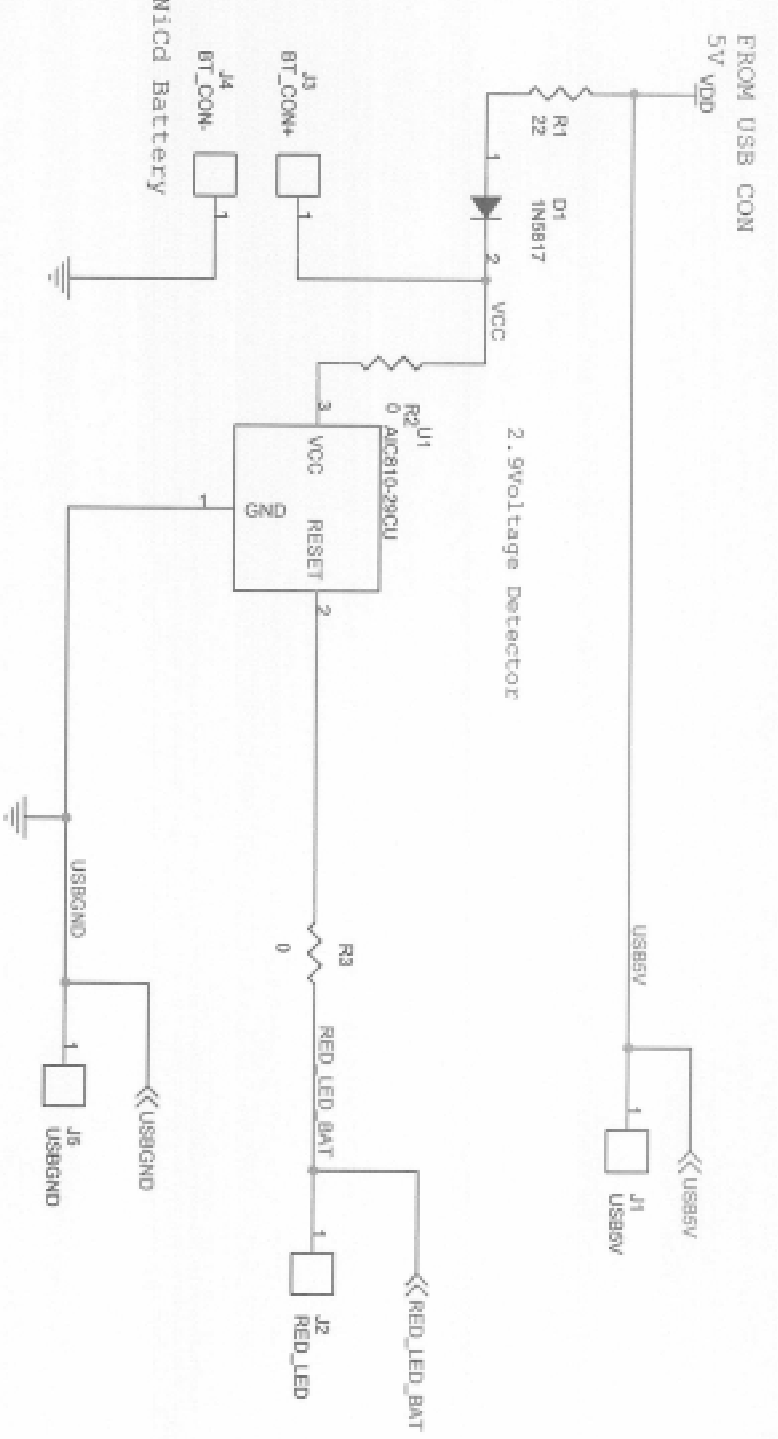

2 cells NIMH/NICD Battery

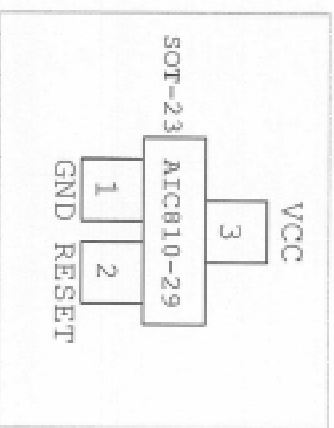
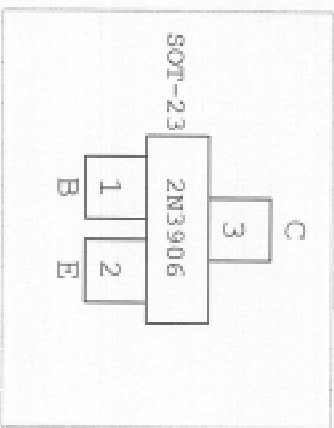

DWG:	CHK:	APP:
KB-3008/R		
Size A	Document Number	Rev 6
	CKT-21010004100	
Date:	Wednesday, June 09, 2004	PCB:10230021100 VER:7
	Sheet 1	of 4

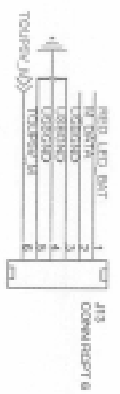
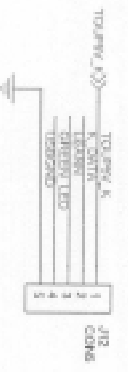
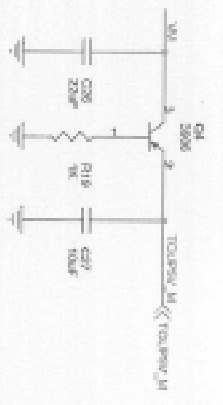
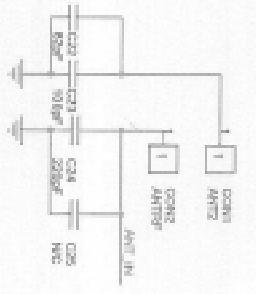

- RECEIVER UPBOARD**
- FUNCTION INCLUDE**
1. Antenna to Keyboard RX
  2. Mouse Receiver
  3. LED Light \*2
  4. Learn Bottom \*1

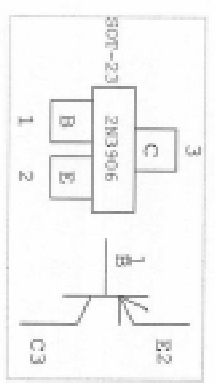
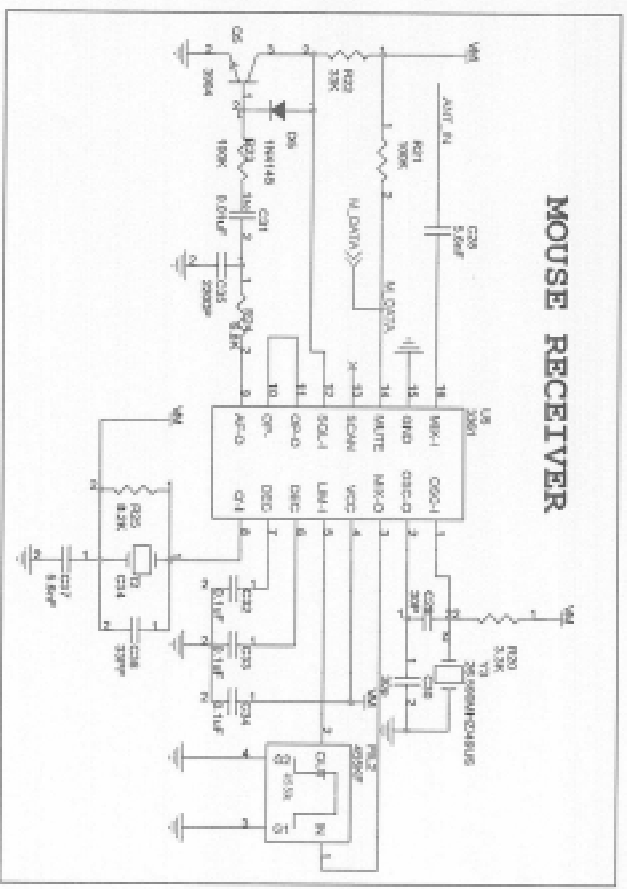

Date: 2003.12.19  
 Rev:11  
 Rev  
 Date: 2004.02.17  
 Rev:2  
 Change Machinery for 樂玉  
 Modify Re and Power  
 Circuit  
 Date: 2004.03.8  
 Rev:3  
 Change Machinery for 廣和  
 ModelC  
 Date: 2004.03.15  
 Rev:4  
 Modify MCP Cypress  
 Date: 2004.04.15  
 Rev:5  
 DC:30401035  
 Modify RF Circuit  
 Move R4 R5 to Top Board  
 Modify J12,13 Pin  
 Assignment  
 Del R13,20  
 Date: 2004.04.20  
 Rev:5-2  
 Modify RF Circuit  
 Change 180 DE  
 Date: 2004.05.13  
 Rev:6  
 DC:30401827  
 Modify Ver:3 Circuit  
 Del R4,05,R26,R27  
 Date: 2004.06.7  
 Rev:7  
 Modify Punch and List

Doc#	Document Number	KB-030084R
Rev	Rev	1
Doc#	Document Number	CKT:21010004100 PCB:10230049100 Rev:8
Rev	Rev	8