



FCC TEST REPORT

for

PART 15, SUBPART B CLASS B

EQUIPMENT : Mouse

MODEL NO. : P805, P806

F C C I D : FSUGMZG1

FILING TYPE : ORIGINAL CERTIFICATION

APPLICANT : **KYE SYSTEMS CORP.**

No. 492, Sec. 5, Chung Hsin Rd., San Chung,
Taipei Hsien, 241, Taiwan, R.O.C.

- The test result refers exclusively to the test presented test model / sample.
- Without the written authorization of the test lab., the Test Report may not be copied.

SPORTON INTERNATIONAL INC.

6F, No. 106, Hsin Tai Wu Rd., Sec. 1, Hsi Chih, Taipei Hsien, Taiwan, R.O.C.

TABLE OF CONTENT

SECTION TITLE	PAGE
CERTIFICATE OF COMPLIANCE.....	3
1. GENERAL DESCRIPTION OF EQUIPMENT UNDER TEST	4
1.1. APPLICANT.....	4
1.2. MANUFACTURER.....	4
1.3. BASIC DESCRIPTION OF EQUIPMENT UNDER TEST.....	4
1.4. FEATURE OF EQUIPMENT UNDER TEST	4
2. TEST CONFIGURATION OF EQUIPMENT UNDER TEST.....	5
2.1. TEST MANNER.....	5
2.2. DESCRIPTION OF TEST SYSTEM.....	5
2.3. CONNECTION DIAGRAM OF TEST SYSTEM.....	7
3. TEST SOFTWARE	8
4. GENERAL INFORMATION OF TEST.....	9
4.1. TEST FACILITY.....	9
4.2. STANDARD FOR METHODS OF MEASUREMENT	9
4.3. TEST IN COMPLIANCE WITH	9
4.4. FREQUENCY RANGE INVESTIGATED.....	9
4.5. TEST DISTANCE	9
5. TEST OF CONDUCTED POWERLINE.....	10
5.1. MAJOR MEASURING INSTRUMENTS	10
5.2. TEST PROCEDURES	11
5.3. TYPICAL TEST SETUP LAYOUT OF CONDUCTED POWERLINE	12
5.4. TEST RESULT OF AC POWERLINE CONDUCTED EMISSION.....	13
5.4.1. TEST RESULT OF AC POWERLINE CONDUCTED EMISSION.....	14
5.5. PHOTOGRAPHS OF CONDUCTED POWERLINE TEST CONFIGURATION.....	15
6. TEST OF RADIATED EMISSION	17
6.1. MAJOR MEASURING INSTRUMENTS	17
6.2. TEST PROCEDURES	18
6.3. TYPICAL TEST SETUP LAYOUT OF RADIATED EMISSION	19
6.4. TEST RESULT OF RADIATED EMISSION	20
6.4.1. TEST RESULT OF RADIATED EMISSION	21
6.5. PHOTOGRAPHS OF RADIATED EMISSION TEST CONFIGURATION.....	22
7. ANTENNA FACTOR AND CABLE LOSS	23
8. LIST OF MEASURING EQUIPMENT USED.....	24



CERTIFICATE OF COMPLIANCE

for

FCC PART 15, SUBPART B CLASS B

EQUIPMENT : Mouse

MODEL NO. : P805, P806

F C C I D : FSUGMZG1

APPLICANT : **KYE SYSTEMS CORP.**

No. 492, Sec. 5, Chung Hsin Rd., San Chung,
Taipei Hsien, 241, Taiwan, R.O.C.

I HEREBY CERTIFY THAT :

The measurement shown in this report were made in accordance with the procedures given in **ANSI C63.4 -1992** and the energy emitted by this equipment was *passed* both radiated and conducted emissions **Class B** limits. Testing was carried out on **Oct. 23, 1998** at **SPORTON International Inc. LAB.**

W. L. Huang
General Manager

SPORTON INTERNATIONAL INC.

6F, No. 106, Hsin Tai Wu Rd., Sec. 1, Hsi Chih, Taipei Hsien, Taiwan, R.O.C.

1. GENERAL DESCRIPTION OF EQUIPMENT UNDER TEST

1.1. APPLICANT

KYE SYSTEMS CORP.

No. 492, Sec. 5, Chung Hsin Rd., San Chung,
Taipei Hsien, 241, Taiwan, R.O.C.

1.2. MANUFACTURER

Same as 1.1

1.3. BASIC DESCRIPTION OF EQUIPMENT UNDER TEST

EQUIPMENT : Mouse

MODEL NO. : P805, P806

TRADE NAME : **Genius**

DATA CABLE : Non-shielded, 1.5m

POWER SUPPLY TYPE : N/A

POWER CORD : N/A

1.4. FEATURE OF EQUIPMENT UNDER TEST

400DPI : P805	: High resolution, two-button mouse version
: P806	: High resolution, three-button mouse version
Supports Plug and Play Function	
Windows Modeling design	: For smooth cursor movement, fashion modeling
MouseMate	: Friendly interface lets you personalize the mouse cursor
Models	: PS/2 version

1. GENERAL DESCRIPTION OF EQUIPMENT UNDER TEST

1.1. APPLICANT

KYE SYSTEM CORP.

No. 492, Sec. 5, Chung Hsin Rd., San Chung,
 Taipei Hsien, 241, Taiwan, R.O.C.

1.2. MANUFACTURER

Same as 1.1

1.3. BASIC DESCRIPTION OF EQUIPMENT UNDER TEST

EQUIPMENT : Mouse
 MODEL NO. : P805, P806
 TRADE NAME : **Genius**
 DATA CABLE : No-shielded, 1.4m
 POWER SUPPLY TYPE : N/A
 POWER CORD : N/A

1.4. FEATURE OF EQUIPMENT UNDER TEST

400DPI : P805	: High resolution, two-button mouse version
: P806	: High resolution, three-button mouse version
Supports Plug and Play Function	
Windows Modeling design	: For smooth cursor movement, fashion modeling
MouseMate	: Friendly interface lets you personalize the mouse cursor
Models	: PS/2 version

2. TEST CONFIGURATION OF EQUIPMENT UNDER TEST

2.1. TEST MANNER

- a. The EUT has been associated with personal computer and peripherals pursuant to ANSI C63.4-1992 and configuration operated in a manner, which tended to maximize its emission characteristics in a typical application.
- b. The SONY monitor, DELL keyboard, HP printer, ACEEX modem and EUT were connected to the F.I.C. P.C. for EMI test.
- c. Frequency range investigated: Conduction 450 KHz to 30 MHz, Radiation 30 MHz to 1000 MHz.

2.2. DESCRIPTION OF TEST SYSTEM

Support Device 1. --- P.C. (FIC)

FCC ID : N/A
Model No. : P2L97
Serial No. : SP1005
Data Cable : Shielded
Power Cord : Non-shielded
Power Supply Type : Switching

(Remark : This support device was tested to comply with FCC standards and authorized under a declaration of conformity.)

Support Device 2. --- MONITOR (SONY)

FCC ID : AK8GDM17SE2T
Model No. : GDM-17SE2T
Serial No. : SP1006
Data Cable : Shielded, 360 degree via metal backshells, 1.7m
Power Supply Type : Switching
Power Cord : Non-shielded

Support Device 3. --- KEYBOARD (DELL)

FCC ID : GYUM92SK
Model No. : AT101 (DE8M)
Serial No. : SP1021
Data Cable : Shielded, 360 degree via metal backshells, 1.9m

Support Device 4. --- PRINTER (HP)

FCC ID : B94C2642X
Model No. : DESK JET 400
Serial No. : SP1040
Data Cable : Shielded, 360 degree via metal backshells, 1.35m
Power Supply Type : Linear, Adapter
Power Cord : Non-shielded

Support Device 5. -- MODEM (ACEEX)

FCC ID : IFAXDM1414
Model No. : DM1414
Power Supply Type : Linear, AC Adapter
Power Cord : Non-shielded
Serial No. : SP1045
Data Cable : Shielded, 360 degree via metal backshells, 1.15m

2.3. CONNECTION DIAGRAM OF TEST SYSTEM

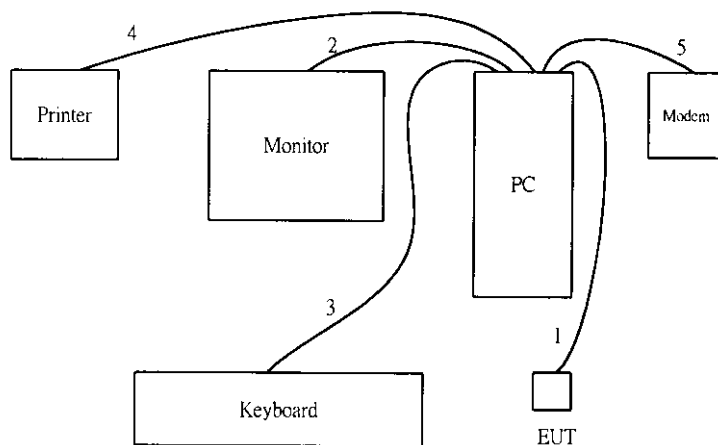

1. The I/O cable is connected from the PC to the EUT.
2. The I/O cable is connected from the PC to the support device 2.
3. The I/O cable is connected from the PC to the support device 3.
4. The I/O cable is connected from the PC to the support device 4.
5. The I/O cable is connected from the PC to the support device 5.

3. TEST SOFTWARE

An executive program, EMITEST.EXE under WIN 98, which generates a complete line of continuously repeating " H " pattern was used as the test software.

The EMITEST.EXE program was executed as follows :

- a. Turn on the power of all equipment.
- b. The PC reads the test program from the floppy disk drive and runs it.
- c. The PC sends " H " messages to the monitor, and the monitor displays " H " patterns on the screen.
- d. The PC sends " H " messages to the printer, then the printer prints them on the paper.
- e. The PC sends " H " messages to the modem.
- f. The PC sends " H " messages to the internal Hard Disk, and the Hard Disk reads and writes the message.
- g. Repeat the steps from b to f.

4. GENERAL INFORMATION OF TEST

4.1. TEST FACILITY

This test was carried out by SPORTON INTERNATIONAL INC.

Test Site Location : No. 30-1, Lin 6, Diing-Fwu Tsuen, Lin-Kou-Hsiang,
Taipei Hsien, Taiwan, R.O.C.

TEL : 886-2-2601-1640, FAX : 886-2-2601-1695

4.2. STANDARD FOR METHODS OF MEASUREMENT

ANSI C63.4-1992

4.3 .TEST IN COMPLIANCE WITH

FCC PART 15, SUBPART B CLASS B

4.4. FREQUENCY RANGE INVESTIGATED

- a. Conduction : from 450 KHz to 30 MHz
- b. Radiation : from 30 MHz to 1000 MHz.

4.5. TEST DISTANCE

The test distance of radiated emission from antenna to EUT is 3M.

5. TEST OF CONDUCTED POWERLINE

Conducted Emissions were measured from 450 KHz to 30 MHz with a bandwidth of 9 KHz on the 115 VAC power and return leads of the EUT according to the methods defined in ANSI C63.4-1992 Section 3.1. The EUT was placed on a nonmetallic stand in a shielded room 0.8 meters above the ground plane as shown in Figure 5-3. The interface cables and equipment positioning were varied within limits of reasonable applications to determine the position produced maximum conducted emissions.

5.1. MAJOR MEASURING INSTRUMENTS

- Test Receiver (HP 8591EM)
 - Attenuation 0 dB
 - Start Frequency 0.45 MHz
 - Stop Frequency 30 MHz
 - Step MHz 0.007 MHz
 - IF Bandwidth 9 KHz

5.2. TEST PROCEDURES

- a. The EUT was placed 0.4 meter from the conducting wall of the shielding room and was kept at least 80 centimeters from any other grounded conducting surface.
- b. Connect EUT to the power mains through a line impedance stabilization network (LISN).
- c. All the support units are connect to the other LISN.
- d. The LISN provides 50 ohm coupling impedance for the measuring instrument.
- e. The FCC states that a 50 ohm , 50 microhenry LISN should be used.
- f. Both sides of AC line were checked for maximum conducted interference.
- g. The frequency range from 450 KHz to 30 MHz was searched.
- h. Set the test-receiver system to Peak Detect Function and Specified Bandwidth with Maximum Hold Mode.
- i. If the emission level of the EUT in peak mode was 6 dB lower than the limit specified, then testing will be stopped and peak values of EUT will be reported otherwise the emissions which do not have 6 dB margin will be retested on by one using the quasi-peak method and reported.

5.3. TYPICAL TEST SETUP LAYOUT OF CONDUCTED POWERLINE

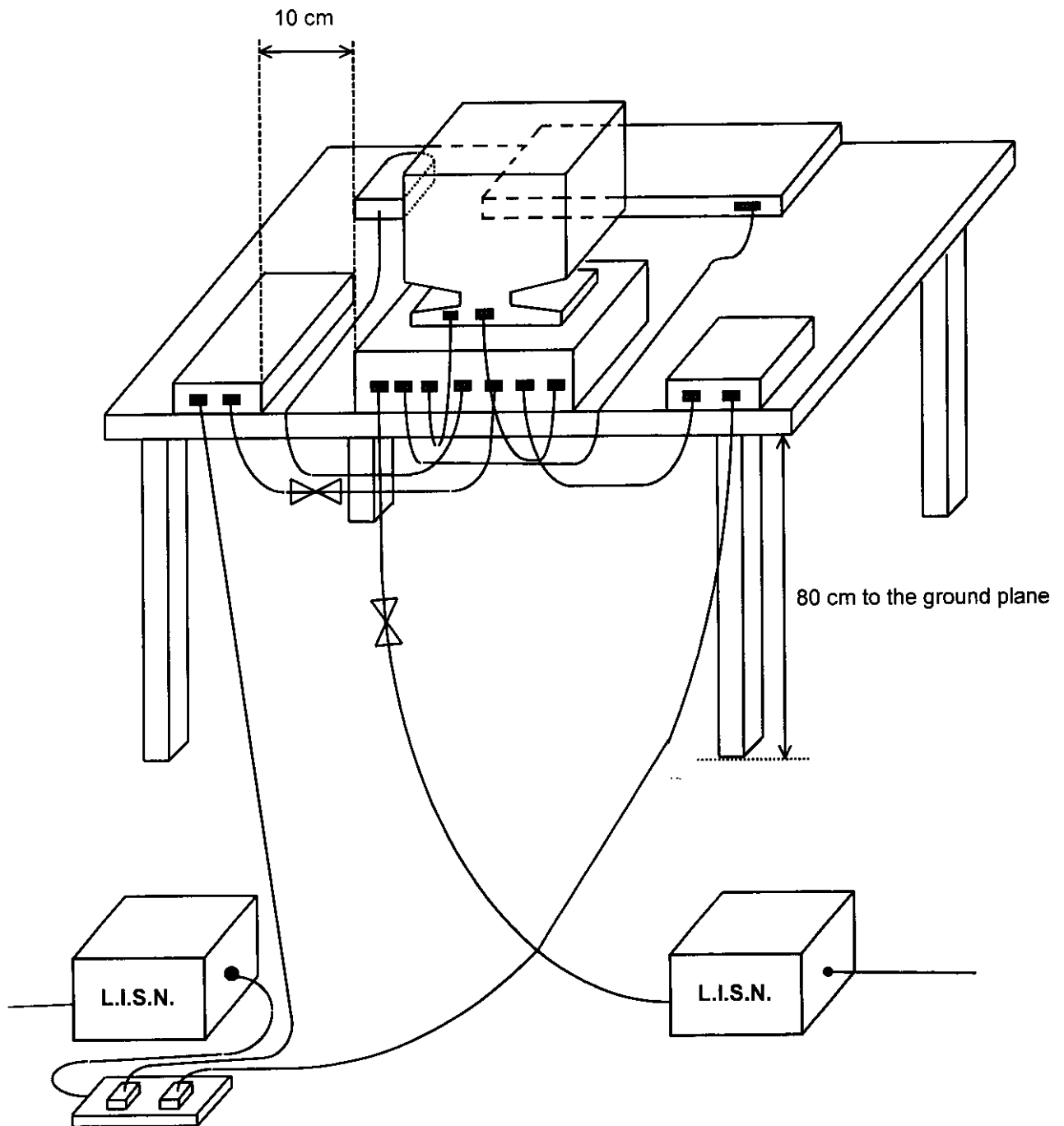

5.4. TEST RESULT OF AC POWERLINE CONDUCTED EMISSION

- Frequency Range of Test : from 0.45 MHz to 30 MHz
- All emissions not reported here are more than 10 dB below the prescribed limit.
- Temperature : 24°C
- Relative Humidity : 58 % RH
- Test Model : P805
- Test Date : Oct. 23, 1998

The Conducted Emission test was passed at Line 24.91 MHz/ 44.40 dBuV.

Frequency (MHz)	Line / Neutral	Meter Reading		Limits		Margin
		(dBuV)	(uV)	(dBuV)	(uV)	(dB)
0.48	L	41.00	112.20	48.00	251.19	-7.00
20.75	L	35.80	61.66	48.00	251.19	-12.20
24.91	L	44.40	165.96	48.00	251.19	-3.60
0.48	N	41.30	116.14	48.00	251.19	-6.70
1.72	N	31.90	39.36	48.00	251.19	-16.10
24.90	N	44.40	165.96	48.00	251.19	-3.60

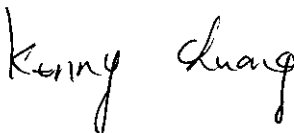
Test Engineer : 
 Kenny Chuang

5.4.1. TEST RESULT OF AC POWERLINE CONDUCTED EMISSION

- Frequency Range of Test : from 0.45 MHz to 30 MHz
- All emissions not reported here are more than 10 dB below the prescribed limit.
- Temperature : 24°C
- Relative Humidity : 58 % RH
- Test Model : P806
- Test Date : Oct. 23, 1998

The Conducted Emission test was passed at Line 24.90 MHz/ 43.70 dBuV.

Frequency (MHz)	Line / Neutral	Meter Reading		Limits		Margin (dB)
		(dBuV)	(uV)	(dBuV)	(uV)	
0.48	L	41.10	113.50	48.00	251.19	-6.90
1.06	L	34.10	50.70	48.00	251.19	-13.90
24.90	L	43.70	153.11	48.00	251.19	-4.30
0.48	N	41.00	112.20	48.00	251.19	-7.00
20.76	N	31.60	38.02	48.00	251.19	-16.40
24.90	N	40.70	108.39	48.00	251.19	-7.30

Test Engineer :
Kenny Chuang

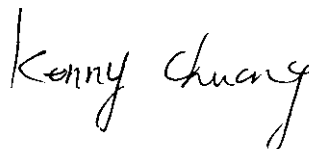

6. TEST OF RADIATED EMISSION

Radiated emissions from 30 MHz to 1000 MHz were measured with a bandwidth of 120 KHz according to the methods defines in ANSI C63.4-1992. The EUT was placed on a nonmetallic stand in the open-field site, 0.8 meter above the ground plane, as shown in Figure 6-3. The interface cables and equipment positions were varied within limits of reasonable applications to determine the positions producing maximum radiated emissions.

6.1. MAJOR MEASURING INSTRUMENTS

- Amplifier (HP 8447D)
 - Attenuation 0 dB
 - RF Gain 25 dB
 - Signal Input 0.1 MHz to 1.3 GHz

- Spectrum Analyzer (HP 8560E)
 - Attenuation 0 dB
 - Start Frequency 30 MHz
 - Stop Frequency 1000 MHz
 - Resolution Bandwidth 1 MHz
 - Video Bandwidth 1 MHz
 - Signal Input 30 Hz to 2.9 GHz

- Test Receiver (R&S ESVP)
 - Resolution Bandwidth 120 KHz
 - Frequency Band 30 MHz to 1 GHz
 - Quasi-Peak Detector ON for Quasi-Peak Mode
OFF for Peak Mode

6.2. TEST PROCEDURES

- a. The EUT was placed on a rotatable table top 0.8 meter above ground.
- b. The EUT was set 3 meters from the interference receiving antenna which was mounted on the top of a variable height antenna tower.
- c. The table was rotated 360 degrees to determine the position of the highest radiation.
- d. The antenna is a half wave dipole and its height is varied between one meter and four meters above ground to find the maximum value of the field strength both horizontal polarization and vertical polarization of the antenna are set to make the measurement.
- e. For each suspected emission the EUT was arranged to its worst case and then tune the antenna tower (from 1 M to 4 M) and turn table (from 0 degree to 360 degrees) to find the maximum reading.
- f. Set the test-receiver system to Peak Detect Function and specified bandwidth with Maximum Hold Mode.
- g. If the emission level of the EUT in peak mode was 6 dB lower than the limit specified, then testing will be stopped and peak values of EUT will be reported otherwise the emissions which do not have 6 dB margin will be repeated one by one using the quasi-peak method and reported.

6.3. TYPICAL TEST SETUP LAYOUT OF RADIATED EMISSION

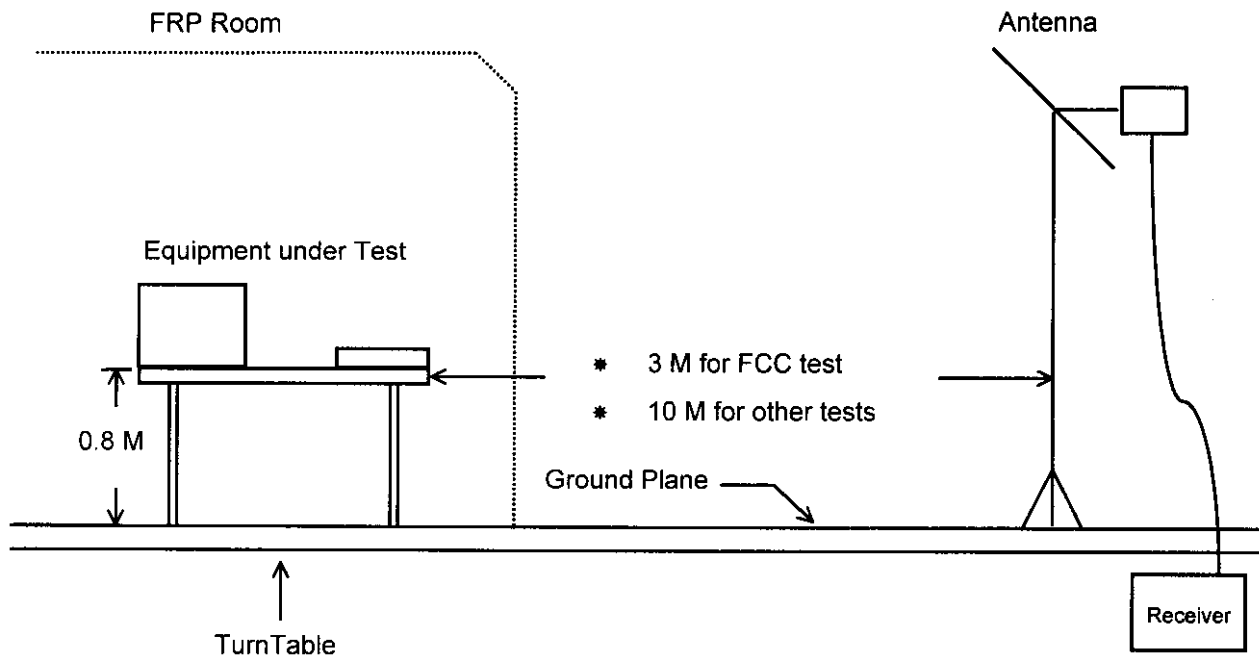

6.4. TEST RESULT OF RADIATED EMISSION

- Equipment meets the technical specifications of 15.109
- Frequency Range of Test : from 30 MHz to 1000 MHz
- Test Distance : 3 M
- Temperature : 25°C
- Relative Humidity : 60 % RH
- Test Model : P805
- Test Date : Oct. 23, 1998

- Emission level (dBuV/m) = 20 log Emission level (uV/m)
- Sample Calculation at 47.82 MHz
 Corrected Reading = 1.91 + 1.00 + 30.52 = 33.43 (dBuV/m)

The Radiated Emission test was passed at

Vertical 48.17 MHz / 33.85 dBuV

Antenna Height 1.5 Meter , Turntable Degree 240 °.

Frequency (MHz)	Antenna Polarity	Cable Factor	Reading Loss	Limits (dBuV)	Emission (uV)	Level (dBuV)	Margin (uV)	(dB)
47.82	H	1.91	1.00	30.52	40.00	100	33.43	46.94 -6.57
400.66	H	22.29	3.60	13.23	46.00	200	39.12	90.36 -6.88
48.17	V	1.99	1.00	30.86	40.00	100	33.85	49.26 -6.15
67.02	V	5.32	1.20	24.80	40.00	100	31.32	36.81 -8.68
200.58	V	14.06	2.40	17.71	43.50	150	34.17	51.11 -9.33
401.45	V	22.29	3.61	11.40	46.00	200	37.30	73.28 -8.70

Test Engineer : 
 Jack Deng

6.4.1. TEST RESULT OF RADIATED EMISSION

- Equipment meets the technical specifications of 15.109
- Frequency Range of Test : from 30 MHz to 1000 MHz
- Test Distance : 3 M
- Temperature : 25°C
- Relative Humidity : 60 % RH
- Test Model : P806
- Test Date : Oct. 23, 1998

- Emission level (dBuV/m) = 20 log Emission level (uV/m)
- Sample Calculation at 400.66 MHz
 Corrected Reading = 22.29 + 3.60 + 16.23 = 42.12 (dBuV/m)

The Radiated Emission test was passed at
Horizontal 633.38 MHz / 42.22 dBuV
Antenna Height 2.0 Meter , Turntable Degree 160 °.

Frequency (MHz)	Antenna Polarity	Cable Factor	Reading Loss	Limits (dBuV)	Emission (uV)	Level (dBuV)	Margin (dB)
400.66	H	22.29	3.60	16.23	46.00	200	42.12 127.64 -3.88
633.38	H	24.74	4.87	12.61	46.00	200	42.22 129.12 -3.78
48.01	V	1.96	1.00	30.59	40.00	100	33.55 47.59 -6.45
67.20	V	5.34	1.20	28.36	40.00	100	34.90 55.59 -5.10
400.66	V	22.29	3.60	12.56	46.00	200	38.45 83.66 -7.55
733.80	V	26.34	5.44	10.15	46.00	200	41.94 125.03 -4.06

Test Engineer : 
 Jack Deng

7. ANTENNA FACTOR AND CABLE LOSS

Frequency (MHz)	Antenna Factor (dB)	Cable Loss (dB)
30	-1.91	0.90
35	-0.50	0.92
40	0.61	1.04
45	1.40	1.28
50	2.39	1.10
55	3.54	1.11
60	4.40	1.30
65	4.84	1.40
70	5.59	1.37
75	6.21	1.24
80	7.60	1.51
85	7.73	1.60
90	8.22	1.60
95	8.90	1.70
100	9.36	1.70
110	10.01	1.70
120	10.41	1.90
130	10.84	1.90
140	11.42	1.91
150	11.91	2.01
160	12.25	2.11
170	12.72	2.21
180	13.02	2.30
190	13.50	2.30
200	14.05	2.40
220	15.11	2.50
240	16.81	2.60
260	17.51	2.71
280	17.70	2.90
300	17.89	2.91
320	18.00	3.10
340	18.33	3.20
360	19.44	3.30
380	20.31	3.40
400	21.19	3.50
450	21.10	3.70
500	22.21	4.10
550	23.42	4.30
600	24.01	4.50
650	25.11	4.70
700	26.00	4.90
750	26.41	5.11
800	27.10	5.50
850	27.51	5.60
900	27.90	5.80
950	28.01	5.90
1000	28.1	3.00

8. LIST OF MEASURING EQUIPMENT USED

Instrument	Manufacturer	Model No.	Serial No.	Characteristics	Calibration Date	Remark
EMC Receiver (site 2)	HP	8591EM	3710A01187	9 KHz - 18 GHz	Sep. 15, 1998	Conduction
LISN (EUT) (site 2)	Telemeter	NNB-2/16Z	98009	50 ohm / 50 uH	Jan. 29, 1998	Conduction
LISN (Support Unit) (site 2)	EMCO	3810/2NM	9703-1839	50 ohm / 50 uH	Jul. 06, 1998	Conduction
Spectrum Analyzer (Site 4)	HP	8560E	3728A03186	30Hz - 2.9GHz	Sep. 16, 1998	Radiation
Amplifier (Site 4)	HP	8447D	2944A09072	0.1MHz -1.3GHz	Sep. 04, 1998	Radiation
Test Receiver (Site 4)	R&S	ESVP	893610/003	20MHz - 1.3GHz	Apr. 13, 1998	Radiation
Bilog Antenna (Site 4)	CHASE	CBL6112A	2288	30MHz -2GHz	Jul. 14, 1998	Radiation
Half-wave dipole antenna (Site 4)	EMCO	3121C	9705-1285	28 M - 1GHz	May 19, 1998	Radiation
Turn Table (site 4)	EMCO	2080	9711-1090	0 ~ 360 degree	N/A	Radiation
Antenna Mast (site 4)	EMCO	2075	9711-2114	1 m- 4 m	N/A	Radiation

※ The column of Remark indicates that the instruments used for conduction ("C") or radiation ("R") test.



SPORTON LAB

Certificate No: D700701

CERTIFICATE OF COMPLIANCE

Authorized under Declaration of Conformity
according to

47 CFR, Part 2 and Part 15 of the FCC Rules

☉ Equipment Under Test : PERSONAL COMPUTER

Model No. : P2L97

Applicant : FIRST INTERNATIONAL COMPUTER INC.

6F, Formosa Plastics Rear Building 201,
Tung Hwa N. Rd., Taipei, Taiwan, R.O.C.



CERTIFY THAT:

THE MEASUREMENTS SHOWN IN THIS TEST REPORT WERE MADE IN
ACCORDANCE WITH THE PROCEDURES GIVEN IN ANSI C63.4-1992 AND THE
ENERGY EMITTED BY THIS EQUIPMENT WAS PASSED BOTH RADIATED AND
CONDUCTED EMISSIONS CLASS B LIMITS. THE TESTING WAS COMPLETED ON SEP. 02,
1997 AT SPORTON INTERNATIONAL INC. LAB IN NEI HWU.

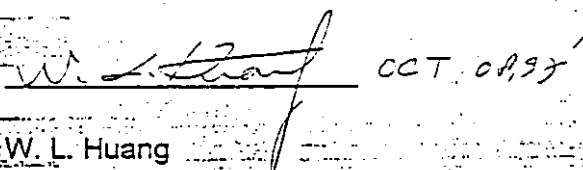
W. L. Huang
GENERAL MANAGER