



Spectrum Research & Testing Lab., Inc.
No. 101-10, Ling 8,
Shan-Tong Li, Chung-Li
City, Taoyuan, Taiwan

TEST REPORT

Reference No.: A05101406
Report No.: FCCA05101406
FCCID: FSUGG000B
Page:1 of 54
Date:Jan. 04, 2006

Product Name: 2.4G XBOX GAME PAD
Model Number: Wireless Blaze X (XBOX)
Applicant: KYE SYSTEMS CORP.
No.492,Sec.5,Chung Hsin Rd.,San Chung,Taipei
Hsien,241,Taiwan,R.O.C.
Date of Receipt: Oct. 14, 2005
Finished date of Test: Dec. 21, 2005
Applicable Standards: 47 CFR Part 15, Subpart C
ANSI C63.4:2003
DA 00-705

We, **Spectrum Research & Testing Laboratory Inc.**, hereby certify that one sample of the above was tested in our laboratory with positive results according to the above-mentioned standards. The records in the report are an accurate account of the results. Details of the results are given in the subsequent pages of this report.

Checked By : Julian Chiang, Date: 1, 4, 2006
(Julian, Chiang)

Approved By : James Lee, Date: Jan. 04, 2006
(Johnson Ho, Director)

NVLAQ®

Lab Code: 200099-0



TABLE OF CONTENTS

1. DOCUMENT POLICY AND TEST STATEMENT.....	4
1.1 DOCUMENT POLICY.....	4
1.2 TEST STATEMENT	4
1.3 EUT MODIFICATION.....	4
2. DESCRIPTION OF EUT AND TEST MODE.....	5
2.1 GENERAL DESCRIPTION OF EUT	5
2.2 DESCRIPTION OF SUPPORT UNIT.....	5
2.3 DESCRIPTION OF TEST MODE	6
3. DESCRIPTION OF APPLIED STANDARDS	6
4. CONDUCTED EMISSION TEST	7
4.1.1 CONDUCTED EMISSION LIMIT	7
4.1.2 TEST EQUIPMENT	7
4.1.3 TEST SETUP	8
4.1.4 TEST PROCEDURE	8
4.1.5 EUT OPERATING CONDITION	8
4.1.6 TEST RESULT	9
4.2 TECHNICAL CHARACTERISTICS TEST	13
4.2.1 6dB Bandwidth	13
4.2.2 LIMIT	13
4.2.3 TEST EQUIPMENT	13
4.2.4 TEST SET-UP	13
4.2.4 TEST PROCEDURE	13
4.2.5 EUT OPERATING CONDITION	13
4.2.6 TEST RESULT	14
4.3 PEAK POWER TEST	18
4.3.1 LIMIT	18
4.3.2 TEST EQUIPMENT	18
4.3.3 TEST SET-UP	19
4.3.4 TEST PROCEDURE	19
4.3.5 EUT OPERATING CONDITION	19
4.3.6 TEST RESULT	20
4.4 BAND EDGE TEST	24
4.4.1 LIMIT	24
4.4.2 TEST EQUIPMENT	25
4.4.3 TEST SET-UP	26
4.4.4 TEST PROCEDURE	27
4.4.5 EUT OPERATING CONDITION	27
4.4.6 TEST RESULT	28
4.5 FUNDAMENTAL & SPURIOUS RADIATED EMISSION TEST	32
4.5.1 LIMIT	32



Spectrum Research & Testing Lab., Inc.
No. 101-10, Ling 8,
Shan-Tong Li, Chung-Li
City, Taoyuan, Taiwan

TEST REPORT

Reference No.:A05101406
Report No.:FCCA05101406
FCCID: FSUGG000B
Page:3 of 54
Date:Jan. 04, 2006

4.5.2	TEST EQUIPMENT	33
4.5.3	TEST SET-UP	34
4.5.4	TEST PROCEDURE	35
4.5.5	EUT OPERATING CONDITION	35
4.5.6	TEST RESULT	36
4.7	POWER DENSITY TEST	43
4.7.1	LIMIT	43
4.7.2	TEST EQUIPMENT	43
4.7.3	TEST SET-UP	43
4.7.4	TEST PROCEDURE	43
4.7.5	EUT OPERATING CONDITION	43
4.7.6	TEST RESULT	44
5.	Antenna application	48
5.1	ANTENNA REQUIREMENT	48
5.2	RESULT	48
6.	PHOTOS OF TESTING	49
7.	TERMS OF ABRIVATION	54



**Spectrum Research &
Testing Lab., Inc.**
No. 101-10, Ling 8,
Shan-Tong Li, Chung-Li
City, Taoyuan, Taiwan

TEST REPORT

Reference No.:A05101406
Report No.:FCCA05101406
FCCID: FSUGG000B
Page:4 of 54
Date:Jan. 04, 2006

1. DOCUMENT POLICY AND TEST STATEMENT

1.1 DOCUMENT POLICY

- The report shall not be reproduced except in full, without the written approval of SRT Lab, Inc.

1.2 TEST STATEMENT

- The test results in the report apply only to the unit tested by SRT Lab.
- There was no deviation from the requirements of test standards during the test.
- AC power source, 120 VAC/60 Hz, was used during the test.

1.3 EUT MODIFICATION

- No modification in SRT Lab.



2. DESCRIPTION OF EUT AND TEST MODE

2.1 GENERAL DESCRIPTION OF EUT

PRODUCT	2.4G XBOX GAME PAD
MODEL NO.	Wireless Blaze X (XBOX)
POWER SUPPLY	DC 3V 10m
FREQUENCY BAND	2400~2481HMz
NUMBER OF CHANNEL	20
RATED RF OUTPUT POWER	0dBm
MODULATION TYPE	FSK
BIT RATE OF TRANSMISSION	1Mbps
ANTENNA TYPE	Integral Antenna

NOTE :

For more detailed information, please refer to the EUT's specification or user's manual provided by manufacturer.

2.2 DESCRIPTION OF SUPPORT UNIT

The transmitter part of EUT was tested with a Game system(Play station 2) and configured by the requirement of ANSI C63.4. All interface ports were connected to the appropriate support units via specific cables. The support units and cables are listed below.

NO	DEVICE	BRAND	MODEL #	CABLE
1	TV	PANASONIC	TC14S10RZ	1.5m shielded power cord
2	X-BOX	MISCROSOFT	F23-00164	2.1m shielded power cord 1.8m unshielded data cable

NOTE : For the actual test configuration, please refer to the photos of testing.



2.3 DESCRIPTION OF TEST MODE

78 channels are provided by EUT. The 3 channels of lower, medium and higher were chosen for test.

Channel	Frequency (MHz)
0	2402
9	2440
19	2481

NOTE :

1. Below 1 GHz, the channel 0, 9 and 19 were pre-tested in chamber. The channel 19, worst case one, was chosen for conducted and radiated emission test.
2. Above 1 GHz, the channel 0, 9 and 19 were tested individually.

3. DESCRIPTION OF APPLIED STANDARDS

The EUT is a kind of wireless product and to be connected with a Game system for normal use. According to the specifications provided by the applicant, it must comply with the requirements of the following standards:

47 CFR Part 15, Subpart C

ANSI C63.4: 2003

Public DA00-705 (March 2000)

All tests have been performed and recorded as the above standards.



4. CONDUCTED EMISSION TEST

4.1.1 CONDUCTED EMISSION LIMIT

FREQUENCY (MHz)	Class A (dB μ V)		Class B (dB μ V)	
	Quasi-peak	Average	Quasi-peak	Average
0.15 - 0.5	79	66	66 - 56	56 - 46
0.5 - 5.0	73	60	56	46
5.0 - 30.0	73	60	60	50

NOTE:

1. The lower limit shall apply at the transition frequencies.
2. The limit decreases in line with the logarithm of the frequency in the range of 0.15 to 0.50 MHz.

4.1.2 TEST EQUIPMENT

The following test equipment was used for the test:

EQUIPMENT/ FACILITIES	SPECIFICATIONS	MANUFACTURER	MODEL#/ SERIAL#	DUE DATE OF CAL. & CAL. CENTER
EMI TEST RECEIVER	9 kHz TO 30 MHz	ROHDE & SCHWARZ	ESHS30/ 826003/008	AUG. 2006 ETC
LISN (for EUT)	50 μ H, 50 ohm	SOLAR ELECTRONICS	8012-50-R-24-BNC / 924839	JUN. 2006 ETC
LISN (for Peripheral)	50 μ H, 50 ohm	SOLAR ELECTRONICS	9252-50-R-24-BNC / 951318	JUN. 2006 ETC
50 ohm TERMINATOR	50 ohm	HP	11593A/ 2	JUN. 2006 ETC
COAXIAL CABLE	3m	SUNCITY	J400/ 3M	JUL. 2006 SRT
ISOLATION TRANSFORMER	N/A	APC	AFC-11015/ F102040016	N/A
FILTER	2 LINE, 30A	FIL.COIL	FC-943/ 771	N/A
GROUND PLANE	2.3M (H) x 2.4M (W)	SRT	N/A	APR. 2006 SRT
GROUND PLANE	2.4M (H) x 2.4M (W)	SRT	N/A	APR. 2006 SRT

NOTE: The calibration interval of the above test equipment is one year and the calibrations are traceable to NML/ROC and NIST/USA.



4.1.3 TEST SETUP

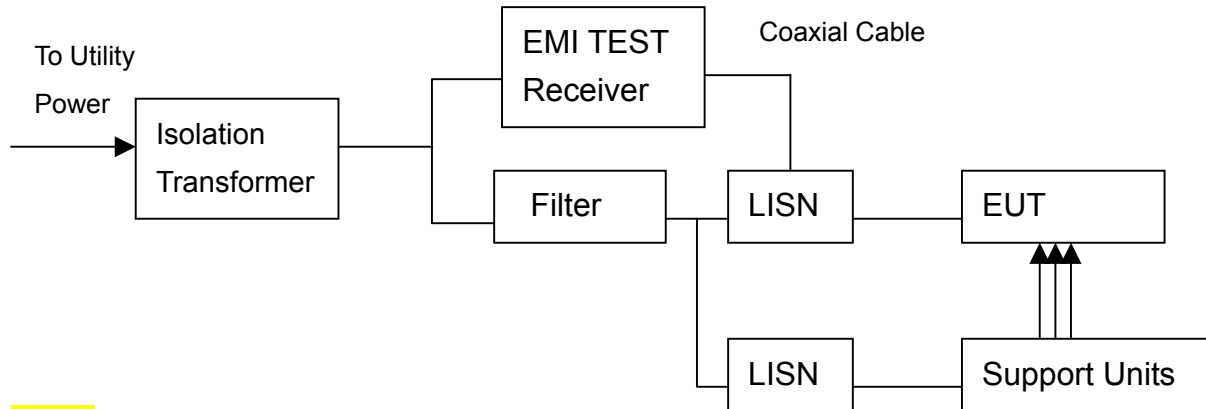

NOTE:

1. The EUT was put on a wooden table with 0.8m heights above ground plane, and 0.4m away from reference ground plane (> 2mx2m).
2. For the actual test configuration, please refer to the photos of testing.
3. The serial no. of the LISN connected to EUT is 951318.
4. The serial no. of the LISN connected to support units is 924839.

4.1.4 TEST PROCEDURE

The EUT was tested according to the requirement of ANSI C63.4:2003 and CISRP22:2003. The frequency spectrum from 0.15 MHz to 30 MHz was investigated. The LISN used was 50 ohm/50 μ H as specified. All readings were quasi-peak and average values with 10 kHz resolution bandwidth of the test receiver. The EUT system was operated in all typical methods by users. Both lines of the power mains of EUT were measured and the cables connected to EUT and support units were moved to find the maximum emission levels for each frequency.

First, find the margin or higher points at least 6 points by software, then use manual to find the maximum data. The procedure is referred on the test procedure of SRT LAB.

4.1.5 EUT OPERATING CONDITION

1. Set the EUT under transmission condition continuously at a specific channel frequency.



TEST REPORT

4.1.6 TEST RESULT

Temperature:	25°C	Humidity:	62 %RH
Ferquency Range:	0.15 – 30 MHz	Tested Mode:	Link
Receiver Detector:	Q.P. and AV.	Tested By:	Julian Chiang
		Tested Date:	Dec. 18, 2005

Power Line Measured : Line

Freq. (MHz)	Correct. Factor (dB)	Reading Value (dB μ V)		Emission Level (dB μ V)		Limit (dB μ V)		Margin (dB)	
		Q.P.	AV.	Q.P.	AV.	Q.P.	AV.	Q.P.	AV.
0.375	0.27	45.98	41.36	46.25	41.63	58.37	48.37	-12.12	-6.740
0.468	0.26	43.34	38.59	43.60	38.85	56.53	46.53	-12.94	-7.690
1.873	0.12	37.30	33.47	37.42	33.59	56.00	46.00	-18.58	-12.41
2.061	0.11	37.04	33.93	37.15	34.04	56.00	46.00	-18.85	-11.96
10.735	0.10	35.36	34.37	35.46	34.47	60.00	50.00	-24.54	-15.53
18.177	0.10	14.00	7.96	14.10	8.06	60.00	50.00	-45.90	-41.94

Power Line Measured : Neutral

Freq. (MHz)	Correct. Factor (dB)	Reading Value (dB μ V)		Emission Level (dB μ V)		Limit (dB μ V)		Margin (dB)	
		Q.P.	AV.	Q.P.	AV.	Q.P.	AV.	Q.P.	AV.
0.375	0.27	45.80	40.97	46.07	41.24	58.37	48.37	-12.30	-7.130
0.658	0.23	35.04	30.35	35.27	30.58	56.00	46.00	-20.74	-15.43
4.883	0.10	40.08	37.47	40.18	37.57	56.00	46.00	-15.82	-8.430
5.071	0.10	41.66	39.03	41.76	39.13	60.00	50.00	-18.24	-10.87
5.162	0.10	40.76	38.63	40.86	38.73	60.00	50.00	-19.14	-11.27
17.839	0.10	25.90	22.72	26.00	22.82	60.00	50.00	-34.00	-27.18

NOTE :

1. Measurement uncertainty is +/-1.32dB
2. Emission level = Reading value + Correction factor
3. Correction Factor = Cable loss + Insertion loss of LISN
4. Margin value = Emission level - Limit
5. The emission of other frequencies were very low against the limit.
6. "-": The Quasi-peak reading value also meets average limit and measurement with the average detector is unnecessary.



TEST REPORT

Temperature: 25°C Humidity: 62 %RH
 Frequency Range: 0.15 – 30 MHz Tested Mode: CH0
 Receiver Detector: Q.P. and AV. Tested By: Julian Chiang
 Tested Date: Dec. 18, 2005

Power Line Measured : Line

Freq. (MHz)	Correct. Factor (dB)	Reading Value (dB μ V)		Emission Level (dB μ V)		Limit (dB μ V)		Margin (dB)	
		Q.P.	AV.	Q.P.	AV.	Q.P.	AV.	Q.P.	AV.
0.375	0.27	46.14	41.59	46.41	41.86	58.37	48.37	-11.96	-6.510
0.658	0.23	35.90	30.74	36.13	30.97	56.00	46.00	-19.88	-15.04
1.784	0.12	35.54	32.27	35.66	32.39	56.00	46.00	-20.34	-13.61
2.160	0.11	37.82	33.61	37.93	33.72	56.00	46.00	-18.07	-12.28
10.735	0.10	37.78	21.43	37.88	21.53	60.00	50.00	-22.12	-28.47
17.901	0.10	26.00	16.93	26.10	17.03	60.00	50.00	-33.90	-32.97

Power Line Measured : Neutral

Freq. (MHz)	Correct. Factor (dB)	Reading Value (dB μ V)		Emission Level (dB μ V)		Limit (dB μ V)		Margin (dB)	
		Q.P.	AV.	Q.P.	AV.	Q.P.	AV.	Q.P.	AV.
0.375	0.27	45.92	41.26	46.19	41.53	58.37	48.37	-12.18	-6.840
0.658	0.23	35.58	30.31	35.81	30.54	56.00	46.00	-20.20	-15.47
1.972	0.11	35.66	31.62	35.77	31.73	56.00	46.00	-20.23	-14.27
10.755	0.10	39.96	32.41	40.06	32.51	60.00	50.00	-19.94	-17.49
10.816	0.10	35.08	31.58	35.18	31.68	60.00	50.00	-24.82	-18.32
17.901	0.10	23.48	21.18	23.58	21.28	60.00	50.00	-36.42	-28.72

NOTE :

1. Measurement uncertainty is +/-1.32dB
2. Emission level = Reading value + Correction factor
3. Correction Factor = Cable loss + Insertion loss of LISN
4. Margin value = Emission level - Limit
5. The emission of other frequencies were very low against the limit.
6. "-": The Quasi-peak reading value also meets average limit and measurement with the average detector is unnecessary.



TEST REPORT

Temperature: 25°C Humidity: 62 %RH
 Frequency Range: 0.15 – 30 MHz Tested Mode: CH9
 Receiver Detector: Q.P. and AV. Tested By: Julian Chiang
 Tested Date: Dec. 18, 2005

Power Line Measured : Line

Freq. (MHz)	Correct. Factor (dB)	Reading Value (dB μ V)		Emission Level (dB μ V)		Limit (dB μ V)		Margin (dB)	
		Q.P.	AV.	Q.P.	AV.	Q.P.	AV.	Q.P.	AV.
0.375	0.27	46.18	41.51	46.45	41.78	58.37	48.37	-11.92	-6.590
0.658	0.23	35.24	30.51	35.47	30.74	56.00	46.00	-20.54	-15.27
1.784	0.12	35.46	32.07	35.58	32.19	56.00	46.00	-20.42	-13.81
2.160	0.11	38.64	34.37	38.75	34.48	56.00	46.00	-17.25	-11.52
6.106	0.10	29.16	22.44	29.26	22.54	60.00	50.00	-30.74	-27.46
6.198	0.10	31.34	25.00	31.44	25.10	60.00	50.00	-28.56	-24.90

Power Line Measured : Neutral

Freq. (MHz)	Correct. Factor (dB)	Reading Value (dB μ V)		Emission Level (dB μ V)		Limit (dB μ V)		Margin (dB)	
		Q.P.	AV.	Q.P.	AV.	Q.P.	AV.	Q.P.	AV.
0.378	0.27	45.76	41.03	46.03	41.30	58.31	48.31	-12.28	-7.010
0.658	0.23	35.24	30.86	35.47	31.09	56.00	46.00	-20.54	-14.92
4.794	0.10	36.96	33.27	37.06	33.37	56.00	46.00	-18.94	-12.63
4.883	0.10	40.34	38.13	40.44	38.23	56.00	46.00	-15.56	-7.770
10.735	0.10	43.76	38.51	43.86	38.61	60.00	50.00	-16.14	-11.39
17.901	0.10	20.50	17.18	20.60	17.28	60.00	50.00	-39.40	-32.72

NOTE :

1. Measurement uncertainty is +/-1.32dB
2. Emission level = Reading value + Correction factor
3. Correction Factor = Cable loss + Insertion loss of LISN
4. Margin value = Emission level - Limit
5. The emission of other frequencies were very low against the limit.
6. "-": The Quasi-peak reading value also meets average limit and measurement with the average detector is unnecessary.



TEST REPORT

Temperature:	<u>25°C</u>	Humidity:	<u>62 %RH</u>
Ferquency Range:	<u>0.15 – 30 MHz</u>	Tested Mode:	<u>CH19</u>
Receiver Detector:	<u>Q.P. and AV.</u>	Tested By:	<u>Julian Chiang</u>
		Tested Date:	<u>Dec. 18, 2005</u>

Power Line Measured : Line

Freq. (MHz)	Correct. Factor (dB)	Reading Value (dB μ V)		Emission Level (dB μ V)		Limit (dB μ V)		Margin (dB)	
		Q.P.	AV.	Q.P.	AV.	Q.P.	AV.	Q.P.	AV.
0.375	0.27	45.92	41.01	46.19	41.28	58.37	48.37	-12.18	-7.090
0.471	0.26	43.92	39.29	44.18	39.55	56.48	46.48	-12.31	-6.940
2.160	0.11	38.16	34.25	38.27	34.36	56.00	46.00	-17.73	-11.64
3.576	0.10	36.14	32.78	36.24	32.88	56.00	46.00	-19.76	-13.12
6.106	0.10	30.36	23.55	30.46	23.65	60.00	50.00	-29.54	-26.35
17.880	0.10	13.54	5.54	13.64	5.64	60.00	50.00	-46.36	-44.36

Power Line Measured : Neutral

Freq. (MHz)	Correct. Factor (dB)	Reading Value (dB μ V)		Emission Level (dB μ V)		Limit (dB μ V)		Margin (dB)	
		Q.P.	AV.	Q.P.	AV.	Q.P.	AV.	Q.P.	AV.
0.378	0.27	49.22	44.67	49.49	44.94	58.31	48.31	-8.82	-3.370
0.658	0.23	40.00	34.99	40.23	35.22	56.00	46.00	-15.78	-10.79
1.685	0.13	32.38	26.86	32.51	26.99	56.00	46.00	-23.49	-19.01
2.160	0.11	43.48	39.18	43.59	39.29	56.00	46.00	-12.41	-6.710
10.735	0.10	47.54	33.28	47.64	33.38	60.00	50.00	-12.36	-16.62
18.598	0.10	25.38	20.00	25.48	20.10	60.00	50.00	-34.52	-29.90

NOTE :

1. Measurement uncertainty is +/-1.32dB
2. Emission level = Reading value + Correction factor
3. Correction Factor = Cable loss + Insertion loss of LISN
4. Margin value = Emission level - Limit
5. The emission of other frequencies were very low against the limit.
6. "-": The Quasi-peak reading value also meets average limit and measurement with the average detector is unnecessary.



4.2 TECHNICAL CHARACTERISTICS TEST

4.2.1 6dB Bandwidth

4.2.2 LIMIT

Frequency Range (MHz)	Quantity of Hopping Channel	Limit(kHz)			
		50	25	15	75
902-928		<250	>250	NA	NA
2400-2483.5		NA	NA	>1000	<1000

4.2.3 TEST EQUIPMENT

The following test equipment was used during the test:

EQUIPMENT/FACILITIES	SPECIFICATIONS	MANUFACTURER	MODEL#/SERIAL#	DUE DATE OF CAL. & CAL. CENTER
SPECTRUM	9kHz-7GHz	ROHDE & SCHWARZ	FSP7/ 839511/010	APR. 2006 R&S

NOTE: The calibration interval of the above test equipment is one year and the calibrations are traceable to NML/ROC and NIST/USA.

4.2.4 TEST SET-UP

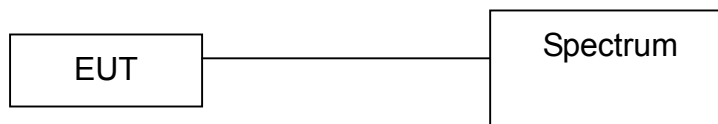

The EUT was connected to a spectrum through a 50Ω RF cable.

4.2.4 TEST PROCEDURE

The EUT was operating in hopping mode or could be controlled its channel. Printed out the test result from the spectrum by hard copy function.

4.2.5 EUT OPERATING CONDITION

1. Set the EUT under transmission condition continuously at a specific channel frequency.



Spectrum Research & Testing Lab., Inc.
 No. 101-10, Ling 8,
 Shan-Tong Li, Chung-Li
 City, Taoyuan, Taiwan

TEST REPORT

Reference No.:A05101406
 Report No.:FCCA05101406
 FCCID: FSUGG000B
 Page:14 of 54
 Date:Jan. 04, 2006

4.2.6 TEST RESULT

Temperature:	<u>25°C</u>	Humidity:	<u>60%RH</u>
Spectrum Detector:	<u>PK</u>	Tested by:	<u>Julian Chiang</u>
Test Result:	<u>PASS</u>	Tested Date:	<u>Dec. 16, 2005</u>
Test Mode:	<u>TX (Game Pad)</u>		

CHANNEL NUMBER	CHANNEL FREQUENCY (MHz)	6dB DOWN BW (MHz)
0	2402	1.724
9	2440	1.748
19	2481	1.756

CH0, 2402MHz

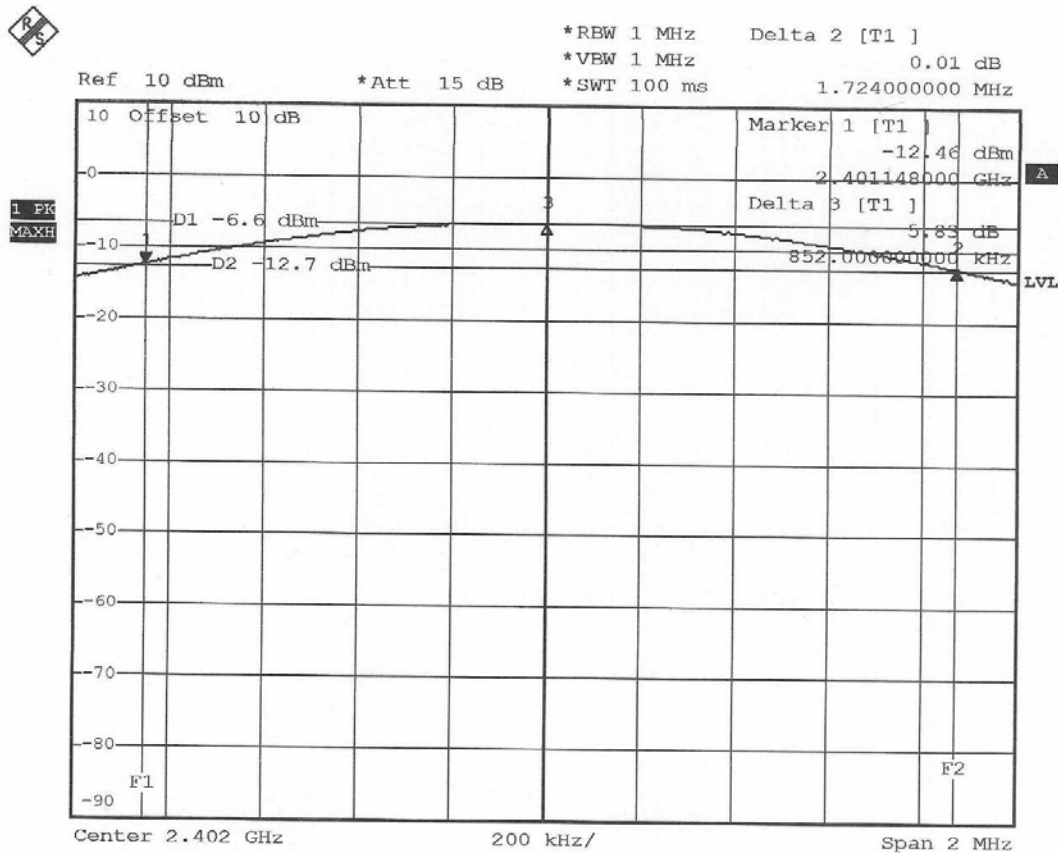



CH9, 2440MHz

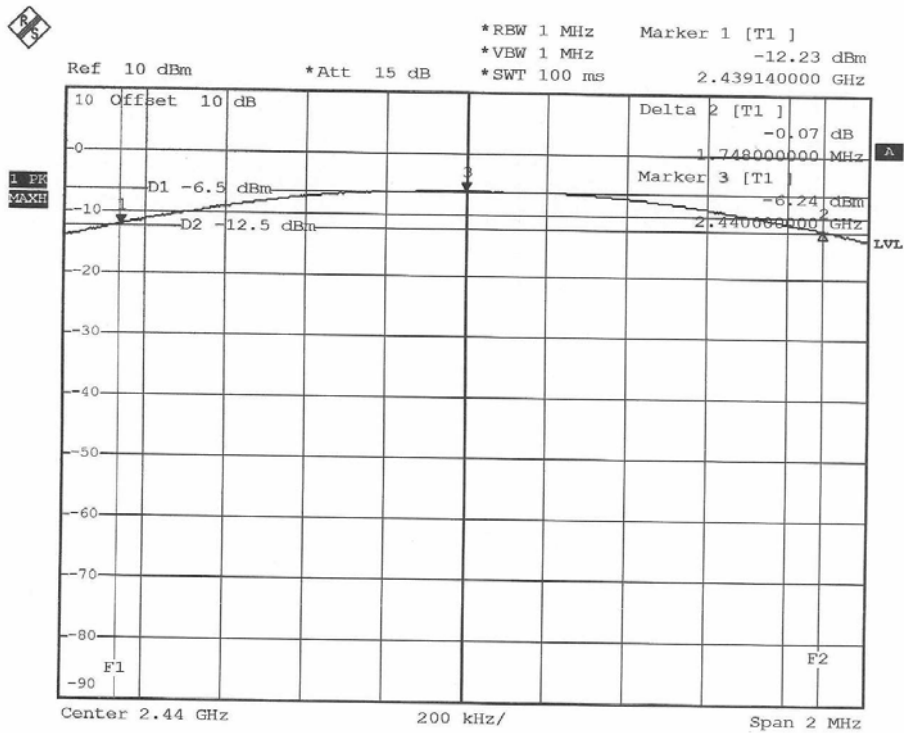

CH19, 2481MHz

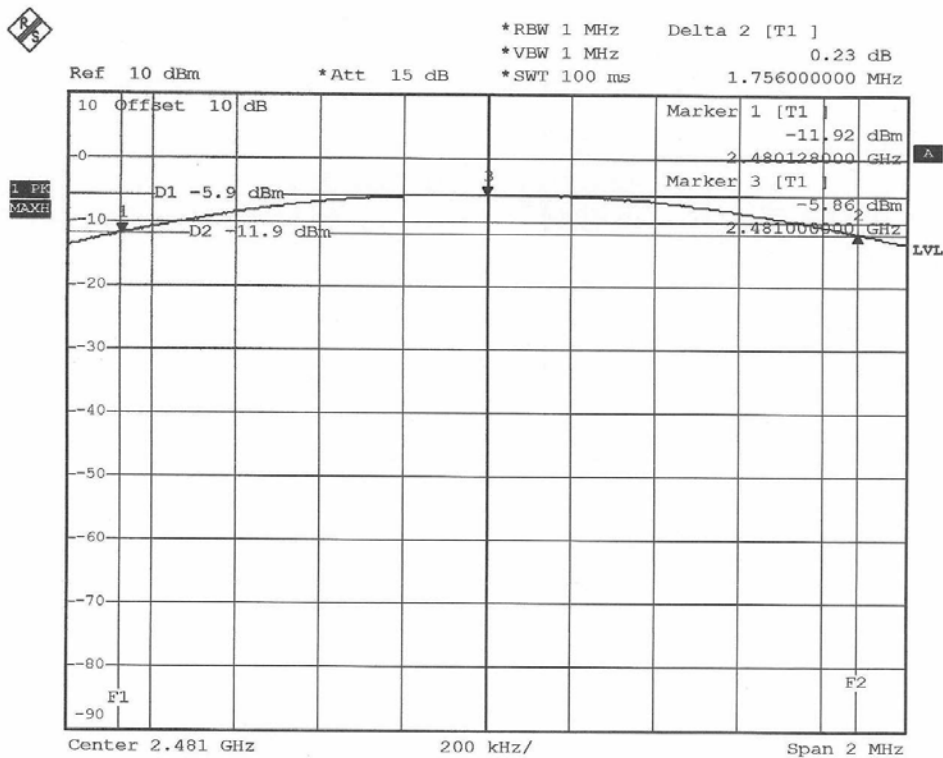



Spectrum Research & Testing Lab., Inc.
 No. 101-10, Ling 8,
 Shan-Tong Li, Chung-Li
 City, Taoyuan, Taiwan

TEST REPORT

Reference No.:A05101406
 Report No.:FCCA05101406
 FCCID: FSUGG000B
 Page:16 of 54
 Date:Jan. 04, 2006

Temperature:	<u>25°C</u>	Humidity:	<u>60%RH</u>
Spectrum Detector:	<u>PK</u>	Tested by:	<u>Julian Chiang</u>
Test Result:	<u>PASS</u>	Tested Date:	<u>Dec. 16, 2005</u>
Test Mode:	<u>TX (Receiver)</u>		

CHANNEL NUMBER	CHANNEL FREQUENCY (MHz)	6dB DOWN BW (MHz)
0	2402	1.568
9	2440	1.560
19	2481	1.528

CH0, 2402MHz

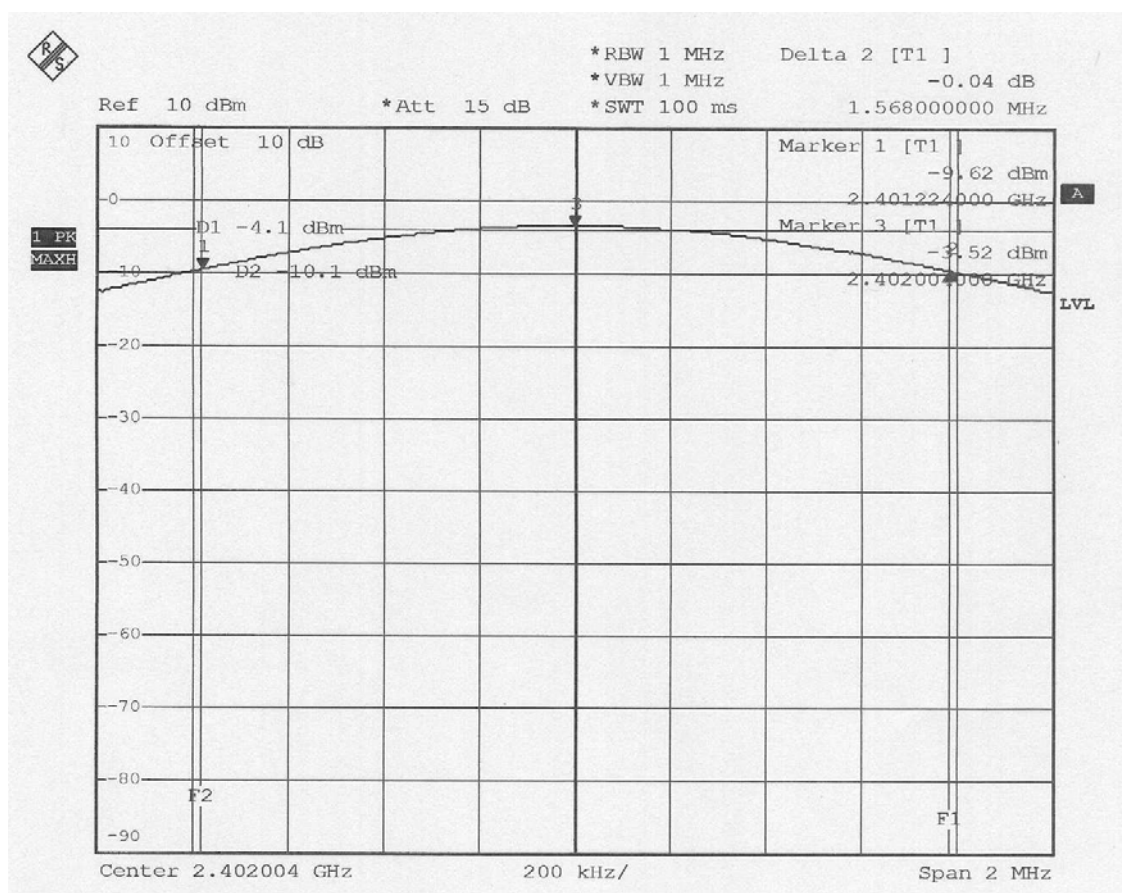



CH9, 2440MHz

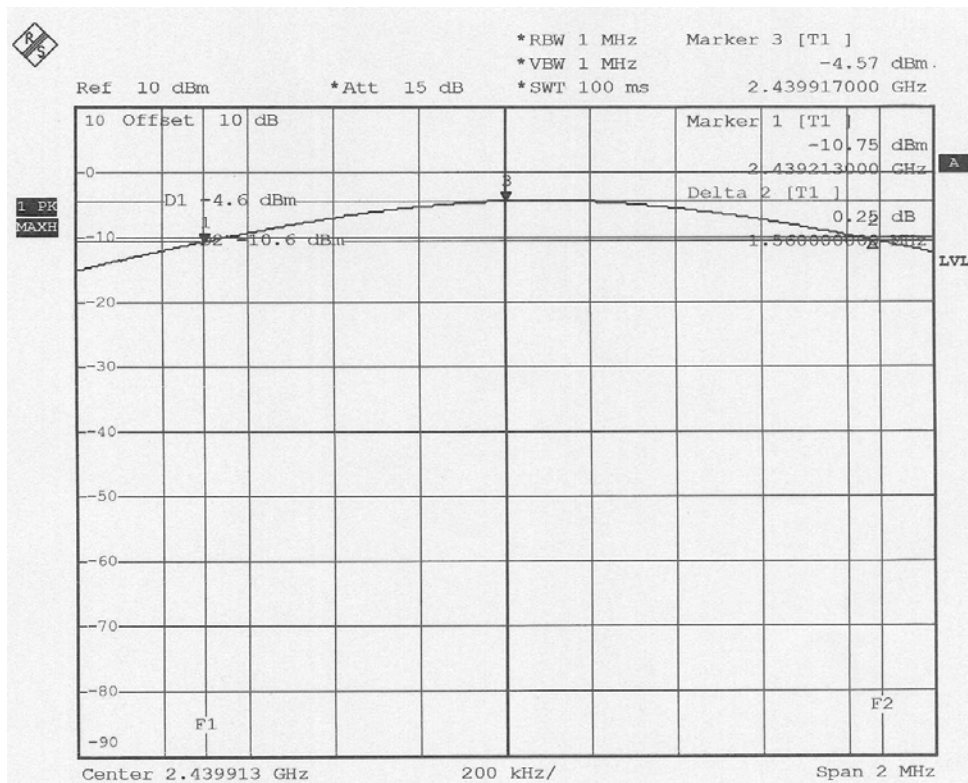

CH19, 2481MHz

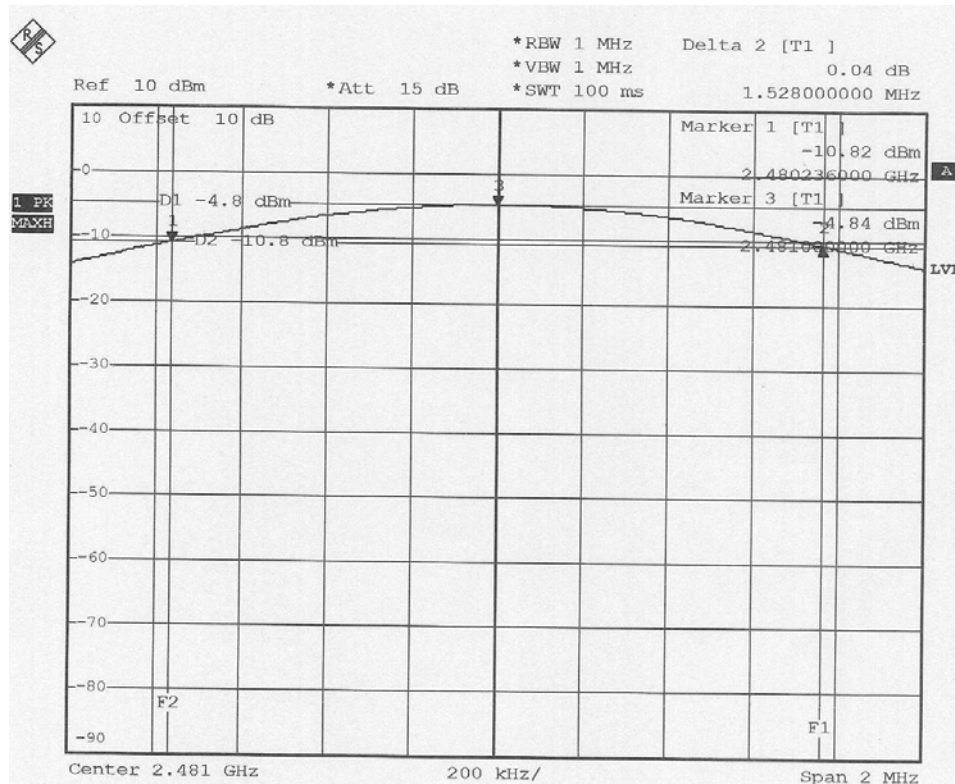



4.3 PEAK POWER TEST

4.3.1 LIMIT

FCC Part15, Subpart C Section 15.247.

FREQUENCY RANGE (MHz)	LIMIT (W)				
	Quantity of Hopping Channel	50	25	15	75
902-928		1(30dBm)	0.125(21dBm)	NA	NA
2400-2483.5		NA	NA	0.125(21dBm)	1(30dBm)
5725-5850		NA	NA	NA	1(30dBm)

4.3.2 TEST EQUIPMENT

The following test equipment was used during the test :

EQUIPMENT/FACILITIES	SPECIFICATIONS	MANUFACTURER	MODEL#/SERIAL#	DUE DATE OF CAL. & CAL. CENTER
SPECTRUM	9kHz-7GHz	ROHDE & SCHWARZ	FSP7/ 839511/010	APR. 2006 R&S
POWER METER	N/A	BOONTON	4232A/ 29001	MAY 2006 ETC
POWER SENSOR	DC-18GHz 0.3 μ W-100mW 50 Ω	BOONTON	51011-EMC/ 31184	JUN. 2006 ETC

NOTE: The calibration interval of the above test equipment is one year and the calibrations are traceable to NML/ROC and NIST/USA.



4.3.3 TEST SET-UP

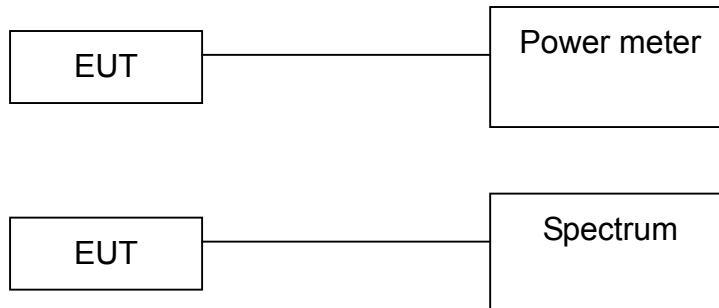

The EUT was connected to a spectrum through a 50 Ω RF cable.

4.3.4 TEST PROCEDURE

The EUT was operating in hopping mode or could control its channel.
Printed out the test result from the spectrum by hard copy function.
Recorded the read value of the power meter.

4.3.5 EUT OPERATING CONDITION

Same as section 4.1.5 of this report.



Spectrum Research & Testing Lab., Inc.
 No. 101-10, Ling 8,
 Shan-Tong Li, Chung-Li
 City, Taoyuan, Taiwan

TEST REPORT

Reference No.:A05101406
 Report No.:FCCA05101406
 FCCID: FSUGG000B
 Page:20 of 54
 Date:Jan. 04, 2006

4.3.6 TEST RESULT

Temperature:	<u>26°C</u>	Humidity:	<u>61%RH</u>
Spectrum Detector:	<u>PK</u>	Tested by:	<u>Julian Chiang</u>
Test Result:	<u>PASS</u>	Tested Date:	<u>Dec. 16, 2005</u>
Test Mode:	<u>TX (Game Pad)</u>		

CHANNEL NUMBER	CHANNEL FREQUENCY (MHz)	PEAK POWER OUTPUT (dBm)	PEAK POWER LIMIT (dBm)
0	2402.0000	-4.54	30
9	2440.0000	-4.69	30
19	2481.0000	-4.92	30

Ch0, 2402MHz

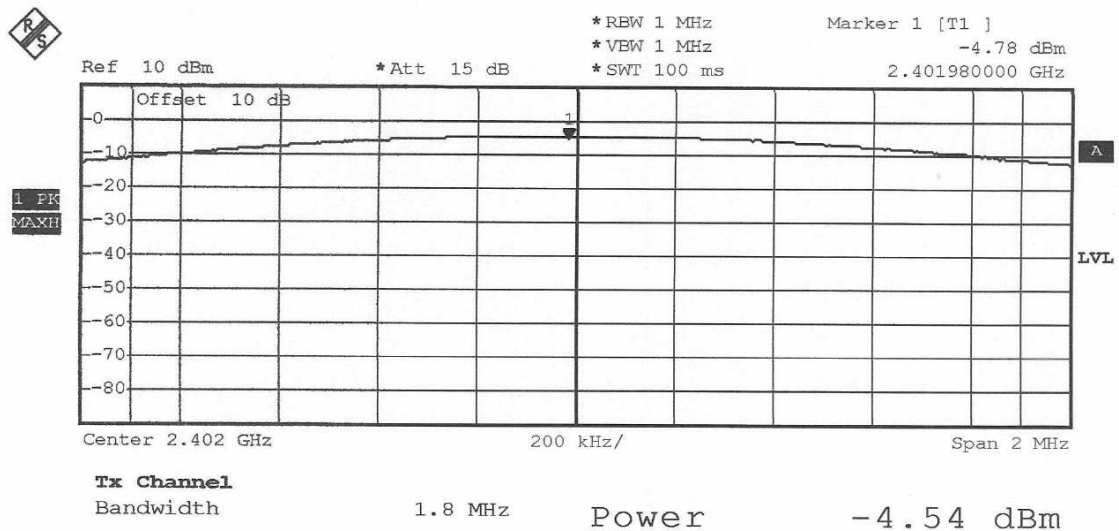



Ch9, 2440MHz

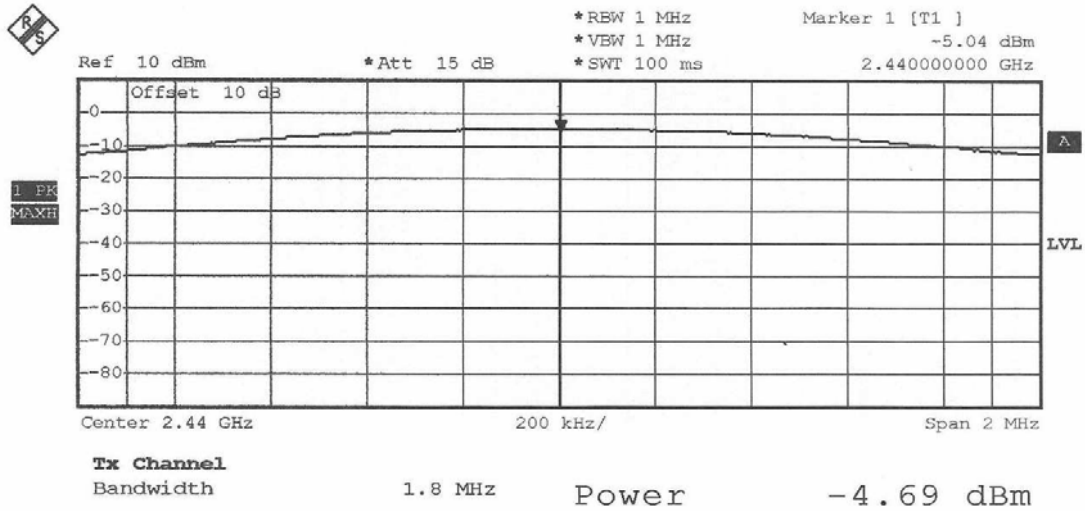

Ch19, 2481MHz

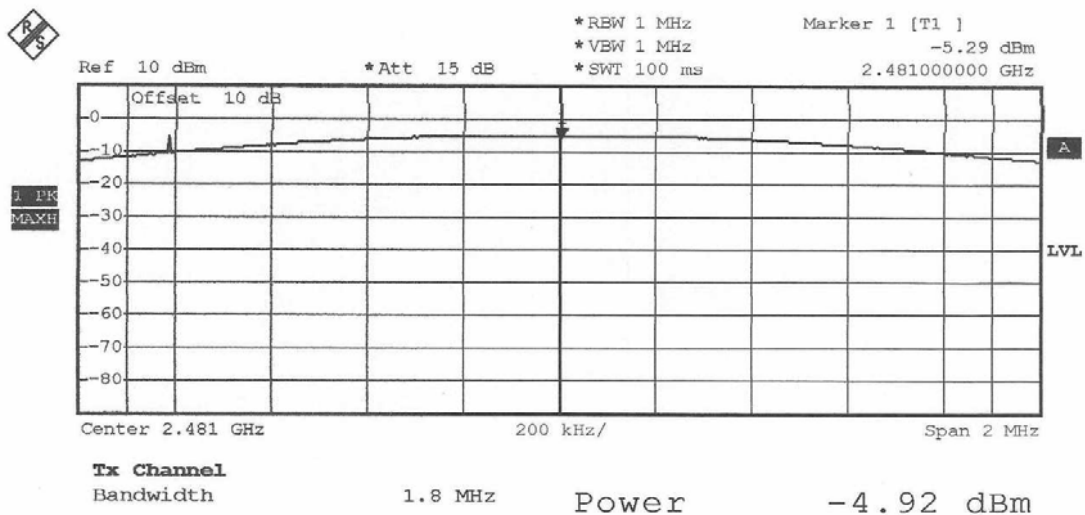



Spectrum Research & Testing Lab., Inc.
 No. 101-10, Ling 8,
 Shan-Tong Li, Chung-Li
 City, Taoyuan, Taiwan

TEST REPORT

Reference No.:A05101406
 Report No.:FCCA05101406
 FCCID: FSUGG000B
 Page:22 of 54
 Date:Jan. 04, 2006

Temperature:	<u>26°C</u>	Humidity:	<u>61%RH</u>
Spectrum Detector:	<u>PK</u>	Tested by:	<u>Julian Chiang</u>
Test Result:	<u>PASS</u>	Tested Date:	<u>Dec. 16, 2005</u>
Test Mode:	<u>TX (Receiver)</u>		

CHANNEL NUMBER	CHANNEL FREQUENCY (MHz)	PEAK POWER OUTPUT (dBm)	PEAK POWER LIMIT (dBm)
0	2402.0000	-4.47	30
9	2440.0000	-4.60	30
19	2481.0000	-4.88	30

Ch0, 2402MHz

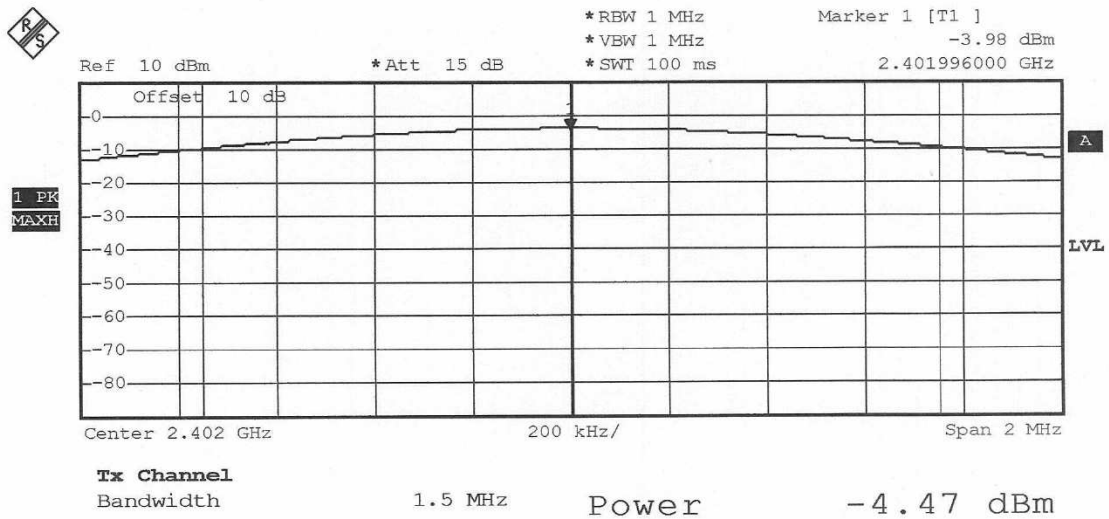



Ch9, 2440MHz

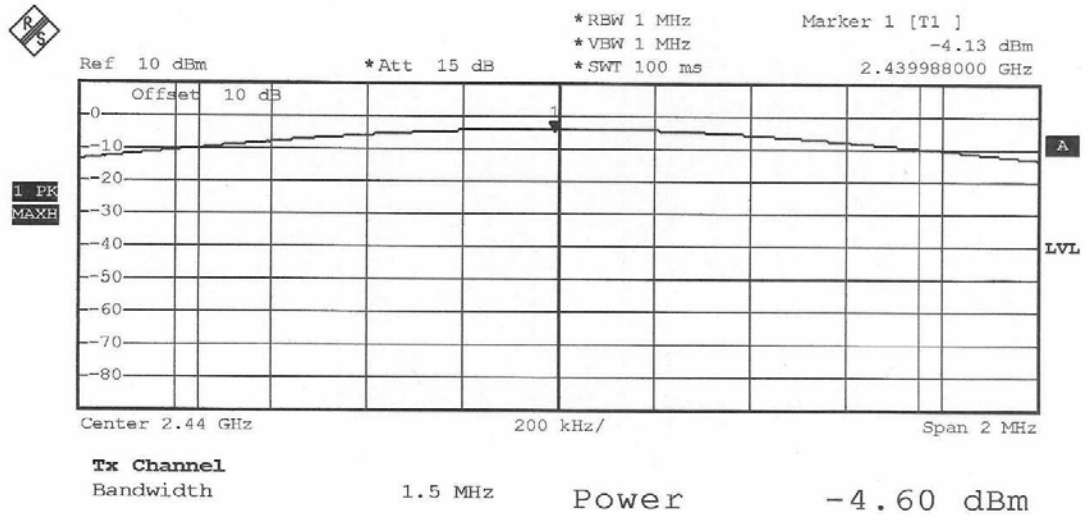

Ch19, 2481MHz

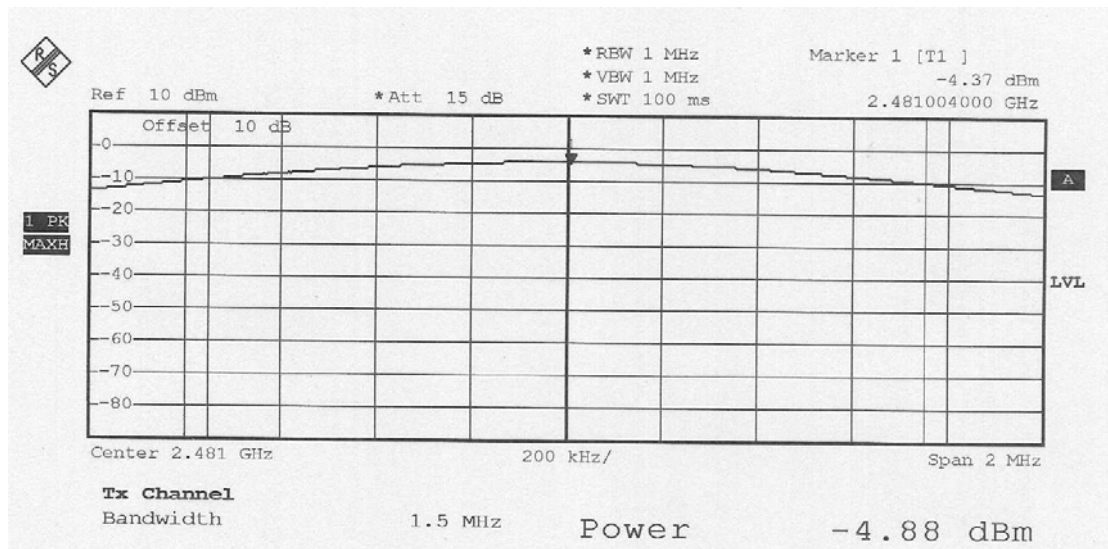



4.4 BAND EDGE TEST

4.4.1 LIMIT

FCC Part15, Subpart C Section 15.247. In any 100 kHz bandwidth outside the frequency band in which the spread spectrum intentional radiator is operating, the radio frequency power that is produced by the intentional radiator shall be at least 20 dB below that in the 100 kHz bandwidth within the band that contains the highest level of the desired power, based on either an RF conducted or a radiated measurement. Attenuation below the general limits specified in Section 15.209(a) is not required. In addition, radiated emissions which fall in the restricted bands, as defined in Section 15.205(a), must also comply with the radiated emission limits specified in Section 15.209(a) (see Section 15.205(c)).

OPERATING FREQUENCY RANGE (MHz)	SPURIOUS EMISSION FREQUENCY (MHz)	LIMIT	
		Peak power ration to emission(dBc)	Emission level(dBuV/m)
902-928	<902	>20	NA
	>928	>20	NA
	960-1240	NA	54
2400-2483.5	<2400	>20	NA
	>2483.5-2500	NA	54
5725-5850	<5350-5460	NA	54
	<5725	>20	NA
	>5850	>20	NA



Spectrum Research & Testing Lab., Inc.
No. 101-10, Ling 8,
Shan-Tong Li, Chung-Li
City, Taoyuan, Taiwan

TEST REPORT

Reference No.:A05101406
Report No.:FCCA05101406
FCCID: FSUGG000B
Page:25 of 54
Date:Jan. 04, 2006

4.4.2 TEST EQUIPMENT

The following test equipment was used during the test :

EQUIPMENT/ FACILITIES	SPECIFICATIONS	MANUFACTURER	MODEL#/ SERIAL#	DUE DATE OF CAL. & CAL. CENTER
SPECTRUM	9kHz-7GHz	ROHDE & SCHWARZ	FSP7/ 839511/010	APR. 2006 R&S
EMI TEST RECEIVER	9 kHz TO 2750 MHz	ROHDE & SCHWARZ	ESCS30/ 830245/012	OCT. 2006 ETC
SPECTRUM	9KHz-26.5GHz	HP	8953E/ 3710A03220	MAY 2006 ETC
PRE-AMPLIFIER	1GHz-26.5GHz Gain:30dB	HP	8449B/ 3008A01019	NOV. 2006 ETC
BI-LOG ANTENNA	25 MHz TO 2 GHz	EMCO	3142/ 9701-1124	FEB. 2006 SRT
HORN ANTENNA	1GHz to 18GHz	EMCO	3115/ 9602-4681	DEC. 2006 ETC
OATS	3 - 10 M measurement	SRT	SRT-1	APR. 2006 SRT

NOTE: The calibration interval of the above test equipment is one year and the calibrations are traceable to NML/ROC and NIST/USA.



4.4.3 TEST SET-UP

FOR RF CONDUCTED TEST (dBc)

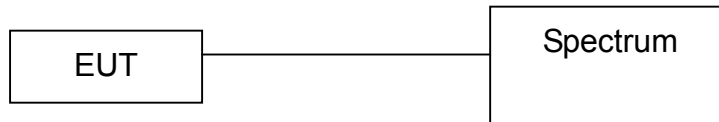

The EUT was connected to the spectrum through a 50 Ω RF cable.

FOR RADIATED EMISSION TEST

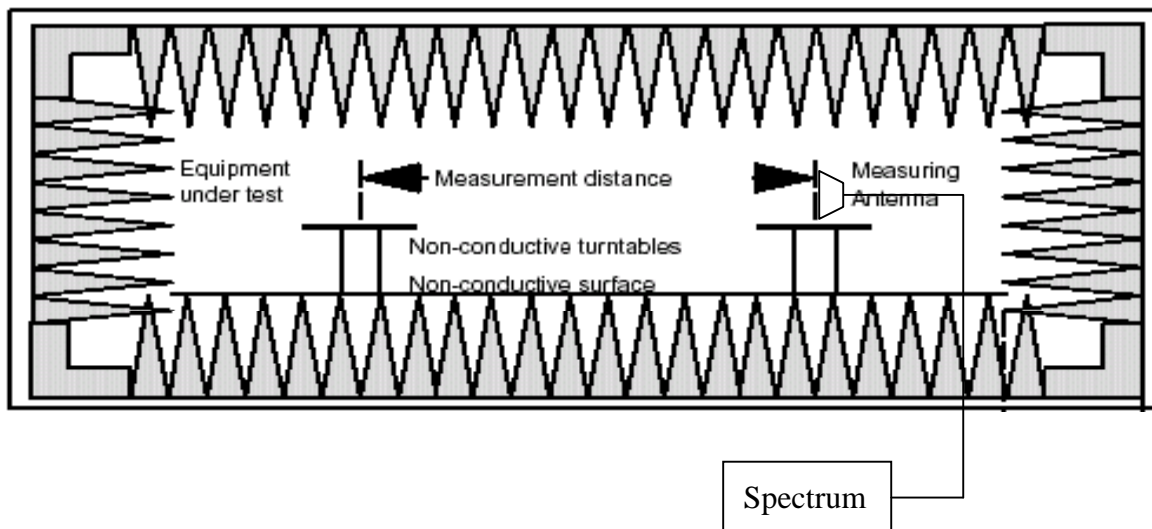

NOTE :

1. The EUT system was put on a wooden table with 0.8m heights above a ground plane.
2. For the actual test configuration, please refer to the photos of testing.



4.4.4 TEST PROCEDURE

1. The EUT was operating in hopping mode or could be controlled its channel.
Printed out the test result from the spectrum by hard copy function.
2. The EUT was tested according to the requirement of ANSI C63.4 and CISPR 22.
The measurements were made at an open area test site with 10 meter measurement distance under 1 GHz and with 3m distance above 1GHz. The frequency spectrum measured started from 30 MHz. Under 1 GHz. All readings were quasi-peak values with 120 kHz resolution bandwidth of the test receiver. Above 1 GHz, the measurements were made at an open area test site with 3 meter measurement distance and all readings were peak and average values with 1 MHz resolution bandwidth of the test receiver. The EUT system was operated in all typical methods by users. The cables connected to EUT and support units were moved to find the maximum emission levels for each frequency.

4.4.5 EUT OPERATING CONDITION

Same as section 4.1.5 of this report.



Spectrum Research & Testing Lab., Inc.
 No. 101-10, Ling 8,
 Shan-Tong Li, Chung-Li
 City, Taoyuan, Taiwan

TEST REPORT

Reference No.:A05101406
 Report No.:FCCA05101406
 FCCID: FSUGG000B
 Page:28 of 54
 Date:Jan. 04, 2006

4.4.6 TEST RESULT

Temperature:	<u>26°C</u>	Humidity:	<u>61%RH</u>
Spectrum Detector:	<u>PK & AV</u>	Tested by:	<u>Julian Chiang</u>
Test Result:	<u>PASS</u>	Tested Date:	<u>Dec. 16, 2006</u>
Test Mode:	<u>TX (Game Pad)</u>		

Frequency (MHz)	PEAK POWER OUTPUT (dBm)	Emission read Value(dBm)	Result of Band edge (dBc)	Band edge LIMIT (dBc)
<2400	-6.27	-54.95	48.68	>20dBc
>2480	-7.14	-59.65	52.51	>20dBc

2.Radiated emission test

Frequency (MHz)	Antenna polarization (H/V)	Reading (dBuV)		Emission (dBuV/m)		Band edge Limit (dBuV/m)	
		PK	AV	PK	AV	PK	AV
<2400	H	32.6	*	28.4	*	74.0	54.0
>2483.5	V	33.6	*	29.6	*	74.0	54.0



Ch0

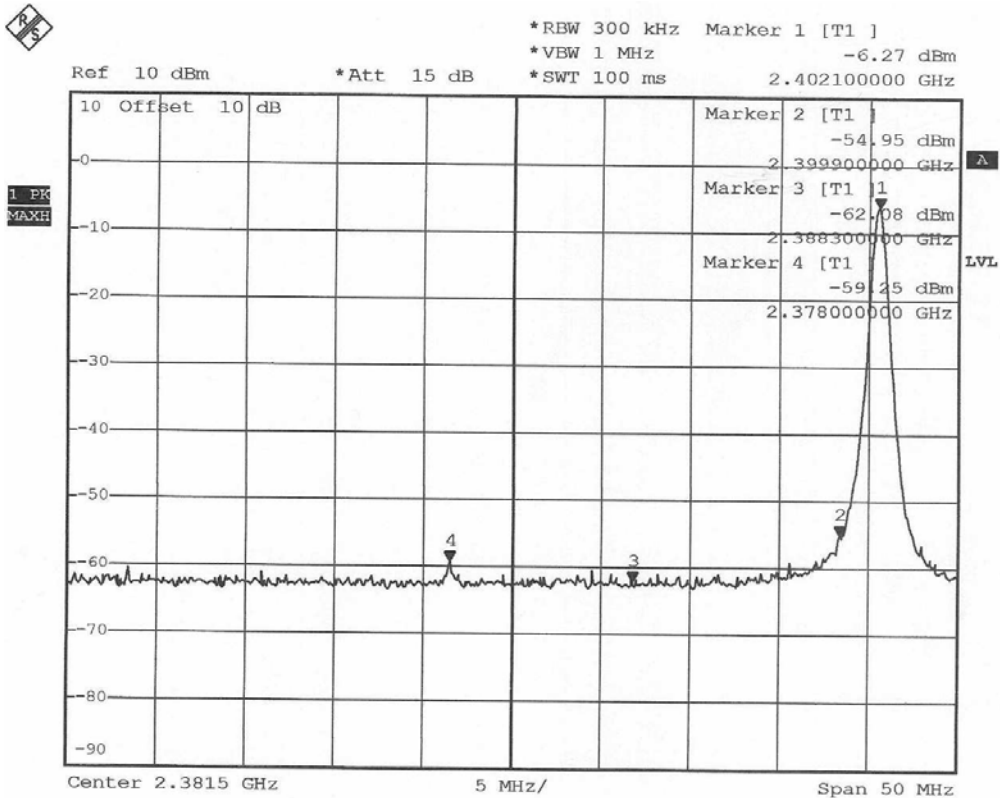

Ch19

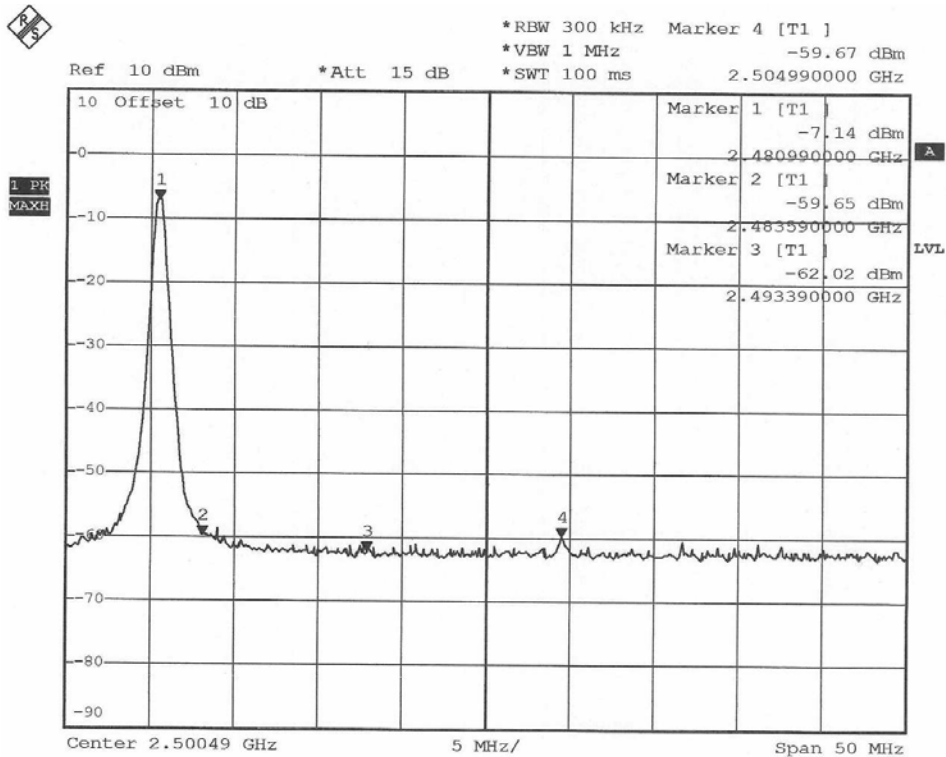



Spectrum Research & Testing Lab., Inc.
No. 101-10, Ling 8,
Shan-Tong Li, Chung-Li
City, Taoyuan, Taiwan

TEST REPORT

Reference No.:A05101406
Report No.:FCCA05101406
FCCID: FSUGG000B
Page:30 of 54
Date:Jan. 04, 2006

Temperature: 26°C Humidity: 61%RH
Spectrum Detector: PK & AV Tested by: Julian Chiang
Test Result: PASS Tested Date: Dec. 16, 2006
Test Mode: TX (Receiver)

Frequency (MHz)	PEAK POWER OUTPUT (dBm)	Emission read Value(dBm)	Result of Band edge (dBc)	Band edge LIMIT (dBc)
<2400	-3.67	-60.69	57.02	>20dBc
>2480	-4.94	-56.80	51.86	>20dBc

2.Radiated emission test

Frequency (MHz)	Antenna polarization (H/V)	Reading (dBuV)		Emission (dBuV/m)		Band edge Limit (dBuV/m)	
		PK	AV	PK	AV	PK	AV
<2400	H	33.62	*	29.4	*	74.0	54.0
>2483.5	V	31.9	*	27.9	*	74.0	54.0



Ch0

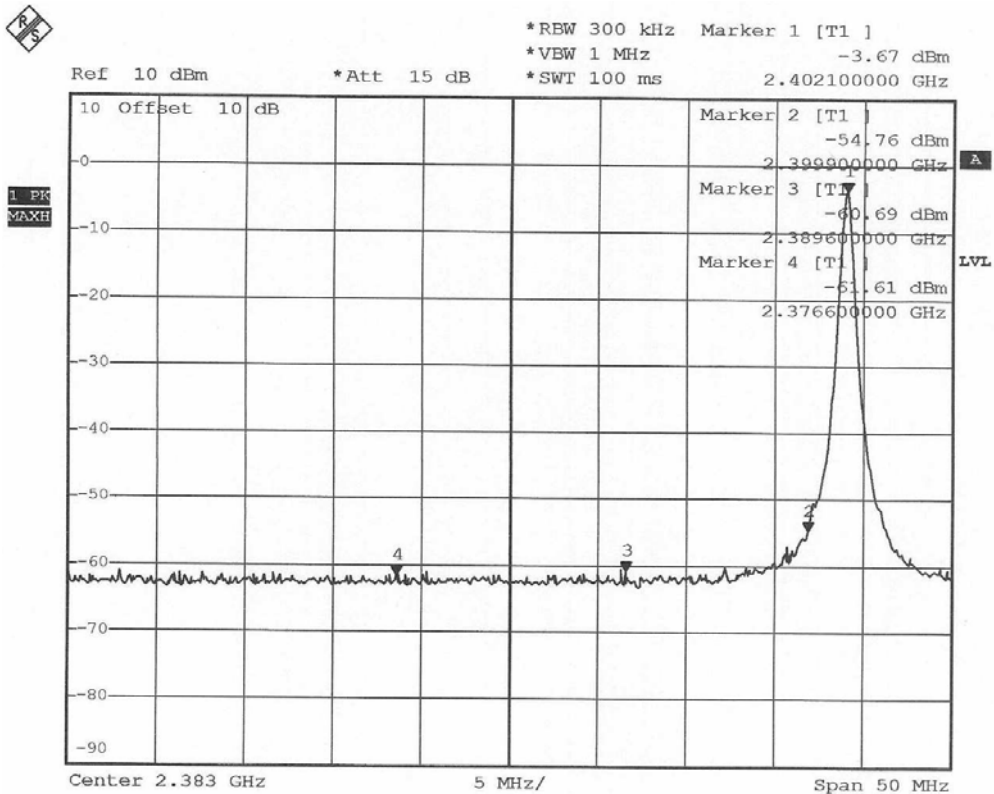

Ch19

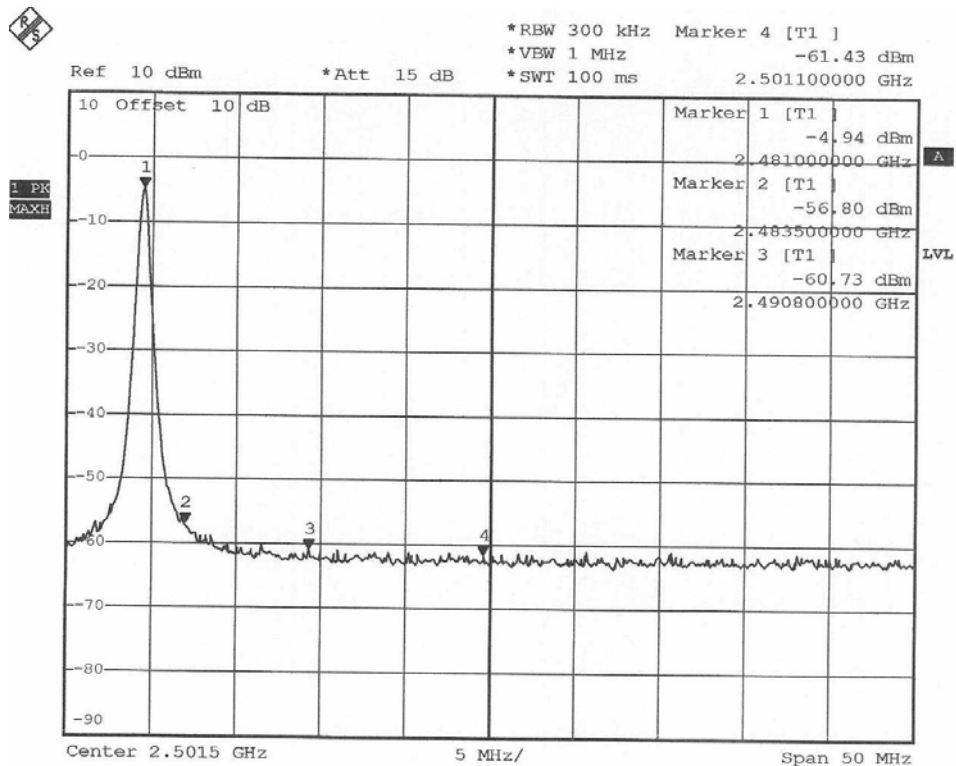



4.5 FUNDAMENTAL & SPURIOUS RADIATED EMISSION TEST

4.5.1 LIMIT

FCC Part15, Subpart C Section 15.209 limit of radiated emission for frequency below1000MHz. The emissions from an intentional radiator shall not exceed the field strength levels specified in the following table:

FREQUENCY (MHz)	DISTANCE (m)	FIELD STRENGTH (dB μ V/m)
30 - 88	3	40.0
88 - 216	3	43.5
216 - 960	3	46.0
ABOVE 960	3	54.0

- NOTE** :
1. In the emission tables above , the tighter limit applies at the band edges.
 2. Distance refers to the distance between measuring instrument , antenna , and the closest point of any part of the device or system.

FCC Part 15, Section15.35(b) limit of radiated emission for frequency above 1000 MHz

FREQUENCY (MHz)	Class A (dBuV/m) (at 3m)		Class B (dBuV/m) (at 3m)	
	PEAK	AVERAGE	PEAK	AVERAGE
Above 1000	80.0	60.0	74.0	54.0

FCC Part 15, Subpart C Section 15.249. The field strength of emissions from intentional radiators operated within these frequency bands shall comply with the following:

FUNDAMENTAL FREQUENCY (MHz)	FILED STRENGTH OF FUNDAMENTAL (dBuV/m) (at 3m)		FIELD STRENGTH OF HARMONICS (dBuV/m) (at 3m)	
	PEAK	AVERAGE	PEAK	AVERAGE
902-928	114	94	74.0	54.0
2400-2483.5	114	94	74.0	54.0
5725-5875	114	94	74.0	54.0
24000-24250	128	108	88.0	68.0



4.5.2 TEST EQUIPMENT

The following test equipment was used during the radiated emission test :

EQUIPMENT/ FACILITIES	SPECIFICATIONS	MANUFACTURER	MODEL#/ SERIAL#	DUE DATE OF CAL. & CAL. CENTER
EMI TEST RECEIVER	20 kHz TO 1 GHz	ROHDE & SCHWARZ	ESCS30/ 830245/012	OCT. 2006 ETC
BI-LOG ANTENNA	25 MHz TO 2 GHz	EMCO	3142/ 9701-1124	FEB. 2006 SRT
OATS	3 – 10 M MEASUREMENT	SRT	SRT-1	DEC. 2006 SRT
COAXIAL CABLE	25M	SUNCITY	J400/ 25M	AUG. 2006 SRT
FILTER	2 LINE, 30A	FIL.COIL	FC-943/ 869	N/A
FREQUENCY CONVERTER	N/A	APC	AFC-2KBB/ F100030031	AUG. 2006 SRT
DOUBLE RIDGE WAVEGUIDE ANTENNA	18-40G	EST-CINDGREN	3116/00032255	NOV. 2006 SRT

NOTE:

1. The calibration interval of the above test equipment is one year and the calibrations are traceable to NML/ROC and NIST/USA.
2. The Open Area Test Site (SRT-1) is registered by FCC with No. 90957 and VCCI with No. R-1081.
3. The Open Area Test Site (SRT-2) is registered by FCC with No. 98458 and VCCI with No. R-1168.



4.5.3 TEST SET-UP

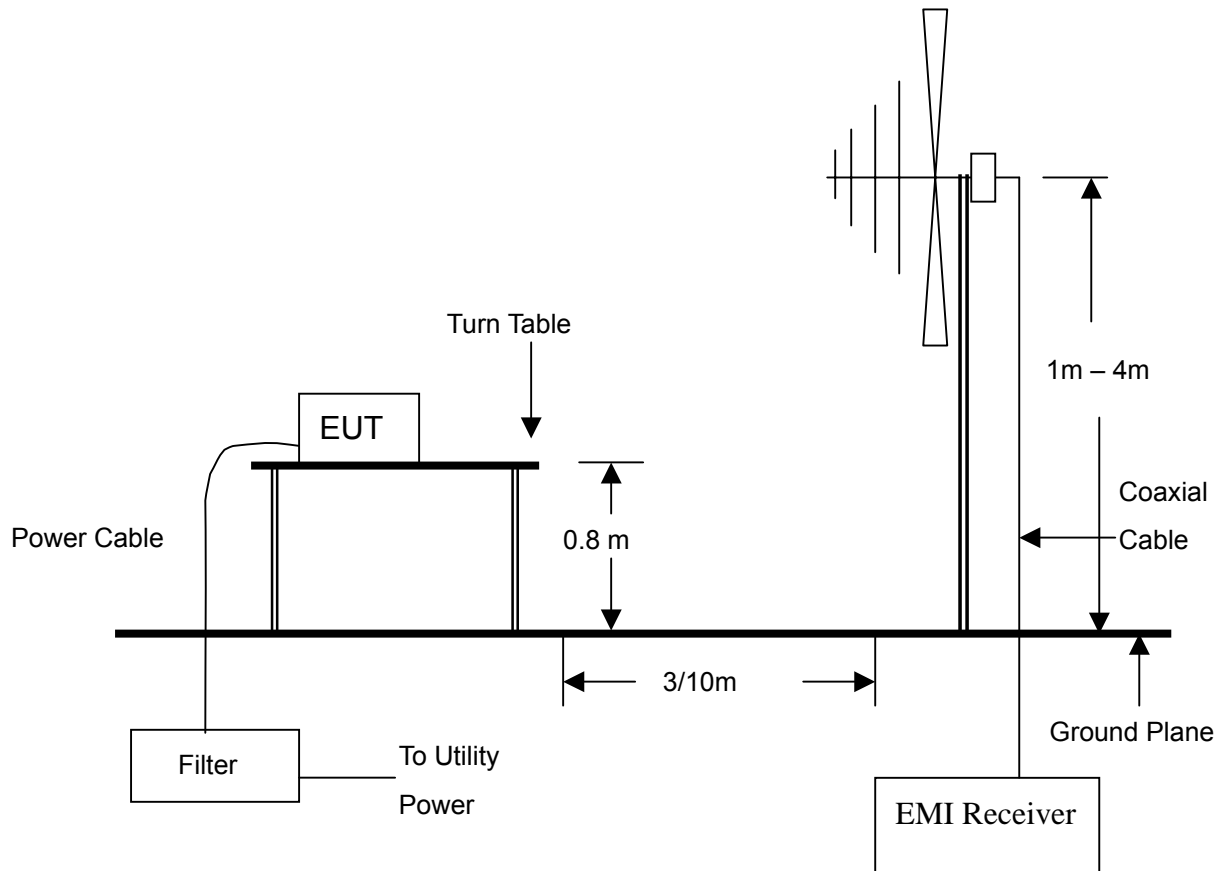

NOTE :

1. The EUT system was put on a wooden table with 0.8m heights above a ground plane.
2. For the actual test configuration, please refer to the photos of testing.



FOR RADIATED EMISSION TEST

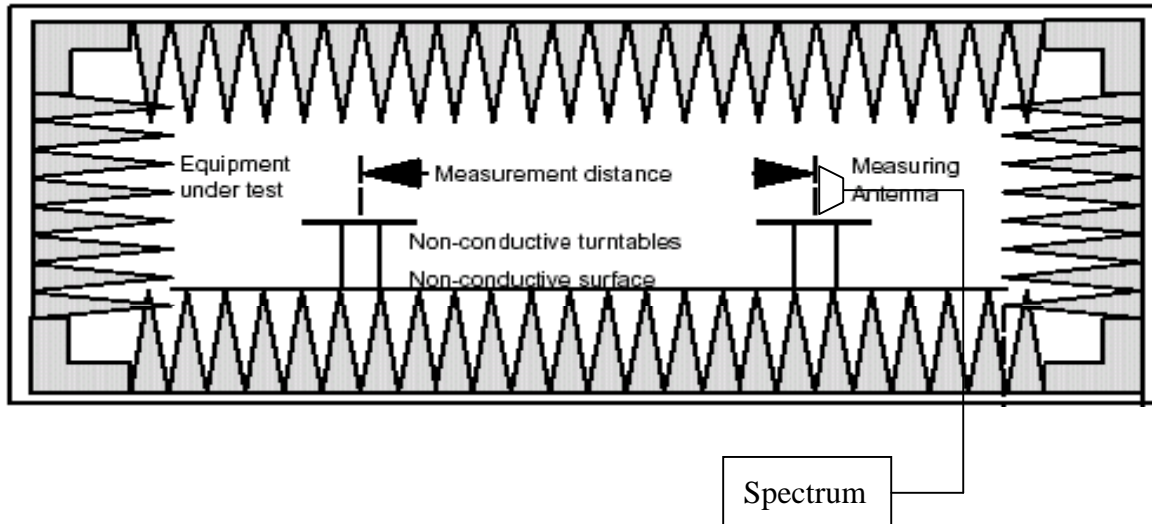

4.5.4 TEST PROCEDURE

The EUT was tested according to the requirement of ANSI C63.4 and CISPR 22. The measurements were made at an open area test site with 10 meter measurement distance under 1 GHz and with 3m distance above 1GHz. The frequency spectrum measured started from 30 MHz. Under 1 GHz. All readings were quasi-peak values with 120 kHz resolution bandwidth of the test receiver. Above 1 GHz, the measurements were made at an open area test site with 3 meter measurement distance and all readings were peak and average values with 1 MHz resolution bandwidth of the test receiver. The EUT system was operated in all typical methods by users. The cables connected to EUT and support units were moved to find the maximum emission levels for each frequency.

4.5.5 EUT OPERATING CONDITION

Same as section 4.1.5 of this report.



TEST REPORT

4.5.6 TEST RESULT

Temperature:	22 °C	Humidity:	68 %RH
Frequency Range:	30 – 1000 MHz	Measured Distance:	3m
Receiver Detector:	Q.P.	Tested Mode:	Link
Tested By:	Julian Chiang	Tested Date:	Dec. 21, 2005

Antenna Polarization: Vertical

Frequency (MHz)	Cable Loss (dB)	Antenna Factor (dB/m)	Reading Data (dBμV)	Emission Level (dBμV/m)	Limit (dBμV/m)	Margin (dB)	AZ(°)	EL(m)
43.2640	0.96	8.36	15.7	25.0	40.0	-15.0	125	1.00
157.2570	1.63	8.82	16.4	26.8	43.5	-16.7	152	1.10
166.8200	1.91	8.53	20.3	30.7	43.5	-12.8	108	1.10
256.8420	2.53	11.81	15.4	29.7	46.0	-16.3	74	1.20
331.9530	2.93	14.75	13.7	31.4	46.0	-14.6	62	1.10
662.8410	4.59	20.44	15.2	40.2	46.0	-5.8	237	1.00

Antenna Polarization: Horizontal

Frequency (MHz)	Cable Loss (dB)	Antenna Factor (dB/m)	Reading Data (dBμV)	Emission Level (dBμV/m)	Limit (dBμV/m)	Margin (dB)	AZ(°)	EL(m)
41.2870	0.95	9.12	14.7	24.8	40.0	-15.2	166	1.20
156.2410	1.60	9.02	20.4	31.0	43.5	-12.5	82	1.10
166.3840	1.91	8.53	22.5	32.9	43.5	-10.6	94	1.20
331.2870	2.93	14.75	12.7	30.4	46.0	-15.6	342	1.10
663.4780	4.58	20.46	10.6	35.6	46.0	-10.4	72	1.20
847.2610	4.59	22.72	13.5	40.8	46.0	-5.2	169	1.20

NOTE :

1. Measurement uncertainty is +/-2dB.
2. "**": Measurement does not apply for this frequency.
3. Emission Level = Reading Value + Ant. Factor + Cable Loss.
4. The field strength of other emission frequencies were very low against the limit.



TEST REPORT

Temperature:	<u>22°C</u>	Humidity:	<u>68 %RH</u>
Frequency Range:	<u>1 – 25 GHz</u>	Measured Distance:	<u>3m</u>
Receiver Detector:	<u>PK. or AV.</u>	Tested Mode:	<u>TX (Game Pad) CH0</u>
Tested By:	<u>Julian Chiang</u>	Tested Date:	<u>Dec. 21, 2006</u>

Antenna Polarization : Horizontal

Frequency (MHz)	Correct Factor (dB)	Ant. Factor (dB/m)	Reading Data (dBµV)		Emission Level (dBµV/m)		Limit (dBµV/m)		Margin (dB)		AZ (°)	EL (m)
			PK.	AV.	PK.	AV.	PK.	AV.	PK.	AV.		
2402.00	-32.16	28.54	73.5	68.7	69.9	65.1	N/A	N/A	N/A	N/A	142	1.0
4804.00	-30.47	33.64	35.7	*	38.9	*	74.0	54.0	-35.1	*	135	1.1
7206.00	-28.90	36.26	38.4	*	45.8	*	74.0	54.0	-28.2	*	65	1.0
2368.16	-32.28	27.94	31.5	*	27.2	*	74.0	54.0	-46.8	*	72	1.1
2397.52	-32.17	27.99	32.6	*	28.4	*	74.0	54.0	-45.6	*	91	1.1
2435.94	-32.22	28.07	33.4	*	29.3	*	74.0	54.0	-44.7	*	152	1.2

Antenna Polarization : Vertical

Frequency (MHz)	Correct Factor (dB)	Ant. Factor (dB/m)	Reading Data (dBµV)		Emission Level (dBµV/m)		Limit (dBµV/m)		Margin (dB)		AZ (°)	EL (m)
			PK.	AV.	PK.	AV.	PK.	AV.	PK.	AV.		
2402.00	-32.16	28.00	75.4	70.3	71.2	66.1	N/A	N/A	N/A	N/A	64	1.3
4804.00	-30.47	33.64	34.8	*	38.0	*	74.0	54.0	-36.0	*	187	1.2
7206.00	-28.90	36.26	35.9	*	43.3	*	74.0	54.0	-30.7	*	183	1.2
2348.67	-32.35	27.90	34.7	*	30.2	*	74.0	54.0	-43.8	*	48	1.3
2399.34	-32.16	28.00	34.6	*	30.4	*	74.0	54.0	-43.6	*	66	1.3
2469.74	-32.21	28.14	35.9	*	31.8	*	74.0	54.0	-42.2	*	39	1.3

NOTE :

1. Measurement uncertainty is +/-2dB.
2. "**": The Peak reading value also meets average limit and measurement with the average detector is unnecessary.
3. Emission Level = Reading Value + Ant. Factor + Correct Factor (incl.:Cable Loss and Pre-Amplifier Gain)
4. The field strength of other emission frequencies were very low against the limit.
5. (F):The field strength of fundamental frequency.
6. The tested value of over 10GHz is too low to get from test equipment, which is not record on this report.



TEST REPORT

Temperature:	22°C	Humidity:	68 %RH
Frequency Range:	1 – 25 GHz	Measured Distance:	3m
Receiver Detector:	PK. or AV.	Tested Mode:	TX (Game Pad) CH9
Tested By:	Julian Chiang	Tested Date:	Dec. 21, 2006

Antenna Polarization : Horizontal

Frequency (MHz)	Correct Factor (dB)	Ant. Factor (dB/m)	Reading Data (dBμV)		Emission Level (dBμV/m)		Limit (dBμV/m)		Margin (dB)		AZ (°)	EL (m)
			PK.	AV.	PK.	AV.	PK.	AV.	PK.	AV.		
2440.00	-32.22	28.62	72.6	67.1	69.0	63.5	N/A	N/A	N/A	N/A	126	1.1
4880.00	-30.27	33.70	36.8	*	40.2	*	74.0	54.0	-33.8	*	138	1.0
7320.00	-29.05	36.36	34.2	*	41.5	*	74.0	54.0	-32.5	*	251	1.1
2337.69	-32.35	27.87	33.6	*	29.1	*	74.0	54.0	-44.9	*	33	1.0
2412.66	-32.18	28.02	31.9	*	27.7	*	74.0	54.0	-46.3	*	168	1.2
2487.62	-32.18	28.17	32.7	*	28.7	*	74.0	54.0	-45.3	*	324	1.2

Antenna Polarization : Vertical

Frequency (MHz)	Correct Factor (dB)	Ant. Factor (dB/m)	Reading Data (dBμV)		Emission Level (dBμV/m)		Limit (dBμV/m)		Margin (dB)		AZ (°)	EL (m)
			PK.	AV.	PK.	AV.	PK.	AV.	PK.	AV.		
2440.00	-32.22	28.08	73.7	68.2	69.6	64.1	N/A	N/A	N/A	N/A	167	1.1
4880.00	-30.27	33.70	36.8	*	40.2	*	74.0	54.0	-33.8	*	25	1.3
7320.00	-29.05	36.36	35.1	*	42.4	*	74.0	54.0	-31.6	*	352	1.2
2359.74	-32.32	27.92	32.6	*	28.2	*	74.0	54.0	-45.8	*	19	1.3
2429.62	-32.21	28.06	33.9	*	29.8	*	74.0	54.0	-44.2	*	257	1.2
2510.36	-32.09	28.26	32.1	*	28.3	*	74.0	54.0	-45.7	*	64	1.3

NOTE :

1. Measurement uncertainty is +/-2dB.
2. "**": The Peak reading value also meets average limit and measurement with the average detector is unnecessary.
3. Emission Level = Reading Value + Ant. Factor + Correct Factor (incl.:Cable Loss and Pre-Amplifier Gain)
4. The field strength of other emission frequencies were very low against the limit.
5. (F):The field strength of fundamental frequency.
6. The tested value of over 10GHz is too low to get from test equipment, which is not record on this report.



TEST REPORT

Temperature:	<u>22°C</u>	Humidity:	<u>68 %RH</u>
Frequency Range:	<u>1 – 25 GHz</u>	Measured Distance:	<u>3m</u>
Receiver Detector:	<u>PK. or AV.</u>	Tested Mode:	<u>TX (Game Pad) CH19</u>
Tested By:	<u>Julian Chiang</u>	Tested Date:	<u>Dec. 21, 2006</u>

Antenna Polarization : Horizontal

Frequency (MHz)	Correct Factor (dB)	Ant. Factor (dB/m)	Reading Data (dBμV)		Emission Level (dBμV/m)		Limit (dBμV/m)		Margin (dB)		AZ (°)	EL (m)
			PK.	AV.	PK.	AV.	PK.	AV.	PK.	AV.		
2481.00	-32.19	28.73	73.5	67.8	70.0	64.3	N/A	N/A	N/A	N/A	74	1.1
4962.00	-30.26	33.77	38.6	*	42.1	*	74.0	54.0	-31.9	*	81	1.2
7443.00	-28.95	36.45	37.5	*	45.0	*	74.0	54.0	-29.0	*	68	1.1
2332.16	-32.35	27.86	32.4	*	27.9	*	74.0	54.0	-46.1	*	114	1.1
2484.12	-32.19	28.17	35.7	*	31.7	*	74.0	54.0	-42.3	*	62	1.0
2495.63	-32.17	28.19	31.9	*	27.9	*	74.0	54.0	-46.1	*	350	1.2

Antenna Polarization : Vertical

Frequency (MHz)	Correct Factor (dB)	Ant. Factor (dB/m)	Reading Data (dBμV)		Emission Level (dBμV/m)		Limit (dBμV/m)		Margin (dB)		AZ (°)	EL (m)
			PK.	AV.	PK.	AV.	PK.	AV.	PK.	AV.		
2481.00	-32.19	28.16	72.4	66.9	68.4	62.9	N/A	N/A	N/A	N/A	194	1.2
4962.00	-30.26	33.77	37.8	*	41.3	*	74.0	54.0	-32.7	*	48	1.2
7443.00	-28.95	36.45	36.4	*	43.9	*	74.0	54.0	-30.1	*	73	1.3
2448.19	-32.24	28.10	34.7	*	30.6	*	74.0	54.0	-43.4	*	157	1.4
2483.59	-32.19	28.17	33.6	*	29.6	*	74.0	54.0	-44.4	*	166	1.3
2464.87	-32.22	28.13	34.9	*	30.8	*	74.0	54.0	-43.2	*	84	1.4

NOTE :

1. Measurement uncertainty is +/-2dB.
2. "**": The Peak reading value also meets average limit and measurement with the average detector is unnecessary.
3. Emission Level = Reading Value + Ant. Factor + Correct Factor (incl.:Cable Loss and Pre-Amplifier Gain)
4. The field strength of other emission frequencies were very low against the limit.
5. (F):The field strength of fundamental frequency.
6. The tested value of over 10GHz is too low to get from test equipment, which is not record on this report.



TEST REPORT

Temperature:	<u>22°C</u>	Humidity:	<u>68 %RH</u>
Frequency Range:	<u>1 – 25 GHz</u>	Measured Distance:	<u>3m</u>
Receiver Detector:	<u>PK. or AV.</u>	Tested Mode:	<u>TX (Receiver) CH0</u>
Tested By:	<u>Julian Chiang</u>	Tested Date:	<u>Dec. 21, 2006</u>

Antenna Polarization : Horizontal

Frequency (MHz)	Correct Factor (dB)	Ant. Factor (dB/m)	Reading Data (dBμV)		Emission Level (dBμV/m)		Limit (dBμV/m)		Margin (dB)		AZ (°)	EL (m)
			PK.	AV.	PK.	AV.	PK.	AV.	PK.	AV.		
2402.00	-32.16	28.54	72.4	67.2	68.8	63.6	N/A	N/A	N/A	N/A	156	1.2
4804.00	-30.47	33.64	35.6	*	38.8	*	74.0	54.0	-35.2	*	51	1.1
7206.00	-28.90	36.26	36.7	*	44.1	*	74.0	54.0	-29.9	*	237	1.0
2387.24	-32.21	27.97	32.1	*	27.9	*	74.0	54.0	-46.1	*	24	1.1
2396.28	-32.18	27.99	33.6	*	29.4	*	74.0	54.0	-44.6	*	168	1.2
2468.27	-32.21	28.14	31.7	*	27.6	*	74.0	54.0	-46.4	*	148	1.1

Antenna Polarization : Vertical

Frequency (MHz)	Correct Factor (dB)	Ant. Factor (dB/m)	Reading Data (dBμV)		Emission Level (dBμV/m)		Limit (dBμV/m)		Margin (dB)		AZ (°)	EL (m)
			PK.	AV.	PK.	AV.	PK.	AV.	PK.	AV.		
2402.00	-32.16	28.00	72.6	67.4	68.4	63.2	N/A	N/A	N/A	N/A	166	1.2
4804.00	-30.47	33.64	36.4	*	39.6	*	74.0	54.0	-34.4	*	149	1.2
7206.00	-28.90	36.26	37.6	*	45.0	*	74.0	54.0	-29.0	*	177	1.1
2397.25	-32.17	27.99	31.5	*	27.3	*	74.0	54.0	-46.7	*	194	1.2
2443.67	-32.23	28.09	32.4	*	28.3	*	74.0	54.0	-45.7	*	84	1.2
2489.71	-32.18	28.18	32.6	*	28.6	*	74.0	54.0	-45.4	*	135	1.3

NOTE :

1. Measurement uncertainty is +/-2dB.
2. "**": The Peak reading value also meets average limit and measurement with the average detector is unnecessary.
3. Emission Level = Reading Value + Ant. Factor + Correct Factor (incl.:Cable Loss and Pre-Amplifier Gain)
4. The field strength of other emission frequencies were very low against the limit.
5. (F):The field strength of fundamental frequency.
6. The tested value of over 10GHz is too low to get from test equipment, which is not record on this report.



TEST REPORT

Temperature:	22°C	Humidity:	68 %RH
Frequency Range:	1 – 25 GHz	Measured Distance:	3m
Receiver Detector:	PK. or AV.	Tested Mode:	TX (Receiver) CH9
Tested By:	Julian Chiang	Tested Date:	Dec. 20, 2006

Antenna Polarization : Horizontal

Frequency (MHz)	Correct Factor (dB)	Ant. Factor (dB/m)	Reading Data (dBμV)		Emission Level (dBμV/m)		Limit (dBμV/m)		Margin (dB)		AZ (°)	EL (m)
			PK.	AV.	PK.	AV.	PK.	AV.	PK.	AV.		
2440.00	-32.22	28.62	72.6	66.1	69.0	62.5	N/A	N/A	N/A	N/A	154	1.1
4880.00	-30.27	33.70	35.8	*	39.2	*	74.0	54.0	-34.8	*	166	1.2
7320.00	-29.05	36.36	36.7	*	44.0	*	74.0	54.0	-30.0	*	247	1.2
2397.16	-32.17	27.99	32.8	*	28.6	*	74.0	54.0	-45.4	*	25	1.1
2423.67	-32.20	28.05	31.5	*	27.3	*	74.0	54.0	-46.7	*	317	1.1
2469.74	-32.21	28.14	31.7	*	27.6	*	74.0	54.0	-46.4	*	166	1.0

Antenna Polarization : Vertical

Frequency (MHz)	Correct Factor (dB)	Ant. Factor (dB/m)	Reading Data (dBμV)		Emission Level (dBμV/m)		Limit (dBμV/m)		Margin (dB)		AZ (°)	EL (m)
			PK.	AV.	PK.	AV.	PK.	AV.	PK.	AV.		
2440.00	-32.22	28.08	71.5	65.4	67.4	61.3	N/A	N/A	N/A	N/A	62	1.1
4880.00	-30.27	33.70	37.6	*	41.0	*	74.0	54.0	-33.0	*	94	1.2
7320.00	-29.05	36.36	35.7	*	43.0	*	74.0	54.0	-31.0	*	87	1.2
2394.18	-32.18	27.99	32.6	*	28.4	*	74.0	54.0	-45.6	*	65	1.3
2483.47	-32.19	28.17	31.7	*	27.7	*	74.0	54.0	-46.3	*	134	1.2
2512.74	-32.08	28.27	32.6	*	28.8	*	74.0	54.0	-45.2	*	47	1.3

NOTE :

1. Measurement uncertainty is +/-2dB.
2. "**": The Peak reading value also meets average limit and measurement with the average detector is unnecessary.
3. Emission Level = Reading Value + Ant. Factor + Correct Factor (incl.:Cable Loss and Pre-Amplifier Gain)
4. The field strength of other emission frequencies were very low against the limit.
5. (F):The field strength of fundamental frequency.
6. The tested value of over 10GHz is too low to get from test equipment, which is not record on this report.



TEST REPORT

Temperature:	22°C	Humidity:	68 %RH
Frequency Range:	1 – 25 GHz	Measured Distance:	3m
Receiver Detector:	PK. or AV.	Tested Mode:	TX (Receiver) CH19
Tested By:	Julian Chiang	Tested Date:	Dec. 21, 2006

Antenna Polarization : Horizontal

Frequency (MHz)	Correct Factor (dB)	Ant. Factor (dB/m)	Reading Data (dBμV)		Emission Level (dBμV/m)		Limit (dBμV/m)		Margin (dB)		AZ (°)	EL (m)
			PK.	AV.	PK.	AV.	PK.	AV.	PK.	AV.		
2481.00	-32.19	28.73	73.2	67.1	69.7	63.6	N/A	N/A	N/A	N/A	64	1.1
4962.00	-30.26	33.77	37.2	*	40.7	*	74.0	54.0	-33.3	*	91	1.2
7443.00	-28.95	36.45	35.4	*	42.9	*	74.0	54.0	-31.1	*	348	1.1
2374.58	-32.26	27.95	33.0	*	28.7	*	74.0	54.0	-45.3	*	76	1.1
2416.74	-32.19	28.03	32.4	*	28.2	*	74.0	54.0	-45.8	*	158	1.2
2483.69	-32.19	28.17	33.5	*	29.5	*	74.0	54.0	-44.5	*	72	1.2

Antenna Polarization : Vertical

Frequency (MHz)	Correct Factor (dB)	Ant. Factor (dB/m)	Reading Data (dBμV)		Emission Level (dBμV/m)		Limit (dBμV/m)		Margin (dB)		AZ (°)	EL (m)
			PK.	AV.	PK.	AV.	PK.	AV.	PK.	AV.		
2481.00	-32.19	28.16	73.8	67.5	69.8	63.5	N/A	N/A	N/A	N/A	127	1.1
4962.00	-30.26	33.77	38.0	*	41.5	*	74.0	54.0	-32.5	*	16	1.1
7443.00	-28.95	36.45	37.9	*	45.4	*	74.0	54.0	-28.6	*	49	1.2
2411.71	-32.18	28.02	32.4	*	28.2	*	74.0	54.0	-45.8	*	60	1.3
2459.30	-32.23	28.12	32.5	*	28.4	*	74.0	54.0	-45.6	*	157	1.2
2484.52	-32.19	28.17	31.9	*	27.9	*	74.0	54.0	-46.1	*	18	1.1

NOTE :

1. Measurement uncertainty is +/-2dB.
2. "**": The Peak reading value also meets average limit and measurement with the average detector is unnecessary.
3. Emission Level = Reading Value + Ant. Factor + Correct Factor (incl.:Cable Loss and Pre-Amplifier Gain)
4. The field strength of other emission frequencies were very low against the limit.
5. (F):The field strength of fundamental frequency.
6. The tested value of over 10GHz is too low to get from test equipment, which is not record on this report.



4.7 POWER DENSITY TEST

4.7.1 LIMIT

FCC Part15, Subpart C Section 15.247

FREQUENCY RANGE (MHz)	Limit(dBm/kHz)
902-928	8dBm/3kHz
2400-2483.5	
5725-5850	

4.7.2 TEST EQUIPMENT

The following test equipment was used during the radiated emission test:

EQUIPMENT/FACILITIES	SPECIFICATIONS	MANUFACTURER	MODEL#/SERIAL#	DUE DATE OF CAL. & CAL. CENTER
SPECTRUM	9kHz-7GHz	ROHDE & SCHWARZ	FSP7/ 839511/010	APR. 2006 R&S

NOTE: The calibration interval of the above test equipment is one year and the calibrations are traceable to NML/ROC and NIST/USA.

4.7.3 TEST SET-UP

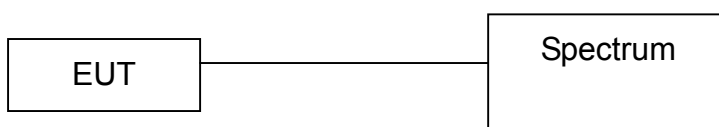

The EUT was connected to a spectrum through a 50Ω RF cable.

4.7.4 TEST PROCEDURE

The EUT was operating in transmitter mode and could be controlled its channel. Printed out the test result from the spectrum by hard copy function.

4.7.5 EUT OPERATING CONDITION

Same as section 4.1.5 of this report.



Spectrum Research & Testing Lab., Inc.
 No. 101-10, Ling 8,
 Shan-Tong Li, Chung-Li
 City, Taoyuan, Taiwan

TEST REPORT

Reference No.:A05101406
 Report No.:FCCA05101406
 FCCID: FSUGG000B
 Page:44 of 54
 Date:Jan. 04, 2006

4.7.6 TEST RESULT

Temperature:	<u>23°C</u>	Humidity:	<u>60%RH</u>
Spectrum Detector:	<u>PK.</u>	Tested Mode:	<u>TX (Game Pad)</u>
Tested By:	<u>Julian Chiang</u>	Modulation Type:	<u>FSK</u>
Tested Date:	<u>Dec. 16, 2006</u>		

CHANNEL NUMBER	CHANNEL FREQUENCY (MHz)	RF POWER LEVEL IN 3KHz BW (dBm/3kHz)	MAXIMUM LIMIT (dBm/3kHz)
0	2.402	-11.32	8
9	2.440	-11.14	8
19	2.481	-10.98	8

Ch0

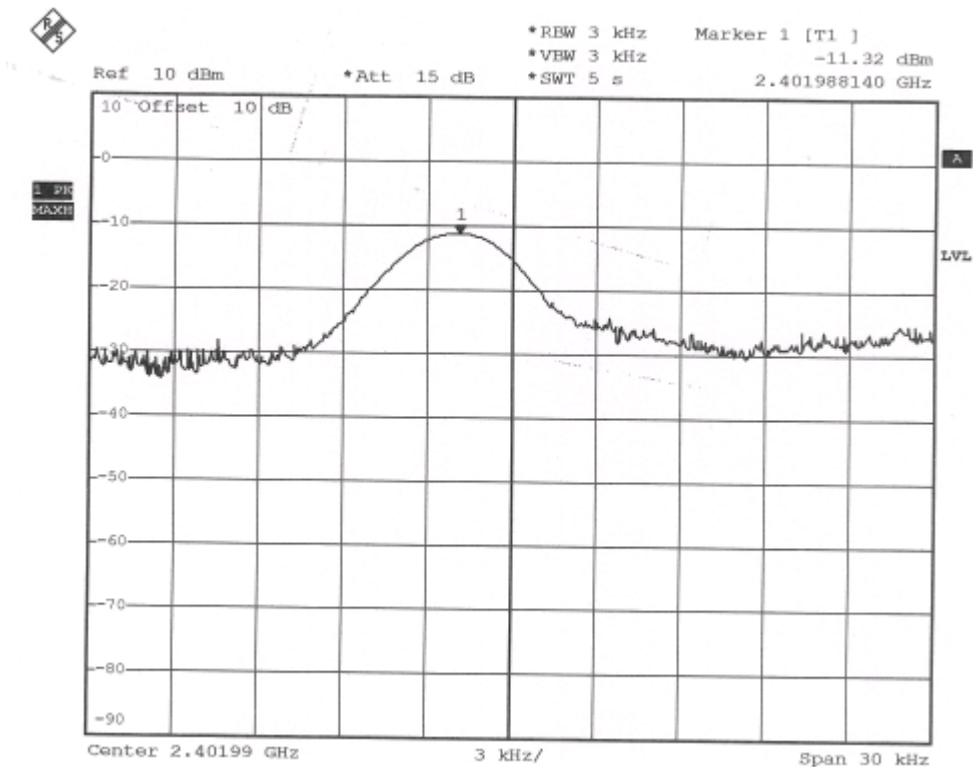



CH9

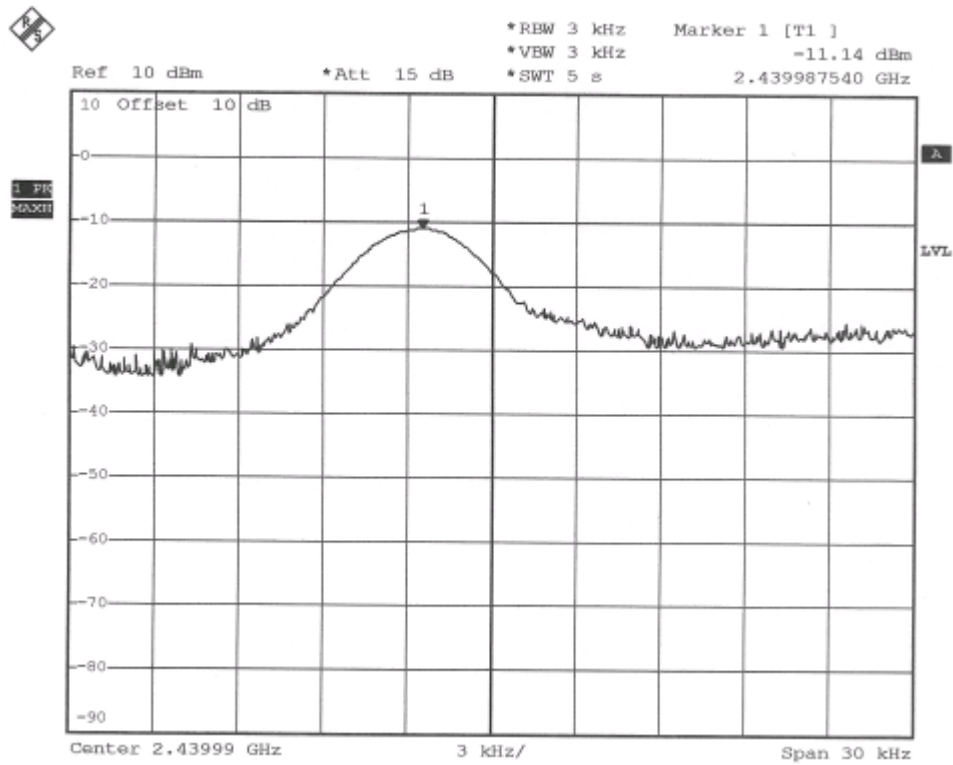

CH19

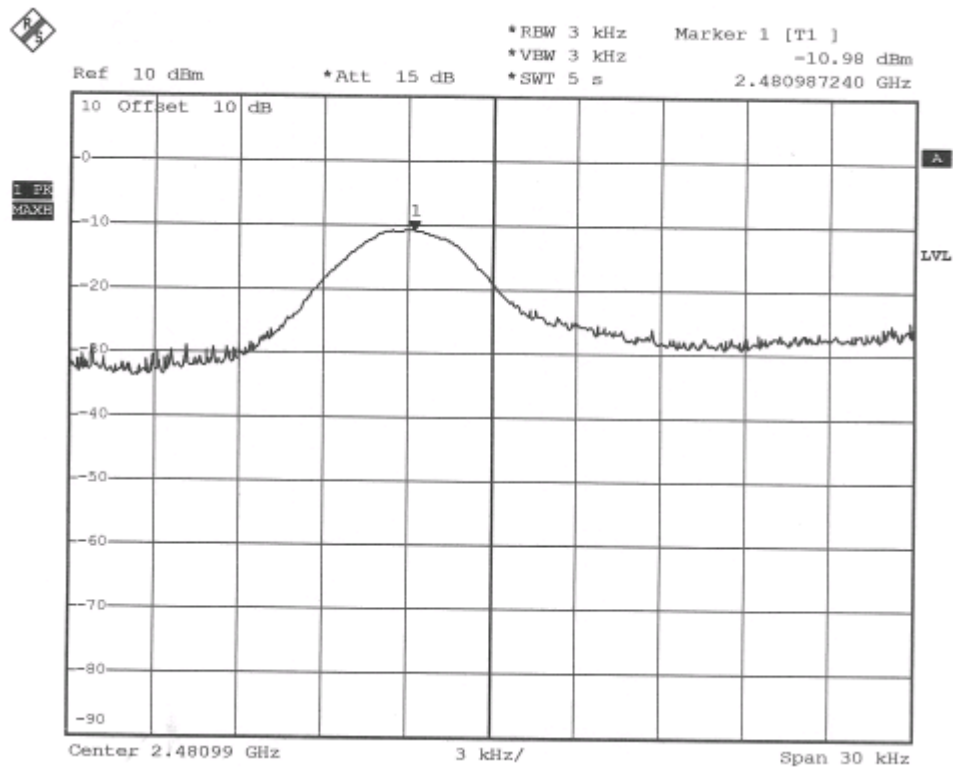



Spectrum Research & Testing Lab., Inc.
 No. 101-10, Ling 8,
 Shan-Tong Li, Chung-Li
 City, Taoyuan, Taiwan

TEST REPORT

Reference No.:A05101406
 Report No.:FCCA05101406
 FCCID: FSUGG000B
 Page:46 of 54
 Date:Jan. 04, 2006

Temperature:	<u>23°C</u>	Humidity:	<u>60%RH</u>
Spectrum Detector:	<u>PK.</u>	Tested Mode:	<u>TX (Receiver)</u>
Tested By:	<u>Julian Chiang</u>	Modulation Type:	<u>FSK</u>
Tested Date:	<u>Dec. 16, 2006</u>		

CHANNEL NUMBER	CHANNEL FREQUENCY (MHz)	RF POWER LEVEL IN 3KHz BW (dBm/3kHz)	MAXIMUM LIMIT (dBm/3kHz)
0	2.402	-6.62	8
9	2.440	-5.45	8
19	2.481	-8.07	8

Ch0

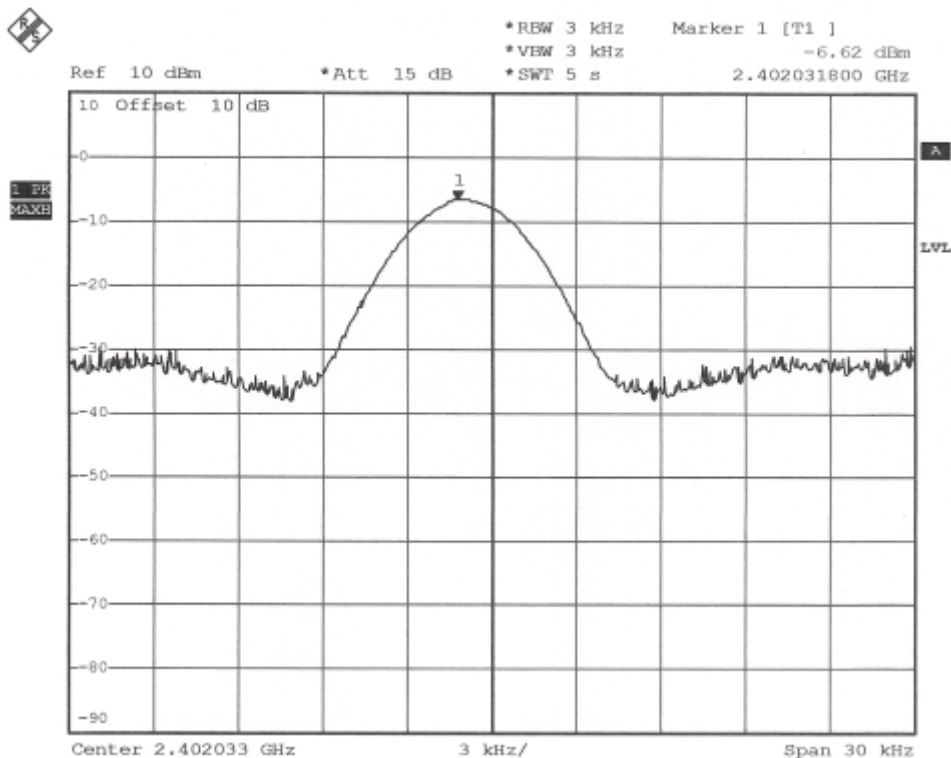



CH9

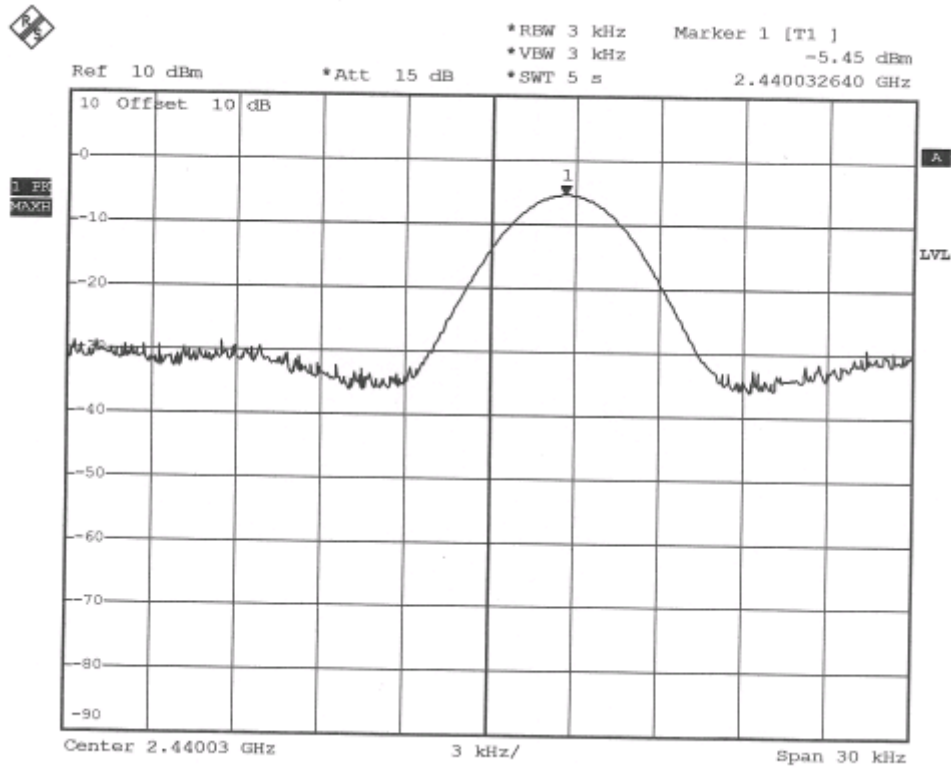

CH19

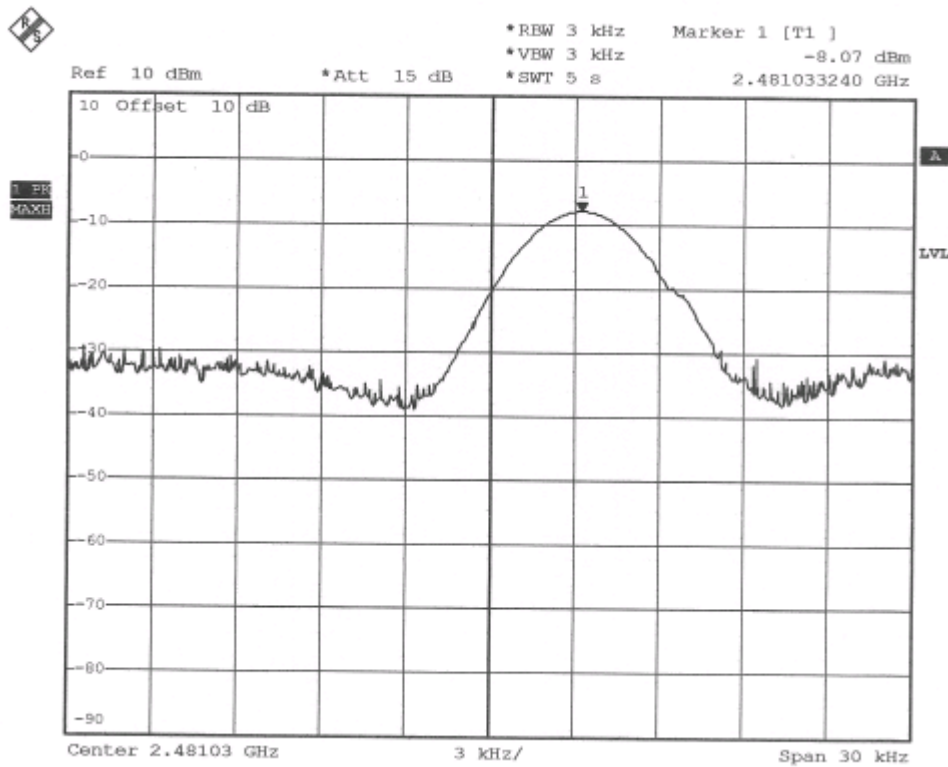



5. Antenna application

5.1 Antenna requirement

The EUT's antenna is met the requirement of FCC part15C section15.203 and 15.204.

FCC part15C section15.247 requirement:

Systems operating in the 2400-2483.5 MHz band that are used exclusively for fixed, point-to-point operations may employ transmitting antennas with directional gain greater than 6 dBi provided the maximum peak output power of the intentional radiator is reduced by 1 dB for every 3 dB that the directional gain of the antenna exceeds 6 dBi.

5.2 Result

The EUT's antenna used a chip antenna and integrated on PCB. The antenna's gain is 0dBi and meets the requirement.



6. PHOTOS OF TESTING

- Conducted test





- Conducted test





- Radiated test (Link)





- Radiated test (TX)





- Radiated test (TX)

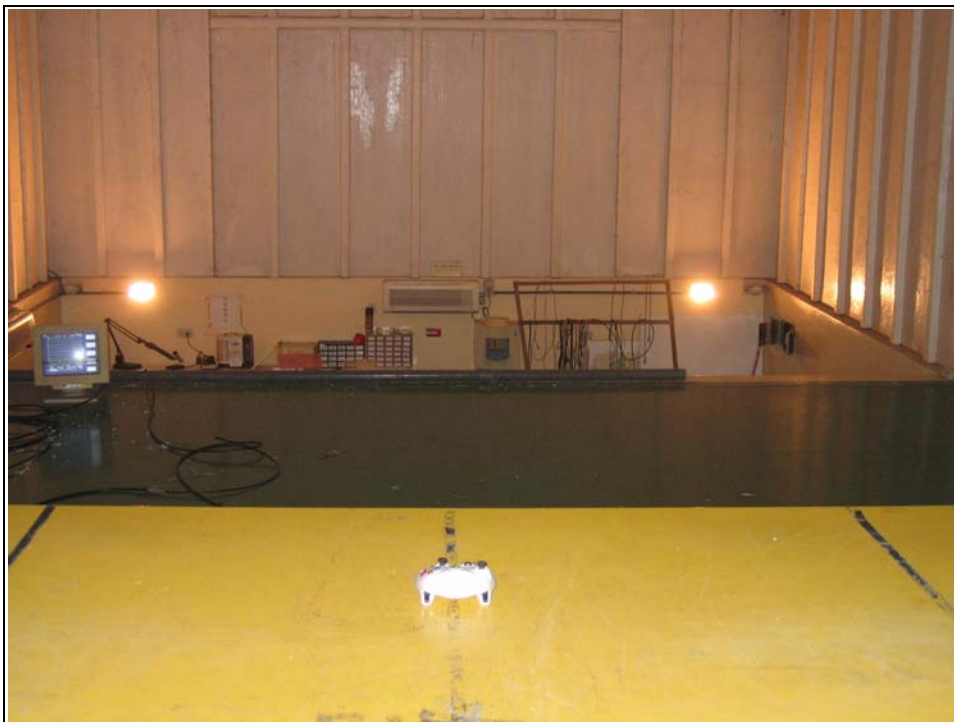



Spectrum Research & Testing Lab., Inc.
No. 101-10, Ling 8,
Shan-Tong Li, Chung-Li
City, Taoyuan, Taiwan

TEST REPORT

Reference No.:A05101406
Report No.:FCCA05101406
FCCID: FSUGG000B
Page:54 of 54
Date:Jan. 04, 2006

7. TERMS OF ABRIVATION

AV.	Average detection
AZ(°)	Turn table azimuth
Correct.	Correction
EL(m)	Antenna height (meter)
EUT	Equipment Under Test
Horiz.	Horizontal direction
LISN	Line Impedance Stabilization Network
NSA	Normalized Site Attenuation
Q.P.	Quasi-peak detection
SRT Lab	Spectrum Research & Testing Laboratory, Inc.
Vert.	Vertical direction